

Service Manual

LCD Monitor Acer A231H

Table of Contents

Important Safety Notice02

01 Product Specification03

02 Flat Panel Specification 15

03 Exploded Diagram36

04 Troubleshooting37

05 Spare Parts List42

06 Schematics and Layouts.....43

07 Assembly and Disassembly46

Appendix : User’s manual

Copyright

Copyright 2010 InnoLux Tech. Corp. Ltd

All Rights Reserved

This manual may not, in whole or in part, be copied, Photocopied, reproduced, translated, or converted to any electronic or machine readable form without prior written permission of InnoLux Tech. Corp. Ltd.

Acer A231H Service Manual

Important Safety Notice

1. Safety precautions

This monitor is manufactured and tested on a ground principle that a user's safety comes first. However, improper used or installation may cause damage to the monitor as well as to the user.

Warning:

- This monitor should be operated only at the correct power sources indicated on the label on the rear of the monitor. If you're unsure of the power supply in you residence, consult your local dealer or Power Company.
- Do not try to repair the monitor by yourself, as it contains no user-serviceable parts. This monitor should only be repaired by a qualified technician.
- Do not remove the monitor cabinet. There are high-voltage parts inside that may cause electric shock to human bodies.
- Stop using the monitor if the cabinet is damaged. Have it checked by a service technician.
- Put your monitor only in a lean, cool, dry environment. If it gets wet, unplug the power cable immediately and consult your closed dealer.
- Always unplug the monitor before cleaning it. Clean the cabinet with a clean, dry cloth. Apply non-ammonia based cleaner onto the cloth, not directly onto the class screen.
- Do not place heavy objects on the monitor or power cord.

2. Product safety notice

Many electrical and mechanical parts in this chassis have special safety visual inspections and the protection afforded by them cannot necessarily be obtained by using replacement components rated for higher voltage, wattage, etc. Before replacing any of these components read the parts list in this manual carefully. The use of substitute replacement parts, which do not have the same safety characteristics as specified in the parts list, may create shock, fire, or other hazards.

3. Service notes

- When replacing parts or circuit boards, clamp the lead wires around terminals before soldering.
- Keep wires away from high voltage, high temperature components and sharp edges.
- Keep wires in their original position so as to reduce interference.
- Adjustment of this product please refers to the user' manual.

01 Product Specification

1. General:

Acer A231H is designed with LVDS interface and VGA/DVI-D/HDMI(option) input, it featured with embedded universal AC power supplies and audio input. It's a green product and meets all ROHS standard. The power button and display control buttons are on the front of the monitor. The monitors shall automatically to display lower resolution video modes into 1920x1080 full screen display. The image can be adjusted through OSD control. It support HDCP and color management function.

1.1 Main Features

Features		Specifications
Maximum resolution		1920 x 1080 @ 60Hz
Back light system		4 CCFL
Pixel pitch		265.2 um (H) x 265.2 um (V)
Display area		509.76mm (H) x 286.74mm (V)
Contrast ratio		1000:1 (TYP.) /80000:1(ACM ON)
Brightness		250cd/m ² (TYP.)
Response time (Tr+Tf)		5ms (typ.)
Viewing angle		160° (H)/ 160°(V), (TYP.)
Input interface		Analog (D-sub 15 pin) Digital Option (DVI-D 24 pin & HDMI 19Pin)
Audio system		1.5 W *2
Power management		Compatible with VESA, DPMS
Plug & Play		VESA DDC/CI
University AC power supply		YES
OSD language	For Non-EMEA	English, Deutsch, Español, 简体中文, 繁體中文, Français, Italiano, 日本語
	For EMEA	English, Deutsch, Español, Dutch, Russian, Français, Italiano, Finnish

1.2 Accessories

Items	VGA cable	DVI cable	Audio cable	User's manual	Warranty card	Quick-start Guide
Description	1.8m	1.8m	1.8m	Multi	Multi	Multi
Option	●	●	●	●	●	●

2. Operation Specifications

The unit should suffer no visible cosmetic damage and should operate with no degradation in display quality during exposure to the operating conditions and after exposure to the non-operating conditions, in any sequence.

2.1 Environmental conditions

Operating	Specification
Low Temperature	0°C (Relative Humidity is as low as possible), 12 hrs.
High Temperature	+40°C / 20% R.H., 12 hrs.
High Humidity	+32°C/ 80% R.H., 12 hrs
Altitude	12,000 feet at 25°C (hold 3.5 hrs)
Storage	
Low Temperature	-30°C / humidity not controlled
High temperature & low humidity	+65°C/ 10% R.H.
Test Profile	+25°C/ 50%R.H.(2hrs)-> -30°C/ No R.H.(12hrs).-> +41°C/ 90% R.H.(12hrs)->+65°C/ 10% R.H.(12 Hrs)->+25°C/ 50% R.H.(2hr)
Max. Wet Bulb Temp	39°C
Altitude	40,000 feet at -30 °C (hold 1 hr)

Notice:1.Altitude Ramp rate: <= 3,500 feet per minute

2. Packed properly with PE bag, cushion material, carton & seal tape
3. power off when test storage

2.2 Safety, EMC, Ergonomics and Compatibility Requirements

EMC	<input checked="" type="checkbox"/> CE/EMC(歐洲) <input checked="" type="checkbox"/> VCCI (日本) <input checked="" type="checkbox"/> C-Tick (澳大利亞) <input checked="" type="checkbox"/> FCC-B(美國) <input type="checkbox"/> MIC(韓國 Dual) <input type="checkbox"/> MIC(韓國 analog) <input type="checkbox"/> ICES (加拿大)
Safety	<input checked="" type="checkbox"/> CB <input type="checkbox"/> Nemko-GS <input type="checkbox"/> TUV-GS <input type="checkbox"/> MET (美國/加拿大) <input type="checkbox"/> Nemko <input type="checkbox"/> Semko <input type="checkbox"/> Demko <input type="checkbox"/> Fimko <input type="checkbox"/> CSA/CSAus(美國/加拿大) <input type="checkbox"/> NOM (墨西哥) <input type="checkbox"/> UV Bauart Mark <input type="checkbox"/> SONCAP (奈及利亞) <input type="checkbox"/> Kazakhstan (哈薩克) <input type="checkbox"/> IRAM (阿根廷) <input checked="" type="checkbox"/> Nemko Bauart Mark (德國) <input type="checkbox"/> TUV S-Mark (阿根廷) <input type="checkbox"/> PSB (新加坡) <input checked="" type="checkbox"/> cTUVus(美國/加拿大)
EMC&Safety	<input type="checkbox"/> GOST-R(俄羅斯) <input checked="" type="checkbox"/> CCC (中國大陸) <input checked="" type="checkbox"/> BSMI(臺灣)Dual <input checked="" type="checkbox"/> BSMI(臺灣)analog <input type="checkbox"/> EK(韓國)Dual <input type="checkbox"/> EK(韓國)analog <input type="checkbox"/> PSE(日本) <input type="checkbox"/> SABS(南非) <input type="checkbox"/> Ukrainian (烏克蘭) <input type="checkbox"/> SASO(沙特) <input type="checkbox"/> SII(以色列) <input type="checkbox"/> KVALITET(塞爾維亞) <input type="checkbox"/> Bellis (白俄羅斯) <input type="checkbox"/> KONCAR(肯尼亞) safety <input type="checkbox"/> Cambodia (柬埔寨) safety
Ergonomics	<input type="checkbox"/> Nemko-Ergo <input type="checkbox"/> TUV-Ergo <input type="checkbox"/> TCO'99 <input type="checkbox"/> TCO'03 <input type="checkbox"/> TCO'06 <input type="checkbox"/> MPRII 證書 <input checked="" type="checkbox"/> MPRII 僅report <input checked="" type="checkbox"/> ISO9241-307證書 <input type="checkbox"/> ISO13406-2 僅report <input checked="" type="checkbox"/> China energy (中國能效) <input type="checkbox"/> CECP (中國節能)
Compatibility	Windows 95/98/Me/2000/XP/VISTA/7
Power Management	Energy Star 5.0

2.3 Electrostatic Discharge Requirements

Item	Condition	Spec	
Electrostatic Discharge	IEC61000-4-2(EN55024)	Contact discharge: 4KV	
		Contact discharge: 8KV	•
		Air discharge : 8KV	
		Air discharge : 15KV	•

2.4 Reliability

Items	Condition	Spec	Note
MTBF	Operating condition is 25°C	≥ 50,000 Hours	
CCFL Life time	Luminance becomes 50%	≥ 50,000 Hours(Typ)	Note1

Note1. Display an all WHITE field at mid Brightness and Contrast settings.

3. Electrical and Optical Characteristics and Performance

3.1 Main Power Supply

3.1.1 Input characteristics

Items	Condition	Spec	Note
AC Input Voltage range	Universal input full range	90~264Vac	
AC Input Voltage rating	Universal input full range	100~240Vac	
AC input frequency range	90~264Vac	47~63Hz	
AC input frequency rating	100~240Vac	50~60Hz	
AC Input Current	100Vac	1.5A(max)	
	240Vac	0.8A(max)	
Inrush Current	100Vac,cold star,25°C	35A (max)	See Note2
	240Vac,cold star,25°C	70A(max)	
AC-DC power Efficiency	DC output full loading	≥80%	

Note2. Before each test, the buck capacitor need to be discharged.
Before each test, it must be 10 minutes at least after the latest test.
Hot star not component be damaged.

3.1.2 Output characteristics

Items	Condition	Spec	Note
Ripple and Noise	+25V output	<800mv	With system See note 3
	+5V output	<500mv	
	Audio 5V output	<500mv	
	With dummy Load	+25V output	<480mv
		+5V output	<100mv
		Audio 5V output	<100mv
DC Output Voltage	25V loading:0.3A~1.4A 5V loading:0.75A~1.5A Audio 5V: 0A~1.2A	Vcc25V:23.2V~28V Vcc5V: 4.75V~5.25V Audio 5V: 4.95V~5.45V	For system active
	25v loading:0.1A~1.5A 5V loading: 0A	Vcc25V: 23.8V~30V Vcc5V: 4.75V~5.25V	For power saving or DC off
DC output loading capability		Vcc5V/1.8A, Vcc25V/1.4A Audio 5V: 1.5A	
Rise Time		<20mS	
Dynamic load change			
Hold-up time	AC input: 100V~240V	>10mS	
Overshoot		<10%	
Turn on delay time		2S	
Power management			See Table-1

Note3: Paralleled a 0.1uF ceramic Cap. And 47uF aluminum Cap. Between the end of DC loading side, Measured band-width=20MHz. Ripple voltage of +25V is less than 1500mv when enter into burst mode.

3.1.3 Protection characteristics

Protection	Condition	Spec
OPP	nominal AC input	60W (min)
SCP(short circuit protection)	with auto-recovery function	
OVP(Over voltage protection)	Auto recovery	<output capacitor voltage

OTP(Over temperature protection)		
Fuse protection		

Table-1

Status	H-sync	V-sync	Video	Power	LED
Power On	on	on	active	≤55W	Blue
Power Saving	off	on	blanked	< 1W	Amber
	on	off	blanked	< 1W	Amber
	off	off	blanked	< 1W	Amber
Power Off	--	--	--	< 1W	Off

3.2 Backlight Power Supply

Panel: LTM230HT02

Items	Specification
Lamp	4 CCFL
Input Voltage	23.8---28V
Input current	1.2A (Typ.), 1.4A (Max.)
On/Off switch level	3.6V ≥ V on ≥ 2.0 V (on) -0.3v ≤ V off ≤ 0.8 V (off)
Brightness PWM Duty (ACM Off)	35%~100%
Brightness PWM Duty (ACM On)	3%~100%
CCFL operating Voltage	875Vrms (Typ.),
CCFL Current	7.5mA (Typ.)
	8.0mA (Max.)
CCFL startup voltage	≥ 1840 Vrms (0°C)
CCFL startup voltage	≥ 1510 Vrms (25°C)
Operating frequency	40~60 KHz
Protect delay time	> 1 second
Efficiency	≥75%

Note: Other panels please refer to the reference panel specs.

3.3 Brightness output

The test to verify specifications in this section shall be performed under the following standard conditions unless otherwise noted.

Temperature	: 25 ± 5°C
Test pattern	: white
Video Resolution	: 1920 x 1080
Video input level	: 700 mV ± 2%
Warm-up time	: 30 minutes

Set brightness control and also contrast control at maximum, to measure the screen center, the light output shall $BL \geq 200 \text{ cd/m}^2$.

3.4 White balance

The test standard conditions refer to Sec 3.3. (Brightness and contrast are under default value)

Mode		Chromaticity Coordinate	
		x	y
Cool	9300K	0.283 ± 0.030	0.297 ± 0.030
Warm	6500K	0.313 ± 0.030	0.329 ± 0.030
User		Panel While x	Panel While y

3.5 Brightness uniformity

The test standard conditions refer to Sec 3.3.

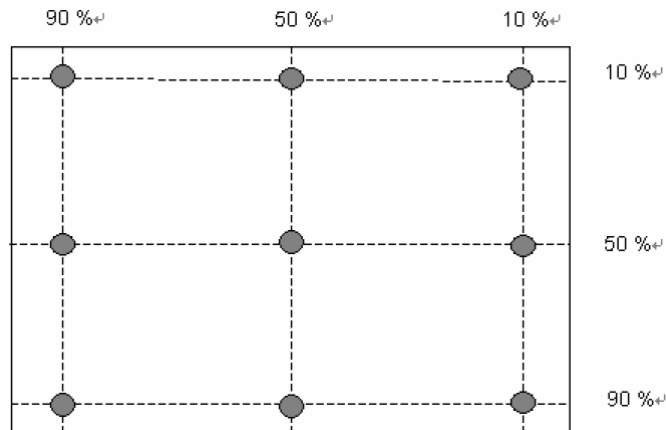

$$\frac{\text{Min. luminance of nine points (backlight)}}{\text{Max. luminance of nine points (backlight)}} \geq 75\%$$

4. Input / Output Signal Specifications

4.1 AC in

- 4.1.1 AC Input Voltage: 100~240VAC
- 4.1.2 AC Input Current: 1.2A @100Vac, 0.6A @240Vac
- 4.1.3 AC Frequency Range: 50~60Hz

4.2 Audio in (Option)

- 4.2.1 Input impedance : $\geq 10K$ ohm
- 4.2.2 Frequency response range : 200Hz ~ 20kHz

4.3 HDMI in (Option)

HDMI type A Connector Pin assignment:

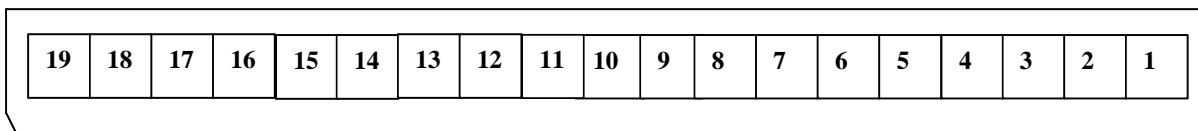

Pin	Symbol	Pin	Symbol
1	TMDS Data2+	11	Cable detect
2	TMDS Data2 shield	12	TMDS Clock-
3	TMDS Data2-	13	CEC
4	TMDS Data1+	14	N/C
5	TMDS Data1 shield	15	SCL

6	TMDS Data1-	16	SDA
7	TMDS Data0+	17	DDC/CEC Ground
8	TMDS Data0 shield	18	+5V Power
9	TMDS Data0-	19	Hot Plug Detect
10	TMDS Clock+		

4.4 DVI-D in

DVI-D Connector Pin assignment:

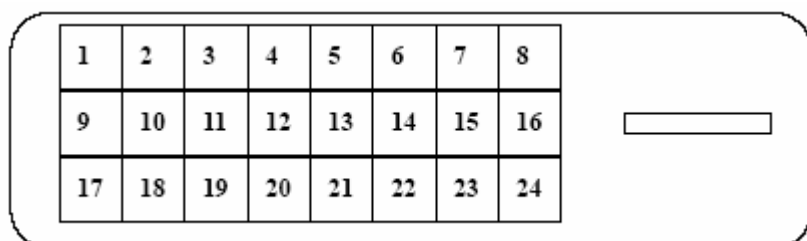

Pin	Symbol	Pin	Symbol
1	TMDS Data 2-	16	Hot Plug Detect
2	TMDS Data 2+	17	TMDS Data 0-
3	TMDS Data 2/4 shield	18	TMDS Data 0+
4	N/C	19	TMDS Data 0/5 shield
5	N/C	20	N/C
6	DDC Clock	21	N/C
7	DDC Data	22	Clock shield
8	Analog Vertical Sync	23	Clock +
9	TMDS Data 1-	24	Clock -
10	TMDS Data 1+		
11	TMDS Data 1/3 shield		
12	N/C		
13	N/C		
14	+5V Power		
15	Cable detect		

4.5 VGA in

4.5.1 D-sub Connector Pin assignment:

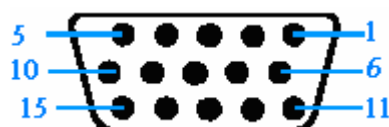

Pin	Symbol
1	Red Video
2	Green Video
3	Blue Video
4	N/C
5	Cable detect
6	Red Ground
7	Green Ground
8	Blue Ground

9	PC +3.3/+5V
10	Sync. Ground
11	N/C
12	DDC SDA
13	H sync
14	V sync
15	DDC SCL

4.5.2 Signal SPEC:

Items	Condition	Specification
Analog RGB signal	Input impedance =75 Ohm	0.7Vp-p
Sync	Input impedance \geq 1k Ohm	TTL level, Separate H/V-sync(+/-)
H-Sync Frequency		31K~83KHz
V-Sync Frequency		56~76Hz

4.6 Timing table

Mode	Resolution (active dot)	Resolution (total dot)	Horizontal Frequency (KHz)	Vertical Frequency (Hz)	Nominal Pixel Clock (MHz)	Write in EDID
	640x480@60Hz	800 x 525	31.469	59.941	25.175	23H
	640x480@72Hz	832 x 520	37.861	72.809	31.500	N/A
MAC	640x480@66.66Hz	864x525	35	66.66	30.24	23H
VESA	720x400@70Hz	900x449	31.469	70.087	28.322	23H
SVGA	800x600@56Hz	1024 x 625	35.156	56.250	36.000	23H
	800x600@60Hz	1056 x 628	37.879	60.317	40.000	23H
	800x600@72Hz	1040 x 666	48.077	72.188	50.000	N/A
	1024x600@60Hz	1312x622	37.320	60.000	48.964	N/A
XGA	1024x768@60Hz	1344x806	48.363	60.004	65.000	24H
	1024x768@70Hz	1328x806	56.476	70.069	75.000	24H
VESA	1152x864@75Hz	1600x900	67.5	75	108	26H~27H
	1280x960@60Hz	1800x1000	60	60	108	N/A
SXGA	1280x1024@60Hz	1688x1066	63.981	60.020	108.000	25H
VESA	1280x720@60Hz	1650x750	44.955	59.940	74.176	N/A
WXGA	1280x800@60Hz	1680x831	49.702	59.810	83.500	28H~29H
	1360x768@60Hz	1792x795	47.712	60.015	85.500	N/A
WXGA+	1440x900@60Hz	1904x931	55.935	59.887	106.500	2AH~2BH
WSXGA+	1680x1050@60Hz	2240*1089	65.290	59.954	146.250	N/A
UXGA	1600x1200@60Hz	2160x1250	75.000	60.000	162.000	N/A
	1920x1080@60Hz	2576x1120	67.158	59.963	173.000	2C~2D
	1920x1080@60Hz	2200x1125	67.500	60.000	148.500	36H~46H
	1920x1080@60Hz	2080x1111	66.587	59.934	138.500	

- Note:
1. Non-interlace signals only (An interlace signal cannot be display)
 2. Please refer to F/W specification for more detail
 3. Each frequency of Power Macintosh and Sun Ultra is a reference value

4.7 HDMI timing table(For HDMI Module)

For DVD Player Input, Attached timing is supported :

Mode	Resolution	Pixel Clock MHz	H sync KHz	V sync Hz
VGA	640 x 480p	25.2	31.5	60
NTSC (480i) 4:3	720 x 480	13.50	15.73	60
NTSC (480i) 16:9	720 x 480	13.50	15.73	60
NTSC (480p) 4:3	720 x 480	27.00	31.47	60
NTSC (480p) 16:9	720 x 480	27.00	31.47	60
PAL (576i)	720 x 576	13.50	15.63	50
PAL (576p) 4:3	720 x 576	27.00	31.27	50
PAL (576p) 16:9	720 x 576	27.00	31.27	50
720p	1280 x 720	74.25	37.5	50
720p	1280 x 720	74.25	44.96	60
1080i	1920 x 1080	74.25	28.125	50
1080i	1920 x 1080	74.25	33.72	60
1080P	1920 x 1080	148.50	56.250	50
1080P	1920 x 1080	148.50	67.50	60

4.8 Audio output SPEC(For Audio Module)

Items	Specification			TEST CONDITIONS
	Min	TYP	MAX	
Output power (W)	1.2	1.5	1.8	THD+N = 10%, AT 1KHz 1Vrms
Output impedance (Ω)	3.4	4	4.6	AT 1KHz 1Vrms
Total harmonic distortion plus noise	---	---	10%	$P_o \leq 2.0W$
Signal to noise ratio (dB)	40	---	---	THD+N \leq 5%
PWM frequency (KHz)	200	250	300	

Note: The low pass RC Filter (R=100 Ω / C=0.047 μ F) for Class-D Output Power and THD+N Measurement

4.9 DDC data

EDID File Format : VESA's EDID Standard Version #3, Revision #0,

EDID Structure : Version #1, Revision #3.

EDID Data Table : See the attached table (for example)

4.9.1 VGA EDID table

	0	1	2	3	4	5	6	7	8	9	A	B	C	D	E	F
0	00	FF	FF	FF	FF	FF	FF	00	04	72	C9	00	45	23	01	01
1	0A	14	01	03	08	33	1D	78	EA	60	85	A6	56	4A	9C	25
2	12	50	54	B3	0C	10	71	4F	81	00	81	80	95	00	D1	C0
3	01	01	01	01	01	01	02	3A	80	18	71	38	2D	40	58	2C
4	45	00	FD	1E	11	00	00	1A	00	00	00	FC	00	50	32	33
5	36	48	0A	20	20	20	20	20	20	20	00	00	00	FD	00	38
6	4C	1F	53	12	00	0A	20	20	20	20	20	20	00	00	00	FF
7	00	30	30	30	30	30	30	30	30	30	30	30	30	0A	00	78

4.9.2 DVI EDID table

	0	1	2	3	4	5	6	7	8	9	A	B	C	D	E	F
0	00	FF	FF	FF	FF	FF	FF	00	04	72	C9	00	45	23	01	01
1	0A	14	01	03	80	33	1D	78	EA	60	85	A6	56	4A	9C	25
2	12	50	54	B3	0C	10	71	4F	81	00	81	80	95	00	D1	C0
3	01	01	01	01	01	01	02	3A	80	18	71	38	2D	40	58	2C
4	45	00	FD	1E	11	00	00	1A	00	00	00	FC	00	50	32	33
5	36	48	0A	20	20	20	20	20	20	20	00	00	00	FD	00	38
6	4C	1F	53	12	00	0A	20	20	20	20	20	20	00	00	00	FF
7	00	30	30	30	30	30	30	30	30	30	30	30	30	0A	00	00

4.9.3 HDMI EDID table(For HDMI Module)

	0	1	2	3	4	5	6	7	8	9	A	B	C	D	E	F
0	00	FF	FF	FF	FF	FF	FF	00	04	72	C9	00	00	00	00	00
1	00	00	01	03	80	33	1D	78	EA	60	85	A6	56	4A	9C	25
2	12	50	54	B3	0C	10	71	4F	81	00	81	80	95	00	D1	C0
3	01	01	01	01	01	01	02	3A	80	18	71	38	2D	40	58	2C
4	45	00	FD	1E	11	00	00	1A	00	00	00	FC	00	48	32	33
5	33	48	0A	20	20	20	20	20	20	20	00	00	00	FD	00	38
6	4C	1F	53	12	00	0A	20	20	20	20	20	20	00	00	00	FF
7	00	30	30	30	30	30	30	30	30	30	30	30	30	0A	01	92
0	02	03	22	F2	23	09	7F	07	4E	01	02	03	84	05	06	07
1	10	11	12	15	93	1F	14	83	01	00	00	66	03	0C	00	10
2	00	00	8C	0A	D0	8A	20	E0	2D	10	10	3E	96	00	13	2A
3	21	00	00	18	01	1D	00	72	51	D0	1E	20	6E	28	55	00
4	13	2A	21	00	00	1E	01	1D	80	18	71	1C	16	20	58	2C

5	25	00	13	2A	21	00	00	9E	01	1D	00	BC	52	D0	1E	20
6	B8	28	55	40	13	2A	21	00	00	1E	01	1D	80	D0	72	1C
7	16	20	10	2C	25	80	13	2A	21	00	00	9E	00	00	00	FF

5. Function Specifications

All the tests to verify specifications in this section shall be performed under the following standard conditions unless otherwise noted. The standard conditions are:

Temperature	: 25 ± 5°C
Warm-up time	: 30 minutes minimum
Checking display modes	: All the specified modes

5.1 Panel general specifications

Item	Describe
Supplier	SEC
Model name	LTM230HT02
Display Area(mm)	509.76× 286.74
Pixel Pitch(mm)	0.2655(H) ×0.2655(V)
Display Colors	16.7M colors (RGB 6-bit + Hi_FRC)
Number of Pixel	1920(H) × 1080(V),Full HD
Brightness	250 cd/m ² (TYP.)
Contrast Ratio	1000 (TYP.)
Viewing Angle	160 (Horizontal) / 160(Vertical) (CR ≥ 10)
Display Mode	Normally White
Response Time	5ms (TYP. ON/OFF)
Surface Treatment	Anti-Glare, 3H
Lamp	4 CCFLs
Outline Dimension	534.0(W) ×311.7(H) ×12(D) (TYP.)

Notice: Other second panel pls refer to panel spec

5.2 Optical characteristic of LCD panel

The test methods for the below items' definition, please refer to the specification of **INL MT230DW01** panel.

Item	Unit	Conditions	Min.	Typ.	Max.	Remark
Viewing Angle (CR >= 10)	[degree]	Horizontal	Right	70	80	-
			Left	70	80	-
	[degree]	Vertical	Up	70	80	-
			Down	70	80	-
Contrast ratio		Normal Direction	600	1000		
Response time	[msec]	Rising + Falling	-	5	10	
Color Chromaticity (CIE)		Red x	Typ-0.03	0.640	Typ+0.03	
		Red y		0.349		
		Green x		0.284		
		Green y		0.617		
		Blue x		0.142		
		Blue y		0.067		
Color Coordinates (CIE) White		White x		0.313		
		White y		0.329		
Luminance Uniformity	[%]	9 points measurement	75%	-		
White Luminance at center point	[cd/m ²]		200	250	-	

5.3 Keypad Function

5.3.1 Control buttons

[AUTO]	<p>A. When OSD un-displays, press [AUTO] and the function menu will show on the screen;</p> <p>B. When function menu displays, press [AUTO] to perform auto-adjustment;</p> <p>C. When OSD displays, press [AUTO] to return to previous level menu;</p> <p>D. When “e Color OSD” OSD displays, press [AUTO] to exit the OSD.</p>
[MENU]	<p>A. When OSD isn't shown on screen, press [MENU] to enter the function menu;</p> <p>B. When function menu displays, press [MENU] to enter the main menu OSD;</p> <p>C. When OSD displays, press [MENU] to perform function of menu icon that is highlight or enter next level menu</p>
[◀]	<p>A. When OSD isn't show on screen, press [◀] to enter the function menu;</p> <p>B. When “MENU OSD” displays, press these keys to change the contents of an adjustment item, or change an adjustment value;</p> <p>C. When Function menu displays, press [◀] to show “Audio” OSD and decrease the volume.</p>
[▶]	<p>A. When OSD isn't show on screen, press [▶] to enter the function menu;</p> <p>B. When “MENU OSD” displays, press these keys to change the contents of an adjustment item, or change an adjustment value;</p> <p>C. When Function menu displays:</p> <ol style="list-style-type: none"> Press [▶] key one time to search (a port with signal in order) Show “source icon” at the same time, as searching that port Go into next port automatically, if search the port without signal Display it, if search the port with signal <p>D. When the volume menu displays, press [▶] to increase the volume.</p>
[e Color]	<p>A. When function menu displays, press [e Color] to show “e Color OSD”, and press again the OSD can not disappear, but the time of “e Color OSD” disappearing is reset to 10 seconds again.</p> <p>B. When OSD disappear not including “e Color OSD”, press [e Color] to show “e Color OSD” OSD, the OSD before disappears, but the parameters of it should be saved</p>

[POWER]	Power on or power off the monitor
---------	-----------------------------------

5.3.2 Hot Key Operation

FUNCTION	HOT KEY OPERATION						DESCRIPTION
	e Color	AUTO	MENU	◀	▶	POWER	
FACTORY MODE	•					ON	Press [e], and then press [POWER] for DC power on. OSD menu will be shown with “F” on the left top. Select “F” for entering factory mode.

5.4 OSD Structure

The On-Screen Display (OSD) shall be an easy to use icon based menu through keypad OSD buttons or remote control unit. The unit shall leave the factory with all OSD controls set to their default values.

First	Second	Third	Fourth	Control Range	Default Value				
Function Menu	e-color	e mpowering technology	---	---	---				
	Auto	---	---	---	---				
	Main menu	Main menu (Picture)	---	---	---				
	Audio	Audio menu	---	---	---				
	Input	---	---	---	---				
Picture	Acer eColor Management	e mpowering technology	---	---	Standard				
	Brightness	---	---	0~100	User mode	77			
					Text mode	44			
					Standard mode	77			
					Graphics mode	97			
					Movie mode	77			
	Contrast	---	---	0~100	User mode	50			
					Text mode	50			
					Standard mode	50			
					Graphics mode	60			
					Movie mode	56			
	H.Position	---	---	0~100	50				
	V.Position			0~100	50				
	Focus			0~100	---				
	Clock			0~100	50 1				
	Colour Temp	Warm	Cool	---	---	Default			
						User	Red	0~100	80
							Green	0~100	80
							Blue	0~100	80
	Auto Config	---	---	---	---				
OSD	OSD Timeout	---	---	10~120	10				
Setting	Wide Mode	Full	---	---	Default				
		Aspect	---	---	---				
	DDC/CI	---	---	---	ON				
	ACM	---	---	---	OFF				
	Source	Analog	---	---	---				

		Digital		---	---	---
		HDMI		---	---	---
	Language	EMEA	NO-EMEA	---	---	English
		English	English	---	---	
		Russian	繁體中文	---	---	
		Deutsch	Deutsch	---	---	
		Français	Français	---	---	
		Español	Español	---	---	
		Italiano	Italiano	---	---	
		Dutch	简体中文	---	---	
Finnish	日本語	---	---			
Reset	---		---	---	---	
Info	Resolution		---	---	---	
	H.Freq		---	---	---	
	V.Freq		---	---	---	
	Input Type		---	---	---	
	S/N		---	---	---	

Notes: 1 Clock default 50 is for Visa timing. Others depend on timing.

5.5 OSD Translation

Main menu (NO_EMEA)

English (英語)	繁體中文	Deutsch (德語)	Français (法語)	Español (西班牙語)	Italiano (意大利語)	簡體中文	日本語
Picture	畫面	Bild	Image	Imagen	Immagine	画面	ピクチャー
Brightness	亮度	Helligkeit	Luminosité	Brillo	Luminosità	亮度	輝度
Contrast	對比	Kontrast	Contraste	Contraste	Contrasto	对比度	コントラスト
H.Position	水平位置	H.Position	H.Position	H.Posicion	O.Posizione	水平位置	水平位置
V.Position	垂直位置	V.Position	V.Position	V.Posicion	V.Posizione	垂直位置	垂直位置
Focus	相位	Fokus	Netteté	Nitidez	Nitidezza	相位	フェーズ
Clock	時脈	Takt	Fréquence	Reloj	Orologio	时序	クロック
Colour Temp	色溫	Farbtemp.	Temp. Couleur	Temp. Color	Temp. Colore	色温	色溫度
Warm	暖色溫	Warm	Chaud	Cálido	Caldo	暖色温	暖色
Cool	冷色溫	Kalt	Clair	Frio	Freddo	冷色温	寒色
User	使用者設定	Anwender	Utilisateur	Usuario	Utente	使用者设定	ユーザー設定
Red	紅色	Rot	Rouge	Rojo	Rossa	红色	赤
Green	綠色	Grün	Vert	Verde	Verde	绿色	緑
Blue	藍色	Blau	Bleu	Azul	Blu	蓝色	青
Auto Config	自動調整	Autom. Abgl.	Autoréglage	Autoajuste	Autoregolazione	自动调整	自動調整
OSD	OSD						
OSD Timeout	OSD 顯示時間 設定	OSD-Dauer	Délai de l'OSD	T. de espera OSD	Intervallo OSD	OSD 显示时 间设定	OSD 表示時間 設定
Setting	設定	Einstellung	Réglages	Configuración	Impostazione	设置	設定
Wide Mode	寬螢幕模式	Vollbild	Plein écran	Completa	Schermo intero	宽屏模式	ワイドモード
Full	全螢幕	Vollbild	Plein écran	Completa	Pieno	全屏	全画面
Aspect	Aspect						
Input	輸入	Eingang	Entrée	Entrada	Input	輸入	入力
Language	語言	Sprache	Langue	Idioma	Lingua	语言	言語
Reset	恢復出廠模式	Rücksetzen	Restaurer	Reiniciar	Resetare	恢复出厂模 式	リセット
Please Wait	請稍待	Bitte warten	Veillez patienter	Espere, por favor	Attendere prego	请稍待	お待ちくださ い
Information	資訊	Info	Informations	Información	Informazioni	信息	情報
Exit	結束調整	Beenden	Quitter	Salida	Uscita	退出菜单	終了
Enter	進入	Eingabe	Entrez	Introducir	Invio	进入	選択
Move	移動	Beweg.	Dépla.	Mover	Muovi	移动	移動
ON	開	EIN	Allumé	ACTIVADO	ATTIVA	开启	オン
OFF	關	Aus	OffEteinte	Apagado	Spento	关闭	オフ
Volume	音量	Lautstärke	Volume	Volumen	Volume	音量	音量

Message menu: (NON_EMEA)

English (英語)	繁體中文	Deutsch (德語)	Français (法語)	Español (西班牙語)	Italiano (意大利語)	簡體中文	日本語
Auto Config Please Wait	自動調整 請稍待	Autom. Abgl. Bitte warten	Autoréglage Veuillez patienter	Autoajuste Espere, porfavor	Autoregolazione Attendere prego	自动调整 请稍待	自動調整 お待ちください
Cable Not Connected	無訊號線 連接	Leitung nicht angeschlossen	Câble non connecté	Cable no conectado	Cavo non connesso	信号线 无连接	ケーブルが接 続されて いません
Input Not Supported	不支援 輸入訊號	Frequenzen nicht unterstützt	Fréquences non supportées	Frecuencias no soportadas	Frequenza non supportata	輸入 不支援	入力はサポ ートされて いません
No Signal	無訊號	Kein signal	Pas de signal	Sin señal	Assenza segnale	无讯号	信号なし

Color management OSD (scenario OSD) language: (NON_EMEA)

English (英語)	繁體中文	Deutsch (德語)	Français (法語)	Español (西班牙語)	Italiano (意大利語)	簡體中文	日本語
Standard	標準	Standard	Standard	Estándar	Standard	标准	標準
Text	文字	Text	Texte	Texto	Testo	文本	テキスト
Graphics	圖形	Grafiken	Images	Gráficos	Grafica	图形	グラフィック ス
Movie	電影	Spielfilm	Film	Película	Film	电影	ムービー
User	使用者	Benutzer	Utilisateur	Usuario	Utente	用户	ユーザー
Adjust/Exit	調整/結束	Abstimmen/Bee nden	Ajuster/Quitter	Ajuste/salir	Regola/Esci	调节/退出	調整/終了
Select	選擇	Auswahl	Sélectionner	Seleccionar	Seleziona	选取	選択

Main menu (EMEA)

English (英語)	Russian (俄語)	Deutsch (德語)	Français (法語)	Español (西班牙語)	Italiano (意大利語)	Dutch (荷蘭語)	Finnish (芬蘭語)
Picture	Изображ.	Bild	Image	Imagen	Immagine	Beeld	Kuva
Brightness	Яркость	Helligkeit	Luminosité	Brillo	Luminosità	Helderheid	Kirkkaus
Contrast	Контрастно сть	Kontrast	Contraste	Contraste	Contrasto	Contrast	Kontrasti
H.Position	Полож. по гориз.	H.Position	H.Position	H.Posicion	O.Posizione	H. positie	Vaakasijainti
V.Position	Полож. по верт.	V.Position	V.Position	V.Posicion	V.Posizione	V. positie	Pystysijainti
Focus	Фокусировк а	Fokus	Netteté	Nitidez	Nitidezza	Scherpstell ing	Tarkennus
Clock	Частота	Takt	Fréquence	Reloj	Orologio	Klok	Taajuus
Colour Temp	Цвет.темп.	Farbtemperatur	Temp. Couleur	Temp. Color	Temp. Colore	Kleurtemp.	Värin lämpöisyys
Warm	Теплый	Warm	Chaud	Cálido	Caldo	Warm	Lämmin
Cool	Холодный	Kalt	Clair	Frio	Freddo	Koel	Viileä
User	Пользоват.	Anwender	Utilisateur	Usuario	Utente	Gebruiker	Käyttjä
Red	Красный	Rot	Rouge	Rojo	Rossa	Rood	Punainen
Green	Зеленый	Grün	Vert	Verde	Verde	Groen	Vihreä

Blue	Синий	Blau	Bleu	Azul	Blu	Blauw	Sininen
Auto Config	Автонастройка	Autom. Abgl.	Autoréglage	Autoajuste	Autoregolazione	Autom.conf iguratie	Autom. asetukset
OSD	OSD						
OSD Timeout	Вр. отобр. Меню	OSD-Dauer	Délai de l'OSD	T. de espera OSD	Intervallo OSD	Time-out OSD	Aikakatkaisu
Setting	Настр.	Einstellung	Réglages	Configuración	Impostazione	Instelling	Asetus
Wide Mode	Широкоэк.р еж.	Bildformate	Mode Large	Modo panorámico	Modo Wide	Breedbeeld modus	Laajakuva
Full	Полное	Vollbild	Plein écran	Completa	Pieno	Volledig	Täysikuva
Aspect	Aspect						
Input	Вход	Eingang	Entrée	Entrada	Input	Ingang	Tulo
Language	Язык	Sprache	Langue	Idioma	Lingua	Taal	Kieli
Reset	Сброс	Rücksetzen	Restaurer	Reiniciar	Resetare	Opn.instellen	Nollaus
Please Wait	Подождите	Bitte warten	Veillez patienter	Espere, por favor	Attendere prego	Een ogenblik geduld	Odotta
Information	Информаци я	Info	Informations	Información	Informazioni	Informatie	Informaatio
Exit	Выход	Beenden	Quitter	Salida	Uscita	Afsluiten	Lopeta
Enter	Ввод	Eingabe	Entrez	Introducir	Invio	Enter	Syötä
Move	Переме	Beweg.	Dépla.	Mover	Muovi	Verpl.	Liiku
ON	Вкл	EIN	Allumé	ACTIVADO	ATTIVA	AAN	PÄÄLLÄ <ON>
OFF	Выкл	Aus	OffEteinte	Apagado	Spento	Uit	Pois päältä
Volume	Громкость	Lautstärke	Volume	Volumen	Volume	Volume	Äänenvoim.

Message menu: (EMEA)

English (英语)	Russian (俄语)	Deutsch (德语)	Français (法语)	Español (西班牙语)	Italiano (意大利语)	Dutch (荷兰语)	Finnish (芬兰语)
Auto Config Please Wait	Автонастройка, подождите..	Autom. Abgl. Bitte warten	Autoréglage Veillez patienter	Autoajuste Espere, por favor	Autoregolazione Attendere prego	Bezig met automatische configuratie, een ogenblik geduld	Autom. asetukset. Odotta
Cable Not Connected	Кабель не подключен	Leitung nicht angeschlossen	Câble non connecté	Cable no conectado	Cavo non connesso	Kabel niet aangesloten	Kaapeli ei kiinni
Input Not Supported	Вход не поддержива ется	Frequenzen nicht unterstützt	Fréquences non supportées	Frecuencias no soportadas	Frequenza non supportata	Ingang niet ondersteund	Tuloa ei tueta
No Signal	Нет сигнала	Kein signal	Pas de signal	Sin señal	Assenza segnale	Geen signaal	Ei signaalia

Color management OSD(scenario OSD) language: (EMEA)

English (英语)	Russian (俄语)	Deutsch (德语)	Français (法语)	Español (西班牙语)	Italiano (意大利语)	Dutch (荷兰语)	Finnish (芬兰语)
Standard	Стандарт	Standard	Standard	Estándar	Standard	Standaard	Vakio
Text	Текст	Text	Texte	Texto	Testo	Tekst	Teksti

Graphics	Изображение	Grafiken	Images	Gráficos	Grafica	Grafische	Grafiikka
Movie	Кино	Spielfilm	Film	Película	Film	Film	Elokuva
User	Пользователь	Benutzer	Utilisateur	Usuario	Utente	Gebruiker	Käyttäjä
Adjust/Exit	Настроить /Выход	Abstimmen/Beenden	Ajuster/Quitter	Ajuste/salir	Regola/Esci	Aanpassen/verlaten	Säädä/Lopeta
Select	Выбор	Auswahl	Sélectionner	Seleccionar	Seleziona	Selecteren	Valitse

6. Mechanical

6.1 Dimension

Dimension	Spec
Width	553mm
Height	409mm(W/Base),352mm(W/O Base)
Depth	172mm(W/Base),63mm(W/O Base)
Monitor Weight	5.5±0.3Kg for INL panel(INL panel 3.05Kg)

Remark: If phase in other second panel, the Monitor weight =2.45Kg+second panel weight ±0.3Kg

6.2 Cabinet Material

Cabinet Material	Spec
Cabinet Plastic Material	ABS HB
Front Bezel	BLACK
Back Cover	BLACK
Base	BLACK
Cabinet Texture	ACER SPECIFICATION

6.3 Mechanical Specification

Mechanical	Spec
Bezel Gap Specification	≤ 1.3mm
Screen printed Parts	Front bezel

6.4 Base Mechanical Interface

items	Spec
Tilt	Compliance with TCO03, -4°(+/-1°) ~+14°(+/-1°)
Wall Mount	100mm x 100 mm

7. Package

7.1 Unit Package Specification

7.1.1 Units package

Items	Spec
Packaging	Refer to ME PACKING SPEC
Ink	COLOR
Length	620+/-2.0mm
Height	483+/-2.0mm
Width	146+/-2.0mm
Gross Weight	7.7±0.5kg for INL panel (INL panel weight 3.05Kg)
Units per Pallet	59sets/pallet
40' /20' Container Loading, Palletized	1180sets/590sets

Remark: If phase in other second panel, the Gross weight =4.65Kg+second panel weight ±0.3Kg

7.1.2 Unit Packing Vibration

Testing with vibration shall be done in each of three mutually perpendicular axes. Axes are referenced to the position of system as it normally sits in front of user, i.e., Front-to-back, side-to-side and top-to-bottom.

7.1.2.1 Random Vibration

Items	Description
Sweep Frequency	1~200Hz
Amplitude	1.14 Grms
Duration Time	30 minute each axis
Direction	3 mutually perpendicular axes (x, y, z)

RANDOM VIBRATION SPECTRUM BREAK POINTS

Frequency (Hz)	PSD, G ² /Hz
1	0.0001
4	0.01
100	0.01
200	0.001

7.1.3 Non operation Thermal Shock Test

Item	Description
Temperature	-20 ⁰ C to 60 ⁰ C
Reset cycles times	25 ⁰ C>60 ⁰ C (10hrs)>25 ⁰ C (2hrs)>-20 ⁰ C (10hrs)>25 ⁰ C 3cycles ,every transition time 0.5 hr,
Total cycles	3 cycles

7.1.4 Package Drop

Drop height (Select drop height according to the gross weight refer to the table at below)

Gross Weight(kg)	1.0<W ≤ 9.0
Drop Height(cm)	76 √

Drop sequence and orientation

Drop	Drop onto	Type Drop	Figure
Step 1	Corner(2-3-5)of package	Corner	
Step 2	Edge(3-5) of package	Edge	
Step 3	Edge(2-3) of package	Edge	
Step 4	Edge(2-5) of package	Edge	
Step 5	Face(bottom-3)of package	Flat	
Step 6	Face(left-4) of package	Flat	
Step 7	Face(front-5) of package	Flat	
Step 8	Face(right-2) of package	Flat	
Step 9	Face(rear-6) of package	Flat	
Step 10	Face(Top-1) of package	Flat	

Mechanical and electrical damage should not exist after vibration test, and shall be submitted for approval customer before mass production.

8. Marking and Identification

8.1 S/N Label

The approval marking is required by the countries of sales destination.

8.2 Carton label

The approval marking is required by the countries of sales destination.

Acer

Acer –LCD-A231H

02. Flat Panel Specification

Revision History	(3)
General Description	(4)
1. Absolute Maximum Ratings	(5)
2. Optical Characteristics	(7)
3. Electrical Characteristics	(12)
3.1 TFT LCD Module	
3.2 Back Light Unit	
4. Block Diagram	(17)
4.1 TFT LCD Module	
4.2 Back Light Unit	
5. Input Terminal Pin Assignment	(18)
5.1 Input Signal & Power	
5.2 LVDS Interface	
5.3 Input Signals, Basic Display Colors and Gray Scale of Each Color	
6. Interface Timing	(26)
6.1 Timing Parameters (DE only mode)	
6.2 Timing Diagrams of interface Signal (DE only mode)	
6.3 Power ON/OFF Sequence	
6.4 VDD Power Dip Condition	
7. Outline Dimension	(31)
8. Reliability Test	(34)
9. Packing	(35)
10. Marking & Others	(36)
11. General Precaution	(38)
11.1 Handling	
11.2 Storage	
11.3 Operation	
11.4 Others	

General Description

Description

LTM230HT01 is a color active matrix liquid crystal display (LCD) that uses amorphous silicon TFT (Thin Film Transistor) as switching components. This model is composed of a TFT LCD panel, a driver circuit and a back light unit. The resolution of a 23" is 1920 x 1080 and this model can display up to 16.7 millions colors.

Features

- High contrast ratio, high aperture structure
- TN (Twisted Nematic) mode
- Wide Viewing Angle
- High speed response
- FHD (1920 x 1080 pixels) resolution
- Low power consumption
- DE (Data Enable) only mode
- LVDS (Low Voltage Differential Signaling) interface (2pixel/clock)
- Compact Size Design
- RoHS, TCO 03' compliance

Applications

- Workstation & desktop monitors
 - Display terminals for AV application products
 - Monitors for industrial machine
- * If the module is used to other applications besides the above, please contact SEC in advance.

General Information

Items	Specification	Unit	Note
Pixel Pitch	0.2655(H) x 0.2655(W)	mm	
Active Display Area	509.76(H) x 286.74(V)	mm	
Surface Treatment	Haze 25% , Hard coating (3H)		
Display Colors	16.7M (Hi-FRC)	colors	
Number of Pixels	1,920 x 1,080	pixel	
Pixel Arrangement	RGB vertical stripe		
Display Mode	Normally White		
Power Consumption	34.5W		
Luminance of White	300(Typ.)	cd/m ²	

Mechanical Information

Item		Min.	Typ.	Max.	Unit	Note
Module size	Horizontal (H)	533.5	534.0	534.5	mm	w/o inverter ass'y
	Vertical (V)	311.2	311.7	312.2	mm	
	Depth (D)	-	-	18.9	mm	
Weight		-	-	3,000	g	LCD module only

Note (1) Mechanical tolerance is $\pm 0.5\text{mm}$ unless there is a special comment.

1. Absolute Maximum Ratings

If the condition exceeds maximum ratings, it can cause malfunction or unrecoverable damage to the device.

Item	Symbol	Min.	Max.	Unit	Note
Power Supply Voltage	V_{DD}	GND-0.5	6.5	V	(1)
Data Signal	V_{sig}	-	5	V	
Storage temperature	T_{STG}	-25	60	$^{\circ}\text{C}$	(2)
Center of Glass surface temperature (Operation)	T_{OPR}	0	50	$^{\circ}\text{C}$	(2)
Shock (non - operating)	S_{np}	-	50	G	(3)(5)
Vibration (non - operating)	V_{np}	-	1.5	G	(4)(5)

Note (1) $T_a = 25 \pm 2 \text{ }^{\circ}\text{C}$

- (2) Temperature and relative humidity range are shown in the figure below.
 - a. 90 % RH Max. ($T_a \leq 39^\circ\text{C}$)
 - b. Maximum wet-bulb temperature at 39°C or less. ($T_a \leq 39^\circ\text{C}$)
 - c. No condensation
- (3) 11ms, sine wave, one time for $\pm X, \pm Y, \pm Z$ axis
- (4) 10-300 Hz, Sweep rate 10min, 30min for X,Y,Z axis
- (5) At vibration and shock test, the fixture which holds the module to be tested has to be hard and rigid enough so that the module would not be twisted or bent by the fixture.

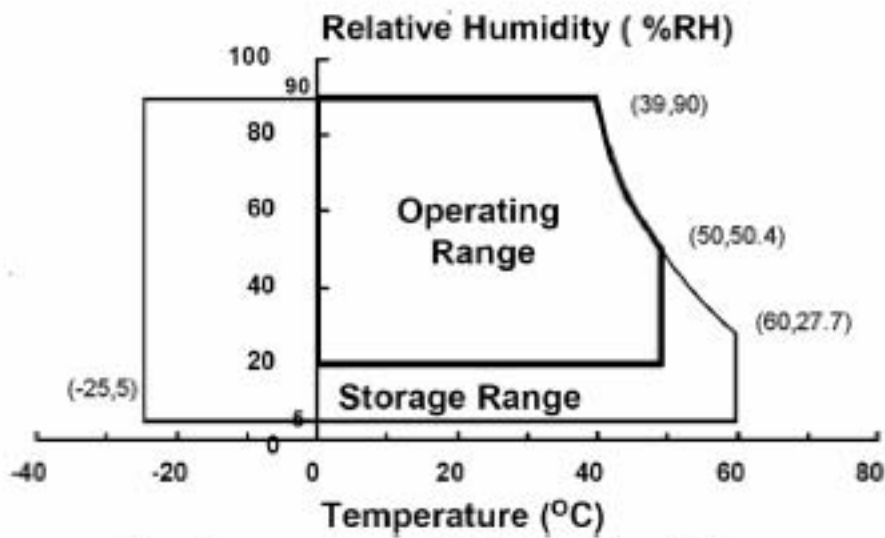

Fig. Temperature and Relative humidity range

2. Optical Characteristics

The optical characteristics should be measured in a dark room or equivalent.

Measuring equipment : SR-3, RD-80S (TOPCON), EZ-Contrast (Eldim)

($T_a = 25 \pm 2^\circ\text{C}$, $V_{DD}=5\text{V}$, $f_v=60\text{Hz}$, $f_{DCLK}=69.3\text{MHz}$, $I_L = 7.5\text{mA}_{rms}$)

Item	Symbol	Condition	Min.	Typ.	Max.	Unit	Note
Contrast Ratio (Center of screen)	C/R		600	1000	-		(3) SR-3
Response Time(On/Off)	On/Off	$T_r + T_f$	-	5	10	msec	(5) RD-80S
Luminance of White (Center of screen)	Y_L		250	300	-	cd/m ²	(6) SR-3
Color Chromaticity (CIE 1931)	Red	R_x	0.610	0.640	0.670		(7),(8) SR-3
		R_y	0.300	0.330	0.360		
	Green	G_x	0.270	0.300	0.330		
		G_y	0.570	0.600	0.630		
	Blue	B_x	0.120	0.150	0.180		
		B_y	0.030	0.060	0.090		
	White	W_x	0.283	0.313	0.343		
		W_y	0.299	0.329	0.359		
Color Chromaticity (CIE 1976)	Red	$R_{u'}$	-	0.451	-		
		$R_{v'}$	-	0.523	-		
	Green	$G_{u'}$	-	0.125	-		
		$G_{v'}$	-	0.564	-		
	Blue	$B_{u'}$	-	0.175	-		
		$B_{v'}$	-	0.158	-		
	White	$W_{u'}$	-	0.198	-		
		$W_{v'}$	-	0.468	-		
C.G.L (ACC ONLY)	White	$\Delta u'v'$	-	-	0.02	(9)	

* C.G.L : Color Grayscale Linearity

Item	Symbol	Condition	Min.	Typ.	Max.	Unit	Note
Color Gamut	-		-	72	-	%	
Color Temperature	-		-	6500	-	K	
Viewing Angle	Hor.	θ_L	70	80	-	Degrees	(8) EZ-Contrast
		θ_R	70	80	-		
	Ver.	θ_U	70	80	-		
		θ_D	70	80	-		
Brightness Uniformity (9 Points)	B_{uni}		-	-	25	%	(4) SR-3

Note (1) Test Equipment Setup

The measurement should be executed in a stable, windless and dark room between 30min after lighting the back light at the given temperature for stabilization of the back light. This should be measured in the center of screen.

Single lamp current : 7.5mA

Environment condition : $T_a = 25 \pm 2 ^\circ\text{C}$

Photo detector	Field
SR-3	2'

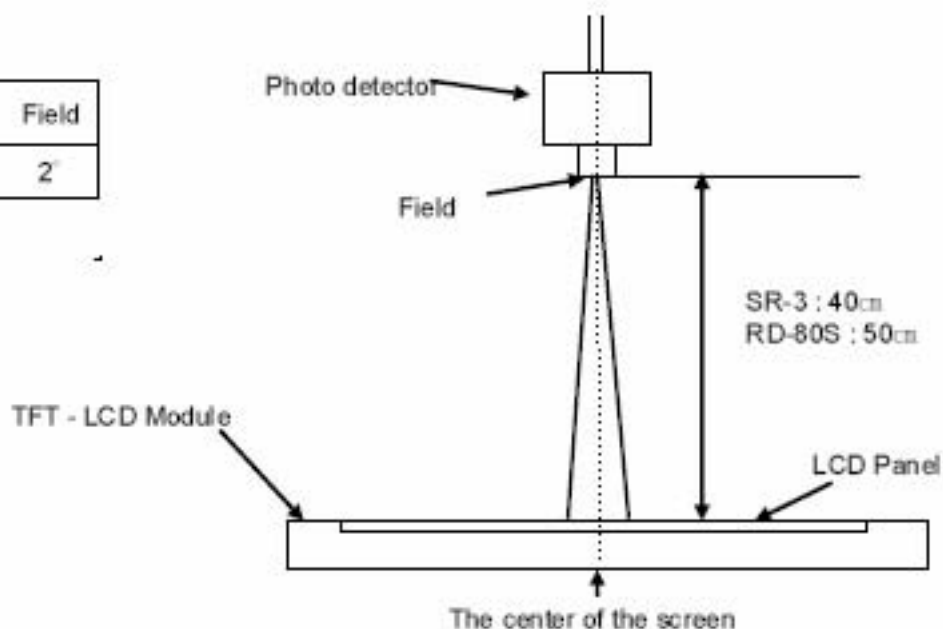

Note (2) Definition of test point

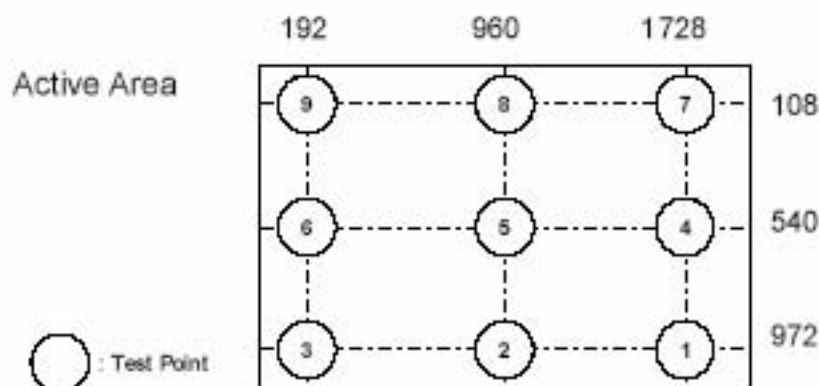

Note (3) Definition of Contrast Ratio (C/R)

: Ratio of gray max (Gmax) & gray min (Gmin) at the center point ⑤ of the panel

$$CR = \frac{G \max}{G \min}$$

Gmax : Luminance with all pixels white

Gmin : Luminance with all pixels black

Note (4) Definition of 9 points brightness uniformity

$$Buni = 100 \times \frac{(B \max - B \min)}{B \max}$$

Bmax : Maximum brightness

Bmin : Minimum brightness

Note (5) Definition of Response time : Sum of Tr, Tf

Display Data



Optical Instruments
Response

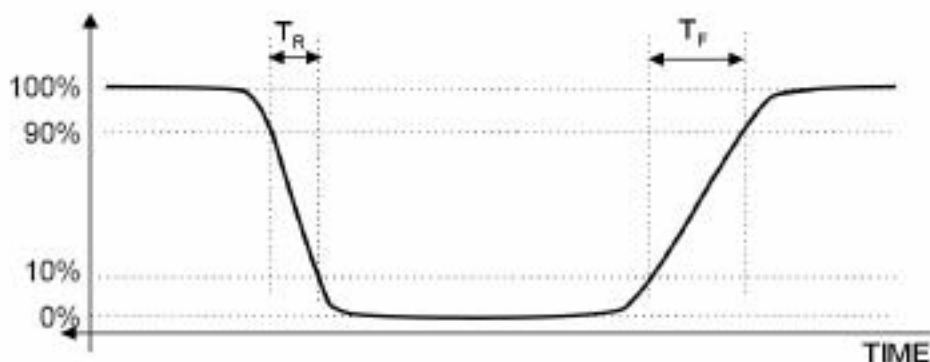

Note (6) Definition of Luminance of White : Luminance of white at center point⑤

Note (7) Definition of Color Chromaticity (CIE 1931, CIE1976)

Color coordinate of Red, Green, Blue & White at center point⑤

Note (8) Definition of Viewing Angle

: Viewing angle range ($CR \geq 10,5$)

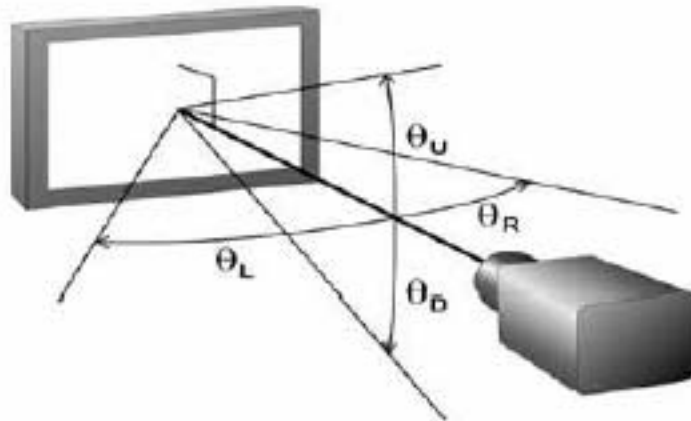

Note (9) Color Grayscale Linearity

a. Test image : 100% full white pattern with a test pattern as below

b. Test pattern : Squares, 40mm by 40mm in size, filled with 255, 225, 195, 165, 135 and 105 grays steps should be arranged at the center⁵⁾ of the screen.

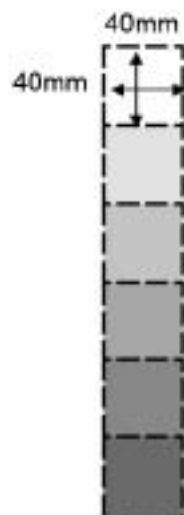

c. Test method

- 1st gray step : move a square of 255 gray level should be moved into the center of the screen and measure luminance and u' and v' coordinates.

- Next gray step : Move a 225 gray square into the center and measure both luminance and coordinates, too.

d. Test evaluation

$$\Delta u'v' = \sqrt{(u'_A - u'_B)^2 + (v'_A - v'_B)^2}$$

Where A, B : 2 gray levels found to have the largest color differences between them

i.e. get the largest $\Delta u'$ and $\Delta v'$ of each 6 pair of u' and v' and calculate the $\Delta u'v'$.

3. Electrical Characteristics

3.1 TFT LCD Module

The connector for display data & timing signal should be connected.

$T_a = 25^\circ\text{C}$

Item	Symbol	Min.	Typ.	Max.	Unit	Note	
Voltage of Power Supply	V_{DD}	4.5	5.0	5.5	V	(1)	
LVDS Input Characteristics	Differential Input Voltage for LVDS Receiver Threshold	High	-	-	+100	mV	(2)
		Low	-100	-	-	mV	
	LVDS skew	t_{SKW}	-300		300	ps	(3)
	Differential input voltage	$ V_{ID} $	200		600	mV	(4)
	Input voltage range (single-ended)	V_{IN}	0		2.4	V	(4)
	Common mode voltage	V_{CM}	$0+ V_{ID} /2$	1.2	$2.4- V_{ID} /2$	V	(4)
Current of Power Supply	(a) Black	I_{DD}	-	1,600	-	mA	(5),(6)
	(b) White		-	1,100	-	mA	
	(c) Dot		-	1,800	2,200	mA	
Vsync Frequency	f_V	49	60	75	Hz		
Hsync Frequency	f_H	54	60	75	kHz		
Main Frequency	f_{DCLK}	55	68	85	MHz		
Rush Current	I_{RUSH}	-	-	5.0	A	(7)	

Note (1) The ripple voltage should be controlled under 10% of V_{DD} .

(2) Differential receiver voltage definitions and propagation delay and transition time test circuit

- a. All input pulses have frequency = 10MHz, t_r or $t_f = 1ns$
 b. C_L includes all probe and fixture capacitance

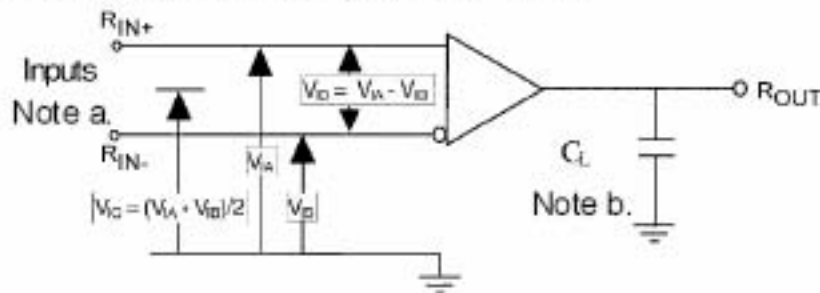

(3) LVDS Receiver DC parameters are measured under static and steady conditions which may not be reflective of its performance in the end application.

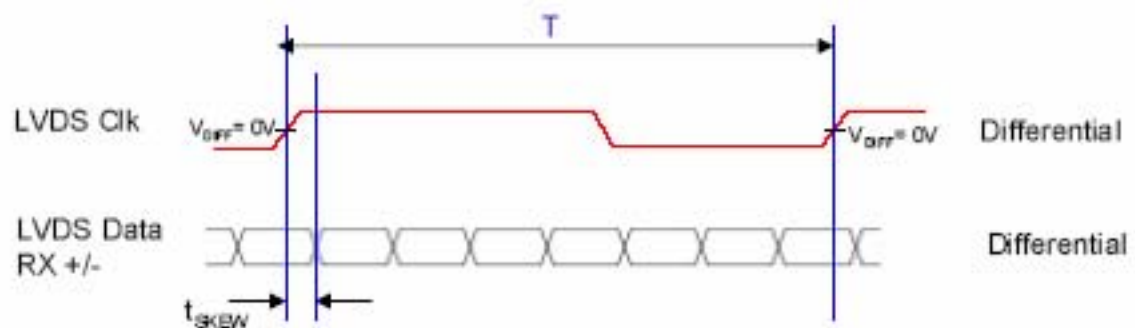

where t_{skew} : skew between LVDS clock & LVDS data,

T : 1 period time of LVDS clock

cf) (-/+) of 300psec means LVDS data goes before or after LVDS clock.

(4) Definition of V_{ID} and V_{CM} using single-end signals

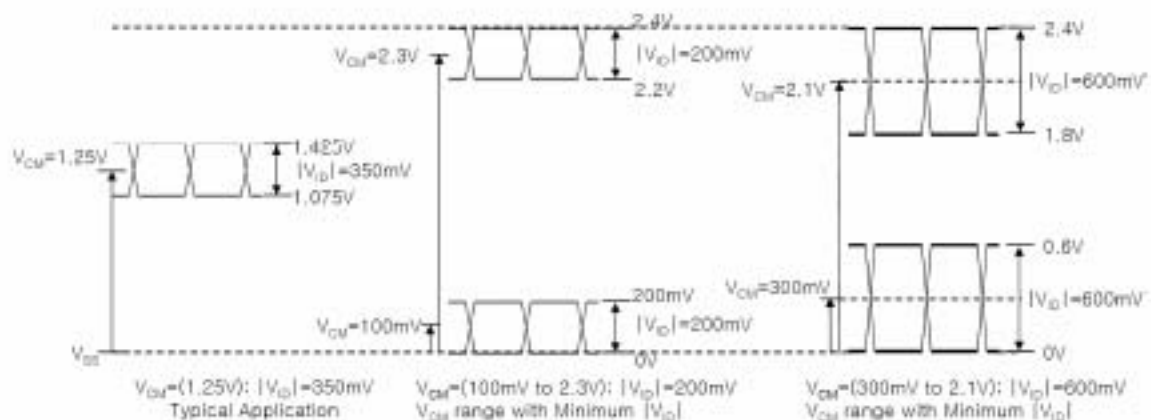

(5) $f_V=60\text{Hz}$, $f_{DCLK} = 69.3\text{MHz}$, $V_{DD} = 5.0\text{V}$, DC Current.

(6) Power dissipation check pattern (LCD Module only)

a) Black Pattern

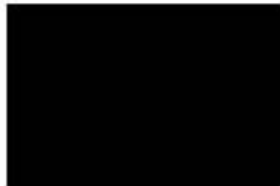

b) White Pattern

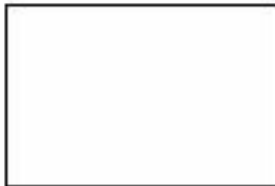

c) Dot Pattern



(7) Measurement Condition

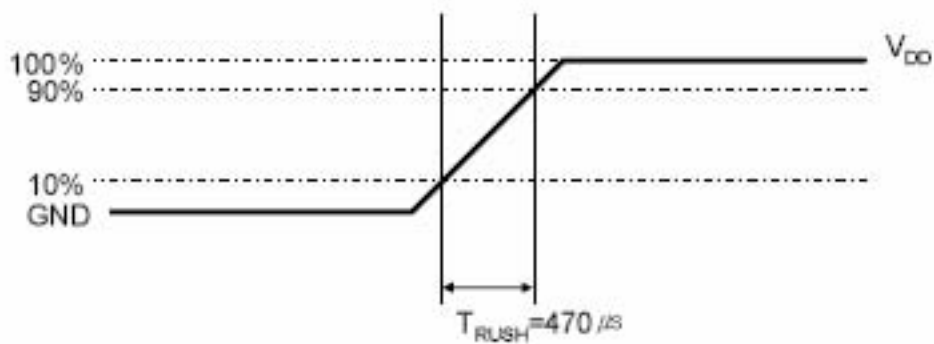

Rush Current I_{RUSH} can be measured when T_{RUSH} is $470 \mu\text{s}$.

3.2 Back Light Unit

The back light unit is an edge - lighting type with 2 dual CCFTs (Cold Cathode Fluorescent Tube) The characteristics of two dual lamps are shown in the following tables.

$T_a=25 \pm 2^\circ\text{C}$

Item	Symbol	Min.	Typ.	Max.	Unit	Note	
Lamp Current	I_L	4.0	7.5	8.0	mArms	(1)	
Lamp Voltage	V_L	-	850	-	Vrms		
Lamp Frequency	f_L	40	-	80	kHz	(2)	
Operating Life Time	Hr	50,000	-	-	Hour	(3)	
Inverter waveform	Asymmetry rate	Wasy	-	-	10	%	(4)
	Distortion rate	Wdis	1.2726	1.414	1.5554		
Startup Voltage	V_s	-	-	0°C : 1,840	Vrms	(5)	
				25°C : 1,450			

Note (1) Specified values are for a single lamp.

Lamp current is measured with current meter for high frequency as shown below.

Refer to the following block diagram of the back light unit for more information.

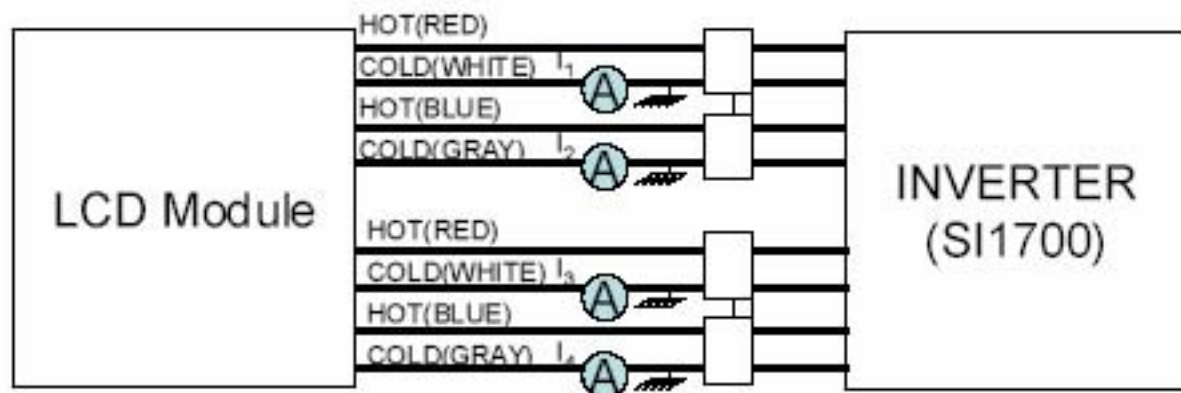

Fig. Measurement point of Lamp Current

(2) Lamp frequency which may produce interference with horizontal synchronous frequency may cause line flow on the display. Therefore lamp frequency should be detached from the horizontal synchronous frequency and its harmonics as far as possible in order to avoid interference.

(3) Life time (Hr) is defined as the time when brightness of a lamp unit itself becomes 50% or less than its original value at the condition of $T_a = 25 \pm 2^\circ\text{C}$ and $I_L = 7.5\text{mA}_{\text{rms}}$

(4) Designing a system inverter intended to have better display performance, power efficiency and lamp reliability.

They would help increase the lamp lifetime and reduce leakage current.

- The measurement should be done at typical lamp current.
- The asymmetry rate of the inverter waveform should be less than 10%.
- The distortion rate of the waveform should be $\sqrt{2}$ with $\pm 10\%$ tolerance.
 - Inverter output waveform had better be more similar to ideal sine wave.

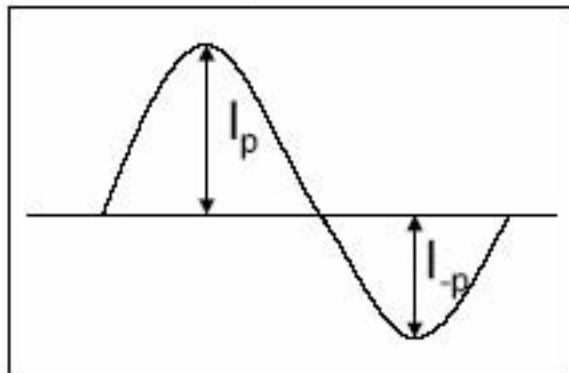

Fig. Wave form of the inverter

- Asymmetry rate

$$\frac{|I_p - I_{-p}|}{I_{\text{rms}}} \times 100$$

- Distortion rate

$$\left| \frac{I_p}{I_{\text{rms}}} \right| \text{ or } \left| \frac{I_{-p}}{I_{\text{rms}}} \right|$$

(5) If an inverter has shutdown function, it should keep its output for over 1 second even if the lamp connector is open. Otherwise the lamps may not be turned on.

4. BLOCK DIAGRAM

4.1 TFT LCD Module

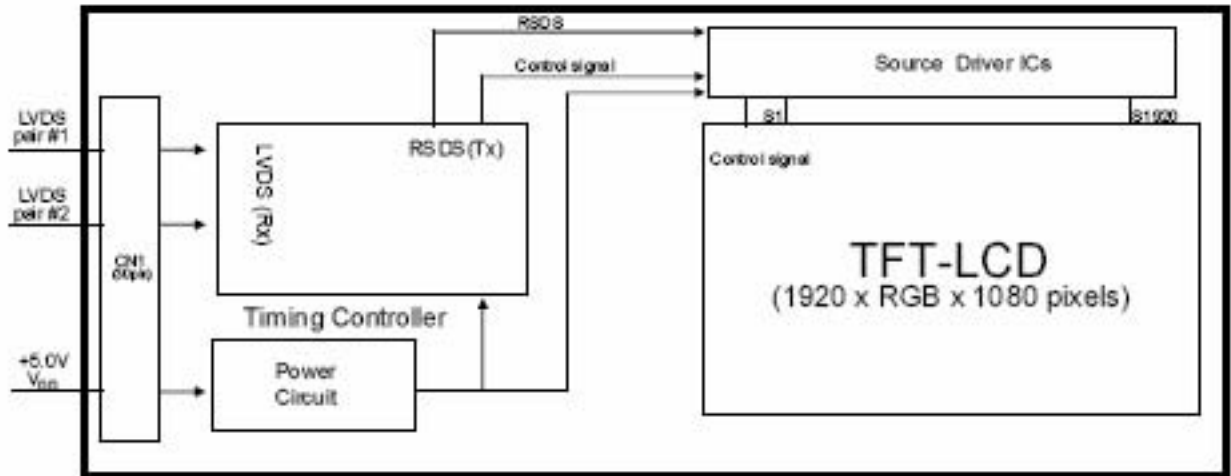

4.2 Back Light Unit

Connector: YEON-HO 35001HS-04L

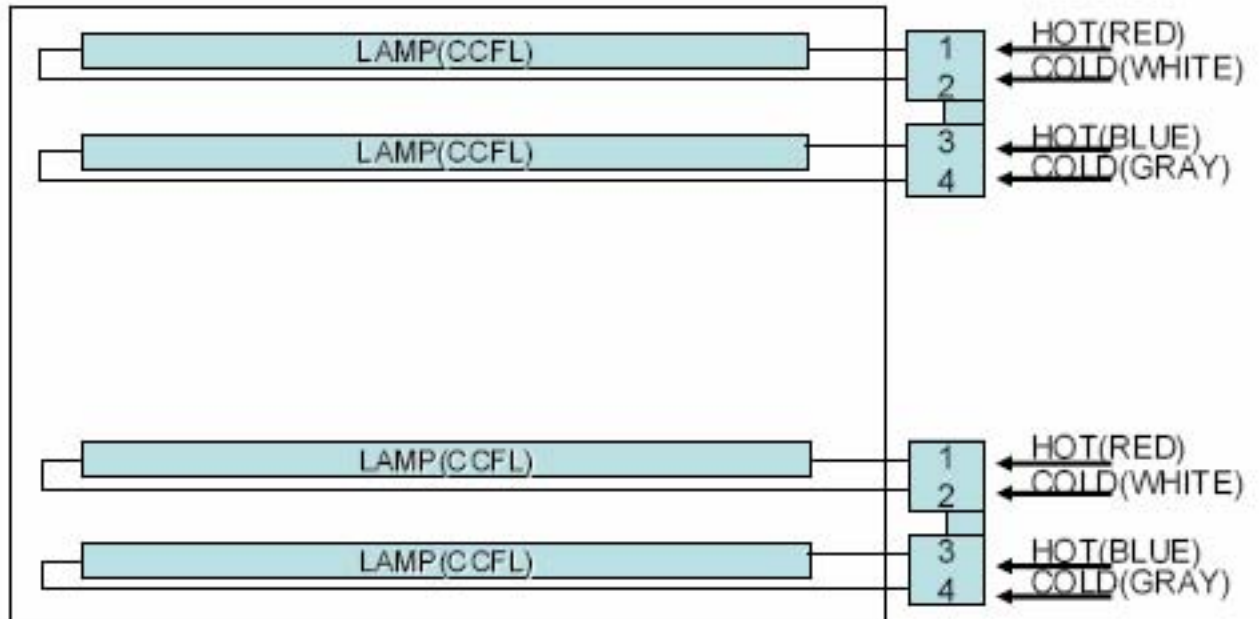

5. Input Terminal Pin Assignment

5.1. Input Signal & Power (Connector : UJU IS100-L300-C23 or Compatible)

PIN NO	SYMBOL	FUNCTION
1	RXO0N	Negative LVDS differential data output
2	RXO0P	Positive LVDS differential data output
3	RXO1N	Negative LVDS differential data output
4	RXO1P	Positive LVDS differential data output
5	RXO2N	Negative LVDS differential data output
6	RXO2P	Positive LVDS differential data output
7	GND	Ground
8	RXOC-	Negative Sampling Clock (ODD data)
9	RXOC+	Positive Sampling Clock (ODD data)
10	RXO3N	Negative LVDS differential data output
11	RXO3P	Positive LVDS differential data output
12	RXE0N	Negative LVDS differential data output
13	RXE0P	Positive LVDS differential data output
14	GND	Ground
15	RXE1N	Negative LVDS differential data output
16	RXE1P	Positive LVDS differential data output
17	GND	Ground
18	RXE2N	Negative LVDS differential data output
19	RXE2P	Positive LVDS differential data output
20	RXEC-	Negative Sampling Clock (EVEN data)
21	RXEC+	Positive Sampling Clock (EVEN data)
22	RXE3N	Negative LVDS differential data output
23	RXE3P	Positive LVDS differential data output
24	GND	Ground
25	NC	* CE (For LCD internal use only. Do not connect)
26	NC	* CTL (For LCD internal use only. Do not connect)
27	NC	No Connection
28	VDD	Power Supply : +5V
29	VDD	
30	VDD	

* If the system already uses the 25, 26pins, it should keep under GND level
The voltage applied to those pins should not exceed -200mV.

Note) Pin number starts from Left side

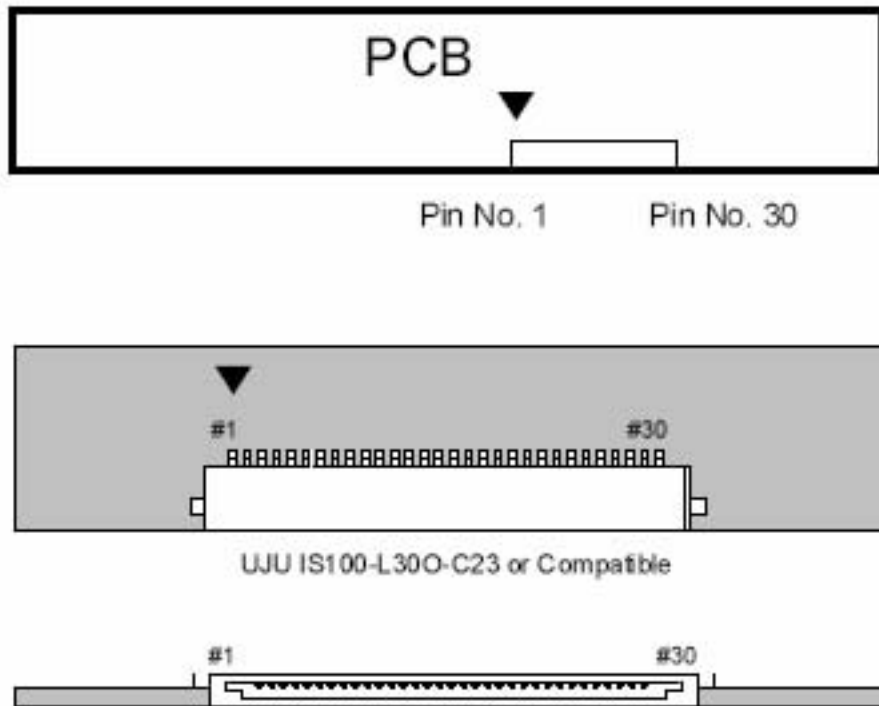

Fig. Connector diagram

- All GND pins should be connected together and also be connected to the LCD's metal chassis.
- All power input pins should be connected together.
- All NC pins should be separated from other signal or power.

5.2 LVDS Interface (1)

5.2.1 Odd Pixel Data (1st pixel data)

LVDS Transmitter (DS90C383, DS90C385) Signal Interface						
Device Input Pin		Device Input Signal		Output Signal	To LTM230HT01 Interface (CN101)	
No	Symbol	Symbol	Function		Terminal	Symbol
51	TXIN0	RO0	Red Odd Pixel Data (LSB)	TXOUT0- TXOUT0+	No. 1 No. 2	RXO0- RXO0+
52	TXIN1	RO1	Red Odd Pixel Data			
54	TXIN2	RO2	Red Odd Pixel Data			
55	TXIN3	RO3	Red Odd Pixel Data			
56	TXIN4	RO4	Red Odd Pixel Data			
2	TXIN5	RO7	Red Odd Pixel Data (MSB)	TXOUT3- TXOUT3+	No. 10 No. 11	RXO3- RXO3+
3	TXIN6	RO5	Red Odd Pixel Data	TXOUT0- TXOUT0+	No. 1 No. 2	RXO0- RXO0+
4	TXIN7	GO0	Green Odd Pixel Data (LSB)			
6	TXIN8	GO1	Green Odd Pixel Data	TXOUT1- TXOUT1+	No. 3 No. 4	RXO1- RXO1+
7	TXIN9	GO2	Green Odd Pixel Data			
8	TXIN10	GO6	Green Odd Pixel Data	TXOUT3- TXOUT3+	No. 10 No. 11	RXO3- RXO3+
10	TXIN11	GO7	Green Odd Pixel Data (MSB)			
11	TXIN12	GO3	Green Odd Pixel Data	TXOUT1- TXOUT1+	No. 3 No. 4	RXO1- RXO1+
12	TXIN13	GO4	Green Odd Pixel Data			
14	TXIN14	GO5	Green Odd Pixel Data			
15	TXIN15	BO0	Blue Odd Pixel Data (LSB)	TXOUT3- TXOUT3+	No. 10 No. 11	RXO3- RXO3+
16	TXIN16	BO6	Blue Odd Pixel Data			
18	TXIN17	BO7	Blue Odd Pixel Data (MSB)			
19	TXIN18	BO1	Blue Odd Pixel Data	TXOUT1- TXOUT1+	No. 3 No. 4	RXO1- RXO1+
20	TXIN19	BO2	Blue Odd Pixel Data	TXOUT2- TXOUT2+	No. 5 No. 6	RXO2- RXO2+
22	TXIN20	BO3	Blue Odd Pixel Data			
23	TXIN21	BO4	Blue Odd Pixel Data			
24	TXIN22	BO5	Blue Odd Pixel Data			
50	TXIN27	RO6	Red Odd Pixel Data	TXOUT3- TXOUT3+	No. 10 No. 11	RXO3- RXO3+

5.2.2 Even Pixel Data (2nd pixel data)

LVDS Transmitter (DS90C383, DS90C385) Signal Interface

Device Input Pin		Device Input Signal		Output Signal	To LTM230HT01 Interface (CN101)	
No	Symbol	Symbol	Function		Terminal	Symbol
51	TXIN0	RE0	Red Even Pixel Data (LSB)	TXOUT0- TXOUT0+	No. 12 No. 13	RXE0- RXE0+
52	TXIN1	RE1	Red Even Pixel Data			
54	TXIN2	RE2	Red Even Pixel Data			
55	TXIN3	RE3	Red Even Pixel Data			
56	TXIN4	RE4	Red Even Pixel Data			
2	TXIN5	RE7	Red Even Pixel Data (MSB)	TXOUT3- TXOUT3+	No. 22 No. 23	RXE3- RXE3+
3	TXIN6	RE5	Red Even Pixel Data	TXOUT0- TXOUT0+	No. 12 No. 13	RXE0- RXE0+
4	TXIN7	GE0	Green Even Pixel Data (LSB)			
6	TXIN8	GE1	Green Even Pixel Data	TXOUT1- TXOUT1+	No. 15 No. 16	RXE1- RXE1+
7	TXIN9	GE2	Green Even Pixel Data			
8	TXIN10	GE6	Green Even Pixel Data	TXOUT3- TXOUT3+	No. 22 No. 23	RXE3- RXE3+
10	TXIN11	GE7	Green Even Pixel Data (MSB)			
11	TXIN12	GE3	Green Even Pixel Data	TXOUT1- TXOUT1+	No. 15 No. 16	RXE1- RXE1+
12	TXIN13	GE4	Green Even Pixel Data			
14	TXIN14	GE5	Green Even Pixel Data			
15	TXIN15	BE0	Blue Even Pixel Data (LSB)	TXOUT3- TXOUT3+	No. 22 No. 23	RXE3- RXE3+
16	TXIN16	BE6	Blue Even Pixel Data			
18	TXIN17	BE7	Blue Even Pixel Data (MSB)			
19	TXIN18	BE1	Blue Even Pixel Data	TXOUT1- TXOUT1+	No. 15 No. 16	RXE1- RXE1+
20	TXIN19	BE2	Blue Even Pixel Data	TXOUT2- TXOUT2+	No. 18 No. 19	RXE2- RXE2+
22	TXIN20	BE3	Blue Even Pixel Data			
23	TXIN21	BE4	Blue Even Pixel Data			
24	TXIN22	BE5	Blue Even Pixel Data			
50	TXIN27	RE6	Red Even Pixel Data	TXOUT3- TXOUT3+	No. 22 No. 23	RXE3- RXE3+

5.2 LVDS Interface (2)

5.2.3 Odd Pixel Data (1st pixel data)

LVDS Transmitter (DS90C387) Signal Interface

Device Input Pin		Device Input Signal		Output Signal	To LTM230HT01 Interface (CN101)	
No	Symbol	Symbol	Function		Terminal	Symbol
10	R10	RO0	Red Odd Pixel Data (LSB)	A0M A0P	No. 1 No. 2	RXO0- RXO0+
9	R11	RO1	Red Odd Pixel Data			
8	R12	RO2	Red Odd Pixel Data			
7	R13	RO3	Red Odd Pixel Data			
6	R14	RO4	Red Odd Pixel Data			
3	R17	RO7	Red Odd Pixel Data (MSB)	A3M A3P	No. 10 No. 11	RXO3- RXO3+
5	R15	RO5	Red Odd Pixel Data	A0M A0P	No. 1 No. 2	RXO0- RXO0+
2	G10	GO0	Green Odd Pixel Data (LSB)			
1	G11	GO1	Green Odd Pixel Data	A1M A1P	No. 3 No. 4	RXO1- RXO1+
100	G12	GO2	Green Odd Pixel Data			
94	G16	GO6	Green Odd Pixel Data	A3M A3P	No. 10 No. 11	RXO3- RXO3+
93	G17	GO7	Green Odd Pixel Data (MSB)			
99	G13	GO3	Green Odd Pixel Data	A1M A1P	No. 3 No. 4	RXO1- RXO1+
96	G14	GO4	Green Odd Pixel Data			
95	G15	GO5	Green Odd Pixel Data			
92	B10	BO0	Blue Odd Pixel Data (LSB)			
86	B16	BO6	Blue Odd Pixel Data	A3M A3P	No. 10 No. 11	RXO3- RXO3+
85	B17	BO7	Blue Odd Pixel Data (MSB)			
91	B11	BO1	Blue Odd Pixel Data	A1M A1P	No. 3 No. 4	RXO1- RXO1+
90	B12	BO2	Blue Odd Pixel Data			
89	B13	BO3	Blue Odd Pixel Data	A2M A2P	No. 5 No. 6	RXO2- RXO2+
88	B14	BO4	Blue Odd Pixel Data			
87	B15	BO5	Blue Odd Pixel Data			
4	R16	RO6	Red Odd Pixel Data	A3M A3P	No. 10 No. 11	RXO3- RXO3+

5.2.4 Even Pixel Data (2nd pixel data)

LVDS Transmitter (DS90C387) Signal Interface						
Device Input Pin		Device Input Signal		Output Signal	To LTM230HT01 Interface (CN101)	
No	Symbol	Symbol	Function		Terminal	Symbol
84	R20	RE0	Red Even Pixel Data (LSB)	A4M A4P	No. 12 No. 13	RXE0- RXE0+
81	R21	RE1	Red Even Pixel Data			
80	R22	RE2	Red Even Pixel Data			
79	R23	RE3	Red Even Pixel Data			
78	R24	RE4	Red Even Pixel Data			
75	R27	RE7	Red Even Pixel Data (MSB)	A7M A7P	No. 22 No. 23	RXE3- RXE3+
77	R25	RE5	Red Even Pixel Data	A4M A4P	No. 12 No. 13	RXE0- RXE0+
74	G20	GE0	Green Even Pixel Data (LSB)			
73	G21	GE1	Green Even Pixel Data	A5M A5P	No. 15 No. 16	RXE1- RXE1+
72	G22	GE2	Green Even Pixel Data			
66	G26	GE6	Green Even Pixel Data	A7M A7P	No. 22 No. 23	RXE3- RXE3+
65	G27	GE7	Green Even Pixel Data (MSB)			
71	G23	GE3	Green Even Pixel Data	A5M A5P	No. 15 No. 16	RXE1- RXE1+
70	G24	GE4	Green Even Pixel Data			
69	G25	GE5	Green Even Pixel Data			
64	B20	BE0	Blue Even Pixel Data (LSB)	A7M A7P	No. 22 No. 23	RXE3- RXE3+
58	B26	BE6	Blue Even Pixel Data			
57	B27	BE7	Blue Even Pixel Data (MSB)			
63	B21	BE1	Blue Even Pixel Data	A5M A5P	No. 15 No. 16	RXE1- RXE1+
62	B22	BE2	Blue Even Pixel Data	A6M A6P	No. 18 No. 19	RXE2- RXE2+
61	B23	BE3	Blue Even Pixel Data			
60	B24	BE4	Blue Even Pixel Data			
59	B25	BE5	Blue Even Pixel Data			
76	R26	RE6	Red Even Pixel Data	A7M A7P	No. 22 No. 23	RXE3- RXE3+

5.2.5 Timing Diagrams of LVDS For Transmitting LVDS Receiver : Integrated T-CON

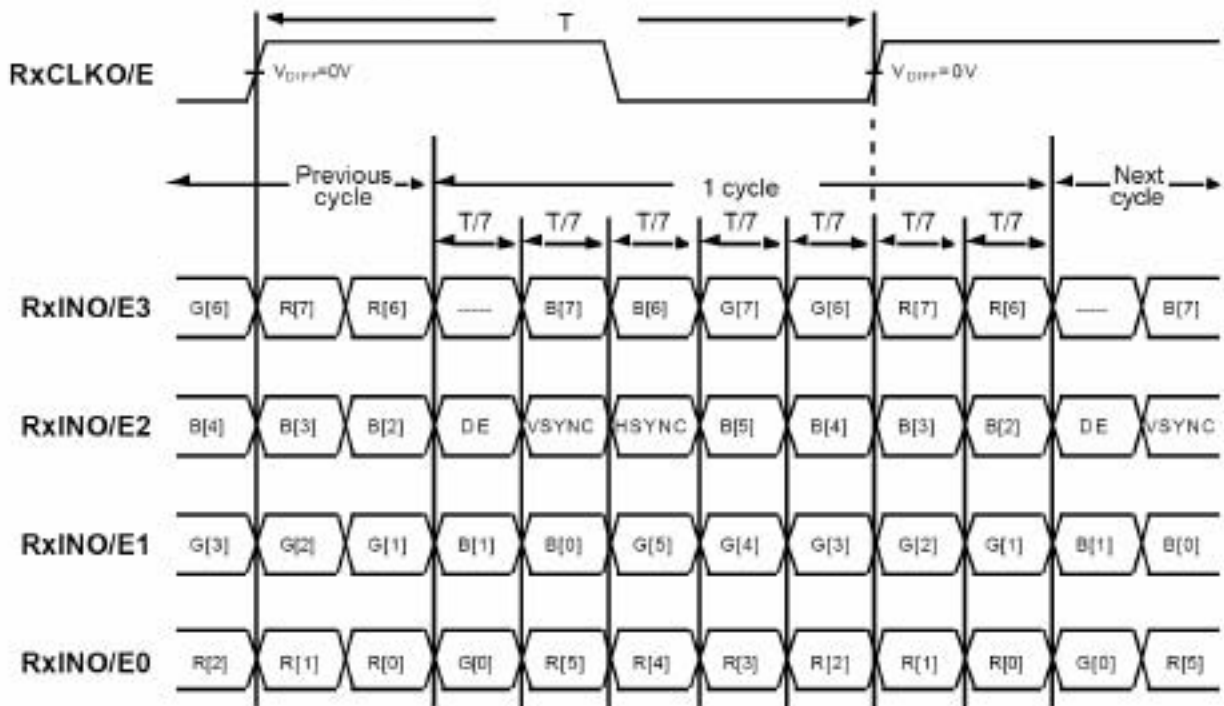

5.3 Back Light Unit

	Pin No.	Input	Color	Function
Upper	1	Hot1	RED	High Voltage
	2	Cold1	White	Ground
	-			
	3	Hot2	Blue	High Voltage
	4	Cold2	Gray	Ground
Lower	1	Hot1	RED	High Voltage
	2	Cold1	White	Ground
	-			
	3	Hot2	Blue	High Voltage
	4	Cold2	Gray	Ground
	Connect or Part No.	YEON-HO 35001HS-04L		

5.3 Input Signals, Basic Display Colors and Gray Scale of Each Color

COLOR	DISPLAY (8bit)	DATA SIGNAL																												GRAY SCALE LEVEL			
		RED								GREEN								BLUE															
		R0	R1	R2	R3	R4	R5	R6	R7	G0	G1	G2	G3	G4	G5	G6	G7	B0	B1	B2	B3	B4	B5	B6	B7								
BASIC COLOR	BLACK	0	0	0	0	0	0	0	0	0	0	0	0	0	0	0	0	0	0	0	0	0	0	0	0	0	0	0	0	0	0	0	-
	BLUE	0	0	0	0	0	0	0	0	0	0	0	0	0	0	0	0	0	0	0	1	1	1	1	1	1	1	1	1	1	1	1	-
	GREEN	0	0	0	0	0	0	0	0	1	1	1	1	1	1	1	1	1	0	0	0	0	0	0	0	0	0	0	0	0	0	0	-
	CYAN	0	0	0	0	0	0	0	0	1	1	1	1	1	1	1	1	1	1	1	1	1	1	1	1	1	1	1	1	1	1	1	-
	RED	1	1	1	1	1	1	1	1	0	0	0	0	0	0	0	0	0	0	0	0	0	0	0	0	0	0	0	0	0	0	0	-
	MAGENTA	1	1	1	1	1	1	1	1	0	0	0	0	0	0	0	0	0	1	1	1	1	1	1	1	1	1	1	1	1	1	1	-
	YELLOW	1	1	1	1	1	1	1	1	1	1	1	1	1	1	1	1	1	0	0	0	0	0	0	0	0	0	0	0	0	0	0	-
	WHITE	1	1	1	1	1	1	1	1	1	1	1	1	1	1	1	1	1	1	1	1	1	1	1	1	1	1	1	1	1	1	1	-
GRAY SCALE OF RED	BLACK	0	0	0	0	0	0	0	0	0	0	0	0	0	0	0	0	0	0	0	0	0	0	0	0	0	0	0	0	0	0	R0	
	DARK ↑ ↓ LIGHT	1	0	0	0	0	0	0	0	0	0	0	0	0	0	0	0	0	0	0	0	0	0	0	0	0	0	0	0	0	0	R1	
		0	1	0	0	0	0	0	0	0	0	0	0	0	0	0	0	0	0	0	0	0	0	0	0	0	0	0	0	0	0	R2	
		:	:	:	:	:	:	:	:	:	:	:	:	:	:	:	:	:	:	:	:	:	:	:	:	:	:	:	:	:	:	:	R3- R252
		:	:	:	:	:	:	:	:	:	:	:	:	:	:	:	:	:	:	:	:	:	:	:	:	:	:	:	:	:	:	:	
		1	0	1	1	1	1	1	1	1	0	0	0	0	0	0	0	0	0	0	0	0	0	0	0	0	0	0	0	0	0	R253	
	0	1	1	1	1	1	1	1	1	0	0	0	0	0	0	0	0	0	0	0	0	0	0	0	0	0	0	0	0	0	0	R254	
RED	1	1	1	1	1	1	1	1	0	0	0	0	0	0	0	0	0	0	0	0	0	0	0	0	0	0	0	0	0	0	R255		
GRAY SCALE OF GREEN	BLACK	0	0	0	0	0	0	0	0	0	0	0	0	0	0	0	0	0	0	0	0	0	0	0	0	0	0	0	0	0	0	G0	
	DARK ↑ ↓ LIGHT	0	0	0	0	0	0	0	0	1	0	0	0	0	0	0	0	0	0	0	0	0	0	0	0	0	0	0	0	0	0	G1	
		0	0	0	0	0	0	0	0	0	1	0	0	0	0	0	0	0	0	0	0	0	0	0	0	0	0	0	0	0	0	G2	
		:	:	:	:	:	:	:	:	:	:	:	:	:	:	:	:	:	:	:	:	:	:	:	:	:	:	:	:	:	:	:	G3- G252
		:	:	:	:	:	:	:	:	:	:	:	:	:	:	:	:	:	:	:	:	:	:	:	:	:	:	:	:	:	:	:	
		0	0	0	0	0	0	0	0	0	1	0	1	1	1	1	1	1	0	0	0	0	0	0	0	0	0	0	0	0	0	G253	
	0	0	0	0	0	0	0	0	0	0	1	1	1	1	1	1	1	0	0	0	0	0	0	0	0	0	0	0	0	0	0	G254	
GREEN	0	0	0	0	0	0	0	0	1	1	1	1	1	1	1	1	0	0	0	0	0	0	0	0	0	0	0	0	0	0	G255		
GRAY SCALE OF BLUE	BLACK	0	0	0	0	0	0	0	0	0	0	0	0	0	0	0	0	0	0	0	0	0	0	0	0	0	0	0	0	0	0	B0	
	DARK ↑ ↓ LIGHT	0	0	0	0	0	0	0	0	0	0	0	0	0	0	0	0	0	1	0	0	0	0	0	0	0	0	0	0	0	0	B1	
		0	0	0	0	0	0	0	0	0	0	0	0	0	0	0	0	0	0	1	0	0	0	0	0	0	0	0	0	0	0	B2	
		:	:	:	:	:	:	:	:	:	:	:	:	:	:	:	:	:	:	:	:	:	:	:	:	:	:	:	:	:	:	:	B3- B252
		:	:	:	:	:	:	:	:	:	:	:	:	:	:	:	:	:	:	:	:	:	:	:	:	:	:	:	:	:	:	:	
		0	0	0	0	0	0	0	0	0	0	0	0	0	0	0	0	0	0	1	0	1	1	1	1	1	1	1	1	1	1	B253	
	0	0	0	0	0	0	0	0	0	0	0	0	0	0	0	0	0	0	0	1	1	1	1	1	1	1	1	1	1	1	1	B254	
BLUE	0	0	0	0	0	0	0	0	0	0	0	0	0	0	0	0	0	1	1	1	1	1	1	1	1	1	1	1	1	1	B255		

Note (1) Definition of Gray :

Rn : Red Gray, Gn : Green Gray, Bn : Blue Gray (n = Gray level)

Input Signal : 0 = Low level voltage, 1 = High level voltage

6. Interface Timing

6.1 Timing Parameters (DE only mode)

SIGNAL	ITEM	SYMBOL	MIN.	TYP.	MAX.	Unit	NOTE
Clock	Frequency	$1/T_C$	55	68	86	MHz	-
Hsync		F_H	54	66	83	KHz	-
Vsync		F_V	49	60	75	Hz	-
Vertical Display Term	Active Display Period	T_{VD}		1080		lines	-
	Vertical Total	T_V	1105	1111	1118	lines	-
Horizontal Display Term	Active Display Period	T_{HD}		960		clocks	2pixel/clock
	Horizontal Total	T_H	990	1010	1040	clocks	2pixel/clock

Note (1) This product is DE only mode. The input of Hsync & Vsync signal does not have an effect on normal operation.

(2) Test Point : TTL control signal and CLK at LVDS Tx input terminal in system

(3) Internal Vcc = 3.3V

(4) Best operation clock frequency is 69.3MHz (60Hz)

(5) Clock frequency = Frame frequency $\times T_V(\text{Typ}) \times T_H(\text{Typ})$

(6) Max, Min variation range is at main clock Typ value (69.3MHz).

6.2 Timing diagrams of interface signal (DE only mode)

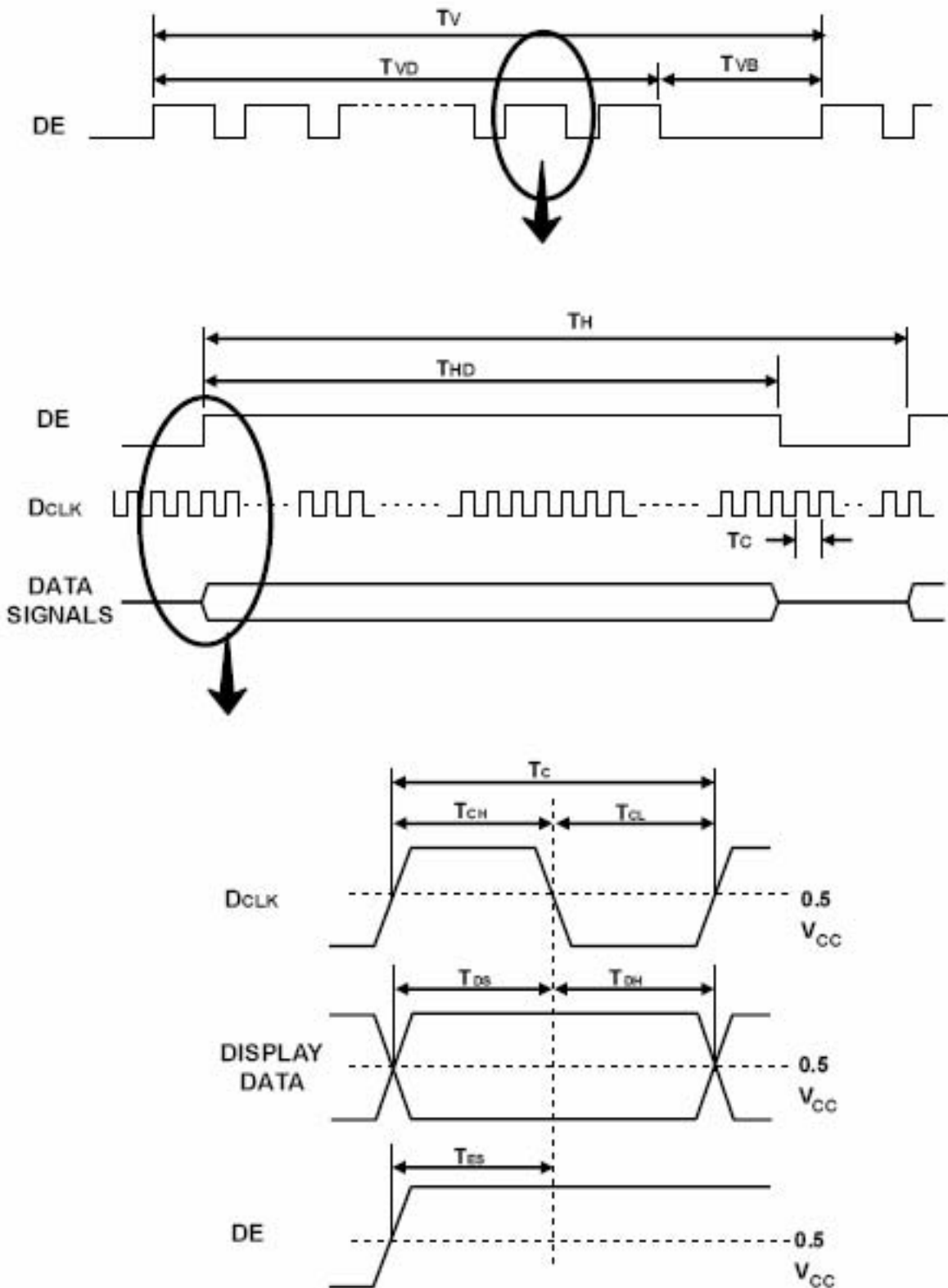

6.3 Power ON/OFF Sequence

To prevent a latch-up or DC operation of the LCD Module, the power on/off sequence should be as the diagram below.

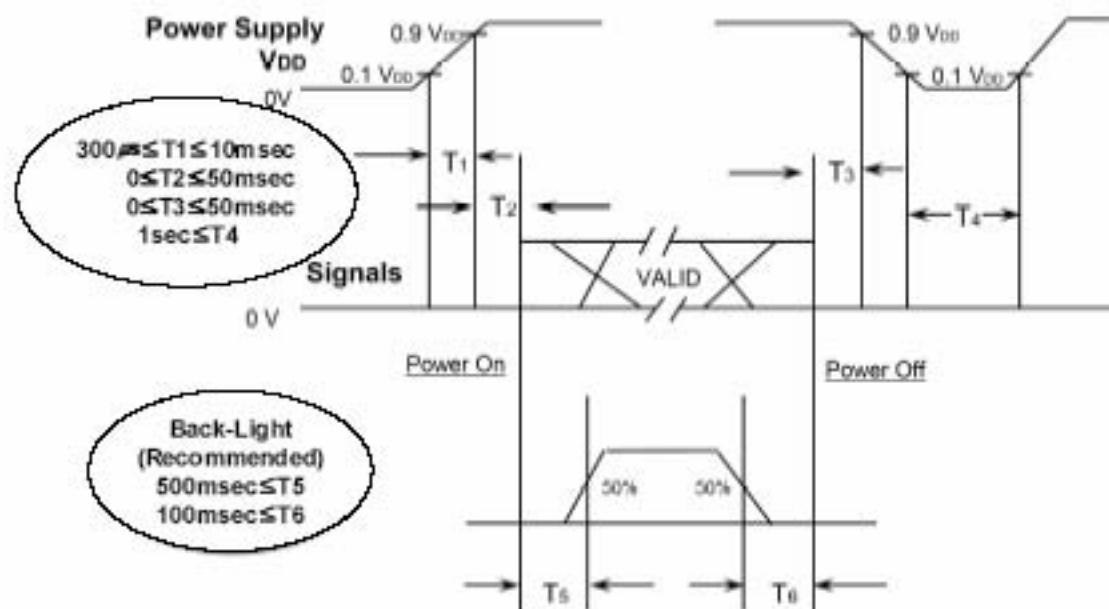

T_1 : V_{DD} rising time from 10% to 90%

T_2 : The time from V_{DD} to valid data at power ON.

T_3 : The time from valid data off to V_{DD} off at power Off.

T_4 : V_{DD} off time for Windows restart

T_5 : The time from valid data to B/L enable at power ON.

T_6 : The time from valid data off to B/L disable at power Off.

- The supply voltage of the external system for the Module input should be the same as the definition of V_{DD} .
- Apply the lamp voltage within the LCD operation range. When the back light turns on before the LCD operation or the LCD turns off before the back light turns off, the display may momentarily show abnormal screen.
- In case of V_{DD} = off level, please keep the level of input signals low or keep a high impedance.
- T_4 should be measured after the Module has been fully discharged between power off and on period.
- Interface signal should not be kept at high impedance when the power is on.

6.3 Power ON/OFF Sequence

To prevent a latch-up or DC operation of the LCD Module, the power on/off sequence should be as the diagram below.

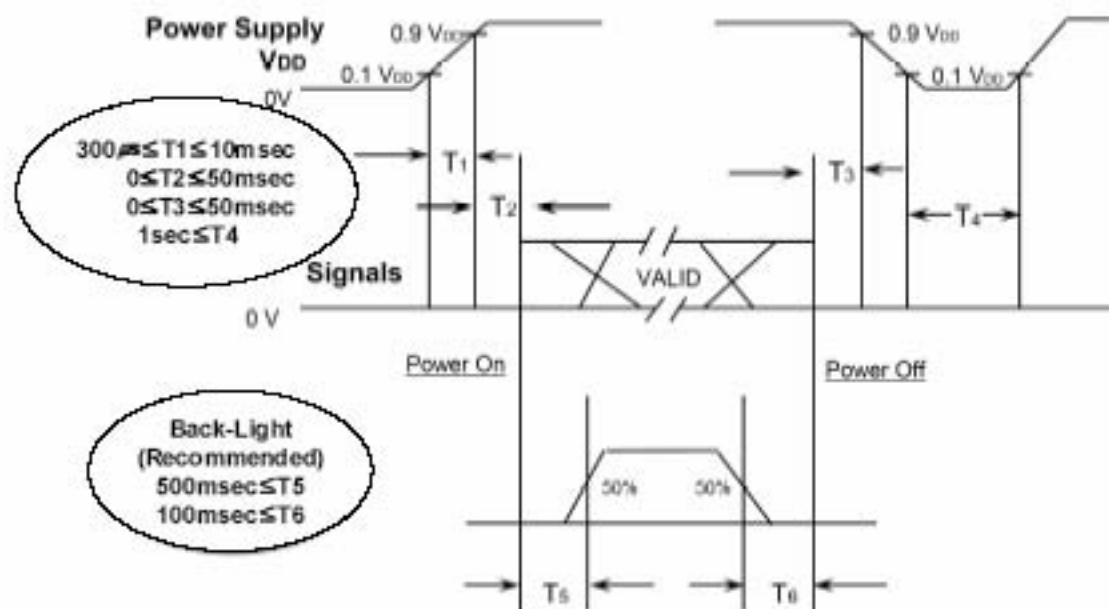

T_1 : V_{DD} rising time from 10% to 90%

T_2 : The time from V_{DD} to valid data at power ON.

T_3 : The time from valid data off to V_{DD} off at power Off.

T_4 : V_{DD} off time for Windows restart

T_5 : The time from valid data to B/L enable at power ON.

T_6 : The time from valid data off to B/L disable at power Off.

- The supply voltage of the external system for the Module input should be the same as the definition of V_{DD} .
- Apply the lamp voltage within the LCD operation range. When the back light turns on before the LCD operation or the LCD turns off before the back light turns off, the display may momentarily show abnormal screen.
- In case of V_{DD} = off level, please keep the level of input signals low or keep a high impedance.
- T_4 should be measured after the Module has been fully discharged between power off and on period.
- Interface signal should not be kept at high impedance when the power is on.

6.4 VDD Power Dip Condition

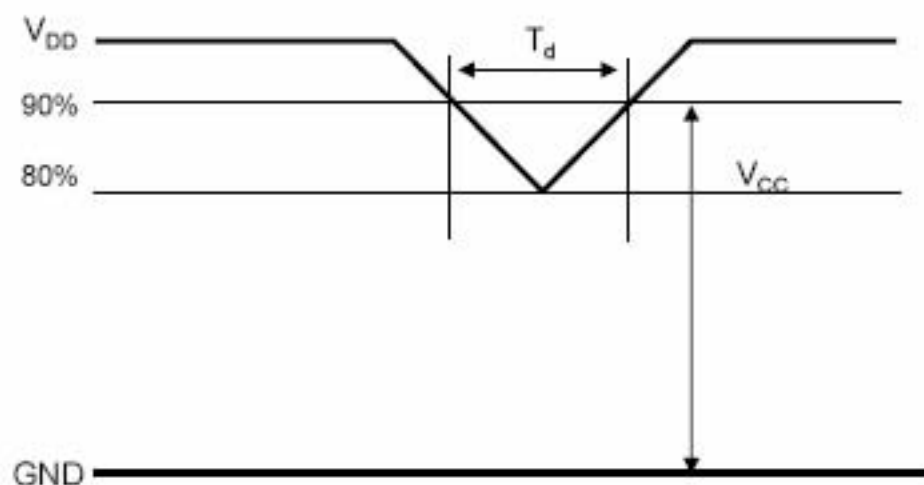

$$4.5V \leq V_{DD} \leq 5.5V$$

$$\text{If } V_{DD}(\text{typ.}) \times 80\% \leq V_{CC} \leq V_{DD}(\text{typ.}) \times 90\%$$

$$\text{Then, } 0 < T_d \leq 20\text{msec}$$

- Note (1) The above conditions are for the glitch of the input voltage.
 (2) For stable operation of an LCD Module power, please follow them.
 i.e., if $\text{typ VDD} \times 80\% \leq V_{cc} \leq \text{typ VDD} \times 90\%$, then T_d should be less than 20ms.

7. Outline Dimension

[Refer to the next page]

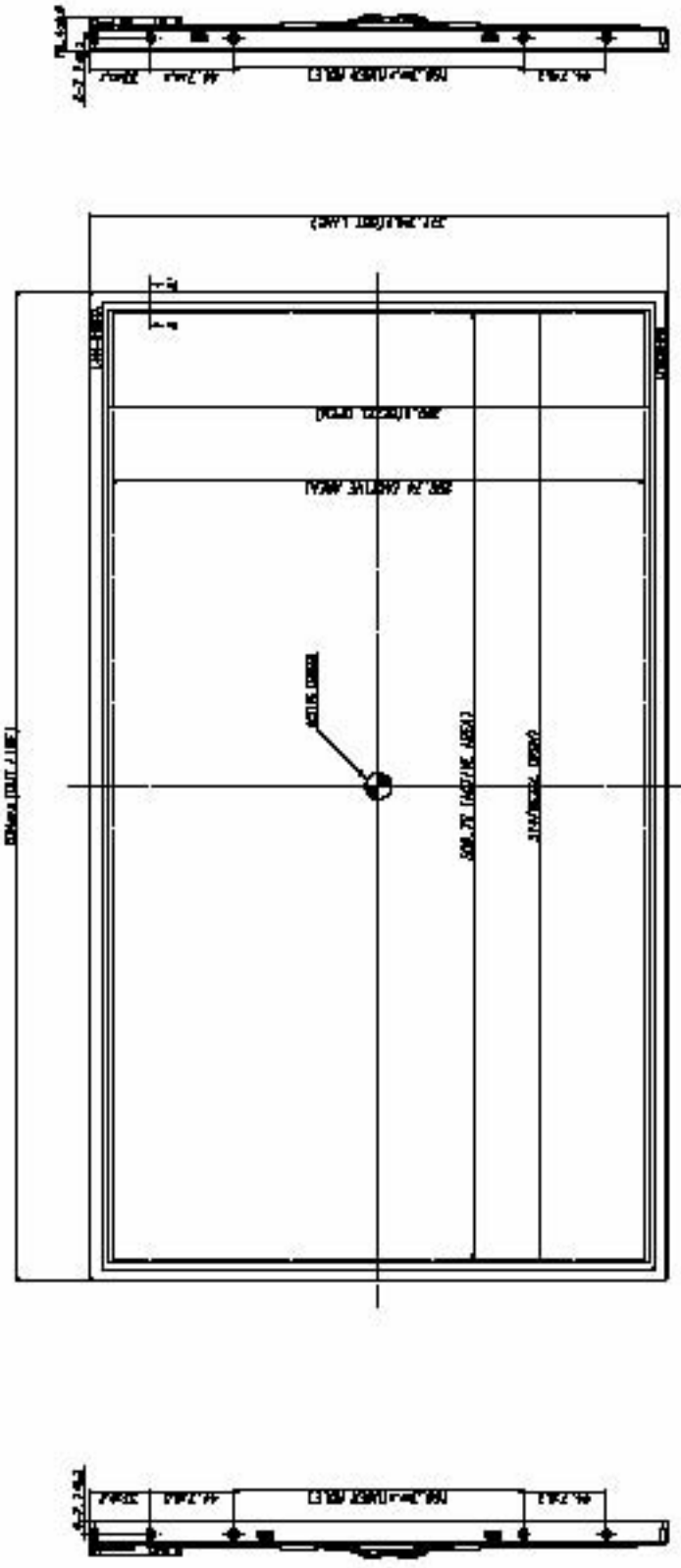

- NOTES
1. DIMENSIONAL LIGHT : 4 COLD CATHODE FLUORESCENT LAMPS
 2. 1/4" CONNECTOR SPEC.
 3. LAMP CONNECTOR SPEC.
 - PART NO. : 15100-1-380-023 OR EQUIVALENT
 - MANFR: DAV
 - MANFR: TERN MO
 4. LAMP MOUNTING BRACKET SPEC : 4" x 4" x 1/8" (WHEN SET UP AT STANDING)
 5. BLACK MATRIX SPEC (When set up at standing)

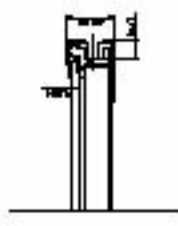
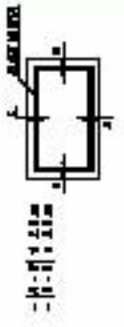

SECTION A-A' (2:1)

PRELIMINARY

NO.	REV.	DATE	BY	CHKD.	DESCRIPTION
1					ISSUED FOR CONSTRUCTION
2					REVISION
3					REVISION
4					REVISION
5					REVISION
6					REVISION
7					REVISION
8					REVISION
9					REVISION
10					REVISION

8. Reliability Test

Test Items	Conditions	Time/Cycle	Sample	
HTOL*	50°C , Bias	500 hrs	12	
LTOL*	0°C , Bias	250 hrs	8	
THB**	40°C / 95% , Bias	500 hrs	4	
HTS***	70°C , No Bias	500 hrs	4	
LTS***	-20°C , No Bias	500 hrs	4	
Thermal Cycle	-20°C/30min ~ +60°C/30min , No bias	200 cycle	8	
Shock (Non-operating)	50G , 11msec Sine wave , ± x/y/z axis	1 time/axis	3	
Vibration (Non-operating)	1.5G , 5~200 Hz x/y/z axis , sweep rate : 10 min	30min/axis	3	
ESD	Non-Operating	CDM : 150pF, 330Ω, 9point, 3 times/point	± 10kV	3
	Operating	Contact : 150pF, 330Ω, 100point, once/point	± 8kV	3
		Air(non-contact) : 150pF, 330Ω, 100point, once/point	± 15kV	3
Altitude	Thermal :-10~50℃ , 15000ft(Operating), 40000ft(Non-operating)	8Hr	3	
	Normal :45℃ , 15000ft	10Hr	3	

[Result Evaluation Criteria]

Under the display quality test conditions with normal operation state, these should be no change which may affect practical display functions.

* HTOL/ LTOL : High/Low Temperature Operating Life

** THB : Temperature Humidity Bias

*** HTS/LTS : High/Low Temperature Storage

9. PACKING

9.1 CARTON

(1) Packing Form

EPS-Cushion Pad

(2) Packing Method

a. Without Inverter

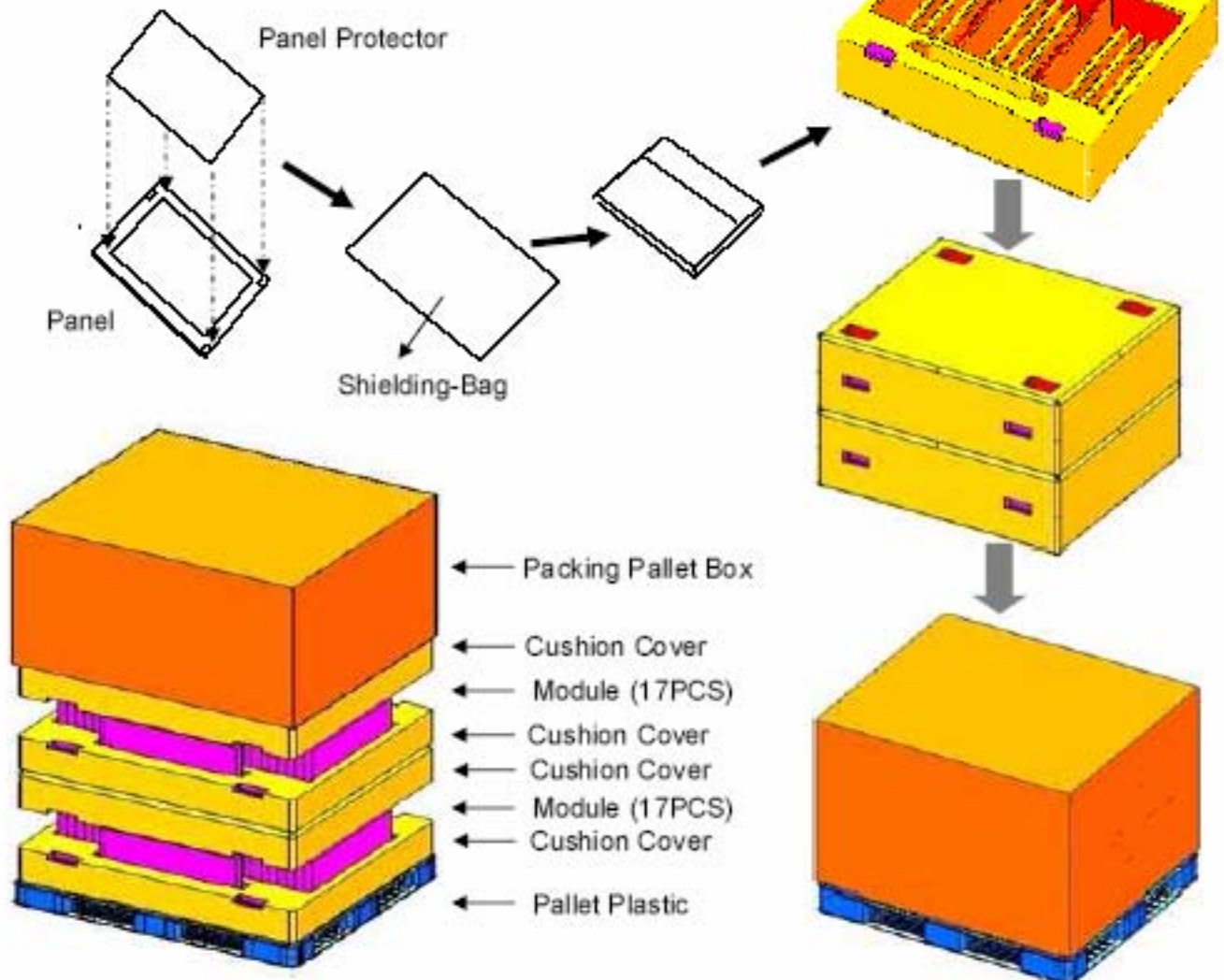

NOTE

1) TOTAL : Approx. 102.0Kg \pm 5%

2) Cushion Material : EPS

3) Cushion Size : 1,120(W) x 955(D) x 216(H)

4) Packing Pallet Box Material : DW4

5) Packing Pallet Box Size : 1,145(W) x 980(D) x 875(H)

(2) Packing Specification

ITEM	Specification	Remark
LCD Packing	Packing-Pallet Box	1. Panel : 34 PCS (17 PCS x 2 Stair = 34 PCS) 2. Cushion Cover : 4 EA 3. Packing Pallet Box : 1 EA
Pallet	1Box/Pallet	1. Pallet Plastic : 1ea 2. Pallet Plastic Size : W1150 x L985 x H125
Packing Direction	Vertical	-

10. MARKING & OTHERS

A nameplate bearing followed by is affixed to a shipped product at the specified location on each product.

(1) Parts number : LTM230HT01

(2) Revision: Three letters

(3) Lot number : X X X X XXX XX X

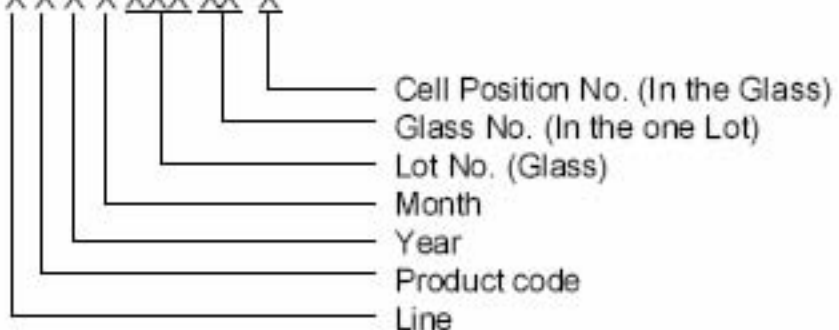

(4) Nameplate Indication

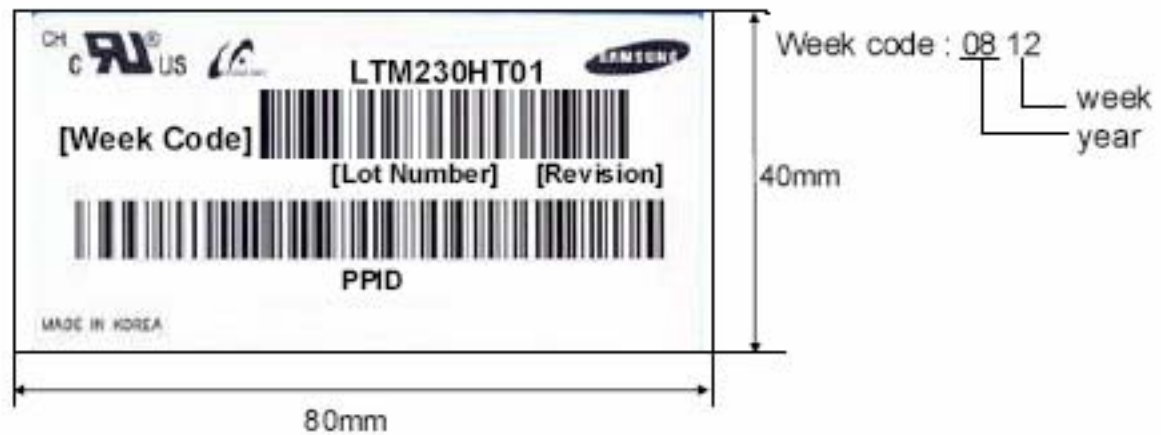

(5) Packing box attach

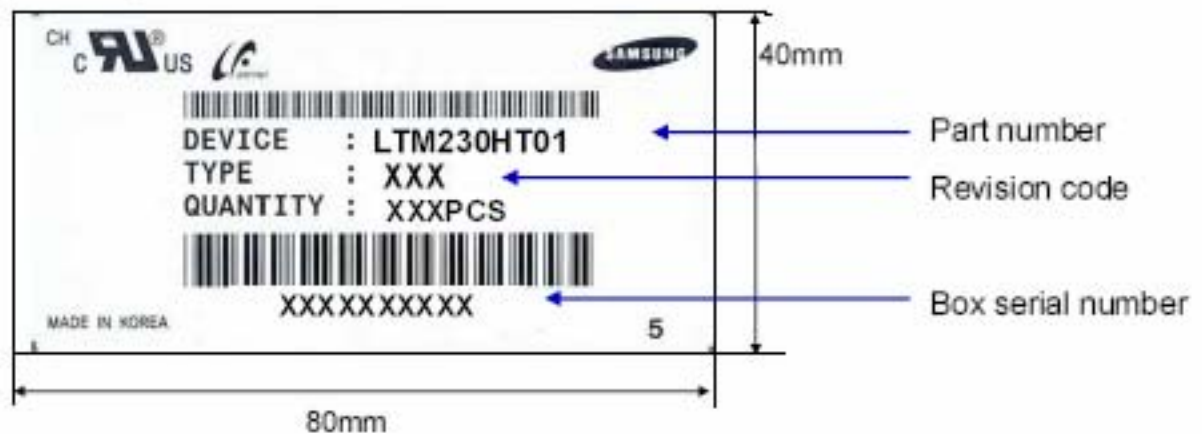

(6) Others

a. After service part

Lamps cannot be replaced because of the narrow bezel structure.

11. General Precautions

11.1 Handling

- (a) When the module is assembled, it should be attached to the system firmly using all mounting holes. Be careful not to twist and bend the module.
- (b) Because the inverter uses high voltages, it should be disconnected from power source before it is assembled or disassembled.
- (c) Refrain from strong mechanical shock and / or any force to the module. In addition to damage, it may cause improper operation or damage to the module and CCFT back light.
- (d) Note that polarizer films are very fragile and could be damaged easily. Do not press or scratch the surface harder than a HB pencil lead.
- (e) Wipe off water droplets or oil immediately. If you leave the droplets for a long time, staining or discoloration may occur.
- (f) If the surface of the polarizer is dirty, clean it using absorbent cotton or soft cloth.
- (g) Desirable cleaners are water, IPA (Isopropyl Alcohol) or Hexane. Do not use Ketone type materials (ex. Acetone), Ethyl alcohol, Toluene, Ethyl acid or Methyl chloride. It might cause permanent damage to the polarizer due to chemical reaction.
- (h) If the liquid crystal material leaks from the panel, it should be kept away from the eyes or mouth. In case of contact with hands, legs or clothes, it must be washed away with soap thoroughly.
- (i) Protect the Module from static, or the CMOS Gate Array IC would be damaged.
- (j) Use finger-stalls with soft gloves in order to keep display clean during the incoming inspection and assembly process.
- (k) Do not disassemble the Module.
- (l) Do not pull or fold the lamp wire.
- (m) Do not adjust the variable resistor located on the Module.
- (n) Protection film for polarizer on the Module should be slowly peeled off just before use so that the electrostatic charge can be minimized.
- (o) Pins of I/F connector should not be touched directly with bare hands.

11.2 Storage

- (a) Do not leave the Module in high temperature, and high humidity for a long time. It is highly recommended to store the Module with temperature from 0 to 35°C and relative humidity of less than 70%.
- (b) Do not store the TFT-LCD Module in direct sunlight.
- (c) The Module should be stored in a dark place. It is prohibited to apply sunlight or fluorescent light in storing.

11.3 Operation

- (a) Do not connect or disconnect the Module in the "Power On" condition.
- (b) Power supply should always be turned on/off by the item 6.3 "Power on/off sequence"
- (c) Module has high frequency circuits. Sufficient suppression to the electromagnetic interference should be done by system manufacturers. Grounding and shielding methods may be important to minimize the interference.
- (d) The cable between the back light connector and its inverter power supply should be connected directly with a minimized length. A longer cable between the back light and the inverter may cause lower luminance of lamp(CCFT) and may require higher startup voltage(Vs).

11.4 Operation Condition Guide

- (a) The LCD product should be operated under normal conditions.
Normal condition is defined as below;
 - Temperature : 20 ± 15 °C
 - Humidity : 65 ± 20 %
 - Display pattern : continually changing pattern (Not stationary)
- (b) If the product will be used in extreme conditions such as high temperature, humidity, display patterns or operation time etc., It is strongly recommended to contact SEC for Application engineering advice. Otherwise, its reliability and function may not be guaranteed. Extreme conditions are commonly found at Airports, Transit Stations, Banks, Stock market, and Controlling systems.

11.5 Others

- (a) Ultra-violet ray filter is necessary for outdoor operation.
- (b) Avoid condensation of water. It may result in improper operation or disconnection of electrode.
- (c) Do not exceed the absolute maximum rating value. (supply voltage variation, input voltage variation, variation in part contents and environmental temperature, and so on)
Otherwise the Module may be damaged.
- (d) If the Module keeps displaying the same pattern for a long period of time, the image may be " " to the screen.
To avoid image sticking, it is recommended to use a screen saver.
- (e) This Module has its circuitry PCB's on the rear side and should be handled carefully in order not to be stressed.
- (f) Please contact SEC in advance when you display the same pattern for a long time.

03 Exploded Diagram

3.1. Screw List

Item	Part No.	Description	Qty	Fixed T(kg*cm)	Remark
1	509146306200R	SCREW,P,CROSS,W/WAS,M3*6,Zn-Cc	6	6.5±0.5	I/F Board to Chassis*1 Power Board to Chassis*4
2	509000000700R	BOLT,#4-40x11.8,Ni ROHS	4	3.75±0.25	D-SUB CON*2 DVI CON*2
3	509212608120R	SCREW,F,CROSS,T4*8,Zn,ROHS(5.8~6.2)	3	10±0.5	Hinge to Stand
4	509116610500R	SCREW,P,CROSS,M4*10,BLK-Zn(NYLO K),ROHS	3	12±0.5	Hinge to back-cover

3.2. LCD Exploded drawing (All)

ZONE	REV	DESCRIPTION	DATE	APPROVED
1	A			Steel

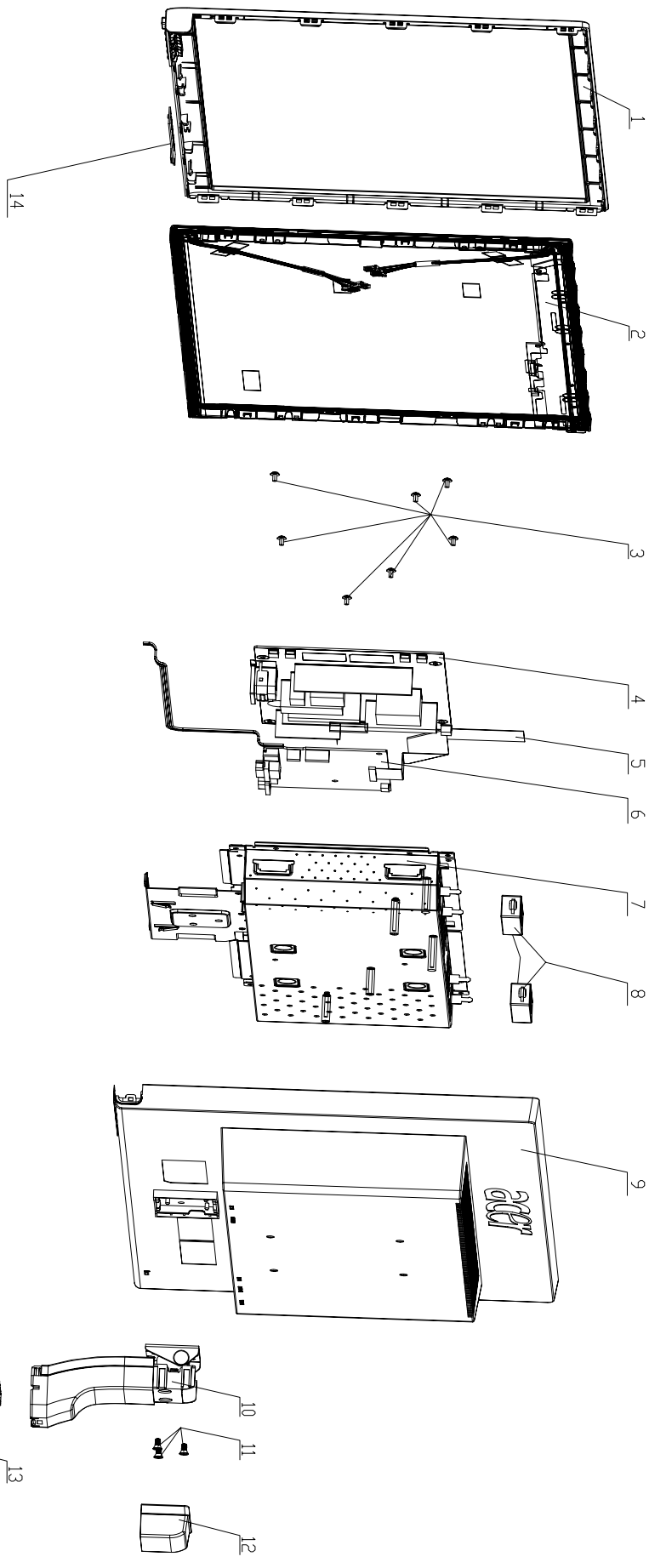

14	7140E23EY00R	KEYPAD	1
13	7140E23EY00R	ASSY BASE LE23EY	1
12	5012E23EY00R	STAND UP LE23EY	1
11	509216608510R	SCRE W/F CROSS M4*6 BLACK/NL RHHS(VN)LUK	3
10	71401E23EY00R	ASSY STAND LE23EY	1
9	71405E23EY00R	ASSY BACK COVER SEC 1A1D LE23EY	1
8		SPEAKER	1
7	70108E23ER03R	ASSY CHASSIS W DVI SPR SEC LE23ER	1
6		I/F BOARD	1
5		L/VDS	1
4		P/T BOARD	1
3	509146306200R	SCRE W/P CRDSS W/VAS M3*6 Zn-Cc	7
2		PANEL	1
1	71403E23EY00R	ASSY FRDNT BEZEL LE23EY	1

ITEM	PART NO	Description	Qty
1	71403E23EY00R	ASSY FRDNT BEZEL LE23EY	1

THESE DIMENSIONS ARE IN MILLIMETERS DIMENSIONS ARE IN MILLIMETERS DECIMALS ANGLES .XX ° XX	
MODEL NO LE23EY SIGNATURE BRAUN, Smit Xu CHK. Schmitz ISSUED SORT 04-09/09	TITLE ASSY LE23EY DATE 04-09/09 PART NO A0 SCALE: 1:1 DWG NO.

ZONE	REV	DESCRIPTION	DATE	APPROVED

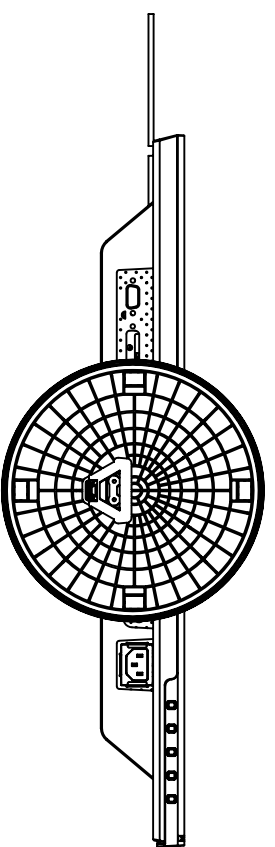
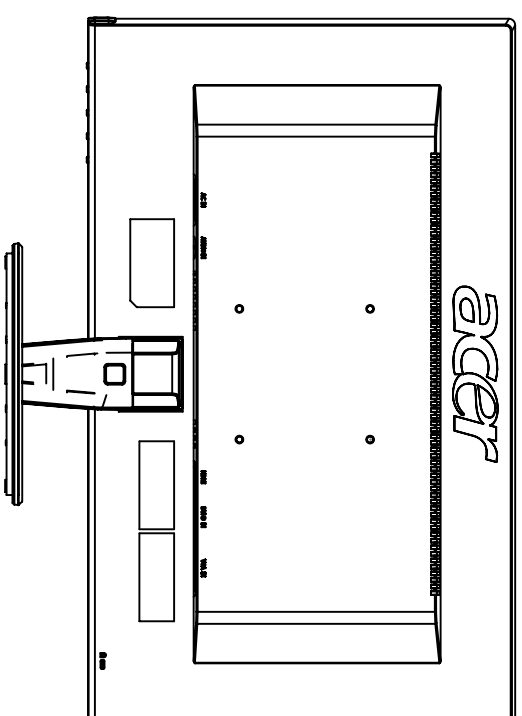
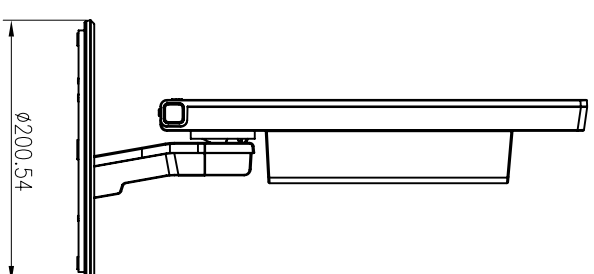
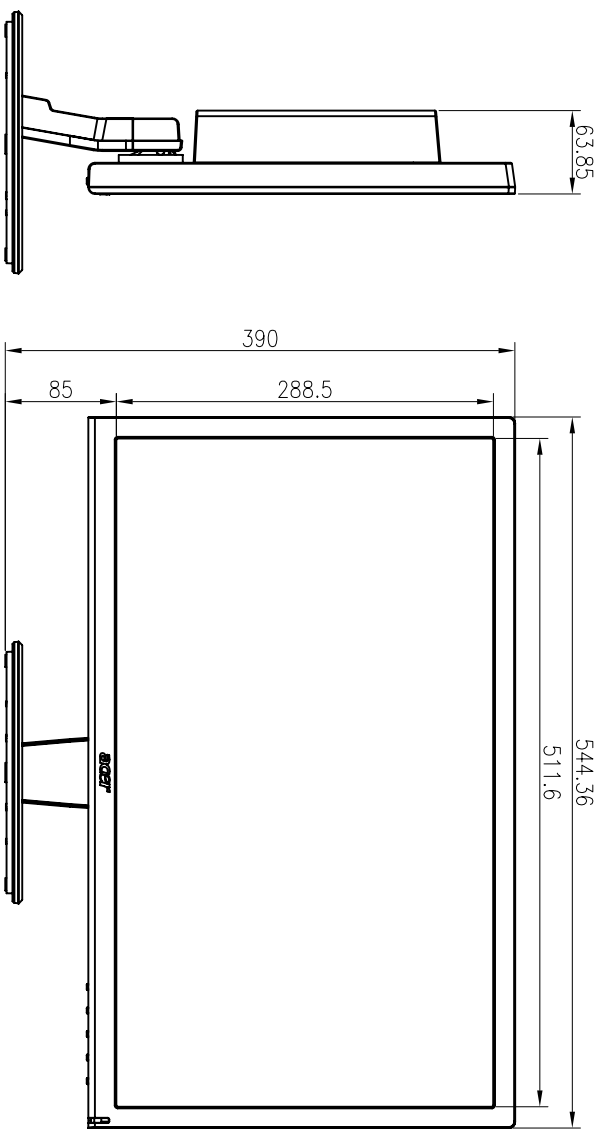
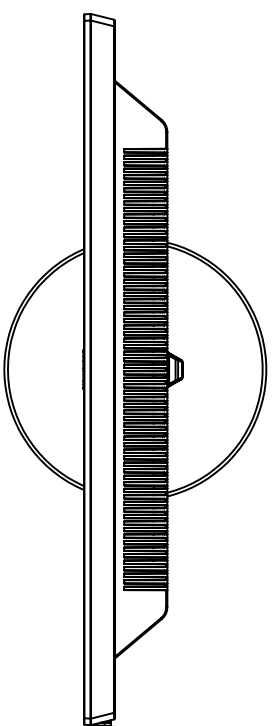

UNLESS OTHERWISE SPECIFIED DIMENSIONS ARE IN MILLIMETERS DECIMALS IN ANGLES		MODEL NO.	FDXC0NN CORP. (INNDLUX)	
X = .	X = .	SIGNATURE	DATE	TITLE
XX = .	XX = .	DRAWN George	11/1/10	P236h SIX VIEW
MATL.		CHK.		PART NO.
FINISH		ISSUED.		SCALE: 1:1
SI - METRIC				DWG NO.
THIRD ANGLE PROJECTION				SHEET 1/2
				REV. 00

04 Troubleshooting

1 . No Power & Power LED Off

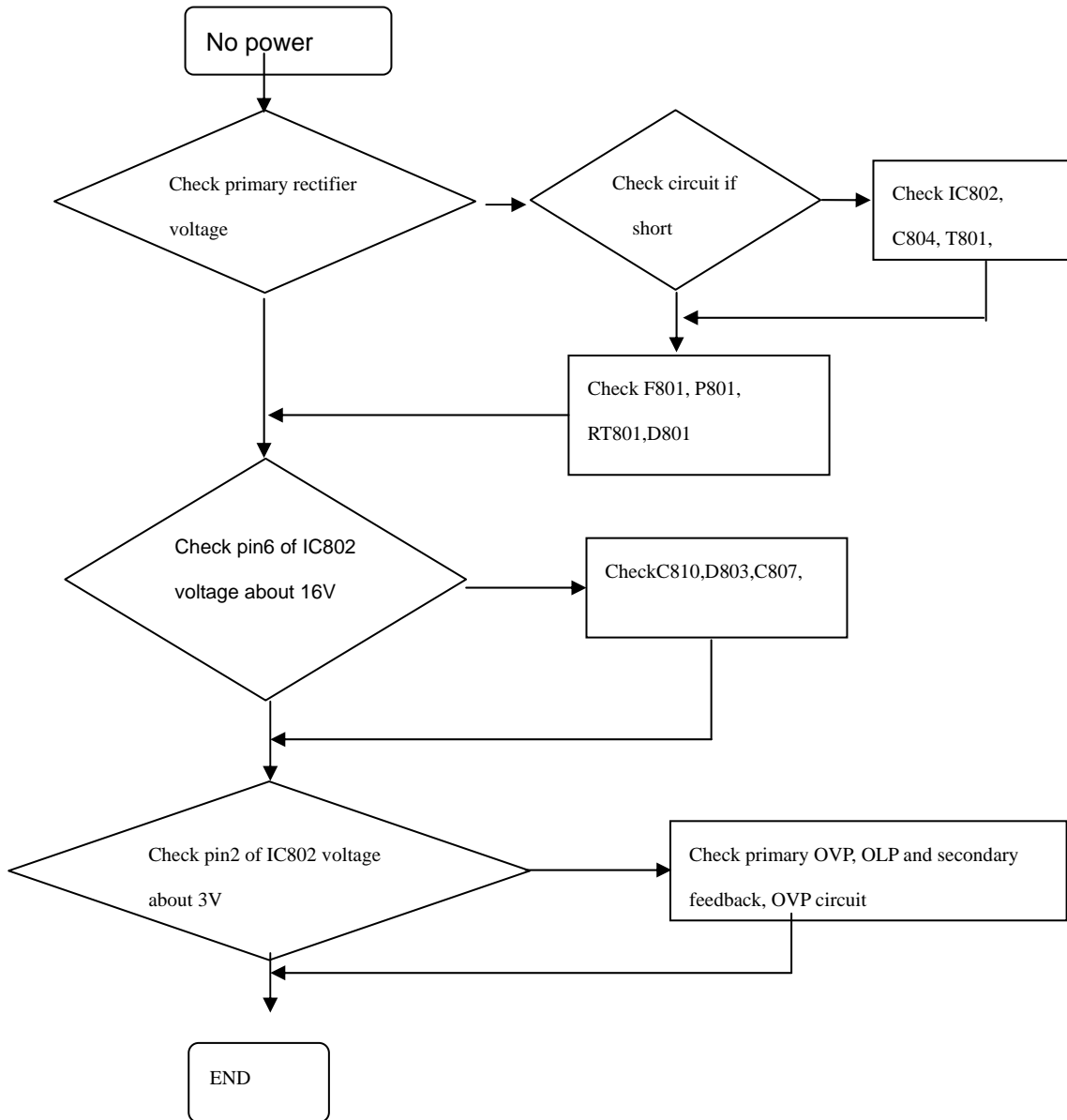

2 . DC output voltage is unstable

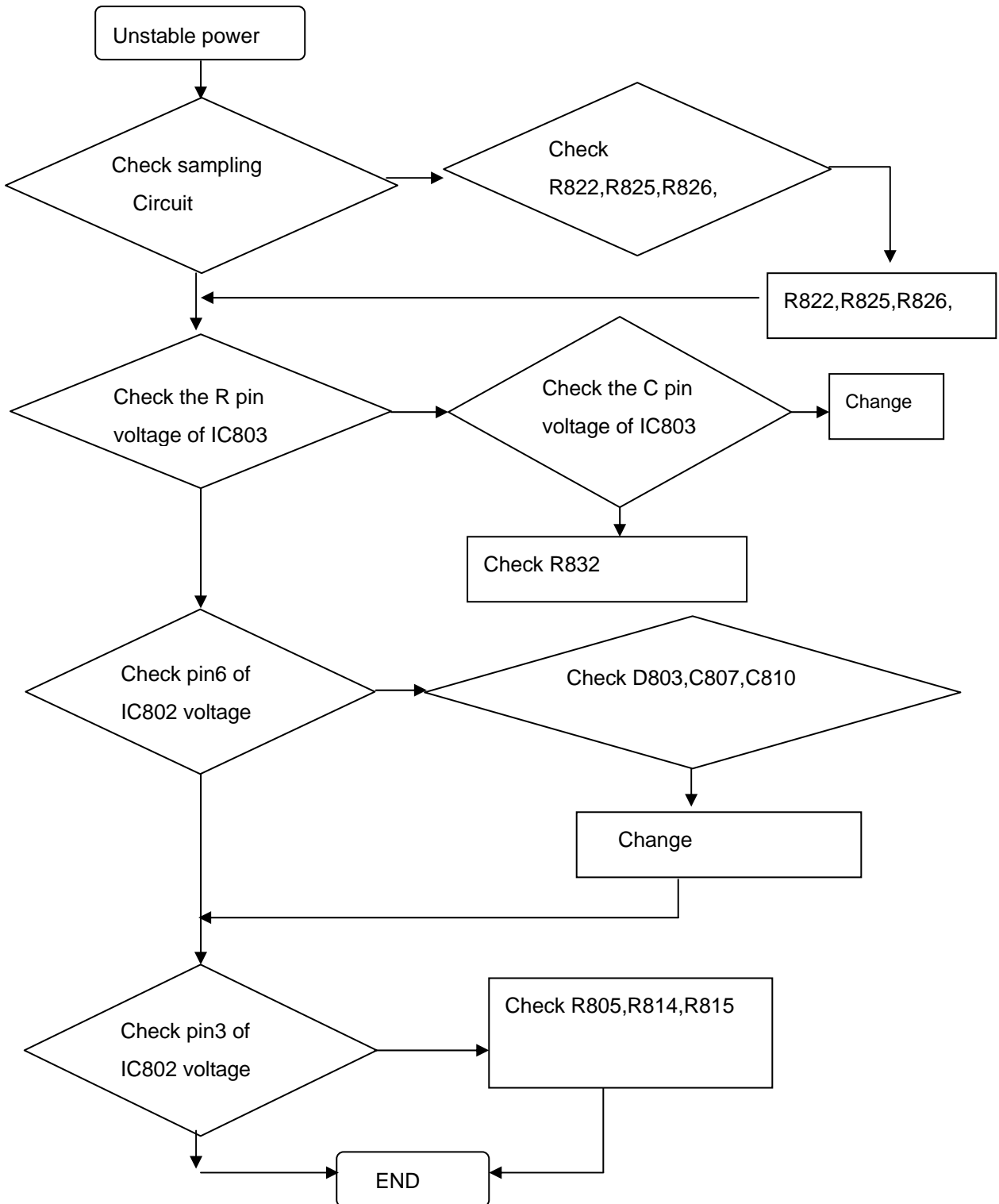

3 . Backlight can't be turned on



4. Black screen

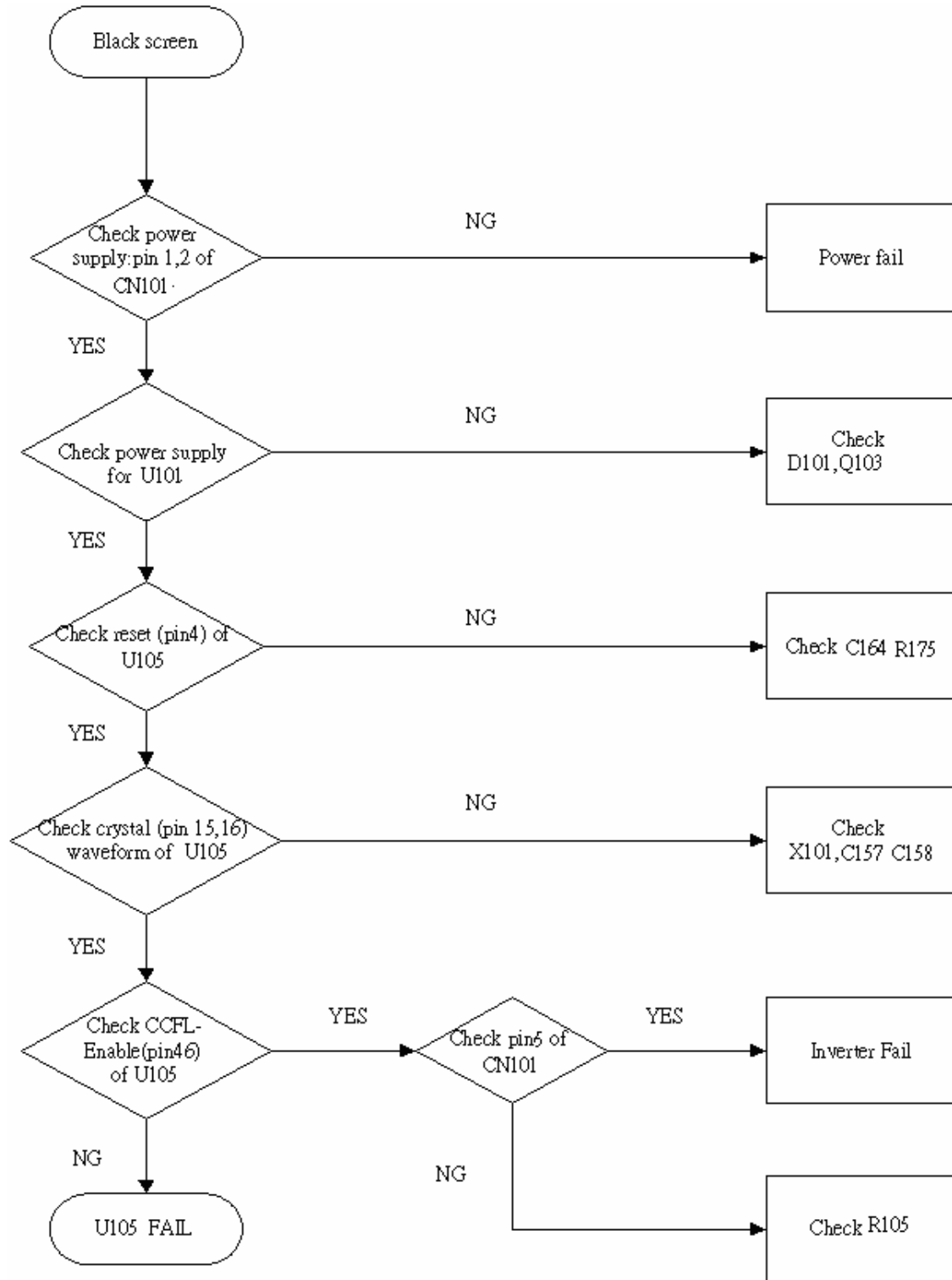

5. White Screen

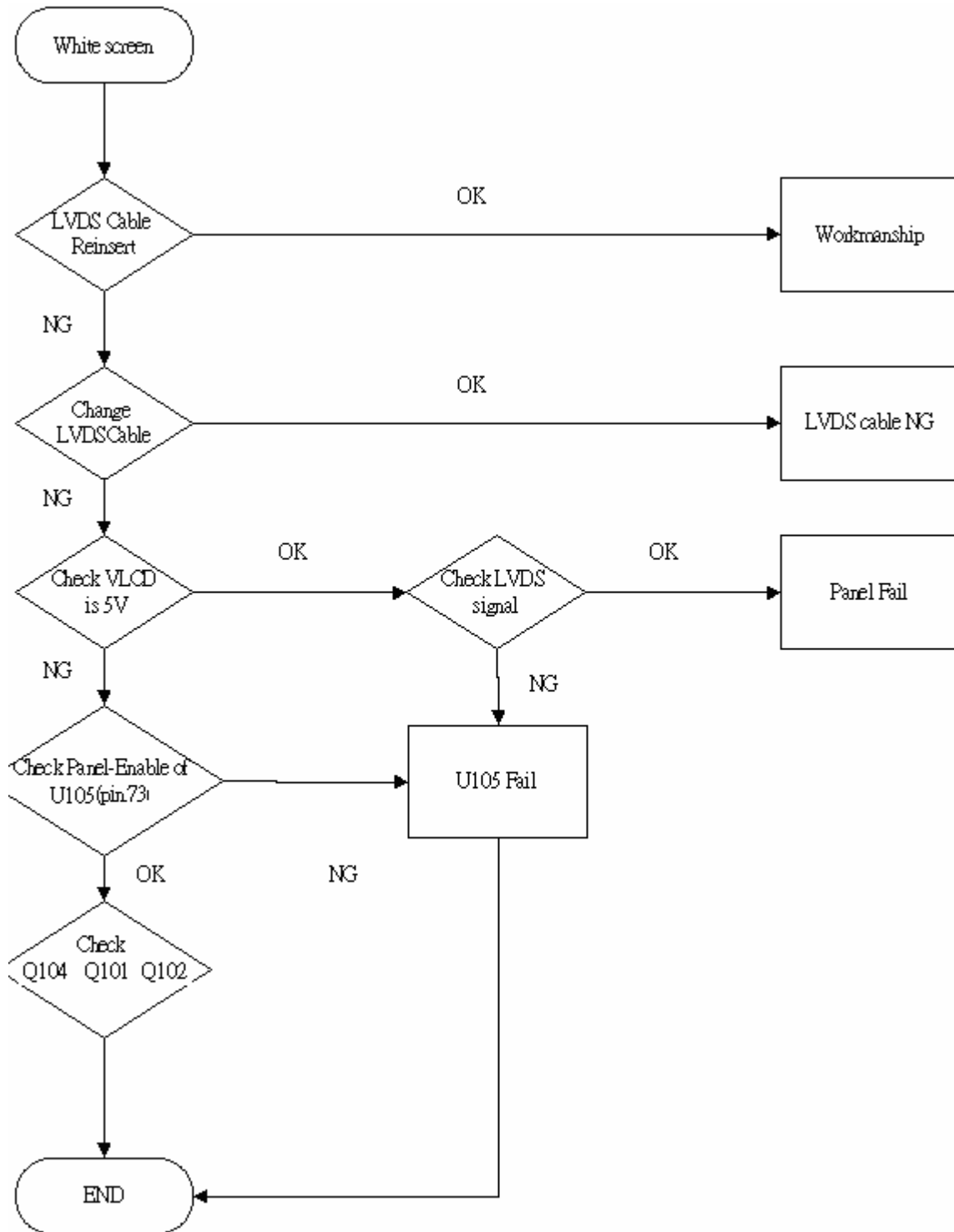



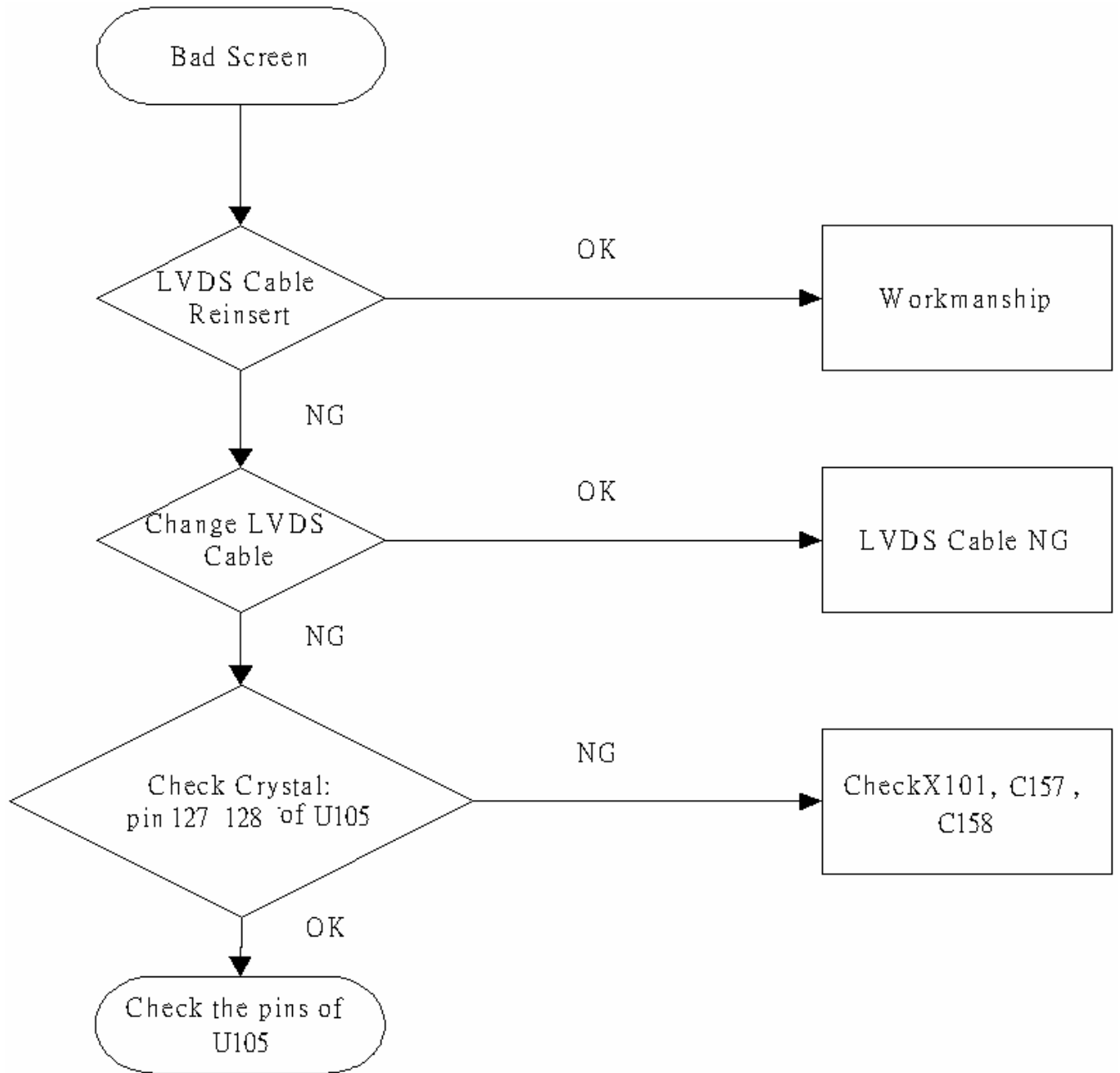

6. Bad Screen



05 Spare parts List

PARTNAME	ACER PART NO.	OEM PART NO	DESCRIPTION	8231EY81A120R
				CN
MAIN BOARD	55.LNW0J.001	795611300800R	PCBA,IF/B(A09,EMEA,W/SPK),LE23ER-812 ROH	
POWER BOARD	55.LNW0J.002	795611400800R	PCBA,PI/B,W/SPK,LE23ER-812 ROHS	
KEYPAD BOARD	55.LNX0J.001	795691500800R	PCBA,KEYPAD/B,LE23EY-812 ROHS	
LVDS CABLE	50.LK60J.002	430303003160R	HRN LVDS FFC 30P 220mm W/CORE & TASTE	
CABLE	50.LNW0J.001	430301001890R	HRN ASS'Y 2x5P to 8P 320mm UL1571#28 Con	
CABLE	27.LBN0J.001	453070801190R	PWRCORD 16A/250V BLK 6FT VDE/KTL H05VV-F	
CABLE	50.L63VF.003	453030300120R	CABLE AUDIO 1P 6FT BLACK/GREEN CP03B06P0	
CABLE	50.LBQ0J.001	453010100380R	CABLE,D-SUB 15P MALE 6FT BLACK/BLUE, ROH	
CABLE	50.LA10J.003	453030300370R	CABLE,DVI-D 18+1P MALE 6FT BLACK , ROHS	
STAND	60.LNX0J.001	71401E23EY00R	ASSY STAND LE23EY	
CHASSIS	60.LNW0J.004	70108E23ER03R	ASSY,CHASSIS,W DVI SPK,SEC,LE23ER	
FRONT BEZEL	60.LNX0J.002	71403E23EY00R	ASSY FRONT BEZEL LE23EY	

COVER	60.LNX0J.003	71405E23EY00R	ASSY BACK COVER SEC 1A1D LE23EY	
BASE	60.LNX0J.004	71402E23EY00R	ASSY BASE LE23EY	
STAND UP	42.LNX0J.001	50126E23EY00R	STAND UP LE23EY	
SPEAKER	23.LK60J.001	618100103150R	SPEAKER 1.5W 4Ω 100&120mm R/B/G W/CASE	
PANEL	LK.23006.014	631102230260HA	LCP 23"LTM230HT01-A09(A)(SAMSUNG)HF	

06 Schematics and Layouts

6.1 IF BD Layout

LAYER	SILKSCREEN TOP		
PCB NO :	492A01201300R	REV :	02 DESIGNER: LIU HUA
FILE NAME :	ILIF-232	DATE :	2010.03.01

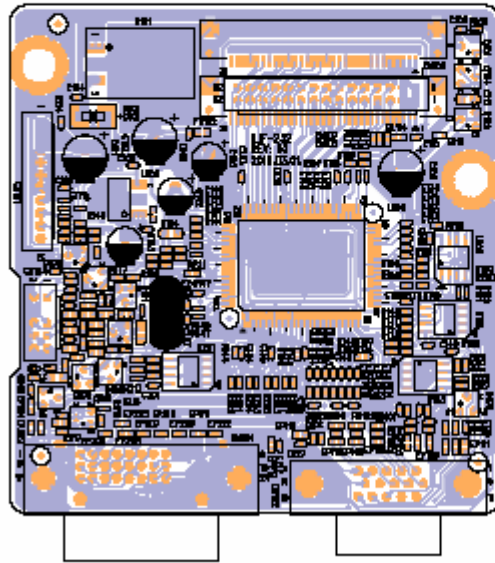

LAYER	SILKSCREEN BOTTOM		
PCB NO :	492A01201300R	REV :	02 DESIGNER: LIU HUA
FILE NAME :	ILIF-232	DATE :	2010.03.01

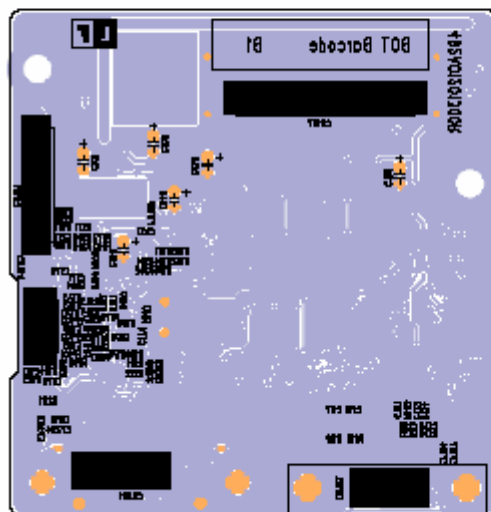

6.2 Power BD Layout

LAYER	SILKSCREEN TOP		
PCB NO :	ILPI-223	REV :	A DESIGNER: Song Wen
FILE NAME :	491AD002140DR	DATE :	2010.03.05

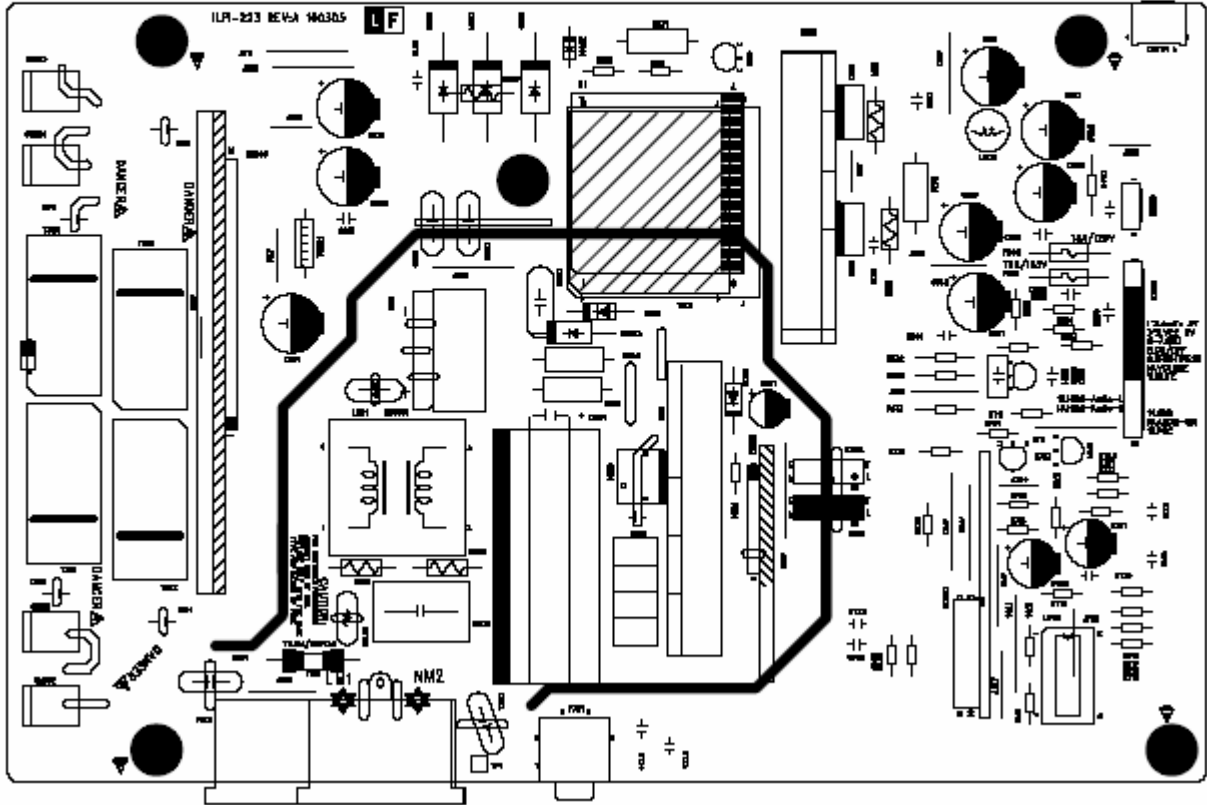

LAYER	SILKSCREEN BOTTOM		
PCB NO :	ILPI-223	REV :	A DESIGNER: Song Wen
FILE NAME :	491AD0021400R	DATE :	2010.03.05

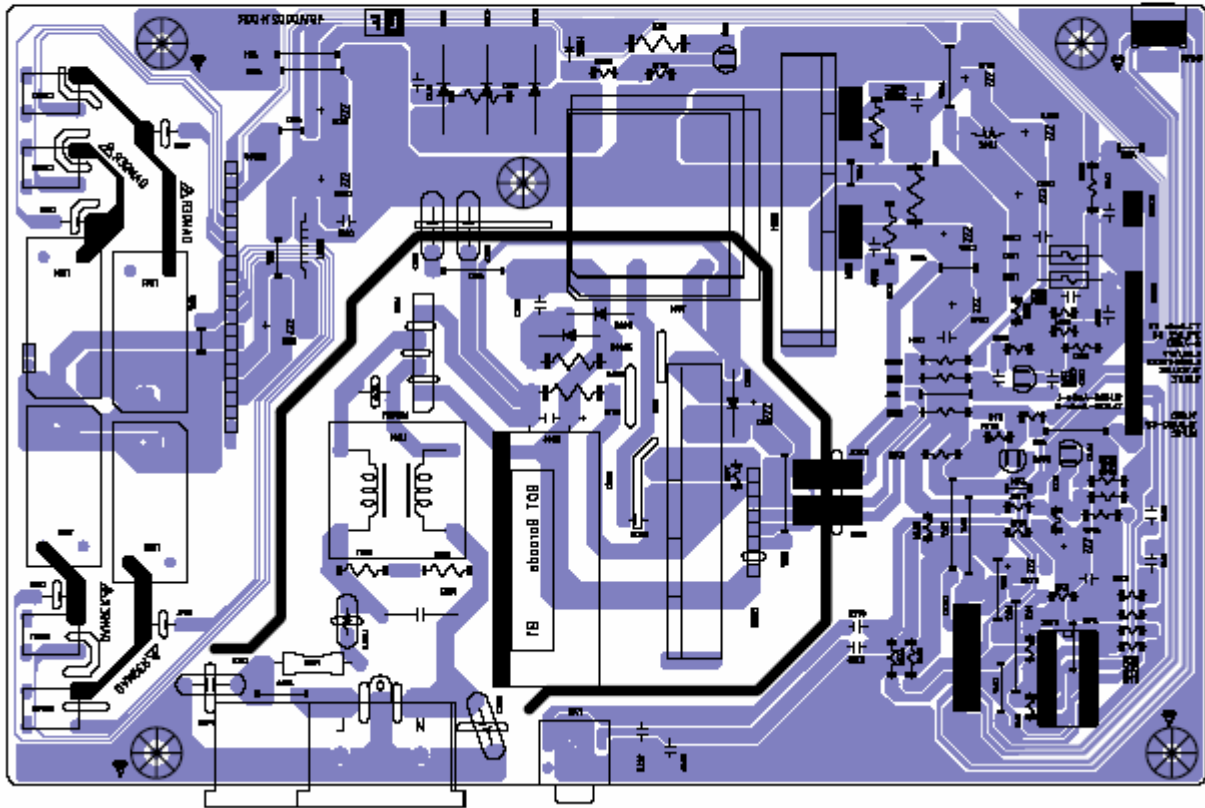

6.3 Keypad BD Layout

LAYER	SILKSCREEN TOP		
PCB NO :	ILK-261	REV :	A-P DESIGNER: Song Wen
FILE NAME :	492A01341500R	DATE :	2010.04.19

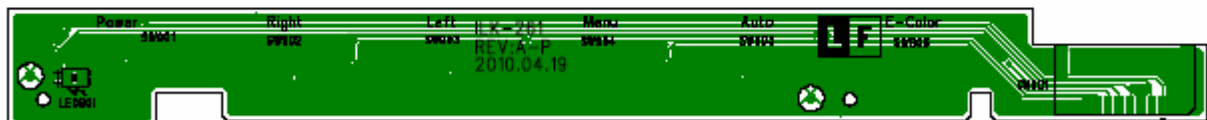

LAYER	SILKSCREEN BOTTOM		
PCB NO :	ILK-261	REV :	A-P DESIGNER: Song Wen
FILE NAME :	492A01341500R	DATE :	2010.04.19

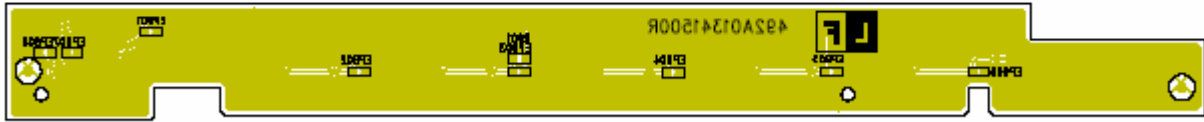

6.4IF BOARD schematics and Power Supply circuit

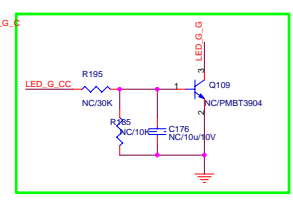
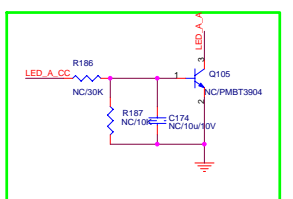
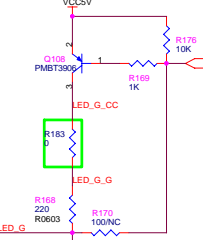
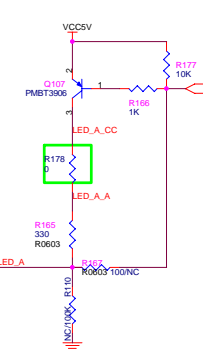
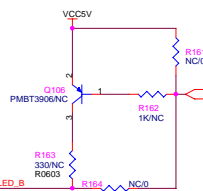
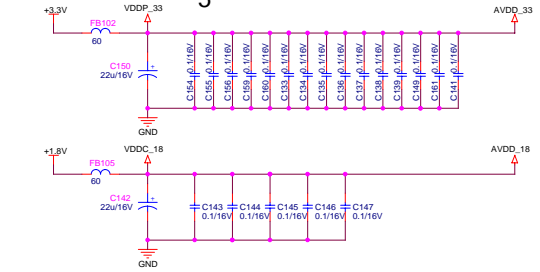
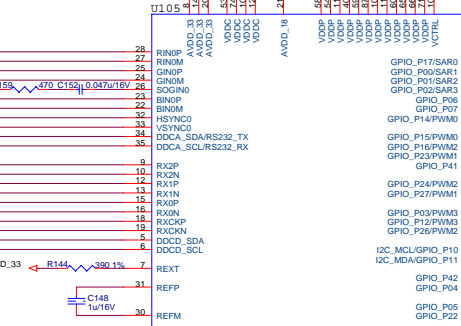
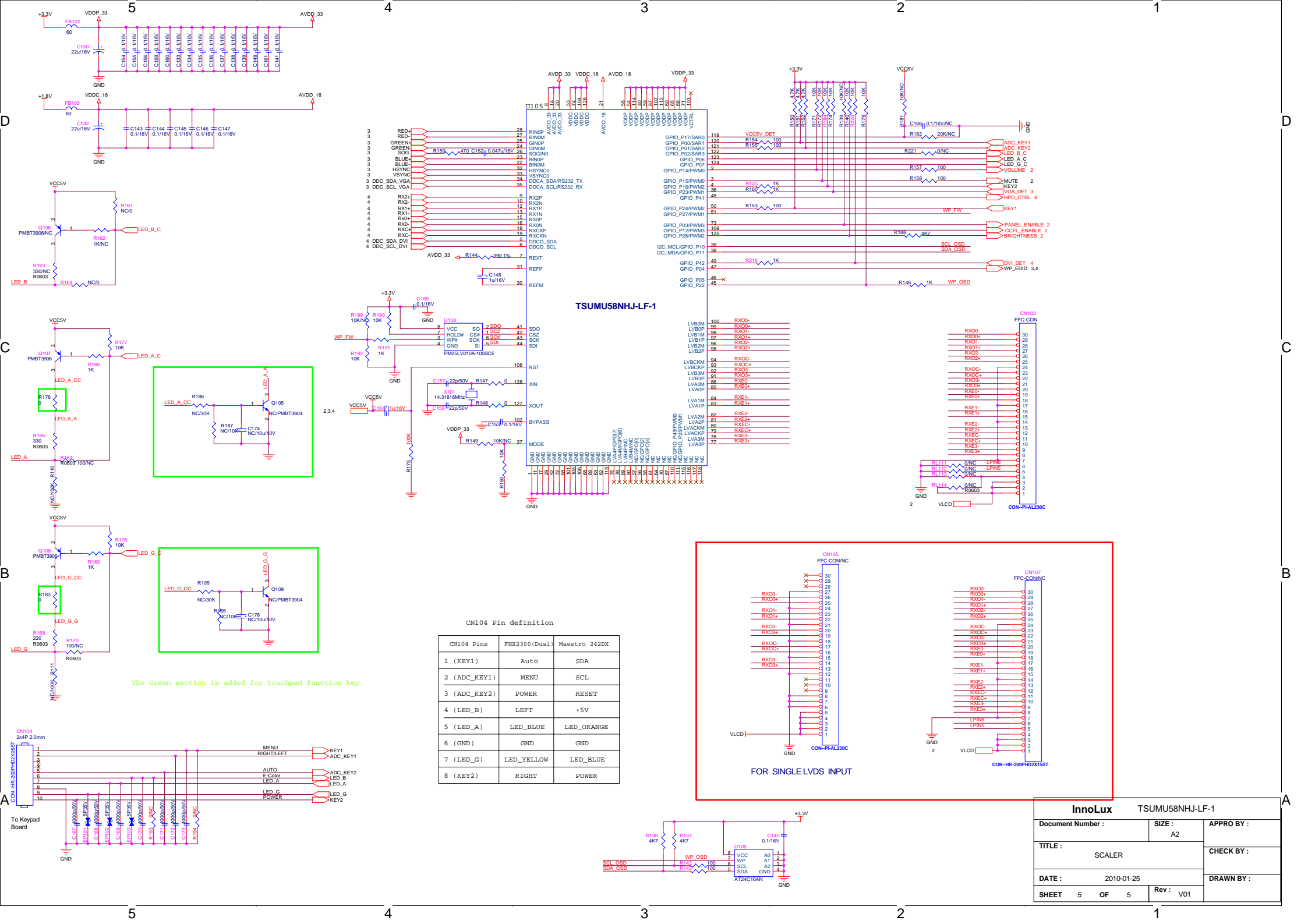

The Green section is added for Touchpad function key

TSUMU58NHJ-LF-1

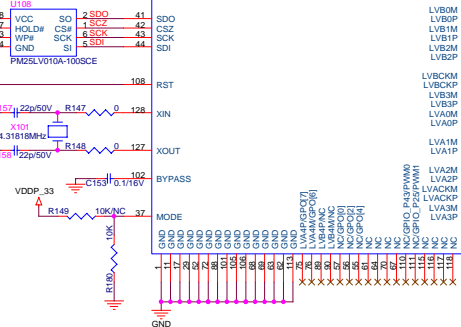

CN104 Pin definition

CN104 Pins	FHX2300(Dual)	Maestro 242DX
1 (KEY1)	Auto	SDA
2 (ADC_KEY1)	MENU	SCL
3 (ADC_KEY2)	POWER	RESET
4 (LED_B)	LEFT	+5V
5 (LED_A)	LED_BLUE	LED_ORANGE
6 (GND)	GND	GND
7 (LED_G)	LED_YELLOW	LED_BLUE
8 (KEY2)	RIGHT	POWER

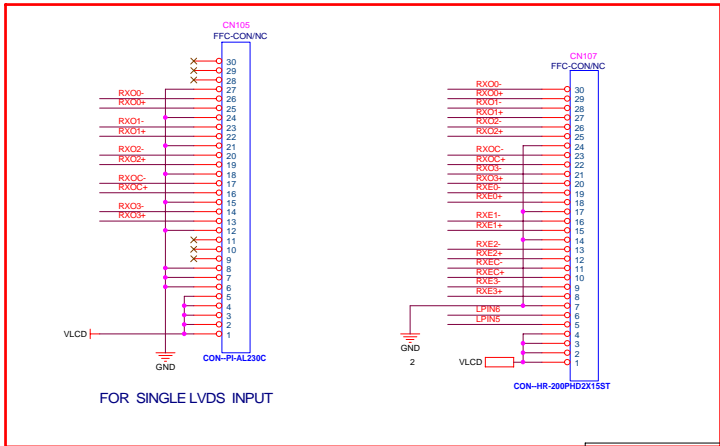

FOR SINGLE LVDS INPUT

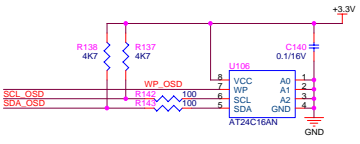
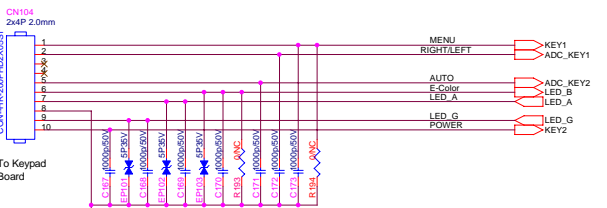

InnoLux		TSUMU58NHJ-LF-1	
Document Number :	SIZE :	APPRO BY :	
	A2		
TITLE :		CHECK BY :	
SCALER			
DATE :	2010-01-25	DRAWN BY :	
SHEET 5	OF 5	Rev :	V01

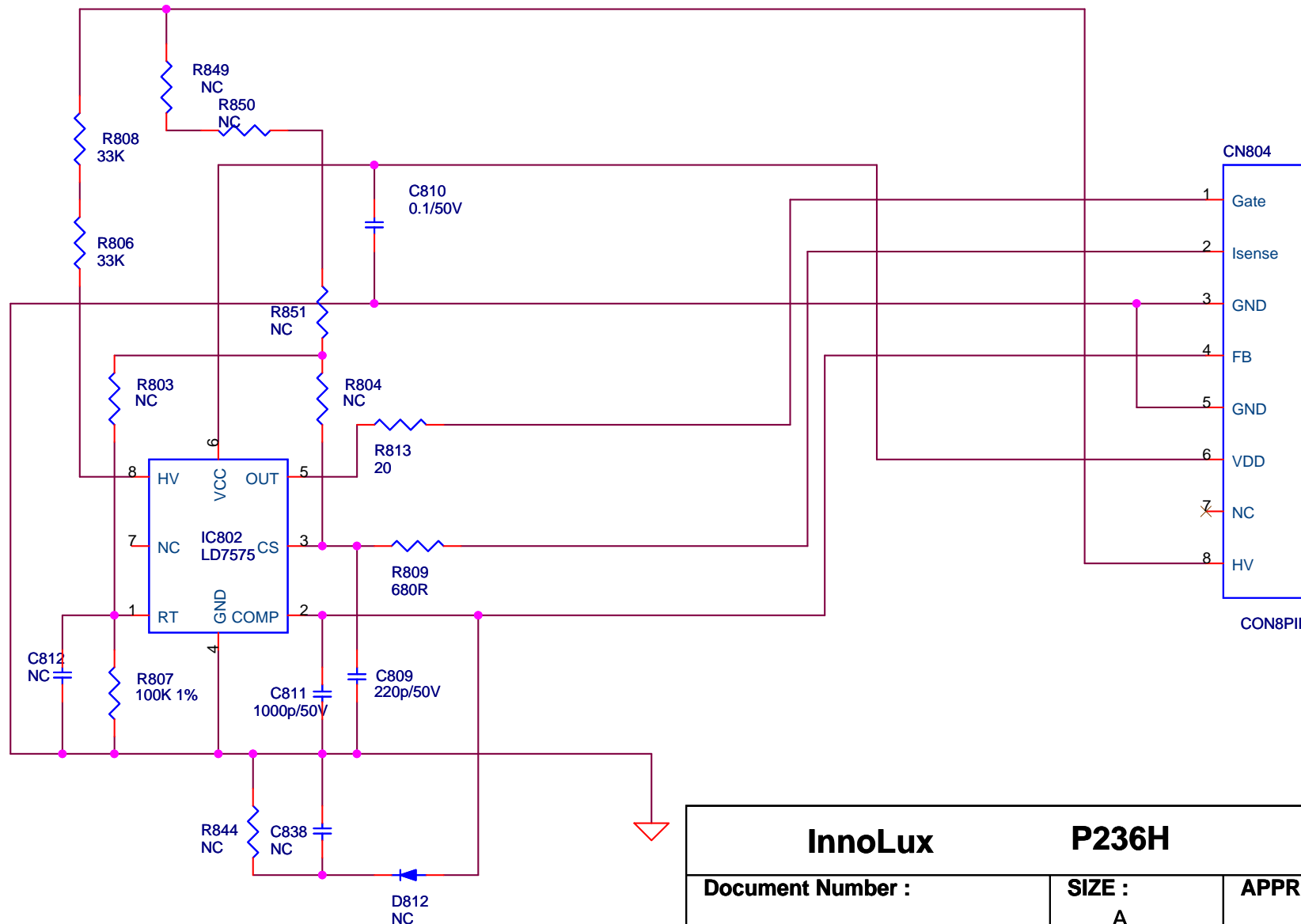

InnoLux		P236H	
Document Number :		SIZE : A	APPRO BY :
TITLE : POWER Control			CHECK BY :
DATE : 2010-01-15		DRAWN BY :	
SHEET 3	OF 6	Rev : V02	

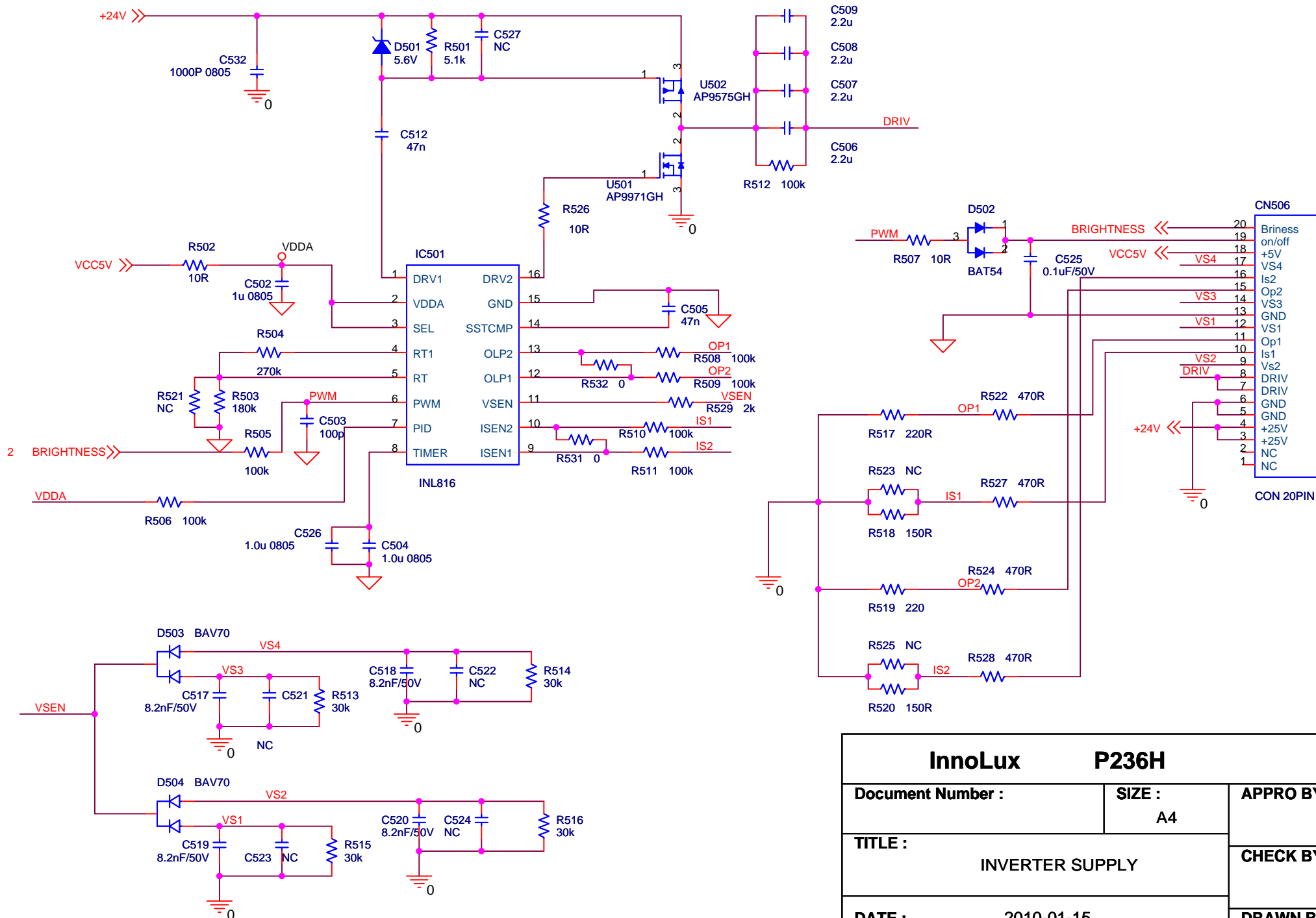

InnoLux P236H		
Document Number :	SIZE : A4	APPRO BY :
TITLE : INVERTER SUPPLY		CHECK BY :
DATE :	2010-01-15	DRAWN BY :
SHEET	4 OF 6	Rev : V01

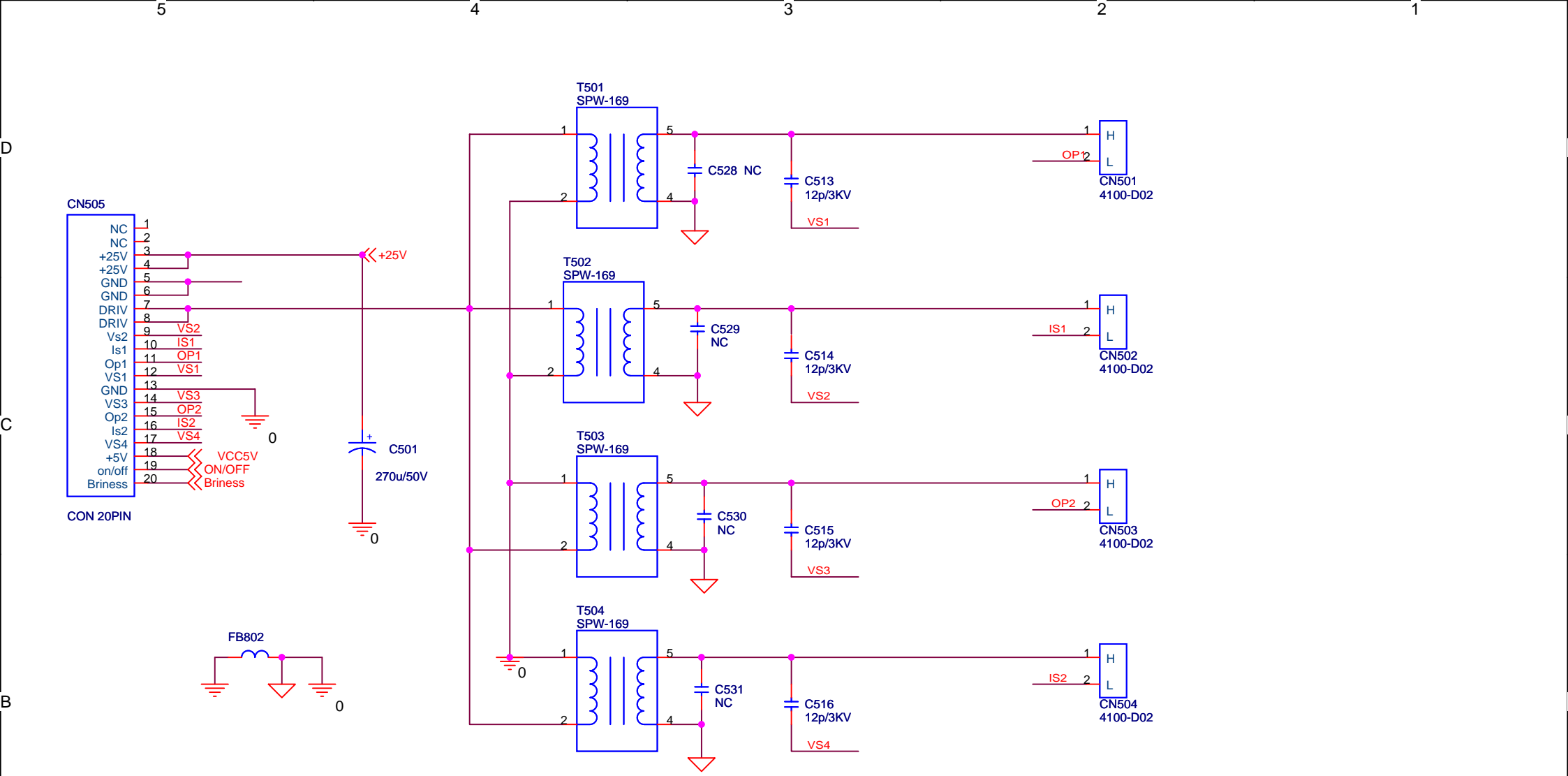

InnoLux		P236H	
Document Number :		SIZE :	APPRO BY :
		A4	
TITLE :			CHECK BY :
INVERTER SUPPLY			
DATE :		DRAWN BY :	
2010-01-15			
SHEET	5	OF	6
		Rev :	V01

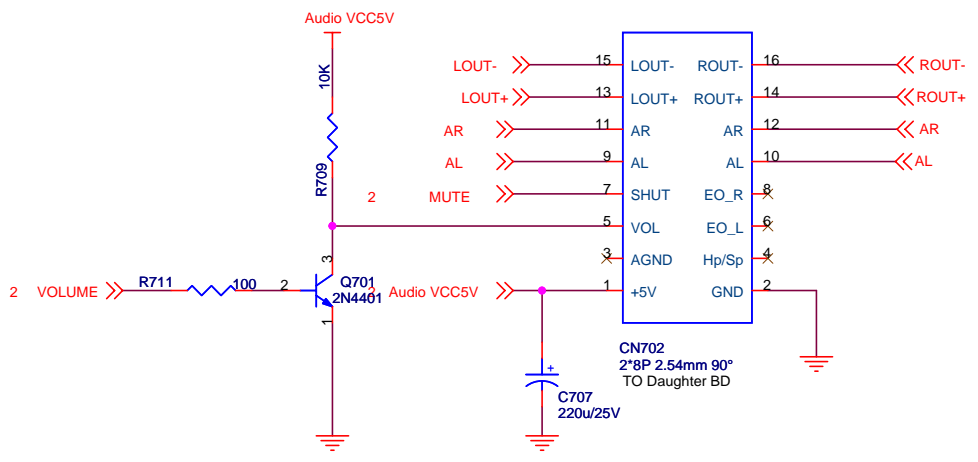
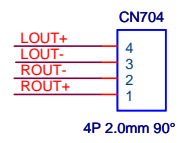
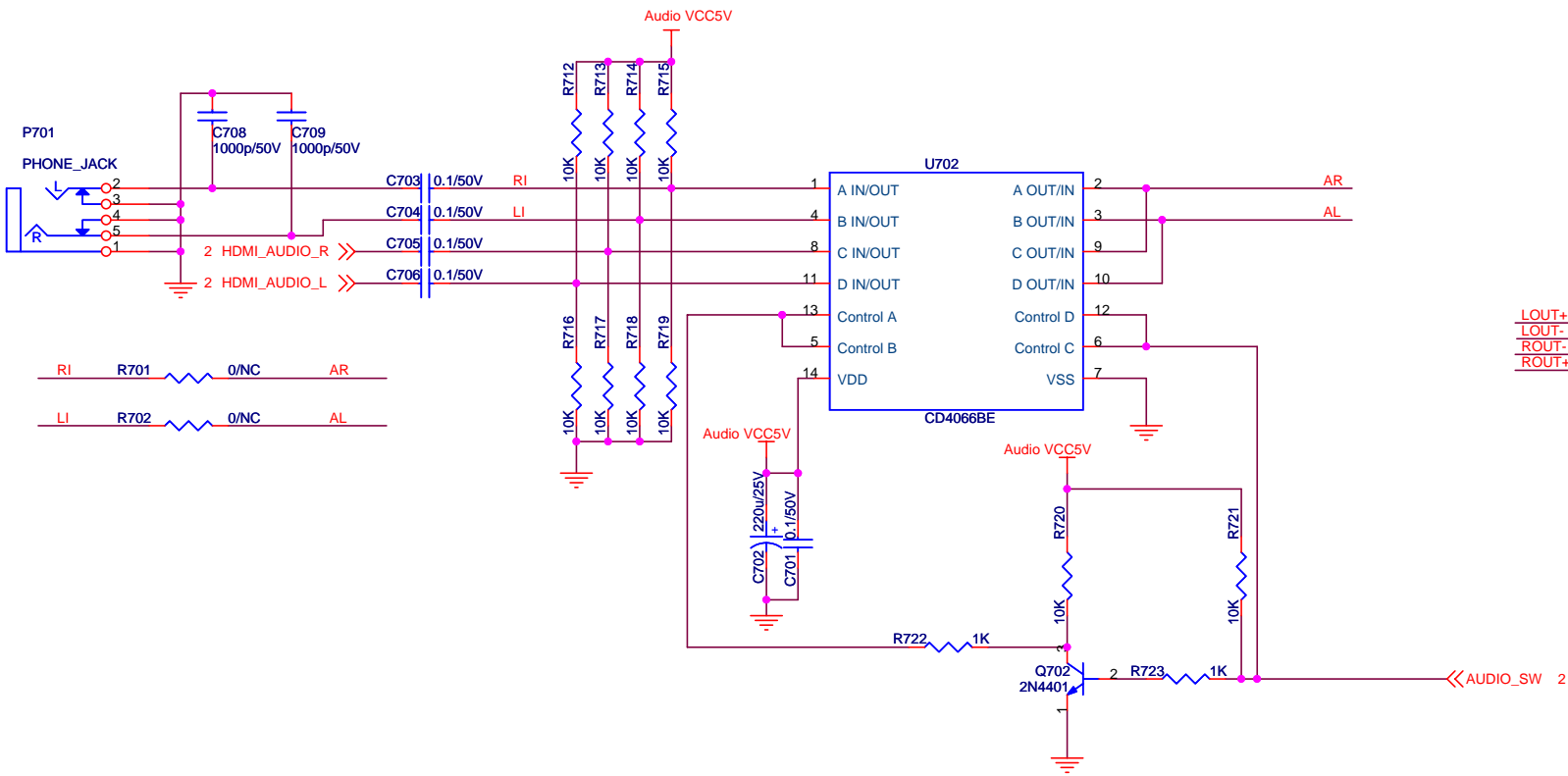

InnoLux		P236H	
Document Number :	SIZE :	APPRO BY :	
	Custom		
TITLE :	Audio Switch		CHECK BY :
DATE :	2010-01-15		DRAWN BY :
SHEET	6	OF	6
		Rev :	V02

07 Assembly and disassembly

S1 Release the base from stand.



S2 Release the stand cover.

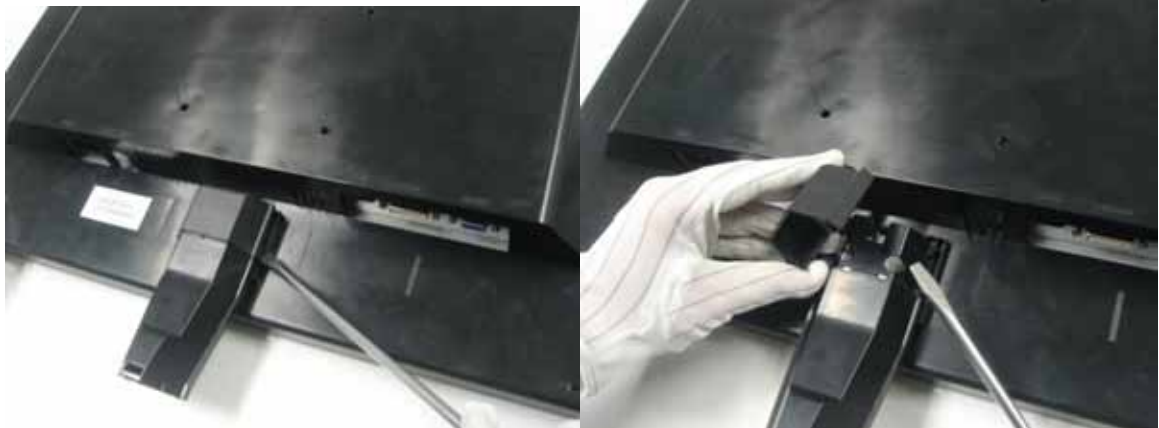

S3 Screw out the 3 screws in stand.



S4 Take off the stand.

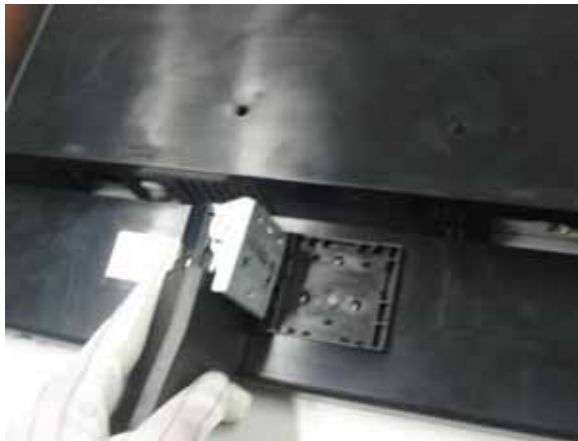

S5 Release the front bezel at 3 sides



S6 Turn over the monitor, release the back-cover.



S7 Release the keypad cable and release the keypad board.



S8 Pull out lamp cables and LVDS cable.



S9 Release the chassis.



S10 Screw out the 4 bolt screws



S11 Release the 6 screws from interface board and power board.



S12 Release the speaker cable.



S13 Take out interface board and power board.



S14 Take out LCD panel.



08 FW & EDID upgrade procedure

1. SOP of PCBA ISP Programming (FW TOOL: INL PN 799999942100R/Acer PN 6K.L46VF.001)

1.1 Operational condition:

Equipment: PC, ISP card, signal cable and power cable.

ESD requirements: antistatic wrists, antistatic gloves(fingers), and connecting cable

Name of ISP program: ISP_Tool_V4.4.2.4

Manufacture of FW IC : PMC/SST/MX

1.2 Operational steps:

1. Connection: connect PC to PCBA with signal cable, and then keep AC and DC in open state.

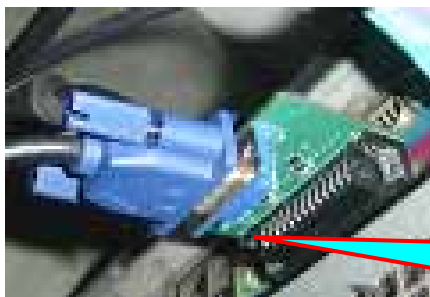

Signal cable



One port of ISP program card is connected to PC



2. Adjust ISP programming

Firstly, double click ISP_Tool_V4.4.2.4 exit and click “Connect ” button; The ISP tool will connect to monitor automatically, and it will show flash IC type automatically

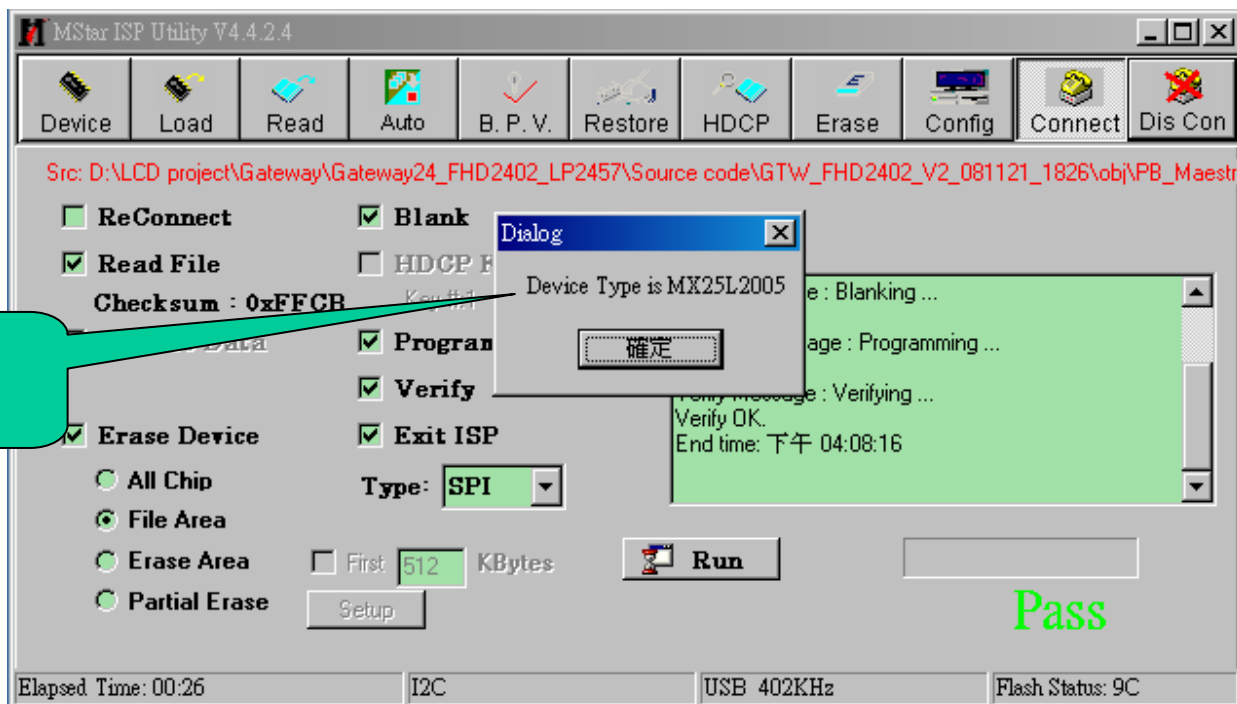

Secondly , download FW software: first select “READ”, and then load FW software in Rooter (Fig.2).

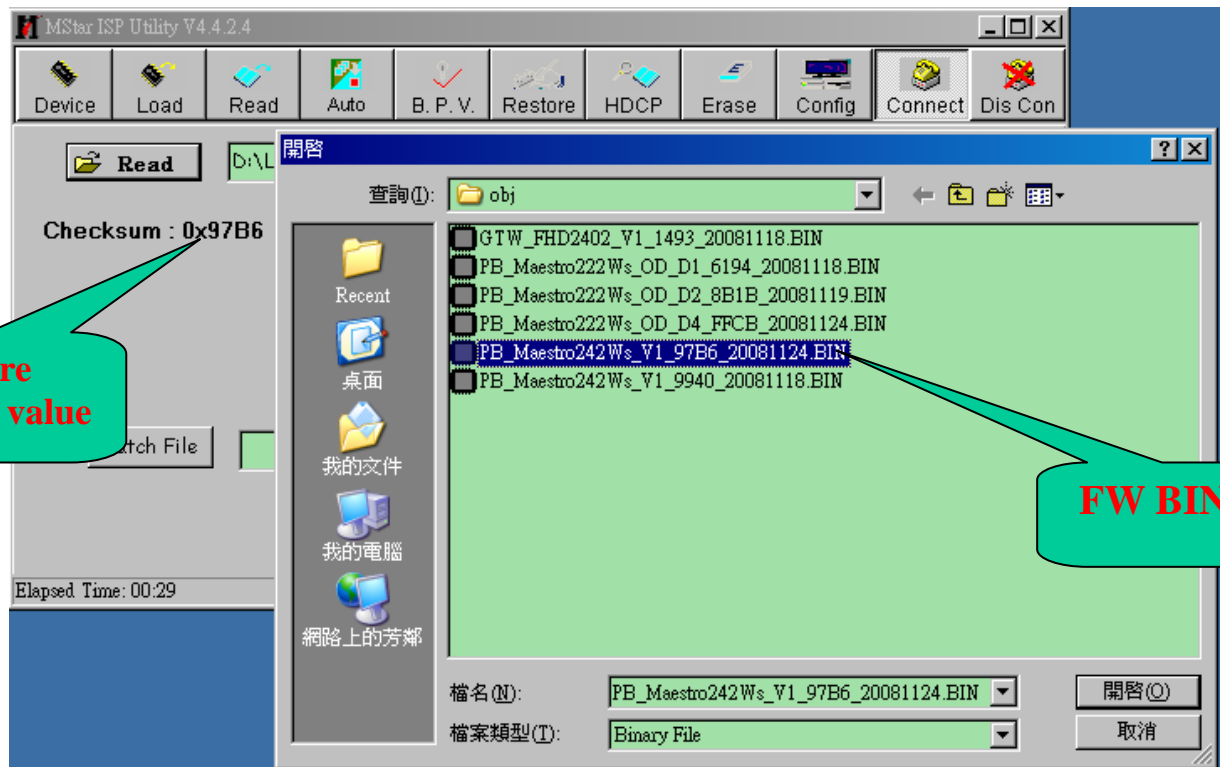

Thirdly, select “AUTO”, and keep its default value. Click “RUN” for beginning programming. There will be prompting if programming is OK.

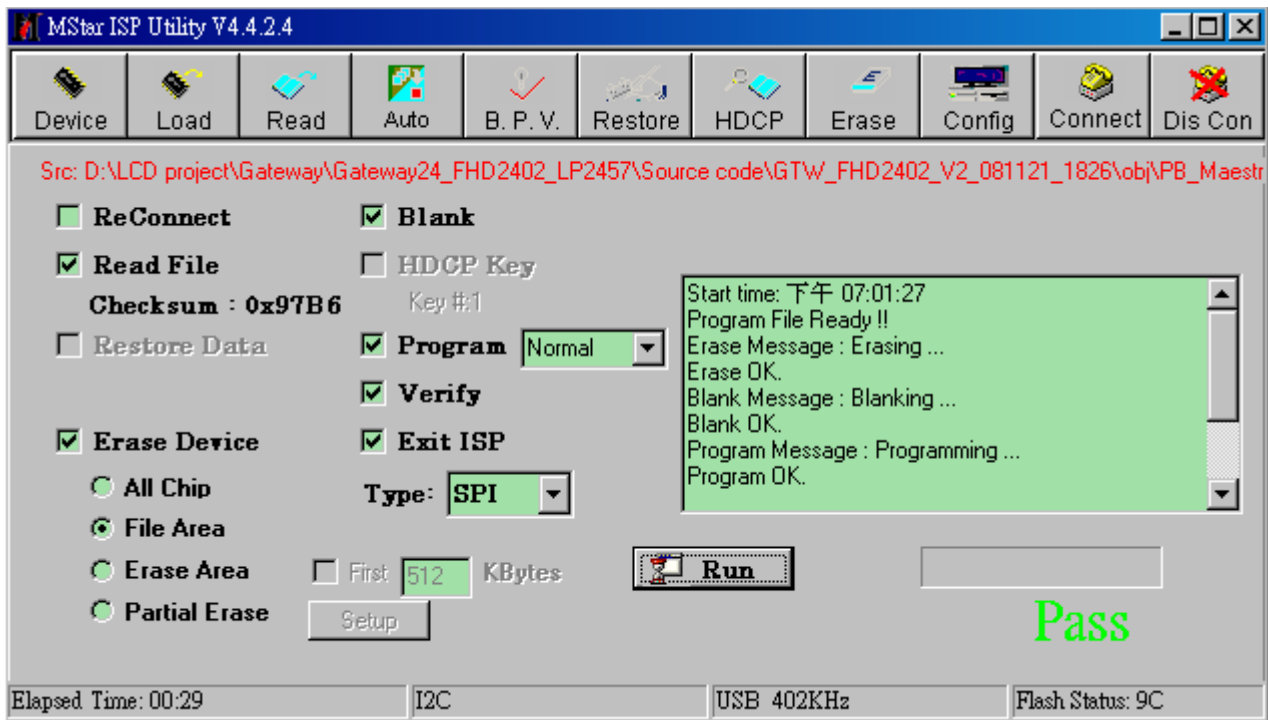

Note: if programming fails or success rate is not high, click “Config” and adjust its speed to lower

in “I2C Speed Setting” and check Communication Setting. If connect port is print port, please check port type.

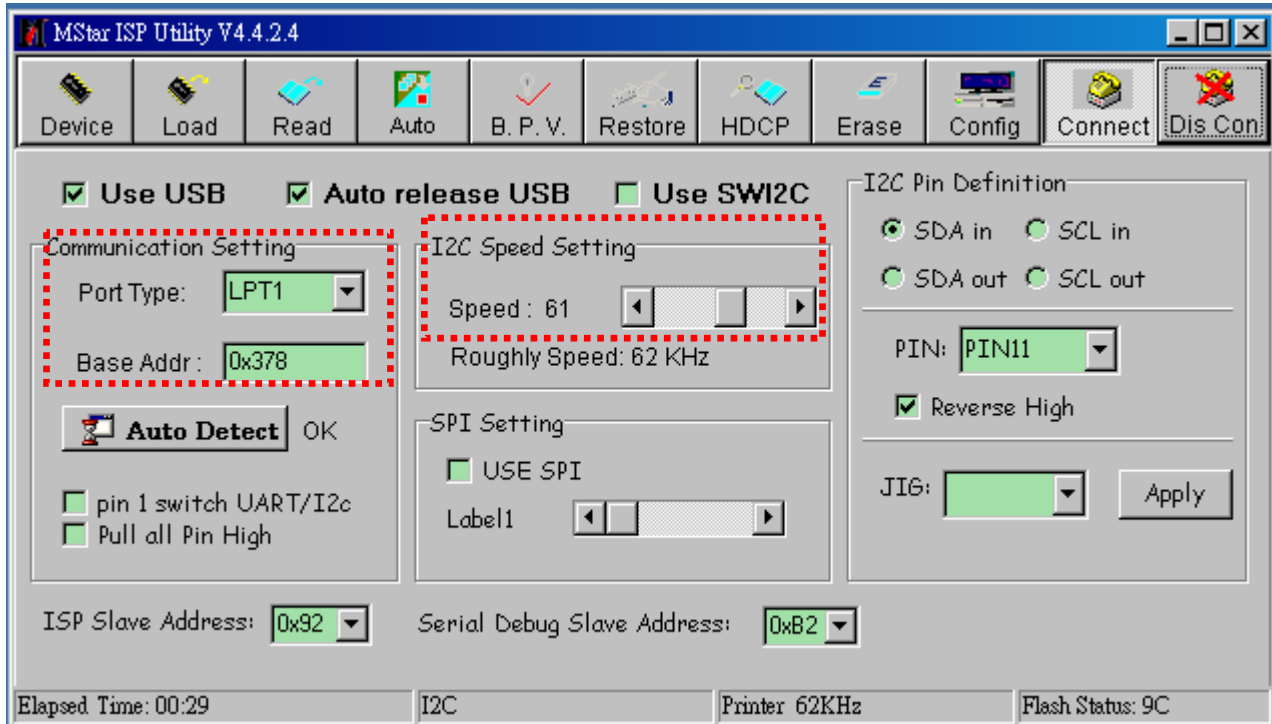

3. Flow Chart

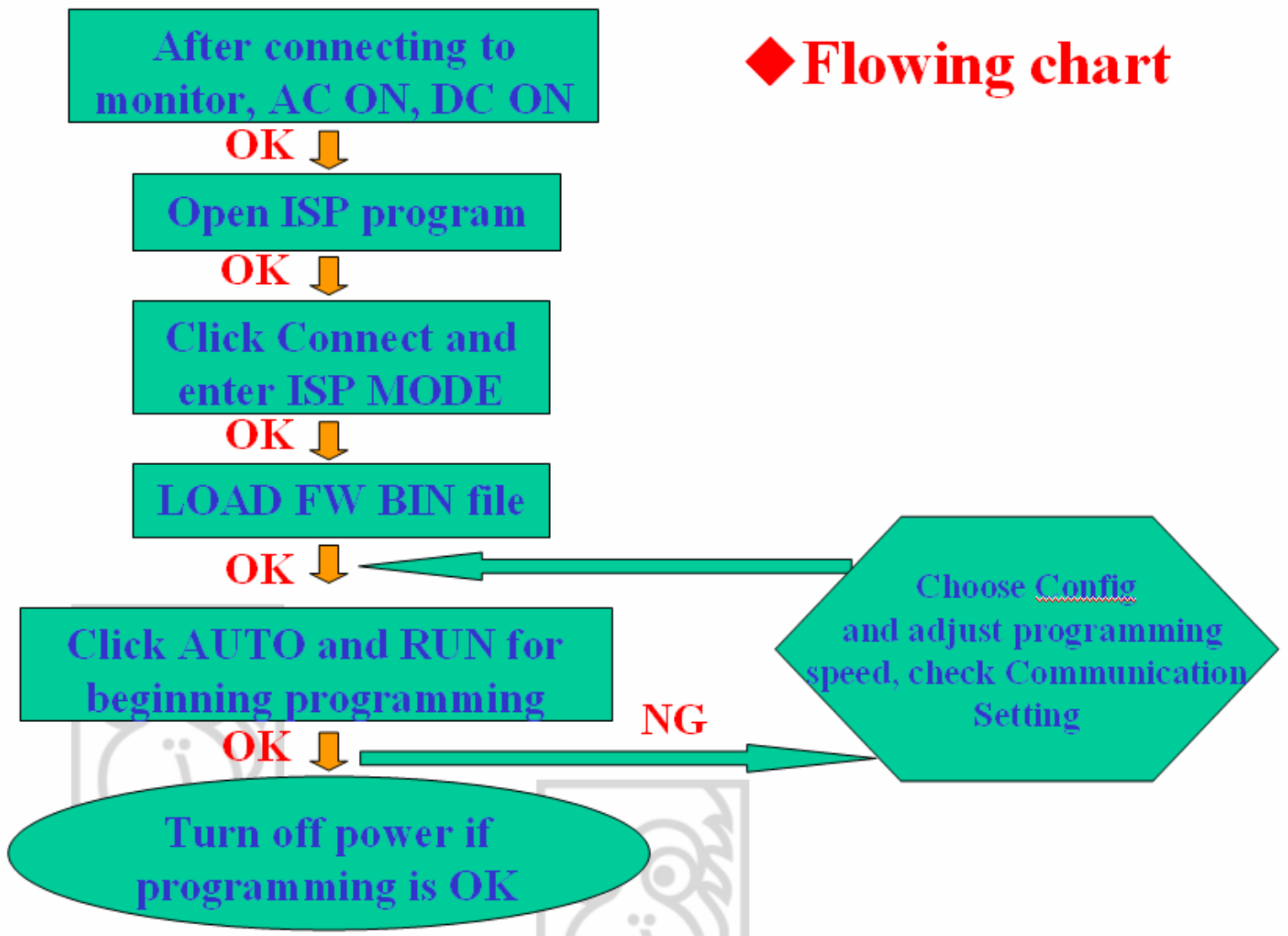

2. SOP of EDID (EDID TOOL: INL PN 799999942000R/ Acer PN 6K.LBQ0J.001)

2.1 Request of hardware and software:

1. Software

a.port95nt.exe

- b.Edid.exe
- c.A231H model

2. Hardware

- a. PC (winXP or win2000) 1PCS ;
- b. Tool (EDID Card、 VGA cable & DVI cable)

2.2 Operational steps:

1. First set up Port95nt.exe

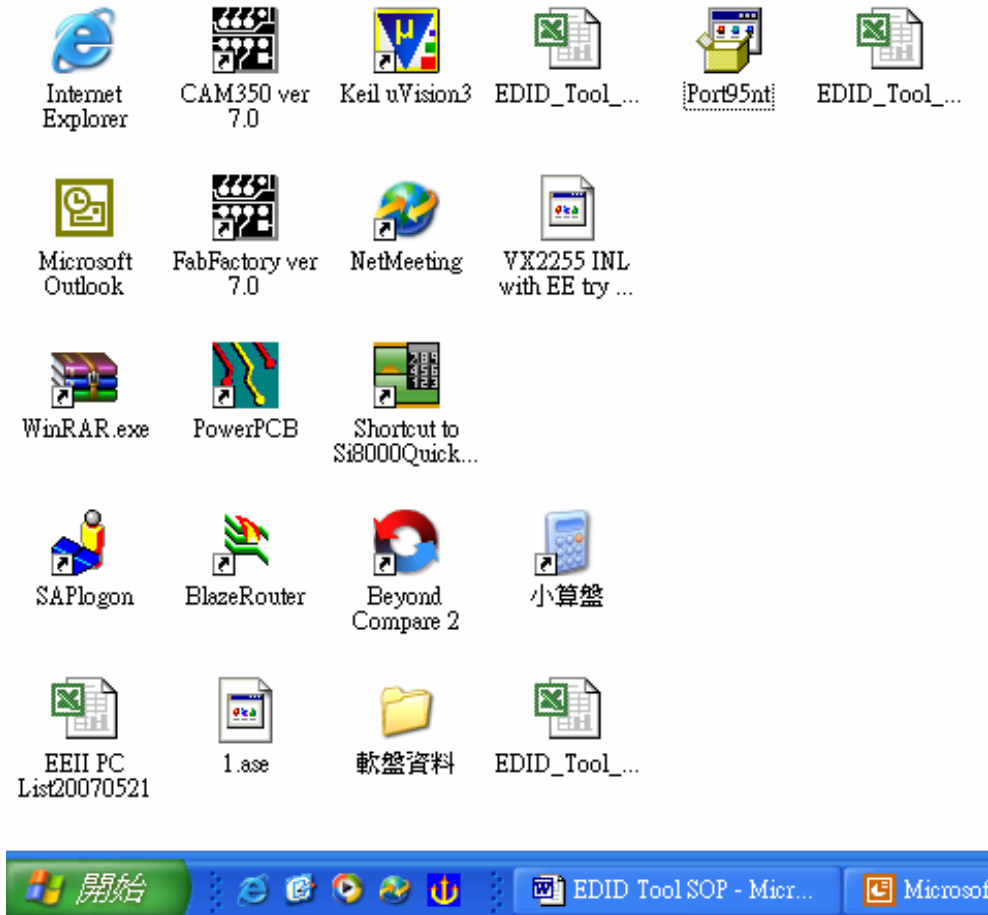

2. Click next button continually then can finish setting.

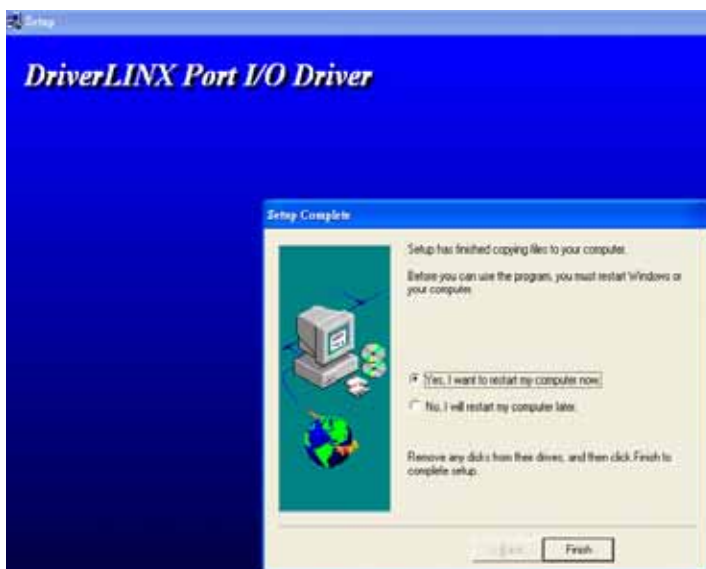
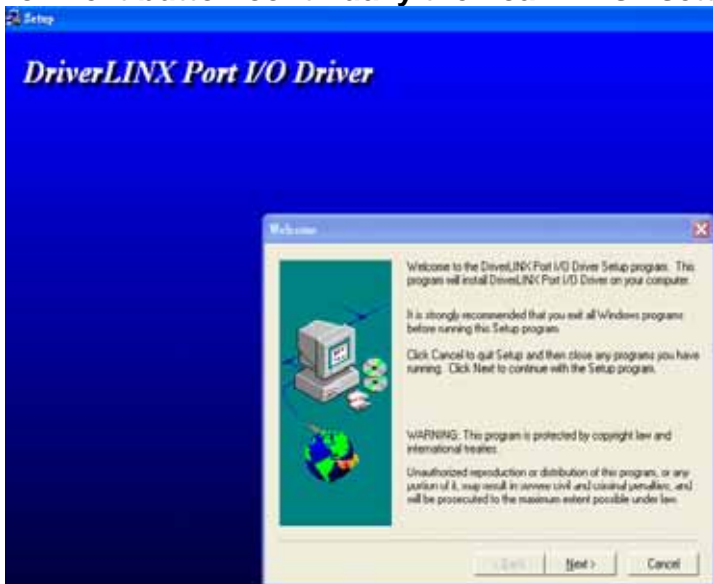

- A : USB interface provide +5V DC power (No Power is ok)
- B : Connect DDC Card and PC with collateral interface ;
- C :VGA、 DVI use different cable to link DDC and PC

EDID ISP Card:

A : Collateral printing interface (connect with PC)

B : VGA interface (one VGA connect with PC to provide signal for monitor the other one connect with PC VGA interface to write VGA EDID, Write EDID can without providing signal)

C : DVI interface (connect with Monitor)

3. Write EDID Process :

3.1 Choose File menu in main menu , choose Auto Write button , click S/N blank .

EDID Tool

File(F) Model(M) Setting(S) Data Read Help(H)

SFC Write
Auto Write
Data Check

Dialog DVI EDID Tool. Ver 1.6

MODEL: **A231H** CheckSum: 1EC1 DATE: 12/09/2008 Week: WEE1

Buffer

	0	1	2	3	4	5	6	7	8	9	a	b	c	d	e	f
0	00	FF	FF	FF	FF	FF	FF	00	04	72	67	00	00	00	00	00
1	00	00	01	03	80	29	17	78	EA	3D	85	A6	56	4A	9A	24
2	12	50	54	BF	EF	90	81	C0	81	00	81	80	81	40	71	4F
3	01	01	01	01	01	01	66	21	56	AA	51	00	1E	30	46	8F
4	33	00	9A	E6	10	00	00	1C	00	00	00	FF	00	30	30	30
5	30	30	30	30	30	30	30	30	0A	00	00	00	00	FD	00	37
6	AC	1E	50	0E	00	04	20	20	20	20	20	20	20	20	20	20

EEPROM

	0	1	2	3	4	5	6	7	8	9	a	b	c	d	e	f
0																
1																
2																
3																
4																
5																
6																

S/N

S/N: Check S/N: NULL Check S/N Length: 13

TID:

State

Write:

Check:

Message

Message:

Model Name:

S/N Time:

Note:

Message:



3.3 Choose the model, A231H_A(Update VGA) ,A231H_D(Update DVI) .

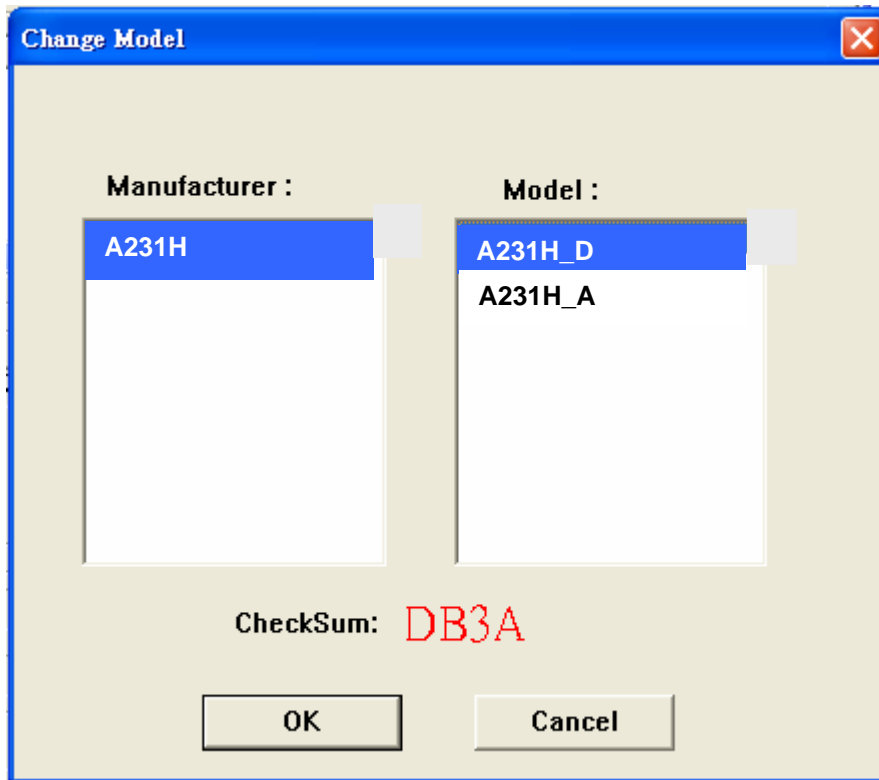

3.6 If write successfully , you can see PASS in the right

EDID Tool
File[F] Model[M] Setting[S] Data Read Help[H]

Analog DVI EDID Tool. Ver 1.6

MODEL: A231H CheckSum: 1EC1

DATE: 12/09/2008 Week: 50

Model Name: **A231H**

S/N Time: **8 0 5 1 1 1 D9 4 0 2 3**

YEAR: 2008 WEEK: 5

Note: **PASS**

Message: **Data Write OK!**

TestTime: 5.5 s

DVI_Buffer

	0	1	2	3	4	5	6	7	8	9	a	b	c	d	e	f
0	00	FF	FF	FF	FF	FF	FF	00	04	72	67	00	D9	11	51	80
1	05	12	01	03	80	29	17	78	EA	3D	85	A6	56	4A	9A	24
2	12	50	54	BF	EF	90	81	CD	81	00	81	80	81	40	71	4F
3	01	01	01	01	01	01	66	21	56	AA	51	00	1E	30	46	8F
4	33	00	9A	E6	10	00	00	1C	00	00	00	FF	00	4C	41	31
5	30	43	31	30	39	34	30	32	33	0A	00	00	00	FD	00	37
6	4C	1F	50	0E	00	0A	20	20	20	20	20	20	20	00	00	FC
7	00	58	31	39	33	48	51	0A	20	20	20	20	20	20	00	9B

DVI_EEPROM

	0	1	2	3	4	5	6	7	8	9	a	b	c	d	e	f
0	00	FF	FF	FF	FF	FF	FF	00	04	72	67	00	D9	11	51	80
1	05	12	01	03	80	29	17	78	EA	3D	85	A6	56	4A	9A	24
2	12	50	54	BF	EF	90	81	CD	81	00	81	80	81	40	71	4F
3	01	01	01	01	01	01	66	21	56	AA	51	00	1E	30	46	8F
4	33	00	9A	E6	10	00	00	1C	00	00	00	FF	00	4C	41	31
5	30	43	31	30	39	34	30	32	33	0A	00	00	00	FD	00	37
6	4C	1F	50	0E	00	0A	20	20	20	20	20	20	20	00	00	FC
7	00	58	31	39	33	48	51	0A	20	20	20	20	20	20	00	9B

S/N: Check S/N: NULL Check S/N Length: 22

TID:

Write **ETLA10C109805111D94023**

State: W_128: C_128:

Message: **Data Write OK!**

Message: (081110)
Enter DDC->Rec: edc,
Exit DDC->Rec: adc,

Free Manuals Download Website

<http://myh66.com>

<http://usermanuals.us>

<http://www.somanuals.com>

<http://www.4manuals.cc>

<http://www.manual-lib.com>

<http://www.404manual.com>

<http://www.luxmanual.com>

<http://aubethermostatmanual.com>

Golf course search by state

<http://golfingnear.com>

Email search by domain

<http://emailbydomain.com>

Auto manuals search

<http://auto.somanuals.com>

TV manuals search

<http://tv.somanuals.com>