

Acer AL1912

Service Guide

Service guide files and updates are available on the CSD web: for more information, Please refer to <http://csd.acer.com.tw/>

Copyright

Copyright © 2003 by Acer Incorporated. All rights reserved. No part of this publication may be reproduced, transmitted, transcribed, stored in a retrieval system, or translated into any language or computer language, in any form or by any means, electronic, mechanical, magnetic, optical, chemical, manual or otherwise, without the prior written permission of Acer Incorporated.

Disclaimer

The information in this guide is subject to change without notice. Acer Incorporated makes no representations or warranties, either expresses or implied, with respect to the contents hereof and specifically disclaims any warranties of merchantability or fitness for any particular purpose. Any Acer Incorporated software described in this manual is sold or licensed "as is". Should the programs prove defective following their purchase, the buyer (and not Acer Incorporated, its distributor, or its dealer) assumes the entire cost of all necessary servicing, repair, and any incidental or consequential damages resulting from any defect in the software.

Acer is a registered trademark of Acer Corporation.

Intel is a registered trademark of Intel Corporation.

Pentium and Pentium II/III are trademarks of Intel Corporation.

Other brand and product names are trademarks and/or registered trademarks of their respective holders.

Conventions

The following conventions are used in this manual:

Screen messages	Denotes actual messages that appear on screen
Note	Gives bits and pieces of additional information related to the current topic.
Warning	Alerts you to any damage that might result from doing or not doing specific actions.
Caution	Gives precautionary measures to avoid possible hardware or software problems.
Important	Reminds you to do specific actions relevant to the accomplishment of procedures.

Preface

Before using this information and the product it supports, please read the following general information.

1. this Service Guide provides you with all technical information relating to the BASICCONFIGURATION decided for Acer's "global" product offering. To better fit local market requirements and enhance product competitiveness, your regional office MAY have decided to extend the functionality of a machine (e.g. add-on card, modem, or extra memory capability). These LOCALIZED FEATURES will NOT be covered in this generic service guide. In such cases, please contact your regional offices or the responsible personnel/channel to provide you with further technical details.
2. please not WHEN ORDERING FRU PARTS, that you should check the most up-to-date information available on your regional web or channel. If, for whatever reason, a part number change is made, it will not be noted in the printed Service Guide, for ACER-AUTHORIZED SERVICE PROVIDERS, your Acer office may have a DIFFERENT part number code to those given in the FRU list of this printed Service Guide. You MUST use the list provided by your regional Acer office to order FRU parts for repair and Service of customer machines.

WARNING: (FOR FCC CERTIFIED MODELS)

NOTE: this equipment has been tested and found to comply with the limits for a Class B digital device, pursuant to Part 15 of the FCC Rules. These limits are designed to provide reasonable protection against harmful interference in a residential installation. This equipment generates, uses and can radiate radio frequency energy, and if not installed and used in accordance with the instructions, may cause harmful interference to radio communications. However, there is no guarantee that interference will not occur in a particular installation. If this equipment does cause harmful interference to radio or television reception,

Which can be determined by turning the equipment off and on, the user is encouraged to try to correct the interference by one or more of the following measures:

1. Reorient or relocate the receiving antenna.
2. Increase the separation between the equipment and receiver.
3. Connect the equipment into an outlet on a circuit different from that to which the receiver is connected.
4. Consult the dealer or an experienced radio/TV technician for help.

Warning

Use only shielded signal cables to connect I/O devices to this equipment. You are cautioned that changes or modifications not expressly approved by the party responsible for compliance could void your authority to operate the equipment.

As an ENERGY STAR® Partner our company has determined that this product meets the ENERGY STAR® guidelines for energy efficiency.

WARNING:

To prevent fire or shock hazard, do not expose the monitor to rain or moisture. Dangerously high voltages are present inside the monitor. Do not open the cabinet. Refer servicing to qualified personnel only.

PRECAUTIONS

- Do not use the monitor near water, e.g. near a bathtub, washbowl, kitchen sink, laundry tub, Swimming pool or in a wet basement.
- Do not place the monitor on an unstable trolley, stand, or table. If the monitor falls, it can injure a person and cause serious damage to the appliance. Use only a trolley or stand recommended by the manufacture or sold with the monitor. If you mount the monitor on a wall or shelf, use a mounting kit approved by the manufacture and follow the kit instructions.
- Slots and openings in the back and bottom of the cabinet area provided for ventilation. To ensure reliable operation of the monitor and to protect it from overheating, be sure these openings are not blocked or covered. Do not place the monitor on a bed, sofa, rug or similar surface. Do not place the monitor near or over a radiator or heat register. Do not place the monitor in a bookcase or cabinet unless proper ventilation is provided.
- The monitor should be operated only from the type of power source indicated on the label. If you are not sure of the type of power supplied to your home, consult your dealer or local power company.
- The monitor is equipped with a three-pronged grounded plug, a plug with a third (grounding) pin. This plug will fit only into a grounded power outlet as a safety feature. If your outlet does not accommodate the three-wire plug, have an electrician install the correct outlet, or use an adapter to ground the appliance safely. Do not defeat the safety purpose of the grounded plug.
- Unplug the unit during a lightning storm or when it will not be used for long periods of time. This will protect the monitor from damage due to power surges.
- Do not overload power strips and extension cords. Overloading can result in fire or electric shock.
- Never push any object into the slot on the monitor cabinet. It could short circuit parts causing a fire or electric shock. Never spill liquids on the monitor.
- Do not attempt to service the monitor yourself; opening or removing covers can expose you to dangerous voltages and other hazards. Please refer all servicing to qualified service personnel.
- To ensure satisfactory operation, use the monitor only with UL listed computers which have appropriate configured receptacles marked between 100-240V AC, Min. 3.5A.
- The wall socket shall be installed near the equipment and shall be easily accessible.

SPECIAL NOTES ON LCD MONITORS

The following symptoms are normal with LCD monitor and do not indicate a problem.

NOTES

- Due to the nature of the fluorescent light, the screen may flicker during initial use. Turn off the Power Switch and then turn it on again to make sure the flicker disappears.
- You may find slightly uneven brightness in the screen depending on the desktop pattern you use.
- The LCD screen has effective pixels of 99.99% or more. It may include blemishes of 0.01% or less such as a missing pixel or a pixel lit all of the time.
- Due to the nature of the LCD screen, an afterimage of the previous screen may remain after switching the image, when the same image is displayed for hours. In this case, the screen is recovered slowly by changing the image or turning off the Power Switch for hours.

Table of contents

Chapter 1 Monitor Feature	8
INTRODUCTION.....	8
ELECTRICAL REQUIREMENTS.....	9
MONITOR BLOCK DIAGRAM	15
BLOCK DIAGRAM	16
MONITOR BOARD LAYOUT	17
SOFTWARE FLOW CHART	18
GENERAL INSTRUCTIONS	19
SYSTEM INSTALLATION	20
POWER/INVERTOR BOARD	25
ELECTRICAL SPECIFICATION.....	26
INVERTER ELECTRICAL SPECIFICATION	28
SAFETY	28
Chapter 2 Operating Instruction	30
CONTROLS	30
MAIN OSD MENU.....	31
OSD MESSAGE.....	33
PLUG AND PLAY	35
WHITE COLOR TEMPERATURE.....	36
AUDIO TECHNICAL SPECIFICATION (FOR AL1912 m ONLY).....	36
SPEAKERS.....	37
Chapter 3 Machine Disassembly and Replacement	38
DISASSEMBLY PROCEDURE	38
Chapter 4 Troubleshooting	41
TROUBLESHOOTING	41
Chapter 5 Connector Information	45
CONNECTOR INFORMATION	45
Chapter 6 FRU List	46
FRU (Field Replaceable Unit) list.....	46
PART LIST.....	49
Chapter 7 Schematic Diagram	52
SCHEMATIC DIAGRAM	52

Monitor Feature

INTRODUCTION

Scope

This specification defines the requirements for the 19" MICRO-PROCESSOR based Multi-mode supported high resolution color LCD monitor. This monitor can be directly connected to general 15 pin D-sub VGA connector and eliminates the requirement of optional special display card. It also supports VESA DPMS power management and plug & play function. There is a build-in stereo audio amplifier with volume control to drive a pair of speakers.

Description

The LCD monitor is designed with the latest LCD technology to provide a performance oriented product with no radiation. This will alleviate the growing health concerns. It is also a space saving design, allowing more desktop space, and comparing to the traditional CRT monitor, it consumes less power and gets less weight in addition MTBF target is 20k hours or more.

Comparison Chart of AL1912 m/AL1912

	AL1912 m	AL1912
Panel	Normal 19" panel Fujitsu FLC48SXC8V-10	Normal 19" panel Fujitsu FLC48SXC8V-10
Signal Interface	DSUB	DSUB
Sync Type for analog input	Separate / compatible /	Separate / compatible /
Color Temp user adjust	Support	Support
DDC	DDC2B	DDC2B
Speaker	0.5W+0.5W	NO
Headphone Jack	NO	NO
Microphone Jack	No	No
USB Hub	Not support	Not support
Tilt / Swivel	Yes / No	Yes / No

Height Adjust	Option	Option
---------------	--------	--------

ELECTRICAL REQUIREMENTS

Standard Test Conditions

All tests shall be performed under the following conditions, unless otherwise specified.

Ambient light :	225 lux
Viewing distance :	50 cm in front of LCD panel
Warm up time	
All specifications :	30 minutes
Fully functional :	5 seconds
Measuring Equipment :	Chroma 2250 signal generator or equivalent, directly Connected to the monitor under test. Minolta CA100 photometer, or equivalent
Control settings	
User brightness control :	Maximum (unless otherwise specified)
User contrast control:	Typical (unless otherwise specified)
User red/white balance, Green/white balance and Blue/white balance control :	In the center (unless otherwise specified)
Power input:	110Vac or 230Vac
Ambient temperature:	20 ± 5 °C (68 ± 9 ° F)
Analog input mode:	1280 x1024 /60 Hz

MEASUREMENT SYSTEMS

The units of measure stated in this document are listed below:

- 1 gamma = 1 nano tesla
- 1 tesla = 10,000 gauss
- cm = in x 2.54
- lb = kg x 2.2
- degrees F = [°C x 1.8] + 32
- degrees C = [°F - 32]/1.8
- $u' = 4x/(-2x + 12y + 3)$
- $v' = 9y/(-2x + 12y + 3)$
- $x = (27u'/4)/[(9u'/2) - 12v' + 9]$
- $y = (3v')/[(9u'/2) - 12v' + 9]$
- nits = cd/(m²) = Ft-L x 3.426
- lux = foot-candle x 10.76

LCD monitor General specification

Panel Type:	19 " active matrix color TFT LCD 1). Fujitsu FLC48SXC8V-10
Display size:	376.32mm (H) × 301.056mm(V)
Display mode:	VGA 720 × 400 (70 Hz) VGA 640 × 480 (60/66/70/72/75 Hz) SVGA 800 × 600 (60/70/72/75 Hz) XGA 1024 × 768 (60/70/75 Hz) SXGA 1280 × 1024 (60/70/75 Hz) standard resolution
Pixel pitch:	0.294mm(H) × 0.294mm(V)
Display Dot:	1280 x (RGB) × 1024
Pixel Clock:	25.2 – 135.0MHz
Contrast ratio: $\theta = 0^\circ$	HYDIS 700:1 (typical)
Brightness:	HYDIS:300 (typical)
Response time (Tr/Tf):	Ta=25°C, 15/10ms (typical)
Display color:	16.2M
Viewing angle:	HYDIS L / R $\geq 85 / \geq 85$ U / D $\geq 85 / \geq 85$
Luminance Uniformity:	> 75 % (min)
Pc interface:	1).Video: RGB analog 0.7V peak to peak Sync: TTL positive or negative
Signal connector:	15 pin Mini D type, (standard VGA video) 3.5 mm stereo audio jack (Audio) (For AL1912 m only)
Audio power:	0.5Wrms + 0.5Wrms (300Hz – 10kHz (S.P.L. – 10 dB))(AL1912 m only)
Front control:	power on/off with LED select adjustment (+,-)
Interface frequency	
Horizontal Frequency	24KHz --80KHz
Vertical Frequency	49Hz -----75Hz
Plug & play:	Support VESA DDC2B functions
Power Input voltage:	Single phase, 50/60HZ, 100 VAC to 240VAC $\pm 10\%$

Total output power: 60 Watt max.

LCD Panel Specification

LCD Panel Model (Hydis LT17E12-200)

- Display Type active matrix color TFT LCD
- Resolution 1280x1024 pixels
- Display Dot 1280x (RGB) x 1024
- Display Area 376.32mm(H) x 301.056mm(V)
- Pixel Pitch 0.294mm(H) x 0.294mm(V)
- Display Color 16M
- Lamp Voltage 750 Vrms (typ)
- Lamp Current 7 mArms (typ)
- Weight 2500g (Max)
- Optical Specifications

9. OPTICAL SPECIFICATIONS									
Table 9-1 shows the optical specifications of this LCD module.									
Table 9-1 Optical Specifications					Ta=25°C, Signal Timing=Typ.				
Item	Symbol	Condition	Specifications			Unit	Remark		
			MIN.	TYP.	MAX.				
Visual Angle	Horizontal	$\theta_{L,R}$	CR \geq 10	$\theta_{U,D}=0^\circ$	85	—	—	deg	
	Vertical	$\theta_{U,D}$		$\theta_{L,R}=0^\circ$	85	—	—	deg	
	All Direction	θ			—	80	—	deg	
Contrast Ratio	③	CR	$\theta_{L,R,U,D}=0^\circ$		400	700	—	—	White/Black
Response Time(ON) (B→W)	t_{on}	$\theta_{L,R,U,D}=0^\circ$	Ta=25°C	—	15	30	ms		
			Ta=0°C	—	50	100	ms		
Response Time(OFF) (W→B)	t_{off}	$\theta_{L,R,U,D}=0^\circ$	Ta=25°C	—	10	25	ms		
			Ta=0°C	—	50	100	ms		
Brightness	③	I	$\theta_{L,R,U,D}=0^\circ$	240	300		cd/m ²		
Brightness Uniformity	ΔI	x	V _{CC} =5V I _L =7mA	④	75	—	—	%	White #1
					0.283	0.313	0.343	—	
②② Chromaticity	W	y	④	Red	(0.648 0.642, 0.346 0.349) Typ.				
		Green		(0.292 0.292, 0.602 0.596) Typ.					
	R G B (x, y)	Blue		(0.150 0.148, 0.130 0.125) Typ.					
LCD Panel Type				TFT Color					
Display Mode				Normaly Black					
Wide Viewing Angle Technology				MVA					
Optimum Viewing Angle				— (symmentry)					
Display Color				16,777,216 (8-bit color)					
Color of non-display area				Black					
Surface Treatment				Anti-glare (Haze value:(25%), 2H)					
<p>(*1) Value at 15~20 minutes after lighting on.</p> <p>(Note) ·CS-1000 (MINOLTA Co., Ltd.) , BM·5A(Topcon) and the like should be used as a luminance colorimeter. Field=1° , L=500mm ·Back-light current = 7mA, Dark room condition(1 lux or less)</p>									
				TITLE FLC48SXC8V-10					
				DRAW NO. Tech Bes LCD-00157					
				FUJITSU DISPLAY TECHNOLOGIES CORPORATION					
				8 /					

DATE DOCUMENT CONTROL SECTION

04	20090128				Correction of R/G/B chromaticity	TITLE FLC48SXC8V-10	
03	20021206				Change brightness, Cr spec.	DRAW NO. Tech Bes LCD-00157	CUST.
02	20021101				Change chromaticity spec.		
EDIT	DATE	DESIG.	CHECK	APPR.	DESCRIPTION	FUJITSU DISPLAY TECHNOLOGIES CORPORATION	
			CHECK		APPR.		

Panel Relative Humidity

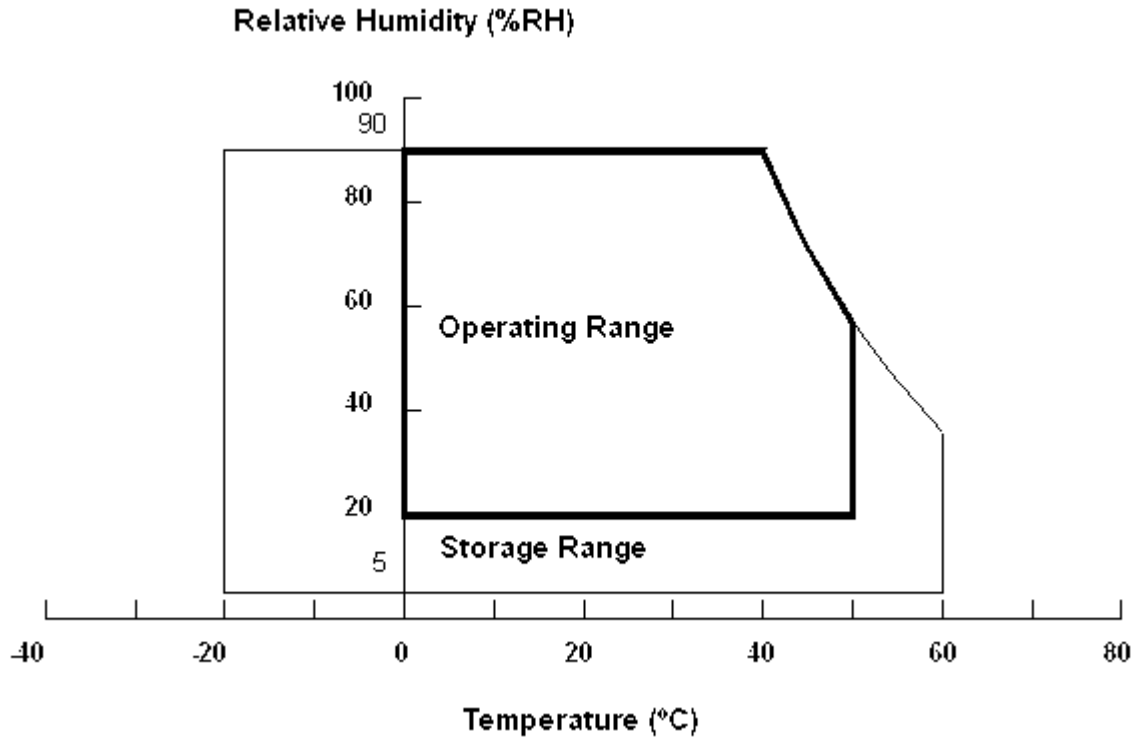

Input Signals

Video input

- Type Analog R, G, B.
- Input Impedance 75 ohm +/- 2%
- Polarity Positive
- Amplitude 0 - 0.7 +/- 0.05 Vp
- Display Color same as LCD panel

Sync input

- Signal separate horizontal and vertical sync, or composite sync which are TTL compatible
- Polarity positive and negative.

Interface frequency

The following frequency range is generalized by supported timing. If the entered mode does not match the supported timing the display optimization will not be assured.

- Horizontal Frequency 24KHz --80KHz
- Vertical Frequency 49Hz -----75Hz

Supported Timing

TIMING	FH(KHZ)	SYNC	TOTAL	ACTIVE	SYNC	FRONT	BACK	PIXEL
	FV(HZ)	POLARITY	(DOT/LINE)	(DOT/LINE)	WIDTH (DOT/LINE)	PORCH (DOT/LINE)	PORCH (DOT/LINE)	FOREQ.(MHZ)
640x350	31.469	+	800	640	96	16	48	25.175
VGA-350	70.087	-	449	350	2	37	60	
640x400	24.83	-	848	640	64	64	80	21.05
NEC PC9801	56.42	-	440	400	8	7	25	
640x400	31.469	-	800	640	96	16	48	25.175
VGA-GRAPH	70.087	+	449	400	2	12	35	
640x400	31.5	-	800	640	64	16	80	25.197
NEC PC9821	70.15	-	449	400	2	13	34	
640X480	31.469	-	800	640	96	16	48	25.175
VESA-PAL	50.030	-	629	480	2	62	85	
640x480	31.469	-	800	640	96	16	48	25.175
VGA-480	59.94	-	525	480	2	10	33	
640x480	35.00	-	864	640	64	64	96	30.24
APPLE MAC-480	66.67	-	525	480	3	3	39	
640x480	37.861	-	832	640	40	16	120	31.5
VESA-480-72Hz	72.809	-	520	480	3	1	20	
640x480	37.5	-	840	640	64	16	120	31.5
VESA-480-75Hz	75	-	500	480	3	1	16	
720x400	31.469	-	900	720	108	18	54	28.322
VGA-400-TEXT	70.087	+	449	400	2	12	35	
832x624	49.725	-	1152	832	64	32	224	57.2832
APPLE MAC-800	74.55	-	667	624	3	1	39	
800x600	35.156	+	1024	800	72	24	128	36
SVGA	56.25	+	625	600	2	1	22	
800x600	37.879	+	1056	800	128	40	88	40
VESA-600-60Hz	60.317	+	628	600	4	1	23	
800x600	48.077	+	1040	800	120	56	64	50
VESA-600-72Hz	72.188	+	666	600	6	37	23	
800x600	46.875	+	1056	800	80	16	160	49.5
VESA-600-75Hz	75	+	625	600	3	1	21	
1024x768	48.363	-	1344	1024	136	24	160	65
XGA	60.004	-	806	768	6	3	29	
1024x768	53.964	+	1328	1024	176	16	112	71.664
COMPAQ-XGA	66.132	+	816	768	4	8	36	
1024x768	56.476	-	1328	1024	136	24	144	75
VESA-768-70Hz	70.069	-	806	768	6	3	29	
1024x768	60.023	+	1312	1024	96	16	176	78.75
VESA-768-75Hz	75.029	+	800	768	3	1	28	
1024x768	60.24	-	1328	1024	96	32	176	80
APPLE MAC-768	75.02	-	803	768	3	3	29	
1152x864	54.054	+	1480	1152	96	40	192	80
(60Hz)	59.270	+	912	864	3	13	32	
1152x864	63.851	+	1480	1152	96	32	200	94.499
(70Hz)	70.012	+	912	864	3	1	44	
1152x864	67.50	+	1600	1152	128	64	256	108.00
(75Hz)	75.00	+	900	864	2	2	32	
1280x960	60.00	+	1800	1280	112	96	312	108.00
(60Hz)	60.00	+	1000	960	3	1	36	
1280x960	70.00	+	1800	1280	112	96	312	126.00
(70Hz)	70.00	+	1000	960	3	1	36	
1280x960	75.00	+	1800	1280	112	96	312	135.00
(75Hz)	75.00	+	1000	960	3	1	36	
1280x1024	64	+	1688	1280	112	48	248	108
VESA-1024-60Hz	60	+	1066	1024	3	1	38	
1280x1024	80	+	1688	1280	144	16	248	135
VESA-1024-75Hz	75	+	1066	1024	3	1	38	

Note: Mode 640x350, 640x400 and 720x400 will locate on middle position but cannot be expanded to full screen on vertical direction.

Support Modes

There will be 28 total support modes to accommodate the above mode and other video modes within the frequency range of the monitor.

85Hz refresh rate Support

Monitor should display 85Hz refresh rate mode as emergency mode.

Monitor should display "Out of Range" warning menu at this mode.

Video input Connector

Analog Video input Connector: 15pins mini D-Sub

Table 2.4.5. Pin assignment for D-sub connector

PIN NO.	Separate Sync
1	RED VIDEO
2	GREEN VIDEO
3	BLUE VIDEO
4	GROUND
5	GROUND
6	RED GROUND
7	GREEN GROUND
8	BLUE GROUND
9	PC5V (+5V DDC)
10	CABLE DETECTION
11	GROUND
12	SDA
13	H.SYNC
14	V.SYNC
15	SCL

Color of plastic parts: Blue (PC99)

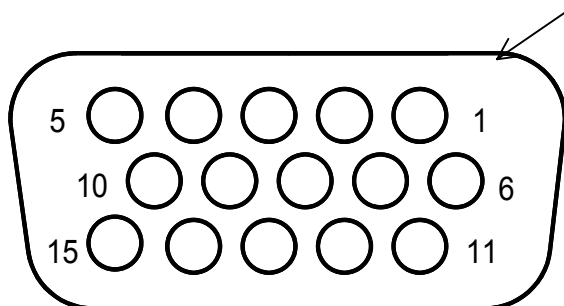

D-sub connector

MONITOR BLOCK DIAGRAM

The LCD monitor will contain an main board, an inverter/ power board, key board and internal adapter which house the flat panel control logic, brightness control logic and DDC.

The inverter board will drive the backlight of panel and the DC-DC conversion.

The Adapter will provide thr 12V DC-power to inverter/ power board.

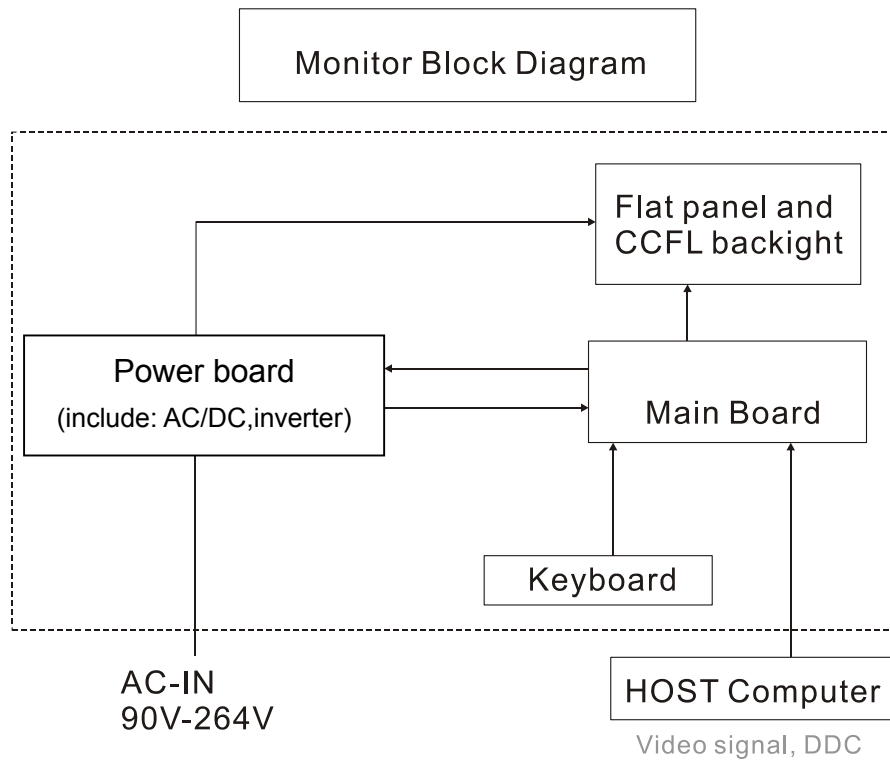

BLOCK DIAGRAM

System Block Diagram

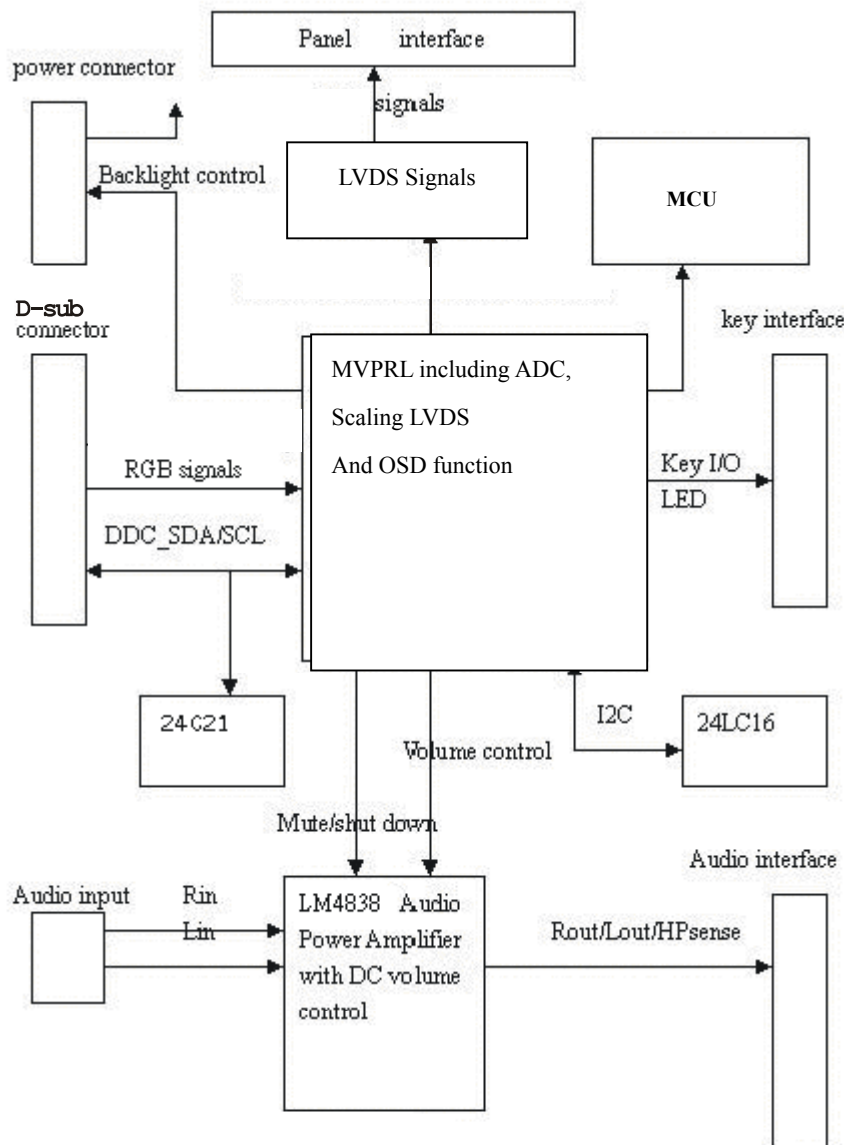

Monitor board layout

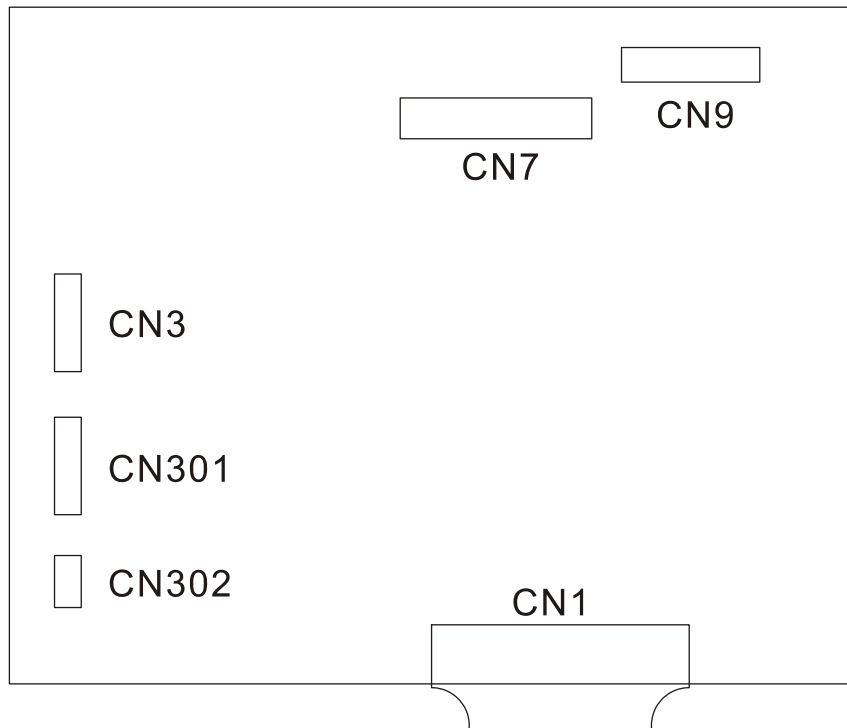

LABEL	Component	LABEL	Component
U1	74LVC14	CN1	D-SVB 15 PIN
U2	24LVC21	CN9	E&T 4501-10
U4	MVPRL	CN3	E&T 6113-08
U6	M8064I	CN301	E&T 4501-11
U5	24LC16B	CN302	E&T 4501-03
U7	MAX810	CN7	E&T DF14-30
U8	SI9435		
U9	LM4838		
U10	APL1085-3.3 CE		
U11	APL1117-2.5 VC		

Software flow chart

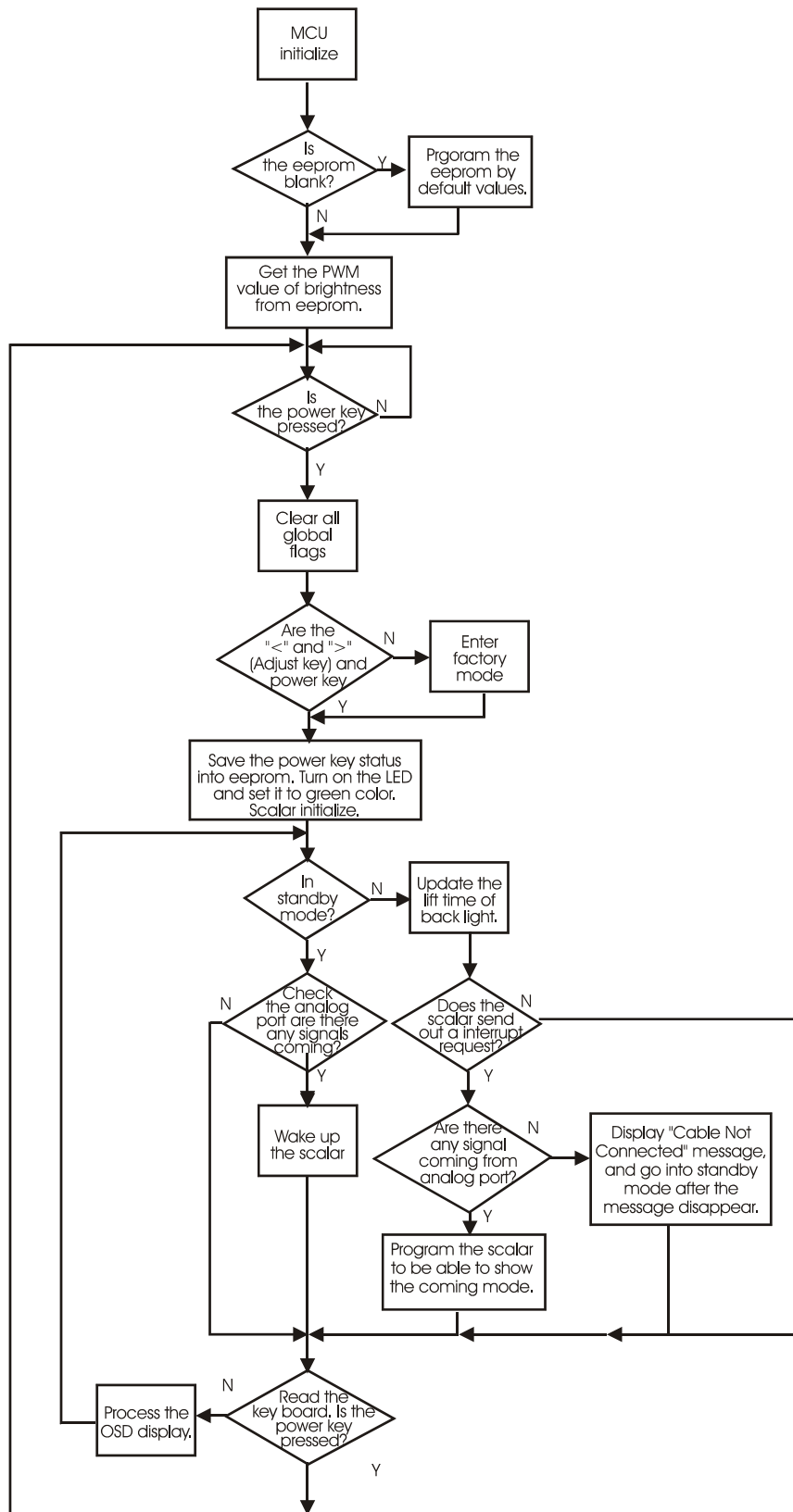

General Instructions

Press the power button to turn the monitor on or off. The other control buttons are located at front panel of the monitor. By changing these settings, the picture can be adjusted to your personal preferences.

- The power cord should be connected.
- Connect the video cable from the monitor to the video card.
- Press the power button to turn on the monitor position. The power indicator will light up.

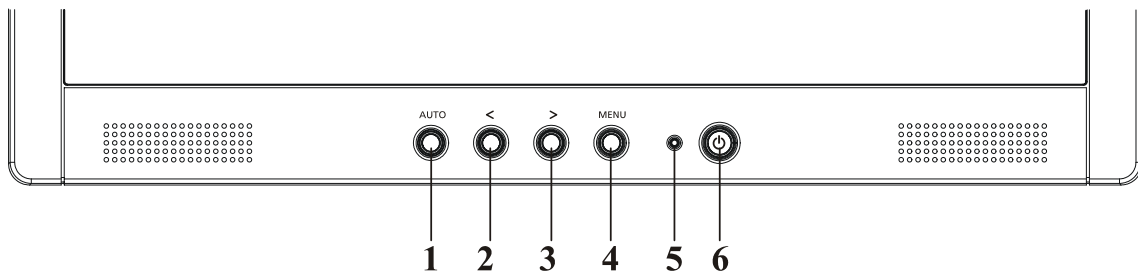

AL1912 m

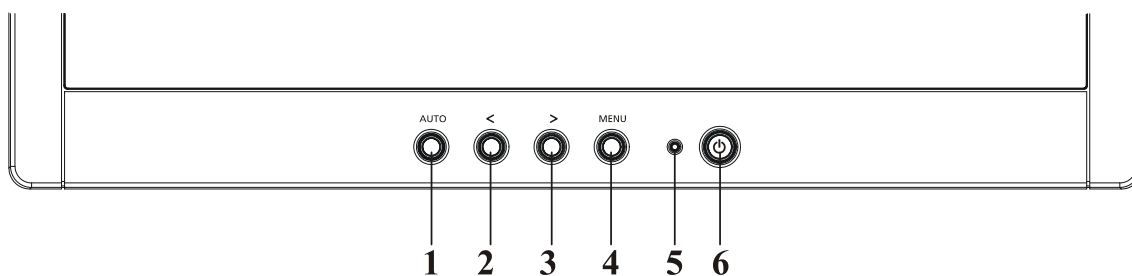

AL1912

External Controls

1	Auto Adjust Key/Exit	4	MENU/ENTER
2	</ Volume	5	LED
3	>/ Volume	6	⏻ / Power Key

System Installation

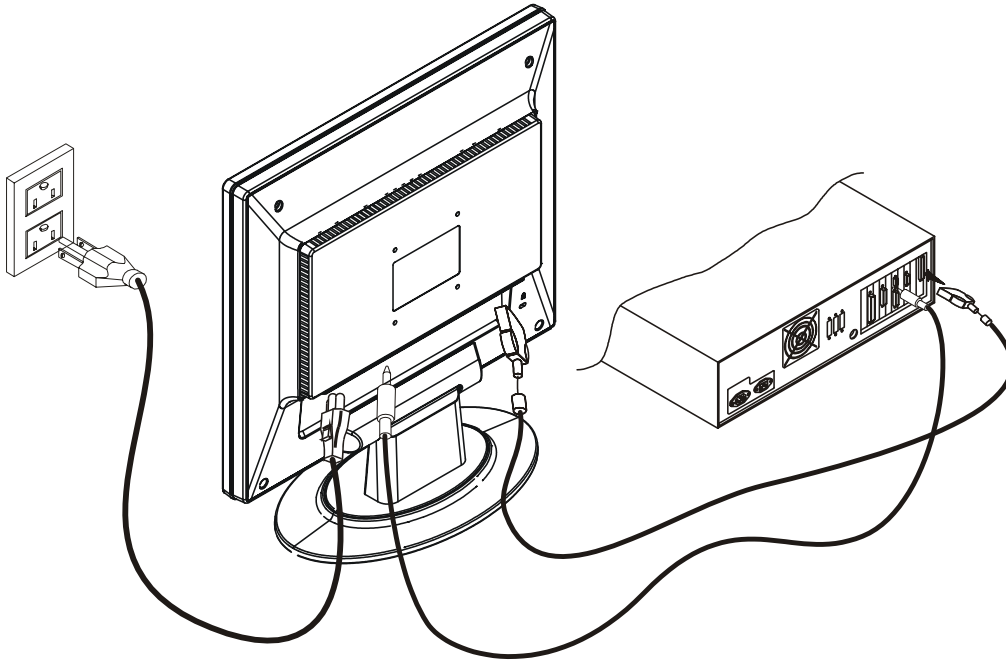

Connecting the Display

- Power off your computer.
- Connect one end of the signal cable to the LCD Monitor's VGA port.
- Connect the other end of the signal cable to the VGA port on your PC.
- Make sure connections are secure.

Connecting the AC Power

- Connect the power cord to the LCD Monitor.
- Connect the power cord to an AC power source.

Connecting the Audio Cable (For AL1912 m and AL1912 bm)

- Connect the audio cable to the " LINE OUT " jack on your PC's audio card or to the front panel's "AUDIO OUT" jack of your CD ROM drive.
- Connect the other end of the audio cable to the LCD Monitor's " AUDIO IN " jack.

The step between front bezel and back cover shall be within specification.

Top and Bottom

Back cover & Bezel concavity

$0.8\text{mm} \leq A \leq 1.3 \text{ mm}$

Left and Right

Back cover & Bezel concavity

$0.8\text{mm} \leq A \leq 1.3 \text{ mm}$

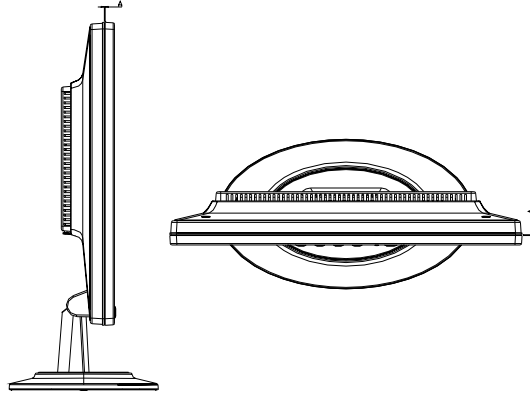

Back Cover & Hinge Cover concavity

$0\text{mm} \leq B \leq 0.5\text{mm}$

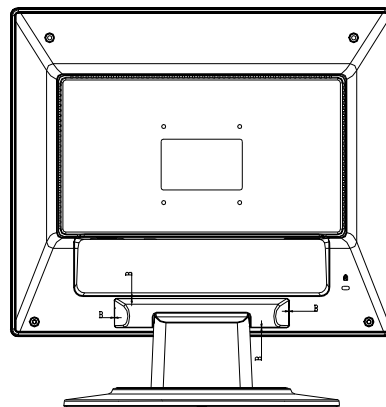

Base & Neck concavity

$$0\text{mm} \leq C \leq 0.6\text{mm}$$

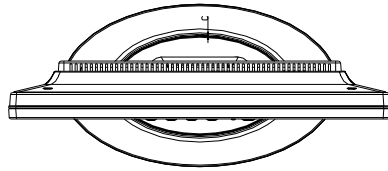

Top and Bottom

Back cover & Bezel step

$$0\text{mm} \leq D \leq 0.8 \text{ mm}$$

Left and Right

Back cover & Bezel step

$$0\text{mm} \leq D \leq 0.8 \text{ mm}$$

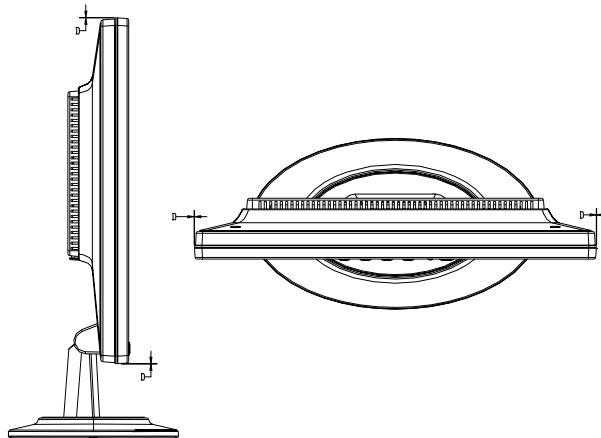

LCD Horizontally

The angle between front bezel and LCD unit in bottom side should not large than 1.0mm.

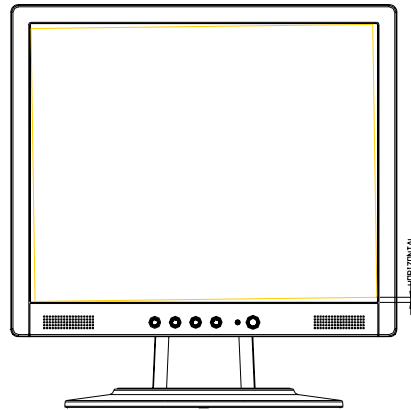

The distance of the LCD display unit from left side to right should not large than 4.0mm.

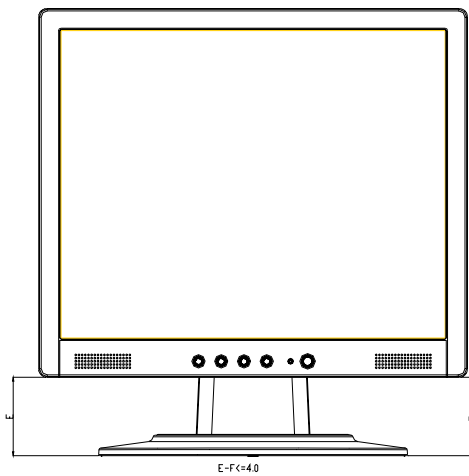

Tilt Base Rotation

Tilt up $15 \pm 2^\circ$ / down $5 \pm 2^\circ$

Plastic Material

For TCO99

Front Bezel PC+ABS

Back Cover PC+ABS

The Others ABS 94HB

For MPRII

Front Bezel ABS 94V-0

Back Cover ABS 94V-0

The Others ABS 94HB

GAP Spec.

Gap between panel with bezel is $0 \text{ mm} < \text{gap} < 1.2 \text{ mm}$

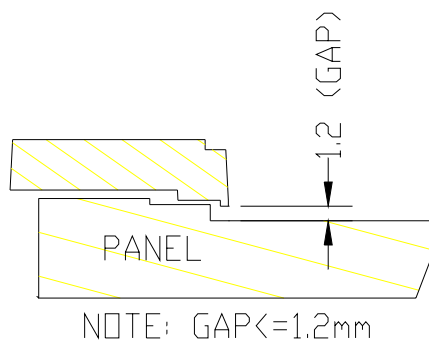

POWER/Inverter Board

Description

This specification defined the performance and characteristic of power/inverter board.

It supplies the following outputs :

- 1). 5Vdc: Logic power.
- 2). 5Vaudio: Audio power.
- 3). 15Vinv: Inverter power.

Features

Input Voltage: 100 ~ 240 \pm 10%Vac

Input current: 1.2Amax. at 90Vac

Input Frequency: 47 ~ 63Hz

Input power saving consumption: Less than 1.2W @ minimum load

Total output power: 60Wmax

Inverter brightness adjustment: Burst mode

Protection function: auto-recovery type

Interface Signals

Input

1. AC Inlet: HUAJIE SA-4S-066 or compatible.
2. J701: SC SCJ-0345-1-X-9 3.6D BLU 3P or compatible.

Output Connector & Pin Assignment:

1. The connector was pitch 2.0mm, cable length was 125mm.

PIN NO.	Function	Function
1	+5Vaudio	Audio power (optional).
2	GND	Audio ground
3	GND	Ground
4	GND	Ground
5	Vbri	Brightness control from logical board (0V to 3.3V)
6	----	-----
7	Ven	Inverter enable signal from logical board (high active , >3V)
8	+5Vdc	+5Vdc supply for logical board
9	+5Vdc	+5Vdc supply for logical board
10	+5Vdc	+5Vdc supply for logical board

2. Inverter-side connector : SM02B-BHSS-1-TB(JST) for AL1912 m

/ SM02(8.0)B-BHS-1(JST) for AR599 or equivalent.

PIN NO.	Function	Comment
1	Cth	VBLH(High voltage)
2	Ctl	VBLL(Low voltage)

Electrical Specification:

AC-DC Electrical specification

Input Specification

No	Item	Condition	Min.	Typ.	Max.	Unit
1	Input Voltage	----	100	---	240	Vac
2	Input Frequency	----	47	---	63	Hz
3	Input Current	----	---	---	1.0	Arms
4	Inrush Current	Cold Start @Vin=100Vrms	---	---	30	A _{0-P}
		Cold Start @Vin=240Vrms		---	50	A _{0-P}
5	Hold Up Time	@full load & 100Vac input	10	---	---	ms
6	Turn on time	Vin =110Vac	---	1.0	---	S
7	Efficiency	Full load	---	70	---	%
8	Consumption	Vin=240Vac,@ no load	---	---	1	W

AC-DC Output Specification

Output Voltage	Tolerance	Output Current		Voltage Tolerance
		MIN	MAX	
+5Vdc	+5 /-3 %	0.05A	1.5A	4.85~5.25V dc
+15Vinv	+35/-5 %	0A	2A	20~14.3Vdc
+5Vaudio	±5%	0A	0.6A	4.75~5.25Vdc
Ripple	1. Measured at DC output terminals which are paralleled with a 10uf Ecap & 0.1uf Ceramic cap. 2. Band width is limited within 20MHz.	---	1%	+5Vdc:50mVp-p +15Vinv:150mVp-p
Noise		---	3%	+5Vdc:150mVp-p +15Vinv:450mVp-p
Dynamic Load Regulation	50~100% or 100~50% load change of any DC output @50% duty of 1MHz (min.)	---	±5%	---
Over / Under Shoot	@ Power line on/off	---	±5%	---

*+5Vdc load regulation test: the +15Vinv loading at 2.0A

*+15Vinv load regulation test: the +5Vdc loading at 1.5A

Protection function

- 1) SCP: Short circuit protection must be acted on both outputs
- 2) OPP: Should be protected when output power consumption is within 60W ~ 75W

Inverter Electrical Specification:

For Fujitsu FLC488SC8V-10 (AL1912 m)

	Condition	Min.	Typ.	Max.	Unit
Input Voltage	---	---	15	---	V
Input Current	---	---	1.5	---	A
Backlight ON/OFF Control	ON		3.3		V
	OFF		0		V
Brightness Adjust	Min. Luminance / Max. Luminance	---	30%	---	---
Output Voltage	Vin=15V, Iout=6.5mA	---	750	---	Vrms
Brightness	lamp current in 6.5mA	250	300		Cd/m ²
Output Current(Each connector)	Vbri=0.4V~3.3V	4	7	8	mA
Frequency	---	40	50	60	KHz
Lamp start voltage	@0°C	1600	---	---	Vrms
Striking Time	---		1	---	S
Lamp Current Balance	---	---	±0.3	---	mA
Efficiency	Vin=15V	---	80	---	%
Operating Life Time	---	50000	---	---	Hr

*.The open lamp voltage is testes at output connector terminal

SAFETY

Leakage Current: 0.25mA @ 100Vac

Insulation Resistance: more than 3M ohms while withstanding a voltage of 500Vac

Hi-Pot: 3Kvac with using 3mA cut off current

Power Consumption

The monitor is equipped with a power-management according to the below.

There is a delay of 5s ... 7s before the transition from On-state to any power saving state to avoid unintentionally entering of a power saving stage during display resolution and timing mode changes.

Transition from any power saving state to another can be instantaneous.

The recovery from Off-state requires no manual power on.

Mode	H-Sync.	V-Sync.	Video	Pw-cons.	Indicator	Rec. time*
Power-On	on	on	active	< 60W	Green LED	--
Power-off	off	off	blanked	< 3 W	Orange LED	< 5S
Switch-off				< 3 W	Dark LED	

SYNC. On means: Normal operation

SYNC. Off means: H sync. F < 10KHz duty cycle > 25%

V sync. F < 10Hz duty cycle > 25%

CONNECTORS / CONTROLS

Connectors

- Power : Monitor rear side : AC Inlet
- Analog RGB : Monitor rear side / Data Cable : 15-pin D-sub female / male

Pin – Assignment of 15-pin D-sub:

1	Red Video	9	+5V FOR DDC
2	Green Video	10	Detect
3	Blue Video	11	Serial Data for ISP
4	Serial Clock for ISP	12	Serial Data for DDC
5	Ground	13	H-Sync.
6	Red Ground	14	V-Sync.
7	Green Ground	15	Serial Clock for DDC
8	Blue Ground		

- Audio : Monitor rear side :
-PC I/P for PC : 3.5mm Stereo female

Monitor Control Keys

KEY : Power , Menu , Adjust +/- , Vol +/-, Auto

Position Of Controls

Position of all switches : Bottom side of front bezel

Position of LED : Bottom side of front bezel

Chapter 2

Operating Instructions

CONTROLS

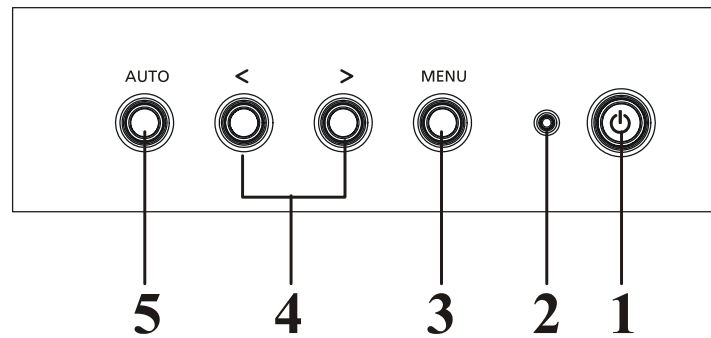

Control panel (monitor front panel)

1. Power ON/OFF switch, push to ON and push to OFF. (Toggle switch)
2. Power LED will be blue when monitor is on; be amber when in power saving mode.
3. Menu.
4. Adjust increase (Function select).
Adjust decrease (Function select).
5. Auto adjustment Buttons.

Note:

1. Press button 4 (plus +) or (minus -) at the same time can activate "Volume Adjustment".
2. When OSD Menu is off, press button 5 (auto) at the same time can activate "Auto Adjustment" immediately.
3. When into Factory mode press 4 (plus +),(minus -) and 1 (power) together 2 seconds at same time.
5. When into Burning mode press 5 (menus), 1 (power) together 2 second at same time.













Main OSD Menu:

Outline:



The description for control function :

Main Menu Icon	Sub Menu Item	Sub Menu Icon	Description	Adjustment Range	Reset Value
	Contrast		Contrast from Digital-register.	0-100	Recall Cool Contrast Value
	Brightness		Backlight Adjustment	0-100	Recall Cool Brightness Value
	Focus		Adjust Picture Phase to reduce Horizontal-Line noise	0-100	Do Auto Config
	Clock		Adjust picture Clock to reduce Vertical-Line noise.	0-100	Do Auto Config
	H. Position		Adjust the horizontal position of the picture.	0-100	Do Auto Config
	V. Position		Adjust the vertical position of the picture.	0-100	Do Auto Config
	Warm	N/A	Recall Warm Color Temperature from EEPROM.	N/A	The Color Temperature will be set to Cool.
	Cool	N/A	Recall Cool Color Temperature from EEPROM.	N/A	

	User / Red		Red Gain from Digital-register.	0-100	100
	User / Green		Green Gain Digital-register.	0-100	100
	User / Blue		Blue Gain from Digital-register.	0-100	100
	English	N/A	Set OSD display language to English.	N/A	The Language will be set to English.
	繁體中文	N/A	Set OSD display language to Traditional Chinese.	N/A	
	Deutsch	N/A	Set OSD display language to German.	N/A	
	Français	N/A	Set OSD display language to French.	N/A	
	Español	N/A	Set OSD display language to Spain.	N/A	
	Italiano	N/A	Set OSD display language to Italian.	N/A	
	简体中文	N/A	Set OSD display language to Simplified Chinese.	N/A	
	日本語	N/A	Set OSD display language to Japanese.	N/A	
	H. Position		Adjust the horizontal position of the OSD.	0-100	50
	V. Position		Adjust the vertical position of the OSD.	0-100	50
	OSD Timeout		Adjust the OSD timeout.	10-120	10
	Auto Config	N/A	Auto Adjust the H/V Position, Focus and Clock of picture.	N/A	N/A
	Information	N/A	Show the resolution, H/V frequency and input port of current input timing.	N/A	N/A
	Reset	N/A	Clear each old status of Auto-configuration and set the color temperature to Cool.	N/A	N/A
	Exit	N/A	Exit OSD	N/A	N/A

Hot-Key Menu:(For AL1912 m only)

Outline:

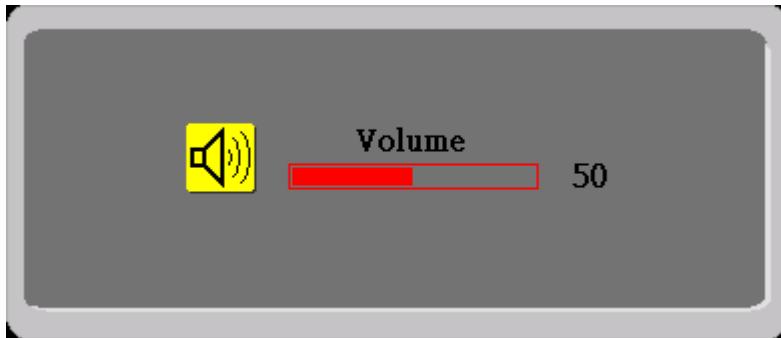

The description for Hot-Key function :

Item	Operation	Icon	Description	Adjustment Range	Reset Value
Volume	When the OSD is closed, press Left or Right button will be Volume Hot-Key Function		Volume of Audio adjustment. The Audio will be Mute when volume=0.	0-100	50

OSD Message:

Outline:



The description for OSD Message :

Item	Description
Auto Config Please Wait	When User Press Hot-Key "Auto", will show this message, and the monitor do the auto config function.
Input Not Supported	When the Hsync Frequency, Vsync Frequency or Resolution is out of the monitor support range, will show this message. This message will be flying.
Cable Not Connected	When the video cable is not connected, will show this message. This message will be flying.
No Signal	When the video cable is connected, but the is no active signal input, will show this message, then enter power saving.

LOGO:

When the monitor is power on, the LOGO will be showed in the center.



Item of Factory menu

Vendor may customize design and add adjustment items Factory menu as far as all required items are included.

1) Bright

Adjust Brightness and Contrast value to Max.

2) Auto Balance

Adjust each R, G, B contrast (gain) and offset.

Method of auto adjust is depends on hardware.

Adjusted value of R, G, B gain shall be used for initial value of Contrast in user menu.

All value shall be adjustable manually.

This function shall be located in 3. tag of Factory menu.

3) Factory color temp data edit

Following data for color temp shall be editable manually.

-color temp default preset No.

Plug and play

Plug & play DDC2B feature

This monitor is equipped with VESA DDC2B capabilities according to the VESA DDC STANDARD. It allows the monitor to inform the host system of its identity and, depending on the level of DDC used, communicate additional information about its display capabilities. The communication channel is defined in two levels, DDC2B.

The DDC2B is a bidirectional data channel based on the I²C protocol. The host can request EDID information over the DDC2B channel.

THIS MONITOR WILL APPEAR TO BE NON-FUNCTIONAL IF THERE IS NO VIDEO INPUT SIGNAL. IN ORDER FOR THIS MONITOR TO OPERATE PROPERLY, THERE MUST BE A VIDEO INPUT SIGNAL.

This monitor meets the Green monitor standards as set by the Video Electronics Standards Association (VESA) and/or the United States Environmental Protection Agency (EPA) and The Swedish Confederation Employees (NUTEK). This feature is designed to conserve electrical energy by reducing power consumption when there is no video-input signal present. When there is no video input signal this monitor, following a time-out period, will automatically switch to an OFF mode. This reduces the monitor's internal power supply consumption. After the video input signal is restored, full power is restored and the display is automatically redrawn. The appearance is similar to a "Screen Saver" feature except the display is completely off. The display is restored by pressing a key on the keyboard, or clicking the mouse.

Using The Right Power Cord

The accessory power cord for the Northern American region is the wallet plug with NEMA 5-15 style and is UL listed and CSA labeled. The voltage rating for the power cord shall be 125 volt AC.

Supplied with units intended for connection to power outlet of personal computer: Please use a cord set consisting of a minimum No. 18 AWG, type SJT or SVT three conductors flexible cord. One end terminates with a grounding type attachment plug, rated 10A, 250V, CEE-22 male configuration. The other end terminates with a molded-on type connector body, rated 10A, 250V, having standard CEE-22 female configuration.

Please note that power supply card needs to use VDE 0602, 0625, 0821 approval power cord in European countries.

White Color Temperature

White color temperature is 4 preset as 9300, 7500,6500 and User,
 Default value of user color should be user which is maximum setting for panel.

Target of color setting

Color Temp.	Color Coordinate		Tolerance	Color Coordinate		Tolerance
	x	y		u'	v'	
9300K	0.283	0.297	± 0.03	0.189	0.446	$u'v' \leq 0.01^*$
6500K	0.313	0.329	± 0.03	0.198	0.469	$u'v' \leq 0.01^*$
User	-	-		-	-	-

*) TCO'0X A.2.6.1 requirement

User should follow "Microsoft Windows Color Quality Specification for Liquid Crystal Display OEM's".
 (<http://www.microsoft.com/hwdev/tech/color/ColorTest.asp>)

Audio Technical specification (For AL1912 m only)

General Description:

- Output power : 1W + 1W maximum
- Total harmonic distortion : Less than 1 % (except speakers distortion)
- Input signal sensitivity : 0.5 Vrms for full output
- Input impedance : 47 Kohm +/- 5 %
- Frequency response range : 20Hz – 20kHz (except speakers response)
- Difference of L and R output : Less than 2 dB

Electrical characteristics (Tamb=25°)

Audio amplifier(USE Panasonic VP-7723A Audio Analyzer.)

Item	Audio Input	Freq.	Spec.			Comment
			Min.	Typ.	Max.	
Input Voltage(V)			-	0.5Vrms	-	
Input Current(m A)			-	500	800	
Audio Voltage Gain	500m Vrms	1KHz	-	-	6 d B	Volume Max.,load 4 Ω
Frequency Response	500m Vrms	300Hz-20KHz	-10dB	-	+10d B	Volume Max.,load 4 Ω
Signal to Noise ratio	500m Vrms	1KHz	-	-	-40dB	Volume Max.,load 4 Ω
Total harmonic distortion	500m Vrms	1KHz			1%	except speakers distortion
Cross talk	500m Vrms	1KHz	-	-	-30dB	Volume Max.,load 4 Ω
Output Watt.	500m Vrms	1KHz	-	-	0.5W	Volume Max.,load 4 Ω
Volume Control			-	-	-	Analog

Speakers

- Maximum power : 2 W per speaker(max)
- Impedance : 4 ohm +/- 15 % @ 1kHz 1.0Hz
- Frequency response range : 300 Hz – 20 kHz (S.P.L. – 10 dB)
- Total harmonic distortion : Less than 5 % @ 0.125 W 1kHz

Machine Disassembly and Replacement

Disassembly Procedure

Disassemble the base

1. Remove the neck cover.
2. Remove the four screws to release the hinge.
3. Remove the base

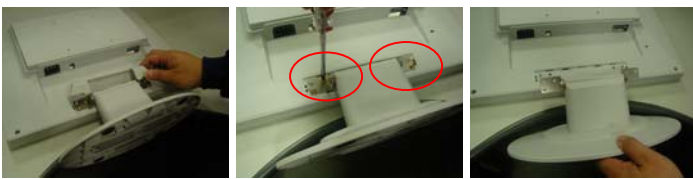

Disassemble the chassis

1. Remove the four screws to release the back cover.
2. Remove the two screws to release the EMI cover from chassis.
3. Remove the two screws from VGA connector.
4. Then take the chassis.
5. Remove the two screws from bezel.
6. To separate the chassis and bezel.
7. Remove the four screws from chassis and release the panel.

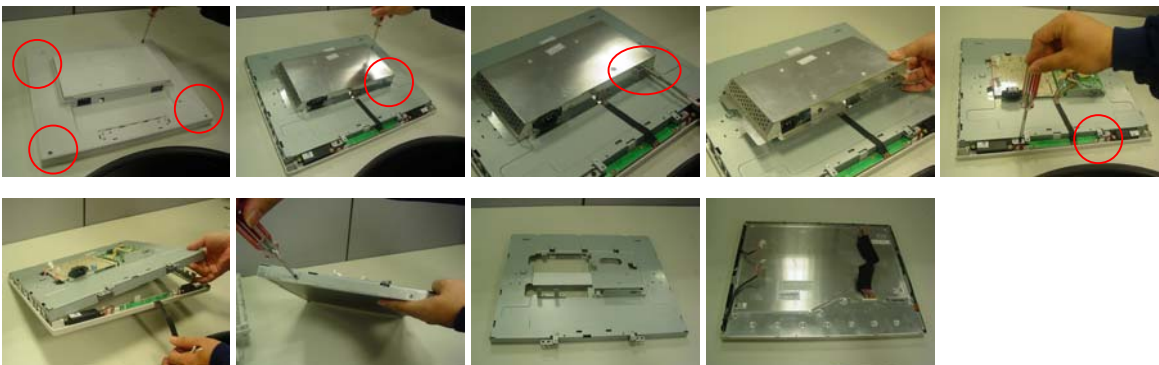

Disassemble the main board

1. Disassemble audio line from power board.
2. Disassemble two VL-VK lines from VL board.
3. Disassemble power line from VL board.
4. Disassemble FPC line from VL board.
5. Remove the one screw to release line from Chassis.
6. Remove the three screws from Chassis and release the main board.

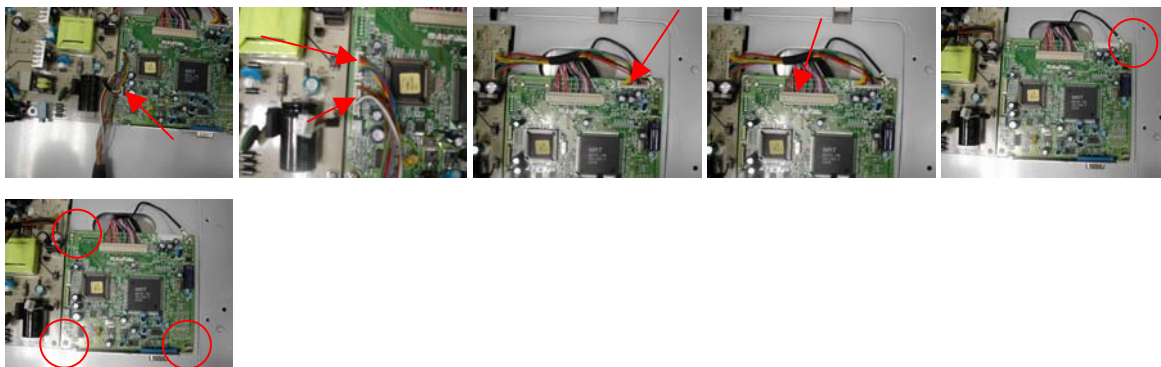

Disassemble the power board

1. Disassemble two voltage lines from power board.
2. Remove the one screw to release line from Chassis.
3. Remove the three screws from Chassis.
4. Remove the two screws to release power board from Chassis.
5. Then take the power board from the chassia.

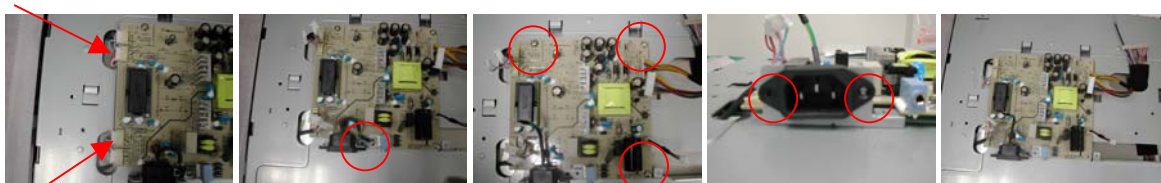

Disassemble the key board

1. Remove the one screw to release VK board from bezel.
2. Disassemble the two speaker lines from VK board.



Disassemble the speakers

1. Remove the two screws to release line and VK board from bezel.
2. Remove the two screws to release line and chassis from bezel.
3. Remove the four screws from bezel.

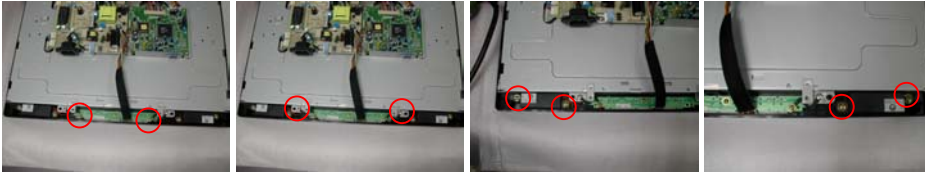

Troubleshooting

Main Procedure

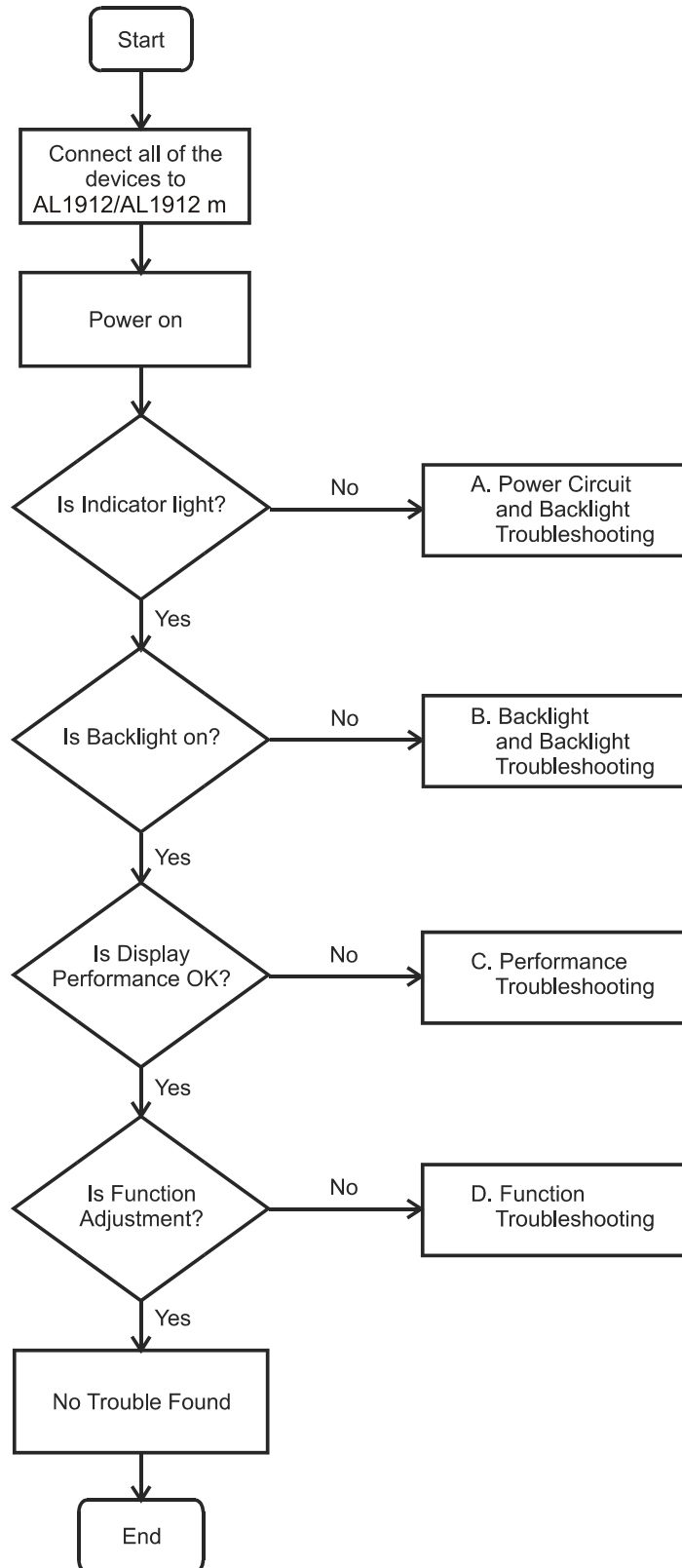

Power Circuit and Backlights Troubleshooting

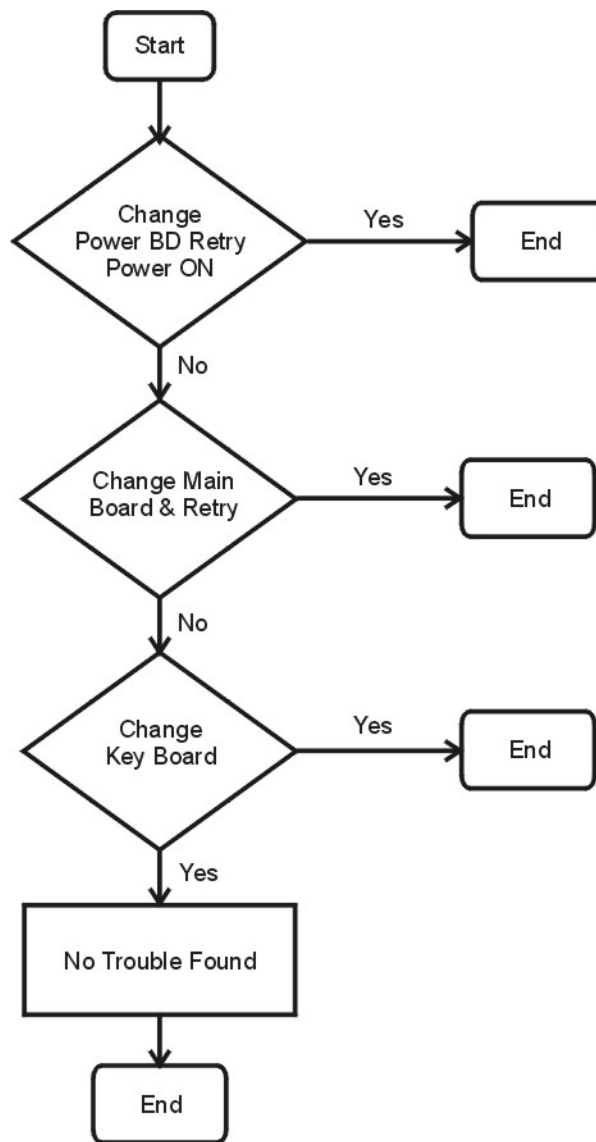

Performance Troubleshooting

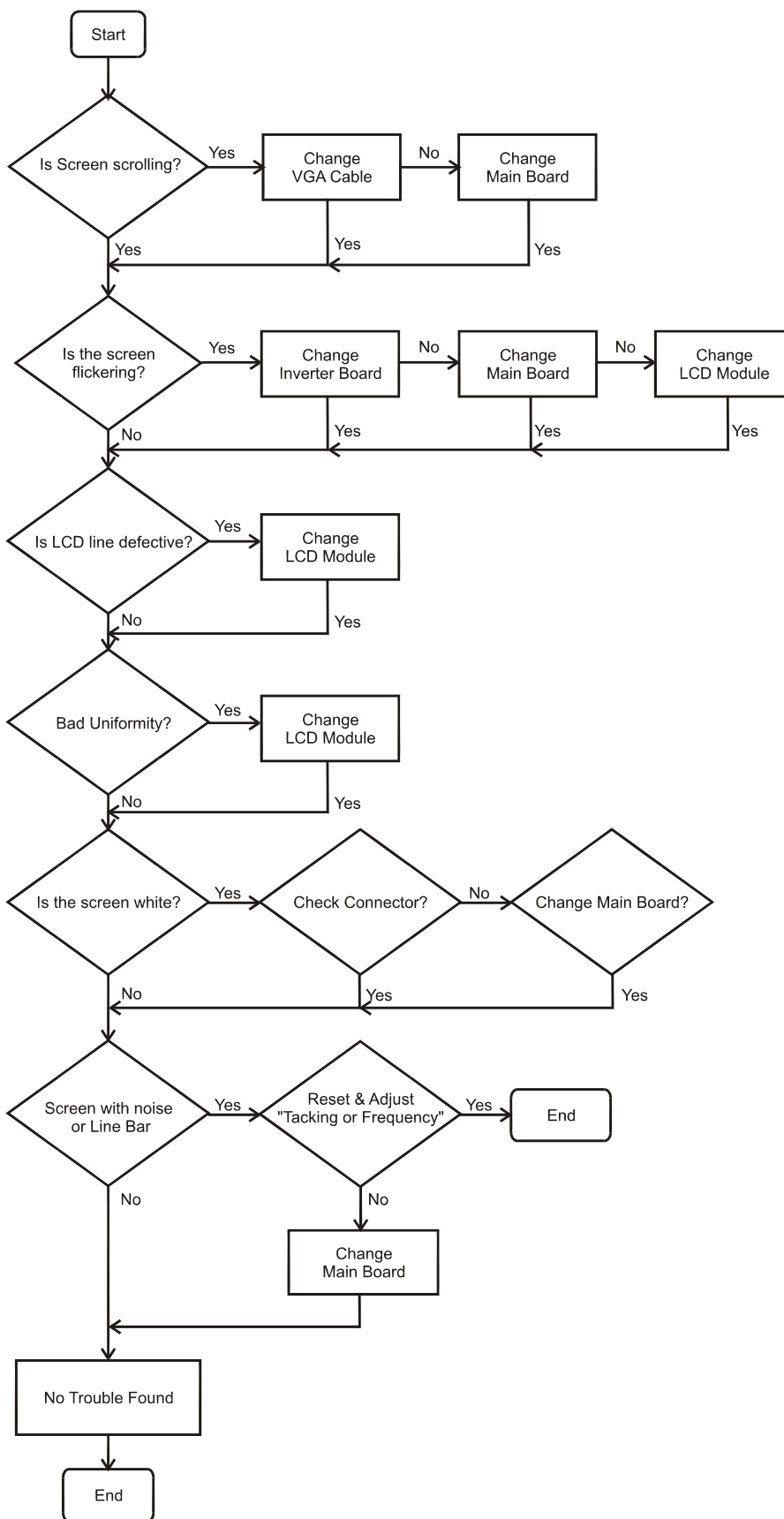

Function Troubleshooting

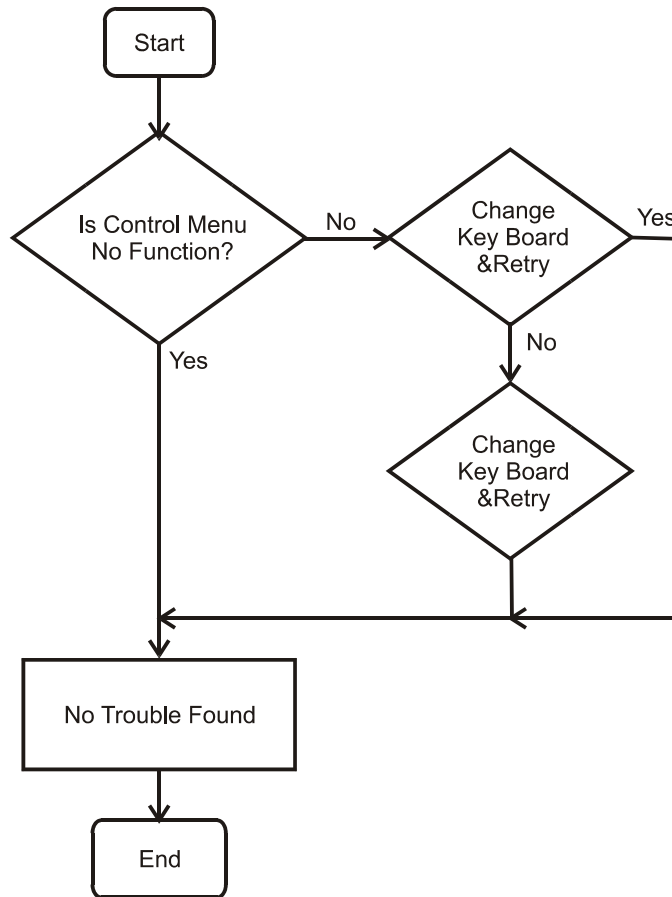

Connector Information

Phonejack stereo

PIN1. right : CEE22 typed connector

PIN2. Left

PIN3. Gnd : Line-in receptacle

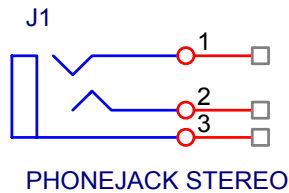

Video input Connector

Analog Video input Connector: 15pins mini D-Sub

Table 2.4.5. Pin assignment for D-sub connector

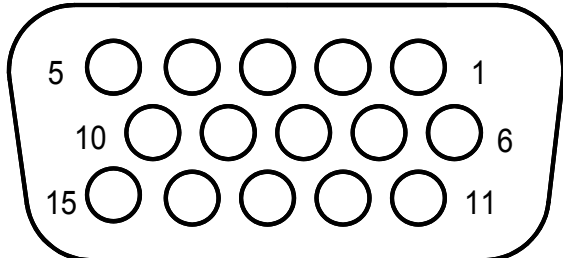

PIN NO.	Separate Sync
1	RED VIDEO
2	GREEN VIDEO
3	BLUE VIDEO
4	GROUND
5	GROUND
6	RED GROUND
7	GREEN GROUND
8	BLUE GROUND
9	PC5V (+5V DDC)
10	CABLE DETECTION
11	GROUND
12	SDA
13	H.SYNC
14	V.SYNC
15	SCL

FRU (Field Replaceable Unit) list

This chapter gives you the FRU (Field Replaceable Unit) listing in global configurations of AL1912 m. Refer to this chapter whenever ordering for parts to repair or for RMA (Return Merchandise Authorization).

NOTE : Please note WHEN ORDERING FRU PARTS, that you should check the most up-to-date information available on your regional web or channel(<http://aicsl.acer.com.tw/spl/>). For whatever reasons a part number change is made, it will not be noted in the printed Service Guide. For ACER-AUTHORIZED SERVICE PROVIDERS, your Acer office may have a DIFFERENT part number code to those given in the FRU list of this printed Service Guide. You MUST use the local FRU list provided by your regional Acer office to order FRU parts repair and service of customer machines.

NOTE: To scrap or to return the defective parts, you should follow the local government ordinance or regulations on how best to dispose it, or follow the rules set by your regional Acer office on how to return it.



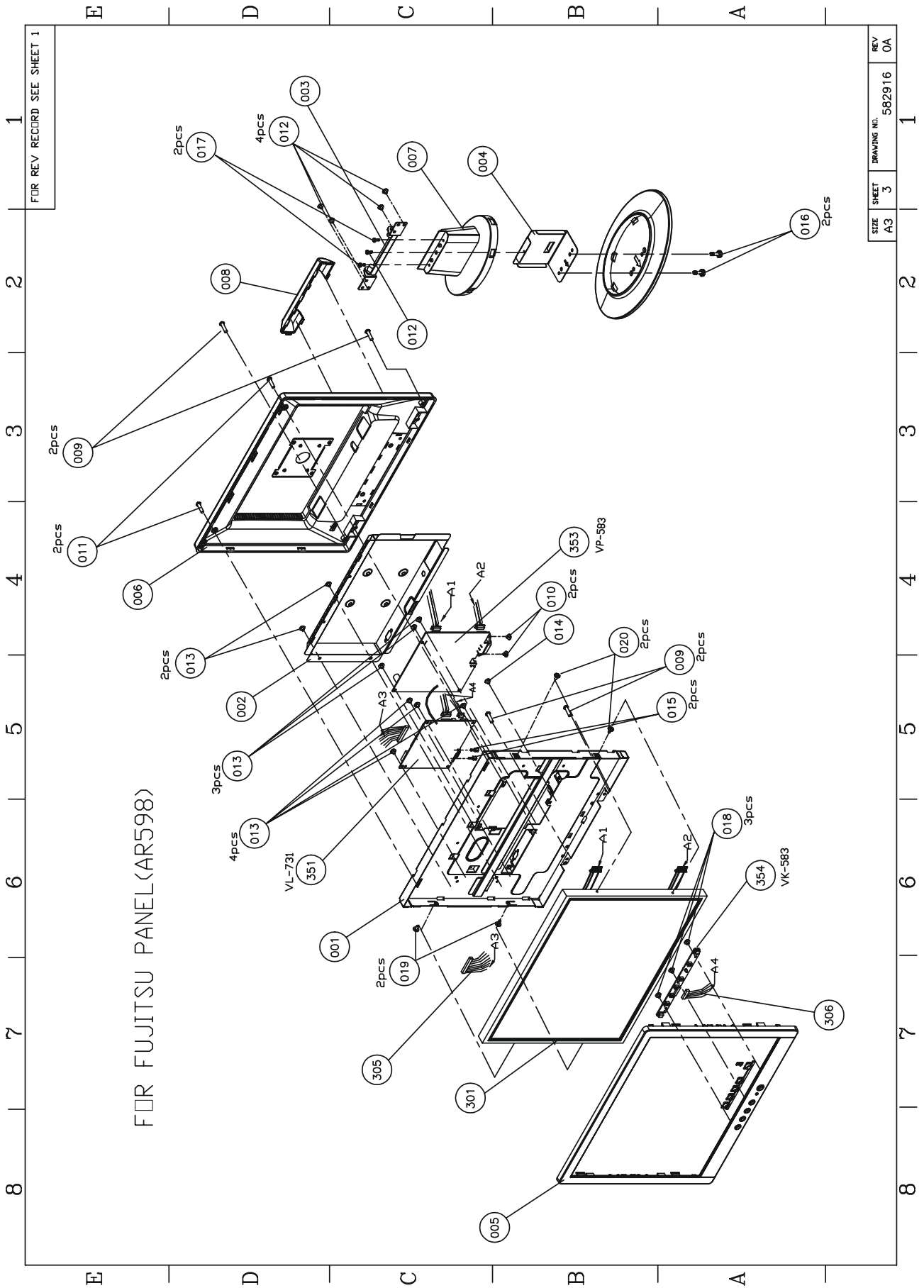



Model: AL1912



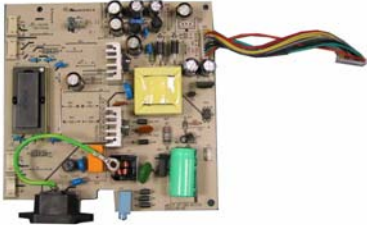

SIZE	SHEET	DRAWING N.L.	REV
A3	3	582916	0A

Part list

No.	Photo	Part Name	Part No.
1		Hinge Cover	FAAR7721000
2		Base Assy	FAAR9913A00
3		Rear Cover	FAAR9912000
4		Base	FAAR9913000
6		Neck	FAAR7713000
7		Main Shield	ECAR9914A00
8		MB	DA2P577V012

9		Power Board to MB cable	599: 453AAP30021 598: 453AAP30031
10		Inverter Board	599: 453AAP30021 598: 453AAP30031
11		Front Bezel	FAAR9911A00
12		Keyboard to MB Cable	599: DCO20162300 598: DCO20162500
13		Speaker-R	CG10021V900
14		Speaker-L	CG19921V910
15		Frame	ECAR9915A00
16		LCD (R)	AC6VF190010

17		Panel to MB cable	DC020162600
18		Function Board	599: 454AAPE0001 598: 454AAP30011

Schematic Diagram

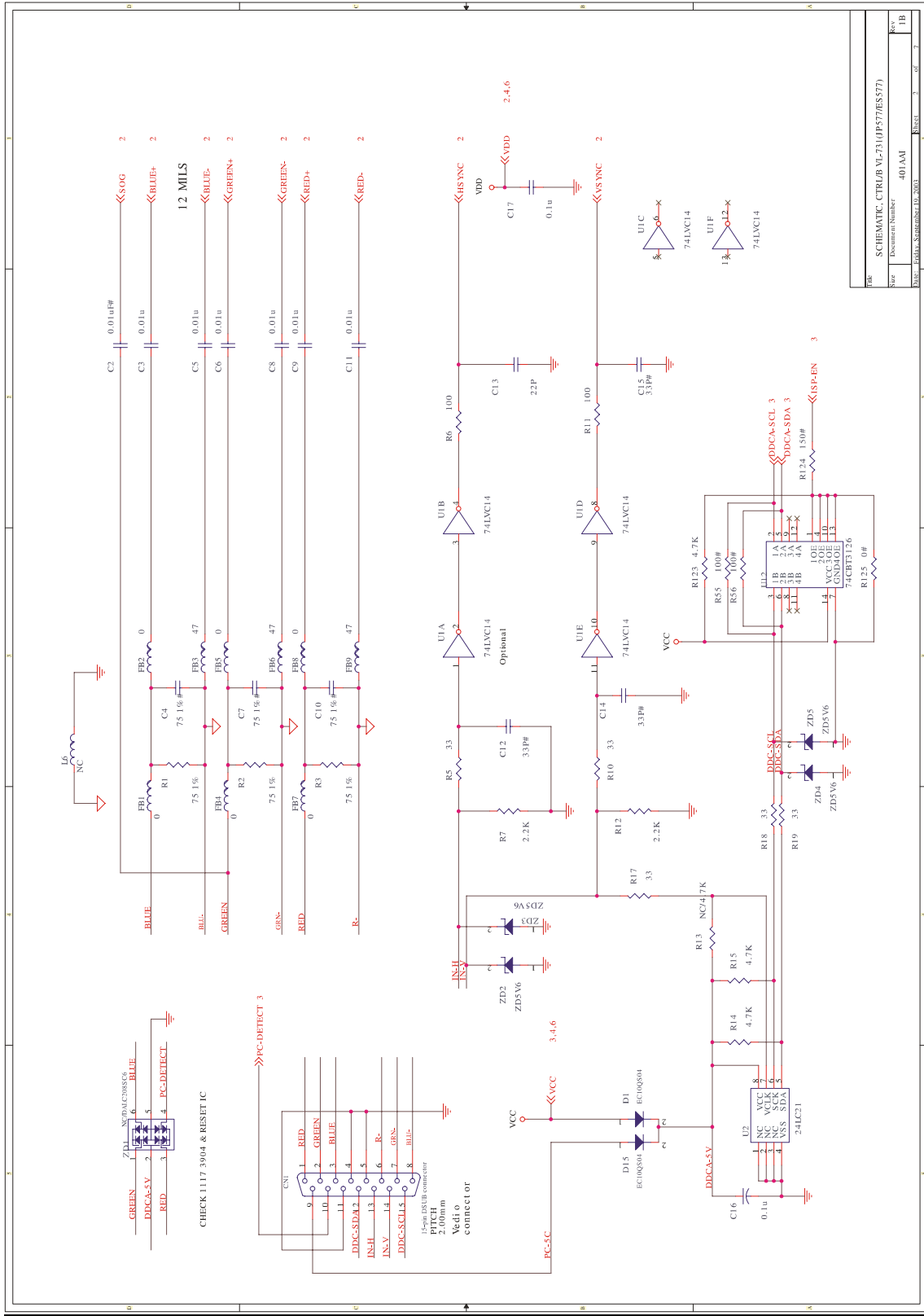

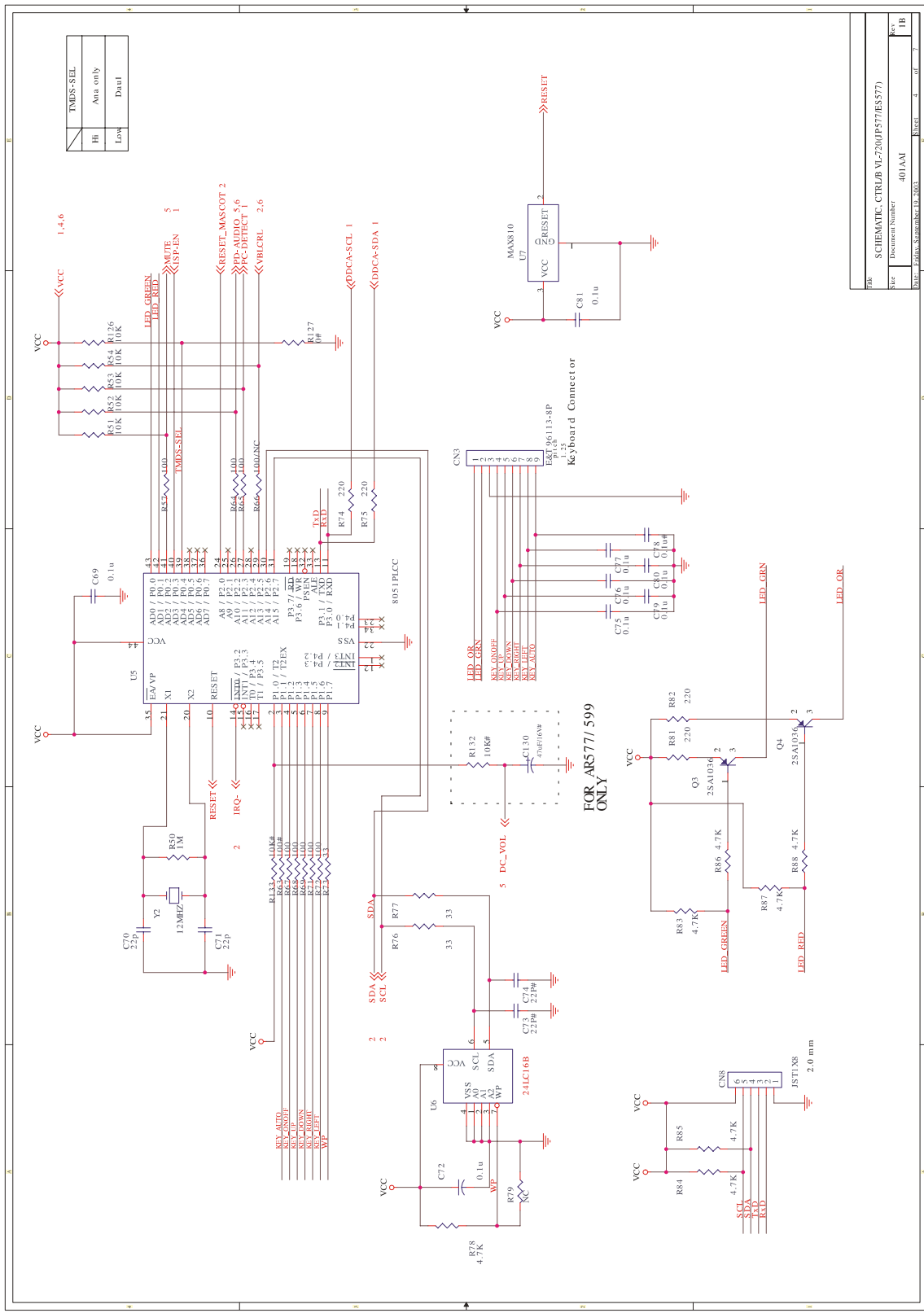

File	SCHEMATIC_CTRLUB_VL7300(P577/599)					
Sheet	Description Number 401AA1					
Rev	1	2	3	4	5	6
Date	Rev. 1.0, 2003					

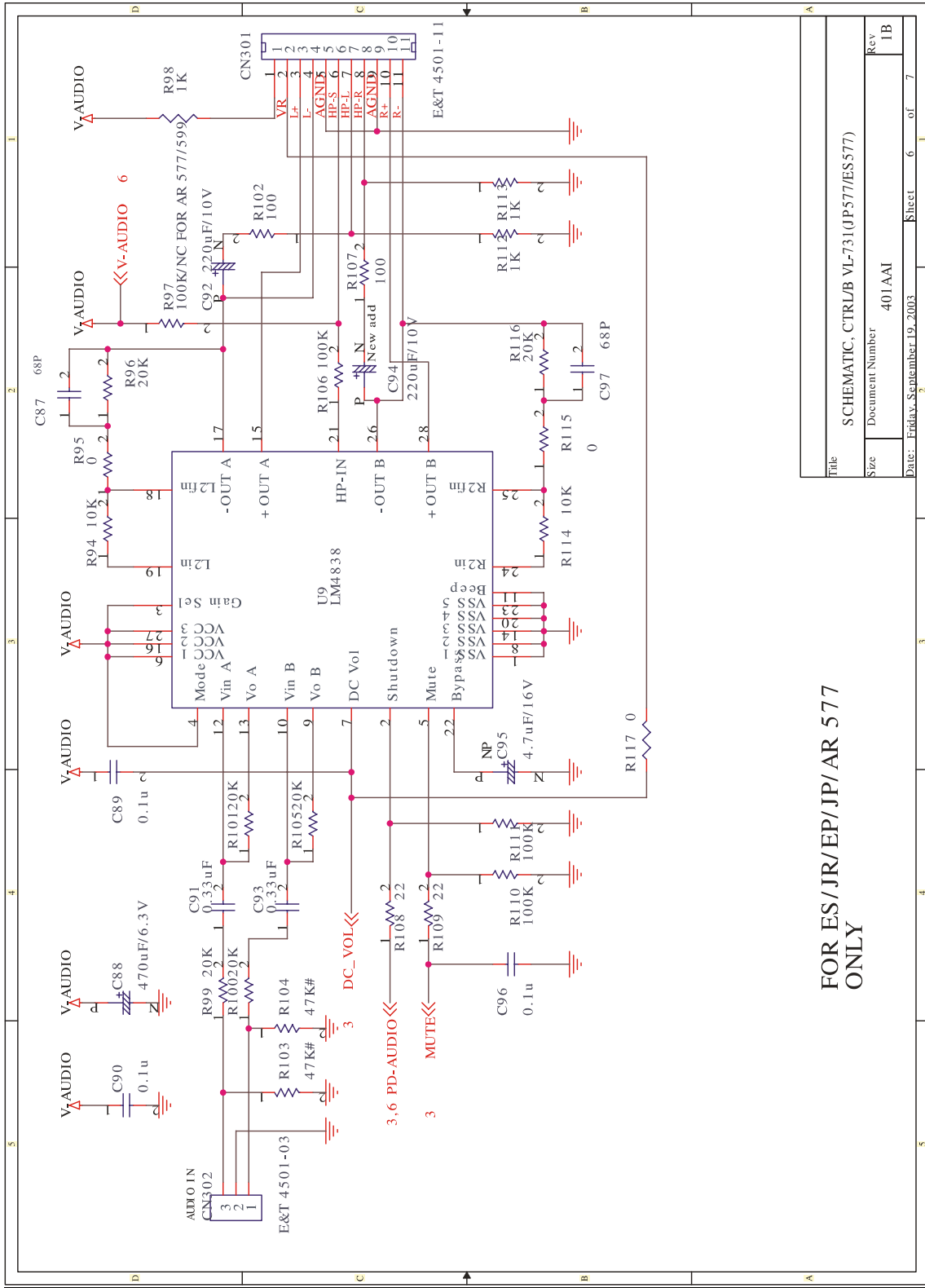

FOR ES/JR/EP/JP/AR 577
ONLY

Title	SCHEMATIC, CTRL/B VL-731(OP577/ES577)	
Size	Document Number	401AAI
Date:	Friday, September 19, 2003	Sheet 6 of 7
Rev	1B	

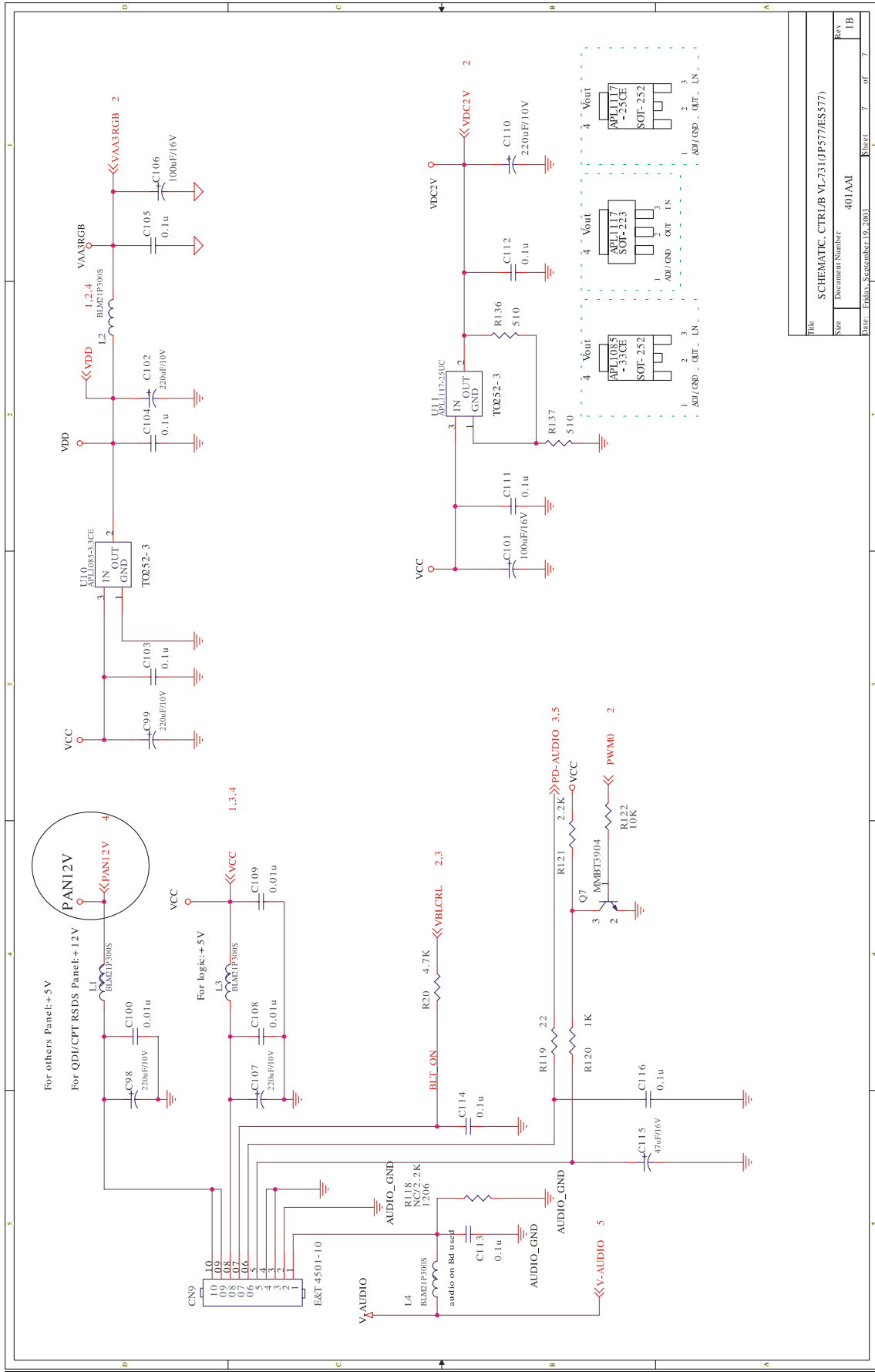

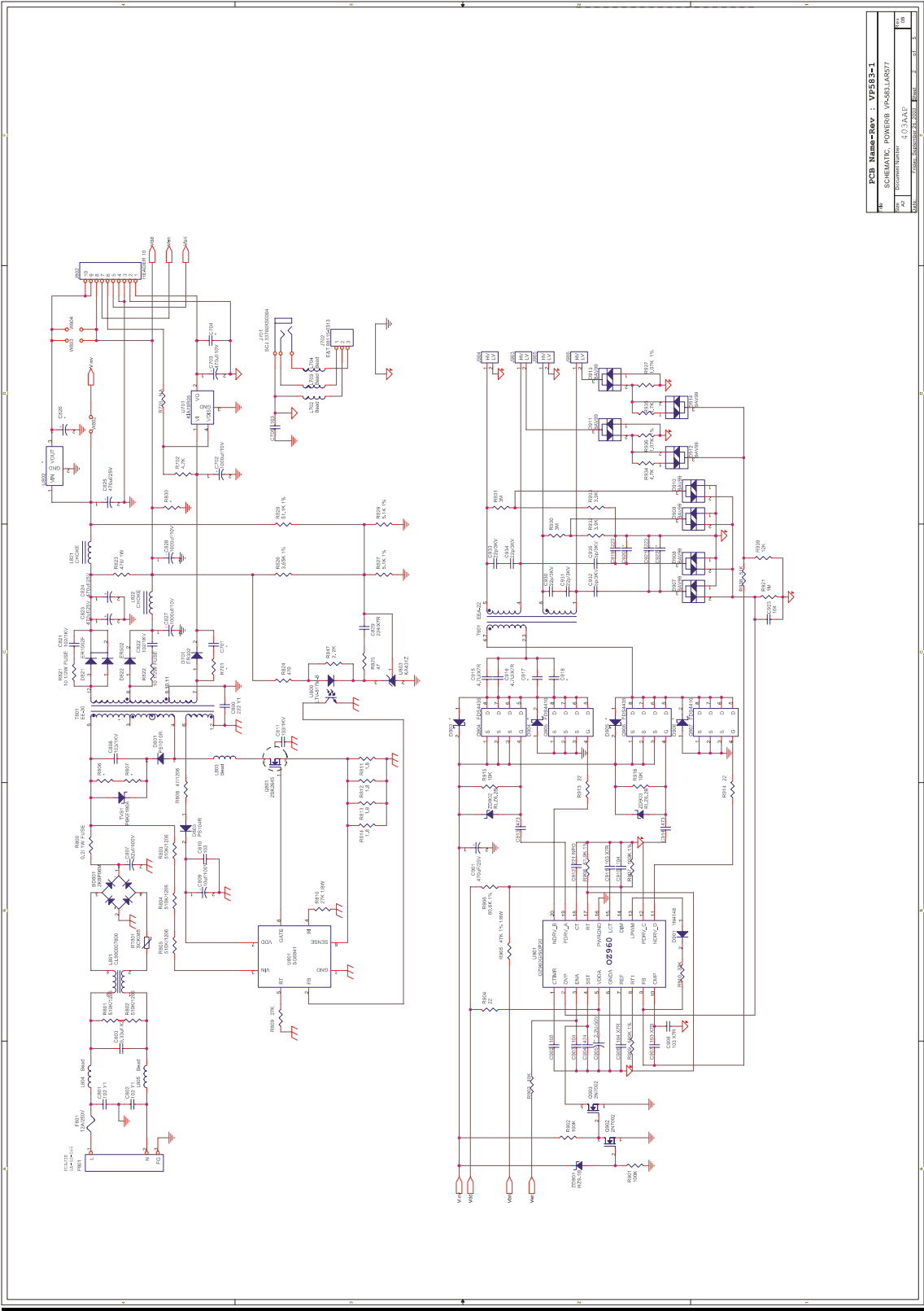

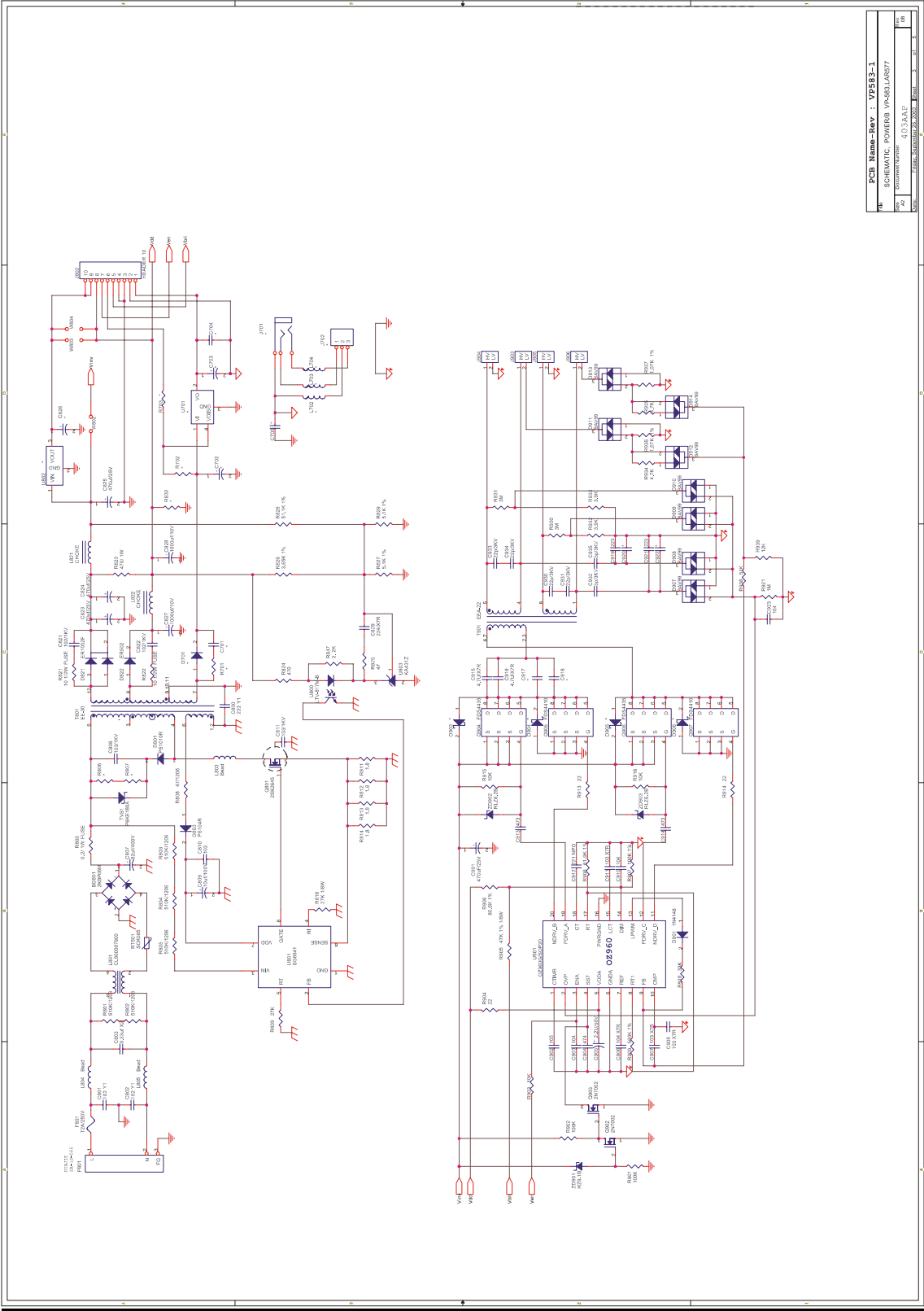

PCB Name-Rev :	VZ563-1
Doc :	SCHEMATIC_POWER08_VZ481L0807
Rev :	1.0
Author :	...
Check :	...
Date :	...

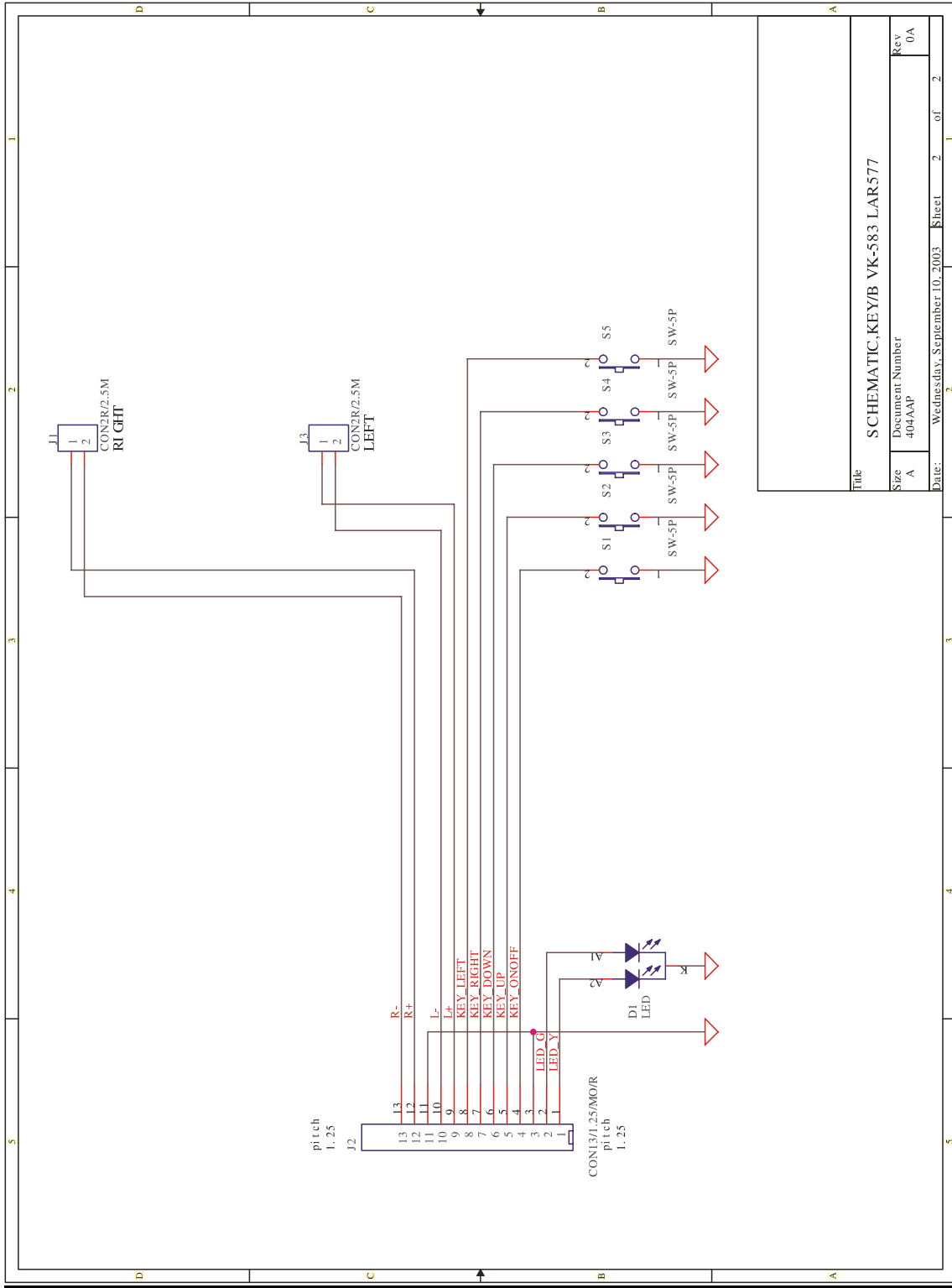

Title		SCHEMATIC KEY/B VK-583 LAR577	
Size	A	Document Number	404AAP
Date:	Wednesday, September 10, 2003	Sheet	2 of 2
Rev	0A		

Free Manuals Download Website

<http://myh66.com>

<http://usermanuals.us>

<http://www.somanuals.com>

<http://www.4manuals.cc>

<http://www.manual-lib.com>

<http://www.404manual.com>

<http://www.luxmanual.com>

<http://aubethermostatmanual.com>

Golf course search by state

<http://golfingnear.com>

Email search by domain

<http://emailbydomain.com>

Auto manuals search

<http://auto.somanuals.com>

TV manuals search

<http://tv.somanuals.com>