

# Acer Projector

X115/X117/X115AH/X117AH/X115H/X117H/X125H/  
X127H/X135WH/X137WH/X1185G/X1185PG/X1285G/  
X1285PG/H6517ABD/H6519ABD/  
D602/D604/D602B/D604B/D602D/D604D/D612D/D614D/  
D622D/D624D/X1184G/X1184PG/X1284G/X1284PG/  
E145F/  
EV-S62/EV-S64/EV-S62A/EV-S64A/EV-S62H/EV-S64H/  
EV-X62H/EV-X64H/EV-W62H/EV-W64H/HE-801K/  
V31S/V33S/V30S/V34S/V32S/V35S/V32X/V35X/V32W/  
V35W/  
AS304/AS307/AS313/AS317/AS314/AS318/AX314/AX314/  
AX318/AW314/AW318/  
D600+/D605/D600H+/D605H/D600D+/D605D/D610D+/  
D615D/D620D+/D625D/  
X114P/X114AH/X114PH/X124PH/X134PWH/  
R602/R604/R602D/R604D/R602H/R604H/R612H/R614H/  
R622H/R624H/  
KS304/KS305/KS314A/KS315A/KS314/KS315/KX314/  
KX315/KW314/KW315/  
ES-12/ES-13/ES-12D/ES-13D/ES-12H/ES-13H/EX-12H/  
EX-13H/EW-12H/EW-13H/  
B102/B103/B102H/B103H/B102D/B103D/B112D/B113D/  
B122D/B122D/B123D Series

## User's Guide

Copyright © 2016. Acer Incorporated.  
All Rights Reserved.

Acer Projector User's Guide  
Original Issue: 03/2016

Changes may be made periodically to the information in this publication without obligation to notify any person of such revisions or changes. Such changes will be incorporated in new editions of this manual or supplementary documents and publications. This company makes no representations or warranties, either expressed or implied, with respect to the contents hereof and specifically disclaims the implied warranties of merchantability or fitness for a particular purpose.

Record the model number, serial number, purchase date and place of purchase information in the space provided below. The serial number and model number are recorded on the label affixed to your projector. All correspondence concerning your unit should include the serial number, model number and purchase information.

No part of this publication may be reproduced, stored in a retrieval system, or transmitted, in any form or by any means, electronically, mechanically, by photocopy, recording or otherwise, without the prior written permission of Acer Incorporated.

Model number: \_\_\_\_\_

Serial number: \_\_\_\_\_

Date of purchase: \_\_\_\_\_

Place of purchase: \_\_\_\_\_

"HDMI™, the HDMI logo and High-Definition Multimedia Interface are trademarks or registered trademarks of HDMI Licensing LLC."



# Information for your safety and comfort

Read these instructions carefully. Keep this document for future reference. Follow all warnings and instructions marked on the product.

## Turning the product off before cleaning

Unplug this product from the wall outlet before cleaning. Do not use liquid cleaners or aerosol cleaners. Use a damp cloth for cleaning.

## Caution for plug as disconnecting device

Observe the following guidelines when connecting and disconnecting power to the external power supply unit:

- Install the power supply unit before connecting the power cord to the AC power outlet.
- Unplug the power cord before removing the power supply unit from the projector.
- If the system has multiple sources of power, disconnect power from the system by unplugging all power cords from the power supplies.

## Caution for Accessibility

Be sure that the power outlet you plug the power cord into is easily accessible and located as close to the equipment operator as possible. When you need to disconnect power to the equipment, be sure to unplug the power cord from the electrical outlet.



### Warnings!

- Do not use this product near water.
- Do not place this product on an unstable cart, stand or table. If the product falls, it could be seriously damaged.
- Slots and openings are provided for ventilation to ensure reliable operation of the product and to protect it from overheating. These openings must not be blocked or covered. The openings should never be blocked by placing the product on a bed, sofa, rug or other similar surface.

This product should never be placed near or over a radiator or heat register, or in a built-in installation unless proper ventilation is provided.

- Never push objects of any kind into this product through cabinet slots as they may touch dangerous voltage points or short-out parts that could result in a fire or electric shock. Never spill liquid of any kind onto or into the product.

- To avoid damage of internal components and to prevent battery leakage, do not place the product on a vibrating surface.
- Never use it under sporting, exercising, or any vibrating environment which will probably cause unexpected short current or damage rotor devices, lamp.

## Using electrical power

- This product should be operated from the type of power indicated on the marking label. If you are not sure of the type of power available, consult your dealer or local power company.
- Do not allow anything to rest on the power cord. Do not locate this product where people will walk on the cord.
- If an extension cord is used with this product, make sure that the total ampere rating of the equipment plugged into the extension cord does not exceed the extension cord ampere rating. Also, make sure that the total rating of all products plugged into the wall outlet does not exceed the fuse rating.
- Do not overload a power outlet, strip or receptacle by plugging in too many devices. The overall system load must not exceed 80% of the branch circuit rating. If power strips are used, the load should not exceed 80% of the power strip's input rating.
- This product's AC adapter is equipped with a three-wire grounded plug. The plug only fits in a grounded power outlet. Make sure the power outlet is properly grounded before inserting the AC adapter plug. Do not insert the plug into a non-grounded power outlet. Contact your electrician for details.



.....

**Warning!** The grounding pin is a safety feature. Using a power outlet that is not properly grounded may result in electric shock and/or injury.



.....

**Note:** The grounding pin also provides good protection from unexpected noise produced by other nearby electrical devices that may interfere with the performance of this product.

- Use the product only with the supplied power supply cord set. If you need to replace the power cord set, make sure that the new power cord meets the following requirements: detachable type, UL listed/CSA certified, VDE approved or its equivalent, 4.5 meters (15 feet) maximum length.

## Product servicing

Do not attempt to service this product yourself, as opening or removing covers may expose you to dangerous voltage points or other risks. Refer all servicing to qualified service personnel.

Unplug this product from the wall outlet and refer servicing to qualified service personnel when:

- the power cord or plug is damaged, cut or frayed
- liquid was spilled into the product
- the product was exposed to rain or water
- the product has been dropped or the case has been damaged
- the product exhibits a distinct change in performance, indicating a need for service
- the product does not operate normally after following the operating instructions



.....

**Note: Adjust only those controls that are covered by the operating instructions, since improper adjustment of other controls may result in damage and will often require extensive work by a qualified technician to restore the product to normal condition.**



.....

**Warning! For safety reasons, do not use non-compliant parts when adding or changing components. Consult your reseller for purchase options.**

Your device and its enhancements may contain small parts. Keep them out of the reach of small children.

## Additional safety information

- Do not look into the projector's lens when the lamp is on. The bright may hurt your eyes.
- Turn on the projector first and then signal sources
- Do not place the product in following environments:
  - Space that is poorly ventilated or confined. At least 50cm clearance from walls and free flow of air around the projector is necessary.
  - Locations where temperatures may become excessively high, such as inside of a car with all windows rolled up.
  - Locations where excessive humidity, dust, or cigarette smoke may contaminate optical components, shortening the life span and darkening the image.
  - Locations near fire alarms.
  - Locations with an ambient temperature above 40 °C/104 °F.
  - Locations where the altitudes are higher than 10000 feet.
- Unplug immediately if there is something wrong with your projector. Do not operate if smoke, strange noise or odor comes out of your projector. It

might cause fire or electric shock. In this case, unplug immediately and contact your dealer.

- Do not keep using this product to break or drop it. In this case contact your dealer for inspection.
- Do not face the projector lens to the sun. It can lead to fire.
- When switching the projector off, suggest to ensure the projector completes its cooling cycle before disconnecting power.
- Do not frequently turn off the main power abruptly or unplug the projector during operation. The best way is to wait for the fan to turn off before turning main power off.
- Do not touch air outlet grille and bottom plate which becomes hot.
- Clean the air filter frequently if have. The temperature inside may rise and cause damage when the filter/ventilation slots clogged with dirt or dust.
- Do not look into the air outlet grille when projector is operating. It may hurt your eyes.
- Always open the lens shutter or remove the lens cap when the projector is on.
- Do not block the projector lens with any object when the projector is under operation as this could cause the object to become heated and deformed or even cause a fire. To temporarily turn off the lamp, press **HIDE** on the remote control.
- The lamp becomes extremely hot during operation. Allow the projector to cool for approximately 45 minutes prior to removing the lamp assembly for replacement.
- Do not operate lamps beyond the rated lamp life. It could cause it to break on rare occasions.
- Never replace the lamp assembly or any electronic components unless the projector is unplugged.
- The product will detect the life of the lamp itself. Please be sure to change the lamp when is showing warning message.
- When changing the lamp, please allow unit to cool down, and follow all changing instructions.
- Reset the "Lamp Hour Reset" function from the Onscreen display "Management" menu after replacing the lamp module.
- Do not attempt to disassemble this projector. There are dangerous high voltages inside which may hurt you. The only user serviceable part is the lamp which has its own removable cover. Refer servicing only to suitable qualified professional service personnel.
- Do not stand the projector on end vertically. It may cause the projector to fall over, causing injury or damage.
- This product is capable of displaying inverted images for ceiling mount installation. Only use acer ceiling mount kit for mounting the projector and ensure it is securely installed.

## Caution for Listening

To protect your hearing, follow these instructions.

- Increase the volume gradually until you can hear clearly and comfortably.
- Do not increase the volume level after your ears have adjusted.
- Do not listen to music at high volumes for extended periods.
- Do not increase the volume to block out noisy surroundings.
- Decrease the volume if you can't hear people speaking near you.

## Disposal instructions

Do not throw this electronic device into the trash when discarding. To minimize pollution and ensure utmost protection of the global environment, please recycle. For more information on the Waste from Electrical and Electronics Equipment (WEEE) regulations, visit

<http://www.acer-group.com/public/Sustainability/sustainability01.htm>



## Mercury advisory

For projectors or electronic products containing an LCD/CRT monitor or display:



Lamp(s) inside this product contain mercury and must be recycled or disposed of according to local, state or federal laws. For more information, contact the Electronic Industries Alliance at [www.eiae.org](http://www.eiae.org). For lamp-specific disposal information, check [www.lamprecycle.org](http://www.lamprecycle.org)



## Do not stare into the beam, RG2

"As with any bright source, do not stare into the direct beam, RG2 IEC 62471-5:2015"



# First things first

## Usage Notes

Do:

- Turn off the product before cleaning.
- Use a soft cloth moistened with mild detergent to clean the display housing.
- Disconnect the power plug from AC outlet if the product is not being used for a long period of time.

Don't:

- Block the slots and openings on the unit provided for ventilation.
- Use abrasive cleaners, waxes or solvents to clean the unit.
- Use under the following conditions:
  - In extremely hot, cold or humid environments.
  - In areas susceptible to excessive dust and dirt.
  - Near any appliance that generates a strong magnetic field.
  - Place In direct sunlight.

## Precautions

Follow all warnings, precautions and maintenance as recommended in this user's guide to maximize the life of your unit.



### Warning:

- Do not look into the projector's lens when the lamp is on. The bright light may hurt your eyes.
- To reduce the risk of fire or electric shock, do not expose this product to rain or moisture.
- Please do not open or disassemble the product as this may cause electric shock.
- When changing the lamp, please allow unit to cool down, and follow all changing instructions.
- This product will detect the life of the lamp itself. Please be sure to change the lamp when it shows warning messages.
- Reset the "Lamp Hour Reset" function from the Onscreen display "Management" menu after replacing the lamp module.
- When switching the projector off, please ensure the projector completes its cooling cycle before disconnecting power.
- Turn on the projector first and then the signal sources.
- Do not use lens cap when projector is in operation.
- When the lamp reaches the end of its life, it will burn out and may make a loud popping sound. If this happens, the projector will not turn back on until the lamp module has been replaced. To replace the lamp, follow the procedures listed under "Replacing the Lamp".



Information for your safety and comfort	iii
First things first	viii
Usage Notes	viii
Precautions	viii
Introduction	1
Product Features	1
Package Overview	3
Projector Overview	4
Projector Outlook	4
Control Panel	6
Remote Control Layout	7
Getting Started	9
Connecting the Projector	9
Turning the Projector On/Off	11
Turning on the Projector	11
Turning the projector off	12
Adjusting the Projected Image	13
Adjusting the Height of Projected Image	13
How to optimize image size and distance	14
How to get a preferred image size by adjusting distance and zoom	17
User Controls	20
Installation menu	20
Onscreen Display (OSD) Menus	21
Color	22
Image	24
Setting	26
Management	28
Audio	28
3D	29
Language	29
Appendices	30
Troubleshooting	30

# Contents

LED & Alarm Definition Listing	34
Cleaning and replacing the dust filters	35
Replacing the Lamp	36
Ceiling Mount Installation	37
Specifications	40
Compatibility modes	45
<b>Regulations and safety notices</b>	<b>50</b>

# Introduction

## Product Features

This product is a single-chip DLP® projector. Outstanding features include:

- DLP® technology
- X115/D602/EV-S62/V31S/AS304/D600+/X114P/R602/KS304/ES-12/B102/  
X115AH/D602B/EV-S62A/V30S/AS313/D600H+/X114AH/R602D/KS314A/  
ES-12D/B102H/X115H/D602D/EV-S62H/V32S/AS314/D600D+/X114PH/R602H/  
KS314/ES-12H/B102D/X117/D604/EV-S64/V33S/AS307/D605/R604/KS305/  
ES-13/B103/X117AH/D604B/EV-S64A/V34S/AS317/D605H/R604D/KS315A/  
ES-13D/B103H/X117H/D604D/EV-S64H/V35S/AS318/D605D/R604H/KS315/  
ES-13H/B103D/X1185G/X1184G/X1185PG/X1184PG series: Native 800 x 600  
SVGA resolution  
X125H/D612D/EV-X62H/V32X/AX314/D610D+/X124PH/R612H/KX314/  
EX-12H/B112D/X127H/D614D/EV-X64H/V35X/AX318/D615D/R614H/KX315/  
EX-13H/B113D/X1285G/X1284G/X1285PG/X1284PG series: Native 1024 x 768  
XGA resolution  
X135WH/D622D/EV-W62H/V32W/AW314/D620D+/X134PWH/R622H/KW314/  
EW-12H/B122D/X137WH/D624D/EV-W64H/V35W/AW318/D625D/R624H/  
KW315/EW-13H/B123D series: Native 1280 x 800 WXGA resolution  
H6517ABD/H6519ABD/E145F/HE-801K series: 1920x1080 1080p resolution  
Full/4:3/16:9/L.Box aspect ratio supported
- Enables projecting 3D content via DLP Link Technology: Blue-Ray 3D supported and nVidia 3DTV Play Ready
- Acer ColorBoost technology delivers nature's true colors for vivid, life-like images
- High brightness and contrast ratio
- Versatile display modes (Bright, Presentation, Standard, Video, Game, Education, Movie, Dark Cinema, Sports, User) enable optimum performance in any situation
- NTSC / PAL / SECAM compatible and HDTV (480i/p, 576i/p, 720p, 1080i/p) supported
- Lower power consumption and economy (ECO) mode extends lamp life
- Acer EcoProjecton Technology delivers Intelligent power management approach and physical efficiency improvement
- Advanced digital keystone correction optimizes presentations
- Smart detection delivers quick, intelligent source detection
- Multi-language onscreen display (OSD) menus
- Manual focus projection lens zooms up to 1.1x
- 2x digital zoom

- Microsoft® Windows® 2000, XP, Vista®, Windows 7, Windows 8, Windows® 10, Macintosh® OS compliant



**Note:** Functions vary depending on model definition.

# Package Overview

This projector comes with all the items shown below. Check to make sure your unit is complete. Contact your dealer immediately if any thing is missing.



Projector



Power cord



VGA cable



Remote control

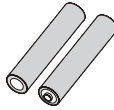

2 x Batteries  
(option)



Security card  
(option)



User's guide  
(option)



Quick start guide



Carrying case  
(option)

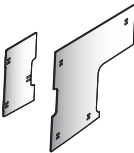

Dust filters  
(option)

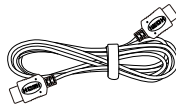

HDMI cable  
(option)

# Projector Overview

## Projector Outlook

Front / upper side

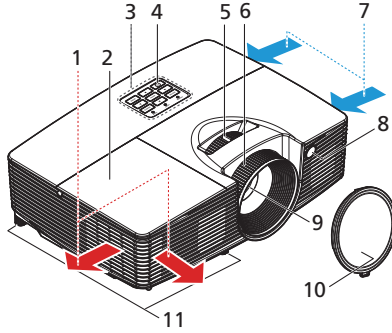

#	Description	#	Description
1	Air outlet	7	Air inlet
2	Lamp cover	8	Remote control receiver
3	Control panel	9	Projection lens
4	Power button	10	Lens cap
5	Zoom lever	11	Tilt adjusting wheels
6	Focus ring		

## Right / Rear side

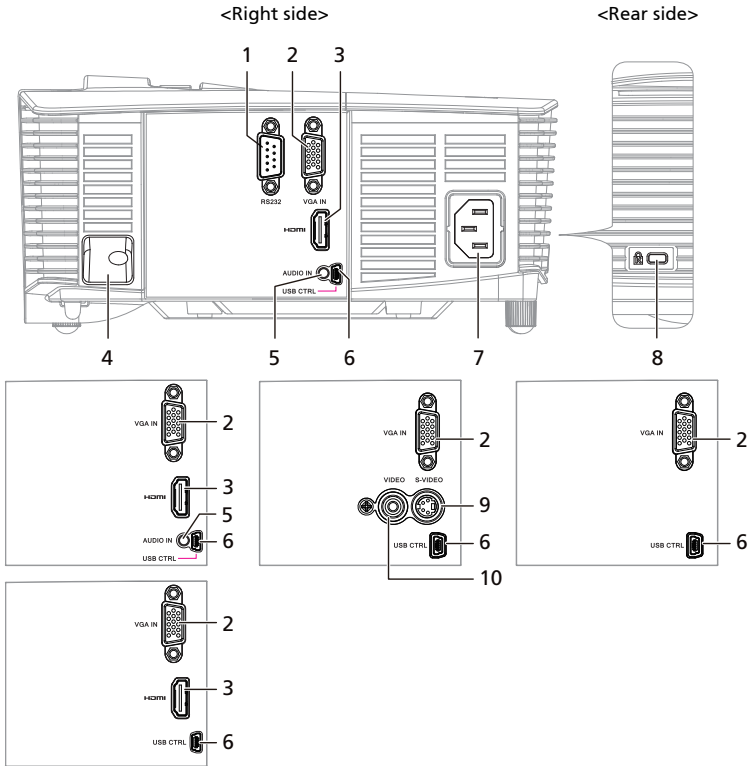

#	Description	#	Description
1	RS232 connector	6	Mini USB Ctrl connector (for firmware upgrade and page up/page down function)
2	PC analog signal/HDTV/component video input connector	7	Power socket
3	HDMI connector	8	Kensington™ lock port
4	Security bar	9	S-Video input connector
5	Audio input connector	10	Composite video input connector



**Note:** Functions vary depending on model definition.

## Control Panel



#	Icon	Function	Description
1	POWER	POWER	Power Indicator LED
2	LAMP	LAMP	Lamp Indicator LED
3	TEMP	TEMP	Temp Indicator LED
4	RESYNC	RESYNC	Automatically synchronizes the projector to the input source.
5	SOURCE	SOURCE	Changes the active source.
6		POWER	See the contents in <b>"Turning the Projector On/Off"</b> section.
7	MODE	MODE	Press <b>"MODE"</b> to select the display mode from Bright, Presentation, Standard, Video, Game, Education and User.
8	MENU	MENU	<ul style="list-style-type: none"> <li>Press <b>"MENU"</b> to launch the Onscreen display (OSD) menu, back to the previous step for the OSD menu operation or exit the OSD menu.</li> <li>Confirm your selection of items.</li> </ul>
9		Four directional select keys	Use     to select items or make adjustments to your selection.
10		Keystone	Adjusts the image to compensate for distortion caused by tilting the projector.



**Note:** Functions vary depending on model definition.



## Remote Control Layout



#	Icon	Function	Description
1		Infrared transmitter	Sends signals to the projector.
2		POWER	Refer to the <b>"Turning the Projector On/Off"</b> section.
3		3D	Press "3D" to select 3D models.
4		SOURCE	Changes the active source.
5		MODE	Press "MODE" to select the display mode from Bright, Presentation, Standard, Video, Game, Education, Movie, Dark Cinema, Sports and User.
6		HIDE	Momentarily turns off the video. Press <b>"HIDE"</b> to hide the image, press again to display the image.
7		MEDIA_SETUP	No function.
8		RATIO	To choose the desired aspect ratio.
9		ZOOM	Zooms the projector display in or out.
10		FREEZE	To pause the screen image.
11		MENU	<ul style="list-style-type: none"> <li>Press "MENU" to launch the Onscreen display (OSD) menu, back to the previous step for the OSD menu operation or exit the OSD menu.</li> <li>Confirm your selection of items.</li> </ul>
12		KEYSTONE	Adjusts the image to compensate for distortion caused by tilting the projector.

#	Icon	Function	Description
13		Four directional select keys	Use up, down, left, right buttons to select items or make adjustments to your selection.
14		Pre./Rewind	No function.
		Enter/ Play/ Pause	No function.
		Back/Stop	No function.
		Next/Fast forward	No function.
15		KeyPad 0~9	Press " <b>0~9</b> " to input a password in the "Security" OSD.
16		PgUp/PgDn	For computer mode only. Use this button to select the next or previous page. This function is only available when USB Ctrl connector (mini type B) is connected to a computer via a USB cable.
17		COMPONENT	No function.
18		VIDEO	To change source to COMPOSITE VIDEO.
19		VGA	Press " <b>VGA</b> " to change source to the VGA connector. This connector supports analog RGB, YPbPr (480p/576p/720p/1080i), YCbCr (480i/576i) and RGBsync.
20		S-VIDEO	To change source to S-Video.
21		SD/USB A	No function.
22		USB B	For USB control and firmware upgrade.
23		HDMI™/MHL	To change source to HDMI.
24		LAN/WIFI	No function.



**Note:** Functions vary depending on model definition.

# Getting Started

## Connecting the Projector

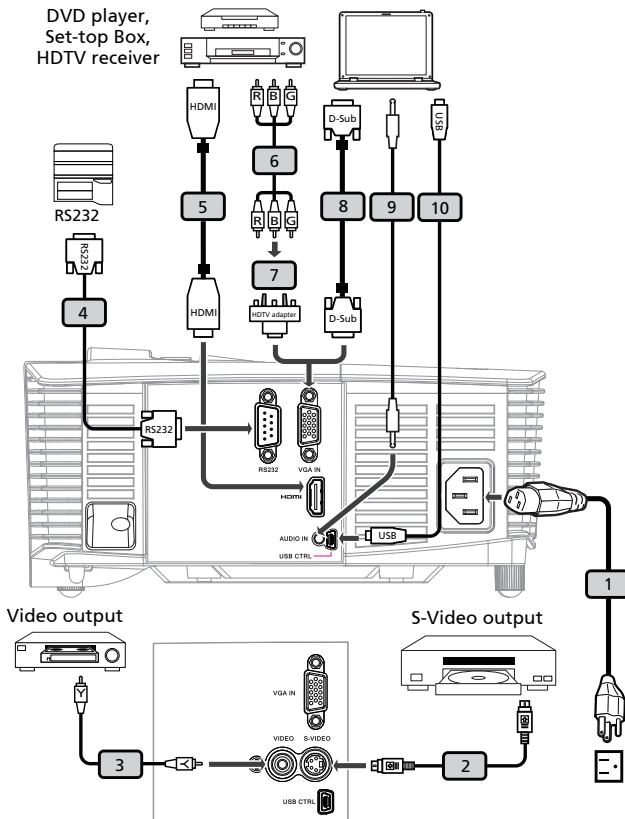

#	Description	#	Description
1	Power cord	6	3 RCA component cable
2	S-Video cable	7	VGA to component/HDTV adapter
3	Composite video cable	8	VGA cable
4	RS232 cable	9	Audio cable jack/jack
5	HDMI cable	10	USB cable



.....

**Note 1:** To ensure the projector works well with your computer, please make sure the timing of the display mode is compatible with the projector.

**Note 2:** Functions vary depending on model definition.

**Note 3:** USB cable needs powered extender if the length is over 5 m.

# Turning the Projector On/Off

## Turning on the Projector

- 1 Ensure that the power cord and signal cable are securely connected. The Power indicator LED will flash red.
- 2 Turn on the projector by pressing "**Power**" button on the control panel or remote control, and the Power indicator LED will turn blue.
- 3 Turn on your source (computer, notebook, video player, etc.). The projector will detect your source automatically.
  - If the screen displays "Lock" and "Source" icons, it means the projector is locked onto a specific source type and there is no such type of input signal detected.
  - If the screen displays "No Signal", please make sure the signal cables are securely connected.
  - If you connect to multiple sources at the same time, use the "Source" button on either control panel or the remote control or direct source key on the remote control to switch between inputs.

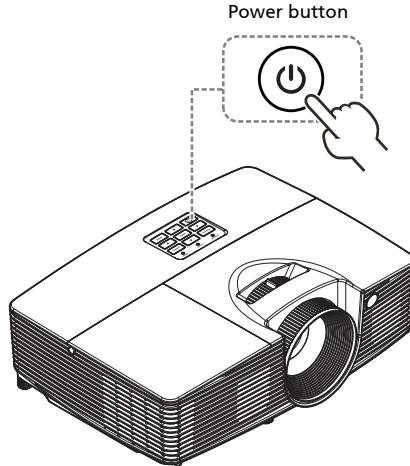

## Turning the projector off

- 1 To turn the projector off, press and hold the power button. This message appears: **"Please press the power button again to complete the shutdown process."** Press the power button again.
- 2 The LED power indicator will turn RED and blink rapidly after the projector is turned off, and the fan(s) will continue to operate for about 2 minutes to ensure that the system cools properly. (only supported under "Instant Resume" mode)
- 3 As long as the power cord remains plugged in, you can press the power button to turn the projector immediately back on anytime during the 2-minute shutdown process. (only supported under "Instant Resume" mode)
- 4 Once the system has finished cooling, the LED power indicator will stop blinking and turn solid red to indicate standby mode.
- 5 It is now safe to unplug the power cord.



### Warning indicators:

- **"Projector Overheated. Lamp will automatically turn off soon."**  
This onscreen message indicates that the projector has overheated. The lamp will automatically turn off, the projector will automatically shut down, and the LED temp indicator will turn solid red. Contact your local dealer or service center.
- **"Fan failed. Lamp will automatically turn off soon."**  
This onscreen message indicates that the fan has failed. The lamp will automatically turn off, the projector will automatically shut down, and the LED temp indicator will blink. Contact your local dealer or service center.



**Note 1:** Whenever the projector automatically shuts down and the LED lamp indicator turns solid red, contact your local reseller or service center.

**Note 2:** Functions vary depending on model definition.

**Attention!** The projector will enter a two minute cool down period to ensure continued optimal lamp operation.

## Adjusting the Projected Image

### Adjusting the Height of Projected Image

The projector is equipped with elevator feet for adjusting the height of image.

To raise/lower the image:

Use Tilt adjusting wheel to fine-tune the display angle.



## How to optimize image size and distance

Consult the table below to find the optimal image sizes achievable when the projector is positioned at a desired distance from the screen.

- SVGA/XGA series

If the projector is 2.0 m from the screen, good image quality is possible for image sizes between 46" and 51".



**Note:** Remind as below figure, the space of 89 cm height is required when located at 2.0 m distance.



Desired Distance (m) <A>	Screen size			Screen size		
	(Min zoom)			(Max zoom)		
	Diagonal (inch) <B>	W (cm) x H (cm)	From base to top of image (cm) <C>	Diagonal (inch) <B>	W (cm) x H (cm)	From base to top of image (cm) <C>
1.2	27.34	56 x 42	48	30	62 x 46	53
1.5	34	69 x 52	60	38	77 x 58	67
2	46	93 x 69	80	51	103 x 77	89
3	68	139 x 104	120	76	155 x 116	133
4	91	185 x 139	160	101	206 x 155	178
5	114	231 x 174	200	127	258 x 193	222
6	137	278 x 208	240	152	309 x 232	267
7	159	324 x 243	280	178	361 x 271	311
8	182	370 x 278	319	203	412 x 309	356
9	205	417 x 313	359	228	464 x 348	400
10	228	463 x 347	399	254	515 x 387	445
11	251	509 x 382	439	279	567 x 425	489
11.8	269	546 x 410	471	299.3	608 x 456	525

Zoom Ratio: 1.1x



- WXGA series

If the projector is 2.0 m from the screen, good image quality is possible for image sizes between 54" and 60".



**Note:** Remind as below figure, the space of 91 cm height is required when located at 2.0 m distance.



Desired Distance (m) <A>	Screen size		Top	Screen size		Top
	(Min zoom)			(Max zoom)		
	Diagonal (inch) <B>	W (cm) x H (cm)	From base to top of image (cm) <C>	Diagonal (inch) <B>	W (cm) x H (cm)	From base to top of image (cm) <C>
1.1	29.69	64 x 40	45	33	71 x 45	50
1.5	40	87 x 55	61	45	97 x 61	68
2	54	116 x 73	82	60	130 x 81	91
3	81	174 x 109	123	90	194 x 121	136
4	108	233 x 145	163	120	259 x 162	182
5	135	291 x 182	204	150	324 x 202	227
6	162	349 x 218	245	180	389 x 243	273
7	189	407 x 254	286	210	453 x 283	318
8	216	465 x 291	327	241	518 x 324	364
9	243	523 x 327	368	271	583 x 364	409
10	270	581 x 363	408	300.69	648 x 405	455

Zoom Ratio: 1.1x

- 1080p series

If the projector is 2 m from the screen, good image quality is possible for image sizes between 56" and 61".



**Note:** Remind as below figure, the space of 88 cm height is required when located at 2 m distance.

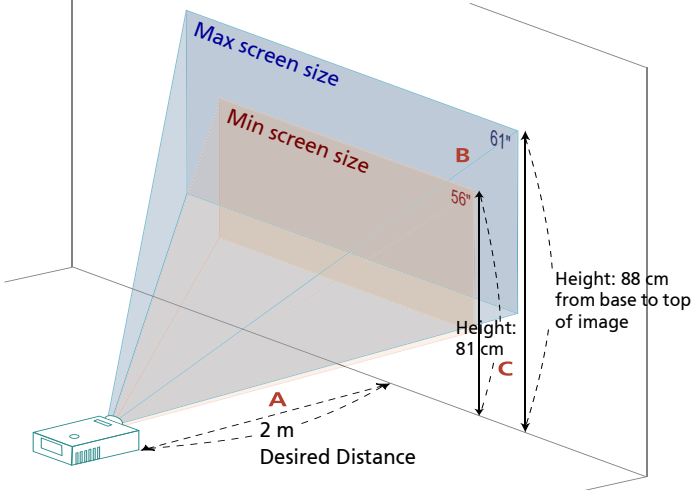

Desired Distance (m) <A>	Screen size		Top	Screen size		Top
	(Min zoom)			(Max zoom)		
	Diagonal (inch) <B>	W (cm) x H (cm)	From base to top of image (cm) <C>	Diagonal (inch) <B>	W (cm) x H (cm)	From base to top of image (cm) <C>
1.5	41.8	93 x 52	60	46	101 x 57	66
2	56	123 x 69	81	61	135 x 76	88
2.5	70	154 x 87	101	76	169 x 95	110
3	84	185 x 104	121	92	203 x 114	132
3.5	98	216 x 122	141	107	236 x 133	154
4	112	247 x 139	161	122	270 x 152	176
4.5	125	278 x 156	181	137	304 x 171	198
5	139	309 x 174	201	153	338 x 190	220
6	167	370 x 208	242	183	405 x 228	265
7	195	432 x 243	282	214	473 x 266	309
8	223	494 x 278	322	244	541 x 304	353
9	251	556 x 313	363	275	608 x 342	397
10	279	617 x 347	403	305.2	676 x 380	441

Zoom Ratio: 1.1x

## How to get a preferred image size by adjusting distance and zoom

The table below shows how to achieve a desired image size by adjusting either the position or the zoom ring.

- SVGA/XGA series

To obtain an image size of 50" set the projector at a distance 2.0 m and 2.2 m from the screen.

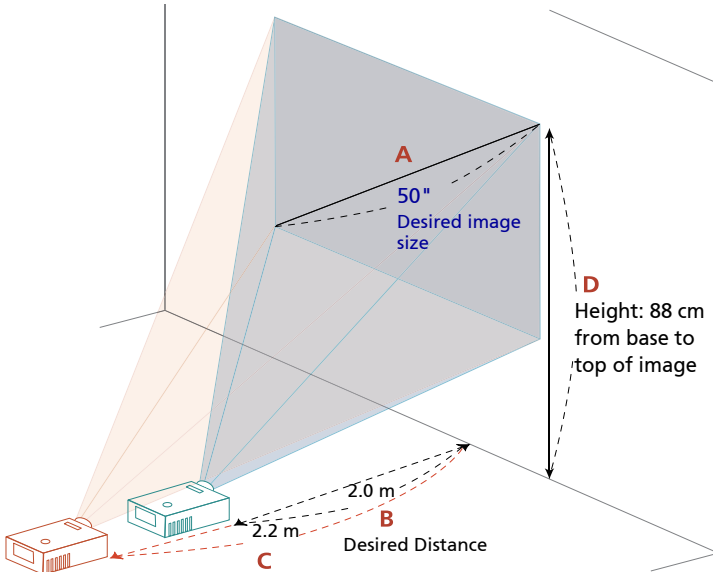

Desired Image Size		Distance (m)		Top (cm)
Diagonal (inch) <A>	W (cm) x H (cm)	Max zoom <B>	Min zoom <C>	From base to top of image <D>
30	61 x 46	1.2	1.3	53
40	81 x 61	1.6	1.8	70
50	102 x 76	2.0	2.2	88
60	122 x 91	2.37	2.6	105
70	142 x 107	2.8	3.1	123
80	163 x 122	3.2	3.5	140
90	183 x 137	3.5	4.0	158
100	203 x 152	3.9	4.4	175
150	305 x 229	5.9	6.6	263
180	366 x 274	7.1	7.9	315
200	406 x 305	7.9	8.8	351
250	508 x 381	9.9	11.0	438
300	610 x 457	11.8		526

Zoom Ratio: 1.1x

- WXGA series

To obtain an image size of 60" set the projector at a distance 2.0 m and 2.2 m from the screen.



Desired Image Size		Distance (m)		Top (cm)
Diagonal (inch) <A>	W (cm) x H (cm)	Max zoom <B>	Min zoom <C>	From base to top of image <D>
30	65 x 40		1.1	45
40	86 x 54	1.3	1.5	61
50	108 x 67	1.7	1.9	76
60	129 x 81	2.0	2.2	91
70	151 x 94	2.3	2.6	106
80	172 x 108	2.7	3.0	121
90	194 x 121	3.0	3.3	136
100	215 x 135	3.3	3.7	151
150	323 x 202	5.0	5.6	227
180	388 x 242	6.0	6.7	272
200	431 x 269	6.7	7.4	303
250	538 x 337	8.3	9.3	378
300	646 x 404	10.0		454

Zoom Ratio: 1.1x

- 1080p series

To obtain an image size of 60" set the projector at a distance 1.97 m and 2.2 m from the screen.



Desired Image Size		Distance (m)		Top (cm)
Diagonal (inch) <A>	W (cm) x H (cm)	Max zoom <B>	Min zoom <C>	From base to top of image <D>
42	93 x 52		1.5	61
50	111 x 62	1.6	1.8	72
60	133 x 75	1.97	2.2	87
70	155 x 87	2.3	2.5	101
80	177 x 100	2.6	2.9	116
90	199 x 112	2.9	3.2	130
100	221 x 125	3.3	3.6	144
120	266 x 149	3.9	4.3	173
150	332 x 187	4.9	5.4	217
180	398 x 224	5.9	6.5	260
200	443 x 249	6.6	7.2	289
250	553 x 311	8.2	9.0	361
305	675 x 380	10.0		441

Zoom Ratio: 1.1x

# User Controls

## Installation menu

The installation menu provides an onscreen display (OSD) for projector installation and maintenance. Use the OSD only when the message "No signal input" is displayed on the screen.

The menu options include settings and adjustments for screen size and distance, focus, keystone correction and more.

- 1 Turn on the projector by pressing "**Power**" button on the control pad.
- 2 Press the "**MENU**" button on the remote control to launch the OSD for projector installation and maintenance.

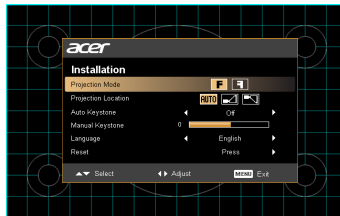

- 3 The background pattern acts as a guide to adjusting the calibration and alignment settings, such as screen size and distance, focus and more.
- 4 The Installation menu includes the following options:
  - Projection Mode
  - Projection Location
  - Auto Keystone settings
  - Manual Keystone settings
  - Keystone settings
  - Language settings
  - Reset to factory default function

Use the up and down arrow keys to select an option, the left and right arrow keys to adjust selected option settings, and the right arrow key to enter a submenu for feature setting. The new settings will be saved automatically upon exiting the menu.

- 5 Push the MENU button anytime to exit the menu and return to the Acer welcome screen.



**Note:** Functions vary depending on model definition.

## Onscreen Display (OSD) Menus

The projector has multilingual OSD that allow you to make image adjustments and change a variety of settings.

### Using the OSD menus

- To open the OSD menu, press **"MENU"** on the remote control or control panel.
- When the OSD is displayed, use the  $\triangle$   $\nabla$  keys to select any item in the main menu. After selecting the desired main menu item, press  $\blacktriangleright$  to enter submenu for feature setting.
- Use the  $\triangle$   $\nabla$  keys to select the desired item and adjust the settings by using the  $\blacktriangleleft$   $\blacktriangleright$  keys.
- Select the next item to be adjusted in the submenu and adjust as described above.
- Press **"MENU"** on the remote control or control panel, the screen will return to the main menu.
- To exit OSD, press **"MENU"** on the remote control or control panel. The OSD menu will close and the projector will automatically save the new settings.



**Note:** Some of the following OSD settings may not be available. Please refer to the actual OSD of your projector.

**Note:** Functions vary depending on model definition.

## Color

Display Mode	<p>There are many factory presets optimized for various types of images.</p> <ul style="list-style-type: none"> <li>• Bright: For brightness optimization.</li> <li>• Presentation: For meeting presentation.</li> <li>• Standard: For common environment.</li> <li>• Video: For playing video in a bright environment.</li> <li>• Game: For game content.</li> <li>• Education: For education environment.</li> <li>• Movie: For brighter and general movie/video/photo playing.</li> <li>• Dark Cinema: For dark movie content.</li> <li>• Sports: For sport picture.</li> <li>• User: Memorize user's settings.</li> </ul>
Wall color	<p>Use this function to choose a proper color according to the wall. There are several choices, including white, light yellow, light blue, pink, dark green. It will compensate the color deviation due to the wall color to show the correct image tone.</p>
Brightness	<p>Adjust the brightness of the image.</p> <ul style="list-style-type: none"> <li>• Press ◀ to darken the image.</li> <li>• Press ▶ to lighten the image.</li> </ul>
Contrast	<p>"Contrast" controls the difference between the lightest and darkest parts of the picture. Adjusting the contrast changes the amount of black and white in the image.</p> <ul style="list-style-type: none"> <li>• Press ◀ to decrease the contrast.</li> <li>• Press ▶ to increase the contrast.</li> </ul>
Saturation	<p>Adjusts a video image from black and white to fully saturated color.</p> <ul style="list-style-type: none"> <li>• Press ◀ to decrease the amount of color in the image.</li> <li>• Press ▶ to increase the amount of color in the image.</li> </ul>
Tint	<p>Adjusts the color balance of red and green.</p> <ul style="list-style-type: none"> <li>• Press ◀ to increase the amount of green in the image.</li> <li>• Press ▶ to increase the amount of red in the image.</li> </ul>



Color Temperature	Mode Use this function to choose CT1, CT2 (Native), CT3, User mode.
	R Gain Adjusts the red gain for color temperature optimization.
	G Gain Adjusts the green gain for color temperature optimization.
	B Gain Adjusts the blue gain for color temperature optimization.
	R Bias Adjusts the red bias for color temperature optimization.
	G Bias Adjusts the green bias for color temperature optimization.
	B Bias Adjusts the blue bias for color temperature optimization.
Dynamic Black	Choose "On" to automatically optimize the display of dark movie scenes enabling them to be shown in incredible detail.
Gamma	Effects the representation of dark scenery. With greater gamma value, dark scenery looks brighter.
Advanced	Ind. Color Management Adjusts the red, green, blue, cyan, yellow and magenta colors.
	Ind. Hue Adjusts the color balance of red and green.
	Ind. Saturation Adjusts the selected color to be less or more saturated color.
	Ind. Gain Adjusts the selected color's contrast.
	Brilliant Color Produces an expanded on-screen color spectrum that delivers enhanced color saturation for bright, true-to-life images.
	White Peaking Increases the brightness of whites that are near 100%. (video sources only)
	Film Mode Sets the image optimized to 24-frame True Film mode.
	Noise Reduction Adjusts signal noise reduction. "0" means the noise reduction is off, ">0" increase noise reduction.
	Black Extension This ensures optimum black level for each analog source.



**Note 1:** "Saturation" and "Tint" functions are not supported under computer or HDMI mode.

**Note 2:** Functions vary depending on model definition.

# Image

Projection	<ul style="list-style-type: none"> <li>•  <b>Front-Desktop:</b> The factory default setting.</li> <li>•  <b>Rear-Desktop:</b> When you select this function, the projector reverses the image so you can project from behind a translucent screen.</li> <li>•  <b>Rear-Ceiling:</b> When you select this function, the projector reverses and inverts the image at same time. You can project from behind a translucent screen with ceiling mounted projection.</li> <li>•  <b>Front-Ceiling:</b> When you select this function, the projector inverts the image for ceiling-mounted projection.</li> </ul>
Projection Mode	<ul style="list-style-type: none"> <li>•  <b>Front:</b> The factory default setting.</li> <li>•  <b>Rear:</b> Reverses the image so you can project from behind a translucent screen.</li> </ul>
Projection Location	<ul style="list-style-type: none"> <li>•  <b>Auto:</b> Automatically adjusts projection location of image.</li> <li>•  <b>Desktop</b></li> <li>•  <b>Ceiling:</b> Turns the image upside down for ceiling-mounted projection.</li> </ul>
Aspect Ratio	<p>Use this function to choose your desired aspect ratio.</p> <ul style="list-style-type: none"> <li>• <b>Auto:</b> Keep the image with original width-height ratio and maximize the image to fit native horizontal or vertical pixels.</li> <li>• <b>Full:</b> Resize image to fit full screen by width (1280 pixels) and height (800 pixels).</li> <li>• <b>4:3:</b> The image will be scaled to fit the screen and displayed using a 4:3 ratio.</li> <li>• <b>16:9:</b> The image will be scaled to fit the width of the screen and the height adjusted to display the image using a 16:9 ratio.</li> <li>• <b>L.Box:</b> Keep original signal aspect ratio and zoom in by 1.333 times.</li> </ul>
Keystone	Adjust image distortion caused by tilting projection.
Auto Keystone	Automatically adjusts vertical image.
Manual Keystone	<p>Adjust image distortion caused by tilting projection.</p> <div style="text-align: center;">  </div> <p>&lt;Note&gt; The Manual Keystone function is unavailable under Auto Keystone setting to "On".</p>
Sharpness	<p>Adjusts the sharpness of the image.</p> <ul style="list-style-type: none"> <li>• Press  to decrease the sharpness.</li> <li>• Press  to increase the sharpness.</li> </ul>

H. Position	<ul style="list-style-type: none"> <li>• Press ◀ to move the image left.</li> <li>• Press ▶ to move the image right.</li> </ul>
V. Position	<ul style="list-style-type: none"> <li>• Press ▼ to move the image down.</li> <li>• Press ▲ to move the image up.</li> </ul>
Frequency	"Frequency" changes the projector's refresh rate to match the frequency of your computer's graphics card. If you can see a vertical flickering bar in the projected image, use this function to make the necessary adjustments.
Tracking	Synchronizes the signal timing of the projector with the graphics card. If you experience an unstable or flickering image, use this function to correct it.
HDMI Color Range	Adjust the color range of the HDMI image data to correct color display error. <ul style="list-style-type: none"> <li>• Auto: Automatically adjust by information from player.</li> <li>• Limited Range: Process the input image as limited color range data.</li> <li>• Full Range: Process the input image as full color range data.</li> </ul>
HDMI Scan Info	Adjust the overscan ratio of the HDMI image on screen. <ul style="list-style-type: none"> <li>• Auto: Automatically adjust by information from player.</li> <li>• Underscan: Always no overscan on HDMI image.</li> <li>• Overscan: Always keep overscan on HDMI image.</li> </ul>







.....

**Note 1:** "H. Position", "V. Position", "Frequency" and "Tracking" functions are not supported under HDMI or Video mode.

**Note 2:** "HDMI Color Range" and "HDMI Scan Info" functions are only supported under HDMI mode.

**Note 3:** Functions vary depending on model definition.

# Setting

Source Lock	When Source Lock is turned "Off", the projector will search for other signals if the current input signal is lost. When Source Lock is turned "On", it will "lock" the current source channel unless you press "Source" button on the remote control for the next channel.
Closed Caption	Selects a preferred closed captioning mode from CC1, CC2, CC3, CC4, (CC1 displays captions in the primary language in your area). Select "Off" to turn off the captioning feature. This function is only available when a composite video or S-Video input signal is selected and its system format is NTSC. <Note> Set your screen aspect ratio to 4:3. This function is not available when the aspect ratio is "16:9" or "Auto" .
Reset	Press the  button and choose "Yes" to return the parameters on all menus to the factory default settings.
Security	<p><b>Security</b> This projector provides a useful security function for the administrator to manage usage of the projector.</p> <p>Press  to change the "Security" setting. If the security function is enabled, you must enter the "Administrator Password" first before changing the security settings.</p> <ul style="list-style-type: none"> <li>• Select "On" to enable the security function. The user has to enter a password to operate the projector. Please refer to the "User Password" section for details.</li> <li>• If "Off" is selected, then the user can turn on the projector without password.</li> </ul> <p><b>Timeout(Min.)</b> Once "Security" is activated to "On", the administrator can set timeout function.</p> <ul style="list-style-type: none"> <li>• Press  or  to select the timeout interval.</li> <li>• The range is from 10 minute to 990 minutes.</li> <li>• When the time is up, the projector will prompt the user to enter the password again.</li> <li>• The factory default setting of "Timeout(Min.)" is "Off".</li> <li>• Once the security function is enabled, the projector will request user to enter password when switch on the projector . Both "User Password" and "Administrator Password" can be accepted for this dialogue.</li> </ul>

	<p><b>User Password</b></p> <ul style="list-style-type: none"> <li>• Press  to setup or change the "User Password".</li> <li>• Press number keys to set your password on the remote control and press "MENU" to confirm.</li> <li>• Press  to delete character.</li> <li>• Enter the password when you see "Confirm Password" displayed.</li> <li>• The password should be between 4 and 8 characters long.</li> <li>• If you select "Request password only when plugging the power cord in.", the projector will prompt the user to enter the password every time the power cord is plugged.</li> <li>• If you select "Always request password while projector turns on.", the user has to enter the password every time when the projector is turned on.</li> </ul> <p><b>Administrator Password</b></p> <p>The "Administrator Password" can be used in both the "Enter Administrator Password" and "Enter Password" dialog boxes.</p> <ul style="list-style-type: none"> <li>• Press  to change the "Administrator Password".</li> <li>• The factory default of "Administrator Password" is "1234".</li> </ul> <p>If you forgot your administrator password, do the following to retrieve the administrator password:</p> <ul style="list-style-type: none"> <li>• An unique 6-digit "Universal Password" which is printed on the Security Card (please check accessory in the box). This unique password is the number which will be accepted by projector anytime no matter what the Administrator Password is.</li> <li>• If losing this security card and number, please contact with an Acer service center.</li> </ul>
--	--



-----

**Note:** Functions vary depending on model definition.



## Management

ECO Mode	Choose "On" to dim the projector lamp which will lower power consumption, extend the lamp life and reduce noise. Choose "Off" to return normal mode.
High Altitude	Choose "On" to turn on High Altitude mode. Operate the fans at full speed continuously to allow for proper high altitude cooling of the projector.
Turn Off Mode	<ul style="list-style-type: none"> <li>Instant Off: Shuts down the projector without fan cooling.</li> <li>Instant Resume: Resumes the system when the Power button is pressed again within 2 minutes.</li> </ul>
Auto Shutdown	The projector will automatically shutdown when there is no signal input after the allocated time. (default is 15 minutes)
Menu Display Time (Seconds)	Choose the OSD menu display time. (Default is 15 seconds). Select "Manual" to turn off main menu/one direct-key menu manually by user.
AC Power On	Choose "On" to power on projector while AC power plug in.
Lamp Hour Elapse	Displays the lamp's elapsed operating time (in hours).
Lamp Reminding	Activate this function to display a reminder to change the lamp 30 hours before its expected end-of-life.
Lamp Hour Reset	Press the  button and choose "Yes" to turn the lamp hour counter to 0 hours.



**Note:** Functions vary depending on model definition.

## Audio

Volume	<ul style="list-style-type: none"> <li>Press  to decrease the volume.</li> <li>Press  to increase the volume.</li> </ul>
Mute	<ul style="list-style-type: none"> <li>Choose "On" to mute the volume.</li> <li>Choose "Off" to restore the volume.</li> </ul>



**Note:** Functions vary depending on model definition.

## 3D

3D	<p>Choose "On" to enable DLP 3D function.</p> <ul style="list-style-type: none"> <li>On: Choose this item while using DLP 3D glasses, 120Hz 3D capable graphics cards and HQFS format file or DVD with corresponding SW player.</li> <li>Off: Turn off 3D mode.</li> </ul>
3D Format	If the 3D content is not displayed correctly, you can select a 3D format that suits the 3D content you are viewing and obtain the best result.
24P 3D	Choose "96Hz" or "144Hz" to compatible with 3D glasses.
3D L/R Invert	If you see a discrete or overlapping image while wearing DLP 3D glasses, you may need to execute "Invert" to get best match of left/right image sequence to get the correct image (for DLP 3D).
3D Warning Message	<p>Choose "On" to display the 3D warning message.</p> 



**Note 1:** It needs correct settings on graphic card 3D application program for correct 3D display.

**Note 2:** The SW players, such as Stereoscopic Player and DDD TriDef Media Player can support 3D format files. You can download these three players on web page below,

- Stereoscopic Player (Trial):

[http://www.3dtv.at/Downloads/Index\\_en.aspx](http://www.3dtv.at/Downloads/Index_en.aspx)



- DDD TriDef Media Player (Trial):

<http://www.tridef.com/download/TriDef-3-D-Experience-4.0.2.html>

**Note 3:** "3D L/R Invert" is only available when 3D is enabled.

**Note 4:** There has reminder screen if 3D still enable when power on projector. Please adjust setting depended on your purpose.

## Language

Language	<p>Choose the multilingual OSD menu. Use the  or  key to select your preferred menu language.</p> <ul style="list-style-type: none"> <li>Press  to confirm the selection.</li> </ul>
----------	---

# Appendices

## Troubleshooting

If you experience a problem with your Acer projector, refer to the following troubleshooting guide. If the problem persists, please contact your local reseller or service center.

### Image Problems and Solutions

#	Problem	Solution
1	No image appears onscreen	<ul style="list-style-type: none"> <li>• Connected as described in the "Getting Started" section.</li> <li>• Ensure none of the connector pins are bent or broken.</li> <li>• Check if the projector lamp has been securely installed. Please refer to the "Replacing the Lamp" section.</li> <li>• Make sure you have removed the lens cap and the projector is switched on.</li> </ul>
2	Partial, scrolling or incorrectly displayed image (for PC (Windows 2000/XP/Vista/Windows 7/Windows 8))	<ul style="list-style-type: none"> <li>• Press "RESYNC" on the control panel.</li> <li>• For an incorrectly displayed image:             <ul style="list-style-type: none"> <li>• Open "My Computer", open the "Control Panel", and then double-click the "Display" icon.</li> <li>• Select the "Settings" tab.</li> <li>• Verify that your display resolution setting is lower than or equal to WUXGA-RB (1920 x 1200).</li> <li>• Click the "Advanced Properties" button.</li> </ul> </li> </ul> <p>If the problem still appears, change the monitor display you are using and follow the steps below:</p> <ul style="list-style-type: none"> <li>• Verify that the resolution setting is lower than or equal to WUXGA-RB (1920 x 1200).</li> <li>• Click the "Change" button under the "Monitor" tab.</li> <li>• Click "Show all devices". Next, select "Standard monitor types" under the SP box, and choose the resolution mode you need under the "Models" box.</li> <li>• Verify that the resolution setting of the monitor display is lower than or equal to WUXGA-RB (1920 x 1200).</li> </ul>



3	Partial, scrolling or incorrectly displayed image (For notebooks)	<ul style="list-style-type: none"> <li>• Press "RESYNC" on the control panel.</li> <li>• For an incorrectly displayed image: <ul style="list-style-type: none"> <li>• Follow the steps for item 2 (above) to adjust the resolution of your computer.</li> <li>• Press the toggle output settings. Example: [Fn]+[F4], Compaq [Fn]+[F4], Dell [Fn]+[F8], Gateway [Fn]+[F4], IBM [Fn]+[F7], HP [Fn]+[F4], NEC [Fn]+[F3], Toshiba [Fn]+[F5]</li> </ul> </li> <li>• If you experience difficulty changing resolutions or your monitor freezes, restart all equipment including the projector.</li> </ul>
4	The screen of the notebook computer is not displaying your presentation	<ul style="list-style-type: none"> <li>• If you are using a Microsoft® Windows® based notebook: Some notebook PCs may deactivate their own screens when a second display device is in use. Each has a different way to be reactivated. Refer to your computer's manual for detailed information.</li> <li>• If you are using an Apple® Mac® OS based notebook: In System Preferences, open Display and select Video Mirroring "On".</li> </ul>
5	Image is unstable or flickering	<ul style="list-style-type: none"> <li>• Adjust the "Tracking" to correct it. Refer to the "Image" section for more information.</li> <li>• Change the display color depth settings on your computer.</li> </ul>
6	Image has vertical flickering bar	<ul style="list-style-type: none"> <li>• Use "Frequency" to make an adjustment. Refer to the "Image" section for more information.</li> <li>• Check and reconfigure the display mode of your graphics card to make it compatible with the projector.</li> </ul>
7	Image is out of focus	<ul style="list-style-type: none"> <li>• Make sure the lens cap is removed.</li> <li>• Adjusts the focus ring on the projector lens.</li> <li>• Make sure the projection screen is within the required distance of 3.3 to 38.8 feet (1.0 to 11.8 meters) (SVGA/XGA series) / 3.3 to 32.7 feet (1.0 to 10.0 meters) (WXGA series) / 3.3 to 32.2 feet (1.0 to 9.8 meters) (1080p series) from the projector. Refer to the "How to get a preferred image size by adjusting distance and zoom" section for more information.</li> </ul>

8	Image is stretched when displaying a "widescreen" DVD title	<p>When you play a DVD encoded in anamorphic or 16:9 aspect ratio you may need to adjust the following settings:</p> <ul style="list-style-type: none"> <li>• If you play a 4:3 format DVD title, please change the format to 4:3 in the projector OSD.</li> <li>• If the image is still stretched, you will also need to adjust the aspect ratio. Set up the display format to 16:9 (wide) aspect ratio on your DVD player.</li> <li>• If you play an Letterbox (LBX) format DVD title, please change the format to Letterbox (LBX) in the projector OSD.</li> </ul>
9	Image is too small or too large	<ul style="list-style-type: none"> <li>• Adjust the zoom lever on the top of the projector.</li> <li>• Move the projector closer to or further from the screen.</li> <li>• Press "MENU" on the remote control. Go to "Image -&gt; Aspect Ratio" and try different settings or press "RATIO" on the remote control to adjust directly.</li> </ul>
10	Image has slanted sides	<ul style="list-style-type: none"> <li>• If possible, reposition the projector so that it is centered on the screen.</li> <li>• Press the "Keystone <math>\Delta</math> / <math>\square</math>" button on the remote control until the sides are vertical.</li> <li>• Press "MENU" on the remote control. Go to "Image -&gt; Auto Keystone" and choose "Off" on the OSD, if "Keystone" button is not available on the remote control.</li> </ul>
11	Image is reversed	<ul style="list-style-type: none"> <li>• Select "Image --&gt; Projection" on the OSD and adjust the projection direction.</li> </ul>

## OSD Messages

#	Condition	Message Reminder
1	Message	<ul style="list-style-type: none"> <li>Fan Fail - the system fan is not working.</li> </ul> <p style="text-align: center;">Fan Fail. Lamp will automatically turn off soon.</p> <ul style="list-style-type: none"> <li>Projector Overheated - the projector has exceeded its recommended operating temperature and must be allowed to cool down before it may be used. Please check the following message.</li> </ul> <p>Projector overheated, system will turn off automatically soon, please:</p> <ol style="list-style-type: none"> <li>1. Check if operation ambient temperature between 5 degree and 40 degree.</li> <li>2. Check if filter needs to be cleaned.</li> <li>3. Check if inlet or outlet is blocked.</li> <li>4. Check if high altitude mode is set when the projector operating at high altitude area.</li> </ol> <p>Please also check the dust filters if they are installed. If the dust filter is clogged with dust, please clean it. Please refer to "Cleaning and replacing the dust filters" for details.</p> <ul style="list-style-type: none"> <li>Replace the lamp - the lamp is about to reach its maximum lifetime. Prepare to replace it soon.</li> </ul> <p style="text-align: center;">Lamp is approaching the end of its useful life in full power operation. Replacement suggested!</p>

## Problems with the Projector

#	Condition	Solution
1	The projector stops responding to all controls	If possible, turn off the projector, then unplug the power cord and wait at least 30 seconds before reconnecting power.
2	Lamp burns out or makes a popping sound	When the lamp reaches the end of its useful life, it will burn out and may make a loud popping sound. If this happens, the projector will not turn on until the lamp module has been replaced. To replace the lamp, follow the procedures in the "Replacing the Lamp" section.

# LED & Alarm Definition Listing

## LED Messages

Message	Lamp_LED	Temp_LED	Power LED	
	Red	Red	Red	Blue
Input power plug	Flash ON to OFF 100ms	Flash ON to OFF 100ms	Flash ON to OFF 100ms	--
Standby	--	--	ON	--
Power button ON	--	--	--	ON
Lamp retry	--	--	--	Quick Flashing
Power off (Cooling state)	--	--	Quick Flashing	--
Power button OFF (cooling completed; standby mode)	--	--	ON	--
Error (thermal failure)	--	ON	--	ON
Error (fan lock)	--	Quick Flashing	--	ON
Error (lamp breakdown)	ON	--	--	ON
Error (color wheel fail)	Quick Flashing	--	--	ON

# Cleaning and replacing the dust filters

## Cleaning the dust filters

Clean the dust filters after every 1000 hours of use. If they are not cleaned periodically, they can become clogged with dust, preventing proper ventilation. This can cause overheating and damage the projector.



Follow these steps:

- 1 Turn the projector off. Wait for the Power LED to stop flashing then unplug the power cord.
- 2 Allow the projector at least 30 mins to cool down.
- 3 Pull out the dust filter. (Illustration #1)
- 4 To clean the dust filters, use a small vacuum cleaner designed for computers and other office equipment. (Illustration #2)
- 5 If the dirt is difficult to remove or the filter is broken, please contact your local dealer or service center to obtain a new filter.

## Replacing the Lamp

Use a screwdriver to remove the screw(s) from the cover, and then pull out the lamp.

The projector will detect the lamp life. You will be shown a warning message "**Lamp is approaching the end of its useful life in full power operation. Replacement suggested!**" When you see this message, change the lamp as soon as possible. Make sure the projector has been cooling down for at least 30 minutes before changing the lamp.



**Warning:** The lamp compartment is hot! Allow it to cool down before changing the lamp.



### To Change the Lamp

Turn off the projector by pressing the Power button.

Allow the projector at least 30 minutes to cool down.

Disconnect the power cord.

- 1 Use a screwdriver to remove the screw from the cover. (Illustration #1)  
Push up and remove the cover. (Illustration #2)
- 2 Remove the screw that secure the lamp module. (Illustration #3)  
Lift the handle so that it stands up. (Illustration #4)  
Pull out the lamp plug. (Illustration #5)
- 3 Lift the handle so that it stands up. Pull out the lamp module by force. (Illustration #6)

To replace the lamp module, use a new lamp and reverse the above steps.



**Warning:** To reduce the risk of personal injury, do not drop the lamp module or touch the lamp bulb. The bulb may shatter and cause injury if it is dropped.

## Ceiling Mount Installation

If you wish to install the projector using a ceiling mount, please refer to the steps below:

- 1 Drill four holes into a solid, structural ceiling member, and secure the ceiling mount base to the ceiling.



- 2 Choose the length combination based on actual environment. (CM-015 doesn't include Type 2 and Type 3.)



- 3 Type 1:  
For the standard size use three bracket screws to mount the projector to the ceiling mount bracket.  
Type 2 and Type 3:  
Alternatively, for the larger size, use the sliding extensions for more supports.

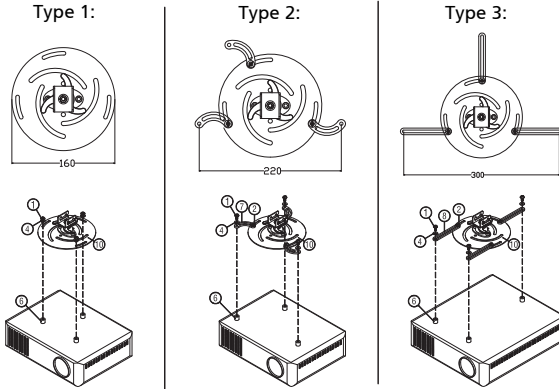

**Note:** It is recommended that you keep a reasonable space between the bracket and the projector to allow for proper heat distribution.

- 4 Connect the main body connector to the projector bracket (illustration 1), and then screw up four screws (illustration 2).

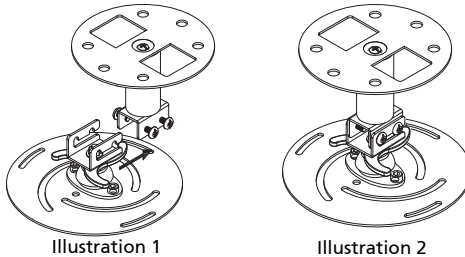



- 5 Adjust the angle and positioning as necessary.

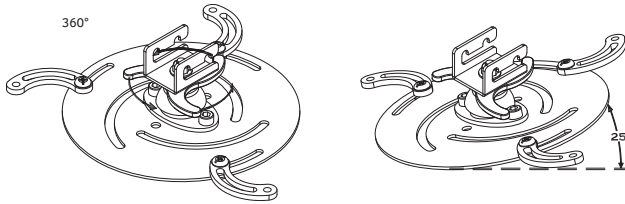

Screw Type B		Washer Type	
Diameter (mm)	Length (mm)	Large	Small
4	25	V	V

SCREW SPEC. M4 x 25 mm

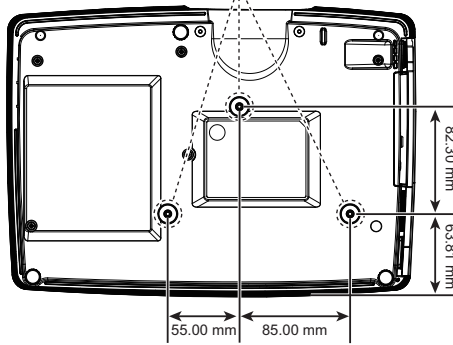

## Specifications

The specifications listed below are subject to change without notice. For final specs, please refer to Acer's published marketing specifications.

Projection system	DLP®
Resolution	<ul style="list-style-type: none"> <li>X115/D602/EV-S62/V31S/AS304/D600+/X114P/R602/KS304/ES-12/B102/X115AH/D602B/EV-S62A/V30S/AS313/D600H+/X114AH/R602D/KS314A/ES-12D/B102H/X115H/D602D/EV-S62H/V32S/AS314/D600D+/X114PH/R602H/KS314/ES-12H/B102D/X117/D604/EV-S64/V33S/AS307/D605/R604/KS305/ES-13/B103/X117AH/D604B/EV-S64A/V34S/AS317/D605H/R604D/KS315A/ES-13D/B103H/X117H/D604D/EV-S64H/V35S/AS318/D605D/R604H/KS315/ES-13H/B103D/X1185G/X1184G/X1185PG/X1184PG series: 800x600 SVGA resolution</li> <li>X125H/D612D/EV-X62H/V32X/AX314/D610D+/X124PH/R612H/KX314/EX-12H/B112D/X127H/D614D/EV-X64H/V35X/AX318/D615D/R614H/KX315/EX-13H/B113D/X1285G/X1284G/X1285PG/X1284PG series: 1024x768 XGA resolution</li> <li>X135WH/D622D/EV-W62H/V32W/AW314/D620D+/X134PWH/R622H/KW314/EW-12H/B122D/X137WH/D624D/EV-W64H/V35W/AW318/D625D/R624H/KW315/EW-13H/B123D series: 1280x800 WXGA resolution</li> <li>H6517ABD/H6519ABD/E145F/HE-801K series: 1920x1080 1080p resolution</li> <li>Maximum: UXGA (1600 x 1200), WSXGA+ (1680x1050), 1080p(1920x1080), WUXGA-RB (1920 x 1200)</li> </ul>
Computer compatibility	IBM PC and compatibles, Apple Macintosh, iMac and VESA standards: SXGA, XGA, VGA, SVGA, SXGA+, WXGA, WXGA+, WSXGA +
Video compatibility	NTSC (3.58/4.43), PAL (B/D/G/H/I/M/N), SECAM (B/D/G/K/K1/L), HDTV (720p, 1080i, 1080p), EDTV (480p, 576p), SDTV (480i, 576i)
Aspect ratio	Auto, Full, 4:3, 16:9, L.Box
Displayable colors	1.07 billion colors
Optical zoom ratio	1.1X

## Throw ratio

- X115/D602/EV-S62/V31S/AS304/D600+/X114P/R602/KS304/ES-12/B102/X115AH/D602B/EV-S62A/V30S/AS313/D600H+/X114AH/R602D/KS314A/ES-12D/B102H/X115H/D602D/EV-S62H/V32S/AS314/D600D+/X114PH/R602H/KS314/ES-12H/B102D/X117/D604/EV-S64/V33S/AS307/D605/R604/KS305/ES-13/B103/X117AH/D604B/EV-S64A/V34S/AS317/D605H/R604D/KS315A/ES-13D/B103H/X117H/D604D/EV-S64H/V35S/AS318/D605D/R604H/KS315/ES-13H/B103D/X1185G/X1184G/X1185PG/X1184PG/X125H/D612D/EV-X62H/V32X/AX314/D610D+/X124PH/R612H/KX314/EX-12H/B112D/X127H/D614D/EV-X64H/V35X/AX318/D615D/R614H/KX315/EX-13H/B113D/X1285G/X1284G/X1285PG/X1284PG series: 1.94 ~ 2.16 (51" @2m)
- X135WH/D622D/EV-W62H/V32W/AW314/D620D+/X134PWH/R622H/KW314/EW-12H/B122D/X137WH/D624D/EV-W64H/V35W/AW318/D625D/R624H/KW315/EW-13H/B123D series: 1.54 ~ 1.72 (60" @2m)
- H6517ABD/H6519ABD/E145F/HE-801K series: 1.48 ~ 1.62 (100" @3.3m)

## Projection lens

- X115/D602/EV-S62/V31S/AS304/D600+/X114P/R602/KS304/ES-12/B102/X115H/D602D/EV-S62H/V32S/AS314/D600D+/X114PH/R602H/KS314/ES-12H/B102D/X115AH/D602B/EV-S62A/V30S/AS313/D600H+/X114AH/R602D/KS314A/ES-12D/B102H/X125H/D612D/EV-X62H/V32X/AX314/D610D+/X124PH/R612H/KX314/EX-12H/B112D/X135WH/D622D/EV-W62H/V32W/AW314/D620D+/X134PWH/R622H/KW314/EW-12H/B122D series:  
F = 2.41 ~ 2.53,  
f = 21.85mm ~ 24.01mm,  
Manual Zoom & Focus
- H6517ABD/H6519ABD/E145F/HE-801K series:  
F = 2.50 ~ 2.67,  
f = 21.86mm ~ 24.00mm,  
Manual Zoom & Focus

Projection screen size (diagonal)	<ul style="list-style-type: none"> <li>X115/D602/EV-S62/V31S/AS304/D600+/X114P/R602/KS304/ES-12/B102/X115AH/D602B/EV-S62A/V30S/AS313/D600H+/X114AH/R602D/KS314A/ES-12D/B102H/X115H/D602D/EV-S62H/V32S/AS314/D600D+/X114PH/R602H/KS314/ES-12H/B102D/X117/D604/EV-S64/V33S/AS307/D605/R604/KS305/ES-13/B103/X117AH/D604B/EV-S64A/V34S/AS317/D605H/R604D/KS315A/ES-13D/B103H/X117H/D604D/EV-S64H/V35S/AS318/D605D/R604H/KS315/ES-13H/B103D/X1185G/X1184G/X1185PG/X1184PG/X125H/D612D/EV-X62H/V32X/AX314/D610D+/X124PH/R612H/KX314/EX-12H/B112D/X127H/D614D/EV-X64H/V35X/AX318/D615D/R614H/KX315/EX-13H/B113D/X1285G/X1284G/X1285PG/X1284PG series: 23" ~ 300" (58cm ~ 762cm)</li> <li>X135WH/D622D/EV-W62H/V32W/AW314/D620D+/X134PWH/R622H/KW314/EW-12H/B122D/X137WH/D624D/EV-W64H/V35W/AW318/D625D/R624H/KW315/EW-13H/B123D series: 27" ~ 300" (69cm ~ 762cm)</li> <li>H6517ABD/H6519ABD/E145F/HE-801K series: 28" ~ 300" (71cm ~ 762cm)</li> </ul>
-----------------------------------	---

Projection distance	<ul style="list-style-type: none"> <li>X115/D602/EV-S62/V31S/AS304/D600+/X114P/R602/KS304/ES-12/B102/X115AH/D602B/EV-S62A/V30S/AS313/D600H+/X114AH/R602D/KS314A/ES-12D/B102H/X115H/D602D/EV-S62H/V32S/AS314/D600D+/X114PH/R602H/KS314/ES-12H/B102D/X117/D604/EV-S64/V33S/AS307/D605/R604/KS305/ES-13/B103/X117AH/D604B/EV-S64A/V34S/AS317/D605H/R604D/KS315A/ES-13D/B103H/X117H/D604D/EV-S64H/V35S/AS318/D605D/R604H/KS315/ES-13H/B103D/X1185G/X1184G/X1185PG/X1184PG/X125H/D612D/EV-X62H/V32X/AX314/D610D+/X124PH/R612H/KX314/EX-12H/B112D/X127H/D614D/EV-X64H/V35X/AX318/D615D/R614H/KX315/EX-13H/B113D/X1285G/X1284G/X1285PG/X1284PG series: 1.0m ~ 11.8m (3.3' ~ 38.8')</li> <li>X135WH/D622D/EV-W62H/V32W/AW314/D620D+/X134PWH/R622H/KW314/EW-12H/B122D/X137WH/D624D/EV-W64H/V35W/AW318/D625D/R624H/KW315/EW-13H/B123D series: 1.0m ~ 10.0m (3.3' ~ 32.7')</li> <li>H6517ABD/H6519ABD/E145F/HE-801K series: 1.0m ~ 9.8m (3.3' ~ 32.2')</li> </ul>
---------------------	--

Horizontal scan rate	15 - 100 kHz
Vertical refresh scan rate	24 - 120 Hz
Lamp type	195 W user-replaceable lamp
Keystone correction	±40 degrees
Audio	Internal speaker with 3 W x 1 output
Weight	2.5 Kgs (5.51lbs)
Dimensions (W x D x H)	314 mm X 223.4 mm X 93.4 mm (12.4" x 8.8" x 3.7")
Digital Zoom	2X
Power supply	AC input 100 - 240 V auto-switching power supply
Power consumption	Normal mode: 235W ± 10% @ 110VAC ECO mode: 195W ± 10% @ 110VAC Standby mode < 0.5W
Operating temperature	0°C to 40°C / 32°F to 104°F

## Standard package contents

- AC power cord x1
- VGA cable x1
- Remote control x1
- Battery x2 (for remote control) (option)
- User's guide (CD-ROM) x1 (option)
- Quick start guide x1
- Security card x1 (option)
- Dust filters x1 (option)
- Carrying case x1 (option)

I/O connectors	X115/D602/ EV-S62/V315/ AS304/ D600+/ X114P/R602/ KS304/ES-12/ B102/X117/ D604/EV-S64/ V335/AS307/ D605/R604/ KS305/ES-13/ B103	X115H/D602D/EV-S62H/ V32S/AS314/D600D+/ X114PH/R602H/KS314/ ES-12H/B102D/X117H/ D604D/EV-S64H/V355/ AS318/D605D/R604H/ KS315/ES-13H/B103D/ X125H/D612D/EV-X62H/ V32X/AX314/D610D+/ X124PH/R612H/KX314/ EX-12H/B112D/X127H/ D614D/EV-X64H/V35X/ AX318/D615D/R614H/ KX315/EX-13H/B113D/ X135WH/D622D/ EV-W62H/V32W/AW314/ D620D+X134PWH/ R622H/KW314/EW-12H/ B122D/X137WH/D624D/ EV-W64H/V35W/AW318/ D625D/R624H/KW315/ EW-13H/B123D/ H6519ABD	X115AH/ D602B/ EV-S62A/ V30S/ AS313/ D600H+/ X114AH/ R602D/ KS314A/ ES-12D/ B102H/ X117AH/ D604B/ EV-S64A/ V34S/ AS317/ D605H/ R604D/ KS315A/ ES-13D/ B103H	X1185G/ X1184G/ X1185PG/ X1184PG/ X1285G/ X1284G/ X1285PG/ X1284PG	H6517ABD/ E145F/ HE-801K
Power socket	V	V	V	V	V
VGA IN	V	V	V	V	V
3.5 mm audio jack input	X	V	X	X	V
S-Video	V	X	X	X	X
Composite video	V	X	X	X	X
RS232	X	X <sup>(*)</sup>	X	X	X
HDMI	X	V	V	X	V
Mini USB x1 (for firmware upgrade)	V	V	V	V	V



**Note 1:** Design and specifications are subject to change without notice.

**Note 2:** \* Functions vary depending on model definition.

# Compatibility modes

## A. VGA Analog

### 1 VGA Analog - PC Signal

Modes	Resolution	V.Frequency [Hz]	H.Frequency [KHz]
VGA	640x480	60	31.5
	640x480	72	37.9
	640x480	75	37.5
	640x480	85	43.3
	640x480	120	61.9
SVGA	800x600	56	35.1
	800x600	60	37.9
	800x600	72	48.1
	800x600	75	46.9
	800x600	85	53.7
XGA	800x600	120	77.4
	1024x768	60	48.4
	1024x768	70	56.5
	1024x768	75	60.0
	1024x768	85	68.7
SXGA	1024x768	120	99.0
	1152x864	70	63.8
	1152x864	75	67.5
	1152x864	85	77.1
	1280x1024	60	64.0
QuadVGA	1280x1024	72	77.0
	1280x1024	75	80.0
	1280x1024	85	91.1
	1280x960	60	60.0
	1280x960	75	75.2
SXGA+	1400x1050	60	65.3
UXGA	1600x1200	60	75.0
PowerBook G4	640x480	60	31.4
PowerBook G4	640x480	66.6(67)	34.9
PowerBook G4	800x600	60	37.9
PowerBook G4	1024x768	60	48.4
PowerBook G4	1152x870	75	68.7
PowerBook G4	1280x960	75	75.0
i Mac DV (G3)	1024x768	75	60.0

## 2 VGA Analog - Extended Wide timing

Modes	Resolution	V.Frequency [Hz]	H.Frequency [KHz]
WXGA	1280x768	60	47.8
	1280x768	75	60.3
	1280x768	85	68.6
	1280x720	60	44.8
	1280x720	120	92.9
	1280x800	60	49.6
	*1280x800-RB	119.909	101.6
WSXGA+	1440x900	60	59.9
	1680x1050	60	65.3
	1920x1080 (1080P)	60	67.5
	1366x768	60	47.7
WUXGA	1920x1200-RB	59.94	74.04

## 3 VGA Analog -Component Signal

Modes	Resolution	V.Frequency [Hz]	H.Frequency [KHz]
480i	720x480(1440x480)	59.94 (29.97)	15.7
576i	720x576(1440x576)	50(25)	15.6
480p	720x480	59.94	31.5
576p	720x576	50	31.3
720p	1280x720	60	45.0
720p	1280x720	50	37.5
1080i	1920x1080	60(30)	33.8
1080i	1920x1080	50(25)	28.1
1080p	1920x1080	23.97/24	27.0
1080p	*1920x1080	25	28.1
1080p	*1920x1080	29.97/30	33.8
1080p	1920x1080	60	67.5
1080p	1920x1080	50	56.3

## B. HDMI Digital

### 1 HDMI - PC Signal

Modes	Resolution	V.Frequency [Hz]	H.Frequency [KHz]
VGA	640x480	60	31.5
	640x480	72	37.9
	640x480	75	37.5



	640x480	85	43.3
	640x480	120	61.9
SVGA	800x600	56	35.1
	800x600	60	37.9
	800x600	72	48.1
	800x600	75	46.9
	800x600	85	53.7
	800x600	120	77.4
XGA	1024x768	60	48.4
	1024x768	70	56.5
	1024x768	75	60.0
	1024x768	85	68.7
	1024x768	120	99.0
SXGA	1152x864	70	63.8
	1152x864	75	67.5
	1152x864	85	77.1
	1280x1024	60	64.0
	1280x1024	72	77.0
	1280x1024	75	80.0
	1280x1024	85	91.1
QuadVGA	1280x960	60	60.0
	1280x960	75	75.2
SXGA+	1400x1050	60	65.3
UXGA	1600x1200	60	75.0
PowerBook G4	640x480	60	31.4
PowerBook G4	640x480	66.6(67)	34.9
PowerBook G4	800x600	60	37.9
PowerBook G4	1024x768	60	48.4
PowerBook G4	1152x870	75	68.7
PowerBook G4	1280x960	75	75.0
i Mac DV (G3)	1024x768	75	60.0

## 2 HDMI - Extended Wide timing

Modes	Resolution	V.Frequency [Hz]	H.Frequency [KHz]
WXGA	1280x768	60	47.8
	1280x768	75	60.3
	1280x768	85	68.6
	1280x720	60	44.8
	1280x720	120	92.9
	1280x800	60	49.6
	*1280x800-RB	119.909	101.6

	1440x900	60	59.9
WSXGA+	1680x1050	60	65.3
	1920x1080 (1080P)	60	67.5
	1366x768	60	47.7
WUXGA	1920x1200-RB	59.94	74.04

### 3 HDMI - Video Signal

Modes	Resolution	V.Frequency [Hz]	H.Frequency [KHz]
480i	720x480(1440x480)	59.94 (29.97)	15.7
576i	720x576(1440x576)	50(25)	15.6
480p	720x480	59.94	31.5
576p	720x576	50	31.3
720p	1280x720	60	45.0
720p	1280x720	50	37.5
1080i	1920x1080	60(30)	33.8
1080i	1920x1080	50(25)	28.1
1080p	1920x1080	23.97/24	27.0
1080p	1920x1080	60	67.5
1080p	*1920x1080	25	28.1
1080p	*1920x1080	29.97/30	33.8
1080p	1920x1080	50	56.3
1080p	*1920x1200-RB	59.94	74.04

### 4 HDMI - 1.4a 3D Timing

Modes	Resolution	V.Frequency [Hz]	H.Frequency [KHz]
720p (Frame Packing)	1280 x 720	50	37.5
720p (Frame Packing)	1280 x 720	60	45.0
1080p (Frame Packing)	1920 x1080	24	27.0
720p (Frame Packing)	1280 x 720	50	37.5
720p (Frame Packing)	1280 x 720	60	45.0
1080i (Top and Bottom)	1920 x1080	50 (25)	28.1
1080i (Top and Bottom)	1920 x1080	60 (30)	33.8
1080p (Top and Bottom)	1920 x1080	24	27.0
1080p (Top and Bottom)	1920 x1080	50	56.3
1080p (Top and Bottom)	1920 x1080	60	67.5
720p (Side by Side (Half))	1280 x 720	60	45.0
1080i (Side by Side (Half))	1920 x1080	50 (25)	28.1
1080i (Side by Side (Half))	1920 x1080	60 (30)	33.8

1080p (Side by Side (Half))	1920 x1080	50	56.3
1080p (Side by Side (Half))	1920 x1080	60	67.5
Graphic source monitor range limits	Horizontal scan rate:		15k-100kHz
	Vertical scan rate:		24-120 Hz
	Max. pixel rate:		Analog:165MHz Digital:165MHz



-----

**Note:** \* Functions vary depending on model definition.

# Regulations and safety notices

## FCC notice

This device has been tested and found to comply with the limits for a Class B digital device pursuant to Part 15 of the FCC rules. These limits are designed to provide reasonable protection against harmful interference in a residential installation. This device generates, uses, and can radiate radio frequency energy and, if not installed and used in accordance with the instructions, may cause harmful interference to radio communications.

However, there is no guarantee that interference will not occur in a particular installation. If this device does cause harmful interference to radio or television reception, which can be determined by turning the device off and on, the user is encouraged to try to correct the interference by one or more of the following measures:

- Reorient or relocate the receiving antenna.
- Increase the separation between the device and receiver.
- Connect the device into an outlet on a circuit different from that to which the receiver is connected.
- Consult the dealer or an experienced radio/television technician for help.

## Notice: Shielded cables

All connections to other computing devices must be made using shielded cables to maintain compliance with FCC regulations.

## Notice: Peripheral devices

Only peripherals (input/output devices, terminals, printers, etc.) certified to comply with the Class B limits may be attached to this equipment. Operation with non-certified peripherals is likely to result in interference to radio and TV reception.

## Caution

Changes or modifications not expressly approved by the manufacturer could void the user's authority, which is granted by the Federal Communications Commission, to operate this device.

## Operation conditions

This device complies with Part 15 of the FCC Rules. Operation is subject to the following two conditions: (1) this device may not cause harmful interference, and (2) this device must accept any interference received, including interference that may cause undesired operation.

## Notice: Canadian users

This Class B digital apparatus complies with Canadian ICES-003.

## Remarque à l'intention des utilisateurs canadiens

Cet appareil numérique de la classe B est conforme à la norme NMB-003 du Canada.

## Declaration of Conformity for EU countries

Acer hereby declares that this projector series is in compliance with the essential requirements and other relevant provisions of Directive 1999/5/EC.

Compliant with Russian regulatory certification



## Radio device regulatory notice



**Note:** The regulatory information below is for models with wireless LAN and/or Bluetooth only.

## General

This product complies with the radio frequency and safety standards of any country or region in which it has been approved for wireless use. Depending on configurations, this product may or may not contain wireless radio devices (such as wireless LAN and/or Bluetooth modules).

## Canada — Low-power license-exempt radio communication devices (RSS-247)

- a Common information
  - Operation is subject to the following two conditions:
    1. This device may not cause interference, and
    2. This device must accept any interference, including interference that may cause undesired operation of the device.
- b Operation in 2.4 GHz band
  - To prevent radio interference to the licensed service, this device is intended to be operated indoors and installation outdoors is subject to licensing.

## List of applicable countries

This device must be used in strict accordance with the regulations and constraints in the country of use. For further information, please contact the local office in the country of use. Please see <http://ec.europa.eu/enterprise/rte/implem.htm> for the latest country list.



**Acer Incorporated**  
8F, 88, Sec. 1, Xintai 5th Rd., Xizhi  
New Taipei City 221, Taiwan

## Declaration of Conformity

We, **Acer Incorporated**  
8F, 88, Sec. 1, Xintai 5th Rd., Xizhi, New Taipei City 221, Taiwan

And, **Acer Italy s.r.l.**  
Via Lepetit, 40, 20020 Lainate (MI) Italy  
Tel: +39-02-939-921 ,Fax: +39-02 9399-2913  
www.acer.it

**Product:** DLP Projector  
**Trade Name:** Acer  
**Model Number:** DSV1527/DSV1523/DNX1522/DWX1521/D1P1532/DNX1605/DSV1606/DSV1607  
**Marketing name:** X115/X117/X115AH/X117AH/X115H/X117H/X125H/X127H/X135WH/X137WH/  
X1185G/X1185PG/X1285G/X1285PG/H6517ABD/H6519ABD/D602/D604/D602B/  
D604B/D602D/D604D/D612D/D614D/D622D/D624D/X1184G/X1184PG/X1284G/  
X1284PG/E145F/EV-S62/EV-S64/EV-S62A/EV-S64A/EV-S62H/EV-S64H/EV-X62H/  
EV-X64H/EV-W62H/EV-W64H/HE-801K/V31S/V33S/V30S/V34S/V32S/V35S/V32X/  
V35X/V32W/V35W/AS304/AS307/AS313/AS317/AS314/AS318/AX314/AX318/  
AW314/AW318/D600+/D605/D600H+/D605H/D600D+/D605D/D610D+/D615D/  
D620D+/D625D/X114P/X114AH/X114PH/X124PH/X134PWH/R602/R604/R602D/  
R604D/R602H/R604H/R612H/R614H/R622H/R624H/KS304/KS305/KS314A/KS315A/  
KS314/KS315/KX314/KX315/KW314/KW315/ES-12/ES-13/ES-12D/ES-13D/ES-12H/  
ES-13H/EX-12H/EX-13H/EW-12H/EW-13H/B102/B103/B102H/B103H/B102D/B103D/  
B112D/B113D/B122D/B123D

We, Acer Incorporated, hereby declare under our sole responsibility that the product described above is in conformity with the relevant Union harmonization legislations as below Directive and following harmonized standards and/or other relevant standards have been applied:

**EMC Directive: 2014/30/EU**

<input checked="" type="checkbox"/> EN 55032:2012+AC:2013, Class B	<input checked="" type="checkbox"/> EN 61000-3-2:2014, Class A
<input checked="" type="checkbox"/> EN 55024:2010+A1:2015	<input checked="" type="checkbox"/> EN 61000-3-3:2013

**R&TTE Directive: 1999/5/EC (until Jun 12, 2017)**

**RED Directive: 2014/53/EU (From Jun 13, 2017)**

<input type="checkbox"/> EN 300 328 V1.9.1	<input type="checkbox"/> EN 301 511 V9.0.2	<input type="checkbox"/> EN 301 489-7 V1.3.1
<input type="checkbox"/> EN 301 893 V1.7.1	<input type="checkbox"/> EN 301 908-1 V6.2.1	<input type="checkbox"/> EN 301 489-17 V2.2.1
<input type="checkbox"/> EN 300 440-1 V1.6.1	<input type="checkbox"/> EN 301 908-2 V6.2.1	<input type="checkbox"/> EN 301 489-24 V1.5.1
<input type="checkbox"/> EN 300 440-2 V1.4.1	<input type="checkbox"/> EN 301 908-13 V6.2.1	<input type="checkbox"/> EN 50360:2001
<input type="checkbox"/> EN 302 291-1 V1.1.1	<input type="checkbox"/> EN 301 489-1 V1.9.2	<input type="checkbox"/> EN 62479:2010
<input type="checkbox"/> EN 302 291-2 V1.1.1	<input type="checkbox"/> EN 301 489-3 V1.6.1	<input type="checkbox"/> EN 62209-1:2006
		<input type="checkbox"/> EN 50566:2013
		<input type="checkbox"/> EN 62311:2008
		<input type="checkbox"/> EN 62209-2:2010

**LVD Directive: 2014/35/EU**

<input checked="" type="checkbox"/> EN 60950-1:2006/A11:2009/A1:2010/A12:2011/A2:2013
<input type="checkbox"/> EN 50332-1:2013
<input type="checkbox"/> EN 50332-2:2013

**RoHS Directive: 2011/65/EU**

<input checked="" type="checkbox"/> EN 50581:2012
---

**ErP Directive: 2009/125/EC**

<input checked="" type="checkbox"/> Regulation (EU) No. 617/2013	<input type="checkbox"/> Regulation (EC) No. 278/2009; EN 50563:2011
<input checked="" type="checkbox"/> Regulation (EC) No. 1275/2008; EN 50564:2011	

Year to begin affixing CE marking 2017.

*RU Jan*

**RU Jan / Sr. Manager**  
Acer Incorporated (Taipei, Taiwan)

**Mar. 31, 2017**  
Date



Acer America Corporation  
333 West San Carlos St.,  
Suite 1500  
San Jose, CA 95110  
U. S. A.  
Tel: 254-298-4000  
Fax: 254-298-4147  
www.acer.com



## Federal Communications Commission Declaration of Conformity

This device complies with Part 15 of the FCC Rules. Operation is subject to the following two conditions: (1) this device may not cause harmful interference, and (2) this device must accept any interference received, including interference that may cause undesired operation.

The following local Manufacturer / Importer is responsible for this declaration:

<b>Product:</b>	DLP Projector
<b>Model Number:</b>	DSV1527/DSV1523/DNX1522/DWX1521/D1P1532/ DNX1605/DSV1606/DSV1607
<b>Machine Type:</b>	X115/X117/X115AH/X117AH/X115H/X117H/X125H/ X127H/X135WH/X137WH/X1185G/X1185PG/ X1285G/X1285PG/H6517ABD/H6519ABD/D602/ D604/D602B/D604B/D602D/D604D/D612D/D614D/ D622D/D624D/X1184G/X1184PG/X1284G/X1284PG/ E145F/EV-S62/EV-S64/EV-S62A/EV-S64A/EV-S62H/ EV-S64H/EV-X62H/EV-X64H/EV-W62H/EV-W64H/ HE-801K/V31S/V33S/V30S/V34S/V32S/V35S/V32X/ V35X/V32W/V35W/AS304/AS307/AS313/AS317/ AS314/AS318/AX314/AX318/AW314/AW318/D600+/ D605/D600H+/D605H/D600D+/D605D/D610D+/ D615D/D620D+/D625D/X114P/X114AH/X114PH/ X124PH/X134PWH/R602/R604/R602D/R604D/ R602H/R604H/R612H/R614H/R622H/R624H/KS304/ KS305/KS314/KS315A/KS314/KS315/KX314/ KX315/KW314/KW315/ES-12/ES-13/ES-12D/ES-13D/ ES-12H/ES-13H/EX-12H/EX-13H/EW-12H/EW-13H/ B102/B103/B102H/B103H/B102D/B103D/ B112D/B113D/B122D/B123D
<b>Name of Responsible Party:</b>	Acer America Corporation
<b>Address of Responsible Party:</b>	333 West San Carlos St. Suite 1500 San Jose, CA 95110 U. S. A.
<b>Contact Person:</b>	Acer Representative
<b>Phone No.:</b>	254-298-4000
<b>Fax No.:</b>	254-298-4147

## Free Manuals Download Website

<http://myh66.com>

<http://usermanuals.us>

<http://www.somanuals.com>

<http://www.4manuals.cc>

<http://www.manual-lib.com>

<http://www.404manual.com>

<http://www.luxmanual.com>

<http://aubethermostatmanual.com>

Golf course search by state

<http://golfingnear.com>

Email search by domain

<http://emailbydomain.com>

Auto manuals search

<http://auto.somanuals.com>

TV manuals search

<http://tv.somanuals.com>