

# Aspire 1410/1680 Series

## User's Guide

Copyright © 2004. Acer Incorporated.  
All Rights Reserved.

Aspire 1410/1680 Series User's Guide  
Original Issue: July 2004

Changes may be made periodically to the information in this publication without obligation to notify any person of such revision or changes. Such changes will be incorporated in new editions of this manual or supplementary documents and publications. This company makes no representations or warranties, either expressed or implied, with respect to the contents hereof and specifically disclaims the implied warranties of merchantability or fitness for a particular purpose.

Record the model number, serial number, purchase date, and place of purchase information in the space provided below. The serial number and model number are recorded on the label affixed to your computer. All correspondence concerning your unit should include the serial number, model number, and purchase information.

No part of this publication may be reproduced, stored in a retrieval system, or transmitted, in any form or by any means, electronic, mechanical, photocopy, recording, or otherwise, without the prior written permission of Acer Incorporated.

Aspire 1410/1680 Series Notebook Computer

Model Number : \_\_\_\_\_

Serial Number: \_\_\_\_\_

Purchase Date: \_\_\_\_\_

Place of Purchase: \_\_\_\_\_

Acer and the Acer logo are registered trademarks of Acer Incorporated. Other company's product names or trademarks are used herein for identification purposes only and belong to their respective companies.

# First things first

We would like to thank you for making the Aspire series of notebook computers your choice for your mobile computing needs. We hope you will be happy with your Aspire as much as we enjoyed making it for you.

## Your guides

To help you use your Aspire, we have designed a set of guides:



First off, the **Just for starters...** poster helps you get started with setting up your computer.



This **User's guide** introduces you to the many ways your computer can help you be more productive. This guide provides clear and concise information about the computer, so read it thoroughly.

If you ever need to print out a copy, this User's guide is also available in Portable Document Format (PDF). Follow these steps:

- 1 Click on **Start, All Programs, AcerSystem**.
- 2 Click on **AcerSystem User's guide**.

**Note:** Viewing the file requires Adobe Acrobat Reader installed. If Adobe Acrobat Reader is not installed on your computer, clicking on Aspire User's guide will run the Acrobat Reader setup program first. Follow the instructions on the screen to complete the installation. For instructions on how to use Adobe Acrobat Reader, access the **Help and Support** menu.

## Basic care and tips for using your computer

### Turning your computer on and off

To turn on the computer, simply press and release the power switch below the LCD screen beside the launch keys. See “Front view” on page 3 for the location of the power switch.

To turn the power off, do any of the following:

- Use the Windows shutdown command

Click on **Start, Turn Off Computer**; then click on **Turn Off**.

- Use the power switch



.....  
**Note:** You can also use the power switch to perform power management functions. See “Power management” on page 27.

- Use the customized functions for power management

You can also shut down the computer by closing the display cover, or by pressing the sleep hot key (**Fn-F4**). See “Power management” on page 27.



.....  
**Note:** If you cannot power off the computer normally, press and hold the power switch for more than four seconds to shut down the computer. If you turn off the computer and want to turn it on again, wait at least two seconds before powering up.

### Taking care of your computer

Your computer will serve you well if you take care of it.

- Do not expose the computer to direct sunlight. Do not place it near sources of heat, such as a radiator.
- Do not expose the computer to temperatures below 0°C (32°F) or above 50°C (122°F).
- Do not subject the computer to magnetic fields.
- Do not expose the computer to rain or moisture.
- Do not spill water or any liquid on the computer.
- Do not subject the computer to heavy shock and vibration.
- Do not expose the computer to dust and dirt.

- Never place objects on top of the computer to avoid damaging the computer.
- Do not slam the computer display when you close it.
- Never place the computer on uneven surfaces.

### Taking care of your AC adapter

Here are some ways to take care of your AC adapter:

- Do not connect the adapter to any other device.
- Do not step on the power cord or place heavy objects on top of it. Carefully route the power cord and any cables away from personal traffic.
- When unplugging the power cord, do not pull on the cord itself but pull on the plug.
- The total ampere ratings of the equipment plugged in should not exceed the ampere rating of the cord if you are using an extension cord. Also, the total current rating of all equipment plugged into a single wall outlet should not exceed the fuse rating.

### Taking care of your battery pack

Here are some ways to take care of your battery pack:

- Use only batteries of the same kind as replacements. Turn the power off before removing or replacing batteries.
- Do not tamper with batteries. Keep them away from children.
- Dispose of used batteries according to local regulations. Recycle if at all possible.

### Cleaning and servicing

When cleaning the computer, follow these steps:

- 1 Power off the computer and remove the battery pack.
- 2 Disconnect the AC adapter.
- 3 Use a soft cloth moistened with water. Do not use liquid or aerosol cleaners.

If any of the following occurs:

- The computer has been dropped or the body has been damaged.
- Liquid has been spilled into the product.
- The computer does not operate normally.

Please refer to "Troubleshooting my computer" on page 59.

First things first	iii
Your guides	iii
Basic care and tips for using your computer	iv
1 Getting to know your Aspire	1
A Aspire tour	3
Front view	3
Closed front view	5
Left view	7
Right view	8
Rear view	9
Bottom view	10
Features	11
Indicators	13
Using the keyboard	15
Lock keys	15
Embedded numeric keypad	16
Windows keys	17
Hot keys	18
Special Key	20
Launch keys	21
Touchpad	23
Touchpad basics	23
Storage	25
Hard disk	25
Optical drive	25
Audio	27
Adjusting the volume	27
Power management	27
Moving around with your Aspire	28
Disconnecting from the desktop	28
Moving around	28
Taking the computer home	29
Traveling with the computer	31
Traveling internationally with the computer	32
Securing your computer	33
Using a computer security lock	33
2 Customizing my computer	35
Expanding through options	37
Connectivity options	37
Upgrade options	42

# Contents

Using system utilities	44
Acer eManager	44
Launch Manager	45
BIOS Utility	45
Windows Arcade	46
Arcade Hot keys	47
Finding and playing content	48
Arcade controls	49
Cinema	50
Album	52
Video	54
Music	55
Burner	55
Acer Disc to Disc Recovery	57
Multilingual operating system installation	57
Restore without a Recovery CD	57
Setup password and exit	58
3 Troubleshooting my computer	59
Frequently-asked questions	61
Troubleshooting tips	64
Error messages	65
Requesting service	66
ITW	66
Before you call	67
Appendix A Specifications	69
Appendix B	
Regulation & safety notices	75
Index	91



1 Getting to know your  
*Aspire*

Your Aspire computer combines high-performance, versatility, power management features and multimedia capabilities with a unique style and ergonomic design. Work with unmatched productivity and reliability with your new power computing partner.

## A Aspire tour

After setting up your computer as illustrated in the **Just for starters...** poster, let us show you around your new Aspire computer.

### Front view





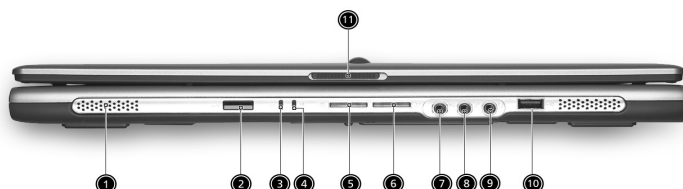

#	Item	Description
1	Display screen	Also called Liquid-Crystal Display (LCD), displaying computer output.
2	Microphone	Internal microphone for sound recording.
3	Keyboard	Inputs data into your computer.

#	Item	Description
4	Palmrest	Comfortable support area for your hands when you use the computer.
5	Click buttons (Left, center and right)	The left and right buttons function like the left and right mouse buttons; the center button serves as a 4-way scroll button.
6	Touchpad	Touch-sensitive pointing device which functions like a computer mouse.
7	Status indicators	Light-Emitting Diodes (LEDs) that turn on and off to show the status of the computer's functions and components.
8	Launch keys	Buttons for launching frequently used programs. See "Launch keys" on page 21 for more details.
9	Power button	Turns the computer on and off.

## Closed front view



#	Item	Description
1	Speakers	Left and right speakers deliver stereo audio output.
2	Infrared port (Manufacturing option)	Interfaces with infrared devices (e.g., infrared printer and IR-aware computer).
3	Power indicator	Lights when the computer is on.
4	Battery indicator	Lights when the battery is being charged.
5	Bluetooth communications	Lights to indicate the status of Bluetooth (optional) communications.
6	Wireless communications	Lights to indicate the status of wireless LAN (optional) communications.

#	Item	Description
7	Line-in/Mic-in jack 	Accepts audio line-in devices (e.g., audio CD player, stereo walkman).
8	Line-in/Mic-in jack 	Accepts audio line-in devices (e.g., audio CD player, stereo walkman).
9	Speaker/Line-Out/ Headphone jack 	Connects to audio line-out devices (e.g., speakers, headphones).
10	USB 2.0 port 	Connects to Universal Serial Bus (USB) 2.0 devices (e.g., USB mouse, USB camera).
11	Latch	Locks and releases the lid.



**Note:** The Bluetooth and Wireless buttons and indicators only work on models with Bluetooth and Wireless features, respectively.



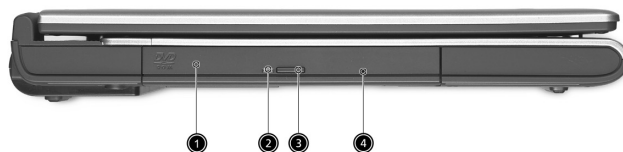



## Left view

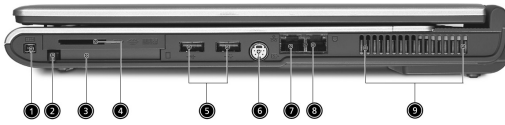

#	Item	Description
1	Optical drive	Internal optical drive; accepts CDs or DVDs depending on the optical drive type.
2	LED indicator	Lights up when the optical drive is active.
3	Optical drive eject button	Ejects the optical drive tray from the drive.
4	Emergency eject hole	Ejects the optical drive tray when the computer is turned off. See page 62 for more details.

# Right view





#	Item	Description
1	IEEE 1394 port (Manufacturing option) 	Connects to IEEE 1394 devices.
2	PC Card slot eject button	Ejects the PC Card from the slot.
3	PC Card slot 	Connects to one Type II CardBus PC Card.
4	3-in-1 card reader 	Accepts MS, MMC and SD cards. <b>Note:</b> The 3-in-1 card reader is a manufacturing option, subject to configuration. Only one card can operate at any given time.
5	Two USB 2.0 ports 	Connect to Universal Serial Bus (USB) 2.0 devices (e.g., USB mouse, USB camera).
6	S-video port (Manufacturing option) 	Connects to a television or display device with S-video input.
7	Network jack 	Connects to an Ethernet 10/100/1000-based network (manufacturing option).
8	Modem jack 	Connects to a phone line.
9	Ventilation slots	Enable the computer to stay cool, even after prolonged use.



## Rear view



#	Item	Description
1	Power jack 	Connects to an AC adapter.
2	External display port 	Connects to a display device (e.g., external monitor, LCD projector).
3	Security keylock 	Connects to a Kensington-compatible computer security lock.

## Bottom view

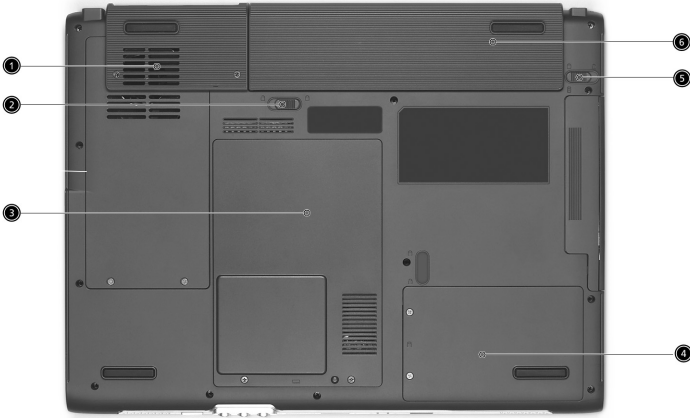

#	Item	Description
1	Cooling fan	Helps keep the computer cool. <b>Note:</b> Do not cover or obstruct the opening of the fan.
2	Battery lock	Locks the battery in place.
3	Memory compartment	Houses the computer's main memory.
4	Hard disk bay	Houses the computer's hard disk (secured by a screw).
5	Battery release latch	Unlatches the battery to remove the battery pack.
6	Battery bay	Houses the computer's battery pack.

# Features

Below is a brief summary of the computer's many features:

## Performance

- Intel® Pentium® M Processor 705, 715, 725, 735, 745, 755, or Intel® Celeron® M Processor 320, 330
- Intel® 855GME or 852GM chipset (manufacturing option)
- 256/512 MB of DDR333 SDRAM standard, upgradeable to 2048 MB with dual soDIMM modules
- 30 GB and above high-capacity, Enhanced-IDE hard disk
- Advanced Configuration Power Interface (ACPI) power management system
- Li-ion main battery pack

## Display

- The TFT LCD panel providing a large viewing area for maximum efficiency and ease-of-use:
  - 14.1" XGA (1024x768) resolution
  - 15.0" XGA (1024x768) or SXGA+ (1400x1050) resolution
  - 15.4" WXGA (1280x800) or WSXGA+ (1680x1050) resolution
- ATI MOBILITY™ RADEON™ 9700 with 64MB of video memory (manufacturing option)
- 3D graphics support
- Simultaneous LCD and CRT monitor, and other display devices like projector support
- "Automatic LCD dim" feature that automatically deciding the best settings for your display and conserves power
- Dual independent display

## Multimedia

- High-speed drive:  
DVD/CD-RW Combo, DVD-Dual or DVD-Super Multi
- 16-bit high-fidelity AC'97 stereo audio
- Built-in microphone and dual speakers

## Connectivity

- Integrated 10/100/1000 Mbps Fast Ethernet connection (manufacturing option)
- Built-in 56Kbps fax/data modem
- Fast Infrared wireless communication (manufacturing option)
- IEEE 1394 port (manufacturing option)
- Three Universal Serial Bus (USB) 2.0 ports
- InviLink™ 802.11b/g dual-band Wireless LAN (manufacturing option)
- Bluetooth® (manufacturing option)
- SD/MMC/MS memory card reader (manufacturing option)

## Human-centric design and ergonomics

- Rugged, yet extremely portable design
- Stylish appearance
- Full-size keyboard with four programmable launch keys
- Ergonomically-centered touchpad pointing device
- Internet 4-way scroll button



## Expansion

- One Type II CardBus PC Card slot
- Upgradeable memory modules

## Indicators



The computer has three easy-to-read status icons on the upper-right above the keyboard.



Icon	Function	Description
	Caps Lock	Lights when Caps Lock is activated.
	Num Lock	Lights when Num Lock is activated.
	Media activity	Lights when the hard disk or optical drive is active.

In addition, there are two indicators at the front panel. Even when the cover is closed, the state or features can still be seen.



Icon	Function	Description
	Power	Lights when the computer is on.
	Battery indicator	Lights when the battery is being charged.

## Using the keyboard

The keyboard has full-sized keys and an embedded keypad, separate cursor keys, two Windows keys and twelve function keys.

### Lock keys

The keyboard has three lock keys which you can toggle on and off.



Lock Key	Description
Caps Lock	When Caps Lock is on, all alphabetic characters typed are in uppercase.
Num Lock (Fn-F11)	When Num Lock is on, the embedded keypad is in numeric mode. The keys function as a calculator (complete with the arithmetic operators +, -, *, and /). Use this mode when you need to do a lot of numeric data entry. A better solution would be to connect an external keypad.
Scroll Lock (Fn-F12)	When Scroll Lock is on, the screen moves one line up or down when you press the up or down arrow keys respectively. Scroll Lock does not work with some applications.

## Embedded numeric keypad

The embedded numeric keypad functions like a desktop numeric keypad. It is indicated by small characters located on the upper right corner of the keycaps. To simplify the keyboard legend, cursor-control key symbols are not printed on the keys.













Desired Access	Num Lock On	Num Lock Off
Number keys on embedded keypad	Type numbers in a normal manner.	
Cursor-control keys on embedded keypad	Hold <b>Shift</b> while using cursor-control keys.	Hold <b>Fn</b> while using cursor-control keys.
Main keyboard keys	Hold <b>Fn</b> while typing letters on embedded keypad.	Type the letters in a normal manner.



## Windows keys

The keyboard has two keys that perform Windows-specific functions.





Key	Description
Windows key 	Pressed alone, this key has the same effect as clicking on the Windows Start button; it launches the Start menu. It can also be used with other keys to provide a variety of functions: <ul style="list-style-type: none"> <li><b> + Tab</b>      Activates the next Taskbar button.</li> <li><b> + E</b>            Opens the My Computer window.</li> <li><b> + F1</b>            Opens Help and Support.</li> <li><b> + F</b>              Opens the Find: All Files dialog box.</li> <li><b> + M</b>            Minimizes all windows.</li> <li><b>Shift +  + M</b>      Undoes the minimize all windows (<b> + M</b>) action.</li> <li><b> + R</b>              Opens the Run dialog box.</li> </ul>
Application key 	This key has the same effect as clicking the right mouse button; it opens the application's context menu.













## Hot keys

The computer employs hot keys or key combinations to access most of the computer's controls like screen brightness, volume output and the BIOS Utility.

To activate hot keys, press and hold the **Fn** key before pressing the other key in the hot key combination.



Hot Key	Icon	Function	Description
<b>Fn-F1</b>	?	Hot key help	Displays help on hot keys.
<b>Fn-F2</b>		Acer eSetting	Launches the Acer eSetting in the Acer eManager set by the Acer Empowering Key. See "Acer eManager" on page 44.
<b>Fn-F3</b>		Acer ePowerManagement	Launches the Acer ePowerManagement in the Acer eManager set by the Acer Empowering Key. See "Acer eManager" on page 44.
<b>Fn-F4</b>	Z <sup>Z</sup>	Sleep	Puts the computer in Sleep mode.

Hot Key	Icon	Function	Description
<b>Fn-F5</b>		Display toggle	Switches display output between the display screen, external monitor (if connected) and both the display screen and external monitor.
<b>Fn-F6</b>		Screen blank	Turns the display screen backlight off to save power. Press any key to return.
<b>Fn-F7</b>		Touchpad toggle	Turns the internal touchpad on and off.
<b>Fn-F8</b>		Speaker toggle	Turns the speakers on and off.
<b>Fn-↑</b>		Volume up	Increases the sound volume.
<b>Fn-↓</b>		Volume down	Decreases the sound volume.
<b>Fn-→</b>		Brightness up	Increases the screen brightness.
<b>Fn-←</b>		Brightness down	Decreases the screen brightness.
<b>Fn-Home</b>		Play/Pause	Press to start playing the audio track or video file. Press again to pause.
<b>Fn-Pg Up</b>		Stop	Press to stop playing the audio track or video file.
<b>Fn-Pg Dn</b>		Backwards	Press to skip backward to the previous track or video file and start playing.
<b>Fn-End</b>		Forward	Press to skip forward to the next track or video file.

Hot Key	Icon	Function	Description
<b>Alt Gr-\$</b>	\$	US dollar	Types the US dollar sign.
<b>Alt Gr-Euro</b>	€	Euro	Types the Euro symbol.

## Special Key

You can locate the Euro symbol and US dollar sign at the upper-center and/or bottom-right of your keyboard. To type:



### The Euro symbol

- 1 Open a text editor or word processor.
- 2 Either directly press the **Euro** symbol at the bottom-right of the keyboard, or hold **Alt Gr** and then press the **Euro** symbol at the upper-center of the keyboard.

### The US dollar sign

- 1 Open a text editor or word processor.
- 2 Either directly press the **dollar** sign at the bottom-right of the keyboard, or hold **Alt Gr** and then press the **dollar** sign at the upper-center of the keyboard.



**Note:** This function varies by the operating system version.

## Launch keys

Located at the upper-right above the keyboard are four buttons. These buttons are called launch keys. They are designated as the mail, Web browser, Empowering and programmable keys.



Press the Acer Empowering Key to run the Acer eManager. Please see "Acer eManager" on page 44. The mail and Web browser are default for Email and Internet programs, but can be reset by users. To set the mail, Web browser and programmable keys, run the Acer Launch Manager. See "Launch Manager" on page 45.



No.	Description	Default Application
1	Mail	Email application (User-programmable)
2	Web browser	Internet browser application (User-programmable)
3	e	Acer eManager application (User-programmable)
4	P	User-programmable

In addition, there are two launch keys at the front panel. Even when the cover is closed, you can easily access the features of Wireless and Bluetooth®. However, the Wireless and Bluetooth keys cannot be reset by users.



No.	Description	Default Application
1	Bluetooth communications 	Lights to indicate the status of Bluetooth (optional) communications.
2	Wireless communications 	Lights to indicate the status of wireless LAN (optional) communications.

## Touchpad

The built-in touchpad is a PS/2-compatible pointing device that senses movement on its surface. This means the cursor responds as you move your finger on the surface of the touchpad. The central location on the palmrest provides optimum comfort and support.



**Note:** When using an external USB or serial mouse, you can press **Fn-F7** to disable the touchpad.



### Touchpad basics

The following items teach you how to use the touchpad:



- Move your finger across the touchpad to move the cursor.
- Press the left **(1)** and right **(3)** buttons located on the edge of the touchpad to do selection and execution functions. These two buttons are similar to the left and right buttons on a mouse. Tapping on the touchpad produces similar results.
- Use the 4-way scroll **(2)** button to scroll up or down and move left or right a page. This button mimics your cursor pressing on the right scroll bar of Windows applications.

Function	Left Button	Right Button	Center Button	Tap
Execute	Click twice quickly.			Tap twice (at the same speed as double-clicking a mouse button).
Select	Click once.			Tap once.
Drag	Click and hold, then use finger to drag the cursor on the touchpad.			Tap twice (at the same speed as double-clicking a mouse button) then hold finger to the touchpad on the second tap and drag the cursor.
Access context menu		Click once.		
Scroll			Click and hold the up/ down/ left/ right.	



**Note:** Keep your fingers dry and clean when using the touchpad. Also keep the touchpad dry and clean. The touchpad is sensitive to finger movements. Hence, the lighter the touch, the better the response. Tapping harder will not increase the touchpad's responsiveness.



# Storage

This computer supplies you with the following media storage:

## Hard disk

The high-capacity hard disk is the answer to your storage needs. This is where your data files and applications are stored.

## Optical drive

Your computer comes equipped with an optical drive which may be one of the following:

- DVD/CD-RW Combo
- DVD-Dual
- DVD-Super Multi

### Ejecting the CD or DVD tray

To eject the DVD tray when the computer is turned on, press the drive eject button; then pull out the tray.



When the power is off, you can eject the drive tray using the emergency eject hole. See page 62.

## Playing DVD movies

When the DVD drive module is installed in the optical drive bay, you can play DVD movies on your computer.

- 1 Eject the DVD tray and insert a DVD movie disc; then close the DVD tray.



**Important!** When you launch the DVD player for the first time, the program asks you to input the region code. DVD discs are divided into 6 regions. Once your DVD drive is set to a region code, it will play DVD discs of that region only. You can set the region code a maximum of five times (including the first time), after which the last region code set will remain permanent. Recovering your hard disk does not reset the number of times the region code has been set. Refer to the table later in this section for DVD movie region code information.

- 2 The DVD movie will automatically play after a few seconds.

Region Code	Country or Region
1	U.S.A., Canada
2	Europe, Middle East, South Africa, Japan
3	Southeast Asia, Taiwan, South Korea
4	Latin America, Australia, New Zealand
5	Former U.S.S.R., parts of Africa, India
6	People's Republic of China



**Note:** To change the region code, insert a DVD movie of a different region into the DVD drive.

## Audio

The computer comes with 16-bit high-fidelity AC'97 stereo audio and microphone. The built-in dual stereo speakers are easy to access.



There are audio ports on the front panel of the computer. See “Closed front view” on page 5 for more information on external audio devices.

## Adjusting the volume

Adjusting the volume on the computer is as easy as pressing some buttons. See “Hot keys” on page 18 for more information on adjusting the speaker volume.

## Power management

This computer has a built-in power management unit that monitors system activity. System activity refers to any activity involving one or more of the following devices: keyboard, mouse, hard disk, peripherals connected to the USB ports, and video memory. If no activity is detected for a period of time (called an inactivity timeout), the computer stops some or all of these devices in order to conserve energy.

This computer employs a power management scheme that supports Advanced Configuration and Power Interface (ACPI), which allows for maximum power conservation and maximum performance at the same time. Windows handles all power-saving chores for your computer.

## Moving around with your Aspire

This section gives you tips and hints on things to consider when moving around or traveling with your computer.

### Disconnecting from the desktop

Follow these steps to disconnect your computer from external accessories:

- 1 Save your work in progress.
- 2 Remove any media or compact disc from the drive(s).
- 3 Shut down the operating system.
- 4 Turn off the computer.
- 5 Close the display cover.
- 6 Disconnect the cord from the AC adapter.
- 7 Disconnect the keyboard, pointing device, printer, external monitor, and other external devices.
- 8 Disconnect the Kensington lock if you are using one to secure the computer.

### Moving around

“when you are just moving within short distances, for example, from your office desk to a meeting room”

#### Preparing the computer

Before moving the computer, close and latch the display cover to place it in Sleep mode. You can now safely take the computer anywhere you go within the building. To bring the computer out of Sleep mode, open the display.

If you are taking the computer to a client's office or a different building, you may choose to shut down the computer:

- 1 Click on **Start, Turn Off Computer**.
  - 2 Click on **Turn Off**.
- or -

you can put the computer in Sleep mode by pressing **Fn-F4**. Then close and latch the display.

When you are ready to use the computer again, unlatch and open the display, and press and release the power switch. If the power indicator is off, the computer has entered Hibernation mode and turned off.

Press and release the power switch to turn the computer back on.

Note that the computer may enter Hibernation mode after a period of time it is in Sleep mode. Turn the power on to wake up the computer from Hibernation mode.

### What to bring to short meetings

A fully charged battery runs the computer for about two hours under most circumstances. If your meeting is shorter than that, you probably do not need to bring anything with you other than the computer.

### What to bring to long meetings

If your meeting lasts longer than two hours or if your battery is not fully charged, you may want to bring the AC adapter with you to plug in your computer in the meeting room.

If the meeting room does not have an electrical outlet, reduce the drain on the battery by putting the computer in Sleep mode. Press **Fn-F4** or close the display cover whenever you are not actively using the computer. Then tap any key or open the display to resume.

## Taking the computer home

“when you are moving from your office to your home or vice versa”

### Preparing the computer

After disconnecting the computer from your desktop, follow these steps to prepare the computer for the trip home:

- Check if you have removed all media and compact discs from the drive(s). Failure to remove the media can damage the drive head.
- Pack the computer in a protective case that can prevent the computer from sliding around and cushion it if it should fall.



.....  
**Caution:** Avoid packing items next to the top cover of the computer. Pressure against the top cover can damage the screen

## What to bring with you

Unless you already have some items at home, bring the following items with you:

- AC adapter and power cord
- The printed user's guide

## Special considerations

Follow these guidelines to protect your computer while traveling to and from work:

- Minimize the effect of temperature changes by keeping the computer with you.
- If you need to stop for an extended period of time and cannot bring the computer with you, leave the computer in the trunk of the car to avoid exposing the computer to excessive heat.
- Changes in temperature and humidity can cause condensation. Allow the computer to return to room temperature, and inspect the screen for condensation before turning on the computer. If the temperature change is greater than 18°F (10°C), allow the computer to come to room temperature slowly. If possible, leave the computer for 30 minutes in an environment with a temperature between outside and room temperature.

## Setting up a home office

If you frequently work on your computer at home, you may want to purchase a second AC adapter for use at home. With a second AC adapter, you can avoid transporting the extra weight to and from home.

If you use your computer at home for significant periods of time, you might also want to add an external keyboard, monitor, or mouse.

## Traveling with the computer

“when you are moving within a larger distance, for instance, from your office building to a client’s office building or traveling locally”

### Preparing the computer

Prepare the computer as if you were taking it home. Make sure that the battery in the computer is charged. Airport security may require you to turn on your computer when bringing it into the gate area.

### What to bring with you

Bring the following items with you:

- AC adapter
- Spare, fully-charged battery pack(s)
- Additional printer driver files if you plan to use another printer

### Special considerations

In addition to the guidelines for taking the computer home, follow these guidelines to protect your computer while traveling:

- Always take the computer as carry-on luggage.
- If possible, have the computer inspected by hand. Airport security X-ray machines are safe, but do not put the computer through a metal detector.
- Avoid exposing floppy disks to hand-held metal detectors.

## Traveling internationally with the computer

“when you are moving from country to country”

### Preparing the computer

Prepare the computer as you would normally prepare it for traveling.

### What to bring with you

Bring the following items with you:

- AC adapter
- Power cords that are appropriate for the country to which you are traveling
- Spare, fully-charged battery packs
- Additional printer driver files if you plan to use another printer
- Proof of purchase, in case you need to show it to customs officials
- International Traveler’s Warranty passport

### Special considerations

Follow the same special considerations as when traveling with the computer. In addition, these tips are useful when traveling internationally:

- When traveling in another country, check that the local AC voltage and the AC adapter power cord specifications are compatible. If not, purchase a power cord that is compatible with the local AC voltage. Do not use converter kits sold for appliances to power the computer.
- If you are using the modem, check if the modem and connector is compatible with the telecommunications system of the country you are traveling in.



## Securing your computer

Your computer is a valuable investment that you need to take care of. Learn how to protect and take care of your computer.

Security features include hardware and software locks — a security lock and passwords.

### Using a computer security lock

A security keylock notch located on the rear panel of the computer lets you connect a Kensington-compatible computer security lock.

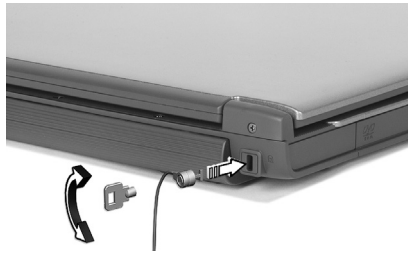

Wrap a computer security lock cable around an immovable object such as a table or locked drawer handle. Insert the lock into the notch and turn the key to secure the lock. Some keyless models are also available.

### Setting a password

Passwords protect your computer from unauthorized access. When set, no one can access the computer without entering the correct password.

There are three types of passwords you can set:

- 1 Supervisor Password secures your computer against unauthorized entry to and use of the BIOS Utility.
- 2 User Password secures your computer against unauthorized use.
- 3 Hard Disk Password protects your data by preventing unauthorized access to your hard disk.



.....  
**Important! Do not forget your Setup and Hard Disk passwords! If you forget your passwords, please get in touch with your dealer or an authorized service center.**

You can set the passwords using the BIOS Utility.



## 2 Customizing my computer

After learning the basics of your Aspire computer, let's get acquainted with the advanced features of your computer. In this chapter, you will learn how to add options, upgrade components for better performance, and customize your computer.

# Expanding through options

Your Aspire offers you a complete mobile computing experience.

## Connectivity options

Ports allow you to connect peripheral devices to your computer as you would with a desktop PC.

### Modem

Your computer has a built-in V.92 56Kbps AC'97 Link modem.



.....  
**Warning! This modem port is not compatible with digital phone lines. Plugging this modem into a digital phone line will damage the modem.**

To use the modem, connect a phone cable from the modem jack to a phone line jack.

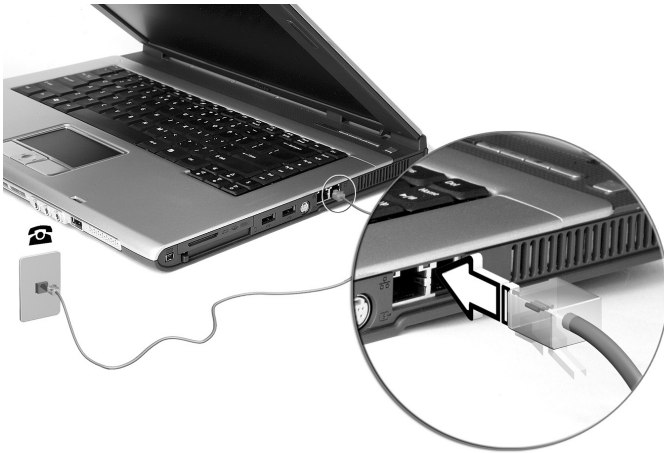

.....  
**Warning: Please use the delivered phone cable in the country of use.**

## Network

Your computer has built-in Ethernet/Fast Ethernet capabilities. To use the network feature, connect an Ethernet cable from the network jack or hub. Consult your network administrator for details.

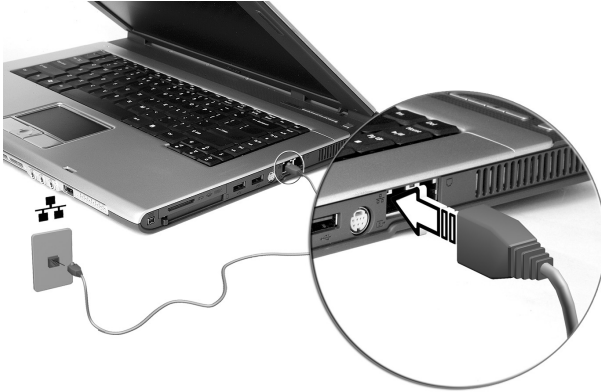

## Fast infrared

The computer's fast infrared (FIR) port allows you to do wireless data transfer with other IR-aware computers and peripherals such as PDAs (personal digital assistants), mobile phones, and infrared printers. The infrared port can transfer data at speeds of up to four megabits per second (Mbps) at a distance of up to one meter.



**Note:** The Fast Infrared feature is available on certain models only.

## Universal Serial Bus

The Universal Serial Bus (USB) 2.0 port is a high-speed serial bus which allows you to connect and daisy-chain USB peripherals without taking up precious system resources. Your computer has three ports available.



## IEEE 1394 port

The computer's IEEE 1394 port allows you to connect to an IEEE 1394 supported devices like a video camera or digital camera.



**Note:** The IEEE 1394 feature is available on certain models only. See your video or digital camera's documentation for details.

## PC Card slot

There is one Type II CardBus PC Card slot found on the right side of the computer. The slot accepts credit-card-sized cards that enhance the usability and expandability of the computer. These cards should have a PC Card logo on them.

PC Cards (formerly PCMCIA) are add-on cards for portable computers, giving you expansion possibilities long afforded by desktop PCs. CardBus improves on the 16-bit PC card technology by expanding the bandwidth to 32 bits.



.....  
**Note:** Refer to your card manual for details on how to install and use the card and its functions.

## Inserting a PC Card

Insert the card into the slot and make the proper connections (e.g., network cable), if necessary. See your card manual for details.





## Ejecting a PC Card

Before ejecting a PC Card:

- 1 Exit the application using the card.
- 2 Left-click on the Safely Remove Hardware icon on the taskbar and click on the PC Card item. Click **OK** to confirm.
- 3 Press the slot eject button (1) to pop out the eject button; then press it again to eject the card (2).



## 3-in-1 card reader (Manufacturing Option)

There is one 3-in-1 card reader found on the right side of the computer. See "Right view" on page 8. The reader accepts Secure Digital (SD), MultiMediaCard (MMC) and Memory Stick (MS) to enhance usability. To insert the card, align and push the card into the slot. To remove, simply press on the card that will eject automatically.

## Upgrade options

Your computer delivers superior power and performance. However, some users and the applications they use may demand more. This computer allows you to upgrade key components when you need increased performance.



-----  
**Note:** Contact your authorized dealer if you decide to perform a key component upgrade.

### Memory upgrade

Memory is expandable to 2 GB, employing DDR 266/333 256MB/512MB/1GB SDRAM modules. The computer supports shadow RAM.

There are two memory slots on your computer. Upgrade memory by inserting a higher capacity DIMM into one or both of these slots.

### Installing memory

Follow these steps to install memory:

- 1 Turn off the computer, unplug the AC adapter (if connected) and remove the battery pack. Then turn the computer over to access its base.
- 2 Remove the screw from the memory cover (1), then lift up and remove the memory cover (2).

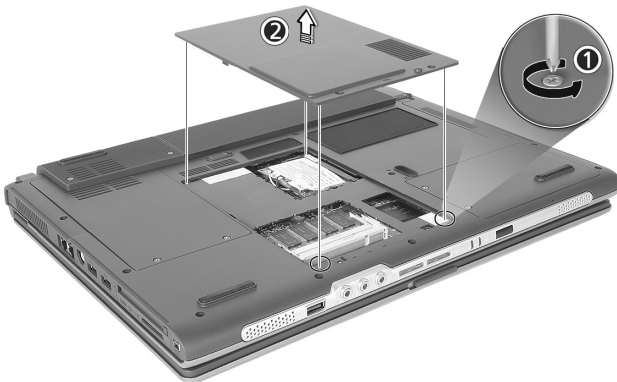

- 3 Insert the memory module diagonally into the slot **(1)**, then gently press it down until it clicks into place **(2)**.

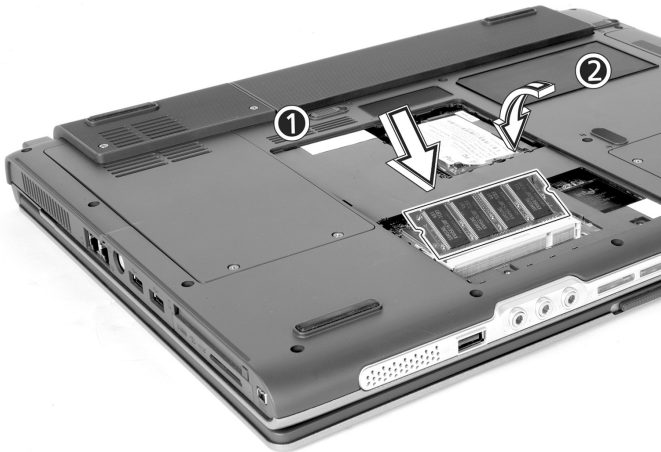

- 4 Replace the memory cover and secure it with the screw.

The computer automatically detects and reconfigures the total memory size.

## Using system utilities

### Acer eManager

Acer eManager is an innovative software designed for frequently used functions. At the press of the Acer Empowering Key, the Acer eManager user interface appears, featuring three main settings -- Acer eSetting, Acer ePresentation and Acer ePowerManagement (selected models).

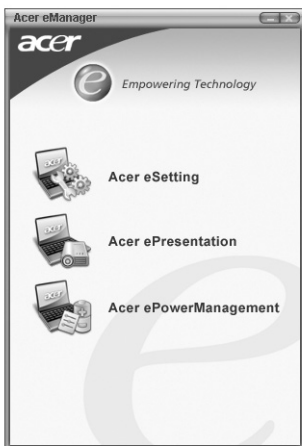

To set the Acer Empowering Key, see "Launch keys" on page 21.

## Launch Manager

The Acer Launch Manager allows you to set the programmable launch keys, including the default mail and Web browser keys, as well as the Empowering and P keys. The Wireless and Bluetooth keys cannot be set by users. See “Launch keys” on page 21 for more information.

You can access the Launch Manager by clicking on **Start, All Programs,** and then **Launch Manager** to start the application.

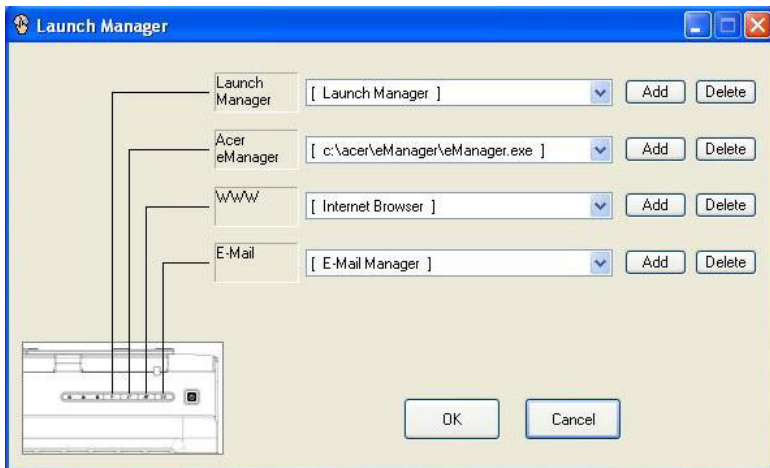

## BIOS Utility

The BIOS Utility is a hardware configuration program built into your computer's Basic Input/Output System (BIOS).

Your computer is already properly configured and optimized, and you do not need to run this utility. However, if you encounter configuration problems, you may need to run it.

To activate the BIOS Utility, press **F2** during the Power-On Self Test (POST) while the Aspire logo is being displayed.

# Windows Arcade

Arcade is an integrated player for music, photos, DVD movies, and videos. To watch or listen, click a content button (e.g. Music, Video, etc...) on the Arcade home page.



**Cinema** - watch DVDs or VCDs

**Album** - view photos stored on your hard drive or any removable media

**Video**- watch and/or edit video clips

**Music** - listen to music files in a variety of formats

**Burner** - create CDs and/or DVDs to share or archive data

**Advanced Settings** - adjust Arcade according to your preferences



.....

**Note:** While watching videos, DVDs, or slideshows your screensaver and power-saving features are unavailable. These functions are enabled when you listen to music.

## Arcade Hot keys

When running in the Windows environment, the key combinations listed below are available to control and fine-tune the features and settings of Arcade.

Hot key	Function
<b>Fn+F1</b>	On-line help menu
<b>Fn+F3</b>	ePowerManagement with battery info
<b>Fn+F5</b>	Display toggle
<b>Fn+F6</b>	Screen blank
<b>Fn+F8</b>	Speaker toggle
<b>Fn + ↑</b>	Volume up; increases the speaker volume.
<b>Fn + ↓</b>	Volume down; decreases the speaker volume
<b>Fn + →</b>	Brightness up; increases the screen brightness
<b>Fn + ←</b>	Brightness down; decreases the screen brightness
<b>Fn + Home</b>	Play; press to start playing the audio track or video file. Press again to pause.
<b>Fn + Pg Up</b>	Stop; press to stop playing the audio track or video file.
<b>Fn + Pg Dn</b>	Backward; press to skip backward to the previous track or video file and start playing.
<b>Fn + End</b>	Forward; press to skip forward to the next track or video file.

## Finding and playing content

Clicking a button on the Arcade home page opens the corresponding feature's home page. The content pages have buttons on the left and a content browsing area on the right. If a button shows one of several choices, such as sort order, the current setting is shown by a brightly coloured ball on the left side.

To pick content, click an item in the content area. When there is more than one CD or DVD drive, all drives will be shown. Pictures and videos are shown as files (with thumbnails) and organized into folders.

To browse a folder, click to open it. To go back up to the folder above it, click the **Up one level** button. If there is more content than will fit on a page, use the buttons at the lower right to scroll through the pages.

## Advanced Settings

There are settings in the Arcade that allow you to fine tune its performance to your machine and your personal preferences. The Settings page is reached by the **Advanced Settings** button on the Home page.

Use the "Screen ratio" setting to choose between standard (4:3) or widescreen (16:9) display.



**Note:** If your speakers are not capable of outputting low frequency signals, it is recommended that you do not select this option in order to avoid damaging your speakers.

"Audio output" should be set to "Stereo" if you are listening to speakers, or "Virtual surround sound" if you are using headphones, or "SPDIF" if you are using digital output.

Click **About Arcade** to open a page with version and copyright information.

Click **Restore to factory settings** to return the Arcade settings to their default values.



## Arcade controls

When watching video clips, movies, or slideshows as full-screen visual content two pop-up control panels are shown when you move the mouse. They automatically disappear after several seconds. The “Navigation controls” panel appears at the top and the “Player controls” panel appears at the bottom of the screen.

### Navigation controls

To return to the Arcade home page, click the **Home** button in the upper left corner of the window. To go up one folder level while searching for content, click **Up one level**. To return to a previous screen, click **Return**. The buttons in the upper right (Minimize, Maximize, and Close) have standard PC behaviours.

To quit Arcade, click the **Close** button in the upper right corner of the window. You can also click **To PC**.

### Player controls

At the bottom of the window, the player controls - used for video, slideshows, movies and music - are shown. The group on the left provides standard playback controls (play, pause, stop, etc...). The group on the right controls volume (mute and volume up/down).



.....

**Note:** When playing DVDs, there are additional controls added to the right of the volume controls. These are discussed in more detail in the Cinema section of this guide.

## Cinema

If your computer came with a DVD drive, you can play movies from DVDs and Video CDs (VCDs) with the Cinema function of Arcade. This player has the features and controls of a typical living room DVD player.

When you insert a disc into the DVD drive, the movie begins playing automatically. To control the movie, the pop-up player control panel appears at the bottom of the window when you move the mouse.

If more than one optical drive contains a playable disc, click the **Cinema** button on the Home page to open the Cinema content page - then select the disc from the list on the right you'd like to watch.

When viewing DVDs, the following special controls are added to the pop-up panel:

- DVD Menu
- Subtitle
- Language
- Angle

The currently playing disc will be shown in the area above the list of drives. This page is also displayed when you press the "Stop" button during a movie. The buttons on the left side allow you to resume the movie from the point it was stopped, restart the movie from the beginning, jump to the DVD menu, eject the disc, or go to the DVD Settings page.

### DVD settings

There are two types of DVD settings - "Video" and "Language." Click the appropriate button to open its settings page.

#### Video

The Video settings control the video output of DVDs/VCDs.

"Use hardware acceleration" takes advantage of the special processing power in some graphics cards to reduce CPU loading when playing back DVDs and some video files. If you have problems with video quality, try turning this option "Off."

Select an output type:

- **4:3 Standard** or **16:9 Widescreen** according to your display preferences
- The **Letterbox** option displays complete widescreen movie content in its original aspect ratio and adds black bars at the top and bottom of the screen.
- The **Pan & Scan** feature is for DVD titles with a widescreen aspect ratio.
- **Cinema vision** is a nonlinear video stretching technology that produces minimal distortion in the centre of the picture.
- **Stretch** stretches the video display to the size of the display screen.

The "Colour profile" option allows you to select from a list of colour configurations to change the overall colour of the video content during playback. "Original" uses the colour scheme of the disc you are watching, while "Vivid," "Bright," and "Theatre" add enhanced colour to the video display.

"Clear vision" is a video enhancement technology that detects video content and dynamically adjusts the brightness/contrast/saturation levels so that you do not need to change the colour settings if the movie you are watching contains scenes that are overly dark or too bright.

Click **Restore to factory settings** to return the settings to their default values.

## Language

The Language settings control the audio and subtitle output of DVDs/VCDs.

"Subtitle" selects the default subtitle language for DVDs when available. The factory setting is "Off."

"Closed caption" turns on the closed captions on DVDs. This function displays captions encoded in the video signal that describe on screen action and dialogue for the hearing impaired. the factory setting is "Off."

"Audio" selects the default language for DVD titles.

## Album

Arcade lets you view digital photos individually or as a slideshow, from any available drive on your computer. Click **Album** button on the Arcade Home page to show the Album main page.



The content area on the right shows both individual pictures and folders. Click on a folder to open it.



To view a slideshow, open the folder containing the pictures you wish to view - then click **Play slideshow**. The slideshow is played full-screen. Use the pop-up control panel to control the slideshow.

To rotate a picture in full-screen, click **Rotate right** or **Rotate left**.

You can also view a single picture by clicking on it. This opens the picture full-screen.

### Slideshow settings

To change slideshow settings click the **Settings** button on the Album page.

The "Slide duration" setting determines how long each slide is shown before automatically advancing to the next picture in the slideshow.

The "Transition effects" setting sets the style of transition used between pictures.

To add background music to a slideshow, set the "Play music during slideshow" option to "Yes." The select music page asks you to choose music from your personal music library.

Click **Restore to factory settings** to return your settings to their default values.

## Video

To open the Video function, click **Video** on the Arcade Home page, to open the Video Home page.



**Note:** The Video feature is designed for video file playback of MPEG1, MPEG2 (if a DVD drive is installed), AVI, WMV, and ASF formats. If you want to watch a DVD or VCD use the Cinema function.

Two options are shown on the Video page - "Video Play" or "Video Edit."

### Playing a video file

Click **Video Play** to watch video files. The Video page shows the video files in the content area on the right side. They are organized by folders and a thumbnail image shows the first frame of the video.

To play a video file, click on it. the video will play full-screen. The pop-up control panel will appear at the bottom of the screen when you move the mouse. To return to the Video page, click "Stop."

### Editing a video file

Click the **Video Edit** to open the PowerDirector program.

PowerDirector is a digital video editing program that can help you create professional looking movies - complete with music, special effects and transition effects. PowerDirector provides home users with a simple tool to help them do something a little more creative with their home videos. You don't have to be a video professional to enjoy using PowerDirector.

The digital movie production process involves a combination of artistry and technology, beginning with raw video footage and ending with a movie.

Before you edit your movie using PowerDirector, you must first create (or gather) it's component parts - video clips, photos, and music.

When you have your raw footage on hand, you can use PowerDirector to perform the following tasks:

- acquire video and audio content
- trim video and audio content to desired length
- add a special effect to a video clip
- adjust the sharpness, contrast, and/or color of a video clip
- add transition effects between video clips
- preview your production
- burn your production to a VCD or DVD

For help with editing video, refer to PowerDirector's online help system.

## Music

For convenient access to your music collection, click the **Music** on the Arcade Home page, to open the Music Home page.

Select the folder that contains the music you want to listen to. Click "Play" to listen to the entire CD from the beginning, or select the song that you want to hear from the list in the content area.

The songs in the folder are shown in the content area, while the left side has controls for "Play", "Random", and "Repeat all." The Visualize option allows you to watch computer generated visualizations while you listen to music. When playing music, the control panel at the bottom of the page makes it easy to adjust the volume and control play-back.

To rip music from a CD, click **Rip CD**. In the page that opens, select the songs you would like to rip (or click "Select"/"Clear all") - then click "Rip now".

## Burner

NTI CD/DVD-Maker simplifies today's digital lifestyle by providing an easy and complete solution for recording data, audio, photos or video. Now you can burn and share anything on CD/DVD - your music just the way you like it, your photos, your videos. Even copy your critical data faster and easier than ever before.

### Copy - backup your CD/DVD collection

Make backup copies of (non-copy protected) CDs in just a few clicks of your mouse. Copy non-copy protected DVDs too!

### Audio - create your own greatest hits CDs

Create better sounding music in a snap. Burn your favourite songs to CD so you can listen to them on any CD player. Convert songs from your music collection to MP3 and other popular audio formats. Even create MP3 CDs with over 100 of your favourite songs and listen to them on you PC or MP3 CD player.

### Data - store files simply and easily

Copy your computer's hard drive files for easy recovery in the event of a crash. archiving your data on CD/DVD eliminates the need for extra hard drives.

### Video - your world in pictures

Turn digital photos into a Slideshow VCD with background music that can be played by most DVD players. Bring new life to your video clips and share any event with your friends and family for playback on most DVD players. You can even add customized menus to Video CDs and Super Video CDs.

For Specific details about each of these options, consult the User's Guide or click the **Help** button to open NTI CD/DVD-Maker's help menu.

### File type compatibility

Mode	Supported	Not Supported
Cinema	DVD/ SVCD VCD/MiniDVD	DTS, LIner PCM, TruSurroundXT, SRS, DVD audio
Video	ASF/WMV/AVI MPEG1/2 DivX (requires codec)	DVD navigator, SVCD, M2V, MOV, Flash
Album	BMP, JPG, PNG	GIF, TIF, PSD, ICO
Music	MP3, WMA, WAV, CDA(Audio CD)	DVD audio, SACD



**Note:** Auto media detection will only function under main menu.



## Acer Disc to Disc Recovery



.....

**Note:** This feature is only available on certain models.

### Multilingual operating system installation

Follow the instructions to choose the operating system and language you use when you first power-on the system.

- 1 Turn on the system.
- 2 Acer multilingual operating system selection menu will pop-up automatically.
- 3 Use the arrow keys to scroll to the language version you want. Press Enter to confirm your selection.
- 4 The operating system and language you choose now will be the only option for future recovery operations.
- 5 The system will install the operating system and language you choose.

### Restore without a Recovery CD

This recovery process helps you restore the C: drive with the original software content that is installed when you purchase your notebook. Follow the steps below to rebuild your C: drive. (Your C: drive will be reformatted and all data will be erased.) It is important to back up all data files before you use this option.

Before performing a restore operation, please check the BIOS settings.

- a Check to see if "Hard Disk Recovery" function is enabled or not.
- b Make sure the **[Hard Disk Recovery]** setting in **[Advanced]** is **[Enabled]**.
- c Exit the BIOS Setup Utility and save changes. The system will reboot.



.....

**Note:** To activate BIOS Setup Utility, press <F2> during POST.

- 1 Restart the system.
- 2 The instruction "Press <F2> to Enter BIOS" is shown at the bottom of the screen, during POST.
- 3 Press <Alt> + <F10> at the same time to enter the recovery process.
- 4 The message "The system has password protection. Please enter 000000:" is displayed.
- 5 Enter six 0s and continue.
- 6 "Acer Self-Configuration Preload" window appears.
- 7 Use the arrow keys to scroll through the items (operating system versions) and press "Enter" to select.

## Setup password and exit

Press "F3" to setup password or press "F5" to exit the system recovery process when "Acer Self-Configuration Preload" window appears.

If "F3" is pressed, the next screen shows "Please enter new password:" enter one to eight alphanumeric characters. You will be asked to reenter your password for confirmation before continuing.

The screen will display "Password has been created. Press any key to reboot...", hit any key to reboot your system.

If "F5" is pressed, the recovery process will be terminated and the system will reboot and start normally.



.....  
**Important:** This feature occupies 2 GB in a hidden partition on your hard drive.

# 3 Troubleshooting my computer

This chapter instructs you on how to deal with common system problems. Read it before calling a technician if a problem occurs. Solutions to more serious problems require opening up the computer. Do not attempt to open the computer by yourself. Contact your dealer or an authorized service center for assistance.

## Frequently-asked questions

The following is a list of possible situations that may arise during the use of your computer. Easy answers and solutions are provided for each one.

I pressed the power switch and opened the display, but the computer does not start or boot-up.

Look at the Power indicator:

- If it is not lit, no power is being applied to the computer. Check the following:
  - If you are running on battery power, it may be low and unable to power the computer. Connect the AC adapter to recharge the battery pack.
  - Make sure that the AC adapter is plugged in properly to the computer and to the power outlet.
- If it is lit, check the following:
  - If the Sleep indicator is lit, the computer is in Sleep mode. Press any key or tap on the touchpad to resume.

Nothing appears on the screen.

The computer's power management system automatically blanks the screen to save power. Press any key to turn the display back on.

If pressing a key does not turn the display back on, two things might be the cause:

- The brightness level might be too low. Press **Fn**→ to increase the brightness level.
- The display device might be set to an external monitor. Press the display toggle hot key **Fn-F5** to toggle the display back to the computer.

Image is not full-screen.

Make sure that the resolution is set to 1024x768. This is the native resolution of your computer display. Right-click on your Windows desktop and select Properties to bring up the **Display Properties** dialog box. Then click on the Settings tab to make sure that the resolution is set to the appropriate resolution. Resolutions lower than the specified resolution are not full-screen on the computer or on an external monitor.

No audio is heard from the computer.

Check the following:

- The volume may be muted. In Windows, look at the volume control (speaker) icon on the taskbar. If it is crossed-out, click on the icon and deselect the Mute option.
- The speakers may be turned off. Press **Fn-F8** to turn the speakers on (this hot key also turns the speakers off).
- The volume level may be too low. In Windows, look at the volume control icon on the taskbar.
- If headphones, earphones or external speakers are connected to the line-out port on the computer's right panel, the internal speakers automatically turn off.

I want to eject the CD or DVD tray without turning on the power. I cannot eject the CD or DVD tray.

There is a mechanical eject button on the optical drive. Simply insert the tip of a pen or paperclip and push to eject the tray.



The CD or DVD drive cannot access a disc.

Check the following:

- Make sure the disc is supported by the drive. If your computer connects to a CD-ROM drive, it can read CDs but cannot read DVDs. If your computer has a DVD drive, it can read DVDs in addition to CDs.
- When placing the CD or DVD in the drive tray, make sure it is secure in the spindle on the drive tray.
- Make sure the CD or DVD is free from scratches or smudges. If the CD or DVD is dirty, clean it using a disc cleaning kit. Remember to follow the instructions included with the kit.
- If the problem does not lie with the disc, your CD or DVD drive may be dirty. Clean it using a drive cleaning kit. Follow the instructions included with the kit.

The keyboard does not respond.

Try attaching an external keyboard to the USB connector on the computer's rear. If it works, contact your dealer or an authorized service center as the internal keyboard cable may be loose.

The infrared port does not work.

Check the following:

- Make sure that the infrared ports of the two devices are facing each other (+/- 15 degrees) a maximum of 1 meter apart.
- Make sure there is a clear path between the two infrared ports. Nothing should be blocking the ports.
- Make sure you have the appropriate software running on both devices (for file transfers) or you have the appropriate drivers (for printing to an infrared printer).
- During the POST, press **F2** to access the BIOS Utility and verify that the infrared port is enabled.
- Make sure both devices are IrDA-compliant.

The printer does not work.

Check the following:

- Make sure that the printer is connected to a power outlet and that it is turned on.
- Depending on your connection (USB or parallel), make sure that the printer cable is connected securely to the appropriate port on your computer and the corresponding port on the printer.
- During POST, press **F2** to access the BIOS Utility and verify that the parallel port is enabled if you use a parallel printer.

I want to set up my location to use the internal modem.

To properly use your communications software, you need to set up your location:

- 1 Click on **Start, Setting, Control Panel**.
- 2 Double-click on **Phone and Modem Options**.
- 3 Click on the **Dialing Rules** tab and begin setting up your location. Refer to Windows Help and Support.

## Troubleshooting tips

This notebook computer incorporates an advanced design that delivers onscreen error message reports to help you solve problems.

If the system reports an error message or an error symptom occurs, see "Error messages" on page 65. If the problem cannot be resolved, contact your dealer. See "Error messages" on page 65.



## Error messages

If you receive an error message, note the message and take the corrective action. The following table lists the error messages in alphabetical order together with the recommended course of action.

Error Messages	Corrective Action
CMOS Battery Bad	Contact your dealer or an authorized service center.
CMOS Checksum Error	Contact your dealer or an authorized service center.
Disk Boot Failure	Insert a system (bootable) diskette into the floppy drive (A:), then press <b>Enter</b> to reboot.
Equipment Configuration Error	Press <b>F2</b> (during POST) to enter the BIOS Utility; then press <b>Esc</b> to exit and reconfigure the computer.
Hard Disk 0 Error	Contact your dealer or an authorized service center.
Hard Disk 0 Extended Type Error	Contact your dealer or an authorized service center.
I/O Parity Error	Contact your dealer or an authorized service center.
Keyboard Error or No Keyboard Connected	Contact your dealer or an authorized service center.
Keyboard Interface Error	Contact your dealer or an authorized service center.
Memory Size Mismatch	Press <b>F2</b> (during POST) to enter the BIOS Utility; then press <b>Esc</b> to exit and reconfigure the computer.

If you still encounter problems after going through the corrective measures, please contact your dealer or an authorized service center for assistance. Some problems may be solved using the BIOS Utility.

## Requesting service

### ITW

Your computer is backed by an International Traveler's Warranty (ITW) that gives you security and peace of mind when traveling. Our worldwide network of service centers are there to give you a helping hand.

An ITW passport comes with your computer. This passport contains all you need to know about the ITW program. A list of available, authorized service centers is in this handy booklet. Read this passport thoroughly.

Always have your ITW passport on hand, especially when you travel to receive the benefits from our support centers. Place your proof-of-purchase in the flap located inside the front cover of the ITW passport.

If the country you are traveling in does not have an Acer-authorized ITW service site, you can still get in contact with our offices worldwide.

There are two ways to access Acer for technical support and information:

- Internet service worldwide ([www.acersupport.com](http://www.acersupport.com))
- Technical support numbers in various countries

You can view a list of technical support numbers by following these steps:

- 1 Click on **Start, Setting, Control Panel**.
- 2 Double-click on **System**.
- 3 Click on the **Support Information** button.

## Before you call

Please have the following information available when you call Acer for online service, and please be at your computer when you call. With your support, we can reduce the amount of time a call takes and help solve your problems efficiently.

If there are error messages or beeps reported by your computer, write them down as they appear on the screen (or the number and sequence in the case of beeps).

You are required to provide the following information:

Name: \_\_\_\_\_

Address: \_\_\_\_\_

\_\_\_\_\_

Telephone number: \_\_\_\_\_

Machine and model type: \_\_\_\_\_

Serial number: \_\_\_\_\_

Date of purchase: \_\_\_\_\_



Appendix A  
Specifications

This appendix lists the general specifications of your computer.

## Microprocessor

- Intel® Pentium® M Processor 705, 715, 725, 735, 745, 755, or Intel® Celeron® M Processor 320, 330

## Memory

- 256/512 MB of DDR333 SDRAM standard, upgradeable to 2048 MB with dual soDIMM modules
- 512 KB flash ROM BIOS

## Data storage

- One 30 GB and above E-IDE hard disk (2.5", 9.5mm, UltraDMA-100)
- One internal optical drive
- 3-in-1 Card Reader (manufacturing option)

## Display and video

- Thin-Film Transistor (TFT) displaying at:
  - 14.1" XGA (1024x768) resolution
  - 15.0" XGA (1024x768) or SXGA+ (1400x1050) resolution
  - 15.4" WXGA (1280x800) or WSXGA+ (1680x1050) resolution
- ATI MOBILITY™ RADEON™ 9700 with 64 MB of video memory (manufacturing option)
- Simultaneous LCD and CRT display support
- Dual independent display
- "Automatic LCD dim" feature that automatically deciding the best settings for your display and conserves power

## Connectivity

- Integrated 10/100/1000 Mbps Fast Ethernet connection (manufacturing option)
- Built-in 56Kbps fax/data modem
- Three Universal Serial Bus (USB) 2.0 ports
- InviLink™ 802.11b/g dual-band Wireless LAN (manufacturing option)
- Bluetooth® (manufacturing option)

## Audio

- 16-bit AC'97 stereo audio
- Dual speakers and one internal microphone
- Separate audio ports for headphone-out, line-in and microphone-in devices

## Keyboard and pointing device

- 88/89-key Windows keyboard
- Ergonomically-centered touchpad pointing device with scroll function

## I/O ports

- One Type II PC Card slot
- One RJ-11 phone jack (V.92, 56Kbps modem)
- One RJ-45 network jack
- One DC-in jack (AC adapter)
- One external monitor port
- One speaker/headphone-out jack (3.5mm mini jack)
- One audio line-in jack (3.5mm mini jack)
- One microphone-in jack (3.5mm mini jack)
- One Infrared (FIR) port (manufacturing option)
- One IEEE 1394 port (manufacturing option)
- One S-video TV-out port (manufacturing option)
- Three USB 2.0 ports
- 3-in-1 MS/MMC/SD card reader (manufacturing option)

## Weight (with battery)

- 14.1" display model: 2.75 kg (6.06 lbs)
- 15.0" display model: 2.91 kg (6.42 lbs)
- 15.4" display model: 2.95 kg (6.48 lbs)



## Dimensions

- 364.0(W) x 279.0(D) x 38.9(max. H) mm, w/ battery
- 364.0(W) x 275.0(D) x 33.9(max. H) mm, w/o battery

## Environment

- Temperature:
  - Operating: 5°C ~ 35°C
  - Non-operating: -20°C ~ 65°C
- Humidity (non-condensing):
  - Operating: 20% ~ 80% RH
  - Non-operating: 20% ~ 80% RH

## System

- Microsoft® Windows® XP Home/Pro
- ACPI 1.0b support
- DMI 2.0-compliant
- Wi-Fi®-compliant
- CCX compliant (certain models only)

## Power

- 3-cell (23W), 4-cell (32W) or 8-cell (60W) Li-ion battery pack
- 65W AC adapter 19V 3.42A

## Options

- 256MB/512MB/1GB memory upgrade module
- Additional 65W AC adapter
- Addition Li-ion battery pack
- Additional hard disk
- USB floppy drive



Appendix B

Regulation &  
safety notices

This appendix lists the general notices for your computer.

## Energy Star Guidelines Compliance

As an Energy Star Partner, Acer Inc. has determined that this product meets the Energy Star guidelines for energy efficiency.

### FCC notice

This device has been tested and found to comply with the limits for a Class B digital device pursuant to Part 15 of the FCC Rules. These limits are designed to provide reasonable protection against harmful interference in a residential installation. This device generates, uses, and can radiate radio frequency energy and, if not installed and used in accordance with the instructions, may cause harmful interference to radio communications.

However, there is no guarantee that interference will not occur in a particular installation. If this device does cause harmful interference to radio or television reception, which can be determined by turning the device off and on, the user is encouraged to try to correct the interference by one or more of the following measures:

- Reorient or relocate the receiving antenna.
- Increase the separation between the device and receiver.
- Connect the device into an outlet on a circuit different from that to which the receiver is connected.
- Consult the dealer or an experienced radio/television technician for help.

### Notice: Shielded cables

All connections to other computing devices must be made using shielded cables to maintain compliance with FCC regulations.

### Notice: Peripheral devices

Only peripherals (input/output devices, terminals, printers, etc.) certified to comply with the Class B limits may be attached to this equipment. Operation with non-certified peripherals is likely to result in interference to radio and TV reception.

### Caution

Changes or modifications not expressly approved by the manufacturer could void the user's authority, which is granted by the Federal Communications Commission, to operate this computer.

### Operation conditions

This device complies with Part 15 of the FCC Rules. Operation is subject to the following two conditions: **(1)** this device may not cause harmful interference, and **(2)** this device must accept any interference received, including interference that may cause undesired operation.

### Notice: Canadian users

This Class B digital apparatus complies with Canadian ICES-003.

### Remarque à l'intention des utilisateurs canadiens

Cet appareil numérique de la classe B est conforme à la norme NMB-003 du Canada.

### Declaration of Conformity for EU countries

Hereby, Acer, declares that this Aspire series is in compliance with the essential requirements and other relevant provisions of Directive 1999/5/EC. (Please visit [www.acer.com/about/certificates/nb](http://www.acer.com/about/certificates/nb) for complete documents.)

### Modem notices

#### Notice for USA

This equipment complies with Part 68 of the FCC rules. Located on the bottom side of the modem is a label that contains, among other information, the FCC Registration Number and Ringer Equivalence Number (REN) for this equipment. Upon request, you must provide this information to your telephone company.

If your telephone equipment causes harm to the telephone network, the telephone company may discontinue your service temporarily. If possible, they will notify you in advance. But, if advance notice is not practical, you will be notified as soon as possible. You will also be informed of your right to file a complaint with the FCC.

Your telephone company may make changes in its facilities, equipment, operations, or procedures that could affect the proper functioning of your equipment. If they do, you will be notified in advance to give you an opportunity to maintain uninterrupted telephone service.

If this equipment should fail to operate properly, disconnect the equipment from the phone line to determine if it is causing the problem. If the problem is with the equipment, discontinue use and contact your dealer or vendor.



.....  
**Caution:** To reduce the risk of fire, use only No. 26 AWG or larger UL Listed or CSA Certified Telecommunication Line Cord.

## TBR 21

This equipment has been approved [Council Decision 98/482/EC - "TBR 21"] for single terminal connection to the Public Switched Telephone Network (PSTN). However, due to differences between the individual PSTNs provided in different countries, the approval does not, of itself, give an unconditional assurance of successful operation on every PSTN termination point. In the event of problems, you should contact your equipment supplier in the first instance.

## List of Applicable Countries

EU member states as of May 2004 are: Belgium, Denmark, Germany, Greece, Spain, France, Ireland, Italy, Luxembourg, the Netherlands, Austria, Portugal, Finland, Sweden, United Kingdom Estonia, Latvia, Lithuania, Poland, Hungary, Czech Republic, Slovak Republic, Slovenia, Cyprus and Malta. Usage allowed in the countries of European Union, as well as Norway, Switzerland, Iceland and Liechtenstein. This device must be used in strict accordance with the regulations and constraints in the country of use. For further information, please contact local office in the country of use.

## Notice for Australia

For safety reasons, only connect headsets with a telecommunications compliance label. This includes customer equipment previously labelled permitted or certified.

## Notice for New Zealand

### **For Modem with approval number PTC 211/03/008**

- 1 The grant of a Telepermit for any item of terminal equipment indicates only that Telecom has accepted that the item complies with minimum conditions for connection to its network. It indicates no endorsement of the product by Telecom, nor does it provide any sort of warranty. Above all, it provides no assurance that any item will work correctly in all respects with another item of Telepermitted equipment of a different make or model, nor does it imply that any product is compatible with all of Telecom's network services.
- 2 This equipment is not capable, under all operating conditions, of correct operation at the higher speeds for which it is designed. Telecom will accept no responsibility should difficulties arise in such circumstances.
- 3 Some parameters required for compliance with Telecom's Telepermit requirements are dependent on the equipment (PC) associated with this device. The associated equipment shall be set to operate within the following limits for compliance with Telecom's Specifications:
  - a There shall be no more than 10 call attempts to the same number within any 30 minute period for any single manual call initiation, and
  - b The equipment shall go on-hook for a period of not less than 30 seconds between the end of one attempt and the beginning of the next call attempt.
- 4 Some parameters required for compliance with Telecom's Telepermit requirements are dependent on the equipment (PC) associated with this device. In order to operate within the limits for compliance with Telecom's specifications, the associated equipment shall be set to ensure that automatic calls to different numbers are spaced such that there is not less than 5 seconds between the end of one call attempt and the beginning of another.
- 5 This equipment shall not be set up to make automatic calls to Telecom's 111 Emergency Service.



**For Modem with approval number PTC 211/01/030**

- 1 The grant of a Telepermit for any item of terminal equipment indicates only that Telecom has accepted that the item complies with minimum conditions for connection to its network. It indicates no endorsement of the product by Telecom, nor does it provide any sort of warranty. Above all, it provides no assurance that any item will work correctly in all respects with another item of Telepermitted equipment of a different make or model, nor does it imply that any product is compatible with all of Telecom's network services.
- 2 This equipment is not capable, under all operating conditions, of correct operation at the higher speeds for which it is designed. Telecom will accept no responsibility should difficulties arise in such circumstances.
- 3 This device is equipped with pulse dialing while the Telecom standard is DTMF tone dialing. There is no guarantee that Telecom lines will always continue to support pulse dialing.
- 4 Use of pulse dialing, when this equipment is connected to the same line as other equipment, may give rise to bell tinkle or noise and may also cause a false answer condition. Should such problems occur, the user should NOT contact the telecom Fault Service.
- 5 This equipment may not provide for the effective hand-over of a call to another device connected to the same line.
- 6 Under power failure conditions this appliance may not operate. Please ensure that a separate telephone, not dependent on local power, is available for emergency use.
- 7 Some parameters required for compliance with Telecom's Telepermit requirements are dependent on the equipment (PC) associated with this device. The associated equipment shall be set to operate within the following limits for compliance with Telecom's specifications, the associated equipment shall be set to ensure that calls are answered between 3 and 30 seconds of receipt of ringing.
- 8 This equipment shall not be set up to make automatic calls to Telecom's 111 Emergency Service.

## Important safety instructions

Read these instructions carefully. Save them for future reference.

- 1 Follow all warnings and instructions marked on the product.
- 2 Unplug this product from the wall outlet before cleaning. Do not use liquid cleaners or aerosol cleaners. Use a damp cloth for cleaning.
- 3 Do not use this product near water.
- 4 Do not place this product on an unstable cart, stand, or table. The product may fall, causing serious damage to the product.
- 5 Slots and openings are provided for ventilation; to ensure reliable operation of the product and to protect it from overheating. These openings must not be blocked or covered. The openings should never be blocked by placing the product on a bed, sofa, rug, or other similar surface. This product should never be placed near or over a radiator or heat register, or in a built-in installation unless proper ventilation is provided.
- 6 This product should be operated from the type of power indicated on the marking label. If you are not sure of the type of power available, consult your dealer or local power company.
- 7 Do not allow anything to rest on the power cord. Do not locate this product where persons will walk on the cord.
- 8 If an extension cord is used with this product, make sure that the total ampere rating of the equipment plugged into the extension cord does not exceed the extension cord ampere rating. Also, make sure that the total rating of all products plugged into the wall outlet does not exceed the fuse rating.
- 9 Never push objects of any kind into this product through cabinet slots as they may touch dangerous voltage points or short out parts that could result in a fire or electric shock. Never spill liquid of any kind on the product.
- 10 Do not attempt to service this product yourself, as opening or removing covers may expose you to dangerous voltage points or other risks. Refer all servicing to qualified service personnel.
- 11 Unplug this product from the wall outlet and refer servicing to qualified service personnel under the following conditions:
  - a When the power cord or plug is damaged or frayed.
  - b If liquid has been spilled into the product.
  - c If the product has been exposed to rain or water.

- d If the product does not operate normally when the operating instructions are followed. Adjust only those controls that are covered by the operating instructions since improper adjustment of other controls may result in damage and will often require extensive work by a qualified technician to restore the product to normal condition.
  - e If the product has been dropped or the case has been damaged.
  - f If the product exhibits a distinct change in performance, indicating a need for service.
- 12 The Aspire series uses the lithium battery.  
Replace the battery with the same type as the product's battery we recommend in the product specification list. Use of another battery may present a risk of fire or explosion.
  - 13 **Warning!** Batteries may explode if not handled properly. Do not disassemble or dispose of them in fire. Keep them away from children and dispose of used batteries promptly.
  - 14 Use only the proper type of power supply cord set (provided in your accessories box) for this unit. It should be a detachable type: UL listed/CSA certified, type SPT-2, rated 7A 125V minimum, VDE approved or its equivalent. Maximum length is 15 feet (4.6 meters).
  - 15 Always disconnect all telephone lines from the wall outlet before serving or disassembling this equipment.
  - 16 Avoid using a telephone (other than a cordless type) during an electrical storm. There may be a remote risk of electric shock from lightning.

## Laser compliance statement

The CD or DVD drive used with this computer is a laser product. The CD or DVD drive's classification label (shown below) is located on the drive.

**CLASS 1 LASER PRODUCT**

**CAUTION: INVISIBLE LASER RADIATION WHEN OPEN. AVOID EXPOSURE TO BEAM.**

**APPAREIL A LASER DE CLASSE 1 PRODUIT**

**LASERATTENTION: RADIATION DU FAISCEAU LASER INVISIBLE EN CAS D'OUVERTURE. EVITER TOUTE EXPOSITION AUX RAYONS.**

**LUOKAN 1 LASERLAITE LASER KLASSE 1**

**VORSICHT: UNSICHTBARE LASERSTRAHLUNG, WENN ABDECKUNG GEÖFFNET NICHT DEM STRAHL AUSSETZEN**

**PRODUCTO LÁSER DE LA CLASE I**

**ADVERTENCIA: RADIACIÓN LÁSER INVISIBLE AL SER ABIERTO. EVITE EXPONERSE A LOS RAYOS.**

**ADVARSEL: LASERSTRÅLING VEDÅBNING SE IKKE IND I STRÅLEN.**

**VARO! LAVATTAESSA OLET ALTTINA LASERSÄTEILYLLE.**

**VARNING: LASERSTRÅLNING NÅR DENNA DEL ÅR ÖPPNAD ÅLÅ TUIJOTA SÄTEESEENSTIRRA EJ IN I STRÅLEN**

**VARNING: LASERSTRÅLNING NAR DENNA DEL ÅR ÖPPNADSTIRRA EJ IN I STRÅLEN**

**ADVARSEL: LASERSTRÅLING NAR DEKSEL ÅPNESSTIRR IKKE INN I STRÅLEN**

## LCD pixel statement

The LCD unit is produced with high-precision manufacturing techniques. Nevertheless, some pixels may occasionally misfire or appear as black or red dots. This has no effect on the recorded image and does not constitute a malfunction.

## Macrovision® copyright protection notice

This product incorporates copyright protection technology that is protected by method claims of certain U.S. patents and other intellectual property rights owned by Macrovision Corporation and other rights owners. Use of this copyright protection technology must be authorized by Macrovision Corporation, and is intended for home and other limited viewing uses only unless otherwise authorized by Macrovision Corporation. Reverse engineering or disassembly is prohibited.

Apparatus Claims of U.S. Patent Nos. 4,631,603, 4,577,216, 4,819,098, 4,907,093, and 6,516,132 licensed for limited viewing uses only.

## Radio Device Regulatory Notice



**Note:** Below regulatory information is for models with wireless LAN and/or Bluetooth® only.

## General

This product complies with the radio frequency and safety standards of any country or region in which it has been approved for wireless use. Depending on configurations, this product may or may not contain wireless radio devices (such as wireless LAN and/or Bluetooth® modules). Below information is for products with such devices.

## European Union (EU)

This device complies with the essential requirements of the European Council Directives listed below:

### 73/23/EEC Low Voltage Directive

- EN 60950

### 89/336/EEC Electromagnetic Compatibility (EMC) Directive

- EN 55022
- EN 55024
- EN 61000-3-2/-3

### 99/5/EC Radio & Telecommunications Terminal Equipment (R&TTE) Directive

- Art.3.1a) EN 60950
- Art.3.1b) EN 301 489 -1/-17
- Art.3.2) EN 300 328-2
- Art.3.2) EN 301 893 \*applied to 5 GHz only

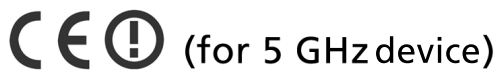

## List of Applicable Countries

EU member states as of May 2004 are: Belgium, Denmark, Germany, Greece, Spain, France, Ireland, Italy, Luxembourg, the Netherlands, Austria, Portugal, Finland, Sweden, United Kingdom, Estonia, Latvia, Lithuania, Poland, Hungary, Czech Republic, Slovak Republic, Slovenia, Cyprus and Malta. Usage allowed in the countries of European Union, as well as Norway, Switzerland, Iceland and Liechtenstein. This device must be used in strict accordance with the regulations and constraints in the country of use. For further information, please contact local office in the country of use.

## The FCC RF safety requirement

The radiated output power of Wireless LAN Mini-PCI Card and Blue-tooth card is far below the FCC radio frequency exposure limits. Nevertheless, the Aspire series shall be used in such a manner that the potential for human contact during normal operation is minimized as follows:

- 1 Users are requested to follow the RF safety instructions on wireless option devices that are included in the user's manual of each RF option device.



**Caution:** To comply with FCC RF exposure compliance requirements, a separation distance of at least 20 cm (8 inches) must be maintained between the antenna for the integrated Wireless LAN Mini-PCI Card built in to the screen section and all persons.

### Diversity antenna positions

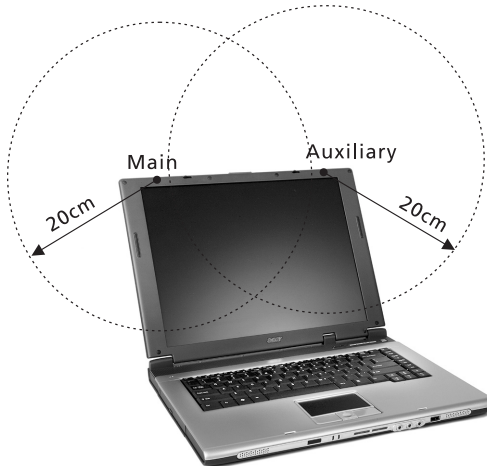

**Note:** Acer Dual-Band 11a/g Wireless Mini PCI Adapter implements transmission diversity function. The function does not emit radio frequencies simultaneously from both antennas. One of the antennas is selected automatically or manually (by users) to have good quality of radiocommunication.

- 2 This device is restricted to indoor use due to its operation in the 5.15 to 5.25 GHz frequency range. FCC requires this product to be used indoors for the frequency range 5.15 to 5.25 GHz to reduce the potential for harmful interference to co-channel Mobile Satellite systems.
- 3 High power radar are allocated as primary users of the 5.25 to 5.35 GHz and 5.65 to 5.85 GHz bands. These radar stations can cause interference with and/or damage this device.
- 4 An improper installation or unauthorized use may cause harmful interference to radio communications. Also any tampering of the internal antenna will void the FCC certification and your warranty.

### Canada - Low power license-exempt radiocommunication devices (RSS-210)

- a Common information  
Operation is subject to the following two conditions:
  1. This device may not cause interference, and
  2. this device must accept any interference, including interference that may cause undesired operation of the device.
- b Operation in 2.4 GHz band  
To prevent radio interference to the licensed service, this device is intended to be operated indoors and installed outdoors is subject to licensing.
- c Operation in 5 GHz band
  - The device for the band 5150-5250 MHz is only for indoor usage to reduce potential for harmful interference to co-channel Mobile Satellite systems.
  - High power radars are allocated as primary users (meaning they have priority) of 5250-5350 MHz and 5650-5850 MHz and these radars could cause interference and/or damage to LELAN (Licence-Exempt Local Area Network) devices.

### Exposure of humans to RF fields (RSS-102)

The Acer Aspire series employs low gain integral antennas that do not emit RF field in excess of Health Canada limits for the general population; consult Safety Code 6, obtainable from Health Canada's Web site at [www.hc-sc.gc.ca/rpb](http://www.hc-sc.gc.ca/rpb).



**Acer Incorporated**  
8F, 88, Sec. 1, Hsin Tai Wu Rd., Hsichih  
Taipei Hsien 221, Taiwan

Tel : 886-2-2696-1234  
Fax : 886-2-2696-3535  
www.acer.com



**Declaration of Conformity for CE marking**

We,

Acer Inc.  
8F, 88, Sec. 1, Hsin Tai Wu Rd., Hsichih,  
Taipei Hsien 221, Taiwan

Contact Person: Mr. Easy Lai  
Tel: 886-2-8691-3089 Fax: 886-2-8691-3000  
E-mail: [easy\\_lai@acer.com.tw](mailto:easy_lai@acer.com.tw)

Hereby declare that:

Product: Notebook PC  
Trade Name: Acer  
Model Number: ZL1  
Machine Type: Aspire 1680; Aspire 1410  
SKU Number: Aspire 168xxx; Aspire 141xxx  
("x" = 0~9, a~z, or A~Z)

Is in compliance with the essential requirements and other relevant provisions of the following EC directives.

Reference No.	Title
89/336/EEC	Electromagnetic Compatibility (EMC directive)
73/23/EEC	Low Voltage Directive (LVD)
1999/5/EC	Radio & Telecommunications Terminal Equipment Directive (R&TTE)

The product specified above was tested conforming to the applicable Rules under the most accurate measurement standards possible, and that all the necessary steps have been taken and are in force to assure that production units of the same product will continue to comply with the requirements.

*Easy Lai*  
-----  
Easy Lai/ Director  
Qualification Center  
Product Assurance, Acer Inc.

**2004/6/1**  
-----  
Date



### Federal Communications Commission Declaration of Conformity

This device complies with Part 15 of the FCC Rules. Operation is subject to the following two conditions: (1) this device may not cause harmful interference, and (2) this device must accept any interference received, including interference that may cause undesired operation.

The following local Manufacturer/Importer is responsible for this declaration:

Product:	Notebook Personal Computer
Model Number:	ZL1
Machine Type:	Aspire 1680; Aspire 1410
SKU Number:	Aspire 168xxx; Aspire 141xxx ('x' = 0~9, a~z, or A~Z)
Name of Responsible Party:	Acer America Corporation
Address of Responsible Party:	2641 Orchard Parkway, San Jose CA 95134, U. S. A.
Contact Person:	Mr. Young Kim
Phone No.:	408-922-2909
Fax No.:	408-922-2606



# Index

## A

- AC adapter
  - caring for v
- audio 27
  - adjusting the volume 27
  - troubleshooting 62

## B

- battery pack
  - caring for v
- BIOS Utility 45
- BIOS utility 45
- brightness
  - hotkeys 19

## C

- caps lock 15
  - on indicator 13
- care
  - AC adapter v
  - battery pack v
  - computer iv
- CD
  - troubleshooting 63
- CD-ROM
  - ejecting 25
  - ejecting manually 62
  - troubleshooting 62
- cleaning
  - computer v
- computer
  - bringing to meetings 29
  - caring for iv
  - cleaning v
  - disconnecting 28
  - features 3, 11
  - indicators 13
  - keyboards 15
  - moving around 28
  - on indicator 5, 14, 22
  - performance 11
  - security 33
  - setting up a home office 30
  - taking home 29

- traveling internationally 32
- traveling on local trips 31
- troubleshooting 60
- turning off iv

## D

- display
  - hotkeys 19
  - troubleshooting 61
- DVD 26
  - troubleshooting 63
- DVD movies
  - playing 26

## E

- error messages 65
- Ethernet 38
- Euro 20

## F

- FAQ. See frequently-asked questions
- frequently-asked questions 61
- front view 3, 5

## H

- hard disk 25
- help
  - online services 66
- Hibernation mode
  - hotkey 18
- hotkeys 18

## I

- IEEE 1394 port 39
- indicator lights 13
- infrared 38
- ITW. See warranty

## K

- keyboard 15
  - embedded numeric keypad 16
  - hotkeys 18
  - lock keys 15
  - troubleshooting 63
  - Windows keys 17

## L

- LEDs 13
- left view 5

**M**

- media access
  - on indicator 13
- memory
  - installing 42
  - upgrading 42
- messages
  - error 65
- modem 37

**N**

- network 38
- Notebook Manager
  - hotkey 18
- notice
  - DVD copyright protection 84
- num lock 15
  - on indicator 13
- numeric keypad
  - embedded 16
  - num lock 16

**O**

- online services 66
- optical drive 25
- options
  - memory upgrade 42

**P**

- PC Card 40, 41
  - ejecting 41
  - inserting 40
- ports 37
- Power-On Self-Test (POST) 45
- printer
  - troubleshooting 64
- problems 61
  - CD 63
  - CD-ROM 62
  - display 61
  - DVD 63
  - keyboard 63
  - printer 64
  - startup 61
  - troubleshooting 60

**Q**

- questions
  - setting location for modem use

64

**S**

- safety
  - CD or DVD 83
  - FCC notice 77
  - general instructions 80
  - modem notices 78
- scroll lock 15
- security
  - keylock 33
- service
  - when to call vi
- speakers
  - hotkey 19
  - troubleshooting 62
- specifications 70
- status indicators 13
- storage 25
  - CD, DVD, or DVD/CD-RW Combo drive 25
  - hard disk 25
- support
  - information 66

**T**

- touchpad 23
  - hotkey 19
  - using 23
- travel
  - international flights 32
  - local trips 31
- troubleshooting 60
  - tips 64

**U**

- universal serial bus 39
- utility
  - BIOS Setup 45

**V**

- view
  - front 7
  - left 7
  - rear 9
  - right 8
- volume
  - adjusting 27

**W**

warranty

International Traveler's

Warranty 66

Windows 46

Windows keys 17

## Free Manuals Download Website

<http://myh66.com>

<http://usermanuals.us>

<http://www.somanuals.com>

<http://www.4manuals.cc>

<http://www.manual-lib.com>

<http://www.404manual.com>

<http://www.luxmanual.com>

<http://aubethermostatmanual.com>

Golf course search by state

<http://golfingnear.com>

Email search by domain

<http://emailbydomain.com>

Auto manuals search

<http://auto.somanuals.com>

TV manuals search

<http://tv.somanuals.com>