

Aspire E1-771G / E1-771 / E1-731G / E1-731

Quick Guide

Product registration

When using your product for the first time, it is recommended that you immediately register it. This will give you access to some useful benefits, such as:

- Faster service from our trained representatives.
- Membership in the Acer community: receive promotions and participate in customer surveys.
- The latest news from Acer.

Hurry and register, as other advantages await you!

How to register

To register your Acer product, please visit **www.acer.com**. Select your country, click **PRODUCT REGISTRATION** and follow the simple instructions.

You will also be asked to register your product during the setup process, or you can double-click the Registration icon on the desktop.

After we receive your product registration, you will be sent a confirmation email with important data that you should keep in a safe place.

Obtaining Acer accessories

We are happy to inform you that Acer's warranty extension program and Notebook accessories are available online. Come and visit our online shop and find what you need at **store.acer.com**.

The Acer store is being progressively rolled out, and, unfortunately may not be available in some regions. Please check back regularly to see when it will be available in your country.

© 07/2013. All Rights Reserved.

Aspire E1-771G / E1-771 / E1-731G / E1-731

Quick Guide

This revision: July 2013

Model number:

Serial number:

Date of purchase:

Place of purchase:

ENVIRONMENT

Temperature:

- Operating: 5 °C to 35 °C
- Non-operating: -20 °C to 65 °C

Humidity (non-condensing):

- Operating: 20% to 80%
- Non-operating: 20% to 80%

First things first

We would like to thank you for making an Acer notebook your choice for meeting your mobile computing needs.

Your guides

To help you use your Acer notebook, we have designed a set of guides:

First off, the **Setup Poster** helps you get started with setting up your computer.

The **Quick Guide** introduces you to the basic features and functions of your new computer.

For more on how your computer can help you to be more productive, please refer to the **User's Manual**. The **User's Manual** contains useful information applying to your new computer. It covers basic topics such as using the keyboard and audio, etc.

This guide contains detailed information on such subjects as system utilities, data recovery, expansion options and troubleshooting. In addition it contains warranty information and the general regulations and safety notices for your notebook.

Follow these steps to access it:

- 1 Type 'User' from *Start*.
- 2 Click on **Acer User's Manual**.





Your Acer notebook tour

After setting up your computer as illustrated in the setup poster, let us show you around your new Acer computer.

Screen view



#	Icon	Item	Description
1		Microphone	Internal microphone for sound recording.
2		Screen	Displays computer output.
3		Webcam	Web camera for video communication. <i>A light next to the webcam indicates that the webcam is active.</i>

#	Icon	Item	Description
		Power indicator	Indicates the computer's power status.
4		Battery indicator	Indicates the computer's battery status. Charging: <i>The light is amber when the battery is charging.</i> Fully charged: <i>The light is blue when plugged in.</i>
		HDD indicator	Indicates when the hard disk drive is active.
		Communication indicator	Indicates the computer's wireless connectivity device status.
5		SD card reader	Accepts one Secure Digital (SD or SDHC) card. Note: <i>Push to remove/install the card.</i>

Keyboard view





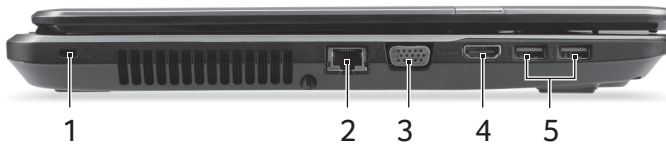

#	Icon	Item	Description
1		Power button	Turns the computer on and off.
2		Keyboard	For entering data into your computer. <i>See "Using the keyboard" on page 8.</i>

#	Icon	Item	Description
3		Touchpad	Touch-sensitive pointing device which functions like a computer mouse.
4		Click buttons (left and right)	The left and right side of the button function as left and right selection buttons.
5		Speakers	Deliver stereo audio output.

Left view







#	Icon	Item	Description
1		Kensington lock slot	Connects to a Kensington-compatible computer security lock. <i>Wrap the computer security lock cable around an immovable object such as a table or handle of a locked drawer.</i> <i>Insert the lock into the notch and turn the key to secure the lock.</i> <i>Keyless models are also available.</i>
2		Ethernet (RJ-45) port	Connects to an Ethernet 10/100/1000-based network.
3		External display (VGA) port	Connects to a display device (e.g., external monitor, LCD projector).
4		HDMI port	Supports high-definition digital video connections.
5		USB port	Connects to USB devices.

Information on USB 3.0

- USB 3.0 compatible ports are blue.
- Compatible with USB 3.0 and earlier devices.
- For optimal performance, use USB 3.0-certified devices.
- Defined by the USB 3.0 specification (SuperSpeed USB).



Right view

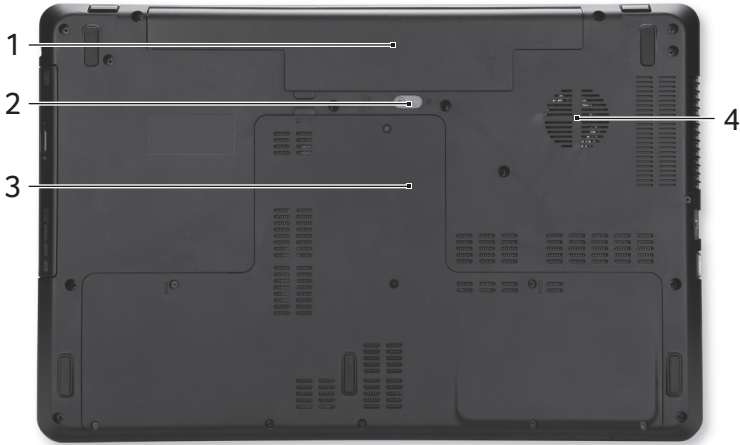

#	Icon	Item	Description
1		Headphones/speaker/ line-out jack	Connects to audio line-out devices (e.g., speakers, headphones).
		Microphone jack	Accepts inputs from external microphones.
2		USB port	Connects to USB devices.
3		Optical drive	Internal optical drive; accepts CDs or DVDs.
4		Optical disk access indicator	Lights up when the optical drive is active.
5		Optical drive eject button	Ejects the optical disk from the drive.
6		Emergency eject hole	Ejects the optical drive tray when the computer is turned off. <i>Carefully insert a straightened paper clip to eject the optical drive tray.</i>
7		DC-in jack	Connects to an AC adapter.

Base view



#	Icon	Item	Description
1		Battery bay	Houses the computer's battery pack.
2		Battery release latch	Releases the battery for removal. Insert a suitable tool and slide to release.
3		Memory compartment	Houses the computer's main memory.
		HDD compartment	Houses the computer's hard disk drive memory.
4		Ventilation and cooling fan	Allows the computer to stay cool. <i>Do not cover or obstruct the openings.</i>















Using the keyboard

The keyboard has full-sized keys and a numeric keypad, separate cursor, lock, Windows, function and special keys.

Hotkeys

The computer employs hotkeys or key combinations to access most of the computer's controls like screen brightness and volume output.

To activate hotkeys, press and hold the **<Fn>** key before pressing the other key in the hotkey combination.

Hotkey	Icon	Function	Description
<Fn> + <F3>		Airplane mode	Turns on / off the computer's network devices. <i>(Network devices vary by configuration.)</i>
<Fn> + <F4>		Sleep	Puts the computer in Sleep mode.
<Fn> + <F5>		Display toggle	Switches display output between the display screen, external monitor (if connected) and both.
<Fn> + <F6>		Display off	Turns the display screen backlight off to save power. Press any key to return.
<Fn> + <F7>		Touchpad toggle	Turns the built-in touchpad on and off.
<Fn> + <F8>		Speaker toggle	Turns the speakers on and off.
<Fn> + <F12>	Scr Lk	Scroll Lock	Turns Scroll Lock on or off.
<Fn> + <▷>		Brightness up	Increases the screen brightness.
<Fn> + <◁>		Brightness down	Decreases the screen brightness.
<Fn> + <△>		Volume up	Increases the sound volume.
<Fn> + <▽>		Volume down	Decreases the sound volume.
<Fn> + <Home>		Play/Pause	Play or pause a selected media file.
<Fn> + <Pg Up>		Stop	Stop playing the selected media file.
<Fn> + <Pg Dn>		Previous	Return to the previous media file.
<Fn> + <End>		Next	Jump to the next media file.

Free Manuals Download Website

<http://myh66.com>

<http://usermanuals.us>

<http://www.somanuals.com>

<http://www.4manuals.cc>

<http://www.manual-lib.com>

<http://www.404manual.com>

<http://www.luxmanual.com>

<http://aubethermostatmanual.com>

Golf course search by state

<http://golfingnear.com>

Email search by domain

<http://emailbydomain.com>

Auto manuals search

<http://auto.somanuals.com>

TV manuals search

<http://tv.somanuals.com>