

**Aspire V7-481P / V7-482P / V5-
472P / V5-473P / V5-452P**
User's Manual



© 2013 All Rights Reserved.

Aspire V7-481P / V7-482P / V5-472P / V5-473P / V5-452P User's Manual

This revision: 04/2013

AcerCloud frees you to enjoy your digital life anytime, anywhere!

This computer comes with AcerCloud pre-installed. AcerCloud is a personal cloud service that allows you to access your files over the Internet and make sure your most important files are always up to date. With your personal cloud, all your connected devices (PC, tablet, phone) can access files on your main Cloud PC. For more information please visit the AcerCloud website:

www.acer.com/acercloud



Model number:

Serial number:

Date of purchase:

Place of purchase:

TABLE OF CONTENTS

| | | | |
|---|-----------|---|-----------|
| Safety and comfort | 5 | snapshot..... | 45 |
| First things first | 16 | Returning your system to its factory condition..... | 46 |
| Your guides | 16 | Recovering from Windows | 47 |
| Basic care and tips for using your computer | 16 | Recovering from a recovery backup | 51 |
| Turning your computer on and off..... | 16 | Power management | 55 |
| Taking care of your computer | 17 | Disable Fast startup..... | 55 |
| Taking care of your AC adapter..... | 18 | Battery pack | 58 |
| Cleaning and servicing..... | 18 | Battery pack characteristics..... | 58 |
| Your Acer notebook tour | 19 | Charging the battery | 58 |
| Screen view..... | 20 | Optimizing battery life..... | 60 |
| Keyboard view..... | 22 | Checking the battery level..... | 60 |
| Left view | 23 | Battery-low warning..... | 60 |
| Right view..... | 24 | Traveling with your computer | 62 |
| Rear view | 25 | Disconnecting from the desktop | 62 |
| Information on USB 3.0..... | 26 | Moving around..... | 62 |
| Base view..... | 27 | Preparing the computer..... | 63 |
| Using the keyboard | 28 | What to bring to meetings | 63 |
| Lock keys and embedded numeric keypad | 28 | Taking the computer home..... | 64 |
| Hotkeys | 29 | Preparing the computer..... | 64 |
| Windows keys | 31 | What to take with you..... | 64 |
| Touchpad | 32 | Special considerations | 64 |
| Touchpad basics | 32 | Setting up a home office | 65 |
| Touchpad gestures | 33 | Traveling with the computer | 65 |
| Recovery | 34 | Preparing the computer..... | 65 |
| Creating a recovery backup | 34 | What to take with you..... | 66 |
| Creating a drivers and applications backup | 38 | Special considerations | 66 |
| Recovering your system..... | 41 | Traveling internationally with the computer | 66 |
| Reinstalling drivers and applications..... | 42 | Preparing the computer..... | 66 |
| Returning to an earlier system | | What to bring with you..... | 66 |
| | | Special considerations | 67 |

| | | | |
|---|-----------|--|------------|
| Securing your computer | 68 | Frequently asked questions | 87 |
| Using a computer security lock | 68 | Requesting service | 89 |
| Using passwords | 68 | Tips and hints for using Windows 8 | 91 |
| Entering passwords | 69 | Three concepts you might want to keep in mind | 91 |
| Acer Theft Shield | 70 | How do I access the charms? | 91 |
| Using Acer Theft Shield | 72 | How do I get to Start? | 91 |
| General | 72 | How do I jump between apps? | 92 |
| Settings | 73 | How do I turn off my computer? | 92 |
| Wireless networks | 74 | Why is there a new interface? | 92 |
| Connecting to the Internet | 74 | How do I unlock my computer? | 92 |
| Acer Instant Connect | 74 | How do I personalize my computer? | 93 |
| Wireless networks | 74 | I want to use Windows in the way that I'm used to - give me my desktop back! | 94 |
| Using a Bluetooth connection | 76 | Where are my apps? | 94 |
| Enabling and disabling Bluetooth | 76 | What is a Microsoft ID (account)? | 96 |
| Enabling Bluetooth from Windows 8 | 77 | How do I add a favorite to Internet Explorer? | 96 |
| Adding a Bluetooth device | 78 | How do I check for Windows updates? | 97 |
| Acer Converter Port | 83 | Where can I get more information? | 97 |
| HDMI | 84 | Troubleshooting | 98 |
| Universal Serial Bus (USB) | 85 | Troubleshooting tips | 98 |
| BIOS utility | 86 | Error messages | 98 |
| Boot sequence | 86 | Regulations and safety notices | 100 |
| Setting passwords | 86 | | |

SAFETY AND COMFORT

SAFETY INSTRUCTIONS

Read these instructions carefully. Keep this document for future reference. Follow all warnings and instructions marked on the product.

Turning the product off before cleaning

Unplug this product from the wall outlet before cleaning. Do not use liquid cleaners or aerosol cleaners. Use a damp cloth for cleaning.

WARNINGS

Accessing the power cord

Be sure that the power outlet you plug the power cord into is easily accessible and located as close to the equipment operator as possible. When you need to disconnect power to the equipment, be sure to unplug the power cord from the electrical outlet.

Disconnecting the power source

Observe the following guidelines when connecting and disconnecting power to the power supply unit:

Install the power supply unit before connecting the power cord to the AC power outlet.

Unplug the power cord before removing the power supply unit from the computer.

If the system has multiple sources of power, disconnect power from the system by unplugging all power cords from the power supplies.

Using electrical power

- This product should be operated from the type of power indicated on the marking label. If you are not sure of the type of power available, consult your dealer or local power company.
- Do not allow anything to rest on the power cord. Do not locate this product where people will walk on the cord.

- If an extension cord is used with this product, make sure that the total ampere rating of the equipment plugged into the extension cord does not exceed the extension cord ampere rating. Also, make sure that the total rating of all products plugged into the wall outlet does not exceed the fuse rating.
- Do not overload a power outlet, strip or receptacle by plugging in too many devices. The overall system load must not exceed 80% of the branch circuit rating. If power strips are used, the load should not exceed 80% of the power strip's input rating.
- This product's AC adapter is equipped with a three-wire grounded plug. The plug only fits in a grounded power outlet. Make sure the power outlet is properly grounded before inserting the AC adapter plug. Do not insert the plug into a non-grounded power outlet. Contact your electrician for details.
- **Warning! The grounding pin is a safety feature. Using a power outlet that is not properly grounded may result in electric shock and/or injury.**
- **Note:** *The grounding pin also provides good protection from unexpected noise produced by other nearby electrical devices that may interfere with the performance of this product.*
- The system can be powered using a wide range of voltages; 100 to 120 or 220 to 240 V AC. The power cord included with the system meets the requirements for use in the country/region where the system was purchased. Power cords for use in other countries/regions must meet the requirements for that country/region. For more information on power cord requirements, contact an authorized reseller or service provider.

Protecting your hearing

- **Warning! Permanent hearing loss may occur if earphones or headphones are used at high volume for prolonged periods of time.**



To protect your hearing, follow these instructions.

- Increase the volume gradually until you can hear clearly and comfortably.
- Do not increase the volume level after your ears have adjusted.
- Do not listen to music at high volumes for extended periods.

- Do not increase the volume to block out noisy surroundings.
- Decrease the volume if you can't hear people speaking near you.

Bundled dummy cards

- **Note:** *Information in this section may not apply to your computer.*

Your computer shipped with plastic dummies installed in the card slots. Dummies protect unused slots from dust, metal objects or other particles. Save the dummies for use when no cards are in the slots.

General

- Do not use this product near water.
- Do not place this product on an unstable cart, stand or table. If the product falls, it could be seriously damaged.
- Slots and openings are provided for ventilation to ensure reliable operation of the product and to protect it from overheating. These openings must not be blocked or covered. The openings should never be blocked by placing the product on a bed, sofa, rug or other similar surface. This product should never be placed near or over a radiator or heat register, or in a built-in installation unless proper ventilation is provided.
- Never push objects of any kind into this product through cabinet slots as they may touch dangerous voltage points or short-out parts that could result in a fire or electric shock. Never spill liquid of any kind onto or into the product.
- To avoid damage of internal components and to prevent battery leakage, do not place the product on a vibrating surface.
- Never use it under sporting, exercising, or any vibrating environment which will probably cause unexpected short current or damage rotor devices, HDD, Optical drive, and even exposure risk from lithium battery pack.
- The bottom surface, areas around ventilation openings and AC adapter may get hot. To avoid injury, ensure they do not come in contact with your skin or body.
- Your device and its enhancements may contain small parts. Keep them out of the reach of small children.

Product servicing

Do not attempt to service this product yourself, as opening or removing covers may expose you to dangerous voltage points or other risks. Refer all servicing to qualified service personnel.

Unplug this product from the wall outlet and refer servicing to qualified service personnel when:

- The power cord or plug is damaged, cut or frayed.
- Liquid was spilled into the product.
- The product was exposed to rain or water.
- The product has been dropped or the case has been damaged.
- The product exhibits a distinct change in performance, indicating a need for service.
- The product does not operate normally after following the operating instructions.
- **Note:** *Adjust only those controls that are covered by the operating instructions, since improper adjustment of other controls may result in damage and will often require extensive work by a qualified technician to restore the product to normal condition.*

Guidelines for safe battery usage

This computer uses a Lithium-ion or Lithium-polymer battery. Do not use it in a humid, wet or corrosive environment. Do not put, store or leave your product in or near a heat source, in a high temperature location, in strong direct sunlight, in a microwave oven or in a pressurized container, and do not expose it to temperatures over 60° C (140° F). Failure to follow these guidelines may cause the battery to leak acid, become hot, explode or ignite and cause injury and/or damage.

Do not pierce, open or disassemble the battery. If the battery leaks and you come into contact with the leaked fluids, rinse thoroughly with water and seek medical attention immediately.

For safety reasons, and to prolong the lifetime of the battery, charging will not occur at temperatures below 0° C (32° F) or above 40° C (104° F).

The full performance of a new battery is achieved only after two or three complete charge and discharge cycles. The battery can be charged and discharged hundreds of times, but it will eventually wear out. When the operation time becomes noticeably shorter than normal, refer to qualified service personnel. Use only the approved batteries, and recharge your battery only with the approved chargers designated for this device.

Never use any charger or battery that is damaged.

The capacity and lifetime of the battery will be reduced if the battery is left in hot or cold places, such as in a closed car in summer or winter. Always try to keep the battery between 15°C and 25°C (59°F and 77°F). A device with a hot or cold battery may not work temporarily, even when the battery is fully charged. Battery performance is especially limited in temperatures well below freezing.

Do not dispose of batteries in a fire as they may explode. Batteries may also explode if damaged. Dispose of batteries according to local regulations. Please recycle when possible. Do not dispose as household waste.

- **Note:** Please refer to www.acer.com for battery shipping documents.
- **Warning! Batteries may explode if not handled properly. Do not disassemble or dispose of them in fire. Keep them away from children. Follow local regulations when disposing of used batteries.**

RADIO FREQUENCY INTERFERENCE

- **Warning! For safety reasons, turn off all wireless or radio transmitting devices when using your laptop under the following conditions. These devices may include, but are not limited to: wireless LAN (WLAN), Bluetooth and/or 3G.**

Remember to follow any special regulations in force in any area, and always switch off your device when its use is prohibited or when it may cause interference or danger. Use the device only in its normal operating positions. This device meets RF exposure guidelines when used normally, and it and its antenna are positioned at least 1.5 centimeters (5/8 inch) away from your body. It should not contain metal and you should position the device the above-stated distance from your body. To successfully transmit data files or messages, this device requires a good quality connection to the network. In

some cases, transmission of data files or messages may be delayed until such a connection is available. Ensure that the above separation distance instructions are followed until the transmission is completed. Parts of the device are magnetic. Metallic materials may be attracted to the device, and persons with hearing aids should not hold the device to the ear with the hearing aid. Do not place credit cards or other magnetic storage media near the device, because information stored on them may be erased.

MEDICAL DEVICES

Operation of any radio transmitting equipment, including wireless phones, may interfere with the functionality of inadequately protected medical devices. Consult a physician or the manufacturer of the medical device to determine if they are adequately shielded from external RF energy or if you have any questions. Switch off your device in health care facilities when any regulations posted in these areas instruct you to do so. Hospitals or health care facilities may be using equipment that could be sensitive to external RF transmissions.

Pacemakers. Pacemaker manufacturers recommend that a minimum separation of 15.3 centimeters (6 inches) be maintained between wireless devices and a pacemaker to avoid potential interference with the pacemaker. These recommendations are consistent with the independent research by and recommendations of Wireless Technology Research. Persons with pacemakers should do the following:

- Always keep the device more than 15.3 centimeters (6 inches) from the pacemaker
- Not carry the device near your pacemaker when the device is switched on.

If you suspect interference, switch off your device, and move it.

Hearing aids. Some digital wireless devices may interfere with some hearing aids. If interference occurs, consult your service provider.

VEHICLES

RF signals may affect improperly installed or inadequately shielded electronic systems in motor vehicles such as electronic fuel injection systems, electronic anti-skid (anti-lock) braking systems, electronic speed control systems, and air bag systems. For more information, check with the manufacturer, or its representative, of your vehicle or any

equipment that has been added. Only qualified personnel should service the device, or install the device in a vehicle. Faulty installation or service may be dangerous and may invalidate any warranty that may apply to the device. Check regularly that all wireless equipment in your vehicle is mounted and operating properly. Do not store or carry flammable liquids, gases, or explosive materials in the same compartment as the device, its parts, or enhancements. For vehicles equipped with an air bag, remember that air bags inflate with great force. Do not place objects, including installed or portable wireless equipment in the area over the air bag or in the air bag deployment area. If in-vehicle wireless equipment is improperly installed, and the air bag inflates, serious injury could result. Using your device while flying in aircraft is prohibited. Switch off your device before boarding an aircraft. The use of wireless teledevices in an aircraft may be dangerous to the operation of the aircraft, disrupt the wireless telephone network, and may be illegal.

POTENTIALLY EXPLOSIVE ENVIRONMENTS

Switch off your device when in any area with a potentially explosive atmosphere and obey all signs and instructions. Potentially explosive atmospheres include areas where you would normally be advised to turn off your vehicle engine. Sparks in such areas could cause an explosion or fire resulting in bodily injury or even death. Switch off the device at refueling points such as near gas pumps at service stations. Observe restrictions on the use of radio equipment in fuel depots, storage, and distribution areas; chemical plants; or where blasting operations are in progress. Areas with a potentially explosive atmosphere are often, but not always, clearly marked. They include below deck on boats, chemical transfer or storage facilities, vehicles using liquefied petroleum gas (such as propane or butane), and areas where the air contains chemicals or particles such as grain, dust or metal powders. Do not switch the computer on when wireless phone use is prohibited or when it may cause interference or danger.

EMERGENCY CALLS

- **Warning! You cannot make emergency calls through this device. To make an emergency call you shall dial out through your mobile phone or other telephone call system.**

DISPOSAL INSTRUCTIONS

Do not throw this electronic device into the trash when discarding. To minimize pollution and ensure utmost protection of the global environment, please recycle. For more information on the Waste from Electrical and Electronics Equipment (WEEE) regulations, visit www.acer-group.com/public/Sustainability.



ENERGY STAR



ENERGY STAR

Acer's ENERGY STAR qualified products save your money by reducing energy cost and protecting the environment without sacrificing features or performance. Acer is proud to offer our customers products with the ENERGY STAR mark.

What is ENERGY STAR?

Products that are ENERGY STAR qualified use less energy and prevent greenhouse gas emissions by meeting strict energy efficiency guidelines set by the U.S. Environmental Protection Agency. Acer is committed to offering products and services worldwide that help customers save money, conserve energy and improve the quality of our environment. The more energy we can save through higher energy efficiency, the more we reduce greenhouse gases and the risks of climate change. More information refers to www.energystar.gov or www.energystar.gov/powermanagement.

- **Note:** *Information in this section may not apply to your computer.*

Acer ENERGY STAR qualified products:

- produce less heat and reduce cooling loads in warmer climates.
- automatically go into "display Sleep" and "computer Sleep" mode after 10 and 30 minutes of inactivity, respectively.
- wake from "Sleep" mode if the keyboard is pressed or mouse is moved.
- save more than 80% energy when in "Sleep" mode.

ENERGY STAR and the ENERGY STAR mark are registered U.S. marks.

TIPS AND INFORMATION FOR COMFORTABLE USE

Computer users may complain of eyestrain and headaches after prolonged use. Users are also at risk of physical injury after long hours of working in front of a computer. Long work periods, bad posture, poor work habits, stress, inadequate working conditions, personal health and other factors greatly increase the risk of physical injury.

Incorrect computer usage may lead to carpal tunnel syndrome, tendonitis, tenosynovitis or other musculoskeletal disorders. The following symptoms may appear in the hands, wrists, arms, shoulders, neck or back:

- Numbness, or a burning or tingling sensation.
- Aching, soreness or tenderness.
- Pain, swelling or throbbing.
- Stiffness or tightness.
- Coldness or weakness.

If you have these symptoms, or any other recurring or persistent discomfort and/or pain related to computer use, consult a physician immediately and inform your company's health and safety department.

The following section provides tips for more comfortable computer use.

Finding your comfort zone

Find your comfort zone by adjusting the viewing angle of the monitor, using a footrest, or raising your sitting height to achieve maximum comfort. Observe the following tips:

- Refrain from staying too long in one fixed posture.
- Avoid slouching forward and/or leaning backward.
- Stand up and walk around regularly to remove the strain on your leg muscles.
- Take short rests to relax your neck and shoulders.
- Avoid tensing your muscles or shrugging your shoulders.
- Install the external display, keyboard and mouse properly and within comfortable reach.

- If you view your monitor more than your documents, place the display at the center of your desk to minimize neck strain.

Taking care of your vision

Long viewing hours, wearing incorrect glasses or contact lenses, glare, excessive room lighting, poorly focused screens, very small typefaces and low-contrast displays could stress your eyes. The following sections provide suggestions on how to reduce eyestrain.

Eyes

- Rest your eyes frequently.
- Give your eyes regular breaks by looking away from the monitor and focusing on a distant point.
- Blink frequently to keep your eyes from drying out.

Display

- Keep your display clean.
- Keep your head at a higher level than the top edge of the display so your eyes point downward when looking at the middle of the display.
- Adjust the display brightness and/or contrast to a comfortable level for enhanced text readability and graphics clarity.
- Eliminate glare and reflections by:
 - placing your display in such a way that the side faces the window or any light source,
 - minimizing room light by using drapes, shades or blinds,
 - using a task light,
 - changing the display's viewing angle,
 - using a glare-reduction filter,
 - using a display visor, such as a piece of cardboard extended from the display's top front edge.
- Avoid adjusting your display to an awkward viewing angle.
- Avoid looking at bright light sources for extended periods of time.

Developing good work habits

The following work habits make computer use more relaxing and productive:

- Take short breaks regularly and often.
- Perform some stretching exercises.
- Breathe fresh air as often as possible.
- Exercise regularly and maintain a healthy body.
- **Warning! We do not recommend using the computer on a couch or bed. If this is unavoidable, work for only short periods, take breaks regularly, and do some stretching exercises.**
- **Note:** *For more information, please refer to "Regulations and safety notices" on page 100.*

FIRST THINGS FIRST

We would like to thank you for making an Acer notebook your choice for meeting your mobile computing needs.

Your guides

To help you use your Acer notebook, we have designed a set of guides: First off, the **setup poster** helps you get started with setting up your computer.

The **Quick Guide** introduces you to the basic features and functions of your new computer. For more on how your computer can help you to be more productive, please refer to the **User's Manual**. This guide contains detailed information on such subjects as system utilities, data recovery, expansion options and troubleshooting. In addition it contains general regulations and safety notices for your notebook. It is available from Desktop; double-click the Help icon and click **User's Manual** in the menu that opens.

Basic care and tips for using your computer

Turning your computer on and off

To turn the power off, do any of the following:

- Use the Windows shutdown command: Press the *Windows key* + <C>, click **Settings** > **Power** then click **Shut Down**.

If you need to power down the computer for a short while, but don't want to completely shut it down, you can put it into *Hibernate* by pressing the power button.

You can also put the computer in sleep mode by pressing the sleep hotkey **<Fn> + <F4>**.

Note: *If you cannot power off the computer normally, press and hold the power button for more than four seconds to shut down the computer. If you turn off the computer and want to turn it on again, wait at least two seconds before powering up.*

Taking care of your computer

Your computer will serve you well if you take care of it.

- Do not expose the computer to direct sunlight. Do not place it near sources of heat, such as a radiator.
- Do not expose the computer to temperatures below 0° C (32° F) or above 50° C (122° F).
- Do not subject the computer to magnetic fields.
- Do not expose the computer to rain or moisture.
- Do not spill water or any liquid on the computer.
- Do not subject the computer to heavy shock or vibration.
- Do not expose the computer to dust or dirt.
- Never place objects on top of the computer.
- Do not slam the computer display when you close it.
- Never place the computer on uneven surfaces.

Taking care of your AC adapter

Here are some ways to take care of your AC adapter:

- Do not connect the adapter to any other device.
- Do not step on the power cord or place heavy objects on top of it. Carefully route the power cord and any cables away from foot traffic.
- When unplugging the power cord, do not pull on the cord itself but pull on the plug.
- The total ampere ratings of the equipment plugged in should not exceed the ampere rating of the cord if you are using an extension cord. Also, the total current rating of all equipment plugged into a single wall outlet should not exceed the fuse rating.

Cleaning and servicing

When cleaning the computer, follow these steps:

1. Turn off the computer.
2. Disconnect the AC adapter.
3. Use a soft, moist cloth. Do not use liquid or aerosol cleaners.

If either of the following occurs:

- The computer has been dropped or the body has been damaged;
- The computer does not operate normally

Please refer to "**Frequently asked questions**" on page 87.

YOUR ACER NOTEBOOK TOUR

After setting up your computer as illustrated in the Setup Guide, let us show you around your new Acer computer.



Aspire V7-481P / V7-482P / V5-472P / V5-473P / V5-452P

Screen view



| # | Icon | Item | Description |
|---|------|-------------|---|
| 1 | | Webcam | Web camera for video communication. <i>A light next to the webcam indicates that the webcam is active.</i> |
| 2 | | Touchscreen | Displays computer output, supports multi-touch input. |

| # | Icon | Item | Description |
|---|------|-------------|--|
| 3 | | Microphones | Internal stereo microphones for sound recording. Note: <i>Only certain models have dual microphones, other models have a single microphone beneath the touchpad.</i> |

Keyboard view





| # | Icon | Item | Description |
|---|------|-------------------|--|
| 1 | | Power indicator | Indicates the computer's power status. |
| | | Battery indicator | Indicates battery status. Charging: The light is amber when the battery is charging. Fully charged: The light is blue. |

| # | Icon | Item | Description |
|---|------|----------|---|
| 2 | | Keyboard | For entering data into your computer. See "Using the keyboard" on page 28. Caution: Do not use a keyboard protector or similar cover as the keyboard includes ventilation intakes for cooling. |
| 3 | | Touchpad | Touch-sensitive pointing device. The touchpad and selection buttons form a single surface. Press down firmly on the touchpad surface to perform a left click. Press down firmly on the lower right corner to perform a right click. |

Left view





| # | Icon | Item | Description |
|---|--|------------|----------------------------|
| 1 |  | DC-in jack | Connects to an AC adapter. |
| 2 |  | USB port | Connects to USB devices. |

| # | Icon | Item | Description |
|---|---|--------------|--------------------------------|
| 3 |  | Power button | Turns the computer on and off. |



Right view



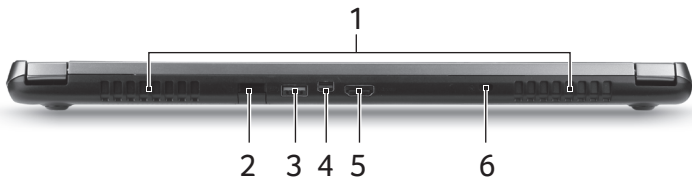

| # | Icon | Item | Description |
|---|---|----------------------|--|
| 1 |  | Headset/speaker jack | Connects to audio devices (e.g., speakers, headphones) or a headset with microphone. |
| 2 |  | SD card reader | Accepts one Secure Digital card (SD or SDHC). Note: To remove the card, simply pull it from the slot. Warning: The card sticks out from the side of the computer. Ensure you don't damage your card. |
| 3 |  | USB port | Connects to USB devices. |

Rear view



| # | Icon | Item | Description |
|---|---|----------------------------------|--|
| 1 | | Ventilation and cooling fan | Allows the computer to stay cool. Do not cover or obstruct the openings. |
| 2 |  | Ethernet (RJ-45) port | Connects to an Ethernet 10/100/1000-based network. Note: Pull the lip down to open the port fully. |
| 3 |  | USB port with power-off charging | Connects to USB devices. |

| # | Icon | Item | Description |
|---|---|----------------------|--|
| 4 |  | Acer Converter Port | Connects to the Acer Converter cable, allowing for easy connection to a LAN, an external display or an additional USB device. Note: <i>There are different cables available. Please check with your retailer to see which are compatible with your computer.</i> |
| 5 |  | HDMI port | Supports high-definition digital video connections. |
| 6 |  | Kensington lock slot | Connects to a Kensington-compatible computer security lock. <i>Wrap the computer security lock cable around an immovable object such as a table or handle of a locked drawer. Insert the lock into the notch and turn the key to secure the lock. Keyless models are also available.</i> |

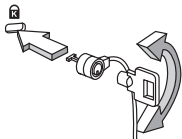

Information on USB 3.0

- USB 3.0 compatible ports are blue.
- Compatible with USB 3.0 and earlier devices.
- For optimal performance, use USB 3.0-certified devices.
- Defined by the USB 3.0 specification (SuperSpeed USB).

Base view

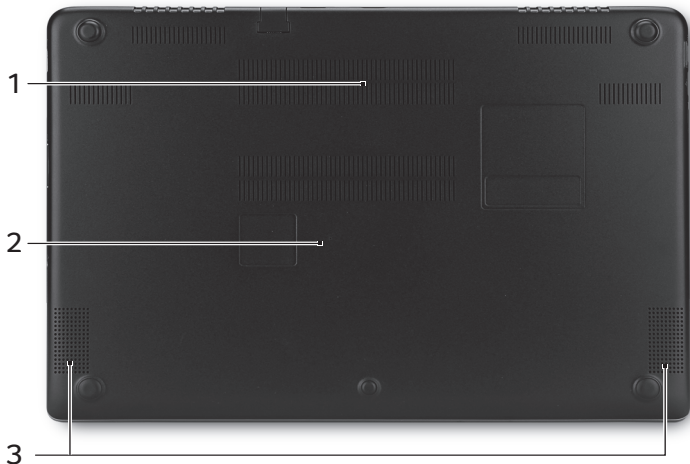

| # | Icon | Item | Description |
|---|---|-----------------------------|--|
| 1 | | Ventilation and cooling fan | Allows the computer to stay cool. Do not cover or obstruct the openings. |
| 2 |  | Battery reset pinhole | Insert a paperclip into the hole and press for four seconds to reset the computer (simulates removing and reinstalling the battery). |
| 3 | | Speakers | Deliver stereo audio output. |

USING THE KEYBOARD

The keyboard has full-sized keys and an embedded numeric keypad, separate cursor, lock, Windows, function and special keys.

Lock keys and embedded numeric keypad

Note: Information in this section may not apply to your computer.

The keyboard has three lock keys which you can toggle on and off.

| Lock key | Description |
|-----------------------------|--|
| Caps Lock | When Caps Lock is on, all alphabetic characters typed are in uppercase. |
| Num Lock <Fn> + <F11> | When Num Lock is on, the embedded keypad is in numeric mode. The keys function as a calculator (complete with the arithmetic operators +, -, *, and /). Use this mode when you need to do a lot of numeric data entry. |
| Scroll Lock <Fn> + <F12> | When Scroll Lock is on, the screen moves one line up or down when you press the up or down arrow keys respectively. Scroll Lock does not work with some applications. |

The embedded numeric keypad functions like a desktop numeric keypad. It is indicated by small characters located on the upper right corner of the

keycaps. To simplify the keyboard legend, cursor-control key symbols are not printed on the keys.









| Desired access | Num Lock on | Num Lock off |
|--|--|--|
| Number keys on embedded keypad | Type numbers in a normal manner. | |
| Cursor-control keys on embedded keypad | Hold <Shift> while using cursor-control keys. | Hold <Fn> while using cursor-control keys. |
| Main keyboard keys | Hold <Fn> while typing letters on embedded keypad. | Type the letters in a normal manner. |







Hotkeys

The computer employs hotkeys or key combinations to access most of the computer's controls like screen brightness and volume output.

To activate hotkeys, press and hold the <Fn> key before pressing the other key in the hotkey combination.



| Hotkey | Icon | Function | Description |
|-------------|---|---------------|---|
| <Fn> + <F3> |  | Airplane mode | Turns on / off the computer's network devices. <i>(Network devices vary by configuration.)</i> |

| Hotkey | Icon | Function | Description |
|--------------|---|--------------------|---|
| <Fn> + <F4> |  | Sleep | Puts the computer in Sleep mode. |
| <Fn> + <F5> |  | Display toggle | Switches display output between the display screen, external monitor (if connected) and both. |
| <Fn> + <F6> |  | Display off | Turns the display screen backlight off to save power. Press any key to return. |
| <Fn> + <F7> |  | Touchpad toggle | Turns the built-in touchpad on and off. |
| <Fn> + <F8> |  | Speaker toggle | Turns the speakers on and off. |
| <Fn> + <F9> |  | Keyboard backlight | Turns the keyboard backlight on and off. Note: <i>This feature is only available on certain models.</i> |
| <Fn> + <F11> | NumLk | Number Lock | Turns the embedded numeric keypad on or off. |
| <Fn> + <F12> | Scr Lk | Scroll Lock | Turns Scroll Lock on or off. |
| <Fn> + <▷> |  | Brightness up | Increases the screen brightness. |
| <Fn> + <◁> |  | Brightness down | Decreases the screen brightness. |

| Hotkey | Icon | Function | Description |
|-------------------|---|-------------|---------------------------------------|
| <Fn> + <△> |  | Volume up | Increases the sound volume. |
| <Fn> + <▽> |  | Volume down | Decreases the sound volume. |
| <Fn> + <Home> |  | Play/Pause | Play or pause a selected media file. |
| <Fn> + <Pg Up> |  | Stop | Stop playing the selected media file. |
| <Fn> + <Pg Dn> |  | Previous | Return to the previous media file. |
| <Fn> + <End> |  | Next | Jump to the next media file. |

Windows keys

The keyboard has two keys that perform Windows-specific functions.

| Key | Description |
|---|---|
|  Windows key | Pressed alone it returns to the Start screen. It can also be used with other keys for special functions, please check Windows Help. |
|  Application key | This key has the same effect as clicking the right mouse button; it opens the application's context menu. |

TOUCHPAD



Touchpad basics

The touchpad controls the arrow (or 'cursor') on the screen. As you slide your finger across the touchpad, the cursor will follow this movement. 

Note: *The touchpad is sensitive to finger movement; the lighter the touch, the better the response.*

Please keep the touchpad and your fingers dry and clean.

The cursor is controlled by some basic gestures:

- **Single-finger slide:** Slide a finger across the touchpad to move the cursor. 
- **Single-finger press** or **tap:** Press the touchpad down, or lightly tap the touchpad with your finger, to perform a 'click', which will select or start an item. Quickly repeat the tap to perform a double tap or 'double click'.
- **Single-finger press** in the bottom-right corner: Press the bottom right corner of the touchpad  to perform a 'right click'. In the Start screen, this will toggle the app commands, in most apps this will open a context menu related to the selected item. 

- **Drag:** Press and hold the bottom left corner of the touchpad, or tap twice anywhere on the touchpad, then slide a second finger across the touchpad to select all items in an area.

Touchpad gestures

Windows 8 and many applications support touchpad gestures that use one or more fingers.

Note: Support for touchpad gestures depends on the active application.

This allows you to control applications with a few simple gestures, such as:

- **Swipe in from edge:** Access Windows tools by swiping into the center of the touchpad from the right, top or left.



- **Swipe in from right edge:** Toggle the charms.
- **Swipe in from top edge:** Toggle the app commands.
- **Swipe in from left edge:** Switch to the previous app.
- **Two-finger slide:** Swiftly scroll through web pages, documents and playlists by placing two fingers on the touchpad and moving both in any direction.
- **Two-finger pinch:** Zoom in and out of photos, maps and documents with a simple finger-and-thumb gesture.



RECOVERY

If you are having trouble with your computer, and the frequently asked questions (see page 87) do not help, you can 'recover' your computer - i.e. return it to an earlier state.

This section describes the recovery tools available on your computer. Acer provides *Acer Recovery Management*, which allows you to create a *recovery backup*, a *drivers and applications backup*, and to start recovery options, either using Windows tools, or the recovery backup.

Note: *Acer Recovery Management is only available with a pre-installed Windows operating system.*

Important: We recommend that you create a **Recovery Backup** and **Drivers and Applications Backup** and as soon as possible. In certain situations a full recovery will require a USB recovery backup.

Creating a recovery backup

To reinstall from a USB storage drive, you must first create a recovery backup. The recovery backup includes the entire original contents of your computer's hard drive, including Windows and all factory-loaded software and drivers. Using this backup will restore your computer to the same state as when you purchased it, while giving you an option to retain all settings and personal data.

Note: Since the recovery backup requires at least 16 GB of storage after formatting, it is recommended to use a USB drive with a capacity of 32 GB or larger.

1. From *Start*, type 'Recovery' and then click **Acer Recovery Management** in the list of apps.

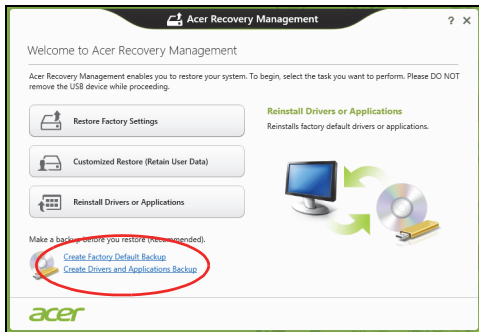

2. Click **Create Factory Default Backup**. The *Recovery Drive* window

opens.

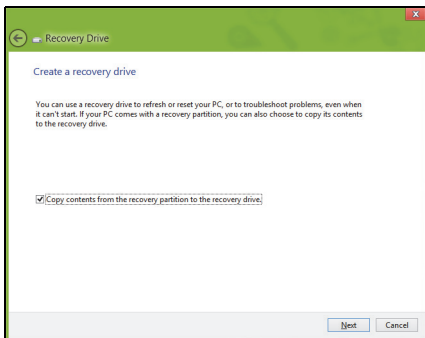

Make sure **Copy contents from the recovery partition to the recovery drive** is selected. This provides the most complete and safest recovery backup.

3. Plug in the USB drive then click **Next**.

- *Since the recovery backup requires at least 16 GB of storage after formatting, it is recommended to use a USB drive with a capacity of 32 GB or larger.*

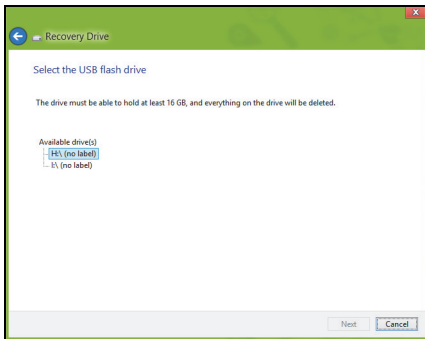

4. You will be shown the backup progress on the screen.
5. Follow the process until it completes.
6. After creating the recovery backup, you can choose to delete the recovery information on your computer. If you delete this information, you can only use the USB recovery backup to restore your computer, if you lose or erase the USB drive, you cannot restore your computer.

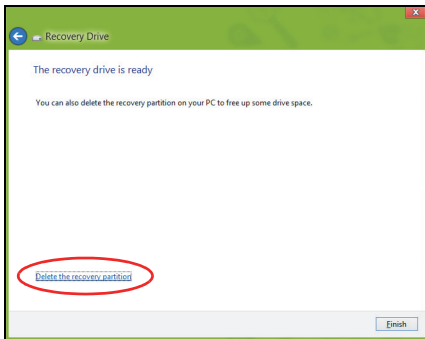

7. Unplug the USB drive and label it clearly.

Important: Write a unique, descriptive label on the backup, such as 'Windows Recovery Backup'. Make sure you keep the backup in a safe place that you will remember.

Creating a drivers and applications backup

To create a Drivers and Applications Backup, that contains the factory-loaded software and drivers needed by your computer, you may use either

a USB storage drive or, if your computer features a DVD recorder, one or more blank recordable DVDs.

1. From *Start*, type 'Recovery' and then click **Acer Recovery Management** in the list of apps.

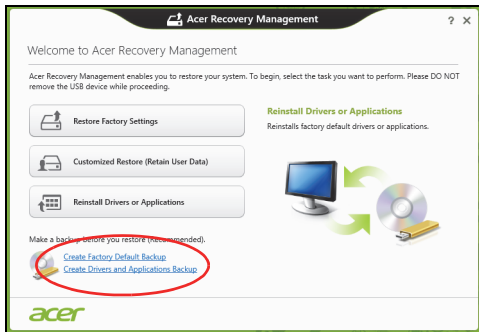

2. Click **Create Drivers and Applications Backup**.

Plug in the USB drive or insert a blank DVD into the optical drive, then click **Next**.

- If you are using a USB drive, make sure your USB drive has enough capacity before continuing.



- If using DVDs, it will also show the number of blank, recordable discs you will need to complete the recovery discs. Make sure that you have the required number of identical, blank discs.



3. Click **Start** to copy files. You will be shown the backup progress on the screen.
4. Follow the process until it completes:
 - If you are using optical discs, the drive ejects each disc as it completes burning it. Remove the disc from the drive and mark it with a permanent marker.
If multiple discs are required, insert a new disc when prompted, then click **OK**. Continue until the process is complete.
 - If you are using a USB drive, unplug the drive and label it clearly.
Important: Write a unique, descriptive label on each backup, such as 'Drivers and Applications Backup'. Make sure you keep the backup in a safe place that you will remember.

Recovering your system

To recover your system:

1. Perform minor fixes.

If only one or two items of software or hardware have stopped working correctly, the problem may be solved by reinstalling the software or the device drivers.

To reinstall software and drivers that were pre-installed at the factory, see **"Reinstalling drivers and applications" on page 42**.

For instructions on reinstalling software and drivers that were not pre-installed, see that product's documentation or support Web site.

2. Revert to a previous system condition.

If reinstalling software or drivers does not help, then the problem may be

solved by returning your system to a previous state when everything was working correctly.

For instructions, see **"Returning to an earlier system snapshot" on page 45.**

3. Reset your operating system.

If nothing else has solved the problem and you want to reset your system, but keep your user information, see **"Returning your system to its factory condition" on page 46.**

4. Reset your system to its factory condition.

If nothing else has solved the problem and you want to reset your system to factory condition, see **"Returning your system to its factory condition" on page 46.**

Reinstalling drivers and applications

As a troubleshooting step, you may need to reinstall the applications and device drivers that came pre-installed on your computer from the factory. You can reinstall using either your hard drive or the backup you have created.

- Other applications - If you need to reinstall software that did not come pre-installed on your computer, you need to follow that software's installation instructions.
- New device drivers - If you need to reinstall device drivers that did not come pre-installed on your computer, follow the instructions provided with the device.

If you are reinstalling using Windows and the recovery information stored on your computer:

- From *Start*, type 'Recovery' and then click **Acer Recovery Management** in the list of apps.



- Click **Reinstall Drivers or Applications**.

- You should see the **Contents** section of the **Acer Resource Center**.



- Click the **install** icon for the item you want to install, then follow the onscreen instructions to complete the installation. Repeat this step for each item you want to reinstall.



If you are reinstalling from a Drivers and Applications Backup on a DVD or USB drive:

1. Insert the **Drivers and Applications Backup** into the disc drive or connect it to a free USB port.
 - If you inserted a DVD wait for **Acer Resource Center** to start.
 - If **Acer Resource Center** does not start automatically, press the *Windows key* + <E>, then double-click on the optical drive icon.
 - If you are using a USB drive, press the *Windows key* + <E>, then double-click on the drive that contains the backup. Double-click on **ResourceCenter**.

2. You should see the **Contents** section of the **Acer Resource Center**.



3. Click the **install** icon for the item you want to install, then follow the onscreen prompts to complete the installation. Repeat this step for each item you want to reinstall.



Returning to an earlier system snapshot

Microsoft System Restore periodically takes a 'snapshot' of your system settings and saves them as restore points. In most cases of hard-to-resolve software problems, you can return to one of these restore points to get your system running again.

Windows automatically creates an additional restore point each day, and also each time you install software or device drivers.

Note: For more information about using Microsoft System Restore, from *Start*, type 'Help' and then click **Help and Support** in the list of

apps. Type 'Windows system restore' in the Search Help box, then press **Enter**.

Returning to a restore point

1. From **Start**, type 'Control Panel' and then click **Control Panel** in the list of apps.
2. Click **System and Security > Action Center**, then click **Recovery** at the bottom of the window.
3. Click **Open System Restore**, then **Next**.
4. Click the latest restore point (at a time when your system worked correctly), click **Next**, then **Finish**.
5. A confirmation window appears; click **Yes**. Your system is restored using the restore point you specified. This process may take several minutes, and may restart your computer.

Returning your system to its factory condition

If your computer experiences problems that are not recoverable by other methods, you may need to reinstall everything to return your system to its factory condition. You can recover from either your hard drive or the recovery backup you have created.

- If you can still run Windows and have not deleted the recovery partition, see "**Recovering from Windows**" on page 47.
- If you cannot run Windows, your original hard drive has been completely re-formatted or you have installed a replacement hard drive, see "**Recovering from a recovery backup**" on page 51.

Recovering from Windows

Start Acer Recovery Management:

- From *Start*, type 'Recovery' and then click **Acer Recovery Management** in the list of apps.

Two options are available, **Restore Factory Settings** (Reset my PC) or **Customized Restore** (Refresh my PC).

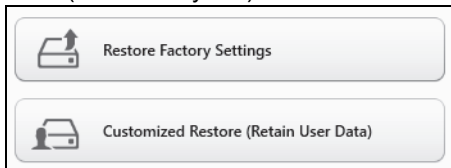

Restore Factory Settings deletes everything on your hard drive, then reinstalls Windows and all software and drivers that were pre-installed on your system. If you can access important files on your hard drive, back them up now. See "**Restore Factory Settings with Acer Recovery Management**" on page 48.

Customized Restore will attempt to retain your files (user data) but will reinstall all software and drivers. Software installed since you purchased your PC will be removed (except software installed from the Windows Store). See "**Customized Restore with Acer Recovery Management**" on page 50.

Restore Factory Settings with Acer Recovery Management

1. Click **Restore Factory Settings**.

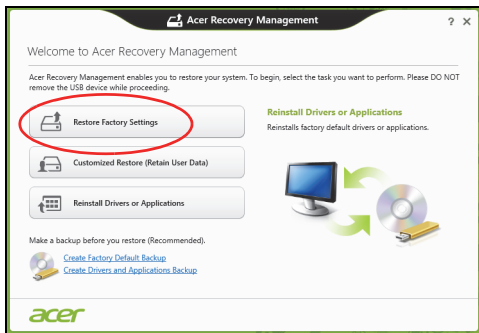

Caution: 'Restore Factory Settings' will erase all files on your hard drive.

2. The **Reset your PC** window opens.

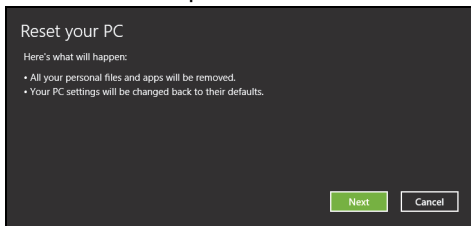

Images for reference only.

3. Click **Next**, then choose how to erase your files:

- a. **Just remove my files** quickly erases all files before restoring your computer and takes about 30 minutes.
 - b. **Fully clean the drive** completely cleans the drive after each file is erased, so no files can be viewed after the recovery. Cleaning the drive takes much longer, up to 5 hours, but is much more secure as old files are completely removed.
4. Click **Reset**.
 5. The recovery process begins by restarting your computer, then continues by copying files to your hard drive.
 6. After the recovery has finished, you can start using your computer by repeating the first-start process.

Recovering from the hard drive during startup

1. Turn on your computer and press <Alt> + <F10> during startup. A screen appears asking you to choose the keyboard layout.
2. Several options are now presented. Click **Troubleshoot**.
3. Click either **Refresh your PC** or **Reset your PC**.

Note: "Refresh your PC" enables you to restore your computer to the default factory condition with files intact. "Reset your PC" completely removes all your files and resets your computer to factory settings.

4. Click **Next**. The process will take several minutes.

Customized Restore with Acer Recovery Management

1. Click **Customized Restore (Retain User Data)**.



2. The **Refresh your PC** window opens.

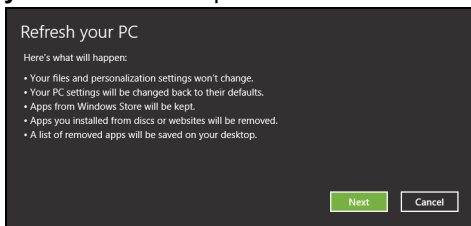

3. Click **Next**, then **Refresh**.

4. The recovery process begins by restarting your computer, then continues by copying files to your hard drive. This process takes about 30 minutes.

Recovering from a recovery backup

To recover from a recovery backup on a USB drive:

1. Find your recovery backup.
2. If your computer does not have a built-in keyboard, make sure a keyboard is attached to your computer.
3. Plug in the USB drive and turn on your computer.
4. If it is not already enabled, you must enable the *F12 Boot Menu*:
 - a. Press <F2> when starting your computer.
 - b. Use the left or right arrow keys to select the **Main** menu.
 - c. Press the down key until **F12 Boot Menu** is selected, press <F5> to change this setting to **Enabled**.
 - d. Use the left or right arrow keys to select the **Exit** menu.
 - e. Depending on the type of BIOS your computer uses, select **Save Changes and Exit** or **Exit Saving Changes** and press **Enter**. Select **OK** or **Yes** to confirm.
 - f. Your computer will restart.
5. During startup, press <F12> to open the boot menu. The boot menu allows you to select which device to start from, select the USB drive.
 - a. Use your arrow keys to select **USB Device**, then press **Enter**.
 - b. Windows starts from the recovery backup instead of the normal startup process.
6. Select your keyboard type.

7. Select **Troubleshoot** and then choose the type of recovery to use:
 - a. Click **Advanced** then **System Restore** to start Microsoft System Restore:

Microsoft System Restore periodically takes a 'snapshot' of your system settings and saves them as restore points. In most cases of hard-to-resolve software problems, you can return to one of these restore points to get your system running again.
 - b. Click **Reset your PC** to start the reset process:

Reset your PC deletes everything on your hard drive, then reinstalls Windows and all software and drivers that were pre-installed on your system. If you can access important files on your hard drive, back them up now. See "**Reset your PC from the recovery backup**" on page 53.
 - c. Click **Refresh your PC** to start the refresh process:

Refresh your PC will attempt to retain your files (user data) but will reinstall all software and drivers. Software installed since you purchased your PC will be removed (except software installed from the Windows Store). See "**Refresh your PC from the recovery backup**" on page 54.

Reset your PC from the recovery backup

Caution: Reset your PC will erase all files on your hard drive.

1. The **Reset your PC** window opens.

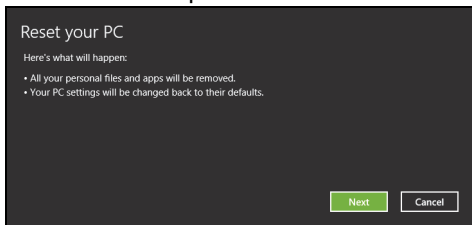

Images for reference only.

2. Click **Next**.

3. Select the operating system to recover (normally only one option is available).

4. Choose to keep any changes to the hard drive:

a. If you have deleted the recovery partition or otherwise changed the partitions on the hard drive and want to keep these changes, select **No**.

b. To completely restore your computer to Factory Settings, select **Yes**.

5. Choose how to erase your files:

a. **Just remove my files** quickly erases all files before restoring your computer and takes about 30 minutes.

b. **Fully clean the drive** completely cleans the drive after each file is erased, so no files can be viewed after the recovery. Cleaning the

drive takes much longer, up to 5 hours, but is much more secure as old files are completely removed.

6. Click **Reset**.
7. After the recovery has finished, you can start using your computer by repeating the first-start process.

Refresh your PC from the recovery backup

1. The **Refresh your PC** window opens.

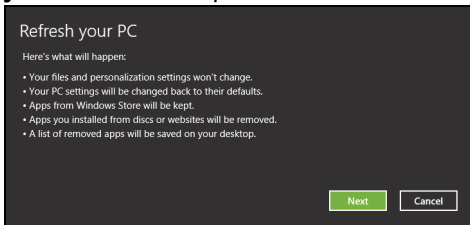

2. Click **Next**.
3. Select the operating system to recover (normally only one option is available).
4. Click **Refresh**.
5. The recovery process begins by restarting your computer, then continues by copying files to your hard drive. This process takes about 30 minutes.

POWER MANAGEMENT

This computer has a built-in power management unit that monitors system activity. System activity refers to any activity involving one or more of the following devices: keyboard, mouse, hard disk, peripherals connected to the computer, and video memory. If no activity is detected for a period of time, the computer stops some or all of these devices in order to conserve energy.

Disable Fast startup

Your computer uses Fast startup to start quickly, but also uses a small amount of power to check for signals to start. These checks will slowly drain your computer's battery.

If you prefer to reduce your computer's power requirements and environmental impact, turn off Fast startup:

Note: If Fast startup is off, your computer will take longer to start from Sleep. Your computer will also not start if it receives an instruction to start over a network (Wake on LAN).

1. Open the Desktop.
 2. Click **Power Options** in the Notification area.
 3. Select **More Power Options**.
-
4. Select **Choose what the power buttons do**.

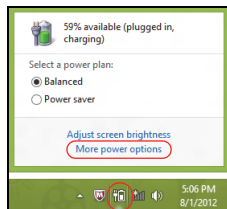

5. To access Shutdown Settings, select **Change settings that are currently unavailable**.

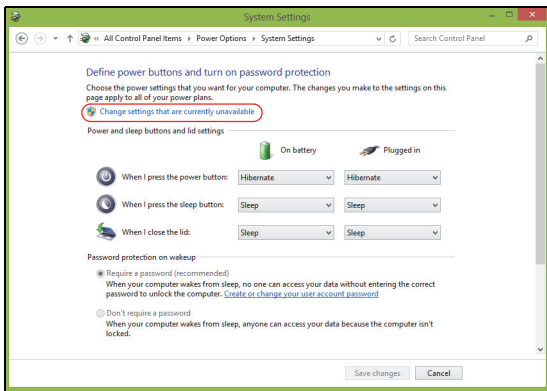

6. Scroll down and disable **Turn on fast startup**.

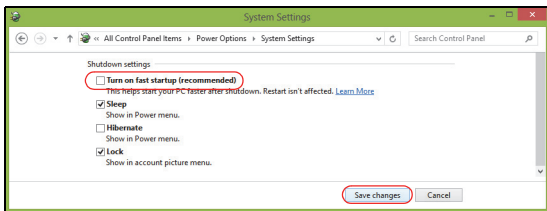

7. Select **Save changes**.

BATTERY PACK

The computer uses an embedded battery pack that gives you long use between charges.

Battery pack characteristics

The battery is recharged whenever you connect the computer to the AC adapter. Your computer supports charge-in-use, enabling you to recharge the battery while you continue to operate the computer. However, recharging with the computer turned off results in a significantly faster charge time.

Charging the battery

Plug the AC adapter into the computer, and connect to a mains power outlet. You can continue to operate your computer on AC power while your battery is charging. However, charging the battery with the computer turned off results in a significantly faster charge time.

Note: *You are advised to charge the battery before retiring for the day. Charging the battery overnight before traveling enables you to start the next day with a fully charged battery.*

Conditioning a new battery pack

Before you use a battery pack for the first time, there is a conditioning process that you should follow:

1. Connect the AC adapter and fully charge the battery.

2. Disconnect the AC adapter.
3. Turn on the computer and operate using battery power.
4. Fully deplete the battery until the battery-low warning appears.
5. Reconnect the AC adapter and fully charge the battery again.

Follow these steps again until the battery has been charged and discharged three times.

Use this conditioning process for all new batteries, or if a battery hasn't been used for a long time.

Warning! Do not expose battery packs to temperatures below 0° C (32° F) or above 45° C (113° F). Extreme temperatures may adversely affect the battery pack.

By following the battery conditioning process you condition your battery to accept the maximum possible charge. Failure to follow this procedure will prevent you from obtaining the maximum battery charge, and will also shorten the effective lifespan of the battery.

In addition, the useful lifespan of the battery is adversely affected by the following usage patterns:

- Using the computer on constant AC power.
- Not discharging and recharging the battery to its extremes, as described above.
- Frequent use; the more you use the battery, the faster it will reach the end of its effective life. A standard computer battery has a life span of about 300 charges.

Optimizing battery life

Optimizing battery life helps you get the most out of battery operation, prolonging the charge/recharge cycle and improving recharging efficiency. You are advised to follow the suggestions set out below:

- Use AC power whenever possible, reserving battery for mobile use.
- Remove accessories that are not being used (e.g. a USB disk drive), as they can continue to draw power.
- Store your PC in a cool, dry place. The recommended temperature is 10° C (50° F) to 30° C (86° F). Higher temperatures cause the battery to self-discharge faster.
- Excessive recharging decreases the battery life.
- Look after your AC adapter and battery.

Checking the battery level

The power meter indicates the current battery level. Rest the cursor over the battery/power icon on the taskbar to see the battery's present charge level.

Battery-low warning

When using battery power pay attention to the power meter.

Warning! Connect the AC adapter as soon as possible after the battery-low warning appears. Data may be lost if the battery is allowed to become fully depleted and the computer shuts down.

When the battery-low warning appears, the recommended course of action depends on your situation:

| Situation | Recommended Action |
|--|--|
| The AC adapter and a power outlet are available. | <ol style="list-style-type: none"><li data-bbox="306 161 985 225">1. Plug the AC adapter into the computer, and then connect to the main power supply.<li data-bbox="306 231 985 260">2. Save all necessary files.<li data-bbox="306 265 985 294">3. Resume work. <p data-bbox="306 299 985 363">Turn off the computer if you want to recharge the battery rapidly.</p> |
| The AC adapter or a power outlet is unavailable. | <ol style="list-style-type: none"><li data-bbox="306 376 985 405">1. Save all necessary files.<li data-bbox="306 410 985 439">2. Close all applications.<li data-bbox="306 444 985 473">3. Turn off the computer. |

TRAVELING WITH YOUR COMPUTER

This section gives you tips and hints to consider when moving around or traveling with your computer.

Disconnecting from the desktop

Follow these steps to disconnect your computer from external accessories:

1. Save any open files.
2. Remove discs from optical drive(s).
3. Shut down the computer.
4. Close the display cover.
5. Disconnect the cord from the AC adapter.
6. Disconnect the keyboard, pointing device, printer, external monitor and other external devices.
7. Disconnect the Kensington lock if you are using one to secure the computer.

Moving around

When you are just moving within short distances, for example, from your office desk to a meeting room.

Preparing the computer

Before moving the computer, close and latch the display cover to place it in Sleep mode. You can now safely take the computer anywhere you go within the building. To bring the computer out of Sleep mode, open the display; then press and release the power button.

If you are taking the computer to a client's office or a different building, you may choose to shut down the computer:

Press the *Windows key* + <C>, click **Settings** > **Power** then click **Shut Down**

Or:

You can put the computer in Sleep mode by pressing <Fn> + <F4>. Then close the display.

When you are ready to use the computer again, open the display; then press and release the power button.

***Note:** The computer may enter Hibernation or Deep Sleep mode after being in Sleep mode for a period of time.*

What to bring to meetings

If your meeting is relatively short, you probably do not need to bring anything with you other than your computer. If your meeting will be longer, or if your battery is not fully charged, you may want to bring the AC adapter with you to plug in your computer in the meeting room.

If the meeting room does not have an electrical outlet, reduce the drain on the battery by putting the computer in Sleep mode. Press <Fn> + <F4> or close the display cover whenever you are not actively using the computer.

Taking the computer home

When you are moving from your office to your home or vice versa.

Preparing the computer

After disconnecting the computer from your desktop, follow these steps to prepare the computer for the trip home:

- Check that you have removed all media and compact discs from the drive(s). Failure to remove the media can damage the drive head.
- Pack the computer in a protective case that can prevent the computer from sliding around and cushion it if it should fall.

Caution: Avoid packing items next to the top cover of the computer. Pressure against the top cover can damage the screen.

What to take with you

Unless you have some items at home, take the following items with you:

- AC adapter and power cord.
- The printed setup poster.

Special considerations

Follow these guidelines to protect your computer while traveling to and from work:

- Minimize the effects of temperature changes by keeping the computer with you.

- If you need to stop for an extended period of time and cannot carry the computer with you, leave the computer in the trunk of the car to avoid exposing the computer to excessive heat.
- Changes in temperature and humidity can cause condensation. Allow the computer to return to room temperature, and inspect the screen for condensation before turning on the computer. If the temperature change is greater than 10° C (18° F), allow the computer to come to room temperature slowly. If possible, leave the computer for 30 minutes in an environment with a temperature between outside and room temperature.

Setting up a home office

If you frequently work on your computer at home, you may want to purchase a second AC adapter for use at home. With a second AC adapter, you can avoid carrying the extra weight to and from home.

If you use your computer at home for significant periods of time, you might also want to add an external keyboard, monitor or mouse.

Traveling with the computer

When you are moving within a larger distance, for instance, from your office building to a client's office building or traveling locally.

Preparing the computer

Prepare the computer as if you were taking it home. Make sure that the battery in the computer is charged. Airport security may require you to turn on your computer when carrying it into the gate area.

What to take with you

Take the following items with you:

- AC adapter
- Additional printer driver files if you plan to use another printer

Special considerations

In addition to the guidelines for taking the computer home, follow these guidelines to protect your computer while traveling:

- Always take the computer as carry-on luggage.
- If possible, have the computer inspected by hand. Airport security X-ray machines are safe, but do not put the computer through a metal detector.

Traveling internationally with the computer

When you are moving from country to country.

Preparing the computer

Prepare the computer as you would normally prepare it for traveling.

What to bring with you

Bring the following items with you:

- AC adapter.
- Power cords that are appropriate for the country to which you are traveling.

- Additional printer driver files if you plan to use another printer.
- Proof of purchase, in case you need to show it to customs officials.
- International Travelers Warranty passport.

Special considerations

Follow the same special considerations as when traveling with the computer.

In addition, these tips are useful when traveling internationally:

- When traveling in another country, check that the local AC voltage and the AC adapter power cord specifications are compatible. If not, purchase a power cord that is compatible with the local AC voltage. Do not use converter kits sold for appliances to power the computer.
- If you are using the modem, check if the modem and connector are compatible with the telecommunications system of the country you are traveling in.

SECURING YOUR COMPUTER

Your computer is a valuable investment that you need to take care of. Learn how to protect and take care of your computer.

Security features include hardware and software locks — a security notch and passwords.

Using a computer security lock

The computer comes with a Kensington-compatible security slot for a security lock.

Wrap a computer security lock cable around an immovable object such as a table or handle of a locked drawer. Insert the lock into the notch and turn the key to secure the lock. Some keyless models are also available.

Using passwords

Passwords protect your computer from unauthorized access. Setting these passwords creates several different levels of protection for your computer and data:

- Supervisor Password prevents unauthorized entry into the BIOS utility. Once set, you must enter this password to gain access to the BIOS utility. See **"BIOS utility" on page 86**.
- User Password secures your computer against unauthorized use. Combine the use of this password with password checkpoints on boot-up and resume from Hibernation (if available) for maximum security.

- Password on Boot secures your computer against unauthorized use. Combine the use of this password with password checkpoints on boot-up and resume from Hibernation (if available) for maximum security.

Important: Do not forget your Supervisor Password! If you forget your password, please get in touch with your dealer or an authorized service center.

Entering passwords

When a password is set, a password prompt appears in the center of the display screen.

- When the Supervisor Password is set, a prompt appears when you the BIOS utility.
- Type the Supervisor Password and press <Enter> to access the BIOS utility. If you enter the password incorrectly, a warning message appears. Try again and press <Enter>.
- When the User Password is set and the password on boot parameter is enabled, a prompt appears at boot-up.
- Type the User Password and press <Enter> to use the computer. If you enter the password incorrectly, a warning message appears. Try again and press <Enter>.

Important: You have three chances to enter a password. If you fail to enter the password correctly after three tries, the system halts. Press and hold the power button for four seconds to shut down the computer. Then turn on the computer again, and try again.

ACER THEFT SHIELD

Note: *This feature is only available on certain models.*

Acer Theft Shield is a tool for your computer that helps prevent theft by alerting you if your computer is moved out of range of your Android cellphone or the selected wireless network.

To start Acer Theft Shield, double-click the *Acer Theft Shield* icon on *Desktop*, or from *Start* simply start typing 'Acer Theft Shield' to open *Search* and list the results.

Note: *Acer Theft Shield needs a Windows Log On password. If you have not set a password, you will be reminded to set one.*

Once Acer Theft Shield is running, you will be asked to select the type of detection you wish to use. You may select:

- **Use an Android phone.**

- Use a Wi-Fi network.



If you select **Use an Android phone**, you will be shown a QR (Quick Reference) code that you can scan using your phone. The QR contains a link that will allow you to download the Android app to your phone.

Tip: If you do not select to use an Android phone at this stage, you can select to use an Android phone at any time from "**Settings**" on page **73**.

Note: If your phone does not have a barcode reader installed, you will need to download one before you can scan the QR code.



Once you have downloaded the Android app to your phone, click **Next** to start setting up Acer Theft Shield. Click **Start** to turn on your notebook's Wi-Fi hotspot feature, this will allow your phone to detect the notebook.

Using Acer Theft Shield

General

Once you have selected the method to use, you will be shown the *General* page which allows you to activate Acer Theft Shield and select a hotkey combination to activate Acer Theft Shield.

You can press the hotkey combination to protect your computer at any time.

Settings

The *Settings* page allows you to change alarm settings and also set up notifications on your Android phone.

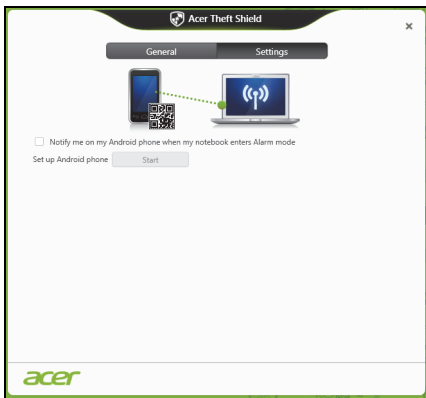

Tap **Edit** under *Configure your notebook's Wi-Fi hotspot network* to change the SSID that your notebook will broadcast while linking to your Android cellphone.

You can also change the alarm notification duration from the drop-down menu under *Alarm mode settings*.

Tip: To view the QR code to download the Android app again, click the  icon.

WIRELESS NETWORKS

Connecting to the Internet

Your computer's wireless connection is turned on by default.

Windows will detect and display a list of available networks during setup. Select your network and enter the password if required.

Otherwise, open Internet Explorer and follow the instructions.

Please refer to your ISP or router documentation.

Acer Instant Connect

Instant Connect ensures a faster connection to any of the networks that your computer connects to most frequently.

Wireless networks

A wireless LAN or WLAN is a wireless local area network, which may link two or more computers without using wires. Setting up a wireless network is easy and allows you to share files, peripheral devices and an Internet connection.

What are benefits of a wireless network?

Mobility

Wireless LAN systems allow you and other users of your home network to share access to files and devices connected to the network, for example a printer or scanner.

Also you can share an internet connection with other computers in your home.

Installation speed and simplicity

Installing a wireless LAN system can be fast and easy and eliminates the need to pull cables through walls and ceilings.

Components of a wireless LAN

To set up your Wireless network at home you need to have the following:

Access point (router)

Access points (routers) are two-way transceivers that broadcast data into the surrounding environment. Access points act as a mediator between wired and wireless network. Most routers have a built-in DSL modem that will allow you access to a high speed DSL internet connection. The ISP (Internet Service Provider) you have chosen normally supplies a modem/router with the subscription to their services. Read carefully the documentation supplied with your Access point/router for detailed setup instructions.

USING A BLUETOOTH CONNECTION

Bluetooth is a technology enabling you to transfer data wirelessly over short distances between many different types of devices. Bluetooth-enabled devices include computers, cell phones, tablets, wireless headsets, and keyboards.

To use Bluetooth, you must ensure the following:

1. Bluetooth is enabled on both devices.
2. Your devices are "paired" (or connected).

Enabling and disabling Bluetooth

The Bluetooth adapter must be enabled on both devices. For your computer, this may be an external switch, a software setting, or a separate Bluetooth dongle plugged into the computer's USB port (if no internal Bluetooth adapter is available).

Note: *Please check your devices owner's manual to determine how to turn on its Bluetooth adapter.*

Enabling Bluetooth from Windows 8

Bluetooth on your computer is disabled by default. To enable your computer's Bluetooth adapter, do the following:

1. Open the Charms and select **Settings** > **Change PC Settings** > **Wireless**, or press the *Windows key* + **<W>** and then type '*Wireless*'; in the results, click on **Wireless**.
2. Click the toggle next to **Bluetooth** to enable/disable it.
3. Then, from the *Desktop* notification area, click the Bluetooth icon, and select **Open Settings**.

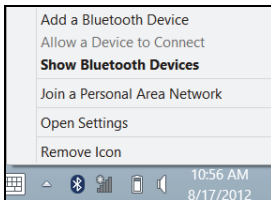

4. Select the **Allow Bluetooth devices to find this computer** check box, click **Apply**, and then click **OK**.

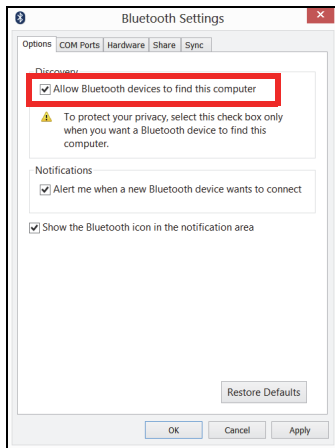

Adding a Bluetooth device

Every new device must first be "paired" with your computer's Bluetooth adapter. This means it must first be authenticated for security purposes. You only need to pair once. After that, simply turning on the Bluetooth adapter of both devices will connect them.

From the notification area, click the Bluetooth icon, and select **Add a Bluetooth Device**.

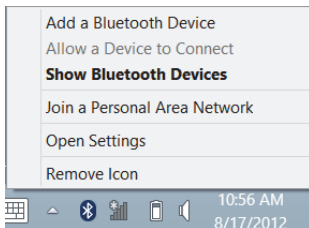

Click on the device you want to add.

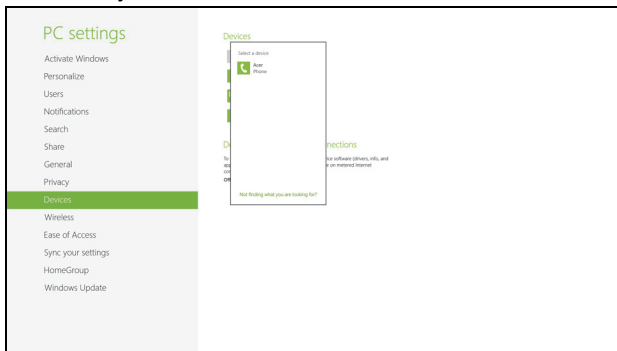

A code displays on your computer, which should match the code displayed on your device. Select **Yes**. Then, accept the pairing from your device.

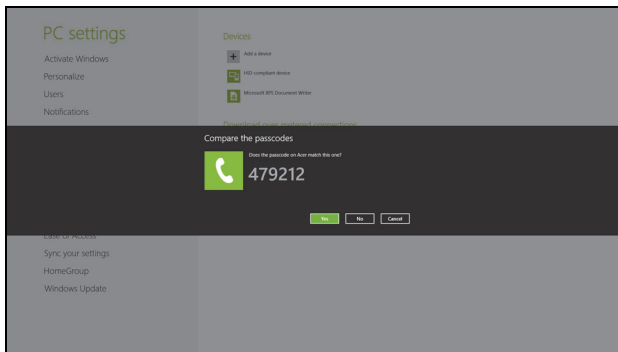

Note: Some devices using older versions of the Bluetooth technology require both devices to enter a PIN. In the case of one of the devices not having any inputs (as in a headset), the passcode is hardcoded into the device (usually "0000" or "1234"). Consult your device's user manual for more information.

Your device will show up in the list of devices if it was successfully paired. Open the **Control Panel** and under **Hardware and Sound** click on **View**

devices and printers. Right click on your device and select **Advanced Operations > Connect to operation window.**

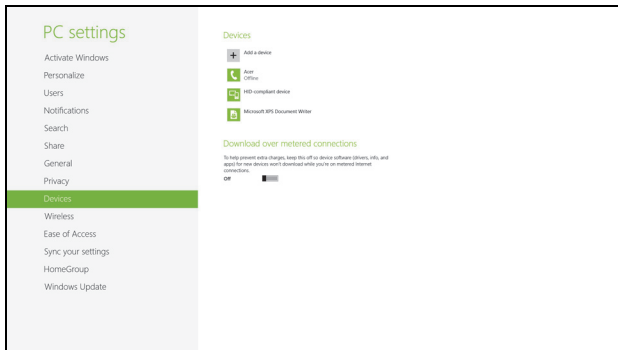

The operation window enables you to play music and audio from your device through your computer, send files to your device and change Bluetooth settings.

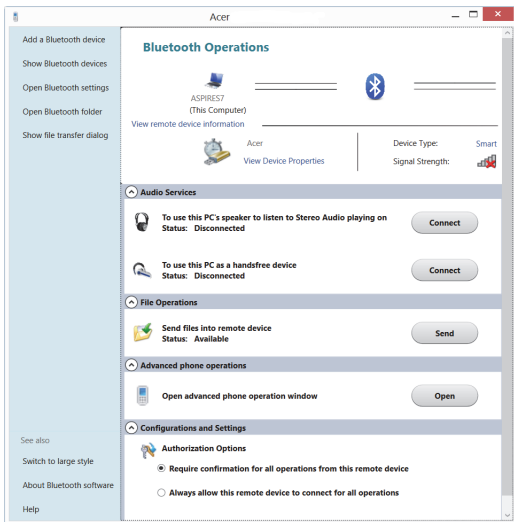

ACER CONVERTER PORT

Note: *There are different cables available. Please check with your retailer to see which are compatible with your computer.*

The Acer Converter Port is a proprietary port that allows you to extend the connectivity options of your computer using a single cable.

The Acer Converter Port supports one or more of the following through a dedicated cable: A LAN connection, an external display (VGA) port and an additional USB port.

You may connect more than one peripheral to the Acer Converter cable that is compatible with your computer.

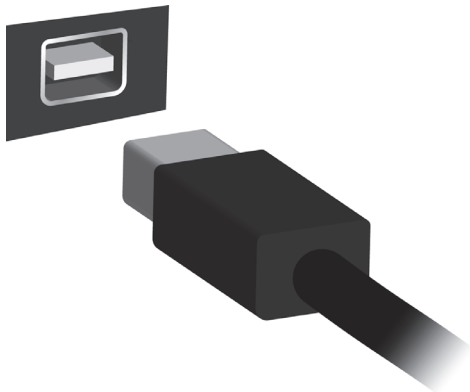

HDMI

HDMI (High-Definition Multimedia Interface) is an industry-supported, uncompressed, all-digital audio/video interface. HDMI provides an interface between any compatible digital audio/video source, such as a set-top box, DVD player, and A/V receiver and a compatible digital audio and/or video monitor, such as a digital television (DTV), over a single cable.

Use the HDMI port on your computer to connect with high-end audio and video equipment. Single cable implementation allows tidy setup and fast connection.

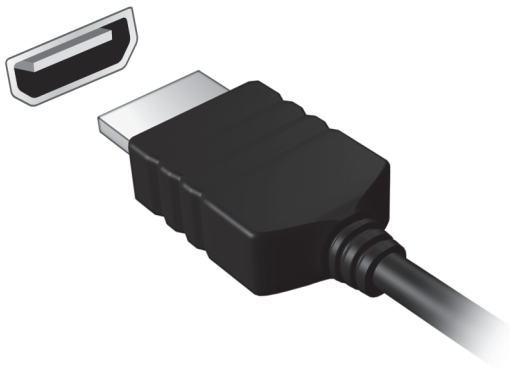

UNIVERSAL SERIAL BUS (USB)

The USB port is a high-speed serial bus which allows you to connect USB peripherals without taking up system resources.

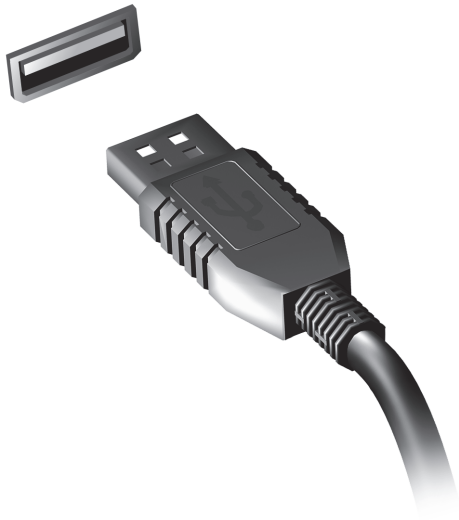

BIOS UTILITY

The BIOS utility is a hardware configuration program built into your computer's BIOS.

Your computer is already properly configured and optimized, and you do not need to run this utility. However, if you encounter configuration problems, you may need to run it.

To activate the BIOS utility, press <F2> during the POST while the computer logo is being displayed.

Boot sequence

To set the boot sequence in the BIOS utility, activate the BIOS utility, then select **Boot** from the categories listed at the top of the screen.

Setting passwords

To set a password on boot, activate the BIOS utility, then select **Security** from the categories listed at the top of the screen. Find **Password on boot:** and use the <F5> and <F6> keys to enable this feature.

FREQUENTLY ASKED QUESTIONS

The following is a list of possible situations that may arise during the use of your computer. Easy solutions are provided for each one.

I turned on the power, but the computer does not start or boot up

Look at the power indicator:

- If it is not lit, no power is being supplied to the computer. Check the following:
 - If you are using on the battery, it may be low and unable to power the computer. Connect the AC adapter to recharge the battery pack.
 - Make sure that the AC adapter is properly plugged into the computer and to the power outlet.
- If it is lit, check the following:
 - Do you have a USB storage device (USB disk or smartphone) plugged into your computer? Unplug it and press <Ctrl> + <Alt> + to restart the system.

Nothing appears on the screen

The computer's power management system automatically blanks the screen to save power. Press any key to turn the display back on.

If pressing a key does not turn the display back on, three things might be the cause:

- The brightness level might be too low. Press <Fn> + <▷> (increase) to adjust the brightness level.
- The display device might be set to an external monitor. Press the display toggle hotkey <Fn> + <F5> to toggle the display back to the computer.
- If the Sleep indicator is lit, the computer is in Sleep mode. Press and release the power button to resume.

No audio is heard from the computer

Check the following:

- The volume may be muted. In Windows, look at the volume control (speaker) icon on the taskbar. If it is crossed-out, click the icon and deselect the **Mute all** option.
- The volume level may be too low. In Windows, look at the volume control icon on the taskbar. You can also use the volume control buttons to adjust the volume.
- If headphones, earphones or external speakers are connected to the line-out port on the computer, the internal speakers automatically turn off.

The keyboard does not respond

Try attaching an external keyboard to a USB port on the computer. If it works, contact your dealer or an authorized service center as the internal keyboard cable may be loose.

The printer does not work

Check the following:

- Make sure that the printer is connected to a power outlet and that it is turned on.
- Make sure that the printer cable is connected securely to a USB port and the corresponding port on the printer.

Requesting service

International Travelers Warranty (ITW)

Your computer is backed by an International Travelers Warranty (ITW) that gives you security and peace of mind when traveling. Our worldwide network of service centers are there to give you a helping hand.

An ITW passport comes with your computer. This passport contains all you need to know about the ITW program. A list of available, authorized service centers is in this handy booklet. Read this passport thoroughly.

Always have your ITW passport on hand, especially when you travel, to receive the benefits from our support centers. Place your proof-of-purchase in the flap located inside the front cover of the ITW passport.

If the country you are traveling in does not have an Acer-authorized ITW service site, you can still get in contact with our offices worldwide. Please visit **www.acer.com**.

Before you call

Please have the following information available when you call Acer for online service, and please be at your computer when you call. With your support, we can reduce the amount of time a call takes and help solve your problems efficiently. If there are error messages or beeps reported by your computer, write them down as they appear on the screen (or the number and sequence in the case of beeps).

You are required to provide the following information:

Name:

Address:

Telephone number:

Machine and model type:

Serial number:

Date of purchase:

Tips and hints for using Windows 8

We know this is a new operating system that will take some getting used to, so we've created a few pointers to help you get started.

Three concepts you might want to keep in mind

1. Start

The Start button is no longer available; you can launch apps from the Start screen.

2. Tiles

Live tiles are similar to thumbnails of the apps.

3. Charms

Charms allow you to perform useful functions, such as sharing content, turning off your PC or changing settings.

How do I access the charms?

Swipe the right-hand edge of the screen inwards.

How do I get to Start?

Press the Windows key; or swipe the right-hand edge of the screen inwards and tap the **Start** charm.

How do I jump between apps?

Swipe the left-hand edge of the screen inwards to cycle through apps that are currently running.

How do I turn off my computer?

Swipe the right-hand edge of the screen inwards, tap **Settings** > **Power** and select the action you'd like to take. Alternatively, from *Desktop*, tap **Acer Power Button** and select the action you'd like to take.

Why is there a new interface?

The new interface for Windows 8 is designed to work well with touch input. Windows Store apps will automatically use the whole screen and don't require closing in the traditional way. Windows Store apps will be displayed on Start using live-tiles.

What are 'live tiles'?

Live tiles are similar to thumbnails of the app that will be updated with new content whenever you're connected to the Internet. So, for example, you can view weather or stock updates without needing to open the app.

How do I unlock my computer?

Swipe the lock screen upwards and tap a user account icon to unlock the computer. If your account has a password set, you will need to enter the password to continue.

Tap and hold the *preview* icon to see the characters you've entered to ensure the password is correct.

How do I personalize my computer?

You can personalize *Start* with a different background image or by arranging the tiles to suit your personal needs.

To change the background, swipe the right-hand edge of the screen inwards and tap **Settings** > **Change PC settings** > **Personalize**. Tap **Start screen** at the top of the page and select a color and image.

How do I move tiles?

Tap and hold a tile to select it, then drag it to the place on *Start* that you want it to appear. Other tiles will be moved to accommodate the tile in its new location.

Can I make tiles bigger or smaller?

Tap and drag the tile downwards and release it. Select **Smaller** or **Larger** from the menu that appears at the bottom of the screen.

How do I personalize the Lock screen?

You can personalize the lock screen with a different image or to show you quick status and notifications to suit your personal needs.

To change the background, swipe the right-hand edge of the screen inwards and tap **Settings** > **Change PC settings** > **Personalize**. Tap **Lock screen** at the top of the page and select the image and apps you would like to see on the lock screen.

So, how do I close an app?

Swipe the window downwards from the top to the bottom of the screen.

Can I change the screen resolution?

Swipe the right-hand edge of the screen inwards and tap **Search**, tap the text box to open the onscreen keyboard and start typing 'Control Panel' to display the results; tap **Control Panel > Adjust screen resolution**.

I want to use Windows in the way that I'm used to - give me my desktop back!

From *Start* tap the **Desktop** tile to see a traditional desktop. You can pin apps you frequently use to the taskbar to easily open them.

If you click an app that is not a Windows Store app, Windows will automatically open the app using *Desktop*.

Where are my apps?

Swipe the right-hand edge of the screen inwards and tap **Search**, type the name of the app you would like to open using the pop-up keyboard. Results will be displayed on the left-hand side of the screen.

To view the complete list of apps, swipe upwards from the bottom of the screen and tap **All apps**.

How do I make an app appear on Start?

If you're in *All apps* and you want to make an app appear on *Start*, tap and drag the app downwards and release it. Tap **Pin to Start** from the menu that appears at the bottom of the screen.

How do I remove a tile from Start?

Tap and drag the app downwards and release it. Tap **Unpin from Start** from the menu that appears at the bottom of the screen.

How do I make an app appear on my taskbar in Desktop?

If you're in *All apps* and you want to make an app appear on the taskbar in *Desktop*, tap and drag the app downwards and release it. Select **Pin to taskbar** from the menu that appears at the bottom of the screen.

How do I install apps?

You can download Windows Store apps from *Store*. You will need to have a Microsoft ID to purchase and download apps from *Store*.

I can't find apps like Notepad and Paint! Where are they?

Swipe the right-hand edge of the screen inwards and tap **Search**, type the name of the app you would like to open using the pop-up keyboard. Alternatively, open *All apps* and scroll to 'Windows Accessories' to see the list of legacy programs.

What is a Microsoft ID (account)?

A Microsoft account is an email address and password that you use to sign in to Windows. You can use any email address, but it is best if you choose the one you already use to communicate with friends and sign in to your favorite websites. When you sign in to your PC with a Microsoft account, you'll connect your PC to the people, files, and devices you care about.

Do I need one?

You do not need a Microsoft ID to use Windows 8, but it makes life easier because you can sync data across different machines you sign in to using a Microsoft ID.

How do I get one?

If you've already installed Windows 8 and didn't sign in with a Microsoft account or you don't have a Microsoft account and want to get one, swipe the right-hand edge of the screen inwards and tap **Settings** > **Change PC settings** > **Users** > **Switch to a Microsoft account**, and follow the onscreen instructions.

How do I add a favorite to Internet Explorer?

Internet Explorer 10 doesn't have traditional favorites, instead you can pin shortcuts to *Start*. Once you have the page open, swipe upwards from the bottom edge of the screen to open the menu at the bottom of the screen. Tap **Pin to Start**.

How do I check for Windows updates?

Swipe the right-hand edge of the screen inwards and tap **Settings** > **Change PC settings** > **Windows Updates**. Tap **Check for updates now**.

Where can I get more information?

For more information please visit the following pages:

- Windows 8 tutorials: www.acer.com/windows8-tutorial
- Support FAQs: www.acer.com/support

Troubleshooting

This chapter shows you how to deal with common system problems. Read it before calling a technician if a problem occurs. Solutions to more serious problems require opening up the computer. Do not attempt to open the computer yourself; contact your dealer or authorized service center for assistance.

Troubleshooting tips

This computer incorporates an advanced design that delivers onscreen error message reports to help you solve problems.

If the system reports an error message or an error symptom occurs, see "Error messages" below. If the problem cannot be resolved, contact your dealer. See **"Requesting service" on page 89**.

Error messages

If you receive an error message, note the message and take the corrective action. The following table lists the error messages in alphabetical order together with the recommended course of action.

| Error messages | Corrective action |
|-----------------------|--|
| CMOS battery bad | Contact your dealer or an authorized service center. |
| CMOS checksum error | Contact your dealer or an authorized service center. |

| Error messages | Corrective action |
|---|---|
| Disk boot failure | Insert a system (bootable) disk, then press <Enter> to reboot. |
| Equipment configuration error | Press <F2> (during POST) to enter the BIOS utility, then press Exit in the BIOS utility to reboot. |
| Hard disk 0 error | Contact your dealer or an authorized service center. |
| Hard disk 0 extended type error | Contact your dealer or an authorized service center. |
| I/O parity error | Contact your dealer or an authorized service center. |
| Keyboard error or no keyboard connected | Contact your dealer or an authorized service center. |
| Keyboard interface error | Contact your dealer or an authorized service center. |
| Memory size mismatch | Press <F2> (during POST) to enter the BIOS utility, then press Exit in the BIOS utility to reboot. |

If you still encounter problems after going through the corrective measures, please contact your dealer or an authorized service center for assistance.

REGULATIONS AND SAFETY NOTICES

FCC STATEMENT

This device has been tested and found to comply with the limits for a Class B digital device pursuant to Part 15 of the FCC rules. These limits are designed to provide reasonable protection against harmful interference in a residential installation. This device generates, uses, and can radiate radio frequency energy and, if not installed and used in accordance with the instructions, may cause harmful interference to radio communications.

However, there is no guarantee that interference will not occur in a particular installation. If this device does cause harmful interference to radio or television reception, which can be determined by turning the device off and on, the user is encouraged to try to correct the interference by one or more of the following measures:

- Reorient or relocate the receiving antenna.
- Increase the separation between the device and receiver.
- Connect the device into an outlet on a circuit different from that to which the receiver is connected.
- Consult the dealer or an experienced radio/television technician for help.

Notice: Shielded cables

All connections to other computing devices must be made using shielded cables to maintain compliance with FCC regulations.

NOTICE: PERIPHERAL DEVICES

Only peripherals (input/output devices, terminals, printers, etc.) certified to comply with the Class B limits may be attached to this equipment. Operation with non-certified peripherals is likely to result in interference to radio and TV reception.

Caution: Changes or modifications not expressly approved by the manufacturer could void the user's authority, which is granted by the Federal Communications Commission, to operate this computer.

NOTICE FOR CANADA

This Class B digital apparatus complies with Canadian ICES-003.

Remarque à l'intention des utilisateurs canadiens

Cet appareil numérique de la classe B est conforme à la norme NMB-003 du Canada.

COMPLIANT WITH RUSSIAN REGULATORY CERTIFICATION



ME61

LCD PIXEL STATEMENT

The LCD unit is produced with high-precision manufacturing techniques. Nevertheless, some pixels may occasionally misfire or appear as black or red dots. This has no effect on the recorded image and does not constitute a malfunction.

RADIO DEVICE REGULATORY NOTICES

Note: *Below regulatory information is for models with wireless LAN and / or Bluetooth only.*

To prevent radio interference to the licensed service, this device is intended to be operated indoors.

This product complies with the radio frequency and safety standards of any country or region in which it has been approved for wireless use. Depending on configurations, this product may or may not contain wireless radio devices (such as wireless LAN and/or Bluetooth modules). Below information is for products with such devices.

Declaration of Conformity for EU countries

Hereby, Acer, declares that this computer is in compliance with the essential requirements and other relevant provisions of Directive 1999/5/EC.

Wireless operation channels for different domains

| | | |
|-------------|-----------------|-------------------|
| N. America | 2.412-2.462 GHz | Ch01 through Ch11 |
| Japan | 2.412-2.484 GHz | Ch01 through Ch14 |
| Europe ETSI | 2.412-2.472 GHz | Ch01 through Ch13 |

France: Restricted wireless frequency bands

Some areas of France have a restricted frequency band. The worst case maximum authorized power indoors is:

- 10 mW for the entire 2.4 GHz band (2400 MHz - 2483.5 MHz)
- 100 mW for frequencies between 2446.5 MHz and 2483.5 MHz

Note: Channels 10 through 13 inclusive operate in the band 2446.6 MHz to 2483.5 MHz.

There are few possibilities for outdoor use: On private property or on the private property of public persons, use is subject to a preliminary authorization procedure by the Ministry of Defense, with maximum authorized power of 100 mW in the 2446.5 - 2483.5 MHz band. Use outdoors on public property is not permitted.

In the departments listed below, for the entire 2.4 GHz band:

- Maximum authorized power indoors is 100 mW
- Maximum authorized power outdoors is 10 mW

Departments in which the use of the 2400 - 2483.5 MHz band is permitted with an EIRP of less than 100 mW indoors and less than 10 mW outdoors:

| | | | |
|-------------------|-------------------|------------------------|--------------------------|
| 01 Ain Orientales | 25 Doubs | 59 Nord | 71 Saone et Loire |
| 02 Aisne | 26 Drome | 60 Oise | 75 Paris |
| 03 Allier | 32 Gers | 61 Orne | 82 Tarn et Garonne |
| 05 Hautes Alpes | 36 Indre | 63 Puy Du Dome | 84 Vaucluse |
| 08 Ardennes | 37 Indre et Loire | 64 Pyrenees Atlantique | 88 Vosges |
| 09 Ariege | 41 Loir et Cher | 66 Pyrenees | 89 Yonne |
| 11 Aude | 45 Loret | 67 Bas Rhin | 90 Territoire de Belfort |
| 12 Aveyron | 50 Manche | 68 Haut Rhin | 94 Val de Marne |
| 16 Charente | 55 Meuse | 70 Haute Saone | |
| 24 Dordogne | 58 Nievre | | |

This requirement is likely to change over time, allowing you to use your wireless LAN card in more areas within France.

Please check with ART for the latest information (www.art-telecom.fr).

Note: *Your WLAN Card transmits less than 100 mW, but more than 10 mW.*

List of national codes

This equipment may be operated in the following countries:

| Country | ISO 3166 2 letter code | Country | ISO 3166 2 letter code |
|----------------|---------------------------|----------------|---------------------------|
| Austria | AT | Malta | MT |
| Belgium | BE | Netherlands | NT |
| Cyprus | CY | Poland | PL |
| Czech Republic | CZ | Portugal | PT |
| Denmark | DK | Slovakia | SK |
| Estonia | EE | Slovenia | SL |
| Finland | FI | Spain | ES |
| France | FR | Sweden | SE |
| Germany | DE | United Kingdom | GB |
| Greece | GR | Iceland | IS |
| Hungary | HU | Liechtenstein | LI |
| Ireland | IE | Norway | NO |
| Italy | IT | Switzerland | CH |
| Latvia | LV | Bulgaria | BG |
| Lithuania | LT | Romania | RO |
| Luxembourg | LU | Turkey | TR |

CANADA — LOW-POWER LICENSE-EXEMPT RADIO COMMUNICATION DEVICES (RSS-210)

Exposure of humans to RF fields (RSS-102)

The computer employs low gain integral antennas that do not emit RF field in excess of Health Canada limits for the general population; consult Safety Code 6, obtainable from Health Canada's website at www.hc-sc.gc.ca/rpb.

This device complies with RSS210 of Industry Canada.

This Class B digital apparatus complies with Canadian ICES-003, Issue 4, and RSS-210, No 4 (Dec 2000) and No 5 (Nov 2001).

"To prevent radio interference to the licensed service, this device is intended to be operated indoors and away from windows to provide maximum shielding. Equipment (or its transmit antenna) that is installed outdoors is subject to licensing."

Cet appareil numérique de la classe B est conforme à la norme NMB-003, No. 4, et CNR-210, No 4 (Dec 2000) et No 5 (Nov 2001).

« Pour empêcher que cet appareil cause du brouillage au service faisant l'objet d'une licence, il doit être utilisé à l'intérieur et devrait être placé loin des fenêtres afin de fournir un écran de blindage maximal. Si le matériel (ou son antenne d'émission) est installé à l'extérieur, il doit faire l'objet d'une licence.

Caution: When using IEEE 802.11a wireless LAN, this product is restricted to indoor use due to its operation in the 5.15- to 5.25-GHz frequency range. Industry Canada requires this product to be used indoors for the frequency range of 5.15 GHz to 5.25 GHz to reduce the potential for harmful interference to co-channel mobile satellite systems. High power radar is allocated as the primary user of the 5.25 to 5.35 GHz and 5.65 to 5.85-GHz bands. These radar stations can cause interference with and/or damage to this device.

The maximum allowed antenna gain for use with this device is 6 dBi in order to comply with the E.I.R.P limit for the 5.25- to 5.35 and 5.725 to 5.85 GHz frequency range in point-to-point operation.

The FCC RF safety requirement

The radiated output power of the wireless LAN Mini PCI Card and Bluetooth card is far below the FCC radio frequency exposure limits. Nevertheless, the computer shall be used in such a manner that the potential for human contact during normal operation is minimized as follows:

1. Users are requested to follow the RF safety instructions on wireless option devices that are included in the user's manual of each RF option device.

Caution: *To comply with FCC RF exposure compliance requirements, a separation distance of at least 20 cm (8 inches) must be maintained between the antenna for the integrated wireless LAN Mini PCI Card built in to the screen section and all persons.*

Note: The wireless Mini PCI adapter implements a transmission diversity function. The function does not emit radio frequencies simultaneously from both antennas. One of the antennas is selected automatically or manually (by users) to ensure good quality radiocommunication.

1. This device is restricted to indoor use due to its operation in the 5.15 to 5.25 GHz frequency range. FCC requires this product to be used indoors for the frequency range 5.15 to 5.25 GHz to reduce the potential for harmful interference to co-channel Mobile Satellite systems.
2. High power radar is allocated as the primary user of the 5.25 to 5.35 GHz and 5.65 to 5.85 GHz bands. These radar stations can cause interference with and/or damage this device.

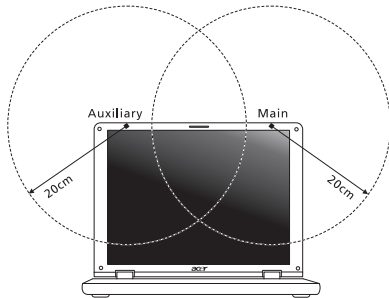

3. An improper installation or unauthorized use may cause harmful interference to radio communications. Also any tampering of the internal antenna will void the FCC certification and your warranty.

CANADA — LOW-POWER LICENSE-EXEMPT RADIO COMMUNICATION DEVICES (RSS-210)

Exposure of humans to RF fields (RSS-102)

The computer employs low gain integral antennas that do not emit RF field in excess of Health Canada limits for the general population; consult Safety Code 6, obtainable from Health Canada's website at www.hc-sc.gc.ca/rpb.

This device complies with RSS210 of Industry Canada.

This Class B digital apparatus complies with Canadian ICES-003, Issue 4, and RSS-210, No 4 (Dec 2000) and No 5 (Nov 2001).

"To prevent radio interference to the licensed service, this device is intended to be operated indoors and away from windows to provide maximum shielding. Equipment (or its transmit antenna) that is installed outdoors is subject to licensing."

Cet appareil numérique de la classe B est conforme à la norme NMB-003, No. 4, et CNR-210, No 4 (Dec 2000) et No 5 (Nov 2001).

« Pour empêcher que cet appareil cause du brouillage au service faisant l'objet d'une licence, il doit être utilisé à l'intérieur et devrait être placé loin des fenêtres afin de fournir un écran de blindage maximal. Si le matériel (ou son antenne d'émission) est installé à l'extérieur, il doit faire l'objet d'une licence.

Caution: When using IEEE 802.11a wireless LAN, this product is restricted to indoor use due to its operation in the 5.15- to 5.25-GHz frequency range. Industry Canada requires this product to be used indoors for the frequency range of 5.15 GHz to 5.25 GHz to reduce the potential for harmful interference to co-channel mobile satellite systems. High power radar is allocated as the primary user of the 5.25 to 5.35 GHz and 5.65 to 5.85-GHz bands. These radar stations can cause interference with and/or damage to this device.

The maximum allowed antenna gain for use with this device is 6 dBi in order to comply with the E.I.R.P limit for the 5.25- to 5.35 and 5.725 to 5.85 GHz frequency range in point-to-point operation.

Free Manuals Download Website

<http://myh66.com>

<http://usermanuals.us>

<http://www.somanuals.com>

<http://www.4manuals.cc>

<http://www.manual-lib.com>

<http://www.404manual.com>

<http://www.luxmanual.com>

<http://aubethermostatmanual.com>

Golf course search by state

<http://golfingnear.com>

Email search by domain

<http://emailbydomain.com>

Auto manuals search

<http://auto.somanuals.com>

TV manuals search

<http://tv.somanuals.com>