

AT1930/AT1931	<b>Important safety instructions</b>	<b>3</b>
	Disposal instructions	4
AT2230/AT2231	EC-Declaration of Conformity	5
User Guide	<b>First things first</b>	<b>6</b>
	Packing checklist	6
	<b>Your LCD TV overview</b>	<b>7</b>
	Front panel view	7
	Rear panel view	8
	<b>Remote control</b>	<b>9</b>
	General keys	9
	Teletext	10
	<b>Basic connections</b>	<b>11</b>
	Connecting the power cord	11
	Setting up the remote control	11
	<b>Enjoying your TV</b>	<b>11</b>
	Connecting an antenna/cable	11
	Getting started watching your TV	12
	<b>Connecting external audio/video devices</b>	<b>14</b>
	Connecting a DVD, VCR, STB or audio/video equipment	14
	Connecting a camera, camcorder or video game	15
	Connecting a PC or notebook computer	16
	Selecting the input source	16
	<b>OSD navigation</b>	<b>17</b>
	Navigating the OSD with the remote control	17
	Adjusting the OSD settings	18
	Setting scenario mode in TV	19
	<b>Advanced features</b>	<b>20</b>
	Advanced setting	20
	Steady sound	22
	Channel setting	23
	Locking TV content	26
	Channel/program list	28
	Audio effects	29
	Widescreen display mode	29
	<b>Troubleshooting</b>	<b>31</b>
	<b>PC input signal reference chart</b>	<b>32</b>
	<b>Product specifications</b>	<b>34</b>

Copyright © 2008. Acer Incorporated.  
All Rights Reserved.

Acer LCD TV User Guide  
Original Issue: 06/2008

Changes may be made periodically to the information in this publication without obligation to notify any person of such revisions or changes. Such changes will be incorporated in new editions of this manual or supplementary documents and publications. This company makes no representations or warranties, either expressed or implied, with respect to the contents hereof and specifically disclaims the implied warranties of merchantability or fitness for a particular purpose.

Record the model number, serial number, purchase date, and place of purchase information in the space provided below. The serial number and model number are indicated on the label affixed to your device. All correspondence concerning your unit should include the serial number, model number, and purchase information.

No part of this publication may be reproduced, stored in a retrieval system, or transmitted, in any form or by any means, electronically, mechanically, by photocopy, recording, or otherwise, without the prior written permission of Acer Incorporated.

Model Number: \_\_\_\_\_

Serial Number: \_\_\_\_\_

Purchase Date: \_\_\_\_\_

Place of Purchase: \_\_\_\_\_

Acer and the Acer Logo are registered trademarks of Acer Inc. Other companies' product names or trademarks are used herein for identification purposes only and belong to their respective companies.

# Important safety instructions

Read these instructions carefully. Please put them somewhere safe for future reference.

1. Only use attachments/accessories specified by the manufacturer.
2. Use only with the cart, stand, tripod, bracket, or table specified by the manufacturer, or sold with the apparatus. When a cart is used, use caution when moving the cart/ apparatus combination to avoid injury from tip-over.
3. Unplug this apparatus during lightning storms or when unused for long periods of time.
4. Do not install this equipment in a confined space such a book case or similar unit.
5. No naked flame sources, such as lighted candles, should be placed on the apparatus.
6. If the remote control will not to be used for a long time, remove the batteries. Use the remote control carefully. Do not drop the remote control on the floor. Keep it away from moisture, direct sunlight, and high temperatures.
7. Used or discharged batteries must be properly disposed of or recycled in compliance with all applicable laws. For detailed information, contact your local solid waste disposal authority.
8. Follow all warnings and instructions marked on the product.
9. Unplug this product from the wall outlet before cleaning. Do not use liquid cleaners or aerosol cleaners. Use a damp cloth for cleaning.
10. Do not use this product near water.
11. Do not place this product on an unstable cart, stand or table. The product may fall, sustaining serious damage.
12. Slots and openings are provided for ventilation; to ensure reliable operation of the product and to protect it from overheating, these openings must not be blocked or covered. The openings should never be blocked by placing the product on a bed, sofa, rug or other similar surface. This product should never be placed near or over a radiator or heat register or in a built-in installation unless proper ventilation is provided.
13. This product should be operated from the type of power indicated on the marking label. If you are not sure of the type of power available, consult your dealer or local power company.
14. Do not allow anything to rest on the power cord. Do not locate this product where the cord will be stepped on.
15. If an extension cord is used with this product, make sure that the total ampere rating of the equipment plugged into the extension cord does not exceed the extension cord ampere rating. Also, make sure that the total rating of all products plugged into the wall outlet does not exceed the fuse rating.
16. Never push objects of any kind into this product through cabinet slots as they may touch dangerous voltage points or short-out parts, which could result in a fire or electric shock. Never spill liquid of any kind on the product.
17. Do not attempt to service this product yourself, as opening or removing covers may expose you to dangerous voltage points or other risks. Refer all servicing to qualified service personnel.
18. Unplug this product from the wall outlet and refer servicing to qualified service personnel under the following conditions:



- a. When the power cord or plug is damaged or frayed.
  - b. If liquid has been spilled into the product.
  - c. If the product has been exposed to rain or water.
  - d. If the product does not operate normally when the operating instructions are followed. Adjust only those controls that are covered by the operating instructions. Improper adjustment of other controls could result in damage; extensive work by a qualified technician might then be required to restore the product to normal condition.
  - e. If the product has been dropped or the case has been damaged.
  - f. If the product exhibits a distinct change in performance, indicating a need for service.
- 19 Use only the proper type of power supply cord set (provided in your accessories box) for this unit. Always disconnect the power cord from the wall outlet before servicing or disassembling this equipment.
  - 20 Do not overload an electrical AC outlet, power strip, or convenience receptacle. The overall system load must not exceed 80% of the branch circuit rating. If power strips are used, the load should not exceed 80% of the power strip input rating.
  - 21 Some products are equipped with a three-wire electrical grounding-type plug that has a third pin for grounding. This plug only fits into a grounded electrical outlet. This is a safety feature. Make sure the AC outlet is properly grounded. Do not defeat the safety purpose of the grounding-type plug by trying to insert it into a non-grounded outlet. If you cannot insert the plug into the outlet, contact your electrician to replace the obsolete outlet.
  - 22 Do not use this LCD TV in the workplace according to BildscharbV, and maintain ample distance from it when watching. Watching a big-screen TV too close can cause eyestrain.
  - 23 HDMI is for video only: supports connections between HDMI-connection-enabled AV devices (set top boxes, DVD players, AV receivers and digital TVs).



-----

The grounding pin is an important safety feature. It is possible to receive an electric shock from a system that is not properly grounded.



-----

The grounding pin is also providing good immunity ability against unexpected noise that interferes performance of this product and is produced by other nearby electrical devices.

## Disposal instructions

Do not throw this electronic device into the rubbish bin / container when discarding. To minimize pollution and ensure utmost protection of the global environment, please recycle.

For more information regarding WEEE, please refer to  
<http://global.acer.com/about/environmental.htm>



Соответствует сертификатам, обязательным в РФ  
 (Compliant with Russian regulatory certification)



ME61

# EC-Declaration of Conformity

**We,  
ACER**

Mr. Easy Lai  
Tel: +886-2-8691-3089 Fax: +886-2-8691-3120  
E-mail: easy\_lai@acer.com.tw

Hereby declare that:

**Product:** LCD Monitor TV  
**Trade Name:** Acer  
**Model Number:** AT1930; AT1931; AT2230; AT2231

Is compliant with the essential requirements and other relevant provisions of the following EC directives, and that all the necessary steps have been taken and are in force to assure that production units of the same product will continue comply with the requirements.

**EMC Directive 2004/108/EC as attested by conformity with the following harmonized standards:**

- EN55022:1998 + A1:2000 + A2:2003, AS/NZS CISPR22:2002, Class B
- EN55013:2001 + A1:2003 + A2:2006
- EN55020:2007
- EN61000-3-2:2006
- EN61000-3-3:1995 + A1:2001 + A2:2005

**Low Voltage Directive 2006/95/EC as attested by conformity with the following harmonized standard:**

- EN60065:2002

**RoHS Directive 2002/95/EC on the Restriction of the Use of certain Hazardous Substances in Electrical and Electronic Equipment.**

*Easy Lai*

Easy Lai / Director

Acer Computer (Shanghai) Limited

20th April 2008

Date

# First things first

We would like to thank you for making this Acer LCD TV your choice. With proper care, your new Acer LCD TV will provide you with years of entertainment and satisfaction.

This User's Guide introduces you to the various features your LCD TV can offer, and provides clear and concise information about the product, so please read it thoroughly and retain it for future reference.

## Packing checklist

Your LCD TV package should contain the following accessories, in addition to the accessory box. Please ensure that they are all present. If any of the items is missing, then please contact your retailer.

- Remote control (x1) / AAA batteries (x2)
- Power cord (x1)
- User's Guide / Quick Guide
- Warranty card







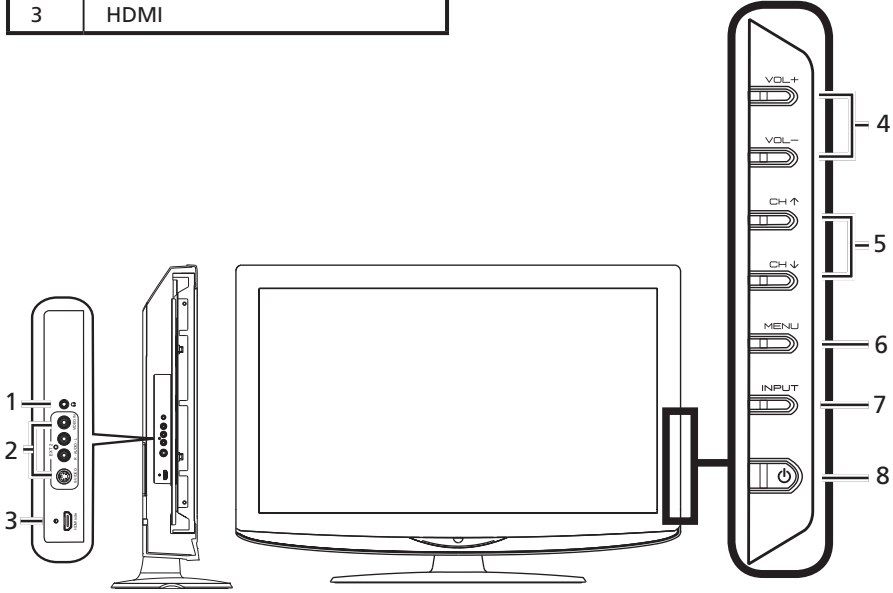

-----  
\* The power cord supplied varies according to your region.

# Your LCD TV overview

Front panel view	
1	Earphone
2	AV in-S-video, CVBS, Audio L/R
3	HDMI



4		Volume up	When the OSD is on, functions the same as the Right arrow.
		Volume down	When the OSD is on, functions the same as the Left arrow.
5		Channel up	When the OSD is on, functions the same as the Up arrow.
		Channel down	When the OSD is on, functions the same as the Down arrow.
6		Menu key	Turns the OSD menu ON and OFF.
7		Input key	Press to change input source. When the OSD is on, press this button to confirm selection.
8		Power On/Off	Turns the power ON and OFF.

## Rear panel view

1	AC-in	2	VGA-in + PC Audio-in
3	HDMI	4	AV in-COMPONENT + Audio L/R
5	SCART	6	Analog Tuner

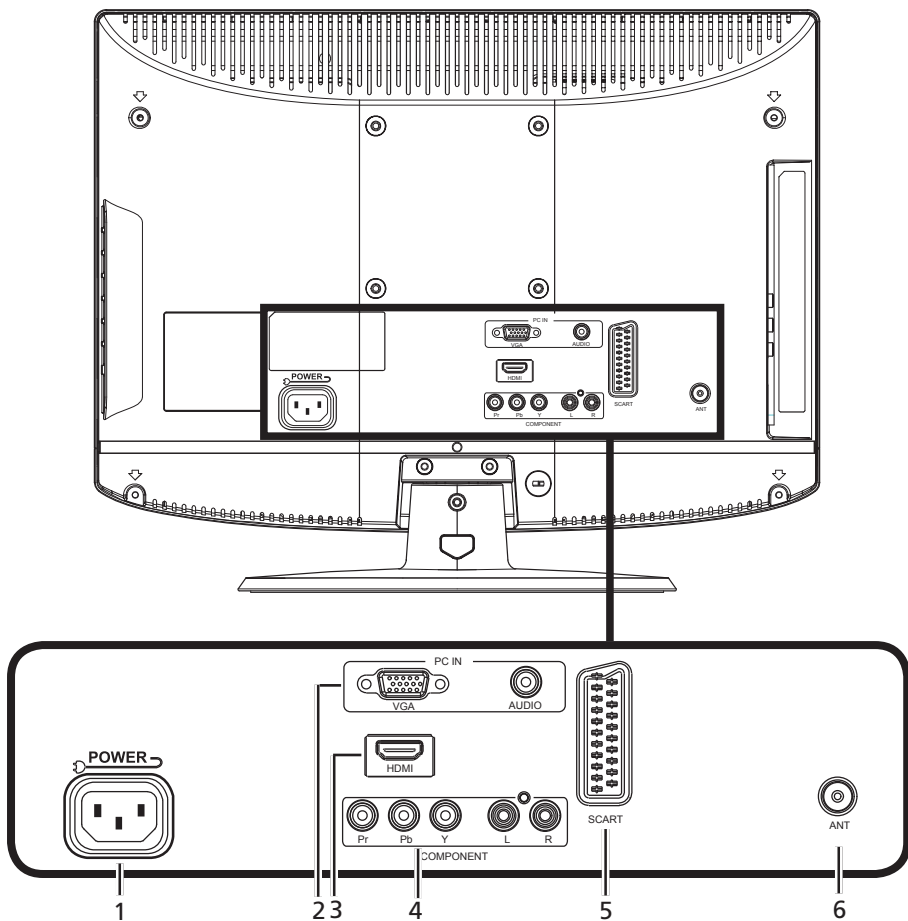



# Remote control

## General keys

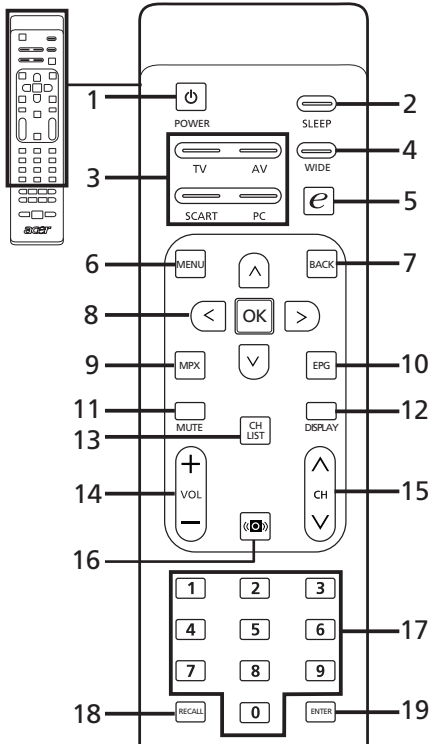

### 1 POWER

Press to turn your TV on/off.

### 2 SLEEP

Press to set a time period after which the TV will switch itself to standby (5, 10, 15, 20, 25 ... 180 minutes).

### 3 Input buttons (TV/AV/SCART/PC)

Press to select correct input mode.

### 4 WIDE

Press to toggle scaling mode between Super zoom, 4:3, 14:9, 16:10, 16:10 subtitle, Full screen and Wide detect modes.

### 5 e (Empowering Technology)

Press to activate and select the scenario mode. See page 19.

### 6 MENU

Press to open or close the Menu.

### 7 Back

Press to back to previous Menu.

### 8 Directional keys/OK

### 9 MPX

Press to select the audio type, displayed in the top right-hand corner (mono, stereo, bilingual).

### 10 EPG (No function for these models)

### 11 MUTE

Press to toggle audio on and off.

### 12 DISPLAY

Press to display or change input/channel information (dependent on input/source type).

### 13 CH LIST

Press to launch the channel/program list. See page 40.

### 14 VOL (+/-)

Press to increase or decrease the volume.

### 15 CH (up/down)

Press to sequentially select the TV channel.

### 16 Audio effects

Press to turn audio mode to Surround mode.

### 17 Number keys.

### 18 RECALL

Press to return to the previous channel.

### 19 ENTER (No function for these models)

# Teletext

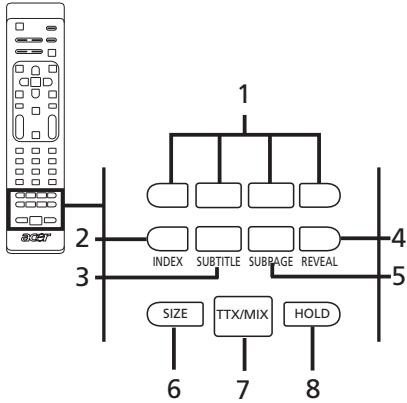

- 1 Colour buttons (R/G/Y/B)**  
Operates corresponding button on the teletext page.
- 2 INDEX**  
Press to go to the index page.
- 3 SUBTITLE**  
Press to view subtitles on the screen.
- 4 REVEAL**  
Press to reveal hidden teletext information.
- 5 SUBPAGE**  
Press to access the teletext's subpages directly.
- 6 SIZE**  
Press once to zoom teletext page to 2X. Press again to resume.  
You can also use navigation key (up and down) to zoom-in or zoom-out the teletext page.
- 7 TTX/MIX (TELETEXT/MIX)**  
Press to switch from TV/AV to Teletext mode.  
Press to overlay teletext page on the TV image.
- 8 HOLD**  
Press to pause the current teletext page in multi-page viewing mode.

## Basic connections

### Connecting the power cord

- 1 Connect the AC cord into the AC input on the back of the set.
- 2 Connect the plug to the wall outlet as shown.

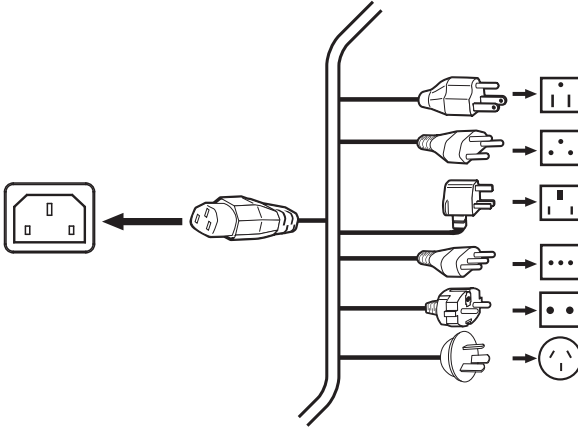

### Setting up the remote control

- 1 Open the cover on the back of the remote unit.
- 2 Insert two AAA batteries (supplied) to match the polarity indicated inside the battery compartment.

## Enjoying your TV

### Connecting an antenna/cable

Connect the antenna cable to the appropriate antenna terminal on the back of the TV set as shown below.

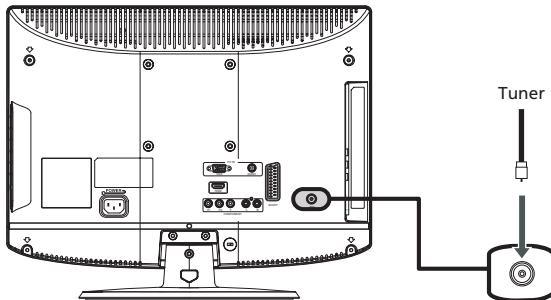

# Getting started watching your TV

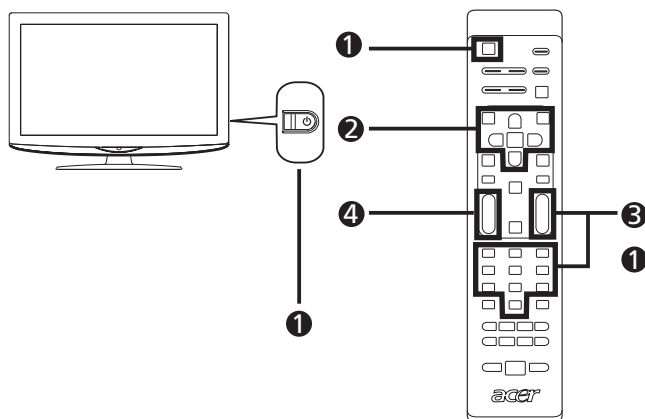

## 1 Power

- Turn on the power switch beneath the screen.
- Press the power button or channel up/down button on the remote control.

## 2 Setup Wizard

The first time you switch on the TV, the Setup Wizard will guide you to complete the language selection and channel scanning.

Press the OK key to begin the setup process.



-----  
You can also adjust these settings using the front control panel. Please see "Front panel view" on page 7 for details.

Step 1. Select the setup language you prefer.

Step 2. Please select country.

Step 3. Ensure that your co-axial cables are connected correctly before proceeding.

Step 4. Scan for analog channels.

Step 5. Setup is now complete. You are ready to begin watching TV.



-----  
If you leave the setup process before it is complete, you will be given a choice of options:

- Press the **MENU** key on the remote control to bring up the OSD.
- Use the **directional keys** to navigate and select **Install**.
- Highlight **Auto Scan**. Then, select **Start?** and press **OK** to begin.
- Press **MENU** to exit.

### ③ Changing channels

- a. Press 0 - 9 on the remote control to select a channel. The channel changes after 2 seconds.
- b. Pressing the channel ( CH ) up / down button on the remote control will also change the channel.

### ④ Adjusting the volume

Adjust the volume level using the ( VOL ) up/down button on the remote control.



-----  
Setup may vary due to local broadcast differences.



# Connecting external audio/video devices

## Connecting a DVD, VCR, STB or audio/video equipment

Connect your DVD player, VCR or audio/video equipment using the SCART port located at the rear of your LCD TV as shown below.

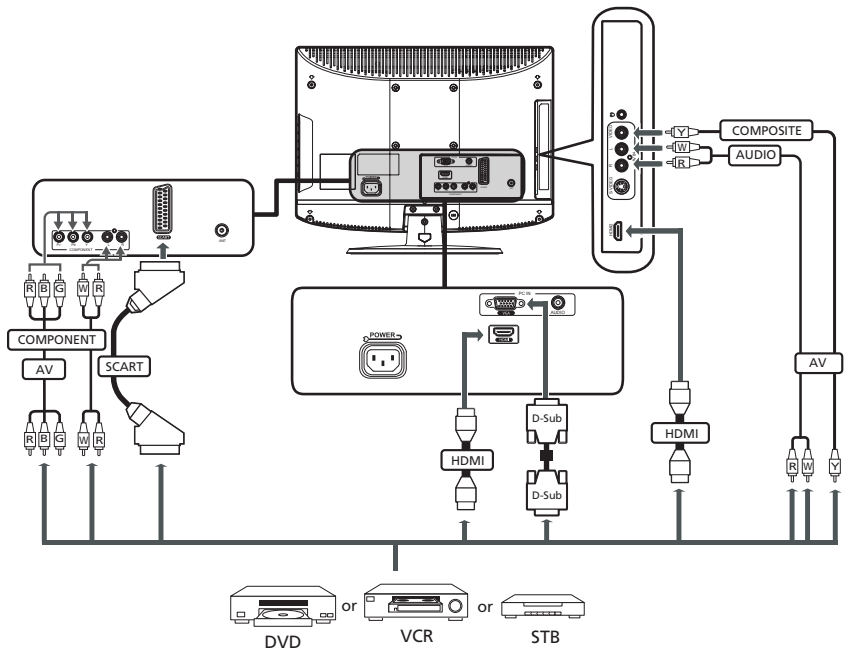
### Source-in



-  Yellow
-  Red
-  White
-  Blue
-  Green



\* Acer recommends the following priority for connection types:  
HDMI -> COMPONENT -> SCART -> S-Video -> Composite.

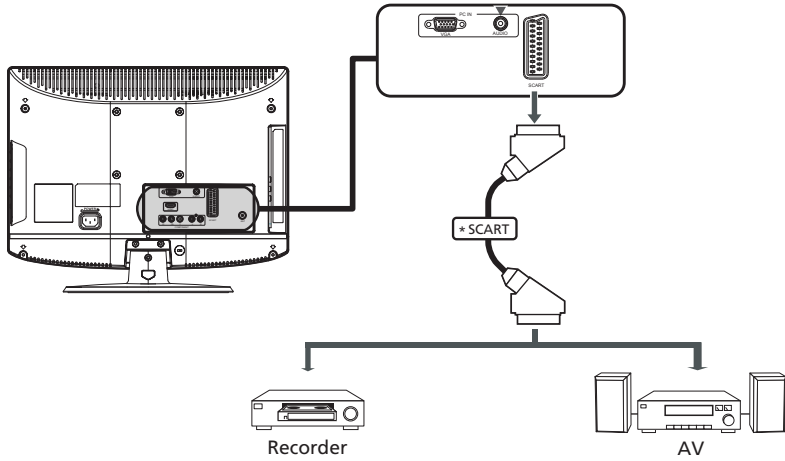

## Connecting a camera, camcorder or video game

Connect your camera or camcorder to the video/audio ports on the left of the TV set as shown below.

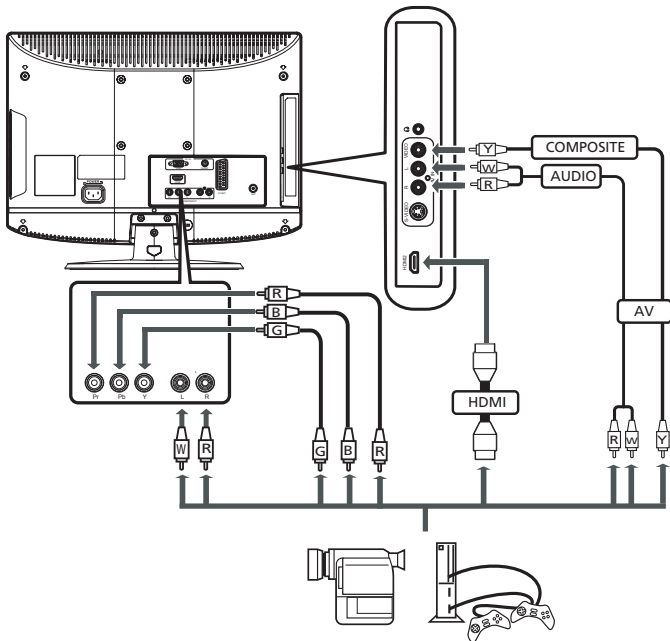

## Connecting a PC or notebook computer

To display PC output on your TV, connect your PC or notebook computer to the TV as shown below.

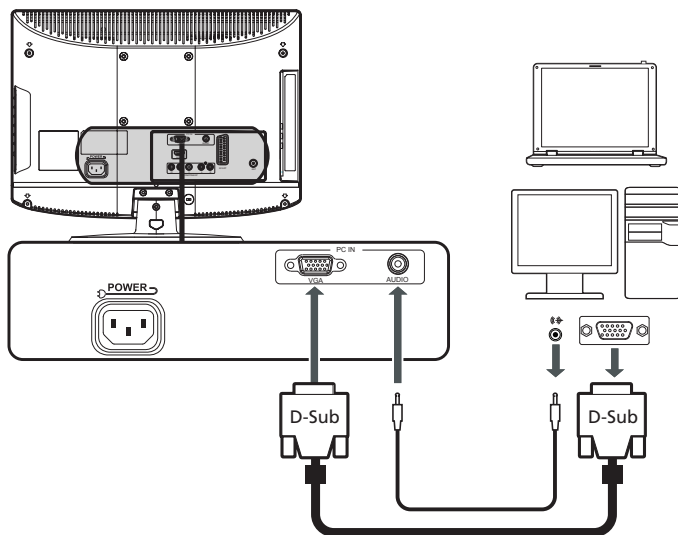

For VGA connections, Acer recommends setting your PC's external monitor resolution to 1440 x 900 (AT1930/AT1931) or 1680 x 1050 (AT2230/AT2231) pixels @ 60 Hz refresh rate.

## Selecting the input source

Once you have connected your antenna or external equipment to the TV, you need to select the correct input source.

Press the corresponding button on the remote control to select the correct input source.

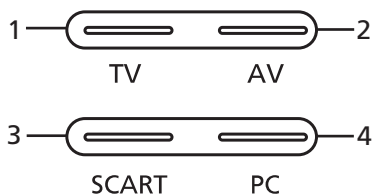

### Input button guide:

- 1 **TV key**  
Toggle TV between input sources.
- 2 **AV key**  
Toggle Composite, S-video, Component, HDMI1 and HDMI2 between input sources.
- 3 **SCART key**  
Toggle SCART between input sources.
- 4 **PC key**  
Toggle VGA between input sources.



# OSD navigation

Many of the advanced settings and adjustments are available through using the OSD (onscreen display) menus, as shown in the example screenshot below.

Basic operations required to navigate these menus (Picture, Sound, Setting and Install) are described in this section.

## Navigating the OSD with the remote control

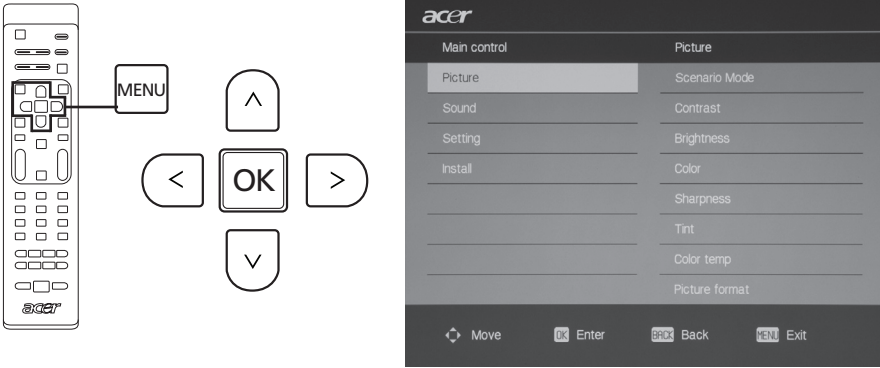

You can also interact with these menus using the right panel controls. Please see "Front panel view" on page 7 for details.

There are four main OSD menus. These are: Picture, Sound, Setting and Install. Use the following method to navigate these menus.		
1		Press the <b>MENU</b> button on the remote control or the <b>MENU</b> button on the control panel.
2		Select your desired menu by using the up and down <b>directional keys</b> to switch between the five menus.
3		Use the <b>directional keys</b> to interact with the menu. The up / down directions will scroll through the menu options, while left/right will adjust the different settings (for example, in the Picture menu, settings such as brightness, contrast, etc.). Press <b>MENU</b> to exit.

# Adjusting the OSD settings

The OSD can be used for adjusting the settings of your LCD TV.

Press the **MENU** key to open the OSD. You can use the OSD to adjust the picture quality, audio settings, channel settings and general settings. For advanced settings, please refer to following page:

## Adjusting the picture quality

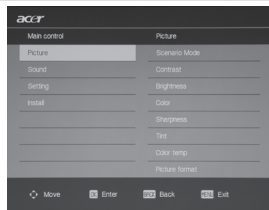

- 1 Press the **MENU** key to bring up the OSD.
- 2 Using the directional keys, select **Picture** from the OSD. Then navigate to the picture element you wish to adjust.
- 3 Use the up or down keys to adjust the sliding scales.
- 4 The **Picture** menu can be used to adjust the current **Picture mode, Brightness, Contrast, Colour, Sharpness** and other image-related qualities.

## Adjusting the audio settings



- 1 Press the **MENU** key to bring up the OSD.
- 2 Using the directional keys, select **Sound** from the onscreen display. Then navigate to the feature you wish to adjust.
- 3 Use the up or down keys to adjust the sliding scale. Press **OK** to save.
- 4 The **Sound** menu can also be used to adjust the the current **Sound Mode, Treble, Bass, Balance, Steady Sound, Sound Effect** and other important sound-related settings.

## Adjusting the settings

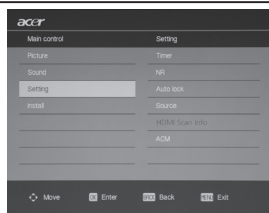

- 1 Press the **MENU** key to bring up the OSD.
- 2 Using the directional keys, select **Setting** from the OSD. Then navigate to the feature you wish to adjust.
- 3 The **Setting** menu can be used to adjust the **Timer, NR, Auto lock, ACM** and other important settings.

## Adjusting the Installation settings



- 1 Press the **MENU** key to bring up the OSD.
- 2 Using the directional keys, select **Install** from the OSD.
- 3 Use the directional keys to navigate the menus.
- 4 The **Install** menu can be used to adjust **Menu Language, Country, Auto Scan, Manual Scan, Channel setting** and other important Installation-related settings.



The options available on the OSD may vary depending on the TV signal source and model.

## Setting scenario mode in TV

Scenario mode has six preset viewing modes designed to give you the best picture quality when watching a particular kind of programme. There are six pre-defined audio and video settings for optimal enjoyment of the following scenarios: Standard, Movie, Sport, Concert, Game, User.

	Pressing the <b>Empowering Key</b> will toggle between the different modes.
--	---



Mode	Information
Standard	Standard mode allows you to watch your favourite channels with sharp, brilliant imagery via adaptive brightness and contrast adjustments, and listen to clear-sounding audio.
Movie	For comfortably enjoying movies at home, Movie mode displays dim scenes in clear detail; compensates for colour; and smoothly presents motion images. This is accomplished through optimal Gamma correction plus saturation, brightness and contrast adjustments. Movie mode makes the most of high-definition movie soundtracks.
Sport	Sport mode is suited for outdoor sports programmes, with accurate background depth and clear gradation between the bright, outdoor playing field and darker auditoriums. Sports mode also brilliantly enhances colours and presents swiftly moving pictures without residual images. All of this is achieved via specific Gamma corrections and saturation adjustments. Precise audio can be heard.
Concert	Concert mode places you in a virtual concert hall, opera house or other dim environment by means of adaptive brightness and contrast adjustments. Concert mode accentuates symphonic harmonies and the tenor audio range.
Game	Game mode carefully details the exquisite graphics of modern video games, providing lifelike entertainment while protecting your eyesight by adjusting brightness and contrast. What's more, Game mode provides a heightened audio experience.
User	User mode allows you to save your favourite video and audio settings.

# Advanced features

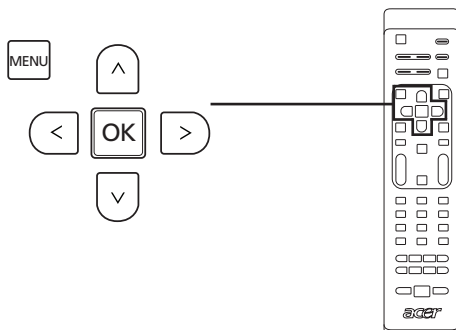
## Advanced setting

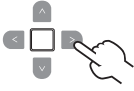

Advanced setting		
1		Press the <b>Menu</b> key from the remote control hand set, to invoke the OSD (On Screen Display).
2		<p>Using the <b>directional keys</b> to navigate, select <b>Setting</b> from the OSD.</p>
3		<p>Using the <b>directional keys</b>, to navigate through 'NR' or 'ACM'.</p>

4		<ul style="list-style-type: none"><li>* <b>NR (Noise Reduction):</b> This function filters noise from a signal. You can set to 'on' or 'off' depending on your preference.</li><li>* <b>ACM (Adaptive Contrast Management):</b> This function automatically adjusts picture contrast, depending on the brightness of the video content. You can turn this feature either to 'on' or 'off'.</li></ul>
5		Press <b>MENU</b> to exit.

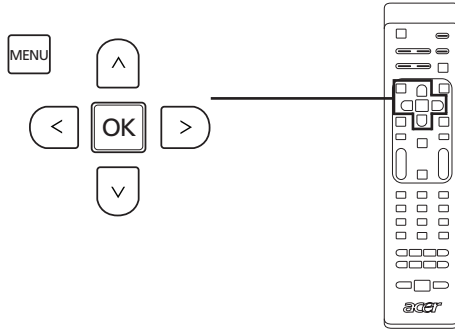

# Steady sound

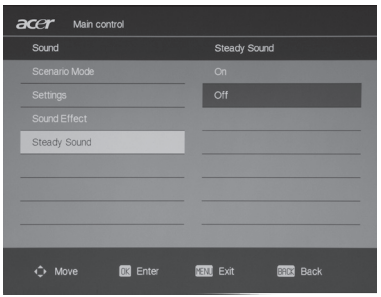

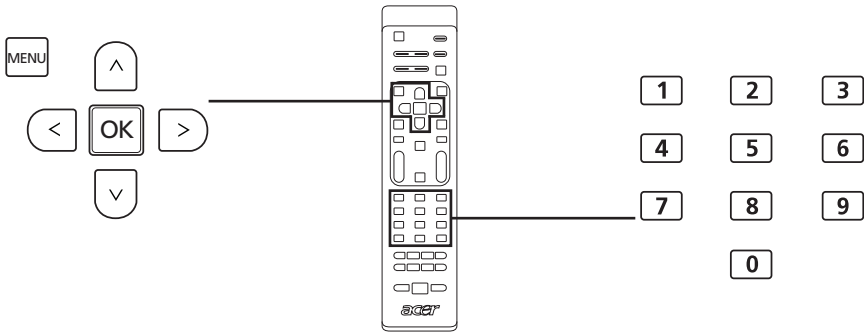

Steady sound		
1		Press the <b>Menu</b> key from the remote control hand set, to invoke the OSD (On Screen Display).
2		 <p>Using the <b>directional keys</b>, navigate to and select <b>Sound</b> from the OSD. Navigate to '<b>Steady sound</b>' to adjust settings.</p>
3		This function prevents sudden changes in the audio output level. If this function is selected as ' <b>On</b> ,' volume levels will be consistent when switching between input sources and changing channels.
4		Press <b>MENU</b> to exit.

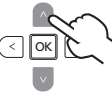
# Channel setting

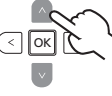
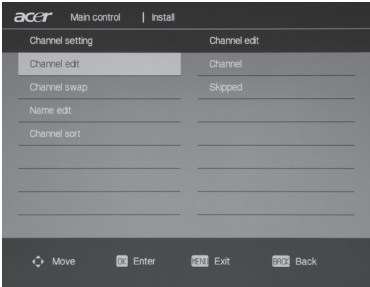

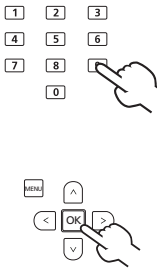
Channel setting		
1		<p>Press the <b>Menu</b> key from the remote control hand set, to invoke the OSD (On Screen Display).</p>
2		<div data-bbox="296 774 666 1061">  </div> <p>Using the <b>directional keys</b>, navigate to and select <b>Install</b>. From this submenu, select <b>Channel Setting</b> to adjust Channel settings.</p>
3		<div data-bbox="296 1077 666 1364">  </div> <p>Using the <b>directional keys</b>, to navigate through options 'Channel edit', 'Channel swap', 'Name edit' or 'Channel sort'.</p>



4		<ul style="list-style-type: none"> <li>* <b>Channel edit:</b> You can set the <b>Channel Index</b> or Skip this channel here. Use the <b>directional keys</b> to edit the channel index column.</li> <li>* <b>Channel swap:</b> You can set the channel index in 'From' and 'To' submenu, then select 'Exchange', these two channels will change order in the channel list.</li> <li>* <b>Name edit:</b> You can set the 'Channel' and 'Name' here. You can use the <b>directional keys</b> to enter a number or alphabetic character and press <b>OK</b> to confirm or <b>Menu</b> to cancel.</li> <li>* <b>Channel sort:</b> Please use the <b>directional keys</b> to select sorting channel here. These channels will automatically sorting by index order.</li> </ul>
5		Press <b>MENU</b> to exit.

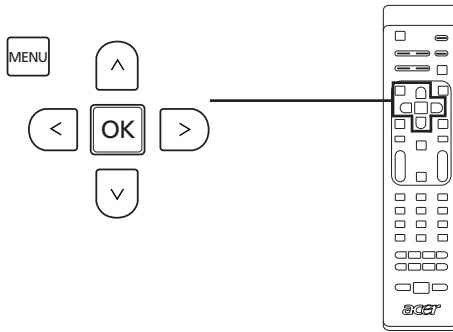

# Re-scan for channels

The first time you completed the setup wizard, all available channels were listed. If you need to re-scan for new channels, please follow the steps below:

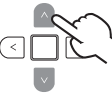

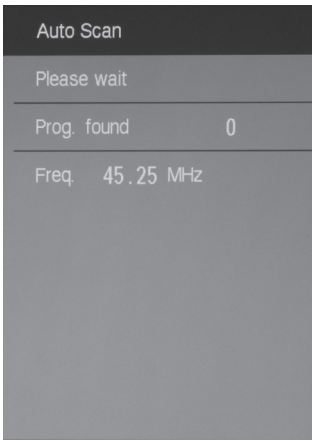
Scanning for channels		
1		Press the <b>MENU</b> key on the remote control to bring up the OSD.
2		Use the <b>directional keys</b> to navigate and select <b>Install</b> .
3		Highlight <b>Auto Scan</b> . Then, select <b>Start?</b> and press <b>OK</b> to begin.
4		

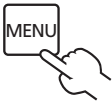

5		Press <b>MENU</b> to exit.
---	--	----------------------------

## Locking TV content

**Auto lock** is a handy feature that can block all TV sources.

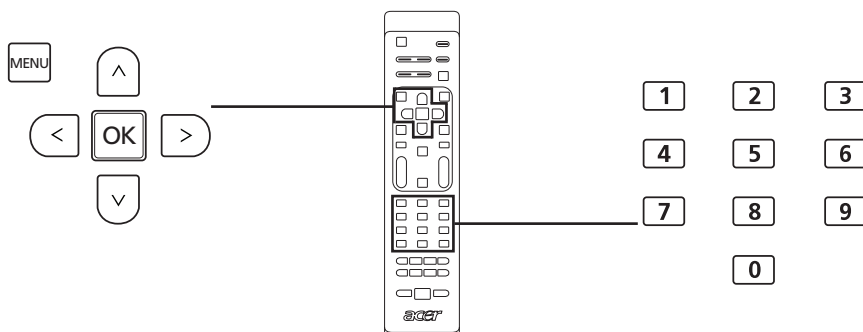
**Auto lock** allows you to enter a password and effectively stop anyone without the password from watching TV.

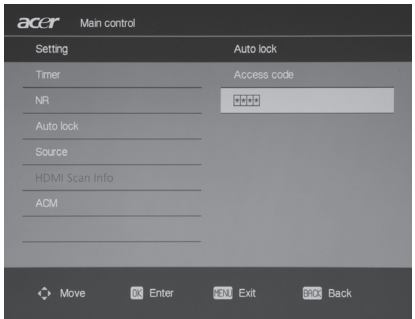
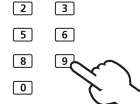

Setting a password		
1		Press the <b>MENU</b> key on the remote control to bring up the OSD.
2		 <p>Using the <b>directional keys</b>, navigate to and select <b>Setting</b> from the OSD. Navigate to the <b>Auto lock</b> menu. Then enter <b>Password</b>. (see page 27 note)</p>
3		Enter a four-digit password.

4		Press <b>MENU</b> to exit.
---	---	----------------------------

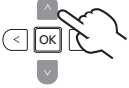
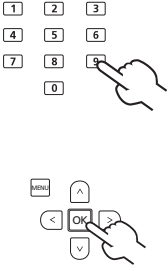
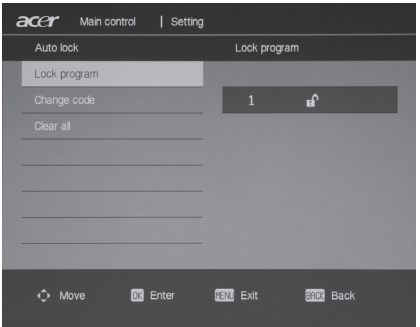
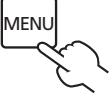
Locking your TV programs		
1		Press the <b>MENU</b> key on the remote control to bring up the OSD.
2		Using the <b>directional keys</b> , navigate to and select <b>Setting</b> from the OSD. Navigate to the Auto lock menu.
3		<div data-bbox="313 542 733 869" data-label="Image">  </div> <div data-bbox="739 630 957 790" data-label="Text"> <p>Enter your Password. Then, select <b>Lock program</b>, <b>Change code</b> or <b>Clear all</b> for further settings. (see page 27 note)</p> </div>
4		Press <b>MENU</b> to exit.



The default password for this TV is "0000." First enter "0000" when you want to change the password. If you forget your password, please enter 6163 to reset.

# Channel/program list

Channel/program list allows you to quickly find the TV channel/program you are searching for.

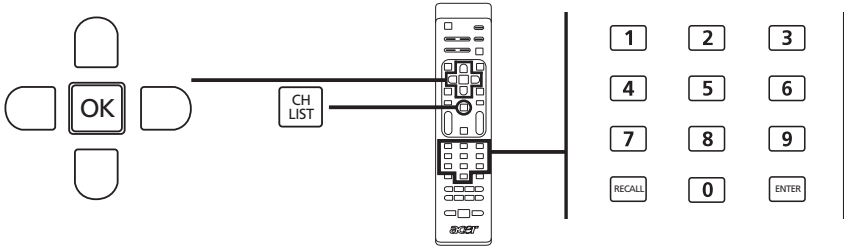

To open the channel list feature:		
1		Press the <b>CH LIST</b> key on the remote control. This will bring up the channel/program list menu.
2		The current channel/program will be highlighted.
3		Use the <b>directional keys</b> to navigate the list and select the channel/program you wish to watch.

## Audio effects

Your Acer LCD TV is equipped with high-quality sound specifications to ensure that you enjoy the best audio experience possible.

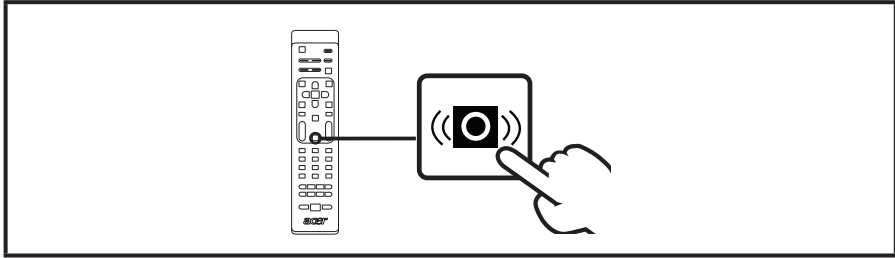

## Widescreen display mode

Your Acer LCD TV has a special widescreen mode that allows you to toggle between Super zoom, 4:3, 14:9, 16:10, 16:10 subtitle, Full screen and Wide detect type views.

Press the **WIDE** key on the remote control to toggle the display between the seven wide modes.

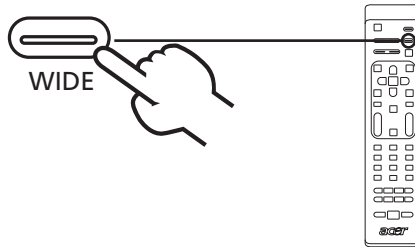

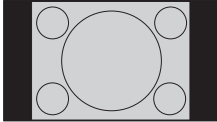
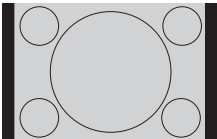
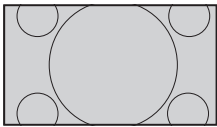
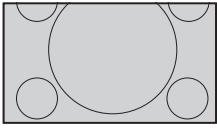
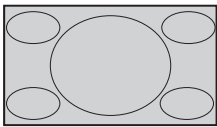
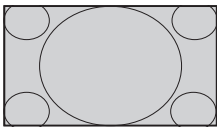
<b>Wide detect</b>	Automatically detects the picture source and selects the appropriate aspect ratio.
<b>4:3 (Not for HD)</b>	
	For 4:3 standard pictures. A side bar appears on each side.
<b>14:9 (Not for HD)</b>	
	Standard 4:3 images will be scaled to 14:9.
<b>16:10 (Not for HD)</b>	
	The 4:3 images will be scaled to 16:10 full-screen resolution.
<b>16:10 subtitle (Not for HD)</b>	
	The 4:3 image will be scaled to full-screen resolution with the vertical scaling adjusted to allow subtitles to be viewed.
<b>Full screen</b>	
	The picture will be stretched to use the full screen.
<b>Super zoom (Not for HD)</b>	
	The picture is scaled to use the full screen width. Upper and lower parts of the picture may be cut off.

# Troubleshooting

Before you call the Acer service center, please check the following items:

Here is a list of possible situations that may arise during the use of your LCD TV. Easy answers and solutions are provided for each.

## There is no picture or sound.

- Make sure the power cord is properly inserted in the power outlet.
- Make sure the input mode is correctly set by your selected input.
- Make sure the antenna at the rear of the TV is properly connected.
- Make sure the main power switch is turned on.
- Make sure the volume is not set to minimum or the sound is not set to mute.
- Make sure the headphones are not connected.
- Reception other than those of broadcasting stations can be considered.

## Picture is not clear.

- Make sure the antenna cable is properly connected.
- Consider whether your TV signal is being properly received.
- Poor picture quality can occur due to a VHS camera, camcorder, or other peripheral being connected at the same time. Switch off one of the other peripherals.
- The 'ghost' or double image may be caused by obstruction to the antenna due to high-rise buildings or hills. Using a highly directional antenna may improve the picture quality.
- The horizontal dotted lines shown on the pictures may be caused by electrical interference, e.g., hair dryer, nearby neon lights, etc. Turn off or remove these.

## Picture is too dark, too light or tinted.

- Check the colour adjustment.
- Check the brightness setting.
- Check the sharpness function.
- The fluorescent lamp may have reached the end of its service life.

## Remote control does not work.

- Check the batteries of the remote control.
- Make sure the remote sensor window is not under strong fluorescent lighting.
- Try to clean the remote control sensor lens on the TV with a soft cloth.
- Use the buttons (hotkeys) on the TV before the remote control works.

If the above suggestions do not solve your technical issue, please refer to the warranty card for service information.

# PC input signal reference chart

## AT2230/A2231:

	Resolution	Horizontal Frequency (kHz)	Vertical Frequency (Hz)	Standard
1	720 x 400	31.5	70.1	VGA
2	640 x 480	31.5	60.0	VGA
3	640 x 480	35.0	67.0	MAC
4	640 x 480	37.9	72.8	VESA
5	640 x 480	37.5	75.0	VESA
6	800 x 600	35.2	56.3	VESA
7	800 x 600	37.9	60.3	VESA
8	800 x 600	48.1	72.2	VESA
9	800 x 600	46.9	75.0	VESA
10	832 x 624	49.7	75.0	MAC
11	1024 x 768	48.4	60.0	VESA
12	1024 x 768	56.5	70.1	VESA
13	1024 x 768	60.0	75.0	VESA
14	1280 x 768		60.0	CVT 2.3MA
15	1280 x 768	60.3	75.0	CVT 2.3MA
16	1152 x 870	68.7	75.0	MAC
17	1152 x 864	63.9	70.0	VESA
18	1152 x 864	67.5	75.0	VESA
19	1280 x 960	60.0	60.0	VESA
20	1280 x 960	75.0	75.0	VESA
21	1280 x 1024	64.0	60.0	VESA
22	1280 x 1024	80.0	75.0	VESA
23	1440 x 900	55.9	59.9	VESA
24	1440 x 900	70.6	75.0	VESA
25	1680 x 1050	65.3	60.0	CVT 1.76MW



# AT1930/AT1931:

	Resolution	Horizontal Frequency (kHz)	Vertical Frequency (Hz)	Standard
1	720 x 400	31.5	70.1	VGA
2	640 x 480	31.5	60.0	VGA
3	640 x 480	35.0	67.0	MAC
4	640 x 480	37.9	72.8	VESA
5	640 x 480	37.5	75.0	VESA
6	800 x 600	35.2	56.3	VESA
7	800 x 600	37.9	60.3	VESA
8	800 x 600	48.1	72.2	VESA
9	800 x 600	46.9	75.0	VESA
10	832 x 624	49.7	75.0	MAC
11	1024 x 768	48.4	60.0	VESA
12	1024 x 768	56.5	70.1	VESA
13	1024 x 768	60.0	75.0	VESA
14	1280 x 768		60.0	CVT 2.3MA
15	1280 x 768	60.3	75.0	CVT 2.3MA
16	1152 x 870	68.7	75.0	MAC
17	1152 x 864	63.9	70.0	VESA
18	1152 x 864	67.5	75.0	VESA
19	1280 x 960	60.0	60.0	VESA
20	1280 x 960	75.0	75.0	VESA
21	1280 x 1024	64.0	60.0	VESA
22	1280 x 1024	80.0	75.0	VESA
23	1440 x 900	55.9	59.9	VESA
24	1440 x 900	70.6	75.0	VESA



-----

- 1). The PC input does not support Sync on Green or Composite Sync.
- 2). The PC input does not support interlaced signals.

# Product specifications

Model	AT1930/AT1931	AT2230/AT2231
<b>Panel spec</b>		
Resolution (pixels)	1440 x 900	1680 x 1050
Brightness (tpe.)	300 nit	
Contrast Ratio (tpe.)	1000 : 1	
Dynamic Contrast Ratio (max.)	10000 : 1	15000 : 1
Display colour	16.7 M	
Viewing angle (tpe.)	H: 170° ; V:160°	
Response (tpe.)	5 ms (Gray to Gray)	
<b>Power supply</b>		
Input	100 to 240 V AC (50~60 Hz)	
Max. power consumption	50W	55 W
Power saving	<0.5 W	
<b>Mechanical</b>		
Dimensions (W x H x D mm)	446.15 x 358.5 x 144.44	511.65 x 400.02 x 144.44
Weight (kg)	4	5
Weight (lbs.)	8.8	11
Gross weight (Kg)	6	11
Gross weight (lbs)	13.2	16.5
Wall mounting	100mm x 100mm	
<b>Analog TV system</b>		
Colour system	PAL, SECAM	
Sound system	B/G/D/K/I/L	
Stereo system	NICAM/A2	
Subtitle	Teletext 1.5 (1000 pages)	

<b>Terminal</b>	
Analog Tuner In	Yes
SCART 1	CVBS(In/Out), RGB(In), Audio R/L
Component in	YPbPr, Audio (R/L)
AV-in	CVBS, Audio (R/L)
S Video	S Video, Audio (R/L)
HDMI 1	Yes (HDMI 1.2)
HDMI 2	Yes (HDMI 1.2)
PC D-sub in	Yes
PC audio-in	Yes
Headphone out	Yes
<b>Resolution</b>	
HDMI	480i/p, 576i/p, 720p, 1080i
<b>Audio system</b>	
Speakers	3W + 3W

## Free Manuals Download Website

<http://myh66.com>

<http://usermanuals.us>

<http://www.somanuals.com>

<http://www.4manuals.cc>

<http://www.manual-lib.com>

<http://www.404manual.com>

<http://www.luxmanual.com>

<http://aubethermostatmanual.com>

Golf course search by state

<http://golfingnear.com>

Email search by domain

<http://emailbydomain.com>

Auto manuals search

<http://auto.somanuals.com>

TV manuals search

<http://tv.somanuals.com>