

Acer Projector

K138STi/L224R/LK-W16F Series User's Guide

Copyright © 2015. Acer Incorporated.
All Rights Reserved.

Acer Projector User's Guide
Original Issue: 09/2015

Changes may be made periodically to the information in this publication without obligation to notify any person of such revisions or changes. Such changes will be incorporated in new editions of this manual or supplementary documents and publications. This company makes no representations or warranties, either expressed or implied, with respect to the contents hereof and specifically disclaims the implied warranties of merchantability or fitness for a particular purpose.

Record the model number, serial number, purchase date and place of purchase information in the space provided below. The serial number and model number are recorded on the label affixed to your projector. All correspondence concerning your unit should include the serial number, model number and purchase information.

No part of this publication may be reproduced, stored in a retrieval system, or transmitted, in any form or by any means, electronically, mechanically, by photocopy, recording or otherwise, without the prior written permission of Acer Incorporated.

Model number: _____

Serial number: _____

Date of purchase: _____

Place of purchase: _____

Acer and the Acer logo are registered trademarks of Acer Incorporated. Other companies' product names or trademarks are used herein for identification purposes only and belong to their respective companies.

"HDMI™, the HDMI logo and High-Definition Multimedia Interface are trademarks or registered trademarks of HDMI Licensing LLC."

For DTS patents, see <http://patents.dts.com>.

Manufactured under license from DTS Licensing Limited. DTS, the Symbol, & DTS and the Symbol together are registered trademarks, and DTS Sound is a trademark of DTS, Inc. © DTS, Inc. All Rights Reserved.

HDMI[®]
HIGH-DEFINITION MULTIMEDIA INTERFACE

 **dts**[®]
Sound

Information for your safety and comfort

Read these instructions carefully. Keep this document for future reference. Follow all warnings and instructions marked on the product.

Turning the product off before cleaning

Unplug this product from the wall outlet before cleaning. Do not use liquid cleaners or aerosol cleaners. Use a damp cloth for cleaning.

Caution for plug as disconnecting device

Observe the following guidelines when connecting and disconnecting power to the external power supply unit:

- Install the power supply unit before connecting the power cord to the AC power outlet.
- Unplug the power cord before removing the power supply unit from the projector.
- If the system has multiple sources of power, disconnect power from the system by unplugging all power cords from the power supplies.

Caution for Accessibility

Be sure that the power outlet you plug the power cord into is easily accessible and located as close to the equipment operator as possible. When you need to disconnect power to the equipment, be sure to unplug the power cord from the electrical outlet.



Warnings!

- Do not use this product near water.
- Do not place this product on an unstable cart, stand or table. If the product falls, it could be seriously damaged.
- Slots and openings are provided for ventilation to ensure reliable operation of the product and to protect it from overheating. These openings must not be blocked or covered. The openings should never be blocked by placing the product on a bed, sofa, rug or other similar surface.

This product should never be placed near or over a radiator or heat register, or in a built-in installation unless proper ventilation is provided.

- Never push objects of any kind into this product through cabinet slots as they may touch dangerous voltage points or short-out parts that could result in a fire or electric shock. Never spill liquid of any kind onto or into the product.

- To avoid damage of internal components and to prevent battery leakage, do not place the product on a vibrating surface.
- Never use it under sporting, exercising, or any vibrating environment which will probably cause unexpected short current or damage rotor devices.

Using electrical power

- This product should be operated from the type of power indicated on the marking label. If you are not sure of the type of power available, consult your dealer or local power company.
- Do not allow anything to rest on the power cord. Do not locate this product where people will walk on the cord.
- If an extension cord is used with this product, make sure that the total ampere rating of the equipment plugged into the extension cord does not exceed the extension cord ampere rating. Also, make sure that the total rating of all products plugged into the wall outlet does not exceed the fuse rating.
- Do not overload a power outlet, strip or receptacle by plugging in too many devices. The overall system load must not exceed 80% of the branch circuit rating. If power strips are used, the load should not exceed 80% of the power strip's input rating.
- This product's AC adapter is equipped with a three-wire grounded plug. The plug only fits in a grounded power outlet. Make sure the power outlet is properly grounded before inserting the AC adapter plug. Do not insert the plug into a non-grounded power outlet. Contact your electrician for details.



.....

Warning! The grounding pin is a safety feature. Using a power outlet that is not properly grounded may result in electric shock and/or injury.



.....

Note: The grounding pin also provides good protection from unexpected noise produced by other nearby electrical devices that may interfere with the performance of this product.

- Use the product only with the supplied power supply cord set. If you need to replace the power cord set, make sure that the new power cord meets the following requirements: detachable type, UL listed/CSA certified, VDE approved or its equivalent, 4.5 meters (15 feet) maximum length.

Product servicing

Do not attempt to service this product yourself, as opening or removing covers may expose you to dangerous voltage points or other risks. Refer all servicing to qualified service personnel.

Unplug this product from the wall outlet and refer servicing to qualified service personnel when:

- the power cord or plug is damaged, cut or frayed
- liquid was spilled into the product
- the product was exposed to rain or water
- the product has been dropped or the case has been damaged
- the product exhibits a distinct change in performance, indicating a need for service
- the product does not operate normally after following the operating instructions



.....

Note: Adjust only those controls that are covered by the operating instructions, since improper adjustment of other controls may result in damage and will often require extensive work by a qualified technician to restore the product to normal condition.



.....

Warning! For safety reasons, do not use non-compliant parts when adding or changing components. Consult your reseller for purchase options.

Your device and its enhancements may contain small parts. Keep them out of the reach of small children.

Additional safety information

- Do not look into the projector's lens when the light is on. The bright may hurt your eyes.
- Turn on the projector first and then signal sources
- Do not place the product in following environments:
 - Space that is poorly ventilated or confined. At least 50cm clearance from walls and free flow of air around the projector is necessary.
 - Locations where temperatures may become excessively high, such as inside of a car with all windows rolled up.
 - Locations where excessive humidity, dust, or cigarette smoke may contaminate optical components, shortening the life span and darkening the image.
 - Locations near fire alarms.
 - Locations with an ambient temperature above 40 °C/104 °F.
 - Locations where the altitudes are higher than 10000 feet.
- Unplug immediately if there is something wrong with your projector. Do not operate if smoke, strange noise or odor comes out of your projector. It

might cause fire or electric shock. In this case, unplug immediately and contact your dealer.

- Do not keep using this product to break or drop it. In this case contact your dealer for inspection.
- Do not face the projector lens to the sun. It can lead to fire.
- When switching the projector off, suggest to ensure the projector completes its cooling cycle before disconnecting power.
- Do not frequently turn off the main power abruptly or unplug the projector during operation. The best way is to wait for the fan to turn off before turning main power off.
- Do not touch air outlet grille and bottom plate which becomes hot.
- Clean the air filter frequently if have. The temperature inside may rise and cause damage when the filter/ventilation slots clogged with dirt or dust.
- Do not look into the air outlet grille when projector is operating. It may hurt your eyes.
- Always open the lens shutter or remove the lens cap when the projector is on.
- Do not block the projector lens with any object when the projector is under operation as this could cause the object to become heated and deformed or even cause a fire.
- Do not attempt to disassemble this projector. There are dangerous high voltages inside which may hurt you. Refer servicing only to suitable qualified professional service personnel.
- Do not stand the projector on end vertically. It may cause the projector to fall over, causing injury or damage.

Caution for Listening

To protect your hearing, follow these instructions.

- Increase the volume gradually until you can hear clearly and comfortably.
- Do not increase the volume level after your ears have adjusted.
- Do not listen to music at high volumes for extended periods.
- Do not increase the volume to block out noisy surroundings.
- Decrease the volume if you can't hear people speaking near you.

Disposal instructions

Do not throw this electronic device into the trash when discarding. To minimize pollution and ensure utmost protection of the global environment, please recycle. For more information on the Waste from Electrical and Electronics Equipment (WEEE) regulations, visit

<http://www.acer-group.com/public/Sustainability/sustainability01.htm>



First things first

Usage Notes

Do:

- Turn off the product before cleaning.
- Use a soft cloth moistened with mild detergent to clean the display housing.
- Disconnect the power plug from AC outlet if the product is not being used for a long period of time.

Don't:

- Block the slots and openings on the unit provided for ventilation.
- Use abrasive cleaners, waxes or solvents to clean the unit.
- Use under the following conditions:
 - In extremely hot, cold or humid environments.
 - In areas susceptible to excessive dust and dirt.
 - Near any appliance that generates a strong magnetic field.
 - Place In direct sunlight.

Precautions

Follow all warnings, precautions and maintenance as recommended in this user's guide to maximize the life of your unit.



.....
Warning:

- Do not look into the projector's lens when the light is on. The bright may hurt your eyes.
- To reduce the risk of fire or electric shock, do not expose this product to rain or moisture.
- Please do not open or disassemble the product as this may cause electric shock.
- When switching the projector off, please ensure the projector completes its cooling cycle before disconnecting power.
- Turn on the projector first and then the signal sources.
- Do not use lens cap when projector is in operation.

Information for your safety and comfort	iii
First things first	viii
Usage Notes	viii
Precautions	viii
Introduction	1
Product Features	1
Package Overview	2
Projector Overview	3
Projector Outlook	3
Control Panel	4
Remote Control Layout	6
MHL (Mobile High-Definition Link) Control	8
Getting Started	9
Connecting the Projector	9
DC 5V Out for Device Charge	10
Turning the Projector On/Off	11
Turning on the Projector	11
Turning the projector off	12
Adjusting the Projected Image	13
Adjusting the Height of Projected Image	13
How to optimize image size and distance	14
Under Operation with Battery	15
LED Indicator / Messages	15
Display Mode and Battery Capacity	16
DC 5V Out for Device Charge	16
User Controls	17
Installation menu	17
Onscreen Display (OSD) Menus	18
Color	19
Image	20
Setting	22
Management	22
Audio	23

Contents

3D	23
Language	24
Appendices	25
Troubleshooting	25
LED & Alarm Definition Listing	30
LED Indicator / Messages	30
Specifications	31
Display Mode and Battery Capacity	33
Compatibility modes	34
Regulations and safety notices	38

Introduction

Product Features

This product is a single-chip DLP® projector. Outstanding features include:

- DLP® technology
- 1280 x 800 WXGA resolution
4:3/16:9/Full/L.Box aspect ratio supported.
- Versatile display modes (Bright, Standard, Movie, Picture, Game, User) enable optimum performance in any situation.
- Compact size projector facilitates business purposes and home entertainment.
- Acer EcoProjeciton Technology delivers Intelligent power management approach and physical efficiency improvement.
- Equipped with HDMI™ connection supporting HDCP.
- Advanced digital keystone correction delivers optimum presentations.
- Multi-language on screen display (OSD) menus.
- 1.7x digital zoom and pan move function.
- Environmental light source and longer life by LED solution.
- Microsoft® Windows® XP, Vista®, Windows® 7, Windows® 8, Windows® 8.1, Windows® 10, Macintosh® OS compliant.
- Support MHL V2.0 signal display.
- Support LumiSense+.
- Support BT audio speaker.
- Built-in two 3 Watts speaker with dts™ feature.
- Built-in battery
- Support wireless projection

Package Overview

This projector comes with all the items shown below. Check to make sure your unit is complete. Contact your dealer immediately if any thing is missing.

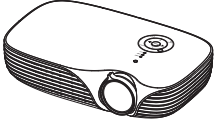

Projector

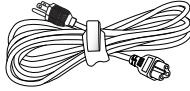

Power cord

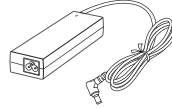

AC to DC power adapter



Remote control

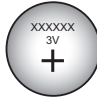

Battery



User's guide



Quick start guide



Carrying case



VGA cable

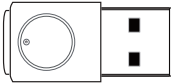

WirelessProjection-Kit

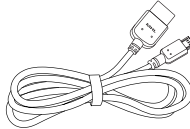

MHL cable (option)

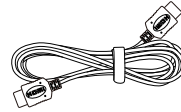

HDMI cable (option)

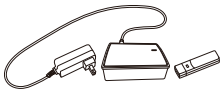

WirelessHD-Kit
(option)

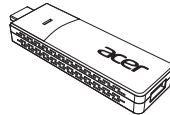

WirelessAndroid-Kit
(option)

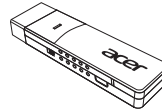

WirelessCAST
(option)



User's guide
(for multi-media and
wireless functions)



Quick start guide
(for multi-media and
wireless functions)

Projector Overview

Projector Outlook

Front / upper side

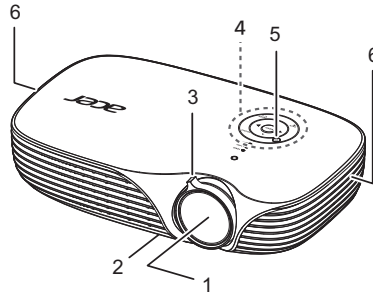

#	Description	#	Description
1	Projection lens	4	Control panel
2	Tilt adjusting wheel	5	Power button
3	Focus ring	6	Speakers

Rear side

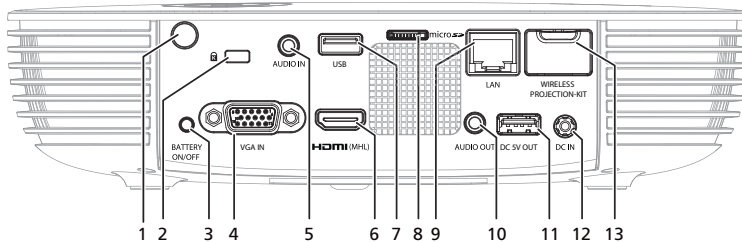

#	Description	#	Description
1	Remote control receiver	8	Micro SD slot
2	Kensington™ lock port	9	LAN (RJ45 Port for 10/100M Ethernet)
3	Battery on/off button (see Note 1.)	10	Audio out connector
4	PC analog signal/HDTV/component video input connector (VGA IN)	11	5V DC output connector (device charge only)
5	Audio input connector	12	DC Input
6	HDMI/MHL connector	13	For Acer WirelessProjection-Kit only, see Note 3.
7	USB Connector, see Note 2. (Support USB flash disk and flash memory storage access)		



Note 1: The design mechanism of "Battery On/Off button" is to protect projector from powering on by touching power button accidentally. To power on projector, press "Battery On/Off" button first and then press power button within 60 sec.

Note 2: It is not allowed to plug in Acer WirelessProjection-Kit or other USB WiFi dongle.

Note 3: Acer WirelessProjection-Kit is only allowed to be installed while projector is off; forbidden to plug out or installed while projector is active.

Control Panel

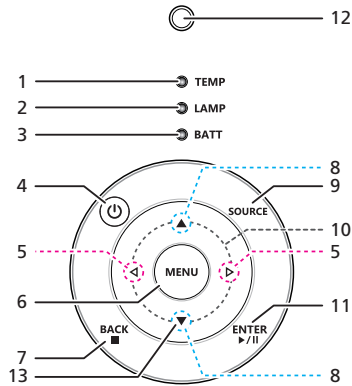

#	Icon	Function	Description
1	TEMP	LED Indicator	Overheat temperature warning
2	LAMP	LED Indicator	Lamp problem warning
3	BATT	LED Indicator	Show battery status by colors (Details see LED indicator page)
4		POWER	See the contents in "Turning the Projector On/Off" section.
5		Volume	Increases/decreases the volume.
6		MENU	<ul style="list-style-type: none"> Press "MENU" to launch the Onscreen display (OSD) menu, back to the previous step for the OSD menu operation or exit the OSD menu. Confirm your selection of items.

#	Icon	Function	Description
7	BACK ■	Back/Exit	<ul style="list-style-type: none"> Press "BACK" to go back one menu step. To exit the file. (only for Navigation mode)
		Stop	Discontinues playback. (only for Multi-Media mode)
8	▲ ▼	Keystone	Adjusts the image to compensate for distortion caused by tilting the projector. (±20 degrees)
9	SOURCE	SOURCE	Changes the active source.
10	▲ ▼ ▶ ◀	Four directional select keys	Use ▲▼▶◀ to select items or make adjustments to your selection.
11	ENTER ▶/	Select/Enter	Press to select/enter the file. (only for Navigation mode)
		Play/Pause	Toggles between playback and pause. (only for Multi-Media mode)
12	⊙	Ambient light sensor	Detect ambient light if LumiSense+ is triggered.
13	▼	Display Key	Long press DOWN key will pop up a screen to ask if end user needs to do screen off.

Remote Control Layout

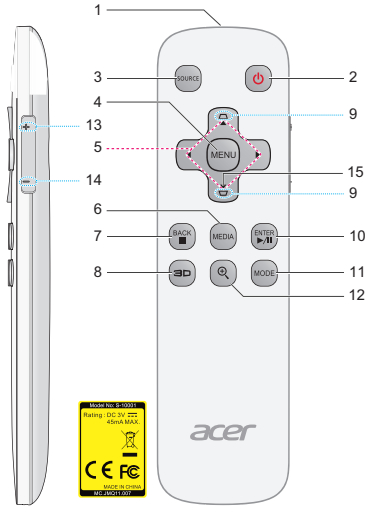

#	Icon	Function	Description
1		Infrared transmitter	Sends signals to the projector.
2		POWER	Refer to the " Turning the Projector On/Off " section.
3		SOURCE	Changes the active source.
4		MENU	<ul style="list-style-type: none"> Press "MENU" to launch the Onscreen display (OSD) menu, back to the previous step for the OSD menu operation or exit the OSD menu. Confirm your selection of items.
5		Four directional select keys	Use up, down, left, right buttons to select items or make adjustments to your selection.
6		MEDIA	Press " MEDIA " to return to the home page of media mode.
7		BACK	Press " BACK " to go back one menu step.
8		3D	Press " 3D " to select 3D models.
9		KEYSTONE	Adjusts the image to compensate for distortion caused by tilting the projector.
10		Select/Enter	Press to select/enter the file. (only for Navigation mode)
		Play/Pause	Toggles between playback and pause. (only for Multi-Media mode)
11		MODE	Press " MODE " to select the display mode from Bright, Standard, Movie, Picture, Game and User.
12		ZOOM	Zooms the projector display in or out.

#	Icon	Function	Description
13	+	Volume UP	Increases the volume.
14	-	Volume Down	Decreases the volume.
15	▼	Display Key	Long press DOWN key will pop up a screen to ask if end user needs to do screen off.



.....

Note 1: Functions vary depending on model definition.

Note 2: Before using the remote control for the first time, remove the transparent insulation tape in the bottom of remote control.

MHL (Mobile High-Definition Link) Control

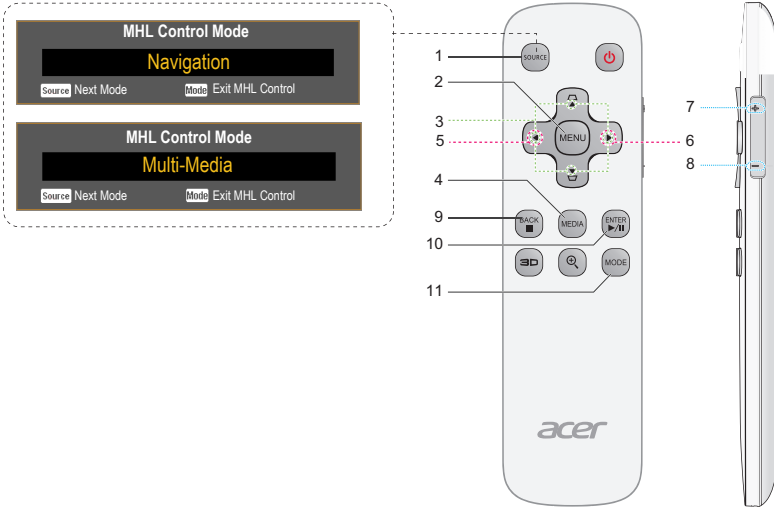

#	Icon	Function	Description
1		SOURCE	Press the "SOURCE" button to toggle between Navigation or Multi-Media mode.
2		MENU	Press to launch the root menu. (only for Navigation mode)
3		Four directional select keys	Use up, down, left, right buttons to select items or make adjustments to your selection. (only for Navigation mode)
4		MEDIA	Press " MEDIA " to return to the home page of media mode. (only for Multi-Media mode)
5		Volume Down	Decreases the volume. (only for Multi-Media mode)
6		Volume UP	Increases the volume. (only for Multi-Media mode)
7		Volume UP	Increases the volume. (only for Navigation mode)
8		Volume Down	Decreases the volume. (only for Navigation mode)
9		Back/Exit	<ul style="list-style-type: none"> Press "BACK" to go back one menu step. To exit the file. (only for Navigation mode)
		Stop	Discontinues playback. (only for Multi-Media mode)
10		Select/Enter	Press to select/enter the file. (only for Navigation mode)
		Play/Pause	Toggles between playback and pause. (only for Multi-Media mode)
11		MODE	<ul style="list-style-type: none"> Press "MODE" button for one second to activate the MHL Control Mode. To exit, press the "MODE" button again.



Note: Functions vary depending on model definition.

Getting Started

Connecting the Projector

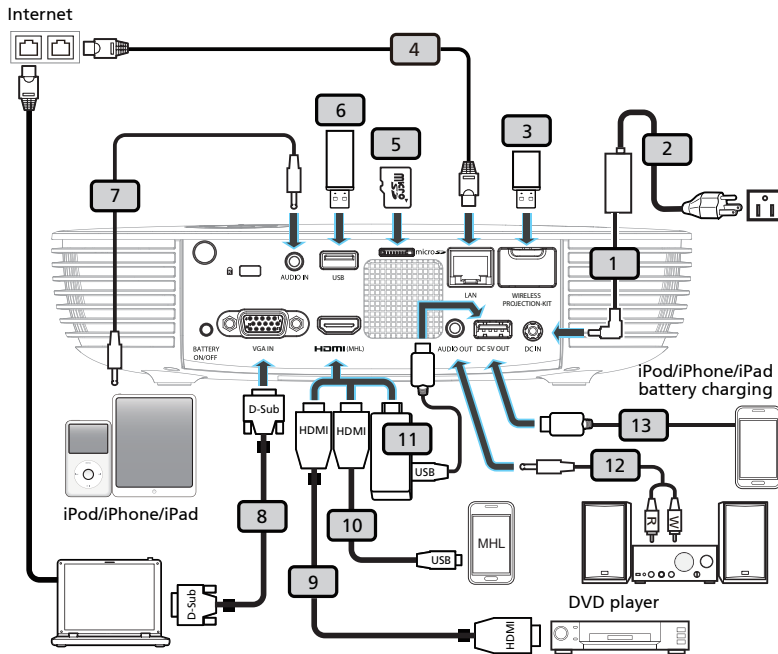

#	Description	#	Description
1	AC to DC power adapter	8	VGA cable
2	Power cord	9	HDMI cable
3	USB WiFi adapter	10	MHL cable (MicroUSB to HDMI)
4	LAN cable	11	WirelessCAST
5	Micro SD card	12	Audio cable Jack/RCA
6	(*) USB disk/stick	13	USB cable for charging device (See details in DC 5V Out for Device Charge)
7	Audio cable Jack/Jack		



Note 1: Functions vary depending on model definition.

Note 2: Some smartphones require a converter (supplied by smartphone maker) to enable the MHL function.

Note 3: "*" USB drive limitation, do not support power consumption over 500mA. Please have external power for USB

device.

Note 4: To ensure the projector works well with your computer, please make sure the timing of the display mode is compatible with the projector.

Note 5: USB cable needs powered extender if the length is over 5 m.

DC 5V Out for Device Charge

- 1 In standby mode (after turning off projector), It will supply power DC 5V to connected device while pressing Battery button. DC 5V will be turned off automatically in 60 sec while device charging is full charge or disconnected.
- 2 In active mode (after turning on projector), MHL and DC 5V are alternatively powered on, ex. DC 5V is off when MHL is on and DC 5V is on when MHL is off.
- 3 In active mode, MHL will be top priority if both DC 5V and MHL port are occupied.



.....

Note: USB DC 5V out connector support 5V/1.0A power output for power bank charging only when MHL source is not detected.

Turning the Projector On/Off

Turning on the Projector

- 1 Remove the lens cap.(Illustration #1)
- 2 Ensure that the power cord and signal cable are securely connected. The Power indicator LED will turn red.
- 3 Under battery-powered, press the "Battery ON / OFF" key first (Illustration #2), and the BTTY LED lights, Power indicator LED blanks red. Within 60 seconds, press the "Power" button to turn the projector on. Over time, the projector will return to primeval state, and restart this step.
- 4 Turn on the projector by pressing "**Power**" button on the control panel or the remote control, and the Power indicator LED will turn blue.(Illustration #3)
- 5 Turn on your source (computer, notebook, video player ,etc.). The projector will detect your source automatically.
 - If the screen displays "No Signal", please make sure the signal cables are securely connected.
 - If you connect to multiple sources at the same time, use the "Source" button on either control panel or the remote control or direct source key on the remote control to switch between inputs.

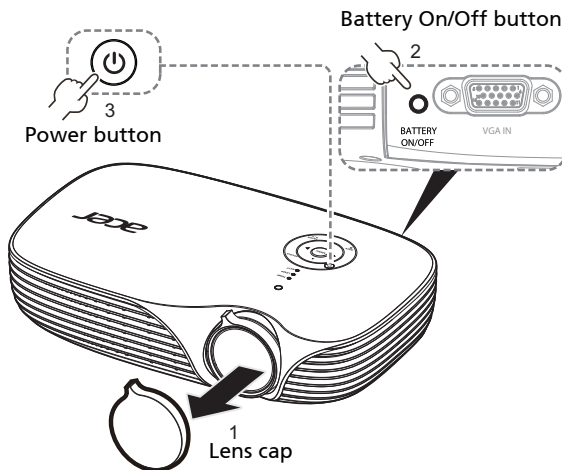

Note: For 1ST time usage, please plug in DC power and press power button when power LED turn RED.

Turning the projector off

- 1 To turn the projector off, press the power button. This message appears: **"Please press the power button again to complete the shutdown process."** Press the power button again.
- 2 The LED power indicator will stop blinking and turn solid red to indicate standby mode after the projector is turned off.
- 3 It is now safe to unplug the power cord.



Warning indicators:

- **"Projector Overheated. Will automatically turn off soon."**
This onscreen message indicates that the projector has overheated. The projector will automatically shut down. Contact your local dealer or service center.
- **"Fan failed. Will automatically turn off soon."**
This onscreen message indicates that the fan has failed. The projector will automatically shut down. Contact your local dealer or service center.



Note: Whenever the projector automatically shuts down, contact your local reseller or service center.

Adjusting the Projected Image

Adjusting the Height of Projected Image

The projector is equipped with tilt adjusting wheel for adjusting the height of image.

To raise/lower the image:

- Use Tilt adjusting wheel to fine-tune the display angle.

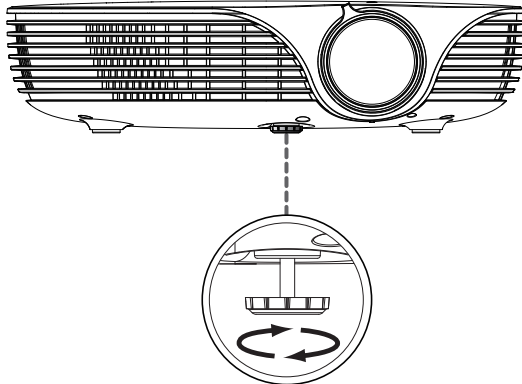

Tilt adjusting wheel

How to optimize image size and distance

Consult the table below to find the optimal image sizes achievable when the projector is positioned at a desired distance from the screen. Example: If the projector is 1.50 m from the screen, good image quality is possible for image sizes 87.1".



Note: Remind as below figure, the space of 117 cm height is required when located at 1.50 m distance.

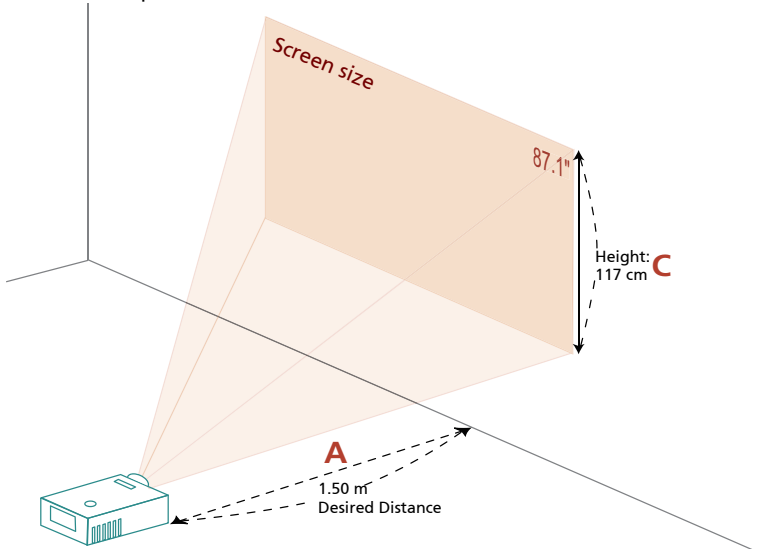

Desired Distance (m) <A>	Screen size		Top
	(Min zoom)		
	Diagonal (inch) 	W (cm) x H (cm)	From base to top of image (cm) <C>
0.43	25.0	54 x 34	34
0.86	49.9	108 x 67	67
1.00	58.0	125 x 78	78
1.14	66.2	143 x 89	89
1.28	74.3	160 x 100	100
1.42	82.4	178 x 111	111
1.50	87.1	188 x 117	117
1.72	99.8	215 x 134	134

Zoom Ratio: 1.0x

Under Operation with Battery

LED Indicator / Messages

	LED	POWER LED	LAMP	TEMP	BATTERY
Standby	Adapter Power (Battery: Off)	Red	-	-	Orange (In Charge) Green (End of Charge)
	Adapter Power (Battery: On)	Red (Flashing)			
	Battery Power (Battery: Off)	-	-	-	Green (>70%) Orange (30%~70%) Red (<30%)
	Battery Power (Battery: On)	Red (Flashing 1 min.)			
Power On	Adapter power	Blue	-	-	Orange (In Charge) Green (End of Charge) Green (>70%) Orange (30%~70%) Red (<30%)
	Battery power				
Overheated	Adapter power	Blue	-	Red	Orange (In Charge) Green (End of Charge) Green (>70%) Orange (30%~70%) Red (<30%)
	Battery power				
FAN Fail	Adapter power	Blue	-	Red (Flashing)	Orange (In Charge) Green (End of Charge) Green (>70%) Orange (30%~70%) Red (<30%)
	Battery power				
LED Fail	Adapter power	Blue	Red	-	Orange (In Charge) Green (End of Charge) Green (>70%) Orange (30%~70%) Red (<30%)
	Battery power				



Note: When power on, click any key, Menu/Up/Down/Left/Right key LED will all be trigger.

Display Mode and Battery Capacity

Referenced Operating Scenarios	Movie Mode (Display Hours)	Standard Mode (Display Hours)
Display a movie by DVD player via HDMI port	3.0hrs	1.5hrs
Local play USB flash thumb content	2.5hrs	1.2hrs
Connect ChromeCast (display videos via Youtube)	2.5hrs	1.2hrs
Source "LAN/WiFi" and do wireless projection via mobile	2.5hrs	1.2hrs



Note 1: The above table is based on battery mode (without plugging power adapter).

Note 2: The above table is at maximum volume and USB WiFi is active. Battery status is from full to end.

Note 3: The battery capacity will be decreased by longer time and more recycling times. The above table is for reference only.

Note 4: Keep the power more than 30% always for better cell life.

Note 5: Full recharge the power bank at least every 3 months.

Note 6: For 1ST time usage, please plug in DC power to recharge battery 8hrs.

DC 5V Out for Device Charge

- 1 In standby mode (after turning off projector), It will supply power DC 5V to connected device while pressing Battery button. DC 5V will be turned off automatically in 60 sec while device charging is full charge or disconnected.
- 2 In active mode (after turning on projector), MHL and DC 5V are alternatively powered on, ex. DC 5V is off when MHL is on and DC 5V is on when MHL is off.
- 3 In active mode, MHL will be top priority if both DC 5V and MHL port are occupied.



Note: USB DC 5V out connector support 5V/1.0A power output for power bank charging only when MHL source is not detected.

User Controls

Installation menu

The installation menu provides an onscreen display (OSD) for projector installation and maintenance. Use the OSD only when the message "No signal input" is displayed on the screen.

The menu options include settings and adjustments for screen size and distance, focus, keystone correction and more .

- 1 Turn on the projector by pressing "**Power**" button on the control pad.
- 2 Press the "**MENU**" button on the control pad to launch the OSD for projector installation and maintenance.



- 3 The background pattern acts as a guide to adjusting the calibration and alignment settings, such as screen size and distance, focus and more.



Note: The OSD screenshot is for reference only and may differ from the actual design.







- 4 The Installation menu includes the following options.

Use the up and down arrow keys to select an option, the left and right arrow keys to adjust selected option settings, and the right arrow key to enter a submenu for feature setting. The new settings will be saved automatically upon exiting the menu.
- 5 Press the "MENU" anytime to exit the menu and return to the Acer welcome screen.

Onscreen Display (OSD) Menus

The projector has multilingual OSD that allow you to make image adjustments and change a variety of settings.

Using the OSD menu

- To open the OSD menu, press **"MENU"** on the remote control.
- When the OSD is displayed, use the   keys to select any item in the main menu. After selecting the desired main menu item, press  to enter submenu for feature setting.
- Use the   keys to select the desired item and adjust the settings by using the   keys.
- Select the next item to be adjusted in the submenu and adjust as described above.
- Press **"MENU"** on the remote control, the screen will return to the main menu.
- To exit OSD, press **"MENU"** on the remote control again. The OSD menu will close and the projector will automatically save the new settings.

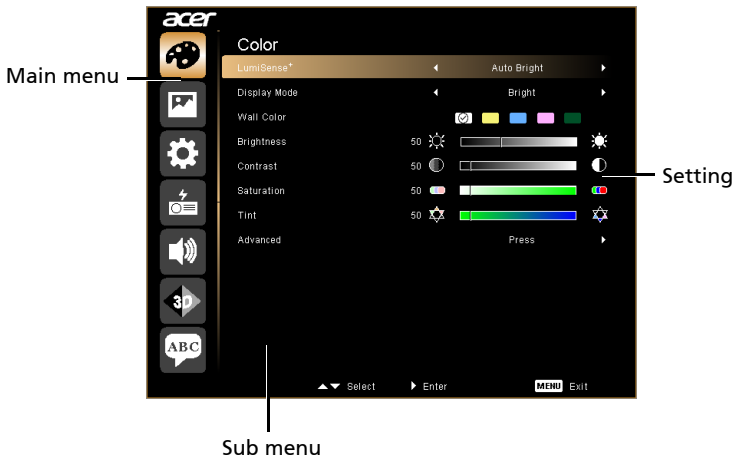

Note: Some of the following OSD settings may not be available. Please refer to the actual OSD of your projector.

Color

LumiSense+	<p>The light sensor of LumiSense+ technology can intelligently optimize the brightness and color saturation of projected image based on actual ambient light. The feature greatly enhances dark detail visibility and color saturation.</p> <ul style="list-style-type: none"> • Off: For normal mode. (ambient light sensor is off) • Auto Bright: Light sensor is on to automatically detect ambient light and optimize the brightness and color saturation of projected image. • Dynamic Black: automatically optimize the display of dark movie scenes enabling them to be shown in incredible detail. <p><Note>: 1. Dynamic Black shows up while in Movie mode. 2. Dynamic Black is not supported while in battery mode.</p>
Display Mode	<p>There are many factory presets optimized for various types of images.</p> <ul style="list-style-type: none"> • Bright: For brightness optimization. • Standard: For common environment. • Movie: For brighter and general movie/video/photo playing. • Picture: For graphic picture. • Game: For game content. • User: Memorize user's settings. <p><Note>: Bettery mode only have Standard, Movie and User mode.</p>
Wall color	<p>Use this function to choose a proper color according to the wall. There are several choices, including white, light yellow, light blue, pink, dark green. It will compensate the color deviation due to the wall color to show the correct image tone.</p>
Brightness	<p>Adjust the brightness of the image.</p> <ul style="list-style-type: none"> • Press ◀ to darken image. • Press ▶ to lighten the image.
Contrast	<p>"Contrast" controls the difference between the lightest and darkest parts of the picture. Adjusting the contrast changes the amount of black and white in the image.</p> <ul style="list-style-type: none"> • Press ◀ to decrease the contrast. • Press ▶ to increase the contrast.
Saturation	<p>Adjust a video image from black and white to fully saturated color.</p> <ul style="list-style-type: none"> • Press ◀ to decrease the amount of color in the image. • Press ▶ to increase the amount of color in the image.
Tint	<p>Adjust the color balance of red and green.</p> <ul style="list-style-type: none"> • Press ◀ to increase the amount of green in the image. • Press ▶ to increase the amount of red in the image.

Advanced	Color Temperature Use this function to choose CT1, CT2, CT3.
	Degamma Effects the representation of dark scenery. With greater gamma value, dark scenery will look brighter.



Note: "Saturation" and "Tint" functions are not supported under computer mode or HDMI mode.

Image

Projection Mode	<ul style="list-style-type: none"> Front: The factory default setting. Rear: Reverses the image so you can project from behind a translucent screen.
Projection Location	<ul style="list-style-type: none"> Auto: Automatically adjusts projection location of image. Desktop Ceiling: Turns the image upside down for ceiling-mounted projection.
Aspect Ratio	<p>Use this function to choose your desired aspect ratio.</p> <ul style="list-style-type: none"> Auto: Keep the image with original width-highth ratio and maximize the image to fit native horizontal or vertical pixels. 4:3: The image will be scaled to fit the screen and displayed using a 4:3 ratio. 16:9: The image will be scaled to fit the width of the screen and the height adjusted to display the image using a 16:9 ratio. Full: Resize image to fit full screen by width (1280 pixels) and height (800 pixels). L.Box: Keep original signal aspect ratio and zoom in by 1.333 times.
Auto Keystone	Automatically adjusts vertical image.
Manual Keystone	<p>Adjust image distortion caused by tilting projection. (±20 degrees)</p> <p><Note> The Manual Keystone function is unavailable under Auto Keystone setting to "On".</p>
Sharpness	<p>Adjust the sharpness of the image.</p> <ul style="list-style-type: none"> Press to decrease the sharpness. Press to increase the sharpness.

H. Position	<ul style="list-style-type: none"> • Press ◀ to move the image left. • Press ▶ to move the image right.
V. Position	<ul style="list-style-type: none"> • Press ▼ to move the image down. • Press ▲ to move the image up.
Frequency	"Frequency" changes the projector's refresh rate to match the frequency of your computer's graphics card. If you can see a vertical flickering bar in the projected image, use this function to make the necessary adjustments.
Tracking	Synchronizes the signal timing of the projector with the graphics card. If you experience an unstable or flickering image, use this function to correct it.
HDMI Color Range	Adjust the color range of the HDMI image data to correct color display error. <ul style="list-style-type: none"> • Auto: Automatically adjust by information from player. • Limited Range: Process the input image as limited color range data. • Full Range: Process the input image as full color range data.
HDMI Scan Info	Adjust the overscan ratio of the HDMI image on screen. <ul style="list-style-type: none"> • Auto: Automatically adjust by information from player. • Underscan: Always no overscan on HDMI image. • Overscan: Always keep overscan on HDMI image.



Note 1: "H. Position", "V. Position", "Frequency" and "Tracking" functions are not supported under HDMI, DVI or Video mode.

Note 2: "Sharpness" functions is not supported under HDMI (RGB) or Computer mode.

Note 3: "HDMI Color Range" and "HDMI Scan Info" functions are only supported under HDMI mode.

Setting

Network	LAN Reset To refresh LAN IP.
	LAN IP/Mask Identify IP and Mask address. (LAN Mode)
	WiFi IP/Mask Identify IP and Mask address. (WiFi Mode) <Note> "WiFi IP/Mask" will grey out if Acer WirelessProjection-Kit isn't being installed.
Reset	Press the  button and choose "Yes" to return the parameters on all menus to the factory default settings.





.....

Note 1: Functions vary depending on model definition.
Note 2: Acer WirelessProjection-Kit is only allowed to be installed while projector is off; forbidden to plug out or installed while projector is active.

Management

ECO Mode	Choose "On" to dim the projector LED brightness which will lower power consumption, extend the LED life and reduce noise. Choose "Off" to return normal mode.
High Altitude	Choose "On" to turn on High Altitude mode. Operate the fans at full speed continuously to allow for proper high altitude cooling of the projector.
Auto Shutdown	The projector will automatically shutdown when there is no signal input after the allocated time. (default is 15 minutes)
AC Power On	Choose "On" to power on projector while AC power plug in.

Audio

Volume	<ul style="list-style-type: none"> Press  to decrease the volume. Press  to increase the volume.
BT Speaker	<p>Adjust Bluetooth Headset Speaker. Show "Connected" or "Not-Connected" and Press , to enter pop-up menu.</p> <ul style="list-style-type: none"> Bluetooth: Turn on/off the Bluetooth. Device Search: This function to list BT speakers (which is in pairing mode and with A2DP service) and connect manually by user. <p><Note> Internal speaker off while BT speaker connection is connected successfully.</p>
DTS Sound	<p>DTS Sound™ is a sound enrichment suite that includes several post processing techniques to expand the sound image, enhance bass, improve definition and add natural surround effects.</p> <ul style="list-style-type: none"> Choose "On" to enable DTS Sound. Choose "Off" to disable DTS Sound.
Treble	Adjust tones of high frequency.
Bass	Adjust tones of low frequency.
Mute	<ul style="list-style-type: none"> Choose "On" to mute the volume. Choose "Off" to restore the volume.
Alarm Volume	Select this function to adjust the volume of any warning notifications.

3D

3D	<p>Choose "On" to enable DLP 3D function.</p> <ul style="list-style-type: none"> On: Choose this item while using DLP 3D glasses, quad buffer (NVIDIA/ATI...) graphic card and HQFS format file or DVD with corresponding SW player. Off: Turn off 3D mode.
3D L/R Invert	If you see a discrete or overlapping image while wearing DLP 3D glasses, you may need to execute "Invert" to get best match of left/right image sequence to get the correct image (for DLP 3D).
3D Warning Message	<p>Choose "On" to display the 3D warning message.</p> <div data-bbox="358 1185 841 1310" style="border: 1px solid black; padding: 5px;"> <p>Note: 3D display is now enabled.</p> <ol style="list-style-type: none"> Please make sure you have the correct 3D signals and glasses. Remember to turn 3D off if you don't want to see 3D images. If the 3D display isn't correct, please try to enable 3D Sync Invert. Display mode options will be disabled while in 3D mode. </div>



Note 1: It needs correct settings on graphic card 3D application program for correct 3D display.

Note 2: The SW players, such as Stereoscopic Player and DDD TriDef Media

Player can support 3D format files. You can download these three players on web page below,



- Stereoscopic Player (Trial): http://www.3dtv.at/Downloads/Index_en.aspx
- DDD TriDef Media Player (Trial):

<http://www.tridef.com/download/TriDef-3-D-Experience-4.0.2.html>

Note 3: "3D L/R Invert" is only available when 3D is enabled.

Note 4: There has reminder screen if 3D still enable when power on projector. Please adjust setting depended on your purpose.

Language

Language	<p>Choose the multilingual OSD menu. Use the  or  key to select your preferred menu language.</p> <ul style="list-style-type: none"> • Press  to confirm the selection.
----------	---



Note: Functions vary depending on model definition.

Appendices

Troubleshooting

If you experience a problem with your Acer projector, refer to the following troubleshooting guide. If the problem persists, please contact your local reseller or service center.

Image Problems and Solutions

#	Problem	Solution
1	No image appears onscreen	<ul style="list-style-type: none"> • Connected as described in the "Getting Started" section. • Ensure none of the connector pins are bent or broken. • Make sure you have removed the lens cap and the projector is switched on.
2	Partial, scrolling or incorrectly displayed image (For PC (Windows 95/98/2000/XP/Vista/Win7/Win 8))	<ul style="list-style-type: none"> • For an incorrectly displayed image: <ul style="list-style-type: none"> • Open "My Computer," open the "Control Panel," and then double-click the "Display" icon. • Select the "Settings" tab. • Verify that your display resolution setting is lower than or equal to 1080P-EIA. • Click the "Advanced Properties" button. • If the problem still appears, change the monitor display you are using and follow the steps below: <ul style="list-style-type: none"> • Verify that the resolution setting is lower than or equal to 1080P-EIA. • Click the "Change" button under the "Monitor" tab. • Click "Show all devices". Next, select "Standard monitor types" under the SP box, and choose the resolution mode you need under the "Models" box. • Verify that the resolution setting of the monitor display is lower than or equal to 1080P-EIA.

3	Partial, scrolling or incorrectly displayed image (for notebooks)	<ul style="list-style-type: none"> • For an incorrectly displayed image: <ul style="list-style-type: none"> • Follow the steps for item 2 (above) to adjust the resolution of your computer. • Press the toggle output settings. Example: [Fn]+[F4], Compaq [Fn]+[F4], Dell [Fn]+[F8], Gateway [Fn]+[F4], IBM [Fn]+[F7], HP [Fn]+[F4], NEC [Fn]+[F3], Toshiba [Fn]+[F5] • If you experience difficulty changing resolutions or your monitor freezes, restart all equipment including the projector.
4	The screen of the notebook computer is not displaying your presentation	<ul style="list-style-type: none"> • If you are using a Microsoft® Windows® based notebook: Some notebook PCs may deactivate their own screens when a second display device is in use. Each has a different way to be reactivated. Refer to your computer's manual for detailed information. • If you are using an Apple® Mac® OS based notebook: In System Preferences, open Display and select Video Mirroring "On".
5	Image is unstable or flickering	<ul style="list-style-type: none"> • Adjust the "Tracking" to correct it. Refer to the "Image" section for more information. • Change the display color depth settings on your computer.
6	Image has vertical flickering bar	<ul style="list-style-type: none"> • Use "Frequency" to make an adjustment. Refer to the "Image" section for more information. • Check and reconfigure the display mode of your graphics card to make it compatible with the projector.
7	Image is out of focus	<ul style="list-style-type: none"> • Adjust the focus ring on the projector lens. • Make sure the projection screen is within the required distance of 1.4-5.7 feet (0.4-1.7 meters) from the projector. Refer to the "How to Get a Preferred Image Size by Adjusting Distance and Zoom" section for more information.
8	Image is stretched when displaying a "widescreen" DVD title	<p>When you play a DVD encoded in anamorphic or 16:9 aspect ratio you may need to adjust the following settings:</p> <ul style="list-style-type: none"> • If you play a 4:3 format DVD title, please change the format to 4:3 in the projector OSD. • If the image is still stretched, you will also need to adjust the aspect ratio. Set up the display format to 16:9 (wide) aspect ratio on your DVD player. • If you play an Letterbox(LBX) format DVD title, please change the format to Letterbox(LBX) in the projector OSD.

9	Image is too small or too large	<ul style="list-style-type: none"> • Adjust the zoom ring on the top of the projector. • Move the projector closer to or further from the screen. • Press "MENU" on the remote control or on the control panel. Go to "Image --> Aspect Ratio" and try different settings.
10	Image has slanted sides	<ul style="list-style-type: none"> • If possible, reposition the projector so that it is centered on the screen. • Press the "Keystone" on the OSD until the sides are vertical.
11	Image is reversed	<ul style="list-style-type: none"> • Select "Image --> Projection Mode" on the OSD and adjust the projection direction.

Problems with the Projector

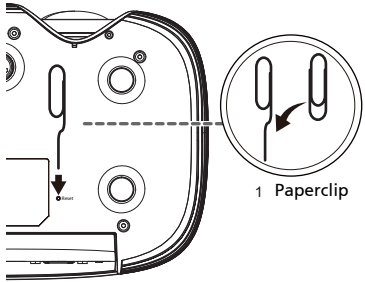
#	Condition	Solution
1	The projector stops responding to all controls	<p>If possible, turn off the projector, then unplug the power cord and wait at least 30 seconds before reconnecting power.</p> <p>Insert a paper clip (Illustration #1) into the "Reset" hole on the bottom of the projector to restart the system.</p>  <p>1 Paperclip</p>

OSD Messages

#	Condition	Message Reminder
1	Message	<p data-bbox="369 276 710 300">Fan Fail - the system fan is not working.</p> <div data-bbox="358 320 919 384" style="background-color: black; color: white; text-align: center; padding: 5px;"> <p data-bbox="547 331 743 371">Fan Fail. Will automatically turn off soon</p> </div> <p data-bbox="369 403 904 467">Projector Overheated - the projector has exceeded its recommended operating temperature and must be allowed to cool down before it may be used.</p> <div data-bbox="358 488 919 552" style="background-color: black; color: white; text-align: center; padding: 5px;"> <p data-bbox="554 499 754 539">Projector Overheated. Will automatically turn off soon</p> </div>
2	Message	<p data-bbox="369 579 568 603">Battery capacity is 20%</p> <div data-bbox="358 624 919 687" style="background-color: black; color: white; text-align: center; padding: 5px;"> <p data-bbox="456 635 820 659">The battery capacity will lower than 20% soon.</p> </div> <p data-bbox="369 687 568 711">Battery capacity is 10%</p> <div data-bbox="358 732 919 796" style="background-color: black; color: white; text-align: center; padding: 5px;"> <p data-bbox="445 743 820 767">The battery capacity will be lower than 10% soon</p> </div> <p data-bbox="369 796 558 820">Battery capacity is 5%</p> <div data-bbox="358 841 919 904" style="background-color: black; color: white; text-align: center; padding: 5px;"> <p data-bbox="461 852 814 876">The battery capacity will lower than 5% soon.</p> </div> <p data-bbox="369 904 558 928">Battery capacity is 1%</p> <div data-bbox="358 949 919 1013" style="background-color: black; color: white; text-align: center; padding: 5px;"> <p data-bbox="429 954 847 978">This projector runs out of battery and turns it off now.</p> <p data-bbox="445 989 831 1013">Please charge power by plugging in power adapter.</p> </div>

Battery Capacity Icon Message in OSD

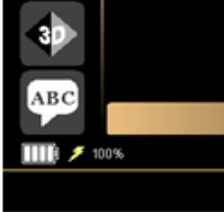
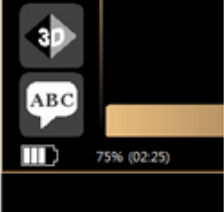
#	Condition	Message Reminder
1	Message	<p>(1) Charging (with power adapter): Show lightening logo and battery capacity (%)</p>  <p>(2) Battery powered (w/o power adapter): X % (YY:ZZ, YY=Hour;ZZ=Minutes) (Show battery capacity and remaining using time)</p> 

LED & Alarm Definition Listing

LED Indicator / Messages

	LED	POWER LED	LAMP	TEMP	BATTERY
Standby	Adapter Power (Battery: Off)	Red	-	-	Orange (In Charge) Green (End of Charge)
	Adapter Power (Battery: On)	Red (Flashing)			
	Battery Power (Battery: Off)	-	-	-	Green (>70%) Orange (30%~70%) Red (<30%)
	Battery Power (Battery: On)	Red (Flashing 1 min.)			
Power On	Adapter power	Blue	-	-	Orange (In Charge) Green (End of Charge)
	Battery power				Green (>70%) Orange (30%~70%) Red (<30%)
Overheated	Adapter power	Blue	-	Red	Orange (In Charge) Green (End of Charge)
	Battery power				Green (>70%) Orange (30%~70%) Red (<30%)
FAN Fail	Adapter power	Blue	-	Red (Flashing)	Orange (In Charge) Green (End of Charge)
	Battery power				Green (>70%) Orange (30%~70%) Red (<30%)
LED Fail	Adapter power	Blue	Red	-	Orange (In Charge) Green (End of Charge)
	Battery power				Green (>70%) Orange (30%~70%) Red (<30%)



Note: When power on, click any key, Menu/Up/Down/Left/Right key LED will all be trigger.

Specifications

The specifications listed below are subject to change without notice. For final specs, please refer to Acer's published marketing specifications.

Projection system	DLP®
Resolution	WXGA (1280 x 800)
Computer compatibility	IBM PC and compatibles, Apple Macintosh, iMac and VESA standards: SXGA+, SXGA, XGA, SVGA, VGA, WXGA, 1080p
Aspect ratio	Full, 4:3, 16:9, L.Box
Displayable colors	16.7 million colors
Projection lens	F = 1.9, f = 8.02 mm , manual focus
Projection screen size (diagonal)	25" (63cm) ~ 100" (254cm)
Projection distance	1.4' (0.4m) ~ 5.7' (1.7m)
Throw ratio	100" @ 1.72m (0.80 ~ 0.80:1)
Horizontal scan rate	30 k - 100 kHz
Vertical refresh scan rate	50 - 120 Hz
Keystone correction	+/- 20 degrees
Audio	Internal speaker with 3W x 2 output
Bluetooth Headset Audio	<ul style="list-style-type: none"> • BT3.0 + EDR audio transmitter. • Completely backward-compatible with BT1.1, 1.2, 2.0, 2.1 systems
Weight	1kg (2.2 lbs)
Dimensions (W x D x H)	240 mm x 147 mm x 59 mm (9.45" x 5.79" x 2.32")
Power supply	100V~240V AC to DC 19V 4.74A Adapter, 50-60 Hz
Battery capacity	<ul style="list-style-type: none"> • 11,412mAh (451P), 43W • Max. 3 Hrs @ movie mode with HDMI cable; Max. 1.5 Hrs @ standard mode with HDMI cable.
USB output rating	5V/1A
Power consumption (AC Adapter)	<ul style="list-style-type: none"> • Normal mode: 80 W +/- 10 % @ 110V AC (Bright mode @ full power) • ECO mode: 38W +/- 10 % @ 110V AC (Movie mode @ eco power) • Standby < 0.5 W
Operating temperature	5 °C to 40 °C / 41 °F to 104 °F

I/O connectors

- DC input x1
- USB x 1
- Audio In x1
- HDMI (MHL) x1
- VGA IN x1
- Audio Out x1
- Micro SD x1
- RJ45 Lan Input x1
- Wireless Projection Kit x1
- DC 5V Output x1

Standard package contents

- Power cord x1
 - AC to DC power adapter
 - VGA cable x1
 - Remote control x1
 - Battery x1 (for remote control) (option)
 - User's Guide (CD-ROM) x1
 - User's guide (CD-ROM) x1 (for multi-media and wireless functions)
 - Quick start guide x1
 - Quick start guide x1 (for multi-media and wireless functions)
 - Carrying case x1
 - USB WiFi adapter x1
 - HDMI cable x1 (option)
-

* Design and specifications are subject to change without notice.

Display Mode and Battery Capacity

Referenced Operating Scenarios	Movie Mode (Display Hours)	Standard Mode (Display Hours)
Display a movie by DVD player via HDMI port	3.0hrs	1.5hrs
Local play USB flash thumb content	2.5hrs	1.2hrs
Connect ChromeCast (display videos via Youtube)	2.5hrs	1.2hrs
Source "LAN/WiFi" and do wireless projection via mobile	2.5hrs	1.2hrs



Note 1: The above table is based on battery mode (without plugging power adapter).

Note 2: The above table is at maximum volume and USB WiFi is active. Battery status is from full to end.

Note 3: The battery capacity will be decreased by longer time and more recycling times. The above table is for reference only.

Note 4: Keep the power more than 30% always for better cell life.

Note 5: Full recharge the power bank at least every 3 months.

Note 6: For 1ST time usage, please plug in DC power to recharge battery 8hrs.

Compatibility modes

A. VGA Analog

1 VGA Analog - PC Signal

Modes	Resolution	V.Frequency [Hz]	H.Frequency [KHz]
VGA	640x480	60	31.5
	640x480	75	37.5
SVGA	800x600	56	35.1
	800x600	60	37.9
	800x600	75	46.9
	800x600	120	77.4
XGA	1024x768	60	48.4
	1024x768	70	56.5
	1024x768	75	60.0
	1024x768	120	99.0
SXGA	1152x864	75	67.5
	1280x1024	60	64.0
	1280x1024	75	80.0
QuadVGA	1280x960	60	60.0
	1280x960	75	75.2
SXGA+	1400x1050	60	65.3
PowerBook G4	640x480	60	31.4
PowerBook G4	640x480	66.6 (67)	34.9
PowerBook G4	800x600	60	37.9
PowerBook G4	1024x768	60	48.4
PowerBook G4	1152x870	75	68.7
PowerBook G4	1280x960	75	75.0
i Mac DV (G3)	1024x768	75	60.0

2 VGA Analog - Extended Wide timing

Modes	Resolution	V.Frequency [Hz]	H.Frequency [KHz]
WXGA	1280x768	60	47.8
	1280x768	75	60.3
	1280x720	60	44.8
	1280x800	60	49.6
	1280x800	120	101.5
WSXGA+	1440x900	60	59.9
	1680x1050	60	65.3
	1920x1080 (Reduced Blanking Timing)	60	66.6
	1366x768	60	47.7

3 VGA Analog - Component Signal

Modes	Resolution	V.Frequency [Hz]	H.Frequency [KHz]
480i	720x480	59.94(29.97)	15.7
576i	720x576	50(25)	15.6
480p	720x480	59.94	31.5
576p	720x576	50	31.3
720p	1280x720	60	45.0
720p	1280x720	50	37.5
1080i	1920x1080	60 (30)	33.8
1080i	1920x1080	50 (25)	28.1
1080p	1920x1080	23.97/24	27.0
1080p	1920x1080	60	67.5
1080p	1920x1080	50	56.3

B. HDMI Digital

1 HDMI - PC Signal

Modes	Resolution	V.Frequency [Hz]	H.Frequency [KHz]
VGA	640x480	60	31.5
	640x480	75	37.5
SVGA	800x600	56	35.1
	800x600	60	37.9
	800x600	75	46.9
	800x600	120	77.4
XGA	1024x768	60	48.4
	1024x768	70	56.5
	1024x768	75	60.0

	1024x768	120	99.0
SXGA	1152x864	70	63.8
	1152x864	75	67.5
	1280x1024	60	64.0
	1280x1024	75	80.0
QuadVGA	1280x960	60	60.0
SXGA+	1400x1050	60	65.3
PowerBook G4	640x480	60	31.4
PowerBook G4	640x480	66.6 (67)	34.9
PowerBook G4	800x600	60	37.9
PowerBook G4	1024x768	60	48.4
PowerBook G4	1152x870	75	68.7
i Mac DV (G3)	1024x768	75	60.0

2 HDMI - Extended Wide timing

Modes	Resolution	V.Frequency [Hz]	H.Frequency [KHz]
WXGA	1280x768	60	47.8
	1280x768	75	60.3
	1280x720	60	44.8
	1280x800	60	49.6
	1280x800	120	101.5
	1440x900	60	59.9
WSXGA+	1680x1050	60	65.3
	1920x1080 (Reduced Blanking Timing)	60	66.6
	1366x768	60	47.7

3 HDMI - Video Signal

Modes	Resolution	V.Frequency [Hz]	H.Frequency [KHz]
480i	720x480(1440x480)	59.94 (29.97)	15.7
576i	720x576(1440x576)	50 (25)	15.6
480p	720x480	59.94	31.5
576p	720x576	50	31.3
720p	1280x720	60	45.0
720p	1280x720	50	37.5
1080i	1920x1080	60 (30)	33.8
1080i	1920x1080	50 (25)	28.1
1080p	1920x1080	23.97/24	27.0
1080p	1920x1080	60	67.5
1080p	1920x1080	50	56.3
Graphic source monitor range limits	Horizontal scan rate:	30k~102kHz	
	Vertical scan rate:	50~120Hz	
	Max. pixel rate	150MHz	

Regulations and safety notices

FCC notice

This device has been tested and found to comply with the limits for a Class B digital device pursuant to Part 15 of the FCC rules. These limits are designed to provide reasonable protection against harmful interference in a residential installation. This device generates, uses, and can radiate radio frequency energy and, if not installed and used in accordance with the instructions, may cause harmful interference to radio communications.

However, there is no guarantee that interference will not occur in a particular installation. If this device does cause harmful interference to radio or television reception, which can be determined by turning the device off and on, the user is encouraged to try to correct the interference by one or more of the following measures:

- Reorient or relocate the receiving antenna.
- Increase the separation between the device and receiver.
- Connect the device into an outlet on a circuit different from that to which the receiver is connected.
- Consult the dealer or an experienced radio/television technician for help.

Notice: Shielded cables

All connections to other computing devices must be made using shielded cables to maintain compliance with FCC regulations.

Notice: Peripheral devices

Only peripherals (input/output devices, terminals, printers, etc.) certified to comply with the Class B limits may be attached to this equipment. Operation with non-certified peripherals is likely to result in interference to radio and TV reception.

Caution

Changes or modifications not expressly approved by the manufacturer could void the user's authority, which is granted by the Federal Communications Commission, to operate this device.

Operation conditions

This device complies with Part 15 of the FCC Rules. Operation is subject to the following two conditions: (1) this device may not cause harmful interference, and (2) this device must accept any interference received, including interference that may cause undesired operation.

Radiation Exposure Statement:

This equipment complies with FCC radiation exposure limits set forth for an uncontrolled environment. This equipment should be installed and operated with minimum distance 20cm between the radiator & your body.

Notice: Canadian users

This Class B digital apparatus complies with Canadian ICES-003.

Remarque à l'intention des utilisateurs canadiens

Cet appareil numérique de la classe B est conforme à la norme NMB-003 du Canada.

Declaration of Conformity for EU countries

Acer hereby declares that this projector series is in compliance with the essential requirements and other relevant provisions of Directive 1999/5/EC.

Compliant with Russian regulatory certification



Radio device regulatory notice



Note: The regulatory information below is for models with wireless LAN and/or Bluetooth only.

General

This product complies with the radio frequency and safety standards of any country or region in which it has been approved for wireless use. Depending on configurations, this product may or may not contain wireless radio devices (such as wireless LAN and/or Bluetooth modules).

Canada — Low-power license-exempt radio communication devices (RSS-210)

- a Common information
 - Operation is subject to the following two conditions:
 1. This device may not cause interference, and
 2. This device must accept any interference, including interference that may cause undesired operation of the device.
- b Operation in 2.4 GHz band
 - To prevent radio interference to the licensed service, this device is intended to be operated indoors and installation outdoors is subject to licensing.

List of applicable countries

This device must be used in strict accordance with the regulations and constraints in the country of use. For further information, please contact the local office in the country of use. Please see <http://ec.europa.eu/enterprise/rte/implem.htm> for the latest country list.



Acer Incorporated
8F, 88, Sec. 1, Xintai 5th Rd., Xizhi
New Taipei City 221, Taiwan

Declaration of Conformity

We,

Acer Incorporated

8F, 88, Sec. 1, Xintai 5th Rd., Xizhi, New Taipei City 221, Taiwan

Contact Person: Mr. RU Jan, e-mail: ru.jan@acer.com

And,

Acer Italy s.r.l

Via Lepetit, 40, 20020 Lainate (MI) Italy

Tel: +39-02-939-921 ,Fax: +39-02 9399-2913

www.acer.it

Declare under our own responsibility that the product:

Product:	DLP Projector
Trade Name:	Acer
Model Number:	CWX1510 K138STI/L224R/LK-W16F

To which this declaration refers conforms to the relevant standard or other standardizing documents:

- EN55022:2010 Class B; EN 55024:2010
- EN61000-3-2:2006+A1:2009+A2:2009, Class A
- EN61000-3-3:2008
- EN 60950-1:2006/A11:2009/A1:2010+A12:2011
- Regulation (EC) No. 1275/ 2008; EN 62301:2005
- Regulation (EC) No. 278/2009; EN 50563:2011
- EN50581:2012

We hereby declare above product is in compliance with the essential requirements and other relevant provisions of EMC Directive 2004/108/EC, Low Voltage Directive 2006/95/EC and RoHS Directive 2011/65/EU and Directive 2009/125/EC with regard to establishing a framework for the setting of ecodesign requirements for energy-related product.

Year to begin affixing CE marking 2015.

RU Jan / Sr. Manager
Regulation, Acer Inc.

Sep. 1, 2015
Date



Acer America Corporation
333 West San Carlos St.,
Suite 1500
San Jose, CA 95110
U. S. A.
Tel: 254-298-4000
Fax: 254-298-4147
www.acer.com



Federal Communications Commission Declaration of Conformity

This device complies with Part 15 of the FCC Rules. Operation is subject to the following two conditions: (1) this device may not cause harmful interference, and (2) this device must accept any interference received, including interference that may cause undesired operation.

The following local Manufacturer / Importer is responsible for this declaration:

Product:	DLP Projector
Model Number:	CWX1510
Machine Type:	K138STi/L224R/LK-W16F
Name of Responsible Party:	Acer America Corporation
Address of Responsible Party:	333 West San Carlos St. Suite 1500 San Jose, CA 95110 U. S. A.
Contact Person:	Acer Representative
Phone No.:	254-298-4000
Fax No.:	254-298-4147

Free Manuals Download Website

<http://myh66.com>

<http://usermanuals.us>

<http://www.somanuals.com>

<http://www.4manuals.cc>

<http://www.manual-lib.com>

<http://www.404manual.com>

<http://www.luxmanual.com>

<http://aubethermostatmanual.com>

Golf course search by state

<http://golfingnear.com>

Email search by domain

<http://emailbydomain.com>

Auto manuals search

<http://auto.somanuals.com>

TV manuals search

<http://tv.somanuals.com>