

Acer Projector

PL6610T/PL6610/PL6510/PL6310W/PL6210/
SL6610T/SL6610/SL6510/SL6310W/SL6210/
FL261T/FL261/FL251/FL221/FL211/FL261ST/
FL261S/FL251S/FL221S/FL211S/ LU-P500UT/
LU-P500U/LU-P500F/LU-P500W/ LU-P500X/
LU-S500UT/LU-S500U/LU-S500F/ LU-S500W/
LU-S500X/PF-L500UT/PF-L500U/ PF-L500F/
PF-L500W/PF-L500X/PS-L500UT/ PS-L500U/
PS-L500F/PS-L500W/PS-L500X/ LR660T/
LR660/LR560/LR360/LR260/LR660ST/ LR660S/
LR560S/LR360S/LR260S/ML-560B/ ML-560/
ML-460/ML-260/ML-160/ML-560SB/ ML-560S/
ML-460S/ML-260S/ML-160S/ DWU1846/
DWU1817/D1P1818/DWX1819/ DNX1820/
DWU1847/DWU1821/D1P1822/ DWX1823/
DNX1824

User's Guide

Copyright © 2018. Acer Incorporated.
All Rights Reserved.

Acer Projector User's Guide
Original Issue: 11/2018

Changes may be made periodically to the information in this publication without obligation to notify any person of such revisions or changes. Such changes will be incorporated in new editions of this manual or supplementary documents and publications. This company makes no representations or warranties, either expressed or implied, with respect to the contents hereof and specifically disclaims the implied warranties of merchantability or fitness for a particular purpose.

Record the model number, serial number, purchase date and place of purchase information in the space provided below. The serial number and model number are recorded on the label affixed to your projector. All correspondence concerning your unit should include the serial number, model number and purchase information.

No part of this publication may be reproduced, stored in a retrieval system, or transmitted, in any form or by any means, electronically, mechanically, by photocopy, recording or otherwise, without the prior written permission of Acer Incorporated.

Model number: _____

Serial number: _____

Date of purchase: _____

Place of purchase: _____

Acer and the Acer logo are registered trademarks of Acer Incorporated. Other companies' product names or trademarks are used herein for identification purposes only and belong to their respective companies.

HDMI™, the HDMI logo and High-Definition Multimedia Interface are trademarks or registered trademarks of HDMI Licensing LLC.



Information for your safety and comfort

Read these instructions carefully. Keep this document for future reference. Follow all warnings and instructions marked on the product.

Turning the product off before cleaning

Unplug this product from the wall outlet before cleaning. Do not use liquid cleaners or aerosol cleaners. Use a damp cloth for cleaning.

Caution for plug as disconnecting device

Observe the following guidelines when connecting and disconnecting power to the external power supply unit:

- Install the power supply unit before connecting the power cord to the AC power outlet.
- Unplug the power cord before removing the power supply unit from the projector.
- If the system has multiple sources of power, disconnect power from the system by unplugging all power cords from the power supplies.

Caution for Accessibility

Be sure that the power outlet you plug the power cord into is easily accessible and located as close to the equipment operator as possible. When you need to disconnect power to the equipment, be sure to unplug the power cord from the electrical outlet.

Warning!

- Do not use this product near water.
- Do not place this product on an unstable cart, stand or table. If the product falls, it could be seriously damaged.
- Slots and openings are provided for ventilation to ensure reliable operation of the product and to protect it from overheating. These openings must not be blocked or covered. The openings should never be blocked by placing the product on a bed, sofa, rug or other similar surface.
- This product should never be placed near or over a radiator or heat register, or in a built-in installation unless proper ventilation is provided.
- Never push objects of any kind into this product through cabinet slots as they may touch dangerous voltage points or short-out parts that could result in a fire or electric shock. Never spill liquid of any kind onto or into the product.
- To avoid damage of internal components and to prevent battery leakage, do not place the product on a vibrating surface.
- Never use it under sporting, exercising, or any vibrating environment which will probably cause unexpected short current or damage rotor devices.

Using electrical power

- This product should be operated from the type of power indicated on the marking label. If you are not sure of the type of power available, consult your dealer or local power company.
- Do not allow anything to rest on the power cord. Do not locate this product where people will walk on the cord.
- If an extension cord is used with this product, make sure that the total ampere rating of the equipment plugged into the extension cord does not exceed the extension cord ampere rating. Also, make sure that the total rating of all products plugged into the wall outlet does not exceed the fuse rating.
- Do not overload a power outlet, strip or receptacle by plugging in too many devices. The overall system load must not exceed 80% of the branch circuit rating. If power strips are used, the load should not exceed 80% of the power strip's input rating.
- This product's AC adapter is equipped with a three-wire grounded plug. The plug only fits in a grounded power outlet. Make sure the power outlet is properly grounded before inserting the AC adapter plug. Do not insert the plug into a non-grounded power outlet. Contact your electrician for details.

 **Warning!** The grounding pin is a safety feature. Using a power outlet that is not properly grounded may result in electric shock and/or injury.

Note: *The grounding pin also provides good protection from unexpected noise produced by other nearby electrical devices that may interfere with the performance of this product.*

- Use the product only with the supplied power supply cord set. If you need to replace the power cord set, make sure that the new power cord meets the following requirements: detachable type, UL listed/CSA certified, VDE approved or its equivalent, 4.5 meters (15 feet) maximum length.

Product servicing

Do not attempt to service this product yourself, as opening or removing covers may expose you to dangerous voltage points or other risks. Refer all servicing to qualified service personnel.

Unplug this product from the wall outlet and refer servicing to qualified service personnel when:

- the power cord or plug is damaged, cut or frayed
- liquid was spilled into the product
- the product was exposed to rain or water
- the product has been dropped or the case has been damaged
- the product exhibits a distinct change in performance, indicating a need for service
- the product does not operate normally after following the operating instructions

Note: *Adjust only those controls that are covered by the operating instructions, since improper adjustment of other controls may result in damage and will often require extensive work by a qualified technician to restore the product to normal condition.*

 **Warning!** For safety reasons, do not use non-compliant parts when adding or changing components. Consult your reseller for purchase options.

Your device and its enhancements may contain small parts. Keep them out of the reach of small children.

Additional safety information

- Do not look into the projector's lens when the light is on. The bright may hurt your eyes.
- Turn on the projector first and then signal sources
- Do not place the product in following environments:
 - Space that is poorly ventilated or confined. At least 50cm clearance from walls and free flow of air around the projector is necessary.
 - Locations where temperatures may become excessively high, such as inside of a car with all windows rolled up.
 - Locations where excessive humidity, dust, or cigarette smoke may contaminate optical components, shortening the life span and darkening the image.
 - Locations near fire alarms.
 - Locations with an ambient temperature above 40°C / 104°F.
 - Locations where the altitudes are higher than 10000 feet.
- Unplug immediately if there is something wrong with your projector. Do not operate if smoke, strange noise or odor comes out of your projector. It might cause fire or electric shock. In this case, unplug immediately and contact your dealer.
- Do not keep using this product to break or drop it. In this case contact your dealer for inspection.
- Do not face the projector lens to the sun. It can lead to fire.
- When switching the projector off, suggest to ensure the projector completes its cooling cycle before disconnecting power.
- Do not frequently turn off the main power abruptly or unplug the projector during operation. The best way is to wait for the fan to turn off before turning main power off.
- Do not touch air outlet grille and bottom plate which becomes hot.
- Do not look into the air outlet grille when projector is operating. It may hurt your eyes.
- Always open the lens shutter or remove the lens cap when the projector is on.
- Do not block the projector lens with any object when the projector is under operation as this could cause the object to become heated and deformed or even cause a fire.
- Do not attempt to disassemble this projector. There are dangerous high voltages inside which may hurt you. Refer servicing only to suitable qualified professional service personnel.
- Do not stand the projector on end vertically. It may cause the projector to fall over, causing injury or damage.
- 360° projection capability

Images can be projected over a full 360° range along the vertical axis, including reproduction on a ceiling or floor.

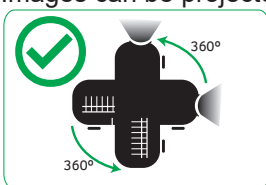

Note: *The brightness will be reduced 70% when the projection direction is downward.*

Portrait projection

Do not use the projector with it leaning to the left and right. This may result in a malfunction, however, portrait installation is possible.



Note:

- Please do not install the projector in a vertical orientation on the top of the floor or table on its own. The intake vent may be obstructed, resulting in the projector getting warm and the possibility of fire and malfunction occurring.
- When operating the projector in an enclosed space, allow at least 50 cm clearance around the intake and exhaust vents.

Caution for Listening

To protect your hearing, follow these instructions.

- Increase the volume gradually until you can hear clearly and comfortably.
- Do not increase the volume level after your ears have adjusted.
- Do not listen to music at high volumes for extended periods.
- Do not increase the volume to block out noisy surroundings.
- Decrease the volume if you can't hear people speaking near you.

Disposal instructions

Do not throw this electronic device into the trash when discarding. To minimize pollution and ensure utmost protection of the global environment, please recycle. For more information on the Waste from Electrical and Electronics Equipment (WEEE) regulations, visit <http://www.acer-group.com/public/Sustainability/sustainability01.htm>



Do not stare into the beam

Complies with 21 CFR 1040.10 and 1040.11 as a Risk Group 2, LIP (Laser Illuminated Projector) as defined in IEC 62471:2006 except for deviations pursuant to Laser Notice No. 50, dated June 24, 2007

| IEC 60825-1:2014 CLASS 1 LASER PRODUCT RISK GROUP 2 | IEC 60825-1:2014 PRODUIT LASER DE CLASSE 1 GROUPE DE RISQUE 2 | IEC 60825-1:2014 1類激光產品 危險組2 | IEC 60825-1:2014 1등급 레이저 제품 위험 그룹 2 | IEC 60825-1:2014 クラス1レーザー製品 リスクグループ2 |
|--|--|--|--|--|
| CAUTION Possibly hazardous optical radiation emitted from this product. Do not stare at beam. May be harmful to the eye. | AVERTISSEMENT Radiation optique à danger potentiel émise par ce produit. Ne regardez pas directement le faisceau laser. Ceci pourrait être nocif pour votre œil. | 注意 此產品可能會產生危險光輻射。請勿直視操作光束，以免對眼睛損害。 | 주의 이 제품으로부터 인체에 위험한 광선이 방사될 수 있음. 광원을 정면으로 바라보지 마시오. 눈에 심각한 손상을 입을 수 있음. | 注意 本製品より危険となりうる光放射あり。ビームをのぞき込まないこと。眼に有害となる可能性あり。 |

Do not stare into beam, RG2

As with any bright source, do not stare into the direct beam, RG2 IEC 62471-5:2015.



First things first

Usage Notes

Do:

- Turn off the product before cleaning.
- Use a soft cloth moistened with mild detergent to clean the displayhousing.
- Disconnect the power plug from AC outlet if the product is not being used for a long period of time.

Don't:

- Block the slots and openings on the unit provided for ventilation.
- Use abrasive cleaners, waxes or solvents to clean the unit.
- Use under the following conditions:
 - In extremely hot, cold or humid environments.
 - In areas susceptible to excessive dust and dirt.
 - Near any appliance that generates a strong magnetic field.
 - Place In direct sunlight.

Precautions

Follow all warnings, precautions and maintenance as recommended in this user's guide to maximize the life of your unit.

Warning!

- Do not look into the projector's lens when the light is on. The bright may hurt your eyes.
- To reduce the risk of fire or electric shock, do not expose this product to rain or moisture.
- Please do not open or disassemble the product as this may cause electric shock.
- When switching the projector off, please ensure the projector completes its cooling cycle before disconnecting power.
- Turn on the projector first and then the signal sources.
- Do not use lens cap when projector is in operation.

TABLE OF CONTENTS

| | |
|---|-----------|
| INTRODUCTION | 9 |
| <i>Package Overview.....</i> | 9 |
| <i>Standard accessories.....</i> | 9 |
| <i>Optional accessories.....</i> | 9 |
| <i>Product Overview.....</i> | 10 |
| <i>Connections.....</i> | 11 |
| <i>Keypad.....</i> | 12 |
| <i>Remote control.....</i> | 13 |
| SETUP AND INSTALLATION..... | 14 |
| <i>Installing the projector.....</i> | 14 |
| <i>Connecting sources to the projector.....</i> | 16 |
| <i>Adjusting the projector image.....</i> | 18 |
| <i>Remote setup.....</i> | 19 |
| USING THE PROJECTOR | 21 |
| <i>Powering on / off the projector.....</i> | 21 |
| <i>Selecting an input source.....</i> | 22 |
| <i>Menu navigation and features.....</i> | 23 |
| <i>OSD Menu tree.....</i> | 24 |
| <i>Display image settings menu.....</i> | 31 |
| <i>Display 3D menu.....</i> | 33 |
| <i>Display aspect ratio menu.....</i> | 34 |
| <i>Display edge mask menu.....</i> | 37 |
| <i>Display zoom menu.....</i> | 37 |
| <i>Display image shift menu.....</i> | 37 |
| <i>Display geometric correction menu.....</i> | 37 |
| <i>Audio mute menu.....</i> | 38 |
| <i>Audio volume menu.....</i> | 38 |
| <i>Audio audio input menu.....</i> | 38 |
| <i>Audio audio/mic input function menu.....</i> | 38 |
| <i>Setup projection menu.....</i> | 39 |
| <i>Setup screen type menu.....</i> | 39 |
| <i>Setup power settings menu.....</i> | 39 |
| <i>Setup security menu.....</i> | 39 |
| <i>Setup HDMI Link settings menu.....</i> | 40 |
| <i>Setup HDBaseT control menu.....</i> | 40 |
| <i>Setup options menu.....</i> | 41 |
| <i>Screen capture by PC tool.....</i> | 41 |
| <i>Setup reset OSD menu.....</i> | 42 |
| <i>Network LAN menu.....</i> | 43 |
| <i>Network control menu.....</i> | 44 |
| <i>Setup network control settings menu.....</i> | 45 |
| <i>Info menu.....</i> | 48 |

ADDITIONAL INFORMATION..... 49

Compatible resolutions 49
Image size and projection distance 52
Projector dimensions and ceiling mount installation..... 55
Troubleshooting 56
Warning indicators..... 57
Specifications 59

INTRODUCTION

Package Overview

Carefully unpack and verify that you have the items listed below under standard accessories. Some of the items under optional accessories may not be available depending on the model, specification and your region of purchase. Please check with your place of purchase. Some accessories may vary from region to region.

The warranty card is only supplied in some specific regions. Please consult your dealer for detailed information.

Standard accessories

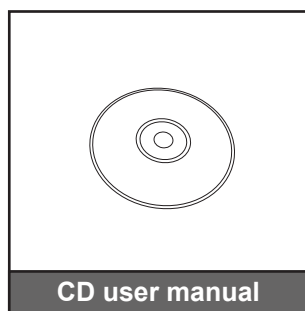
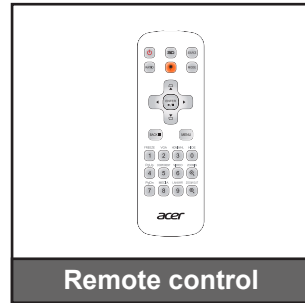

Optional accessories

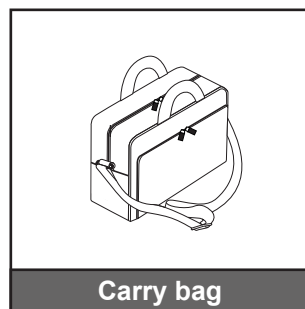

Note:

- *Optional accessories vary depending on model, specification and region.*

INTRODUCTION

Product Overview



Note:

- Do not block projector intake and exhaust vents.
- When operating the projector in an enclosed space, allow at least 50 cm clearance around the intake and exhaust vents.

| No. | Item | No. | Item |
|-----|---------------------|-----|-----------------------|
| 1. | IR Receivers | 7. | Ventilation (outlet) |
| 2. | Keypad | 8. | Tilt-Adjustment Feet |
| 3. | Lens Shift Dial | 9. | Kensington™ Lock Port |
| 4. | Ventilation (inlet) | 10. | Input / Output |
| 5. | Zoom Lever | 11. | Power Socket |
| 6. | Focus Ring | 12. | Lens |

INTRODUCTION

Connections



| No. | Item | 14 IO | 15 IO |
|-----|-------------------------------------|-------|-------|
| 1. | HDMI 2 (v1.4) Connector | √ | √ |
| 2. | HDMI 1(v2.0)(4K) / MHL Connector | √ | √ |
| 3. | USB Power Out (5V---1.5A) Connector | √ | √ |
| 4. | VGA In / VGA In 1 Connector | √ | √ |
| 5. | Composite Connector | √ | √ |
| 6. | Audio In 1 / Microphone Connector | √ | √ |
| 7. | Kensington™ Lock Port | √ | √ |
| 8. | Audio Out Connector | √ | √ |
| 9. | Audio In 2 Connector | √ | √ |
| 10. | VGA Out Connector | √ | √ |
| 11. | RS232 Connector | √ | √ |
| 12. | RJ-45 Connector | √ | √ |
| 13. | Power Socket | √ | √ |
| 14. | VGA In 2 Connector | √ | √ |
| 15. | S-Video Connector | √ | √ |
| 16. | HDBaseT Connector | N/A | √ |

Note: “√” means the item is supported, “N/A” means the item is not available.

INTRODUCTION

Keypad



| No. | Item | No. | Item |
|-----|------------------------------|-----|---------------------|
| 1. | Power LED | 7. | Menu |
| 2. | Lamp LED | 8. | Keystone Correction |
| 3. | Temp LED | 9. | Information |
| 4. | Power | 10. | Enter |
| 5. | Source | 11. | Re-Sync |
| 6. | Four directional select keys | | |

INTRODUCTION

Remote control



| No. | Item | No. | Item |
|-----|------------------------------|-----|---------------------------|
| 1. | Infrared transmitter | 14. | PgUp (not supported) |
| 2. | POWER | 15. | COMPONENT (not supported) |
| 3. | Laser button | 16. | PgDn (not supported) |
| 4. | RATIO | 17. | MEDIA (not supported) |
| 5. | Select/Enter Play/Pause | 18. | Keypad 0~9 |
| 6. | Four directional select keys | 19. | MENU |
| 7. | 3D | 20. | HDMI™/MHL |
| 8. | SOURCE | 21. | HIDE |
| 9. | MODE | 22. | ZOOM IN |
| 10. | KEYSTONE | 23. | VIDEO |
| 11. | BACK STOP | 24. | ZOOM OUT |
| 12. | VGA | 25. | LAN/WiFi (not supported) |
| 13. | FREEZE | 26. | Laser pointer |

Note: Some keys may have no function for models that do not support these features.

SETUP AND INSTALLATION

Installing the projector

Your projector is designed to be installed in one of four possible positions.

Your room layout or personal preference will dictate which installation location you select. Take into consideration the size and position of your screen, the location of a suitable power outlet, as well as the location and distance between the projector and the rest of your equipment.

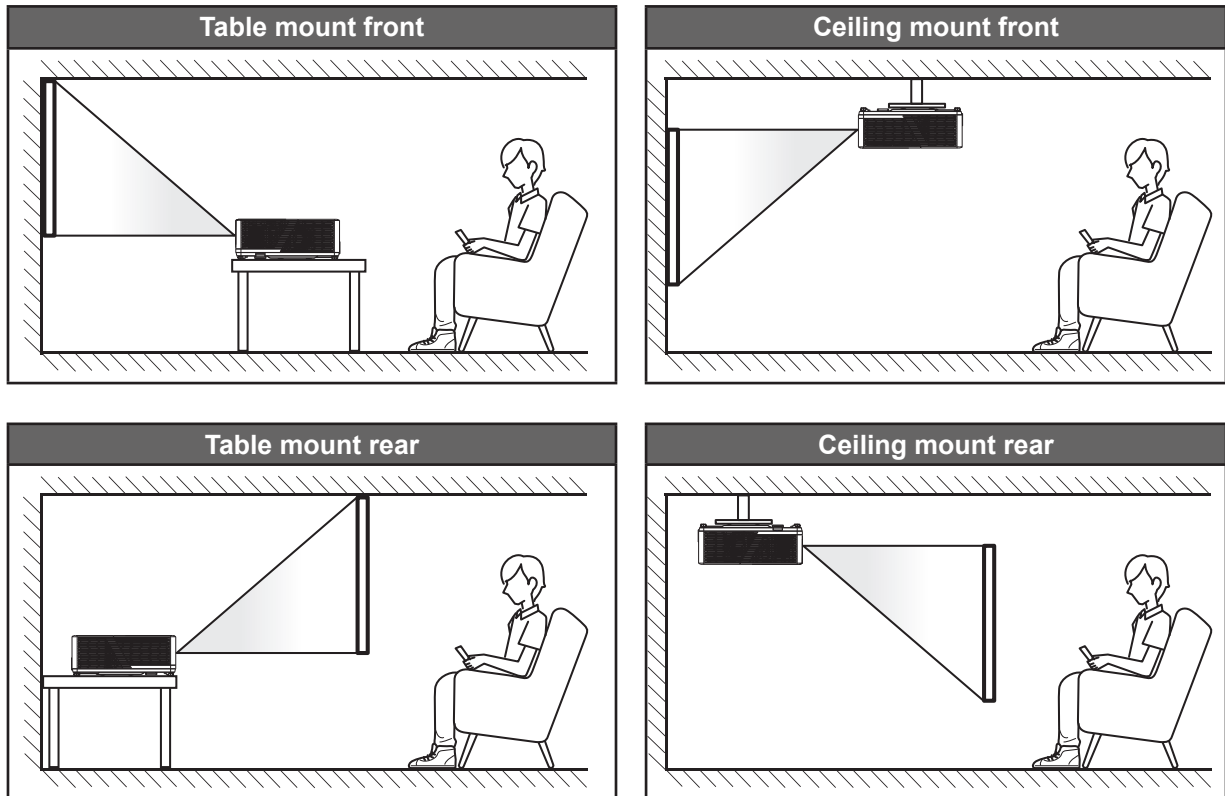

Projector should be placed flat on a surface and 90 degrees / perpendicular to the screen.

- How to determine projector location for a given screen size, please refer to distance table on pages 52-54.
- How to determine screen size for a given distance, please refer to distance table on pages 52-54.

Note: *The further away the projector is placed from the screen the projected image size increases and vertical offset also increases proportionally.*

IMPORTANT!

Do not operate the projector in any orientation other than table top or ceiling mount. The projector should be horizontal and not tilted either forwards/backwards or left/right. Any other orientation will invalidate the warranty and may shorten the lifetime of the projector light source or the projector itself. For non-standard installation advise please contact Acer.

SETUP AND INSTALLATION

Projector installation notice

- Place the projector in a horizontal position.
The tilt angle of the projector should not exceed 15 degrees, nor should the projector be installed in any way other than the desktop and ceiling mount and may lead to other **unpredictable damages**.

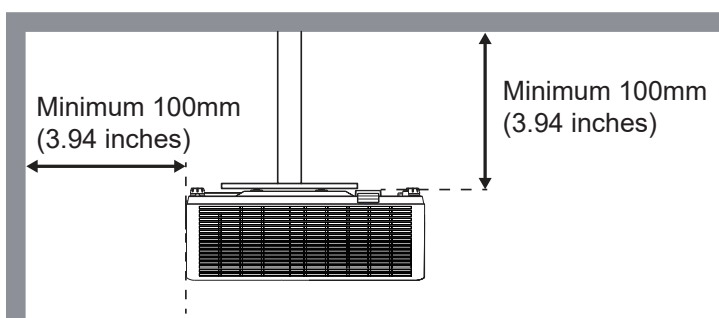
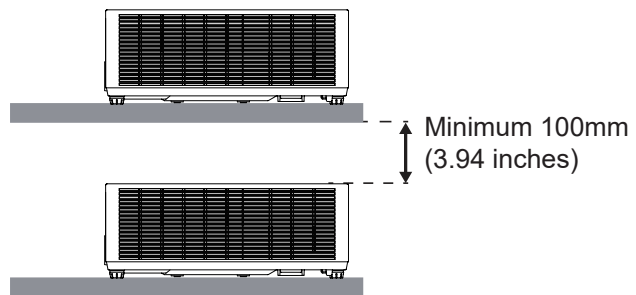
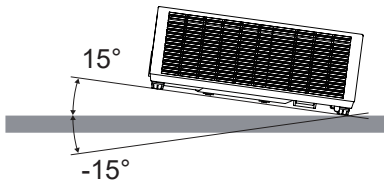

- Ensure that the intake vents do not recycle hot air from the exhaust vent.
- When operating the projector in an enclosed space, ensure that the surrounding air temperature within the enclosure does not exceed operation temperature while the projector is running, and the air intake and exhaust vents are unobstructed.
- All enclosures should pass a certified thermal evaluation to ensure that the projector does not recycle exhaust air, as this may cause the device to shutdown even if the enclosure temperature is within the acceptable operation temperature range.

SETUP AND INSTALLATION

Connecting sources to the projector

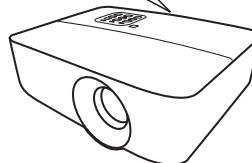
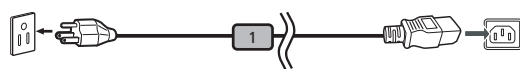
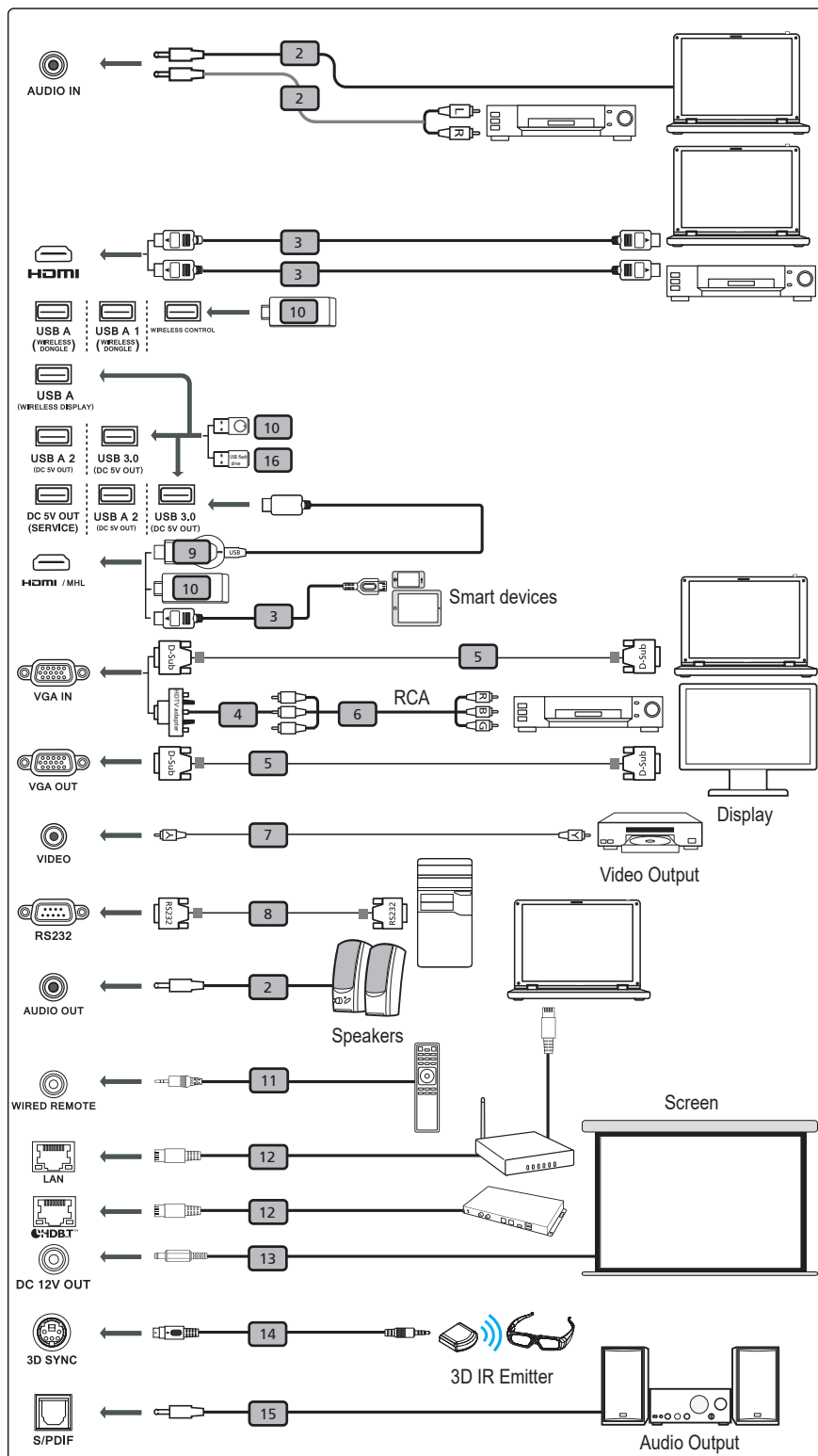

SETUP AND INSTALLATION

| # | Description |
|----|-------------------------------|
| 1 | Power cord |
| 2 | Audio cable |
| 3 | HDMI (MHL) cable |
| 4 | VGA to component/HDTV adapter |
| 5 | VGA cable |
| 6 | 3 RCA component cable |
| 7 | Composite video cable |
| 8 | RS232 cable |
| 9 | WirelessHD dongle |
| 10 | Wireless dongle |
| 11 | Wireless remote control |
| 12 | LAN cable |
| 13 | 12V DC cable |
| 14 | 3D SYNC cable |
| 15 | SPDIF cable |
| 16 | USB flash drive |

Note:

- To ensure the projector works well with your computer, please make sure the timing of the display mode is compatible with the projector.
- Functions vary depending on model definition.
- USB cable needs powered extender if the length is over 5 m.
- USB DC 5V out connector support 5V power output for HDMI dongle charging.
- DC 12V out connector support 12V/100mA power for screen control only.

SETUP AND INSTALLATION

Adjusting the projector image

Image height

The projector is equipped with elevator feet for adjusting the image height.

1. Locate the adjustable foot you wish to adjust on the underside of the projector.
2. Rotate the adjustable foot clockwise or counterclockwise to raise or lower the projector.

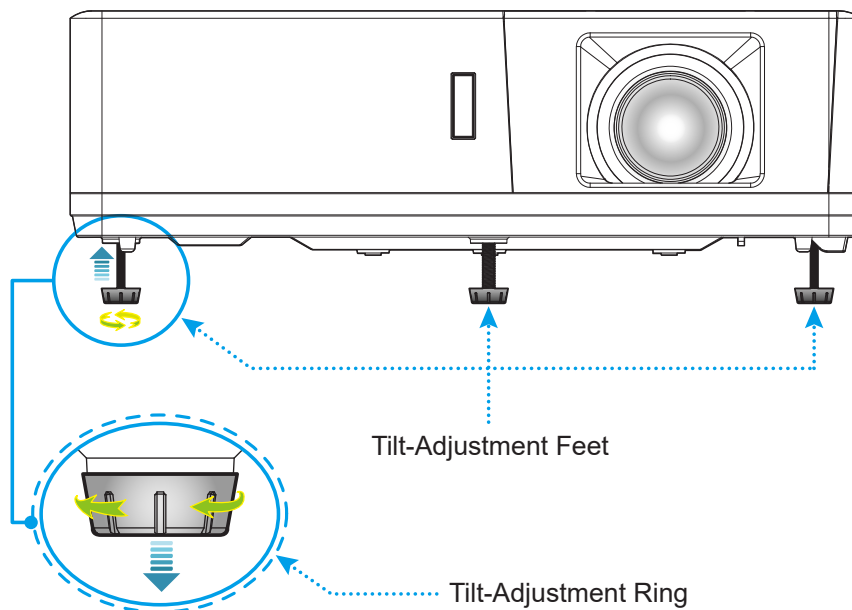

Zoom, lens shift, and focus

- To adjust the image size, turn the zoom lever clockwise or counterclockwise to increase or decrease the projected image size.
- To adjust the image position, turn the lens shift dial clockwise or counterclockwise to adjust the position of the projected image vertically.
- To adjust the focus, turn the focus ring clockwise or counterclockwise until the image is sharp and legible.



Note: Ensure that the projection screen is within the required distance from the projector. Please refer to "Image size and projection distance" for more information.

SETUP AND INSTALLATION

Remote setup

Installing / replacing the batteries

Two AAA size batteries are supplied for the remote control.

1. Remove the battery cover on the back of the remote control.
2. Insert AAA batteries in the battery compartment as illustrated.
3. Replace back cover on remote control.



Note: Replace only with the same or equivalent type batteries.

CAUTION

Improper use of batteries can result in chemical leakage or explosion. Be sure to follow the instructions below.

- Do not mix batteries of different types. Different types of batteries have different characteristics.
- Do not mix old and new batteries. Mixing old and new batteries can shorten the life of new batteries or cause chemical leakage in old batteries.
- Remove batteries as soon as they are depleted. Chemicals that leak from batteries that come in contact with skin can cause a rash. If you find any chemical leakage, wipe thoroughly with a cloth.
- The batteries supplied with this product may have a shorter life expectancy due to storage conditions.
- If you will not be using the remote control for an extended period of time, remove the batteries.
- When you dispose of the batteries, you must obey the law in the relative area or country.

SETUP AND INSTALLATION

Effective range

Infra-Red (IR) remote control sensor is located on the top and front sides of the projector. Ensure to hold the remote control at an angle within 40 degrees perpendicular to the projector's IR remote control sensor to function correctly. The distance between the remote control and the sensor should not be longer than 5 meters (16.4 feet).

- Make sure that there are no obstacles between the remote control and the IR sensor on the projector that might obstruct the infra-red beam.
- Make sure the IR transmitter of the remote control is not being shined by sunlight or fluorescent lamps directly.
- Please keep the remote controller away from fluorescent lamps for over 2 m or the remote controller might become malfunction.
- If the remote control is close to Inverter-Type fluorescent lamps, it might become ineffective from time to time.
- If the remote control and the projector are within a very short distance, the remote control might become ineffective.
- When you aim at the screen, the effective distance is less than 5 m from the remote control to the screen and reflecting the IR beams back to the projector. However, the effective range might change according to screens.



USING THE PROJECTOR

Powering on / off the projector



Powering on

1. Remove the lens cap.
2. Securely connect the power lead and signal/source cable. When connected, the Power LED will turn red.
3. Turn on the projector by pressing the \cup button on the projector keypad or remote control.
4. A start up screen will display in approximately 10 seconds and the Power LED will turn blue.

Note: The first time the projector is turned on, you will be prompted to select the preferred language, projection orientation, and other settings.

Powering off

1. Turn off the projector by pressing the \cup button on the projector keypad or remote control.
2. The following message will be displayed:



3. Press the \cup button again to confirm, otherwise the message will disappear after 10 seconds. When you press the \cup button for the second time, the projector will shut down.
4. When the Power turns solid red, this indicates the projector has entered standby mode. If you wish to turn the projector back on, you must wait until the cooling cycle has finished and the projector has entered standby mode. When the projector is in standby mode, simply press the \cup button again to turn on the projector.
5. Disconnect the power lead from the electrical outlet and the projector.

Note: It is not recommended that the projector is turned on immediately, right after a power off procedure.

USING THE PROJECTOR

Selecting an input source

Turn on the connected source that you want to display on the screen, such as computer, notebook, video player, etc. The projector will automatically detect the source. If multiple sources are connected, press the  button on the projector keypad or the **Source** button on the remote control to select the desired input.

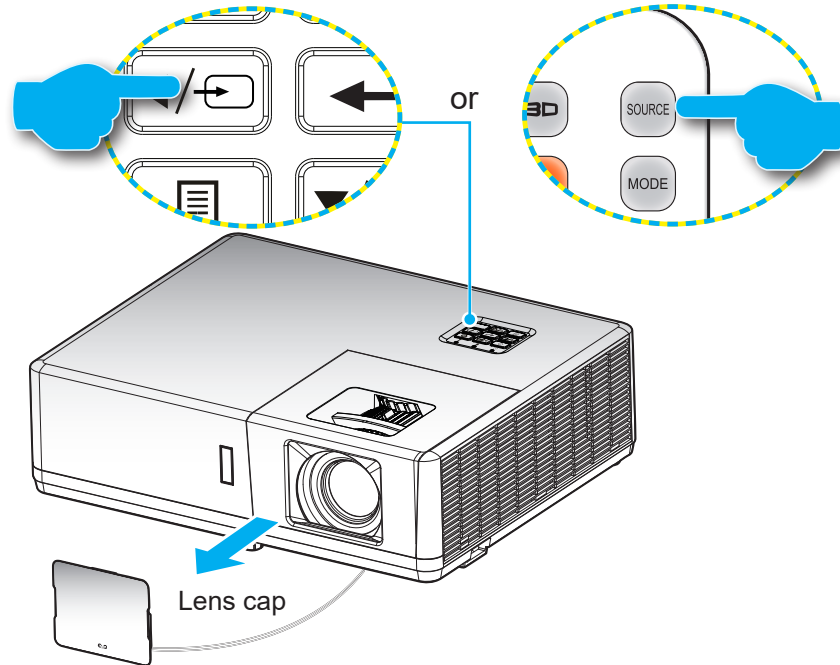

USING THE PROJECTOR

Menu navigation and features

The projector has multilingual on-screen display menus that allow you to make image adjustments and change a variety of settings. The projector will automatically detect the source.

1. To open the OSD menu, press the  button on the projector keypad or the **Menu** button on the remote control.
2. When OSD is displayed, use **▲▼** keys to select any item in the main menu. While making a selection on a particular page, press the **←** button on the projector keypad or the **Enter** button on the remote control to enter sub menu.
3. Use **◀▶** keys to select the desired item in the sub menu and then press the **←** or **Enter** button to view further settings. Adjust the settings by using **◀▶** keys.
4. Select the next item to be adjusted in the sub menu and adjust as described above.
5. Press press the **←** or **Enter** button to confirm, and the screen will return to the main menu.
6. To exit, press the  or **Menu** button again. The OSD menu will close and the projector will automatically save the new settings.



USING THE PROJECTOR

OSD Menu tree

| Main Menu | Sub Menu | Sub Menu 2 | Sub Menu 3 | Sub Menu 4 | Values | | | |
|-----------|----------------|--------------|------------|----------------|-------------------|---------------|----------|----------|
| Display | Image Settings | Display Mode | | | Presentation | | | |
| | | | | | Bright | | | |
| | | | | | HDR SIM. | | | |
| | | | | | Cinema | | | |
| | | | | | Game | | | |
| | | | | | sRGB | | | |
| | | | | | DICOM SIM. | | | |
| | | | | | User | | | |
| | | | | 3D | | | | |
| | | | Wall Color | | | Off [Default] | | |
| | | | | | | Blackboard | | |
| | | | | | | Light Yellow | | |
| | | | | | | Light Green | | |
| | | | | | | Light Blue | | |
| | | | | | | Pink | | |
| | | | | | Gray | | | |
| | | | | Brightness | | | -50 ~ 50 | |
| | | | | Contrast | | | -50 ~ 50 | |
| | | | | Sharpness | | | 1 ~ 15 | |
| | | | | Color | | | -50 ~ 50 | |
| | | | | Tint | | | -50 ~ 50 | |
| | | | | Gamma | Film | | | |
| | | | | | Video | | | |
| | | | | | Graphics | | | |
| | | | | | Standard(2.2) | | | |
| | | | | | 1.8 | | | |
| | | | | | 2.0 | | | |
| | | | | | 2.4 | | | |
| | | | | 2.6 | | | | |
| | | | | Color Settings | BrilliantColor™ | | 1 ~ 10 | |
| | | | | | Color Temperature | | | Warm |
| | | | | | | | | Standard |
| | | | | | | Cool | | |
| | | | | Cold | | | | |

USING THE PROJECTOR

| Main Menu | Sub Menu | Sub Menu 2 | Sub Menu 3 | Sub Menu 4 | Values | |
|-----------------|----------------|---|---|-------------------|-----------------------|---|
| Display | Image Settings | Color Settings | Color Matching | Color | Red [Default] | |
| | | | | | Green | |
| | | | | | Blue | |
| | | | | | Cyan | |
| | | | | | Yellow | |
| | | | | | Magenta | |
| | | | | | White(*) | |
| | | | | Hue / R(*) | -50 ~ 50 [Default: 0] | |
| | | | | Saturation / G(*) | -50 ~ 50 [Default: 0] | |
| | | | | Gain / B(*) | -50 ~ 50 [Default: 0] | |
| | | | Reset | Cancel [Default] | | |
| | | | | Yes | | |
| | | | Exit | | | |
| | | | RGB Gain/Bias | Red Gain | -50 ~ 50 | |
| | | | | Green Gain | -50 ~ 50 | |
| | | | | Blue Gain | -50 ~ 50 | |
| | | | | Red Bias | -50 ~ 50 | |
| | | | | Green Bias | -50 ~ 50 | |
| | | | | Blue Bias | -50 ~ 50 | |
| | | | | Reset | Cancel [Default] | |
| | | | | | Yes | |
| | | | Color Space [Not HDMI Input] | | Auto [Default] | |
| | | | | | RGB | |
| | | | | | YUV | |
| | | | Color Space [HDMI Input] | | Auto [Default] | |
| | | | | | RGB(0~255) | |
| | | | | | RGB(16~235) | |
| | | | | | YUV | |
| | | | Signal | Automatic | | Off |
| | | | | | | On [Default] |
| | | | | Frequency | | -10 ~ 10 (depends on signal) [Default: 0] |
| | | | | Phase | | 0~31 (depends on signal) [Default: 0] |
| | | | | H. Position | | -5 ~ 5 (depends on signal) [Default: 0] |
| V. Position | | -5 ~ 5 (depends on signal) [Default: 0] | | | | |
| Brightness Mode | | | DynamicBlack | | | |
| | | | Power (Power = 100%/ 95%/ 90%/ 85%/ 80%/ 75%/ 70%/ 65%/ 60%/ 55%/ 50%) | | | |
| Reset | | | | | | |

USING THE PROJECTOR

| Main Menu | Sub Menu | Sub Menu 2 | Sub Menu 3 | Sub Menu 4 | Values | | |
|---------------|----------------------|---|------------|-----------------------|-------------------------|---------------------|-------------------|
| Display | 3D | 3D Mode | | | Off [Default] | | |
| | | | | | DLP-Link | | |
| | | 3D → 2D | | | 3D [Default] | | |
| | | | | | L | | |
| | | | | | R | | |
| | | 3D Format | | | Auto [Default] | | |
| | | | | | SBS | | |
| | | | | | Top and Bottom | | |
| | | | | | Frame Sequential | | |
| | | 3D Sync Invert | | | On | | |
| | | | | Off [Default] | | | |
| | Aspect Ratio | | | 4:3 | | | |
| | | | | 16:9 | | | |
| | | | | 16:10 | | | |
| | | | | LBX | | | |
| | | | | Native | | | |
| | | | | Auto | | | |
| | Edge Mask | | | 0 ~ 10 [Default: 0] | | | |
| | Zoom | | | -5 ~ 25 | | | |
| | Image Shift | H  | | | -100 ~ 100 [Default: 0] | | |
| | | V  | | | -100 ~ 100 [Default: 0] | | |
| | Geometric Correction | Four Corners | | | | | |
| | | H Keystone | | | -30 ~ 30 [Default: 0] | | |
| V Keystone | | | | -30 ~ 30 [Default: 0] | | | |
| Auto Keystone | | | | Off | | | |
| Reset | | | | On [Default] | | | |
| Audio | Mute | | | | Off [Default] | | |
| | | | | | On | | |
| | Volume | | | | | 0 ~ 10 [Default: 5] | |
| | | | | | | | |
| | Audio Input | HDMI1/MHL | | | | Audio 1 | |
| | | | | | | Audio 2 | |
| | | | | | | Default [Default] | |
| | | HDMI2 | | | | | Audio 1 |
| | | | | | | | Audio 2 |
| | | | | | | | Default [Default] |
| | | VGA IN 1 | | | | | Audio 1 |
| | | | | | | | Audio 2 |
| | | VGA IN 2 | | | | | Audio 1 |
| | | | | | | | Audio 2 |
| S-VIDEO | | | | | Audio 1 | | |
| | | | | | Audio 2 | | |

USING THE PROJECTOR

| Main Menu | Sub Menu | Sub Menu 2 | Sub Menu 3 | Sub Menu 4 | Values | |
|--------------|--------------------------|-----------------------|------------|------------|---|--|
| Audio | Audio Input | VIDEO | | | Audio 1 | |
| | | | | | Audio 2 | |
| | | HDBaseT | | | Audio 1 | |
| | | | | | Audio 2 | |
| | | | | | Default | |
| | Audio/Mic Input Function | | | | Audio Input | |
| | | | | Mic | | |
| Setup | Projection | | | | Front  [Default] | |
| | | | | | Rear  | |
| | | | | | Ceiling-top  | |
| | | | | | Rear-top  | |
| | Screen Type | | | | 16:9 | |
| | | | | | 16:10 [Default] | |
| | Power Settings | Direct Power On | | | | Off [Default] |
| | | | | | | On |
| | | Signal Power On | | | | Off [Default] |
| | | | | | | On |
| | | Auto Power Off (min.) | | | | 0 ~ 180 (5 min increments) [Default: 20] |
| | | Power Mode (Standby) | | | | Active |
| | | | | | Eco [Default] | |
| | USB Power (Standby) | | | | Off [Default] | |
| | | | | | On | |
| | Security | Security | | | | Off [Default] |
| | | | | | | On |
| | | Security Timer | Month | | | |
| | | | Day | | | |
| | | | Hour | | | |
| | Change Password | | | | [Default: 1234] | |
| | HDMI CEC | | | | | Off [Default] |
| | | | | | | On |
| | HDBaseT Control | Ethernet | | | | Off [Default] |
| | | | | | | On |
| | | RS232 | | | | Off [Default] |
| | | | | | | On |
| HDBaseT Mode | | | | | HDBaseT [Default] | |
| | | | | | Auto | |

USING THE PROJECTOR

| Main Menu | Sub Menu | Sub Menu 2 | Sub Menu 3 | Sub Menu 4 | Values | | |
|-----------|-------------|------------|-------------------|------------------|--|---------------|--|
| Setup | Options | Language | | | English [Default] | | |
| | | | | | Deutsch | | |
| | | | | | Français | | |
| | | | | | Italiano | | |
| | | | | | Español | | |
| | | | | | Português | | |
| | | | | | Polski | | |
| | | | | | Nederlands | | |
| | | | | | Svenska | | |
| | | | | | Norsk/Dansk | | |
| | | | | | Suomi | | |
| | | | | | ελληνικά | | |
| | | | | | 繁體中文 | | |
| | | | | | 简体中文 | | |
| | | | | | 日本語 | | |
| | | | | | 한국어 | | |
| | | | | | Русский | | |
| | | | | | Magyar | | |
| | | | | | Čeština | | |
| | | | | | عربي | | |
| | | | | ไทย | | | |
| | | | | Türkçe | | | |
| | | | | فارسی | | | |
| | | | | Tiếng Việt | | | |
| | | | | Bahasa Indonesia | | | |
| | | | | Română | | | |
| | | | | Slovenčina | | | |
| | | | Closed Captioning | | | CC1 | |
| | | | | | | CC2 | |
| | | | | | | Off [Default] | |
| | | | Menu Settings | Menu Location | | | Top left  |
| | | | | | | | Top right  |
| | | | | | | | Center  [Default] |
| | | | | | Bottom left  | | |
| | | | | | Bottom right  | | |
| | Menu Timer | | | Off | | | |
| | | | | 5sec | | | |
| | | | | 10sec [Default] | | | |
| | Auto Source | | | Off [Default] | | | |
| | | | | On | | | |

USING THE PROJECTOR

| Main Menu | Sub Menu | Sub Menu 2 | Sub Menu 3 | Sub Menu 4 | Values | |
|-----------|----------|------------------|------------------|------------|--------------------------------------|-------------------|
| Setup | Options | Input Source | | | HDMI1/MHL | |
| | | | | | HDMI2 | |
| | | | | | VGA IN 1 [Default] | |
| | | | | | VGA IN 2 | |
| | | | | | Video | |
| | | | | | S-Video | |
| | | | | | HDBaseT | |
| | | | High Altitude | | | Off [Default] |
| | | | | | On | |
| | | | Logo | | | Default [Default] |
| | | | | | Neutral | |
| | | | | | User | |
| | | | Background Color | | | Black [Default] |
| | | | | | Blue | |
| | | | | | Red | |
| | | | | Green | | |
| | | | | Gray | | |
| | | | | Logo | | |
| | Reset | Reset to Default | | | Cancel [Default] | |
| | | | | Yes | | |
| Network | LAN | Network Status | | | (read only) | |
| | | MAC Address | | | (read only) | |
| | | DHCP | | | Off [Default] | |
| | | | | | On | |
| | | IP Address | | | 192.168.0.100 [Default] | |
| | | Subnet Mask | | | 255.255.255.0 [Default] | |
| | | Gateway | | | 192.168.0.254 [Default] | |
| | | DNS | | | 192.168.0.51 [Default] | |
| | Reset | | | | | |
| | Control | HTTP | | | Off | |
| | | | | | On [Default] Note: Port 80 | |

USING THE PROJECTOR

| Main Menu | Sub Menu | Sub Menu 2 | Sub Menu 3 | Sub Menu 4 | Values | |
|-----------|----------------------|------------|------------|------------|--------|--|
| Info | Serial Number | | | | | |
| | Source | | | | | |
| | Resolution | | | | 00x00 | |
| | Refresh Rate | | | | 0.00Hz | |
| | Display Mode | | | | | |
| | Power Mode (Standby) | | | | | |
| | Light Source Hours | | | | 0 hr | |
| | Network Status | | | | | |
| | IP Address | | | | | |
| | Brightness Mode | | | | | |
| | FW Version | System | | | | |
| | | LAN | | | | |
| MCU | | | | | | |

Note: Functions vary depending on model definition.

USING THE PROJECTOR

Display menu

Display image settings menu

Display Mode

There are many factory presets optimized for various types of images.

- **Presentation:** This mode is suitable for showing in front of public in connection to the PC.
- **Bright:** Maximum brightness from PC input.
- **HDR SIM.:** Decodes and displays High Dynamic Range (HDR) content for the deepest blacks, brightest whites, and vivid cinematic color using REC.2020 color gamut. This mode can be selected to enhance non-HDR content with simulated High Dynamic Range (HDR).
- **Cinema:** Provides the best colors for watching movies.
- **Game:** Select this mode to increase the brightness and response time level for enjoying video games.
- **sRGB:** Standardized accurate color.
- **DICOM SIM.:** This mode can project a monochrome medical image such as an X ray radiography, MRI, etc.
- **User:** Memorize user's settings.
- **3D:** To experience the 3D effect, you need to have 3D glasses, make sure your PC/portable device has a 120 Hz signal output quad buffered graphics card and have a 3D Player installed.

Wall Color

Use this function to obtain an optimized screen image according to the wall color. Select between off, blackboard, light yellow, light green, light blue, pink, and gray.

Brightness

Adjust the brightness of the image.

Contrast

The contrast controls the degree of difference between the lightest and darkest parts of the picture.

Sharpness

Adjust the sharpness of the image.

Color

Adjust a video image from black and white to fully saturated color.

Tint

Adjust the color balance of red and green.

Gamma

Set up gamma curve type. After the initial setup and fine tuning is completed, utilize the Gamma Adjustment steps to optimize your image output.

- **Film:** For home theater.
- **Video:** For video or TV source.
- **Graphics:** For PC / Photo source.
- **Standard(2.2):** For standardized setting.
- **1.8 / 2.0 / 2.4 / 2.6:** For specific PC / Photo source.

Note:

USING THE PROJECTOR

- *These options are only available if the 3D mode function is disabled, the **Wall Color** setting is not set to **Blackboard**, and the **Display Mode** setting is not set to **DICOM SIM.** or **HDR SIM.***
- *In 3D mode, user can only select **3D** for **Gamma** setting.*
- *If the **Wall Color** setting is set to **Blackboard**, user can only select **Blackboard** for **Gamma** setting.*
- *If the **Display Mode** setting is set to **DICOM SIM.**, user can only select **DICOM SIM.** for **Gamma** setting.*
- *If the **Display Mode** setting is set to **HDR SIM.**, user can only select **HDR SIM.** for **Gamma** setting.*

Color Settings

Configure the color settings.

- **BrilliantColor™**: This adjustable item utilizes a new color-processing algorithm and enhancements to enable higher brightness while providing true, more vibrant colors in picture.
- **Color Temperature**: Select a color temperature from Warm, Standard, Cool, or Cold.
- **Color Matching**: Select the following options:
 - **Color**: Adjust the red, green, black, cyan, yellow, magenta, and white level of the image.
 - **Hue / R(red)***: Adjust the color balance of red and green.
Note: **If the **Color** setting is set to **White**, you can adjust the red color setting.*
 - **Saturation / G(green)***: Adjust a video image from black and white to fully saturated color.
Note: **If the **Color** setting is set to **White**, you can adjust the green color setting.*
 - **Gain / B(blue)***: Adjust the image brightness.
Note: **If the **Color** setting is set to **White**, you can adjust the blue color setting.*
 - **Reset**: Return the factory default settings for color matching.
 - **Exit**: Exit the “Color Matching” menu.
- **RGB Gain/Bias**: This settings allows to configure the brightness (gain) and contrast (bias) of an image.
 - **Reset**: Return the factory default settings for RGB gain/bias.
 - **Exit**: Exit the “RGB Gain/Bias” menu.
- **Color Space (non-HDMI input only)**: Select an appropriate color matrix type from the following: AUTO, RGB, or YUV.
- **Color Space (HDMI input only)**: select an appropriate color matrix type from the following: Auto, RGB(0-255), RGB(16-235), and YUV.

Signal

Adjust the signal options.

- **Automatic**: Configure automatically the signal (the frequency and phase items are grayed out). If automatic is disabled, the frequency and phase items will appear for tuning and saving the settings.
- **Frequency**: Change the display data frequency to match the frequency of your computer’s graphic card. Use this function only if the image appears to flicker vertically.
- **Phase**: Synchronize the signal timing of the display with the graphic card. If the image appears to be unstable or flickers, use this function to correct it.
- **H. Position**: Adjust the horizontal positioning of the image.
- **V. Position**: Adjust the vertical positioning of the image.

Note: *This menu is only available if the input source is RGB/Component.*

USING THE PROJECTOR

Brightness Mode

Adjust the brightness mode settings.

- **DynamicBlack:** Use to automatically adjust the picture brightness in order to give optimum contrast performance.
- **Power:** Choose the power percentage for brightness mode.

Reset

Return the factory default settings for color settings.

Display 3D menu

Note:

- *This projector is a 3D ready projector with DLP-Link 3D solution.*
- *Please make sure your 3D glasses are use for DLP-Link 3D before enjoy your video.*
- *This projector supports frame sequential (page-flip) 3D via HDMI/VGA ports.*
- *To enable 3D mode, the input frame rate should be set to 60Hz only, lower or higher frame rate is not supported.*
- *To reach the best performance, resolution 1920x1080 is recommended, please be noted that 4K (3840x2160) resolution is not supported in 3D mode.*

3D Mode

Use this option to disable the 3D function or select the appropriate the 3D function.

- **Off:** Select “Off” to turn off 3D mode.
- **DLP-Link:** Select to use optimized settings for DLP 3D Glasses.

Note: *If the 2D and 3D sources enter PJ at the same time, if the ghosting image appears in the 2D source, make sure to manually turn off the 3D function.*

3D → 2D

Use this option to specify how the 3D content should appear on the screen.

- **3D:** Display 3D signal.
- **L (Left):** Display the left frame of 3D content.
- **R (Right):** Display the right frame of 3D content.

3D Format

Use this option to select the appropriate 3D format content.

- **Auto:** When a 3D identification signal is detected, the 3D format is selected automatically.
- **SBS:** Display 3D signal in “Side-by-Side” format.
- **Top and Bottom:** Display 3D signal in “Top and Bottom” format.
- **Frame Sequential:** Display 3D signal in “Frame Sequential” format.

3D Sync Invert

Use this option to enable/disable the 3D sync invert function.

USING THE PROJECTOR

Display aspect ratio menu

Aspect Ratio

Select the aspect ratio of the displayed image between the following options:

- **4:3:** This format is for 4:3 input sources.
- **16:9:** This format is for 16:9 input sources, like HDTV and DVD enhanced for Wide screen TV.
- **16:10** (for WUXGA model only): This format is for 16:10 input sources, like widescreen laptops.
- **LBX:** This format is for non-16x9, letterbox source and if you use external 16x9 lens to display 2.35:1 aspect ratio in full resolution.
- **Native:** This format displays the original image without any scaling.
- **Auto:** Automatically selects the appropriate display format.

Note:

- *Detailed informations about LBX mode:*
 - *Some Letter-Box Format DVDs are not enhanced for 16x9 TVs. In this situation, the image will not look right when displaying image in 16:9 mode. In this situation, please try to use the 4:3 mode to view the DVD. If the content is not 4:3, there will be black bars around the image in 16:9 display. For this type of content, you can use LBX mode to fill the image on the 16:9 display.*
 - *If you use an external anamorphic lens, this LBX mode also allows you to watch a 2.35:1 content (include Anamorphic DVD and HDTV film source) that supports anamorphic wide is enhanced for 16x9 Display in a wide 2.35:1 image. In this case, there are no black bars. Light source power and vertical resolution are fully utilized.*
- *To use the superwide format, do the following:*
 - a) *Set the screen aspect ratio to 2.0:1.*
 - b) *Select “Superwide” format.*
 - c) *Align the projector image correctly on the screen.*

1080p scaling table:

| 16:9 screen | 480i/p | 576i/p | 1080i/p | 720p | PC |
|-------------|---|--------|---------|------|----|
| 4x3 | Scale to 1440x1080. | | | | |
| 16x9 | Scale to 1920x1080. | | | | |
| LBX | Scale to 1920x1440, then get the central 1920x1080 image to display. | | | | |
| Native mode | - 1:1 mapping centered. - No scaling will be made; the image is displayed with the resolution based on input source. | | | | |
| Auto | - If auto format is selected, the screen type will automatically become 16:9 (1920x1080). - If source is 4:3, the screen type will be scaled to 1440 x1080. - If source is 16:9, the screen type will be scaled to 1920x1080. - If source is 16:10, the screen type will be scaled to 1920x1200 and cut 1920x1080 area to display. | | | | |

USING THE PROJECTOR

1080p auto mapping rule:

| Auto | Input resolution | | Auto/Scale | |
|-------------|------------------|--------------|------------|------|
| | H-resolution | V-resolution | 1920 | 1080 |
| 4:3 | 640 | 480 | 1440 | 1080 |
| | 800 | 600 | 1440 | 1080 |
| | 1024 | 768 | 1440 | 1080 |
| | 1280 | 1024 | 1440 | 1080 |
| | 1400 | 1050 | 1440 | 1080 |
| | 1600 | 1200 | 1440 | 1080 |
| Wide Laptop | 1280 | 720 | 1920 | 1080 |
| | 1280 | 768 | 1800 | 1080 |
| | 1280 | 800 | 1728 | 1080 |
| SDTV | 720 | 576 | 1350 | 1080 |
| | 720 | 480 | 1620 | 1080 |
| HDTV | 1280 | 720 | 1920 | 1080 |
| | 1920 | 1080 | 1920 | 1080 |

WUXGA scaling table for 1920 x 1200 DMD (screen type 16:10):

Note:

- Supported screen type 16:10 (1920 x 1200), 16:9 (1920x1080).
- When screen type is 16:9, the 16x10 format becomes unavailable.
- When screen type is 16:10, the 16x9 format becomes unavailable.
- If you select auto option then the display mode will be also automatically changed.

| 16 : 10 screen | 480i/p | 576i/p | 1080i/p | 720p | PC |
|----------------|---|--------|---------|------|----|
| 4x3 | Scale to 1600x1200. | | | | |
| 16x9 | Scale to 1920x1080. | | | | |
| 16x10 | Scale to 1920x1200. | | | | |
| LBX | Scale to 1920x1440, then get the central 1920x1200 image to display. | | | | |
| Native mode | - 1:1 mapping centered. - No scaling will be made; the image is displayed with the resolution based on input source. | | | | |
| Auto | - If this format is selected, the screen type will automatically become 16:10 (1920x1200). - If source is 4:3, the screen type will be scaled to 1600x1200. - If source is 16:9, the screen type will be scaled to 1920x1080. - If source is 16:10, the screen type will be scaled to 1920x1200. | | | | |

USING THE PROJECTOR

WUXGA auto mapping rule (screen type 16:10):

| Auto | Input resolution | | Auto/Scale | |
|-------------|------------------|--------------|------------|------|
| | H-resolution | V-resolution | 1920 | 1200 |
| 4:3 | 640 | 480 | 1600 | 1200 |
| | 800 | 600 | 1600 | 1200 |
| | 1024 | 768 | 1600 | 1200 |
| | 1280 | 1024 | 1600 | 1200 |
| | 1400 | 1050 | 1600 | 1200 |
| | 1600 | 1200 | 1600 | 1200 |
| Wide Laptop | 1280 | 720 | 1920 | 1080 |
| | 1280 | 768 | 1920 | 1152 |
| | 1280 | 800 | 1920 | 1200 |
| SDTV | 720 | 576 | 1350 | 1080 |
| | 720 | 480 | 1620 | 1080 |
| HDTV | 1280 | 720 | 1920 | 1080 |
| | 1920 | 1080 | 1920 | 1080 |

WUXGA scaling table (screen type 16:9):

| 16 : 9 screen | 480i/p | 576i/p | 1080i/p | 720p | PC |
|---------------|--|--------|---------|------|----|
| 4x3 | Scale to 1440x1080. | | | | |
| 16x9 | Scale to 1920x1080. | | | | |
| LBX | Scale to 1920x1440, then get the central 1920x1080 image to display. | | | | |
| Native mode | <ul style="list-style-type: none"> - 1:1 mapping centered. - No scaling will be made; the image is displayed with the resolution based on input source. | | | | |
| Auto | <ul style="list-style-type: none"> - If this format is selected, the screen type will automatically become 16:9 (1920x1080). - If source is 4:3, the screen type will be scaled to 1440x1080. - If source is 16:9, the screen type will be scaled to 1920x1080. - If source is 16:10, the screen type will be scaled to 1920x1200 and cut 1920x1080 area to display. | | | | |

WUXGA auto mapping rule (screen type 16:9):

| Auto | Input resolution | | Auto/Scale | |
|-------------|------------------|--------------|------------|------|
| | H-resolution | V-resolution | 1920 | 1080 |
| 4:3 | 640 | 480 | 1440 | 1080 |
| | 800 | 600 | 1440 | 1080 |
| | 1024 | 768 | 1440 | 1080 |
| | 1280 | 1024 | 1440 | 1080 |
| | 1400 | 1050 | 1440 | 1080 |
| | 1600 | 1200 | 1440 | 1080 |
| Wide Laptop | 1280 | 720 | 1920 | 1080 |
| | 1280 | 768 | 1800 | 1080 |
| | 1280 | 800 | 1728 | 1080 |
| SDTV | 720 | 576 | 1350 | 1080 |
| | 720 | 480 | 1620 | 1080 |

USING THE PROJECTOR

| | | | | |
|------|------|------|------|------|
| HDTV | 1280 | 720 | 1920 | 1080 |
| | 1920 | 1080 | 1920 | 1080 |

Display edge mask menu

Edge Mask

Use this function to remove the video encoding noise on the edge of video source.

Display zoom menu

Zoom

Use to reduce or magnify an image on the projection screen.

Display image shift menu

Image Shift

Adjust the projected image position horizontally (H) or vertically (V).

Display geometric correction menu

Four Corners

Allow the image to be squeezed to fit an area defined by moving each of the four corners' x and y position.

H Keystone

Adjust image distortion horizontally and make a squarer image. Horizontal keystone is used to correct a keystone image shape in which the left and right borders of the image are unequal in length. This is intended for use with horizontally on-axis applications.

V Keystone

Adjust image distortion vertically and make a squarer image. Vertical keystone is used to correct a keystone image shape in which the top and bottom are slanted to one of the sides. This is intended when for use with vertically on-axis applications.

Auto Keystone

Correct keystone digitally to fit the projected image on the area on which you are projecting.

Note:

- *The image size will reduce slightly when adjusting the horizontal and vertical keystone.*
- *When the Auto Keystone is used, the Four Corner Adjustment function will be disabled.*

Reset

Return the factory default settings for keystone settings.

USING THE PROJECTOR

Audio menu

Audio mute menu

Mute

Use this option to temporarily turn off the sound.

- **On:** Choose “On” to turn mute on.
- **Off:** Choose “Off” to turn mute off.

Note: “Mute” function affects both internal and external speaker volume.

Audio volume menu

Volume

Adjust the volume level.

Audio audio input menu

Audio Input

Select the audio input port for the video sources as follows:

- **HDMI1/MHL:** Audio 1, Audio 2, or Default.
- **HDMI2:** Audio 1, Audio 2, or Default.
- **VGA1:** Audio 1 and Audio 2.
- **VGA2:** Audio 1 and Audio 2.
- **S-VIDEO:** Audio 1 and Audio 2.
- **VIDEO:** Audio 1 and Audio 2.
- **HDBaseT:** Audio 1, Audio 2, or Default.

Audio audio/mic input function menu

Audio/Mic Input Function

Configure the audio input source setting.

USING THE PROJECTOR

Setup menu

Setup projection menu

Projection

Select the preferred projection between front, rear, ceiling-top, and rear-top.

Setup screen type menu

Screen Type (for WXGA/WUXGA model only)

Choose the screen type from 16:9 and 16:10.

Setup power settings menu

Direct Power On

Choose “On” to activate Direct Power mode. The projector will automatically power on when AC power is supplied, without pressing the “Power” key on the projector keypad or on the remote control.

Signal Power On

Choose “On” to activate Signal Power mode. The projector will automatically power on when a signal is detected, without pressing the “Power” key on the projector Keypad or on the remote control.

Note: Only supported on HDMI 1, HDMI 2 and VGA In 1 Connector.

Auto Power Off (min.)

Sets the countdown timer interval. The countdown timer will start, when there is no signal being sent to the projector. The projector will automatically power off when the countdown has finished (in minutes).

Power Mode (Standby)

Set the power mode setting.

- **Active:** Choose “Active” to return to normal standby.
- **Eco:** Choose “Eco.” to save power dissipation further < 0.5W.

USB Power (Standby)

Enable or disable the USB power function when the projector is in standby mode.

Setup security menu

Security

Enable this function to prompt for a password before using the projector.

- **On:** Choose “On” to use security verification when the turning on the projector.
- **Off:** Choose “Off” to be able to switch on the projector without password verification.

Security Timer

Can be select the time (Month/Day/Hour) function to set the number of hours the projector can be used. Once this time has elapsed you will be requested to enter your password again.

Change Password

Use to set or modify the password that is prompted when turning the projector on.

Note: Password default value is “1234” (first time).

USING THE PROJECTOR

Setup HDMI Link settings menu

Note:

- When you connect HDMI CEC-compatible devices to the projector with HDMI cables, you can control them on the same power on or power off status using the HDMI Link control feature in the projector's OSD. This lets one device or multiple devices in a group power on or power off via HDMI Link Feature in a typical configuration, your DVD player may be connected to the projector through an amplifier or home theater system.



HDMI CEC

Default is Off. Select "On" to enable HDMI CEC function.

Setup HDBaseT control menu

Ethernet

Enable or disable the Ethernet feature.

- **On:** Choose "On" to enable HDBaseT port connection and disable LAN port connection.
- **Off:** Choose "Off" to use the LAN port connection.

RS232

Enable or disable the RS232 feature.

- **On:** Choose "On" to enable HDBaseT port connection and disable RS232 port connection.
- **Off:** Choose "Off" to use the RS232 port connection.

HDBaseT Mode

Set the HDBaseT Mode.

- **Auto:** The projector will automatically switch to the HDBaseT mode when it detects a signal from the HDBaseT port.
- **HDBaseT:** The projector is switched to the HDBaseT mode.

USING THE PROJECTOR

Setup options menu

Language

Select the multilingual OSD menu between English, German, French, Italian, Spanish, Portuguese, Polish, Dutch, Swedish, Norwegian/Danish, Finnish, Greek, traditional Chinese, simplified Chinese, Japanese, Korean, Russian, Hungarian, Czechoslovak, Arabic, Thai, Turkish, Farsi, Vietnamese, Indonesian, Romanian, and Slovakian.

Closed Captioning

Closed Captioning is a text version of the program sound or other information displayed on the screen. If the input signal contains closed captions, you can turn on the feature and watch the channels. The available options include “Off”, “CC1”, and “CC2”.

Menu Settings

Set the menu location on the screen and configure menu timer settings.

- **Menu Location:** Select the menu location on the display screen.
- **Menu Timer:** Set the duration where the OSD menu stays visible on the screen.

Auto Source

Choose this option to let the projector automatically find an available input source.

Input Source

Select the input source between HDMI1/MHL, HDMI2, HDBaseT, VGA IN 1, VGA IN 2, VIDEO and S-VIDEO

High Altitude

When “On” is selected, the fans will spin faster. This feature is useful in high altitude areas where the air is thin.

Logo

Use this function to set the desired startup screen. If changes are made, they will take effect the next time the projector is powered on.

- **Default:** The default startup screen.
- **Neutral:** Logo is not displayed on startup screen.
- **User:** Use the stored picture as the startup screen.

Screen capture by PC tool

1. **Set “Logo” to “User”**
Set the “Logo” to “User” in **Setup** options menu.
2. **Enter download mode**
Hold both “Power” and “Menu” buttons and then plug in power cord. Release the buttons until Power/Lamp/Temp LED indicators are lighting red.
3. **Connect USB cable between PC and projector**
Please find the “SERVICE” USB port and plug-in USB cable.



USING THE PROJECTOR

4. Install and Click Splash Downloader

Find the Acer_Splash_downloader_v0.4.zip in the CD user manual. Then click Splash Downloader. If the message says “Projector found”, the projector has been connected successfully.

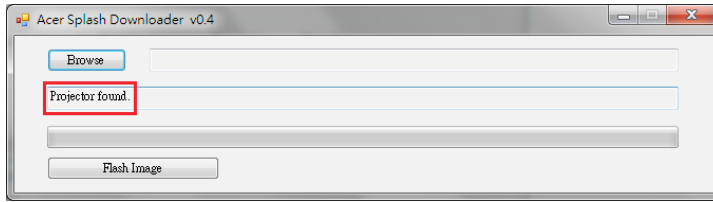

Note: If “Error: No Projector found.”, the projector is not connected. Please retry step 2 and step 3.

5. Select logo file

Click the “Browse” button and select logo file. The recommended resolution of logo should not exceed the default logo resolution (For example, logo resolution is 1920x1200). The purpose is that keeping the quality of the image. If not, the logo may be blurred.

Note: Support “PNG” & “BMP” file format.

6. Download logo to projector

Click the “Flash Image” button. If the file was written to projector successfully, the message “Download Complete” will be displayed on the screen.



7. Reboot projector

Plug-out the power cord of projector and plug-in it. Please ensure that the logo has been upgraded correctly.

8. Operating system compatibility

| | |
|---------------------------|-------------|
| Operating system platform | compatible |
| Windows XP | Not support |
| Windows 7 (64 bit) | Support |
| Windows 10 (64 bit) | Support |

Background Color

Use this function to display a blue, red, green, gray color, black, or logo screen when no signal is available.

Setup reset OSD menu

Reset to Default

Return the factory default settings for all settings except network setting.

USING THE PROJECTOR

Network menu

Network LAN menu

Network Status

Display the network connection status (read-only).

MAC Address

Display the MAC address (read-only).

DHCP

Use this option to enable or disable the DHCP function.

- **Off:** To assign IP, subnet mask, gateway, and DNS configuration manually.
- **On:** Projector will obtain an IP address automatically from your network.

Note: *Exiting OSD will automatically apply the entered values.*

IP Address

Display the IP address.

Subnet Mask

Display subnet mask number.

Gateway

Display the default gateway of the network connected to the projector.

DNS

Display the DNS number.

How to use web browser to control your projector

1. Turn "On" the DHCP option on projector to allow a DHCP server to automatically assign an IP address.
2. Open the web browser in your PC and type in the projector's IP address ("Network > LAN > IP Address").
3. Enter the user name and password, and click "Login".
The projector's configuration web interface opens.

Note:

- *The default user name and password is "admin".*
- *The steps in this section is based on Windows 7 operating system.*

USING THE PROJECTOR

Making a direct connection from your computer to the projector*

1. Turn “Off” the DHCP option on the projector.
2. Configure the IP address, Subnet Mask, Gateway, and DNS on projector (“Network > LAN”).
3. Open **Network and Sharing Center** page on your PC, and assign the identical network parameters to your PC as set on projector. Click “OK” to save the parameters.



4. Open the web browser on your PC and type in to the URL field the IP address, assigned in step 3. Then press “Enter” key.

Reset

Reset all values for LAN parameters.

Network control menu

HTTP

Use this function to select the network function (port: 80).

USING THE PROJECTOR

Setup network control settings menu

LAN_RJ45 function

For simplicity and ease of operation, the projector provides diverse networking and remote management features. The LAN / RJ45 function of the projector through a network, such as remotely manage: Power On / Off, brightness, and contrast settings. Also, you can view the projector status information, such as: Video- Source, Sound-Mute, etc.



Wired LAN terminal functionalities

This projector can be controlled by using a PC (laptop) or other external device via LAN / RJ45 port.

For more detailed information about the various types of external devices which can be connected to the LAN / RJ45 port and remote control the projector, as well as the supported commands for these external devices, please contact the Support-Service directly.

USING THE PROJECTOR

LAN RJ45

1. Connect an RJ45 cable to RJ45 ports on the projector and the PC (laptop).



2. On the PC (Laptop), select **Start > Control Panel > Network Connections**.



3. Right-click on the **Local Area Connection**, and select **Property**.



4. In the **Properties** window, select the **General tab**, and select **Internet Protocol (TCP / IP)**.

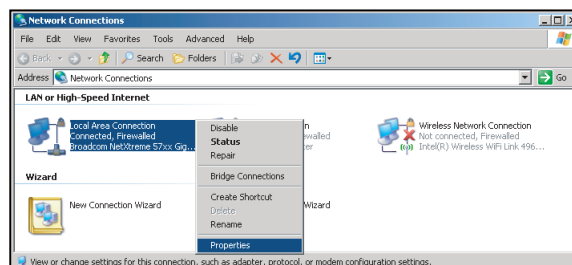

USING THE PROJECTOR

5. Click “Properties”.



6. Type in the IP address and Subnet mask, then press “OK”.

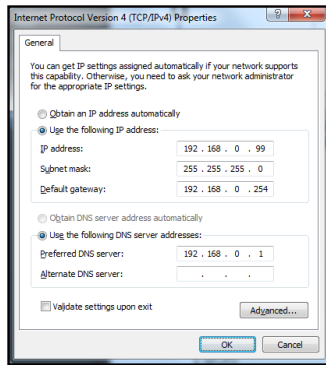

7. Press the “Menu” button on the projector.
8. Open on projector **Network > LAN**.
9. Enter the following connection parameters:
 - DHCP: Off
 - IP Address: 192.168.0.100
 - Subnet Mask: 255.255.255.0
 - Gateway: 192.168.0.254
 - DNS: 192.168.0.51
10. Press “Enter” to confirm settings.
11. Open a web browser, for example Microsoft Internet Explorer with Adobe Flash Player 9.0 or higher installed.
12. In the Address bar, input the projector’s IP address: 192.168.0.100.



13. Press “Enter”.

USING THE PROJECTOR

Info menu

Info menu

View the projector information as listed below:

- Serial Number
- Source
- Resolution
- Refresh Rate
- Display Mode
- Power Mode (Standby)
- Light Source Hours
- Network Status
- IP Address
- Brightness Mode
- FW Version

ADDITIONAL INFORMATION

Compatible resolutions

Digital compatibility

| Digital (HDMI 1.4) | | | | |
|-------------------------|----------------------|---------------------|--------------------------|---------------------|
| B0 / Established Timing | B0 / Standard Timing | B0 / Detail Timing | B1 / Video Mode | B1 / Detail Timing |
| 720 x 400 @ 70Hz | 1280 x 720 @ 60Hz | WXGA: | 720 x 480i @ 60Hz 16:9 | 1920 x 1080p @ 60Hz |
| 640 x 480 @ 60Hz | 1280 x 800 @ 60Hz | 1280 x 800@60Hz | 720 x 480p @ 60Hz 4:3 | 1366x768@60Hz |
| 640 x 480 @ 67Hz | 1280 x 1024 @ 60Hz | 1080p: | 720 x 480p @ 60Hz 16:9 | 1920x1080@120Hz |
| 640 x 480 @ 72Hz | | 1920 x 1080@60Hz | 720 x 576i @ 50Hz 16:9 | |
| 640 x 480 @ 75Hz | | WUXGA: | 720 x 576p @ 50Hz 4:3 | |
| 800 x 600 @ 56Hz | 640 x 480@120Hz | 1920 x 1200@60Hz-RB | 720 x 576p @ 50Hz 16:9 | |
| 800 x 600 @ 60Hz | 800 x 600@120Hz | | 1280 x 720p @ 60Hz 16:9 | |
| 800 x 600 @ 72Hz | 1024 x 768@120Hz | | 1280 x 720p @ 50Hz 16:9 | |
| 800 x 600 @ 75Hz | 1280 x 800@120Hz | | 1920 x 1080i @ 60Hz 16:9 | |
| 832 x 624 @ 75Hz | | | 1920 x 1080i @ 50Hz 16:9 | |
| 1024 x 768 @ 60Hz | | | 1920 x 1080p @ 60Hz 16:9 | |
| 1024 x 768 @ 70Hz | | | 1920 x 1080p @ 50Hz 16:9 | |
| 1024 x 768 @ 75Hz | | | 1920 x 1080p @ 24Hz 16:9 | |
| 1280 x 1024 @ 75Hz | | | 3840 x 2160 @ 24Hz | |
| 1152 x 870 @ 75Hz | | | 3840 x 2160 @ 25Hz | |
| | | | 3840 x 2160 @ 30Hz | |
| | | | 4096 x 2160 @ 24Hz | |

| Digital (HDMI 2.0) | | | | |
|-------------------------|----------------------|--------------------|--------------------------|--------------------|
| B0 / Established Timing | B0 / Standard Timing | B0 / Detail Timing | B1 / Video Mode | B1 / Detail Timing |
| 720 x 400 @ 70Hz | 1280 x 720 @ 60Hz | WXGA: | 720 x 480i @ 60Hz 16:9 | |
| 640 x 480 @ 60Hz | 1280 x 800 @ 60Hz | 1280x800@60Hz | 720 x 480i @ 60Hz 16:9 | 1366x768@60Hz |
| 640 x 480 @ 67Hz | 1280x1024 @ 60Hz | 1080p: | 720 x 480p @ 60Hz 4:3 | 1920x1080@120Hz |
| 640 x 480 @ 72Hz | | 1920x1080@60Hz | 720 x 480p @ 60Hz 16:9 | |
| 640 x 480 @ 75Hz | | WUXGA: | 720 x 576i @ 50Hz 16:9 | |
| 800 x 600 @ 56Hz | 640x480@120Hz | 1920x1200@60Hz-RB | 720 x 576p @ 50Hz 4:3 | |
| 800 x 600 @ 60Hz | 800x600@120Hz | | 720 x 576p @ 50Hz 16:9 | |
| 800 x 600 @ 72Hz | 1024x768@120Hz | | 1280 x 720p @ 60Hz 16:9 | |
| 800 x 600 @ 75Hz | 1280x800@120Hz | | 1280 x 720p @ 50Hz 16:9 | |
| 832 x 624 @ 75Hz | | | 1920 x 1080i @ 60Hz 16:9 | |
| 1024 x 768 @ 60Hz | | | 1920 x 1080i @ 50Hz 16:9 | |
| 1024 x 768 @ 70Hz | | | 1920 x 1080p @ 60Hz 16:9 | |
| 1024 x 768 @ 75Hz | | | 1920 x 1080p @ 50Hz 16:9 | |
| 1280 x 1024 @ 75Hz | | | 1920 x 1080p @ 24Hz 16:9 | |
| 1152 x 870@ 75Hz | | | 3840 x 2160 @ 24Hz | |
| | | | 3840 x 2160 @ 25Hz | |

ADDITIONAL INFORMATION

| Digital (HDMI 2.0) | | | | |
|-------------------------|----------------------|--------------------|--------------------|--------------------|
| B0 / Established Timing | B0 / Standard Timing | B0 / Detail Timing | B1 / Video Mode | B1 / Detail Timing |
| | | | 3840 x 2160 @ 30Hz | |
| | | | 4096 x 2160 @ 24Hz | |
| | | | 3840 x 2160 @ 50Hz | |
| | | | 3840 x 2160 @ 60Hz | |
| | | | 4096 x 2160 @ 50Hz | |
| | | | 4096 x 2160 @ 60Hz | |
| | | | 4096 x 2160 @ 25Hz | |
| | | | 4096 x 2160 @ 30Hz | |

Note: Functions vary depending on model definition.

Analog compatibility

| B0 / Established Timing | B0 / Standard Timing | B0 / Detail Timing | B1 / Video Mode | B1 / Detail Timing |
|-------------------------|----------------------|--------------------|-----------------|----------------------|
| 640 x 480 @ 60Hz | 1280 x 800 @ 60Hz | 1280x800@60Hz | | 1280x800@120Hz(RB) |
| 640 x 480 @ 67Hz | 1280x1024 @ 60Hz | 1080p: | | 1900x1200 @ 60Hz(RB) |
| 640 x 480 @ 72Hz | | 1920x1080@60Hz | | |
| 640 x 480 @ 75Hz | 640x480@120Hz | WUXGA: | | |
| 800 x 600 @ 56Hz | 800x600@120Hz | 1920x1200@60Hz-RB | | |
| 800 x 600 @ 60Hz | 1024x768@120Hz | | | |
| 800 x 600 @ 72Hz | | | | |
| 800 x 600 @ 75Hz | | | | |
| 832 x 624 @ 75Hz | | | | |
| 1024 x 768 @ 60Hz | | | | |
| 1024 x 768 @ 70Hz | | | | |
| 1024 x 768 @ 75Hz | | | | |
| 1280 x 1024 @ 75Hz | | | | |
| 1152 x 870@ 75Hz | | | | |

Note: Functions vary depending on model definition.

ADDITIONAL INFORMATION

True 3D video compatibility

| Input resolutions | HDMI 1.4a 3D Input | Input timing | | |
|-------------------|-----------------------|---------------------|--------------------|-------------------------------|
| | | 1280 x 720P @ 50Hz | Top-and-Bottom | |
| | | 1280 x 720P @ 60Hz | Top-and-Bottom | |
| | | 1280 x 720P @ 50Hz | Frame packing | |
| | | 1280 x 720P @ 60Hz | Frame packing | |
| | | 1920 x 1080i @ 50Hz | Side-by-Side(Half) | |
| | | 1920 x 1080i @ 60Hz | Side-by-Side(Half) | |
| | | 1920 x 1080P @ 24Hz | Top-and-Bottom | |
| | | 1920 x 1080P @ 24Hz | Frame packing | |
| | HDMI 1.3 | 1920 x 1080i @ 50Hz | Side-by-Side(Half) | SBS mode is on |
| | | 1920 x 1080i @ 60Hz | | |
| | | 1280 x 720P @ 50Hz | | |
| | | 1280 x 720P @60Hz | | |
| | | 1920 x 1080i @ 50Hz | Top-and-Bottom | TAB mode is on |
| | | 1920 x 1080i @ 60Hz | | |
| | | 1280 x 720P @ 50Hz | | |
| | | 1280 x 720P @60Hz | | |
| | | 480i | HQFS | 3D format is Frame sequential |

Note:

- If 3D input is 1080p@24Hz, the DMD should replay with integral multiple with 3D mode.
- 1080i@25Hz and 720p@50Hz will run in 100Hz; 1080p@24Hz will run in 144Hz; other 3D timing will run in 120Hz.
- Functions vary depending on model definition.

ADDITIONAL INFORMATION

Image size and projection distance

WXGA Series

To obtain an image size of 60" set the projector at a distance 1.9 m and 3.0 m from the screen.



| Desired image size | | Distance (m) | | Top (cm) |
|------------------------|-----------------|-----------------|-----------------|----------------------------------|
| Diagonal (inch) <A> | W (cm) x H (cm) | Max zoom | Min zoom <C> | From base to top of image <C> |
| 20 | 43 x 27 | | 1.0 | 31 |
| 30 | 65 x 40 | 0.9 | 1.5 | 46 |
| 50 | 108 x 67 | 1.6 | 2.5 | 77 |
| 60 | 129 x 81 | 1.9 | 3.0 | 93 |
| 70 | 151 x 94 | 2.2 | 3.5 | 108 |
| 80 | 172 x 108 | 2.5 | 4.0 | 124 |
| 90 | 194 x 121 | 2.8 | 4.6 | 139 |
| 100 | 215 x 135 | 3.2 | 5.1 | 155 |
| 120 | 258 x 162 | 3.8 | 6.1 | 186 |
| 150 | 323 x 202 | 4.7 | 7.6 | 232 |
| 200 | 431 x 269 | 6.3 | | 310 |
| 250 | 538 x 337 | 7.9 | | 387 |
| 300 | 646 x 404 | 9.5 | | 464 |

Zoom Ratio: 1.6x

ADDITIONAL INFORMATION

WUXGA series

To obtain an image size of 60" set the projector at a distance 1.8 m and 2.9 m from the screen.



| Desired image size | | Distance (m) | | Top (cm) |
|--------------------|-----------------|--------------|----------|---------------------------|
| Diagonal (inch) | W (cm) x H (cm) | Max zoom | Min zoom | From base to top of image |
| <A> | | | <C> | <C> |
| 21 | 45 x 28 | | 1.0 | 30 |
| 40 | 86 x 54 | 1.2 | 1.9 | 58 |
| 60 | 129 x 81 | 1.8 | 2.9 | 86 |
| 70 | 151 x 94 | 2.1 | 3.4 | 101 |
| 80 | 172 x 108 | 2.4 | 3.9 | 115 |
| 90 | 194 x 121 | 2.7 | 4.3 | 130 |
| 100 | 215 x 135 | 3.0 | 4.8 | 144 |
| 120 | 258 x 162 | 3.6 | 5.8 | 173 |
| 150 | 323 x 202 | 4.5 | 7.2 | 216 |
| 200 | 431 x 269 | 6.0 | | 288 |
| 250 | 538 x 337 | 7.5 | | 360 |
| 300 | 646 x 404 | 9.0 | | 432 |
| 302 | 650 x 407 | 9.1 | | 435 |

Zoom Ratio: 1.6x

ADDITIONAL INFORMATION

1080p series

To obtain an image size of 60" set the projector at a distance 1.9 m and 3.0 m from the screen.



| Desired image size | | Distance (m) | | Top (cm) |
|------------------------|-----------------|-----------------|-----------------|----------------------------------|
| Diagonal (inch) <A> | W (cm) x H (cm) | Max zoom | Min zoom <C> | From base to top of image <C> |
| 20 | 44 x 25 | | 1.0 | 29 |
| 40 | 89 x 50 | 1.2 | 2.0 | 59 |
| 60 | 133 x 75 | 1.9 | 3.0 | 88 |
| 70 | 155 x 87 | 2.2 | 3.5 | 103 |
| 80 | 177 x 100 | 2.5 | 4.0 | 118 |
| 90 | 199 x 112 | 2.8 | 4.5 | 132 |
| 100 | 221 x 125 | 3.1 | 5.0 | 147 |
| 120 | 266 x 149 | 3.7 | 6.0 | 176 |
| 150 | 332 x 187 | 4.6 | 7.4 | 220 |
| 200 | 443 x 249 | 6.2 | | 294 |
| 250 | 553 x 311 | 7.7 | | 367 |
| 300 | 664 x 374 | 9.3 | | 441 |

Zoom Ratio: 1.6x

ADDITIONAL INFORMATION

Projector dimensions and ceiling mount installation

1. To prevent damage to your projector, please use the Acer ceiling mount.
2. If you wish to use a third party ceiling mount kit, please ensure the screws used to attach a mount to the projector meet the following specifications:
 - Screw type: M6*10
 - Minimum screw length: 10mm



Note: Please note that damage resulting from incorrect installation will void the warranty.



Warning:







- If you buy a ceiling mount from another company, please be sure to use the correct screw size. Screw size will vary depending on the thickness of the mounting plate.
- Be sure to keep at least 10 cm gap between the ceiling and the bottom of the projector.
- Avoid installing the projector near a heat source.

ADDITIONAL INFORMATION

Troubleshooting

If you experience a problem with your projector, please refer to the following information. If a problem persists, please contact your local reseller or service center.

Image problems

-  *No image appears on-screen*
- Ensure all the cables and power connections are correctly and securely connected as described in the "Installation" section.
 - Ensure the pins of connectors are not crooked or broken.
 - Ensure that the "Mute" feature is not turned on.
-  *Image is out of focus*
- Turn the focus ring clockwise or counterclockwise until the image is sharp and legible. (Please see page 18).
 - Make sure the projection screen is between the required distance from the projector. (Please refer to pages 52-54).
-  *The image is stretched when displaying 16:9 DVD title*
- When you play anamorphic DVD or 16:9 DVD, the projector will show the best image in 16: 9 format on projector side.
 - If you play the LBX format DVD title, please change the format as LBX in projector OSD.
 - If you play 4:3 format DVD title, please change the format as 4:3 in projector OSD.
 - Please setup the display format as 16:9 (wide) aspect ratio type on your DVD player.
-  *Image is too small or too large*
- Turn the zoom lever clockwise or counterclockwise to increase or decrease the projected image size. (Please see page 18).
 - Move the projector closer to or further from the screen.
 - Press "Menu" on the projector panel, go to "Display → Aspect Ratio". Try the different settings.
-  *Image has slanted sides:*
- If possible, reposition the projector so that it is centered on the screen and below the bottom of the screen.
-  *Image is reversed*
- Select "Setup → Projection" from the OSD and adjust the projection direction.

ADDITIONAL INFORMATION

Other problems



The projector stops responding to all controls

- If possible, turn off the projector, then unplug the power cord and wait at least 20 seconds before reconnecting power.

Remote control problems



If the remote control does not work

- Check the operating angle of the remote control is pointed within $\pm 20^\circ$ to the IR receiver on the projector.
- Make sure there are not any obstructions between the remote control and the projector. Move to within 5 m (16.4 ft) of the projector.
- Make sure batteries are inserted correctly.
- Replace batteries if they are exhausted.

Warning indicators

When the warning indicators (see below) light up or flash, the projector will automatically shutdown:

- “Lamp” LED indicator is lit red and if “Power” indicator flashes red.
- “Temp” LED indicator is lit red and if “Power” indicator flashes red. This indicates the projector has overheated. Under normal conditions, the project can be switched back on.
- “Temp” LED indicator flashes red and if “Power” indicator flashes red.

Unplug the power cord from the projector, wait for 30 seconds and try again. If the warning indicator light up or flash, please contact your nearest service center for assistance.

ADDITIONAL INFORMATION

LED lightning messages

| Message | Power LED | | Temp LED | Lamp LED |
|-------------------------------------|--------------|--|--------------|--------------|
| | (Red) | (Blue) | (Red) | (Red) |
| Standby state (Input power cord) | Steady light | | | |
| Power on (Warming) | | Flashing (0.5 sec off / 0.5 sec on) | | |
| Power on and Lamp lighting | | Steady light | | |
| Power off (Cooling) | | Flashing (0.5 sec off / 0.5 sec on). Back to red steady light when cooling fan turns off. | | |
| Quick Resume(100 secs) | | Flashing (0.25 sec off / 0.25 sec on) | | |
| Error (Lamp failure) | Flashing | | | Steady light |
| Error (Fan failure) | Flashing | | Flashing | |
| Error (Over temp.) | Flashing | | Steady light | |

- Power off:

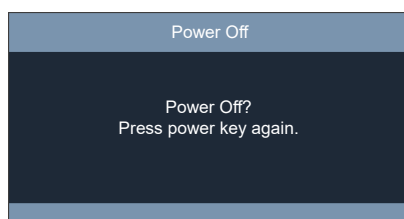

- Temperature warning:

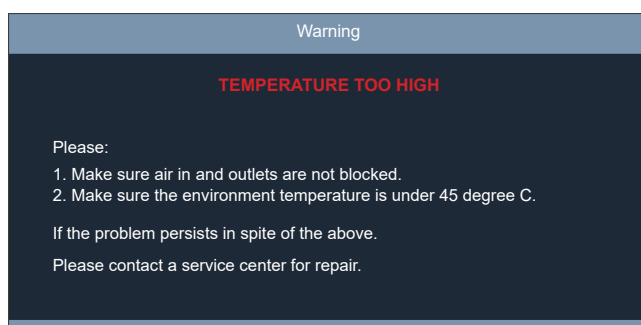

ADDITIONAL INFORMATION

Specifications

| Optical | Description |
|-----------------------|---|
| Maximum resolution | 1920x1200@60Hz(RB) |
| Native resolution | <ul style="list-style-type: none"> • WXGA • 1080p • WUXGA |
| Lens | Manual zoom and manual focus |
| Image size (diagonal) | <ul style="list-style-type: none"> • WXGA: 20" ~ 300" (51cm ~ 762cm) • 1080p: 20" ~ 300" (51cm ~ 762cm) • WUXGA: 21" ~ 302" (53cm ~ 767cm) |
| Projection distance | <ul style="list-style-type: none"> • WXGA: 1.0m ~ 9.5m (20" ~300') • 1080p: 1.0m ~ 9.3m (20" ~300') • WUXGA: 1.0m ~ 9.1m (21" ~302') |

| Electrical | Description |
|--------------------|---|
| Inputs | <ul style="list-style-type: none"> • HDMI 1.4a • HDMI 2.0b / MHL 2.2 • VGA In • Composite (RCA connector (Y)) • Audio In 3.5mm • Audio In 3.5mm, with Microphone • USB Type-A for power USB 5V/1.5A • S-Video |
| Outputs | <ul style="list-style-type: none"> • VGA Out • Audio Out 3.5mm |
| Control | <ul style="list-style-type: none"> • RS232 • RJ-45 (support web control) • RJ-45 for HDBaseT (for 15 IO type only) |
| Color reproduction | 1073.4 Million color |
| Scan rate | <ul style="list-style-type: none"> • Horizontal scan rate: 15.375~91.146 KHz • Vertical scan rate: 50~ 85 Hz (120Hz for 3D feature projector) |
| Built-in speaker | 10W |
| Power requirement | 100 - 240V ±10%, AC 50/60Hz |
| Input current | 3.8A |

| Mechanical | Description |
|--------------------------|---|
| Installation orientation | Front, Rear, Ceiling-top, Rear-top |
| Dimensions | <ul style="list-style-type: none"> • 374mm (W) x 302mm (D) x 117mm(H) (with feet) |
| Weight | 5.5 ±0.5kg |
| Environmental conditions | Operating in 5 ~ 40°C , 10% to 85% humidity (non-condensing) |

Note: All specifications are subject to change without notice.

ADDITIONAL INFORMATION

Regulations and safety notices

FCC notice

This device has been tested and found to comply with the limits for a Class B digital device pursuant to Part 15 of the FCC rules. These limits are designed to provide reasonable protection against harmful interference in a residential installation. This device generates, uses, and can radiate radio frequency energy and, if not installed and used in accordance with the instructions, may cause harmful interference to radio communications.

However, there is no guarantee that interference will not occur in a particular installation. If this device does cause harmful interference to radio or television reception, which can be determined by turning the device off and on, the user is encouraged to try to correct the interference by one or more of the following measures:

- Reorient or relocate the receiving antenna.
- Increase the separation between the device and receiver.
- Connect the device into an outlet on a circuit different from that to which the receiver is connected.
- Consult the dealer or an experienced radio/television technician for help.

Notice: Shielded cables

All connections to other computing devices must be made using shielded cables to maintain compliance with FCC regulations.

Notice: Peripheral devices

Only peripherals (input/output devices, terminals, printers, etc.) certified to comply with the Class B limits may be attached to this equipment. Operation with non-certified peripherals is likely to result in interference to radio and TV reception.

Caution

Changes or modifications not expressly approved by the manufacturer could void the user's authority, which is granted by the Federal Communications Commission, to operate this device.

Operation conditions

This device complies with Part 15 of the FCC Rules. Operation is subject to the following two conditions: (1) this device may not cause harmful interference, and (2) this device must accept any interference received, including interference that may cause undesired operation.

Notice: Canadian users

This Class B digital apparatus complies with Canadian ICES-003.

Remarque à l'intention des utilisateurs canadiens

Cet appareil numérique de la classe B est conforme à la norme NMB-003 du Canada.

Compliant with Russian/ Ukraine regulatory certification



Radio device regulatory notice

Note: The regulatory information below is for models with wireless LAN and/or Bluetooth only.

ADDITIONAL INFORMATION

General

This product complies with the radio frequency and safety standards of any country or region in which it has been approved for wireless use. Depending on configurations, this product may or may not contain wireless radio devices (such as wireless LAN and/or Bluetooth modules).

Canada — Low-power license-exempt radio communication devices (RSS-247)

a Common information

Operation is subject to the following two conditions:

1. This device may not cause interference, and
2. This device must accept any interference, including interference that may cause undesired operation of the device.

b Operation in 2.4 GHz band

To prevent radio interference to the licensed service, this device is intended to be operated indoors and installation outdoors is subject to licensing.

List of applicable countries

This device must be used in strict accordance with the regulations and constraints in the country of use. For further information, please contact the local office in the country of use.

Please see <http://ec.europa.eu/enterprise/rtte/implem.htm> for the latest country list.



Acer Incorporated
8F, 88, Sec. 1, Xintai 5th Rd., Xizhi
New Taipei City 221, Taiwan

Declaration of Conformity

We,

Acer Incorporated

8F, 88, Sec. 1, Xintai 5th Rd., Xizhi, New Taipei City 221, Taiwan

And,

Acer Italy s.r.l.

Via Lepetit, 40, 20020 Lainate (MI) Italy

Tel: +39-02-939-921 ,Fax: +39-02 9399-2913

www.acer.it

Product: DLP Projector
Trade Name: Acer
Model Number: DWU1846/DWU1817/D1P1818/DWX1819/DNX1820/DWU1847/DWU1821/D1P1822/
DWX1823/DNX1824
Marketing name: PL6610T/PL6610/PL6510/PL6310W/PL6210/SL6610T/SL6610/SL6510/SL6310W/
SL6210/FL261T/FL261/FL251/FL221/FL211/FL261ST/FL261S/FL251S/FL221S/
FL211S/LU-P500UT/LU-P500U/LU-P500F/LU-P500W/LU-P500X/LU-S500UT/
LU-S500U/LU-S500F/LU-S500W/LU-S500X/PF-L500UT/PF-L500U/PF-L500F/
PF-L500W/PF-L500X/PS-L500UT/PS-L500U/PS-L500F/PS-L500W/PS-L500X/
LR660T/LR660/LR560/LR360/LR260/LR660ST/LR660S/LR560S/LR360S/LR260S/
ML-560B/ML-560/ML-460/ML-260/ML-160/ML-560SB/ML-560S/ML-460S/
ML-260S/ML-160S

We, Acer Incorporated, hereby declare under our sole responsibility that the product described above is in conformity with the relevant Union harmonization legislations as below Directive and following harmonized standards and/or other relevant standards have been applied:

EMC Directive: 2014/30/EU

| | |
|--|--|
| <input checked="" type="checkbox"/> EN 55032:2015+AC:2016, Class B | <input checked="" type="checkbox"/> EN 61000-3-2:2014, Class D |
| <input checked="" type="checkbox"/> EN 55024:2010+A1:2015 | <input checked="" type="checkbox"/> EN 61000-3-3:2013 |

R&TTE Directive: 1999/5/EC

RED Directive: 2014/53/EU

| | | |
|--|---|---|
| <input type="checkbox"/> EN 300 328 V1.9.1 | <input type="checkbox"/> EN 301 511 V9.0.2 | <input type="checkbox"/> EN 301 489-7 V1.3.1 |
| <input type="checkbox"/> EN 301 893 V1.7.1 | <input type="checkbox"/> EN 301 908-1 V6.2.1 | <input type="checkbox"/> EN 301 489-17 V2.2.1 |
| <input type="checkbox"/> EN 300 440-1 V1.6.1 | <input type="checkbox"/> EN 301 908-2 V6.2.1 | <input type="checkbox"/> EN 301 489-24 V1.5.1 |
| <input type="checkbox"/> EN 300 440-2 V1.4.1 | <input type="checkbox"/> EN 301 908-13 V6.2.1 | <input type="checkbox"/> EN 50360:2001 |
| <input type="checkbox"/> EN 302 291-1 V1.1.1 | <input type="checkbox"/> EN 301 489-1 V1.9.2 | <input type="checkbox"/> EN 50566:2013 |
| <input type="checkbox"/> EN 302 291-2 V1.1.1 | <input type="checkbox"/> EN 301 489-3 V1.6.1 | <input type="checkbox"/> EN 62479:2010 |
| | | <input type="checkbox"/> EN 62311:2008 |
| | | <input type="checkbox"/> EN 62209-1:2006 |
| | | <input type="checkbox"/> EN 62209-2:2010 |

LVD Directive: 2014/35/EU

| | | |
|---|---|---|
| <input checked="" type="checkbox"/> EN 60950-1:2006/A11:2009/A1:2010/A12:2011/A2:2013 | <input checked="" type="checkbox"/> EN 60825-1:2007 | <input checked="" type="checkbox"/> EN 62471:2008 |
| <input type="checkbox"/> EN 50332-1:2013 | <input type="checkbox"/> EN 50332-2:2013 | |

RoHS Directive: 2011/65/EU

| |
|---|
| <input checked="" type="checkbox"/> EN 50581:2012 |
|---|

ErP Directive: 2009/125/EC

| | |
|--|--|
| <input type="checkbox"/> Regulation (EU) No. 617/ 2013 | <input type="checkbox"/> Regulation (EC) No. 278/2009; EN 50563:2011 |
| <input checked="" type="checkbox"/> Regulation (EC) No. 1275/2008; EN 50564:2011 | |

Year to begin affixing CE marking 2018.

RU Jan / Sr. Manager
Acer Incorporated (Taipei, Taiwan)

Nov. 20, 2018
Date



Acer America Corporation
333 West San Carlos St.,
Suite 1500
San Jose, CA 95110
U. S. A.
Tel: 254-298-4000
Fax: 254-298-4147
www.acer.com



Federal Communications Commission Declaration of Conformity

This device complies with Part 15 of the FCC Rules. Operation is subject to the following two conditions: (1) this device may not cause harmful interference, and (2) this device must accept any interference received, including interference that may cause undesired operation.

The following local Manufacturer / Importer is responsible for this declaration:

| | |
|--------------------------------------|--|
| Product: | DLP Projector |
| Model Number: | DWU1846/DWU1817/D1P1818/DWX1819/ DNX1820/DWU1847/DWU1821/D1P1822/ DWX1823/DNX1824 |
| Machine Type: | PL6610T/PL6610/PL6510/PL6310W/PL6210/ SL6610T/SL6610/SL6510/SL6310W/SL6210/ FL261T/FL261/FL251/FL221/FL211/FL261ST/ FL261S/FL251S/FL221S/FL211S/ LU-P500UT/LU-P500U/LU-P500F/LU-P500W/ LU-P500X/LU-S500UT/LU-S500U/LU-S500F/ LU-S500W/LU-S500X/PF-L500UT/PF-L500U/ PF-L500F/PF-L500W/PF-L500X/PS-L500UT/ PS-L500U/PS-L500F/PS-L500W/PS-L500X/ LR660T/LR660/LR560/LR360/LR260/LR660ST/ LR660S/LR560S/LR360S/LR260S/ML-560B/ ML-560/ML-460/ML-260/ML-160/ML-560SB/ ML-560S/ML-460S/ML-260S/ML-160S |
| Name of Responsible Party: | Acer America Corporation |
| Address of Responsible Party: | 333 West San Carlos St. Suite 1500 San Jose, CA 95110 U. S. A. |
| Contact Person: | Acer Representative |
| Phone No.: | 254-298-4000 |
| Fax No.: | 254-298-4147 |

Free Manuals Download Website

<http://myh66.com>

<http://usermanuals.us>

<http://www.somanuals.com>

<http://www.4manuals.cc>

<http://www.manual-lib.com>

<http://www.404manual.com>

<http://www.luxmanual.com>

<http://aubethermostatmanual.com>

Golf course search by state

<http://golfingnear.com>

Email search by domain

<http://emailbydomain.com>

Auto manuals search

<http://auto.somanuals.com>

TV manuals search

<http://tv.somanuals.com>