

eMachines E720/E520 Series Service Guide

Service guide files and updates are available on the ACER/CSD web; for more information, please refer to <http://csd.acer.com.tw>

PRINTED IN TAIWAN

Revision History

Please refer to the table below for the updates made on eMachines E720/E520 Series service guide.

Date	Chapter	Updates

Copyright

Copyright © 2008 by Acer Incorporated. All rights reserved. No part of this publication may be reproduced, transmitted, transcribed, stored in a retrieval system, or translated into any language or computer language, in any form or by any means, electronic, mechanical, magnetic, optical, chemical, manual or otherwise, without the prior written permission of Acer Incorporated.

Disclaimer

The information in this guide is subject to change without notice.

Acer Incorporated makes no representations or warranties, either expressed or implied, with respect to the contents hereof and specifically disclaims any warranties of merchantability or fitness for any particular purpose. Any Acer Incorporated software described in this manual is sold or licensed *as is*. Should the programs prove defective following their purchase, the buyer (and not Acer Incorporated, its distributor, or its dealer) assumes the entire cost of all necessary servicing, repair, and any incidental or consequential damages resulting from any defect in the software.

Acer is a registered trademark of Acer Corporation.

Intel is a registered trademark of Intel Corporation.

Pentium and Pentium II/III are trademarks of Intel Corporation.

Other brand and product names are trademarks and/or registered trademarks of their respective holders.

Conventions

The following conventions are used in this manual:

SCREEN MESSAGES	Denotes actual messages that appear on screen.
NOTE	Gives bits and pieces of additional information related to the current topic.
WARNING	Alerts you to any damage that might result from doing or not doing specific actions.
CAUTION	Gives precautionary measures to avoid possible hardware or software problems.
IMPORTANT	Reminds you to do specific actions relevant to the accomplishment of procedures.

Preface

Before using this information and the product it supports, please read the following general information.

1. This Service Guide provides you with all technical information relating to the BASIC CONFIGURATION decided for Acer's *global* product offering. To better fit local market requirements and enhance product competitiveness, your regional office MAY have decided to extend the functionality of a machine (e.g. add-on card, modem, or extra memory capability). These LOCALIZED FEATURES will NOT be covered in this generic service guide. In such cases, please contact your regional offices or the responsible personnel/channel to provide you with further technical details.
2. Please note WHEN ORDERING FRU PARTS, that you should check the most up-to-date information available on your regional web or channel. If, for whatever reason, a part number change is made, it will not be noted in the printed Service Guide. For ACER-AUTHORIZED SERVICE PROVIDERS, your Acer office may have a DIFFERENT part number code to those given in the FRU list of this printed Service Guide. You MUST use the list provided by your regional Acer office to order FRU parts for repair and service of customer machines.

System Specifications	1
Features	1
System Block Diagram	3
Your Acer Notebook tour	4
Front View	4
Closed Front View	5
Left View	6
Right View	7
Rear View	7
Bottom View	8
Indicators	9
TouchPad Basics	9
Using the Keyboard	10
Lock Keys and embedded numeric keypad	10
Windows Keys	11
Hot Keys	12
Special Key	13
Using the System Utilities	14
Acer GridVista (dual-display compatible)	14
Hardware Specifications and Configurations	16
 System Utilities	 25
BIOS Setup Utility	25
Navigating the BIOS Utility	25
Information	26
Main	27
Security	28
Power	31
Boot	33
Exit	34
BIOS Flash Utilities	35
DOS Flash Utility	36
WinFlash Utility	37
Remove HDD/BIOS Password Utilities	38
Miscellaneous Utilities	41
 Machine Disassembly and Replacement	 43
Disassembly Requirements	43
General Information	44
Pre-disassembly Instructions	44
Disassembly Process	44
External Module Disassembly Process	45
External Modules Disassembly Flowchart	45
Removing the Battery Pack	46
Removing the SD dummy card	47
Removing the ExpressCard dummy card	48
Removing the Lower Covers	49
Removing the DIMM Modules	51
Removing the WLAN Module	52
Removing the TV tuner Module	54
Removing the Hard Disk Drive Module	56
Removing the Optical Drive Module	58
Main Unit Disassembly Process	60
Main Unit Disassembly Flowchart	60

Table of Contents

Removing the Switch Cover	62
Removing the Keyboard	63
Removing the Antenna	64
Removing the LCD Module	66
Removing the Upper Cover	68
Removing the Finger Print Reader	72
Removing the Upper Right Saddle	73
Removing the Left Speaker Module	74
Removing the Upper Left Saddle	75
Removing the TouchPad Bracket	76
Removing the Launch Board	78
Removing the Media Board	78
Removing the eKey Board	79
Removing the Switch Board	81
Removing the Right Speaker Module	82
Removing the TV Board	83
Removing the Bluetooth Module	84
Removing the USB Board	85
Removing the Modem Module	86
Removing the Subwoofer Module	87
Removing the Main Board	88
Removing the RJ-11 Port	90
Removing the Thermal Module	91
Removing the CPU	93
Removing the VGA Module	94
LCD Module Disassembly Process	95
LCD Module Disassembly Flowchart	95
Removing the LCD Bezel	96
Removing the Inverter Board	97
Removing the Camera Module	99
Removing the LCD Panel	101
Removing the LCD Brackets and FPC Cable	102
Removing the Antennas	103
Removing the MIC Module	104
LCD Module Reassembly Procedure	105
Replacing the LCD Panel	105
Replacing the LCD Bezel	109
Main Module Reassembly Procedure	110
Replacing the VGA Module	110
Replacing the CPU	110
Replacing the Thermal Module	111
Replacing the RJ-11 Port	111
Replacing the Mainboard	113
Replacing Subwoofer Module	114
Replacing the Modem Module	114
Replacing the Bluetooth Board	116
Replacing the TV Board	116
Replacing the Right Speaker Module	117
Replacing the Switch Board	118
Replacing the eKey Board	118
Replacing the Media Board	120
Replacing the Upper Right Saddle	121
Replacing the Launch Board	122
Replacing the Finger Print Reader	122
Replacing the TouchPad Bracket	124

Table of Contents

Replacing the Left Speaker Module	125
Replacing the Upper Cover	125
Replacing the LCD Module	127
Replacing the Antenna Cables	129
Replacing the Keyboard	130
Replacing the Switch Cover	130
Replacing the TV Tuner Module	131
Replacing the WLAN Module	133
Replacing the Hard Disk Drive Module	133
Replacing the DIMM Modules	134
Replacing the ODD Module	135
Replacing the Lower Covers	136
Replacing the Express and SD Card Trays	137
Troubleshooting	139
Common Problems	139
Power On Issue	140
No Display Issue	141
Random Loss of BIOS Settings	142
LCD Failure	143
Built-In Keyboard Failure	143
TouchPad Failure	144
Internal Speaker Failure	144
Internal Microphone Failure	146
HDD Not Operating Correctly	147
ODD Failure	148
USB Failure (Rightside)	151
Modem Function Failure	151
Wireless Function Failure	152
EasyTouch Button Failure	152
MediaTouch Button Failure	153
Fingerprint Reader Failure	153
Thermal Unit Failure	154
HDTV Switch Failure	154
External Mouse Failure	155
Other Failures	155
Intermittent Problems	156
Undetermined Problems	156
POST Codes Tables	157
Port 80 Codes	157
Post Key	159
Messages Displayed during POST	159
Jumper and Connector Locations	161
Top View	161
Bottom View	162
Clearing Password Check and BIOS Recovery	163
Clearing Password Check	163
BIOS Recovery by Crisis Disk	164
FRU (Field Replaceable Unit) List	167
eMachines E720/E520 Exploded Diagram	168
eMachines E720/E520 FRU List	169

Table of Contents

Model Definition and Configuration	178
eMachines E720/E520 Series	179
Test Compatible Components	197
Microsoft® Windows® Vista Environment Test	198
Online Support Information	201
Index	203

System Specifications

Features

Below is a brief summary of the computer's many features:

NOTE: Items marked with * denote only selected models.

Operating System

- Genuine Windows® Vista™

Platform

- Intel® Pentium® dual-core processor*
- Intel® Celeron® processor*
- Mobile Intel® GL40 Express Chipset
- IEEE 802.11b/g

System Memory

- Dual-Channel DDR2 support
- Up to 2 GB of DDR2 667 MHz memory, upgradeable to 4 GB using two soDIMM modules

Display and graphics

- 15.4" WXGA 1280 x 800
- Mobile Intel® GL40 Express Chipset

Storage subsystem

- 2.5" hard disk drive
- Optical drive options:
 - DVD-Super Multi double-layer drive*
 - DVD/CD-RW combo drive*

Audio

- Two built-in stereo speakers
- High-definition audio support
- MS-Sound compatible
- Built-in microphone

Communication

- Integrated webcam*
- WLAN: IEEE 802.11b/g
- LAN: Fast Ethernet; Wake-on-LAN ready

Dimensions and weight

- 364.6 (W) x 273.6 (D) x 27.0/38.4 (H) mm (14.4 x 10.8 x 1.1/1.5 inches)
- 2.80 kg (6.17 lbs.) with 6-cell battery pack

Privacy control

- BIOS user, supervisor, HDD passwords
- Kensington lock slot

Power subsystem

- ACPI 3.0
- 48.8 W 4400 mAh
- 3-pin 65/90 W AC adapter
- Energy Star 4.0*

Special keys and controls

- 88-/89-key keyboard
- TouchPad pointing device

I/O interface

- USB 2.0 port
- External display (VGA) port
- Headphones/speaker/line-out jack
- Microphone-in jack
- Line-in jack
- Ethernet (RJ-45) port
- DC-in jack for AC adapter

Environment

- Temperature:
 - Operating: 5 °C to 35 °C
 - Non-operating: -20 °C to 65 °C
- Humidity (non-condensing):
 - Operating: 20% to 80%
 - Non-operating: 20% to 80%

NOTE: Items marked with * denote only selected models.







Your Acer Notebook tour





IMPORTANT:The outside housing and color may vary from the mass produced model.

After knowing your computer features, let us show you around your new computer.

Front View



No.	Icon	Item	Description
1		Microphone	Internal microphone for sound recording.
2		Integrated Webcam	Web camera for video communication (selected models only).
3		Display screen	Also called Liquid-Crystal Display (LCD), displays computer output.
4		Power button	Turns the computer on and off.
5		Speakers	Left and right speakers deliver stereo audio output.
6		Wireless LAN Communication button/indicator	Enables/disables the wireless LAN function. Indicates the status of wireless LAN communication.
7		Keyboard	For entering data into your computer.

No.	Icon	Item	Description
8		Palmrest	Comfortable support area for your hands when you use the computer.
9		TouchPad	Touch-sensitive pointing device which functions like a computer mouse.
10		Click buttons (left and right)	The left and right buttons function like the left and right mouse buttons.
11		Power*	Indicates the computer's power status.
		Battery*	Indicates the computer's battery status. 1. Charging: The light shows amber when the battery is charging. 2. Fully charged: The light shows green when in AC mode.
		HDD	Indicates when the hard disk drive is active.
		Num Lock	Lights up when Num Lock is activated.
		Caps Lock	Lights up when Caps Lock is activated.

* The front panel indicators are visible even when the computer cover is closed up.









Closed Front View

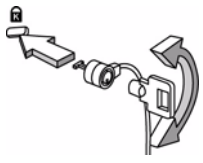

No.	Item	Description
1	Latch	Locks and releases the lid.

Left View



No.	Icon	Item	Description
1		Kensington lock slot 	Connects to a Kensington-compatible computer security lock. Note: Wrap the computer security lock cable around an immovable object such as a table or handle of a locked drawer. Insert the lock into the notch and turn the key to secure the lock. Some keyless models are also available.
2		DC-IN jack	Connects to an AC adapter.
3		Ethernet (RJ-45) port	Connects to an Ethernet 10/100/1000-based network.
4		External display (VGA) port	Connects to a display device (e.g. external monitor, LCD projector).
		2 USB 2.0 ports	Connect to USB 2.0 devices (e.g. USB mouse, USB camera).
		Line-in jack	Accepts audio line-in devices (e.g. audio CD player, stereo walkman).
		Microphone-in jack	Accepts input from external microphones.
		Headphones/speaker/line-out jack	Connects to audio line-out devices (e.g. speakers, headphones).

Right View



No.	Icon	Item	Description
1		Optical drive	Internal optical drive; accepts CDs or DVDs.
2		Optical disk access indicator	Lights up when the optical drive is active.
3		Optical drive eject button	Ejects the optical disk from the drive.
4		Emergency eject hole	Ejects the optical drive tray when the computer is turned off. Note: Insert a paper clip into the emergency eject hole to eject the optical drive tray when the computer is off.





Rear View

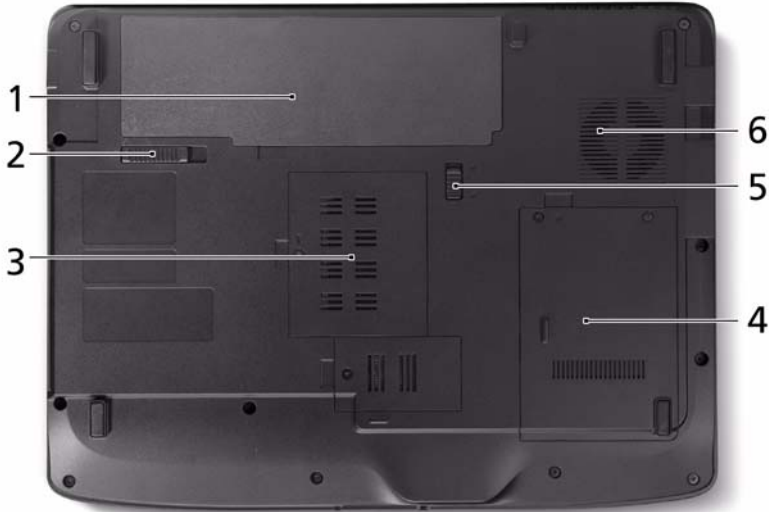

No.	Item	Description
1	Ventilation slots	Enable the computer to stay cool, even after prolonged use.

Bottom View







No.	Icon	Item	Description
1		Battery bay	Houses the computer's battery pack.
2		Battery release latch	Releases the battery for removal.
3		Memory compartment	Houses the computer's main memory.
4		Hard disk bay	Houses the computer's hard disk (secured with screws).
5		Battery lock	Locks the battery in position.
6		Ventilation slots and cooling fan	Enable the computer to stay cool, even after prolonged use. Note: Do not cover or obstruct the opening of the fan.

Indicators

The computer has several easy-to-read status indicators:

The front panel indicators are visible even when the computer cover is closed.

Icon	Function	Description
	Power	Indicates the computer's power status.
	Battery	Indicates the computer's battery status.
	HDD	Indicates when the hard disk drive is active.
	Num Lock	Lights up when Num Lock is activated.
	Caps Lock	Lights up when Caps Lock is activated.

NOTE: 1. **Charging:** The light shows amber when the battery is charging. 2. **Fully charged:** The light shows green when in AC mode.

TouchPad Basics

The following items show you how to use the TouchPad:

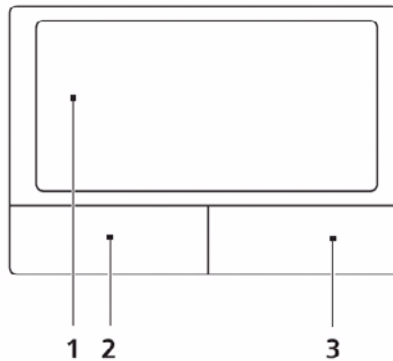

- Move your finger across the TouchPad (1) to move the cursor.
- Press the left (2) and right (3) buttons located beneath the TouchPad to perform selection and execution functions. These two buttons are similar to the left and right buttons on a mouse. Tapping on the TouchPad is the same as clicking the left button.

Function	Left Button (1)	Right Button (3)	Main TouchPad (2)
Execute	Quickly click twice.		Tap twice (at the same speed as double-clicking a mouse button).
Select	Click once.		Tap once.
Drag	Click and hold, then use finger on the TouchPad to drag the cursor.		Tap twice (at the same speed as double-clicking a mouse button); rest your finger on the TouchPad on the second tap and drag the cursor.
Access context menu		Click once.	

NOTE: When using the TouchPad, keep it - and your fingers - dry and clean. The TouchPad is sensitive to finger movement; hence, the lighter the touch, the better the response. Tapping too hard will not increase the TouchPad's responsiveness.

Using the Keyboard

The keyboard has full-sized keys and an embedded numeric keypad, separate cursor, lock, Windows, function and special keys.

Lock Keys and embedded numeric keypad

The keyboard has three lock keys which you can toggle on and off.





















Lock key	Description
Caps Lock	When Caps Lock is on, all alphabetic characters typed are in uppercase.
Num Lock <Fn> + <F11>	When Num Lock is on, the embedded keypad is in numeric mode. The keys function as a calculator (complete with the arithmetic operators +, -, *, and /). Use this mode when you need to do a lot of numeric data entry. A better solution would be to connect an external keypad.
Scroll Lock <Fn> + <F12>	When Scroll Lock is on, the screen moves one line up or down when you press the up or down arrow keys respectively. Scroll Lock does not work with some applications.

The embedded numeric keypad functions like a desktop numeric keypad. It is indicated by small characters located on the upper right corner of the keycaps. To simplify the keyboard legend, cursor-control key symbols are not printed on the keys.

Desired access	Num Lock on	Num Lock off
Number keys on embedded keypad	Type numbers in a normal manner.	
Cursor-control keys on embedded keypad	Hold <Shift> while using cursor-control keys.	Hold <Fn> while using cursor-control keys.
Main keyboard keys	Hold <Fn> while typing letters on embedded keypad.	Type the letters in a normal manner.

Windows Keys

The keyboard has two keys that perform Windows-specific functions.

Key	Description
 Windows key	<p>Pressed alone, this key has the same effect as clicking on the Windows Start button; it launches the Start menu. It can also be used with other keys to provide a variety of functions:</p> <ul style="list-style-type: none"> <  >: Open or close the Start menu <  > + <D>: Display the desktop <  > + <E>: Open Windows Explore <  > + <F>: Search for a file or folder <  > + <G>: Cycle through Sidebar gadgets <  > + <L>: Lock your computer (if you are connected to a network domain), or switch users (if you're not connected to a network domain) <  > + <M>: Minimizes all windows <  > + <R>: Open the Run dialog box <  > + <T>: Cycle through programs on the taskbar <  > + <U>: Open Ease of Access Center <  > + <X>: Open Windows Mobility Center <  > + <BREAK>: Display the System Properties dialog box <  > + <SHIFT+M>: Restore minimized windows to the desktop <  > + <TAB>: Cycle through programs on the taskbar by using Windows Flip 3-D <  > + <SPACEBAR>: Bring all gadgets to the front and select Windows Sidebar <CTRL> + <  > + <F>: Search for computers (if you are on a network) <CTRL> + <  > + <TAB>: Use the arrow keys to cycle through programs on the taskbar by using Windows Flip 3-D <p>Note: Depending on your edition of Windows Vista, some shortcuts may not function as described.</p>
 Application key	<p>This key has the same effect as clicking the right mouse button; it opens the application's context menu.</p>

Hot Keys

The computer employs hotkeys or key combinations to access most of the computer's controls like screen brightness, volume output and the BIOS utility.

To activate hot keys, press and hold the <Fn> key before pressing the other key in the hotkey combination.



Hotkey	Icon	Function	Description
<Fn> + <F1>	?	Hotkey help	Displays help on hotkeys.
<Fn> + <F2>		Acer eSettings Management	Launches Acer eSettings Management in Acer Empowering Technology.
<Fn> + <F3>		Acer ePower Management	Launches Acer ePower Management in Acer Empowering Technology.
<Fn> + <F4>	Z ^z	Sleep	Puts the computer in Sleep mode.
<Fn> + <F5>		Display toggle	Switches display output between the display screen, external monitor (if connected) and both.
<Fn> + <F6>		Screen blank	Turns the display screen backlight off to save power. Press any key to return.
<Fn> + <F7>		TouchPad toggle	Turns the internal TouchPad on and off.
<Fn> + <F8>		Speaker toggle	Turns the speakers on and off.
<Fn> + <D>		Brightness up	Increases the screen brightness.
<Fn> + <D>		Brightness down	Decreases the screen brightness.
<Fn> + <F1>	?	Hotkey help	Displays help on hotkeys.
<Fn> + <F2>		Acer eSettings Management	Launches Acer eSettings Management in Acer Empowering Technology.

Special Key

You can locate the Euro symbol and the US dollar sign at the upper-center and/or bottom-right of your keyboard.



The Euro symbol

1. Open a text editor or word processor.
2. Hold <Alt Gr> and then press the <5> key at the upper-center of the keyboard.

NOTE: Note: Some fonts and software do not support the Euro symbol. Please refer to www.microsoft.com/typography/faq/faq12.htm for more information.

The US dollar sign

1. Open a text editor or word processor.
2. Hold <Shift> and then press the <4> key at the upper-center of the keyboard.

NOTE: This function varies by the operating system version.

Using the System Utilities

Acer Bio-Protection (only for certain models) Acer Bio-Protection Fingerprint Solution is a multi-purpose fingerprint software package integrated with the Microsoft Windows operating system. Utilizing the uniqueness of one's fingerprint features, Acer Bio-Protection Fingerprint Solution has incorporated protection against unauthorized access to your computer with centralized password management with Password Bank, easy music player launching with Acer MusicLaunch, secure Internet favorites via Acer MyLaunch, and fast application/website launching and login with Acer FingerLaunch, while Acer ProfileLaunch can launch up to three applications/websites from a single finger swipe.

Acer Bio-Protection Fingerprint Solution also allows you to navigate through web browsers and documents using Acer FingerNav. With Acer Bio-Protection Fingerprint Solution, you can now enjoy an extra layer of protection for your personal computer, as well as the convenience of accessing your daily tasks with a simple swipe of your finger!

For more information refer to the Acer Bio-Protection help files.



Acer GridVista (dual-display compatible)

NOTE: This feature is only available on certain models.

To enable the dual monitor feature of the notebook, first ensure that the second monitor is connected, then select **Start, Control Panel, Display** and click on **Settings**. Select the secondary monitor (**2**) icon in the display box and then click the check box **Extend my windows desktop onto this monitor**. Finally, click **Apply** to confirm the new settings and click **OK** to complete the process.

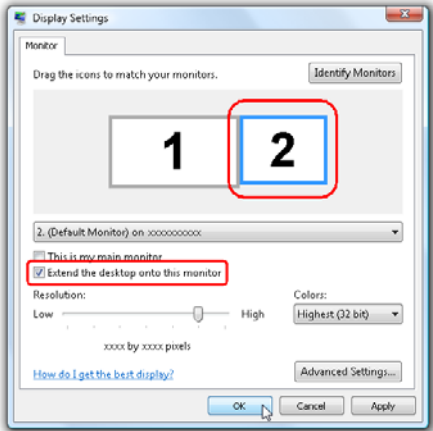

Acer GridVista is a handy utility that offers four pre-defined display settings so you can view multiple windows on the same screen. To access this function, please go to **Start → All Programs** and click on **Acer GridVista**. You may choose any one of the four display settings indicated below:



Double (vertical), Triple (primary at left), Triple (primary at right), or Quad Acer GridVista is dual-display compatible, allowing two displays to be partitioned independently.

Acer GridVista is dual-display compatible, allowing two displays to be partitioned independently.

AcerGridVista is simple to set up:

1. Run Acer GridVista and select your preferred screen configuration for each display from the task bar.
2. Drag and drop each window into the appropriate grid.
3. Enjoy the convenience of a well-organized desktop.

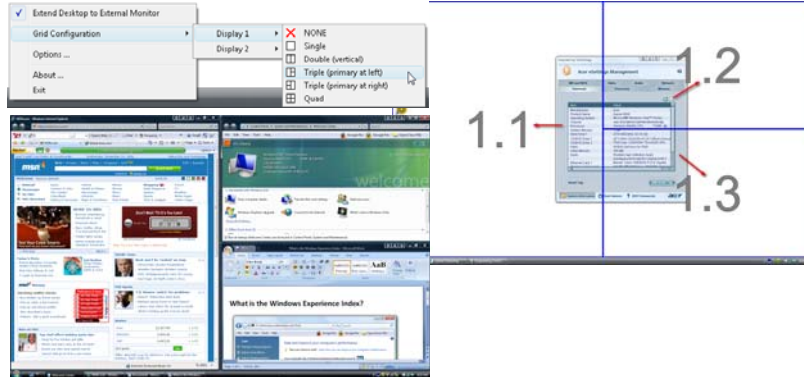

NOTE: Please ensure that the resolution setting of the second monitor is set to the manufacturer's recommended value.

Hardware Specifications and Configurations

Processor

Item	Specification
CPU type	<ul style="list-style-type: none"> Intel Mobile Penryn uPGA, SocketM, 6M L2, FSB 667/800/1066MHz Intel PDC/Celeron mobile processor
Core logic	<ul style="list-style-type: none"> Intel Cantiga GM/GL (667/800/1066MHz FSB supported) ICH9-M
Core Voltage	3.3V
CPU package	Micro uPGA-478 Package

CPU Fan True Value Table

DTS (degree C°)	Fan Speed (rpm)	Acoustic Level (dBA)
35~53	3100	31
50~65	3400	34
60~79	3700	37
75~100	4200	40
85~105	4200	40

- CPU DTS Throttling 50% point = 100°C; /recover 85°C

BIOS

Item	Specification
BIOS ROM type	Flash
BIOS ROM size	1 MB
Supported protocols	<ul style="list-style-type: none"> Support ISIPP Support Acer UI Support multi-boot Suspend to RAM (S3)/Disk (S4) Various hot-keys for system control Support SMBUS 2.0, PCI2.3 ACPI 2.0 compliance with Intel Speed Step Support C1, C2, C3, C4 and S3, S4 for mobile CPU DMI utility for BIOS serial number configurable/asset tag Support PXE Support Y2K solution Support Win Flash Wake on LAN from S3 Wake on LAN form S4 in AC mode System information

Cache

Item	Specification
Cache controller	CPU
Cache size	3 MB/6 MB L2 Cache

System Memory

Item	Specification
Memory controller	Built-in
Memory size	0MB (no on-board memory)
DIMM socket number	2 x 200-pin +1.8V DDRII SO-DIMM
Supports memory size per socket	2 GB
Supports maximum memory size	4G for 64bit OS (with two 2GB SODIMM)
Supports DIMM type	DDR II 667/800 SDRAM
Memory module combinations	You can install memory modules in any combinations as long as they match the above specifications.

Memory Combinations

Slot 1	Slot 2	Total Memory
0MB	512MB	512MB
0MB	1024MB	1024MB
0MB	2048MB	2048MB
512MB	512MB	1024MB
512MB	1024MB	1536MB
512MB	2048MB	2560MB
1024MB	0MB	1024MB
1024MB	512MB	1536MB
1024MB	1024MB	2048MB
1024MB	2048MB	3072MB
2048MB	0MB	2048MB
2048MB	512MB	2560MB
2048MB	1024MB	3072MB
2048MB	2048MB	4096MB

NOTE: Above table lists some system memory configurations. You may combine DIMMs with various capacities to form other combinations. On above table, the configuration of slot 1 and slot 2 could be reversed.

LAN Interface

Item	Specification
LAN Chipset	REALTEK RTL8111C-GR for Giga LAN
Supports LAN protocol	10/100/1000 GBit
LAN connector type	RJ-45
LAN connector location	Left side

Wireless Module 802.11b/g

Item	Specification
Chipset	
Data throughput	
Protocol	
Interface	

Hard Disk Drive Interface

Item	Specifications			
Vendor & Model Name	Hitachi 5K320-320 5K320-250 5K320-160 5K320-120	Seagate ST9250827AS ST9120817AS	WD WD1200BEVS	WD WD3200BEVT WD1600BEVT
Capacity (MB)	320, 250, 160, 120	250, 120	120	320, 160
Bytes per sector	512	512	512	512
Data heads	4, 4 or 3, 2, 2	4, 2	2	4, 2
Drive Format				
Disks	2, 2, 1, 1	2, 1	1	2, 1
Spindle speed (RPM)	5400	5400	5400	5400
Performance Specifications				
Buffer size	8 MB	8 MB	8 MB	8 MB
Interface	SATA	SATA	SATA	SATA
Internal transfer rate (Mbits/sec, max)	674 ~ 775	778	850 Mbits/s maximum	850 Mbits/s maximum
I/O data transfer rate (Mbytes/sec max)	1.5 / 3.0	300	150 maximum	300 maximum
DC Power Requirements				
Voltage	5V ±5%	5V ±5%	5V ±5%	5V ±5%

Super-Multi Drive

Item	Specification	
Vendor & model name	HLDS/GSA-T50N, Philips DS-8A2S, Sony/AD-7560S, Toshiba Digi/TS-L633A	
Performance Specification	With CD Diskette	With DVD Diskette
Transfer rate (MB/sec)	Sustained: Max 3.5 Mbytes/sec	Sustained: Max 10 Mbytes/sec
Buffer Memory	2 MB	
Interface	SATA	
Applicable disc format	Applicable media types: Writing: Confirms to DVD+R Version 1.2 and DVD+RW Version 1.3 / DVD+R DL Version 1.0 / DVD-R Version 2.0 / DVD-RW Version 1.2 / DVD-R DL Version 3.0. Reading: DVD single/dual layer (PTP, OTP), DVD-R single/dual layer DVD+R single/double layer DVD-RW DVD+RW CD-DA CD-ROM CD-ROM/XA Photo-CD, Multi-session, Video CD CD-I FMV, CD Extra, CD Plus, CD-R, and CD-RW	
Loading mechanism	Drawer (Solenoid Open) Tact SW (Open) Emergency Release (draw open hole)	
Power Requirement		
Input Voltage	DC 5 V +/- 5%	

Super Multi Drive (cont.)

Item	Specifications
Manufacturer and Model	Pioneer DVR-TD08RS
Type	Drawer Loading
Interface	Serial ATA Revision 2.6
Data Transfer Modes	Gen1i 1.5Gbits / sec
Buffer Memory Size	2 MB
Maximum Write Speed	8X Zone CLV at DVD-R / +R, DVD+RW 6X Zone CLV at DVD-R DL / +R DL, DVD-RW 5X Zone CLV at DVD-RAM 24X Zone CLV at CD-R / RW
Maximum Read Speed	8X CAV at DVD-ROM SL, DVD-R / +R, -RW / +RW, DVD-ROM DL, DVD-R DL / +R DL 5X Zone CLV at DVD-RAM 24X CAV at CD-ROM, CD-R / RW
Format Compatibility	KODAK Photo CD Single and Multi-session CD Extra (CD PLUS) Video CD CD text data (Read / Write) CD-R discs (Read / Write) CD-RW discs (Read / Write) DVD-ROM DVD-R Ver.2.0 & 2.1 for General (Read / Write) DVD-R DL Ver.3.0 (Read/Write) DVD-RW Ver.1.0 & 1.1 & 1.2 (Read / Write) DVD+R Ver.1.3 (Read/Write) DVD+R DL Ver1.0 & 1.1 (Read / Write) DVD+RW Ver.1.3 (Read/Write) DVD+RW high speed Ver.1.0 (Read/Write) DVD-RAM Ver.2.0 & 2.1 & 2.2
Power Supply	5V
Voltage Allowance	±5% (operating) -8% (startup)

Combo Drive Module

Item	Specification
Manufacturer and Model	Sony DL 24X CRX890S Toshiba DL 24X TS-L463A
Type	Drawer type
Interface	SATA
Data Transfer Mode	PIO Mode4
Buffer Memory Size	2 MB
Maximum Write Speed	• CD 3,600 KB/sec
Maximum Read Speed	• CD 3,600 KB/sec • DVD 10,800 KB/sec
Formats Supported	<p>CD</p> <ul style="list-style-type: none"> • CD-DA (Red Book) - Standard Audio CD & CD-TEXT • CD-ROM (Yellow Book Mode1 & 2) - Standard Data • CD-ROM XA (Mode2 Form1 & 2) - Photo CD, Multi-Session • CD-I (Green Book, Mode2 Form1 & 2, Ready, Bridge) • CD-Extra/ CD-Plus (Blue Book) - Audio & Text/Video • Video-CD (White Book) - MPEG1 Video • CD-R (Orange Book Part 1) • CD-RW & HSRW (Orange Book Part 2 Volume1 & Volume2) • Super Audio CD (SACD) Hybrid type • US & US+ RW <p>DVD</p> <ul style="list-style-type: none"> • DVD-ROM (Book 1.02), DVD-Dual • DVD-Video (Book 1.1) • DVD-R (Book 1.0, 3.9G) • DVD-R (Book 2.0, 4.7G) - General & Authoring • DVD+R (Version 1.0) • DVD-RW, DVD+RW • DVD+R DL • DVD-R DL • Support CPRM (read) • Support VCPS (read)
Power Supply	DC +5V / 1.3A
Voltage Allowance	DC +5V (5% (Operating), DC +5V(8% (Start Up))

Audio Interface

Item	Specification
Audio Controller	REALTEK ALC268-GR for High Definition Audio Codec
Mono or Stereo	Stereo
Supported Features	<p>MIC IN—AC-coupled input, 100mV_{p-p} maximum</p> <p>LINE IN—AC-coupled input, 100mV_{p-p} maximum</p> <p>Headphone out—1V_{p-p}</p> <p>Built-in Speaker—4 ohm, 2W Main Speaker</p>

Video Memory

Item	Specification
Chipset	CANTIGA GM/GL Integrated Graphic
Memory size	128MB UMA VGA memory share from North Bridge

System Board Major Chips

Item	Controller
Core logic	<ul style="list-style-type: none">Intel Cantiga GM/GL (667/800/1066MHz FSB supported)ICH9-M
VGA	CANTIGA GM/GL Integrated Graphic
LAN	REALTEK RTL8111C-GR for Giga LAN
Keyboard/Battery	ENE KB926
Audio Codec	REALTEK ALC268-GR for High Definition Audio Codec with Dolby Digital Live

Keyboard

Item	Specification
Keyboard controller	KB926
Total number of keypads	88-/89-/93-key
Windows logo key	Yes
Internal & external keyboard work simultaneously	Plug USB keyboard to the USB port directly: Yes

Battery 6 Cell

Item	Specification			
Vendor & model name	Sanyo AS2007B	Sony AS2007B	Panasonic AS2007B	Simplo AS2007B
Battery Type	Li-ion	Li-ion	Li-ion	Li-ion
Pack capacity	4400 mAh	4400 mAh	4400 mAh	4400 mAh
Number of battery cell	6cell	6cell	6cell	6cell
Package configuration	3S2P	3S2P	3S2P	3S2P
Normal voltage				
Charge voltage				

Battery 8 Cell

Item	Specification		
Vendor & model name	Sanyo AS2007B	Sony & AS2007B	Panasonic & AS2007B
Battery Type	Li-ion	Li-ion	Li-ion
Pack capacity	4800 mAh	4800 mAh	4800 mAh
Number of battery cell	8cell	8cell	8cell
Package configuration	4S2P	4S2P	4S2P
Normal voltage			
Charge voltage			

LCD 15.4"

Item	Specification
Vendor/model name	Chimei N154I3-L03, AUO B154EW08 V1(HW 3A), LG.Philips LP154WX4
Screen Diagonal (mm)	391
Active Area (mm)	331.2 X 207.0
Display resolution (pixels)	1280x (RGB) x 800
Pixel Pitch	0.2588 (H) x 0.2588 (V)
Pixel Arrangement	RGB vertical stripe
Display Mode	Normally white
Typical White Luminance (cd/m ²) also called Brightness	220 cd/m ² (Typ.5 point)
Luminance Uniformity	1.25 max. (5 points)
Contrast Ratio	300 Min 400 typical
Response Time (Optical Rise Time/Fall Time) msec	Rising: 6 Falling: 2
Nominal Input Voltage VDD	+3.3 typ.
Typical Power Consumption (watt)	6.0 max.(without inverter)
Weight (without inverter)	500 typ. 525 max.
Physical Size (mm)	344.0 typ. x 222.0 typ. x 6.1 max.
Electrical Interface	1 channel LVDS
Support Color	262K colors (RGB 6-bit)
Viewing Angle (degree) Horizontal: Right/Left Vertical: Upper/Lower	40/40 15/30
Temperature Range (°C) Operating Storage (shipping)	0 to +50 -20 to +60

LCD Camera

Item	Specification	
Vendor	Bison Electronics	Suyin
Model Name	BN30V407-010	CN0314-SN30-OV03-1
Type	Fixed	Fixed
Dimension (L x W x H mm)	W 9 * L 65 * H 5.3 mm	65* 9.0 * 5.30+/-0.20 mm
Sensor	Up to SXGA(1280x1024) size CMOS sensor	OV7725 CMOS Sensor 350K Pixel
Optical Size	1/4 inch	F/2.0
Pixel Resolution	640(H) X 480(V) VGA	640 x 480
Pixel Size	6.0µm X 6.0µm	6.0µm x 6.0µm

System Power Management

ACPI mode	Power Management
Mech. Off (G3)	All devices in the system are turned off completely.
Soft Off (G2/S5)	OS initiated shutdown. All devices in the system are turned off completely.
Working (G0/S0)	Individual devices such as the CPU and hard disc may be power managed in this state.
S3 Sleeping State	CPU set power down VGA Suspend PCMCIA Suspend Audio Power Down Hard Disk Power Down CD-ROM Power Down Super I/O Low Power mode
S4 Sleeping State	Also called Hibernation Mode. System saves all system states and data onto the disc prior to power off the whole system.

System Utilities

BIOS Setup Utility

The BIOS Setup Utility is a hardware configuration program built into your computer's BIOS (Basic Input/Output System).

Your computer is already properly configured and optimized, and you do not need to run this utility. However, if you encounter configuration problems, you may need to run Setup. Please also refer to Chapter 4 Troubleshooting when problem arises.

To activate the BIOS Utility, press **F2** during POST (when "Press <F2> to enter Setup" message is prompted on the bottom of screen).

Press **F2** to enter setup. The default parameter of F12 Boot Menu is set to "disabled". If you want to change boot device without entering BIOS Setup Utility, please set the parameter to "enabled".

Press <F12> during POST to enter multi-boot menu. In this menu, user can change boot device without entering BIOS SETUP Utility.

Navigating the BIOS Utility

There are six menu options: Information, Main, Advanced, Security, Boot, and Exit.

Follow these instructions:

- To choose a menu, use the left and right arrow keys.
- To choose an item, use the up and down arrow keys.
- To change the value of a parameter, press **F5** or **F6**.
- A plus sign (+) indicates the item has sub-items. Press **Enter** to expand this item.
- Press **Esc** while you are in any of the menu options to go to the Exit menu.
- In any menu, you can load default settings by pressing **F9**. You can also press **F10** to save any changes made and exit the BIOS Setup Utility.

NOTE: You can change the value of a parameter if it is enclosed in square brackets. Navigation keys for a particular menu are shown on the bottom of the screen. Help for parameters are found in the Item Specific Help part of the screen. Read this carefully when making changes to parameter values. **Please note that system information is subject to different models.**

Information

The Information screen displays a summary of your computer hardware information.

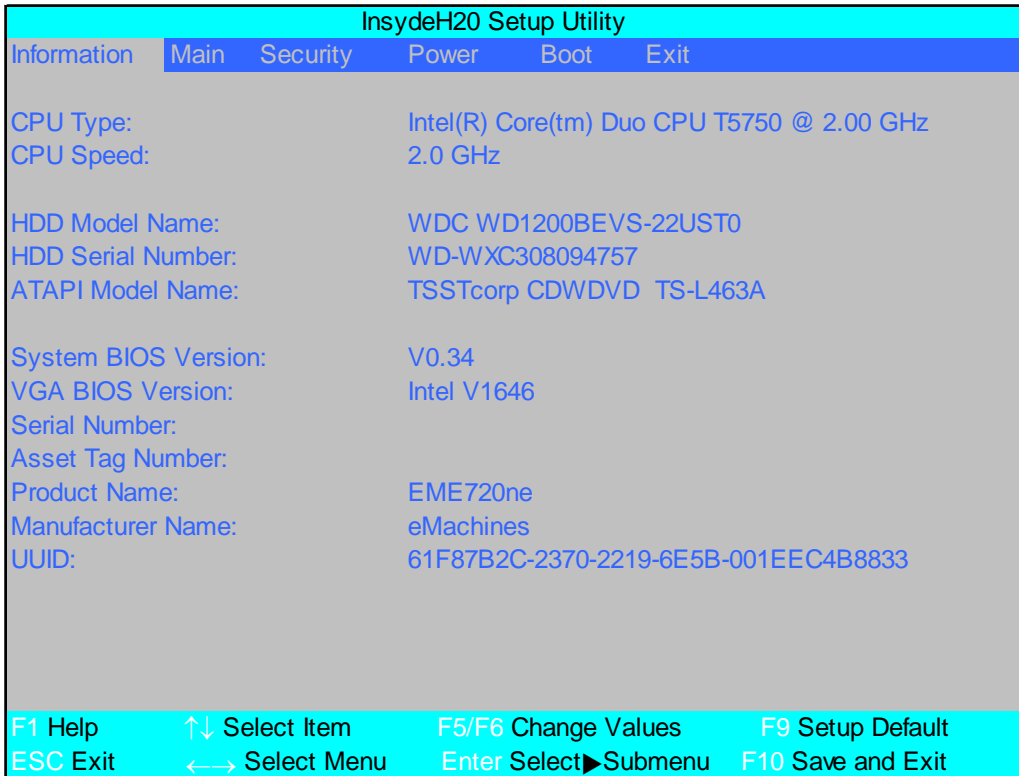

NOTE: The system information is subject to different models.

Parameter	Description
CPU Type	This field shows the CPU type and speed of the system.
CPU Speed	This field shows the speed of the CPU.
HDD Model Name	This field shows the model name of HDD installed on primary IDE master.
HDD Serial Number	This field displays the serial number of HDD installed on primary IDE master.
ATAPI Model Name	This field shows the model name of the Optical device installed in the system.
System BIOS Version	Displays system BIOS version.
VGA BIOS Version	This field displays the VGA firmware version of the system.
Serial Number	This field displays the serial number of this unit.
Asset Tag Number	This field displays the asset tag number of the system.
Product Name	This field shows product name of the system.
Manufacturer Name	This field displays the manufacturer of this system.
UUID Number	Universally Unique Identifier (UUID) is an identifier standard used in software construction, standardized by the Open Software Foundation (OSF) as part of the Distributed Computing Environment (DCE).

Main

The Main screen allows the user to set the system time and date as well as enable and disable boot option and recovery.

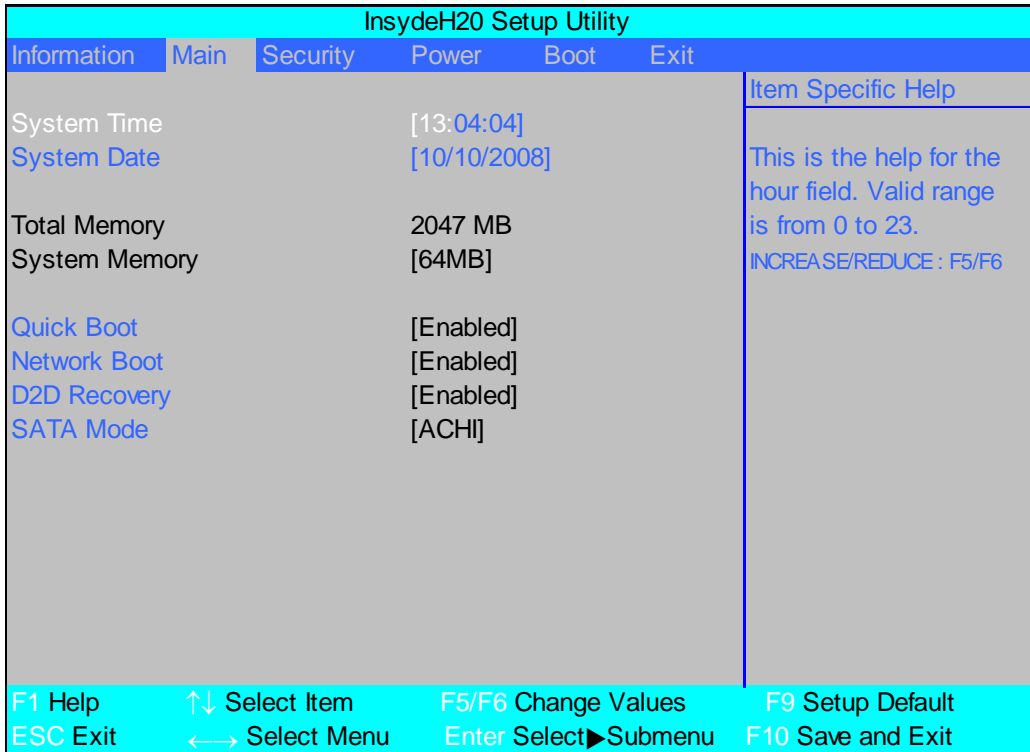

NOTE: The screen above is for your reference only. Actual values may differ.

The table below describes the parameters in this screen. Settings in **boldface** are the default and suggested parameter settings.

Parameter	Description	Format/Option
System Time	Sets the system time. The hours are displayed with 24-hour format.	Format: HH:MM:SS (hour:minute:second)
System Date	Sets the system date.	Format MM/DD/YYYY (month/day/year)
Total Memory	This field reports the total memory size. Memory size is fixed to 2047 MB.	N/A
System Memory	This field reports the System Memory size.	Option: 32, 64 , 128, 246, 512, or 1024.
Quick Boot	Enables the boot sequence to skip some processes to boot up more quickly.	Option: Enabled or Disabled
Network Boot	Enables, disables the system boot from LAN (remote server).	Option: Enabled or Disabled
D2D Recovery	Enables, disables D2D Recovery function. The function allows the user to create a hidden partition on hard disc drive to store operation system and restore the system to factory defaults.	Option: Enabled or Disabled
SATA Mode	Control the mode in which the SATA controller should operate.	Option: ACHI or IDE

Security

The Security screen contains parameters that help safeguard and protect your computer from unauthorized use.

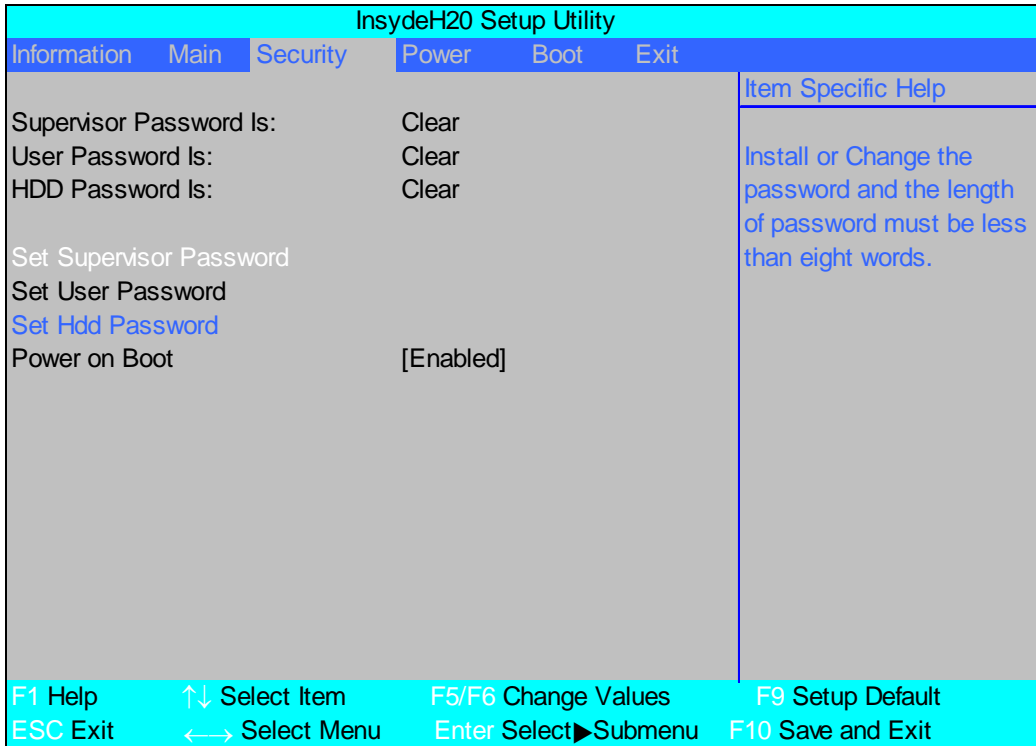

The table below describes the parameters in this screen. Settings in **boldface** are the default and suggested parameter settings.

Parameter	Description	Option
Supervisor Password Is	Shows the setting of the Supervisor password	Clear or Set
User Password Is	Shows the setting of the user password.	Clear or Set
HDD Password Is	Shows the setting of the hard disk password.	Clear or Set
Set Supervisor Password	Press Enter to set the supervisor password. When set, this password protects the BIOS Setup Utility from unauthorized access. The user can not either enter the Setup menu nor change the value of parameters.	N/A
Set User Password	Press Enter to set the user password. When user password is set, this password protects the BIOS Setup Utility from unauthorized access. The user can enter Setup menu only and cannot change parameters.	N/A
Set Hdd Password	Press Enter to set the user password. When user password is set, this password protects the BIOS Setup Utility from unauthorized access. The user can enter Setup menu only and cannot change parameters.	N/A
Password on Boot	Defines whether a password is required or not while the events defined in this group happened. The following sub-options are all requires the Supervisor password for changes and should be grayed out if the user password was used to enter setup.	Disabled or Enabled

NOTE: When you are prompted to enter a password, you have three tries before the system halts. Don't forget your password. If you forget your password, you may have to return your notebook computer to your dealer to reset it.

Setting a Password

Follow these steps as you set the user or the supervisor password:

1. Use the ↑ and ↓ keys to highlight the Set Supervisor Password parameter and press the **Enter** key. The Set Supervisor Password box appears:

Set Supervisor Password		
Enter New Password	[]
Confirm New Password	[]

2. Type a password in the “Enter New Password” field. The password length can not exceeds 8 alphanumeric characters (A-Z, a-z, 0-9, not case sensitive). Retype the password in the “Confirm New Password” field.

IMPORTANT: Be very careful when typing your password because the characters do not appear on the screen.

3. Press **Enter**. After setting the password, the computer sets the User Password parameter to “Set”.
4. If desired, you can opt to enable the Password on boot parameter.
5. When you are done, press F10 to save the changes and exit the BIOS Setup Utility.

Removing a Password

Follow these steps:

1. Use the ↑ and ↓ keys to highlight the Set Supervisor Password parameter and press the **Enter** key. The Set Password box appears:

Set Supervisor Password		
Enter current password	[]
Enter New Password	[]
Confirm New Password	[]

2. Type the current password in the Enter Current Password field and press **Enter**.
3. Press **Enter** twice **without** typing anything in the Enter New Password and Confirm New Password fields. The computer then sets the Supervisor Password parameter to “Clear”.
4. When you have changed the settings, press u to save the changes and exit the BIOS Setup Utility.

Changing a Password

1. Use the ↑ and ↓ keys to highlight the Set Supervisor Password parameter and press the **Enter** key. The Set Password box appears.

Set Supervisor Password		
Enter current password	[]
Enter New Password	[]
Confirm New Password	[]

2. Type the current password in the Enter Current Password field and press **Enter**.
3. Type a password in the Enter New Password field. Retype the password in the Confirm New Password field.
4. Press **Enter**. After setting the password, the computer sets the User Password parameter to “Set”.
5. If desired, you can enable the Password on boot parameter.
6. When you are done, press F10 to save the changes and exit the BIOS Setup Utility.

If the verification is OK, the screen will display as following.

Setup Notice
Changes have been saved.
[continue]

The password setting is complete after the user presses **Enter**.

If the current password entered does not match the actual current password, the screen will show you the Setup Warning.

Setup Warning
Invalid password
Re-enter Password
[continue]

If the new password and confirm new password strings do not match, the screen will display the following message.

Setup Warning
Password do not match
Re-enter Password

Power

The Power screen allows the user to configure CPU and power management options.

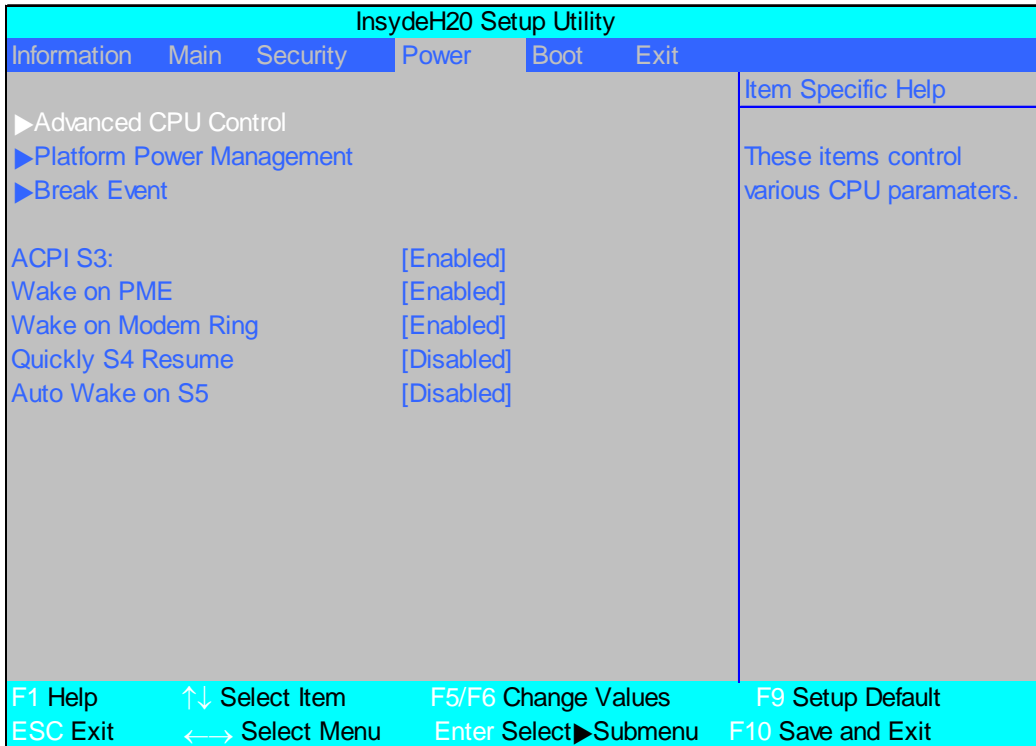

The table below describes the items, menus, and submenus in this screen. Settings in **boldface** are the default and suggested parameter settings.

Parameter	Description	Submenu Items
Advanced CPU Control	Enter the Advanced CPU Control menu.	<ul style="list-style-type: none"> • P-States (IST) • Boot performance mode • Thermal Mode • CMP Support • Use XD capability • VT Support • C-States • Enhanced C-States • C-State Pop Up Mode • C-State Pop Down Mode • C4 Exit Timing Mode • DeepC4 • Hard C4E • Enable C6 • EMTTM • Bi-directional PROCHOT# • Dynamic FSB Switching • Turbo Mode • ACPI 3.0 T-States • DTS • DTS Calibration • Thermal Trip Points Setting (Fan On Temp., Throttle On Temp.)

Parameter	Description	Submenu Items
Platform Power Management	Enter the Platform Power Management menu.	<ul style="list-style-type: none"> • PCI Clock Run • _CST - C4 Latency Value • C4 on C3 - Deeper Sleep
Break Event	Enter the Break Event menu.	<ul style="list-style-type: none"> •
ACPI S3	Enable or Disable ACPI S1/S3 Sleep State.	N/A
Wake on PME	Enable or Disable wake up when the system power is off and a PCI Power Management Enable wake up event occurs.	N/A
Wake on Modem Ring	Enable or Disable wake up when the system power is off and a modem attached to the serial port is ringing.	N/A
Quickly S4 Resume	Disable or Enable optional quick boot from S4 Resume.	N/A
Auto wake on S5	Disable or Enable auto wake up by date and time or at a fixed time everyday.	N/A

Boot

This menu allows the user to decide the order of boot devices to load the operating system. Bootable devices includes the USB diskette drives, the onboard hard disk drive and the DVD drive in the module bay.

InsydeH20 Setup Utility					
Information	Main	Security	Power	Boot	Exit
Boot priority order: 1. IDE0 : WDC WD1200BEVS-22UST0 2. IDE1 : TSSTcorp CDWDVD TS-L463A 3. USB FFD : 4. Network Boot : Realtek Boot Agent 5. USB HDD : 6. USB CDROM :					Item Specific Help
					Use <↑> or <↓> to select a device, then press <F5> to move it down the list, or <F6> to move it up the list. Press <Esc> to escape the menu
F1 Help	↑↓ Select Item	F5/F6 Change Values	F9 Setup Default		
ESC Exit	←→ Select Menu	Enter Select▶ SubMenu	F10 Save and Exit		

Exit

The Exit screen allows you to save or discard any changes you made and quit the BIOS Utility.

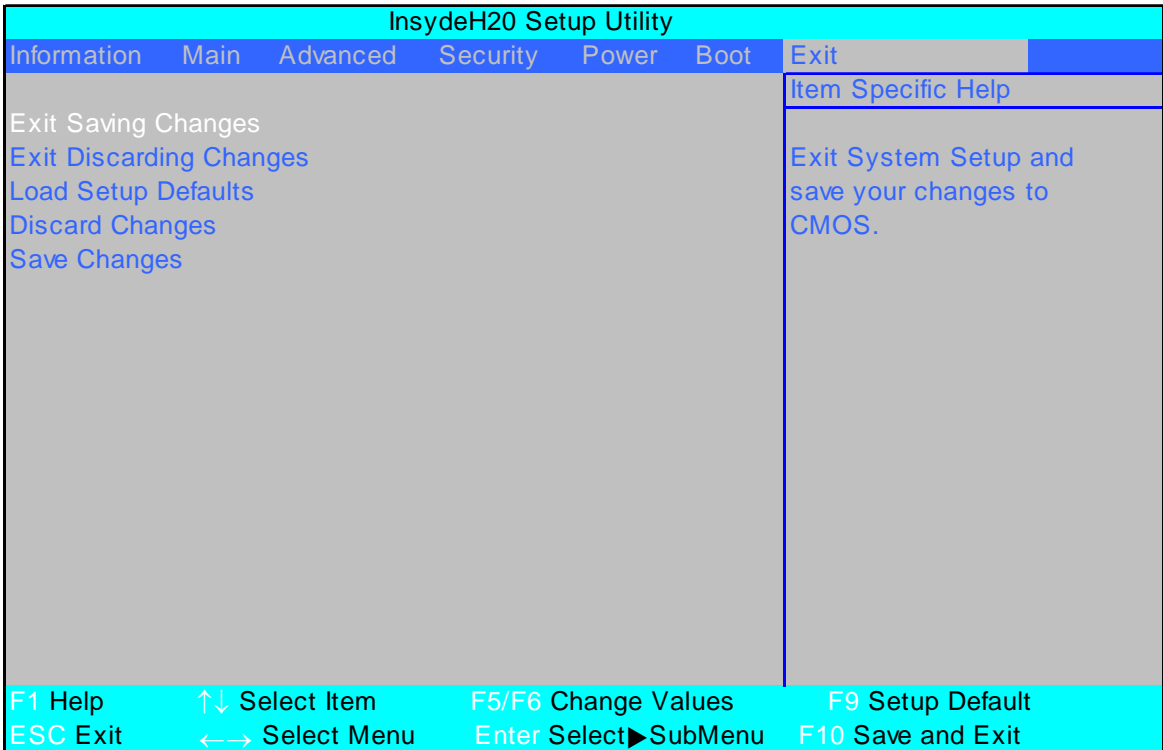

The table below describes the parameters in this screen.

Parameter	Description
Exit Saving Changes	Exit System Setup and save your changes to CMOS.
Exit Discarding Changes	Exit utility without saving setup data to CMOS.
Load Setup Default	Load default values for all SETUP item.
Discard Changes	Load previous values from CMOS for all SETUP items.
Save Changes	Save Setup Data to CMOS.

BIOS Flash Utilities

The BIOS flash memory update is required for the following conditions:

- New versions of system programs
- New features or options
- Restore a BIOS when it becomes corrupted.

Use the Phlash utility to update the system BIOS flash ROM.

NOTE: If you do not have a crisis recovery diskette at hand, then you should create a **Crisis Recovery Diskette** before you use the Phlash utility.

NOTE: Do not install memory-related drivers (XMS, EMS, DPMI) when you use the Phlash.

NOTE: Please use the AC adaptor power supply when you run the Phlash utility. If the battery pack does not contain enough power to finish BIOS flash, you may not boot the system because the BIOS is not completely loaded.

Follow the steps below to run the Phlash.

1. Prepare a bootable diskette.
2. Copy the flash utilities to the bootable diskette.
3. Then boot the system from the bootable diskette. The flash utility has auto-execution function.

DOS Flash Utility

Perform the following steps to use the DOS Flash Utility:

1. Press F2 during boot to enter the Setup Menu.
2. Select **Boot Menu** to modify the boot priority order, for example, if using USB HDD to Update BIOS, move USB HDD to position 1.

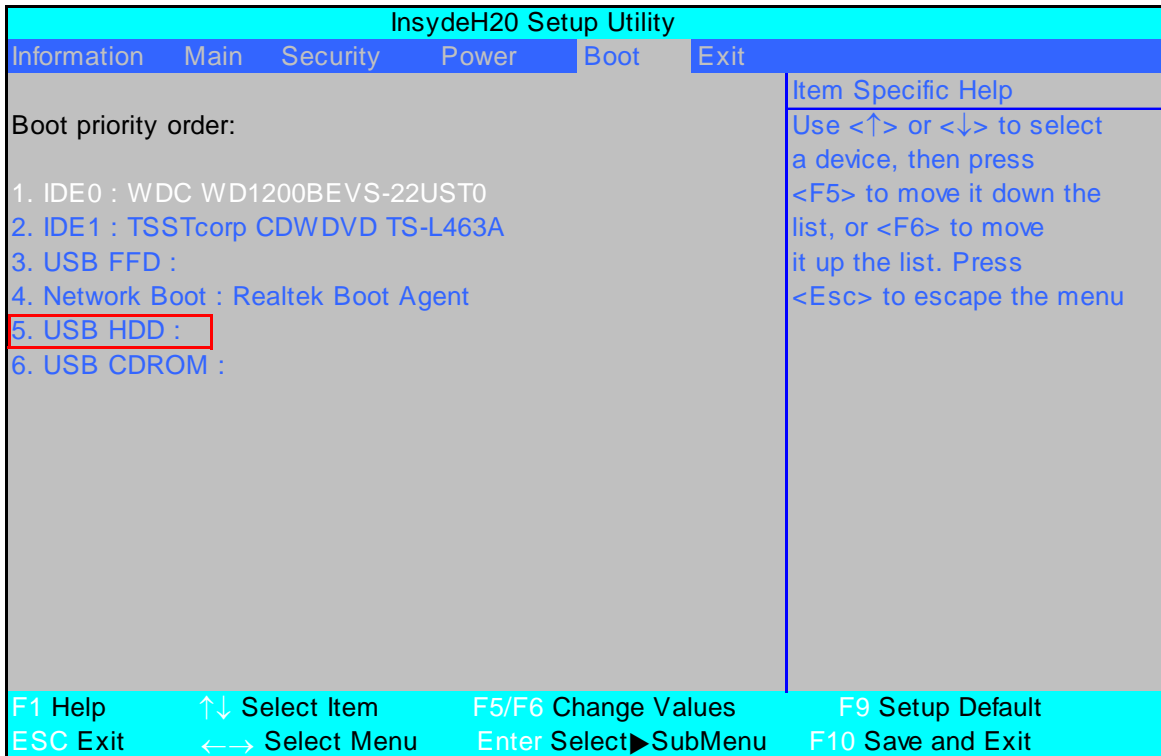

3. Execute the **IFLASH.BAT** batch file to update BIOS.

The flash process begins as shown.



Remove HDD/BIOS Password Utilities

This section provide you with removing HDD/BIOS method:

Remove HDD Password:

When the user keys in the wrong password three times, the system reports the following error code to user.

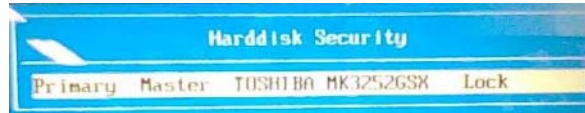

To unlock the HDD password, perform the following steps:

1. Press **Enter** to display the Select Item screen.

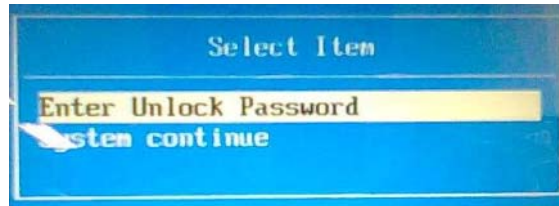

2. Select **Enter Unlock Password** and press **Enter**.

An Unlock Password displays.



3. Make a note of the key, **76943488** in the example.
4. Boot up the system and open a DOS prompt.
5. Enter the **UnlockHD.EXE** command and input the key to create an unlock code. Make a note of the result, for example **46548274**.
6. Reboot and enter the BIOS by pressing F2 when prompted.
7. Go to the Security menu and select Set Hdd Password (see "Security" on page 28).



8. Enter the unlock code generated by UnlockHD.EXE as the current password, **46548274** in the example, and complete the **New Password** and **Confirm** fields to create a new HDD password.
9. Save and exit the BIOS to complete the process.

Removing BIOS Passwords:

If you key in the wrong Supervisor Password three times, System Disabled displays on the screen. See the image below.

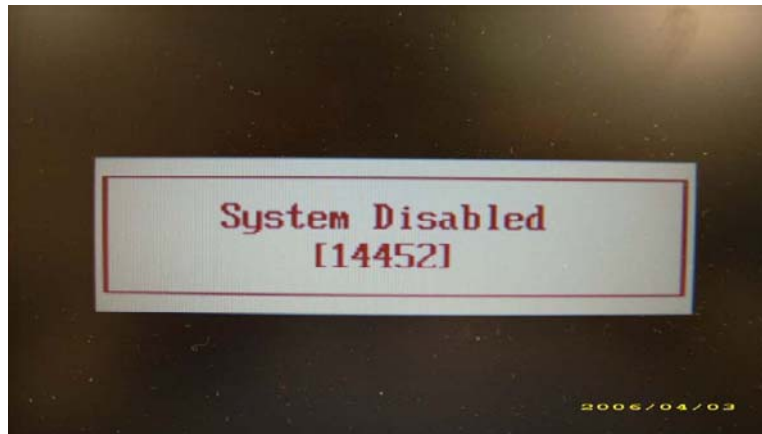

To reset the BIOS password, run BIOS_PW.EXE as follows:

1. Key in **bios_pw 14452 0**
2. Select one string from the list.

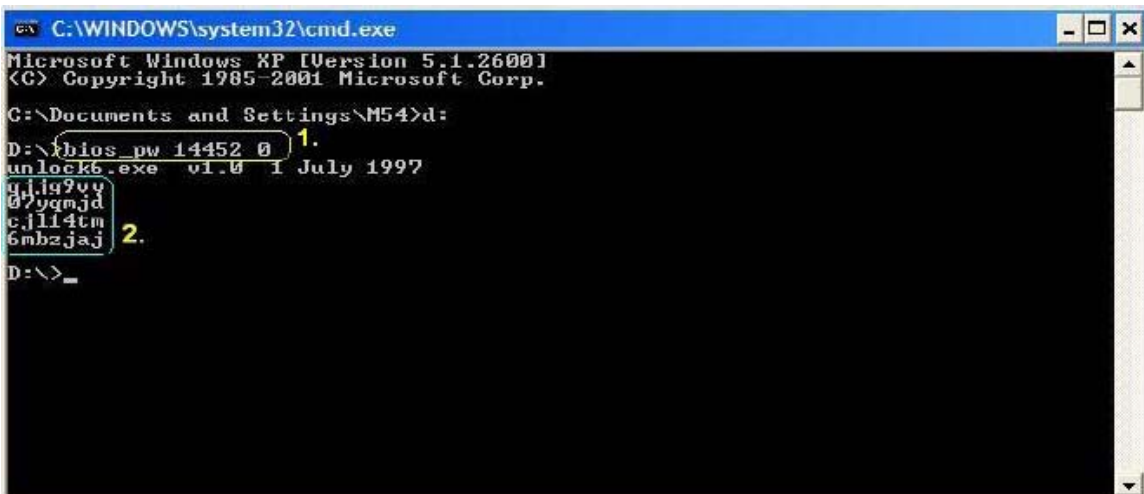

```
C:\WINDOWS\system32\cmd.exe
Microsoft Windows XP [Version 5.1.2600]
Copyright 1985-2001 Microsoft Corp.
C:\Documents and Settings\M54>d:
D:\>bios_pw 14452 0 1.
unlock6.exe v1.0 1 July 1997
qj119900
0?yqmjd
c.jl14tm
6mbzjaj 2.
D:\>_
```

3. Reboot the system and key in the selected string (qjig9vy, 07yqmjd etc.) for the BIOS user password.

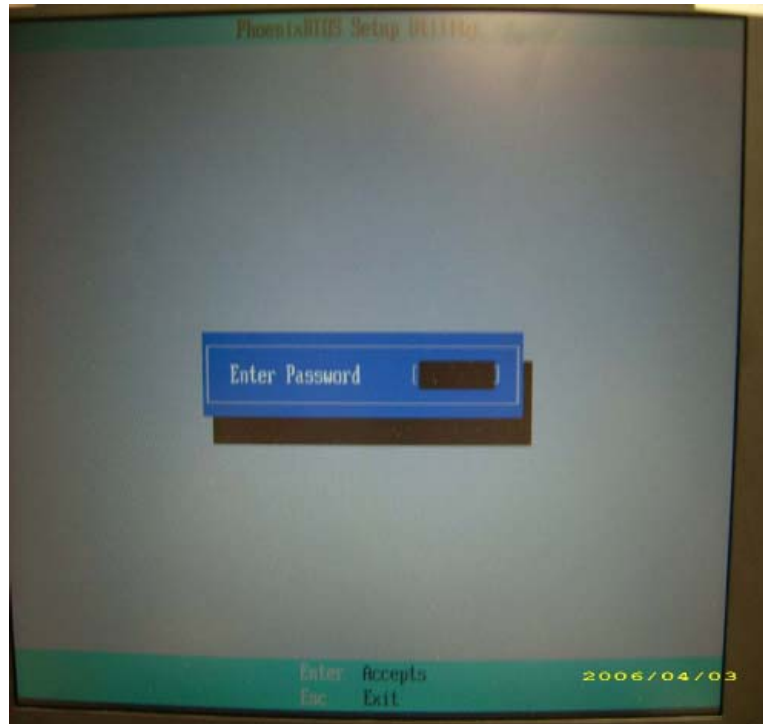

Cleaning BIOS Passwords

To clear the password, perform the following steps:

1. From a DOS prompt, Execute **clnpwd.exe**

```
d:\Clnpwd>clnpwd
ACER Clean Password Utility V1.00
Press 1 or 2 to clean any password shown as below
  1.User Password
  2.Supervisor Password

Clean User Password Successfully!
```

2. Press 1 or 2 to clean the desired password shown on the screen.

The onscreen message determines whether the function is successful or not.

Miscellaneous Utilities

Using Boot Sequence Selector

Boot Sequence Selector allows the boot order to be changes without accessing the BIOS. To use Boot Sequence Selector, perform the following steps:

1. Enter into DOS.
2. Execute **BS.exe** to display the usage screen.

```
d:\B00TSEQ>bs
*** Boot Sequence Selector Version 0.03 ***
Create by Rockwell Chuang 10/01/2005.
Usage:
      BS [ 1 | 2 | 3 | 4 ]
BS 1 : [ Floppy ] => [ HardDisk ] => [ CD-ROM ] => [ LAN ]
BS 2 : [ HardDisk ] => [ CD-ROM ] => [ LAN ] => [ Floppy ]
BS 3 : [ CD-ROM ] => [ HardDisk ] => [ LAN ] => [ Floppy ]
BS 4 : [ LAN ] => [ Floppy ] => [ HardDisk ] => [ CD-ROM ]
d:\B00TSEQ>
```

3. Select the desired boot sequence by entering the corresponding sequence, for example, enter **BS2** to change the boot sequence to HDD|CD ROM|LAN|Floppy.

Using DMITools

The DMI (Desktop Management Interface) Tool copies BIOS information to eeprom to be used in the DMI pool for hardware management.

When the BIOS displays **Verifying DMI pool data** it is checking the table correlates with the hardware before sending to the operating system (Windows, etc.).

To update the DMI Pool, perform the following steps:

1. Enter into DOS.
2. Execute **dmitools**. The following messages show dmitools usage:
 - dmitools /r ==> Read dmi string from memory
 - dmitools /wm xxxx ==> Write manufacturer name to EEPROM (max. 16 characters)
 - dmitools /wp xxxx ==> Write product name to EEPROM (max. 16 characters)
 - dmitools /ws xxxx ==> Write serial number to EEPROM (max. 22 characters)
 - dmitools /wu xxxx ==> Write uuid to EEPROM (Ignore String)
 - dmitools /wa xxxx ==> Write asset tag to EEPROM (max. 32 characters)

NOTE: The following write examples (2 to 5) require a system reboot to take effect

Example 1: Read DMI Information from Memory

Input:

```
dmitools /r
```

Output:

```
Manufacturer (Type1, Offset04h): Acer
Product Name (Type1, Offset05h): eMachines xxxxx
Serial Number (Type1, Offset07h): 01234567890123456789
UUID String (Type1, Offset08h): xxxxxxxx-xxxx-xxxx-xxxx-xxxxxxxxxxxx
Asset Tag (Type3, Offset04h): Acer Asstag
```

Example 2: Write Product Name to EEPROM

Input:

```
dmitools /wp Acer
```

Example 3: Write Serial Number to EEPROM

Input:

```
dmitools /ws 01234567890123456789
```

Example 4: Write UUID to EEPROM

Input:

```
dmitools /wu
```

Example 5: Write Asset Tag to EEPROM

Input:

```
dmitools /wa Acer Asstag
```

Machine Disassembly and Replacement

IMPORTANT: The outside housing and color may vary from the mass produced model.

This chapter contains step-by-step procedures on how to disassemble the notebook computer for maintenance and troubleshooting.

Disassembly Requirements

To disassemble the computer, you need the following tools:

- Wrist grounding strap and conductive mat for preventing electrostatic discharge
- Flat screwdriver
- Philips screwdriver
- Plastic flat screwdriver
- Plastic tweezers

NOTE: The screws for the different components vary in size. During the disassembly process, group the screws with the corresponding components to avoid mismatch when putting back the components.

General Information

Pre-disassembly Instructions

Before proceeding with the disassembly procedure, make sure that you do the following:

1. Turn off the power to the system and all peripherals.
2. Unplug the AC adapter and all power and signal cables from the system.



3. Place the system on a flat, stable surface.
4. Remove the battery pack.

Disassembly Process

The disassembly process is divided into the following stages:

- External module disassembly
- Main unit disassembly
- LCD module disassembly

The flowcharts provided in the succeeding disassembly sections illustrate the entire disassembly sequence. Observe the order of the sequence to avoid damage to any of the hardware components. For example, if you want to remove the main board, you must first remove the keyboard, then disassemble the inside assembly frame in that order.

Main Screw List

Screw	Quantity	Part Number
M2.5*4 (NL)	16	86.ATA02.001
M2.5*6 (NL)	13	86.ATA02.002
M2.5*8 (NL)	15	86.ATA02.003
M2*5 (NL)	4	86.ATA02.004
M2*3 (NL)	31	86.ATA02.005
M3*3 (NI)	6	86.ATA02.006
CPU THERMAL SCREW	4	86.ATA02.007

External Module Disassembly Process

IMPORTANT:The outside housing and color may vary from the mass produced model.

External Modules Disassembly Flowchart

The flowchart below gives you a graphic representation on the entire disassembly sequence and instructs you on the components that need to be removed during servicing. For example, if you want to remove the main board, you must first remove the keyboard, then disassemble the inside assembly frame in that order.

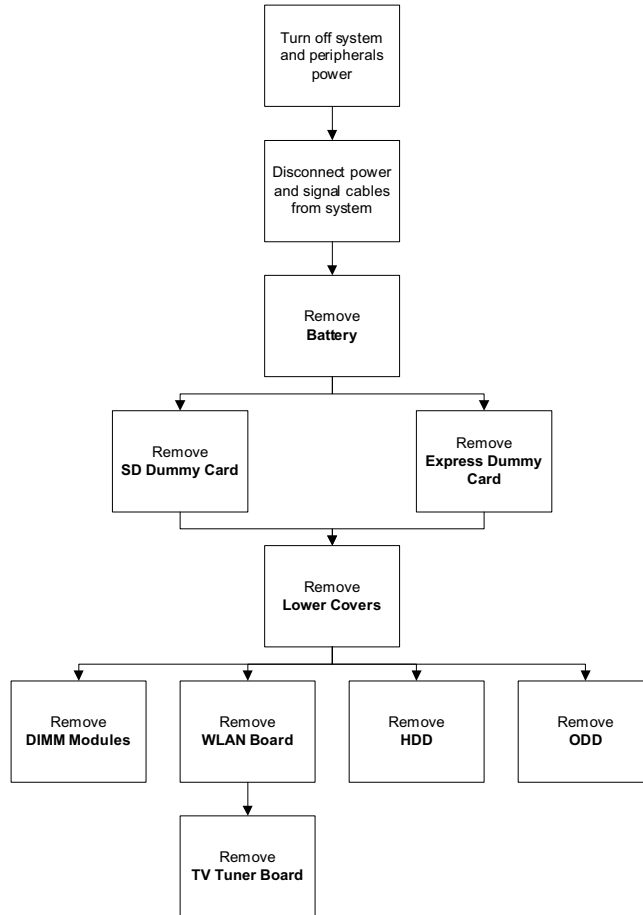

Screw List

Step	Screw	Quantity	Part No.
Memory Cover	M2.5*8 (NL)	1	86.ATA02.003
WLAN Cover	M2.5*8 (NL)	1	86.ATA02.003
WLAN Module	M2*3 (NL)	2	86.ATA02.005
WLAN Bracket	M2*3 (NL)	1	86.ATA02.005
TV Tuner Module	M2*3 (NL)	2	86.ATA02.005
HDD Carrier	M3*3 (NL)	4	86.ATA02.006
ODD Module	M2.5*6(NL)	1	86.ATA02.002
ODD Bracket	M2*3 (NL)	3	86.ATA02.005

Removing the Battery Pack

1. Turn computer over.
2. Slide the battery lock/unlock latch to the unlock position.



3. Slide and hold the battery release latch to the release position (1), then slide out the battery pack from the main unit (2).

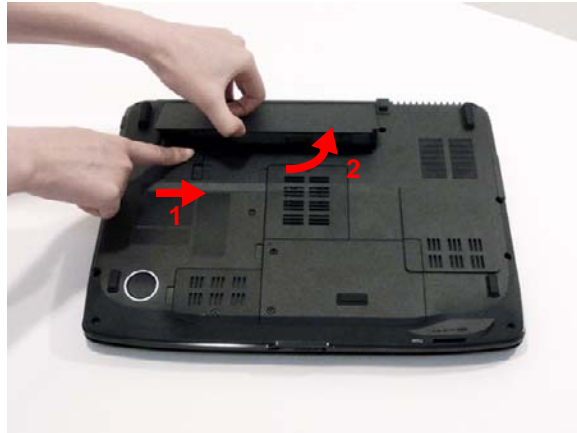

Removing the SD dummy card

1. Push the SD dummy card in to eject it.



2. Grasp the card and pull it out from the slot.



Removing the ExpressCard dummy card

1. Push the ExpressCard dummy card in to eject it.





2. Grasp the card and pull it out from the slot.

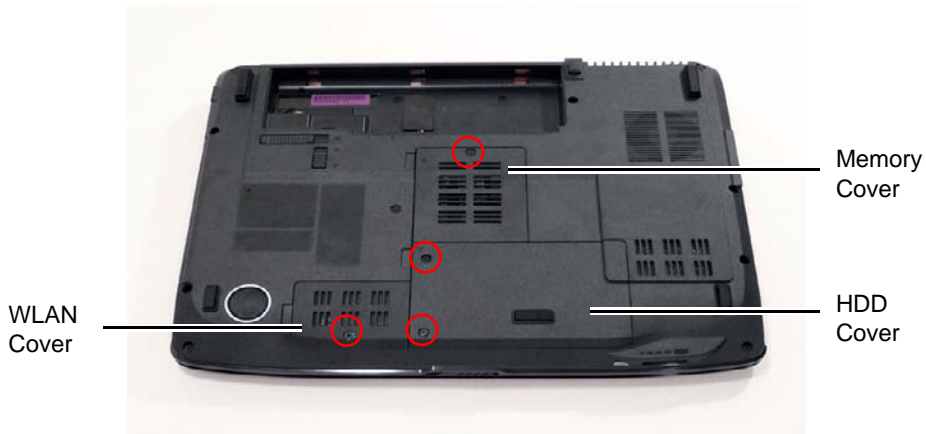

Removing the Lower Covers

1. See "Removing the Battery Pack" on page 46.
2. See "Removing the SD dummy card" on page 47.
3. See "Removing the ExpressCard dummy card" on page 48.
4. Remove the two screws from the Memory and WLAN bays and loosen the two captive HDD bay screws.



Step	Size	Quantity	Screw Type
Memory Cover	M2.5*8 (NL)	1	
WLAN Cover	M2.5*8 (NL)	1	

5. Carefully open the memory cover.

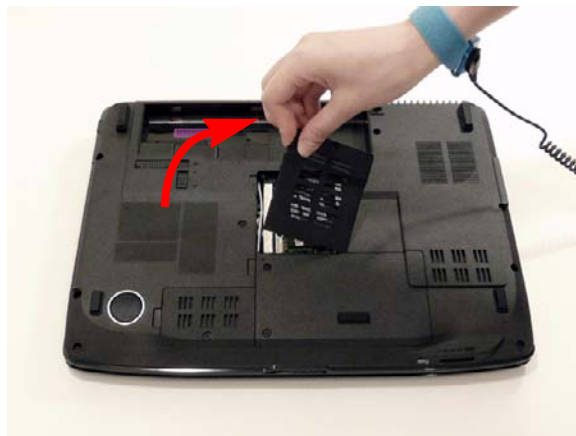

6. Remove the HDD cover as shown.



7. Remove the WLAN cover as shown.



Removing the DIMM Modules

1. Remove the Battery Pack. See “Removing the Battery Pack” on page 46.
2. Remove the Memory Module cover See “Removing the Lower Covers” on page 49.
3. Push out the release latches on both sides of the DIMM socket to release the DIMM module.

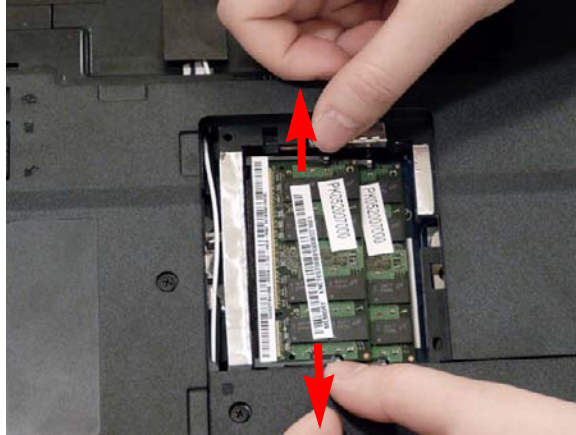

4. Remove the DIMM module.

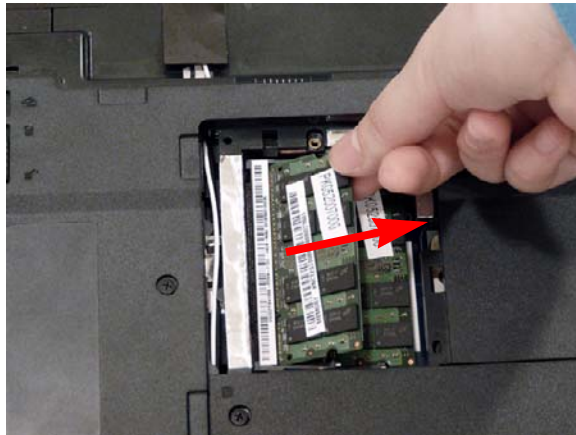

5. Repeat steps for the second DIMM module if present.

Removing the WLAN Module

1. See "Removing the Battery Pack" on page 46.
2. Remove the WLAN cover. See "Removing the Lower Covers" on page 49.
3. Disconnect the antenna cables from the WLAN board.



4. Move the antenna cables away and remove the two screws on the WLAN board to release the WLAN board.

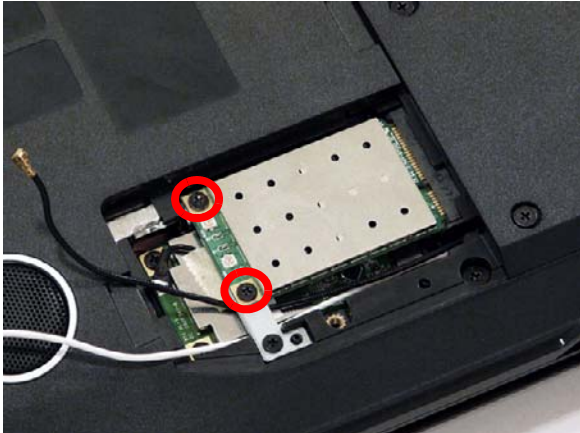

Step	Size	Quantity	Screw Type
WLAN Module	M2*3 (NL)	2	

5. Detach the WLAN board from the WLAN socket.

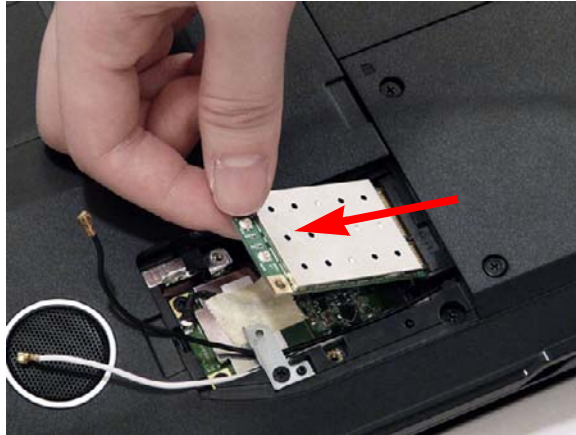

NOTE: When re-attaching the antenna to the WLAN board, make sure the cables are arranged under the WLAN bracket.

Removing the TV tuner Module

- 1. See "Removing the Lower Covers" on page 49.
- 1. Remove the securing screw, located on the WLAN bracket, and remove the bracket.
NOTE: Move the antenna cables out of the way to allow for easier access.



Step	Size	Quantity	Screw Type
WLAN Bracket	M2*3 (NL)	1	

- 2. Remove the adhesive strip to release the cable.

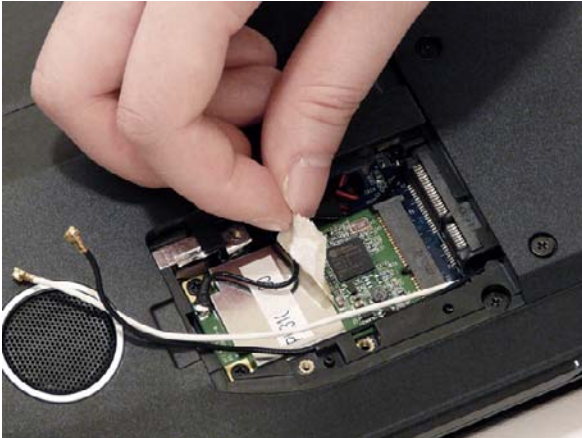



NOTE: Do not throw away the adhesive strip it is necessary to secure the cable on the new module.

3. Disconnect the cable from the TV tuner module.

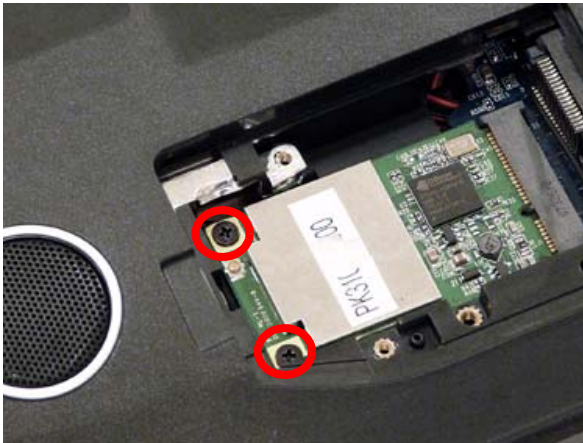

4. Remove the two securing screws.



Step	Size	Quantity	Screw Type
TV Tuner Module	M2*3 (NL)	2	

5. Remove the tv tuner module.

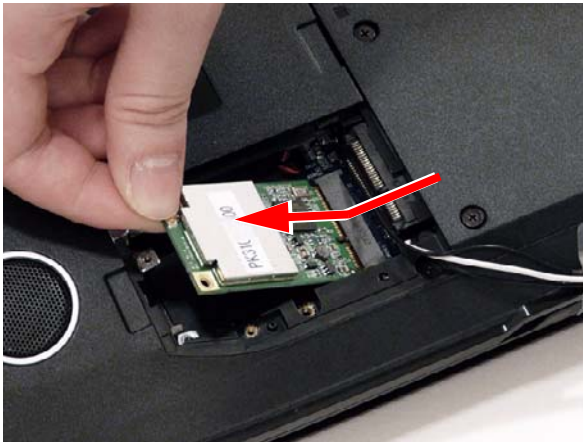

Removing the Hard Disk Drive Module

1. See "Removing the Battery Pack" on page 46.
2. Remove the HDD cover, See "Removing the Lower Covers" on page 49.
3. Use the mylar tab to slide and lift up the hard disk drive module to remove.

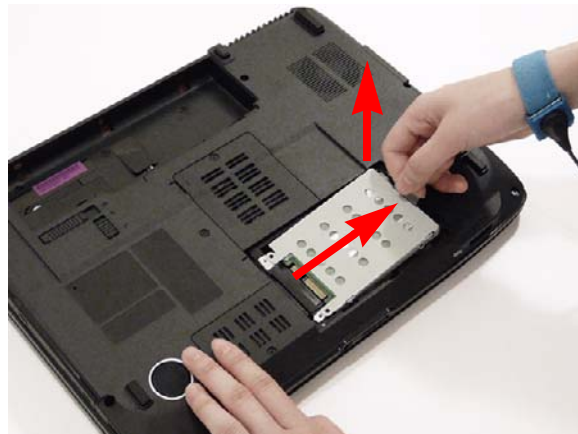
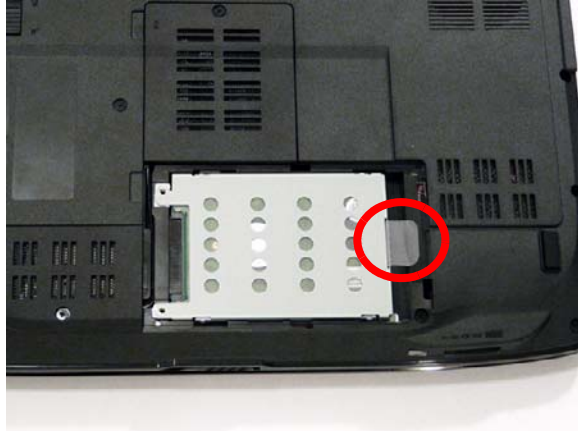

NOTE: To prevent damage to device, avoid pressing down on it or placing heavy objects on top of it.

4. Remove the four screws securing the hard disk to the carrier.

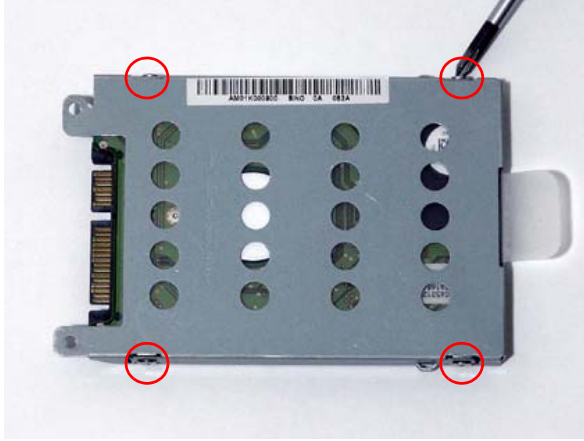

Step	Size	Quantity	Screw Type
HDD Carrier	M3*3 (NL)	4	

5. Remove the HDD from the carrier.

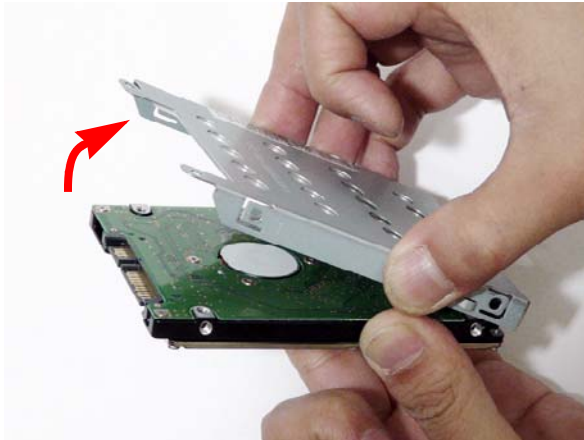

Removing the Optical Drive Module

1. Remove the Battery Pack. See "Removing the Battery Pack" on page 46.
2. Remove the Memory cover. See "Removing the Lower Covers" on page 49.
3. Remove the screw securing the ODD module.



Step	Size	Quantity	Screw Type
ODD Module	M2.5*6(NL)	1	

4. Grasp the front panel of the ODD and pull to remove from the main unit.

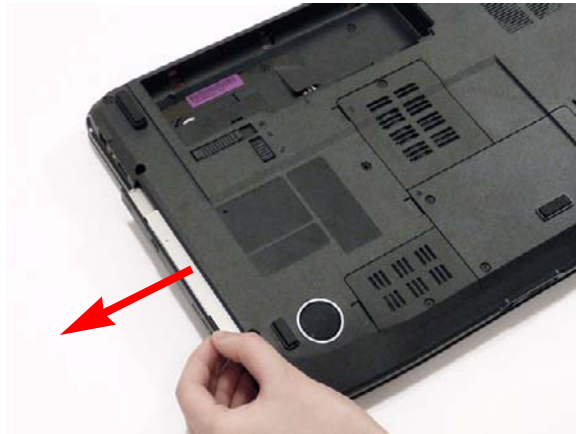

5. Remove the three screws securing the ODD bracket and remove the ODD bracket from the optical disk drive module.



Step	Size	Quantity	Screw Type
ODD Bracket	M2*3 (NL)	3	

6. Insert a pin in the eject hole of the ODD to eject the ODD tray.



7. Press down on the locking catch to release the ODD cover and remove.

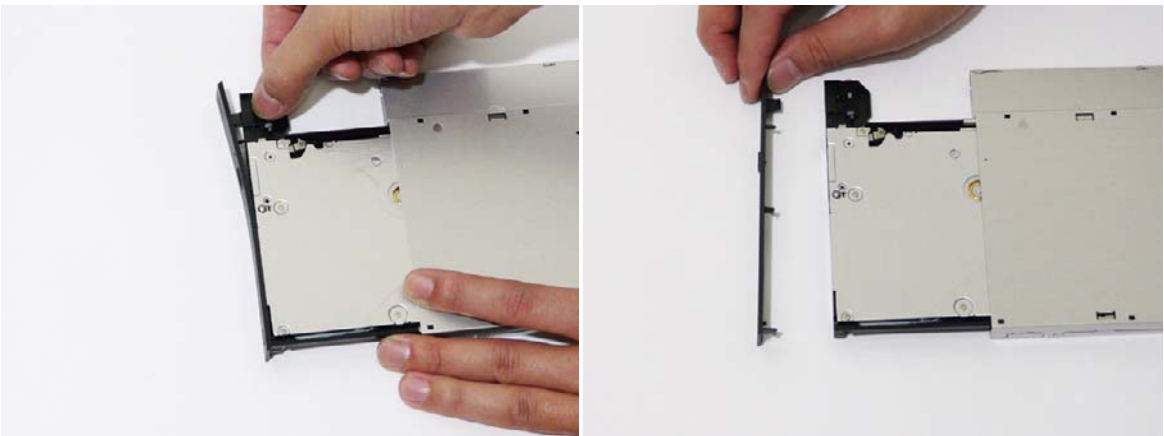

Main Unit Disassembly Process

IMPORTANT:The outside housing and color may vary from the mass produced model.

Main Unit Disassembly Flowchart

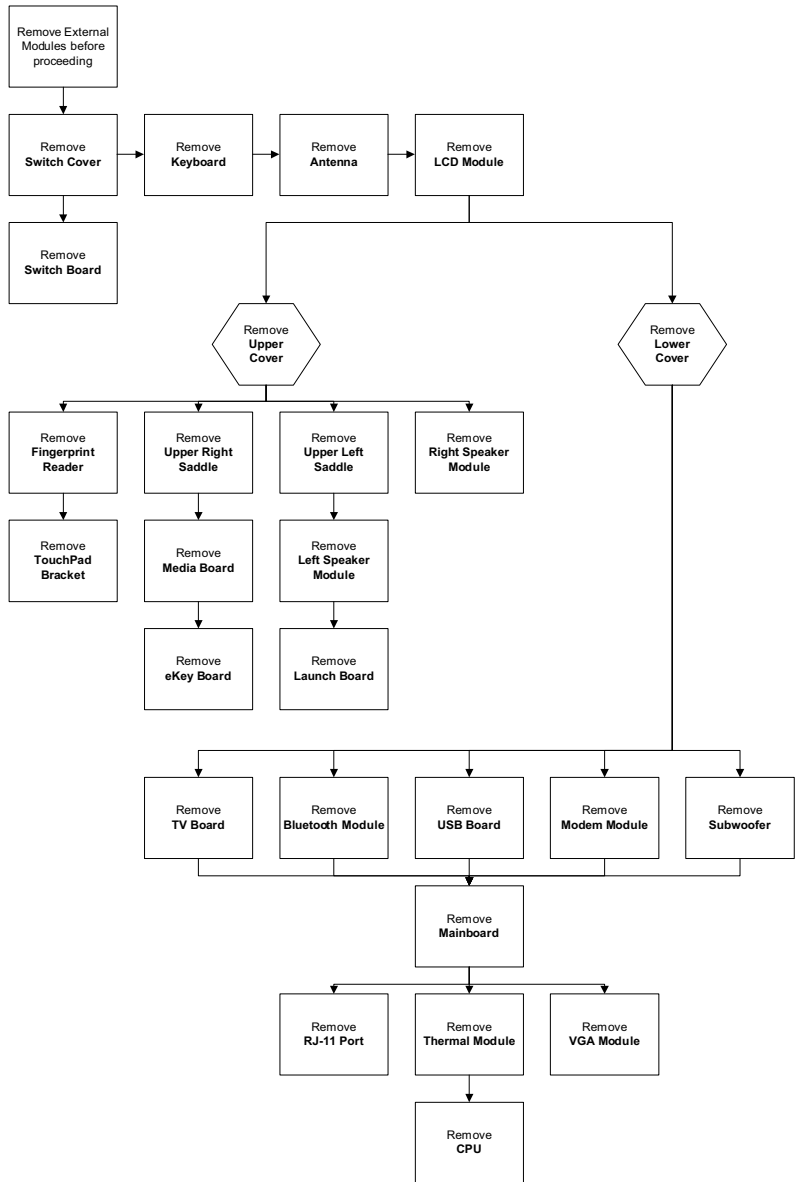

Screw List

Step	Screw	Quantity	Part No.
Switch Cover	M2*3 (NL)	3	86.ATA02.005
LCD Module	M2.5*8(NL)	4	86.ATA02.003
	M2.5*6 (NL)	2	86.ATA02.002
Upper Cover	M2.5*8 (NL)	9	86.ATA02.003
	M2.5*4 (NL)	5	86.ATA02.001

Step	Screw	Quantity	Part No.
Finger Print Reader	M2*3 (NL)	1	86.ATA02.005
Upper Right Saddle	M2*3 (NL)	2	86.ATA02.005
Left Speaker Module	M2.5*4 (NL)	2	86.ATA02.001
Upper Left Saddle	M2.5*4 (NL)	2	86.ATA02.001
TouchPad Bracket	M2*3 (NL)	2	86.ATA02.005
eKey Board	M2*3 (NL)	1	86.ATA02.005
Switch Board	M2.5*4 (NL)	1	86.ATA02.001
Right Speaker Module	M2.5*4 (NL)	2	86.ATA02.001
TV Board	M2.5*4 (NL)	2	86.ATA02.001
USB Board	M2.5*4 (NL)	2	86.ATA02.001
Modem Module	M2*3 (NL)	1	86.ATA02.005
Subwoofer	M2*3 (NL)	2	86.ATA02.005
Mainboard	M2.5*6 (NL)	2	86.ATA02.002
Thermal Module	M2*6.5	4	86.ATA02.007
	M2*5	4	86.ATA02.004
VGA Module	M3*3 (NL)	2	86.ATA02.006

Removing the Switch Cover

CAUTION: Using tools to remove the Switch Cover may cause damage to the outer casing. It is recommended that only fingers are used to remove the Switch Cover.

1. See "Removing the Battery Pack" on page 46.
2. Locate and remove the three securing screws as shown.

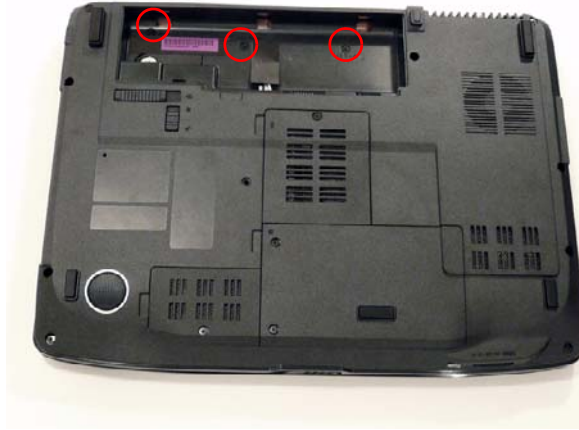

Step	Size	Quantity	Screw Type
Switch Cover	M2*3(NL)	3	

3. Turn the computer over and open the LCD module fully to expose the Switch Cover.
4. Lift the Switch Cover as shown, leftside first.



5. Lift the Switch Cover clear of the chassis.

Removing the Keyboard

1. See "Removing the Battery Pack" on page 46..
2. Push down on the two latches securing the keyboard to the upper case.



3. Turn the keyboard over and pull back the securing latch to release the FFC.



Removing the Antenna

WARNING: Do not attempt to pull the antenna cables under the WLAN bracket to prevent stripping of the cable.

1. See "Removing the WLAN Module" on page 52.
2. Remove the securing screw, located on the WLAN bracket, and remove the bracket.

NOTE: Move the antenna cables out of the way to allow for easier access.



3. Remove the Antenna Cables from the securing guides as shown.

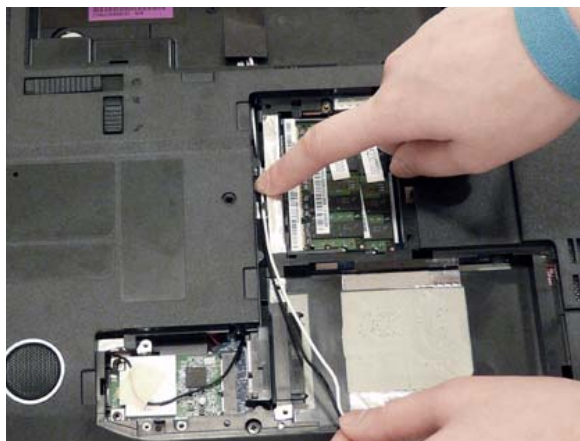
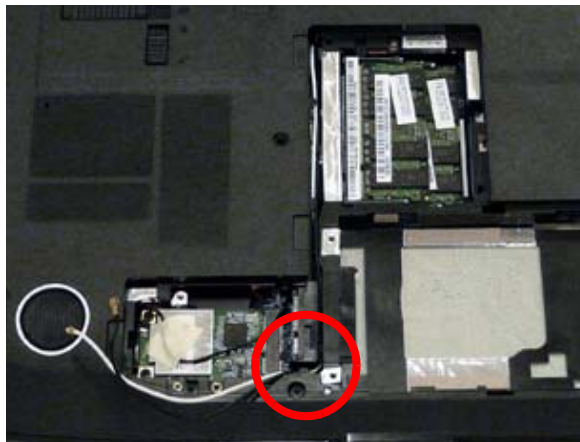

-
4. Using one hand, pull the cables completely through the battery housing.
NOTE: Do not remove the adhesive tape.

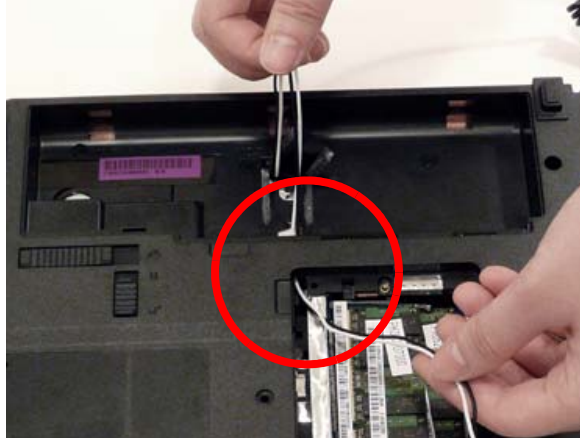



5. Push the cables through the chassis, then turn over the computer and pull them completely through.

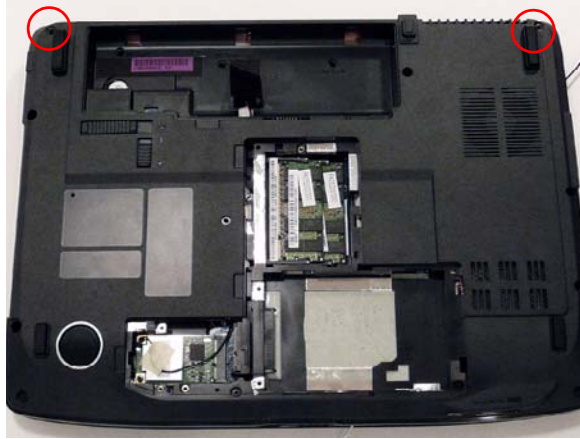

Removing the LCD Module

1. Remove the Antenna. Remove the Antenna. See "Removing the Antenna" on page 64.
2. Remove the two securing screws from the bottom of the chassis.



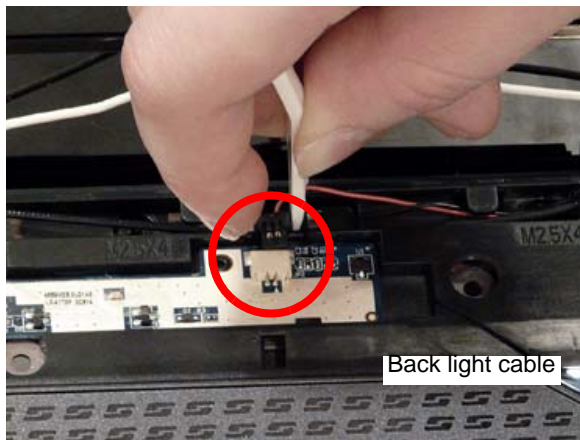
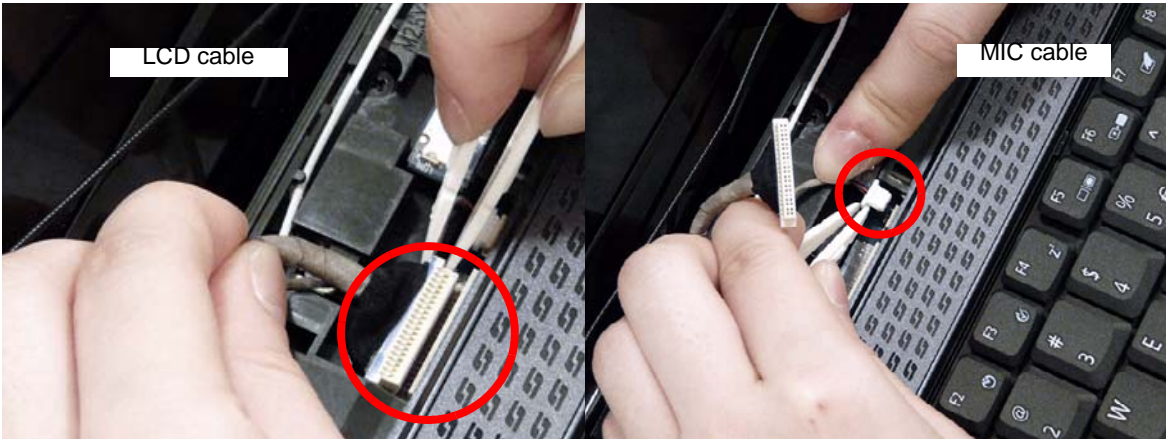

Step	Size	Quantity	Screw Type
LCD Module	M2.5*8(NL)	2	

3. Turn the computer over. Disconnect the LCD, MIC and back light cables from the top panel.

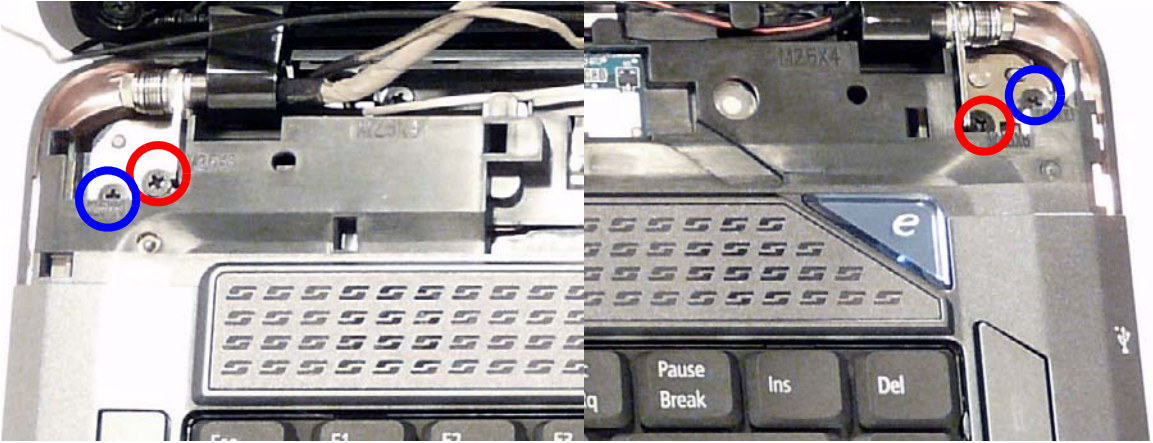

4. Remove the four securing screws (two on each side) connecting the LCD module.



Step	Size	Quantity	Screw Type
LCD Hinges (Red call out)	M2.5*6 (NL)	2	
LCD Hinges (Blue call out)	M2.5*8 (NL)	2	

5. Carefully remove the LCD module from the chassis.

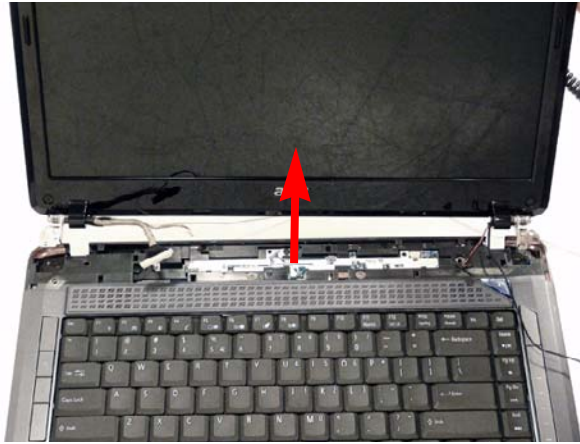

Removing the Upper Cover

1. Remove the LCD Module. See "Removing the LCD Module" on page 66.
2. Turn the computer over. Remove the nine screws on the bottom panel.

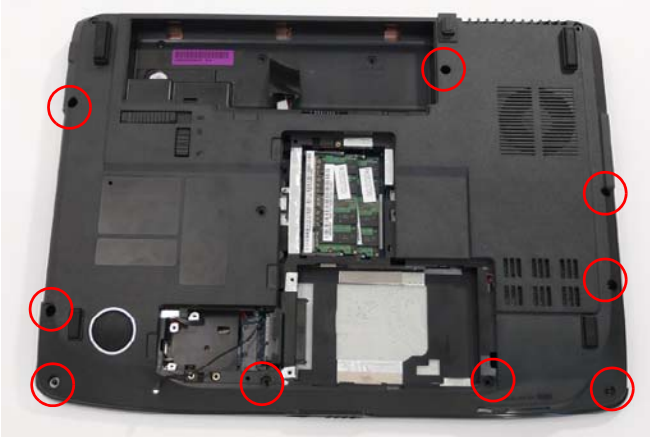

Step	Size	Quantity	Screw Type
Upper Cover	M2.5*8 (NL)	9	

3. Turn the computer over. Remove the five screws on the top panel.



Step	Size	Quantity	Screw Type
Upper Cover	M2.5*4 (NL)	5	

4. Disconnect the seven cables from the mainboard as shown.

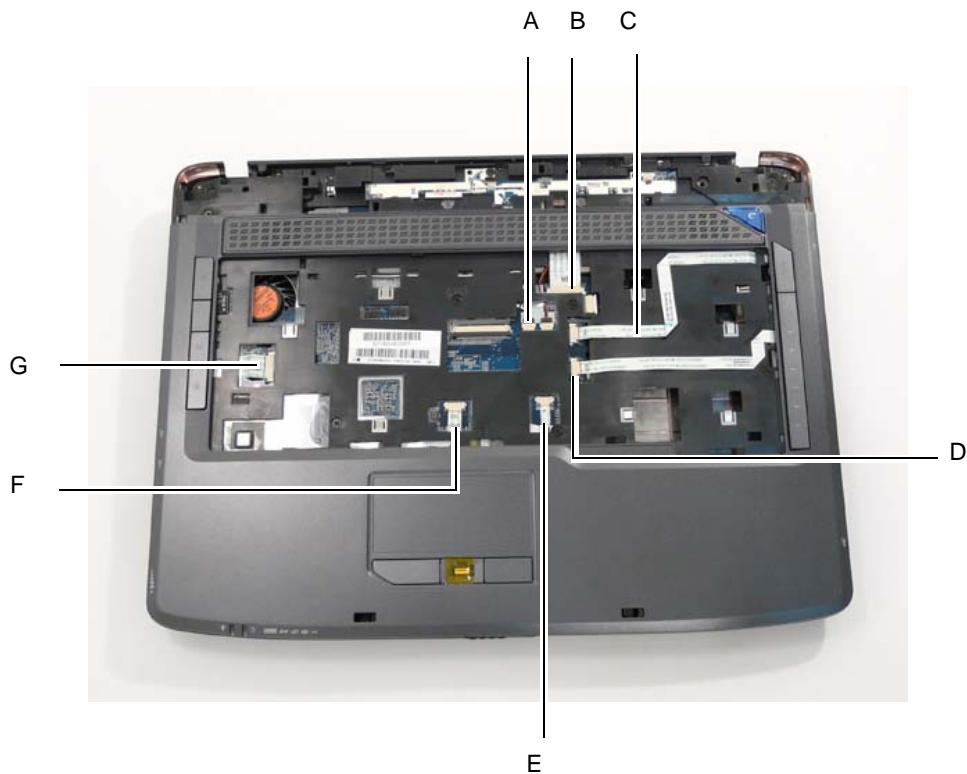

Disconnect A as shown.

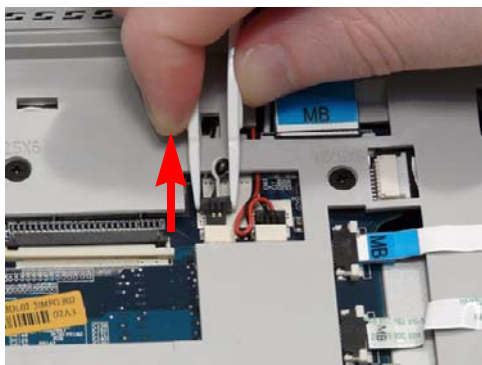

Release the securing latches and disconnect B as shown.

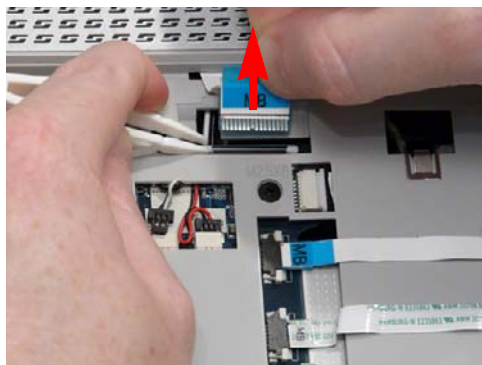

Release the securing latches and disconnect C as shown.

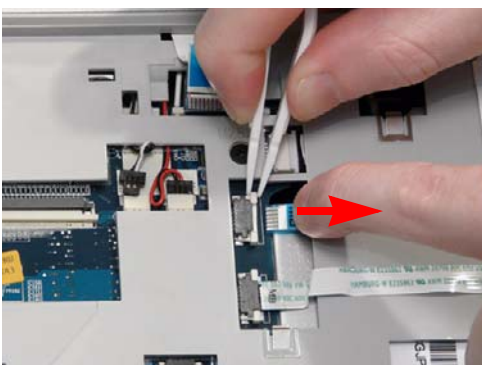

Release the securing latches and disconnect D as shown.

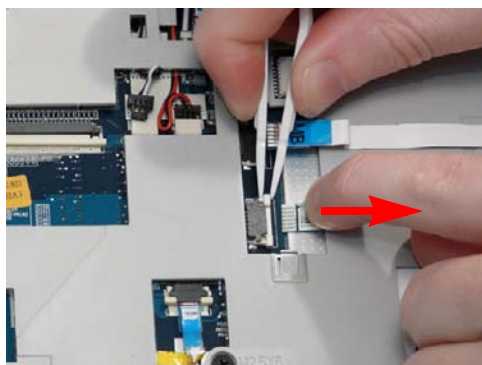

Release the securing latches and disconnect E as shown.

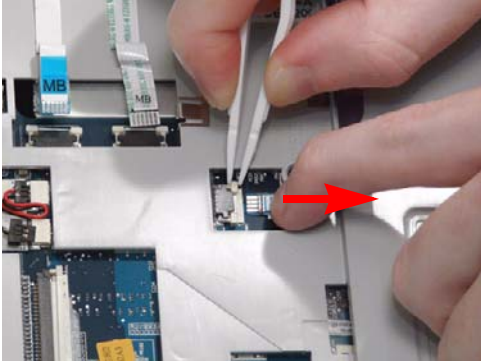

Release the securing latches and disconnect F as shown.

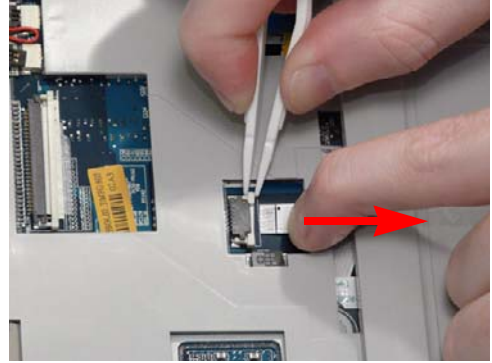

Release the securing latches and disconnect G as shown.



5. Remove the upper cover by lifting upward from the chassis, rear edge first.

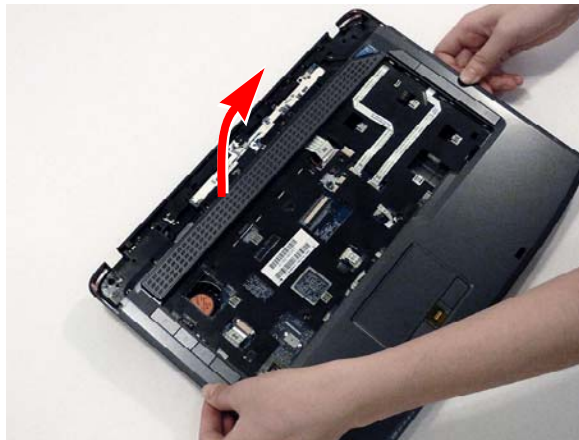

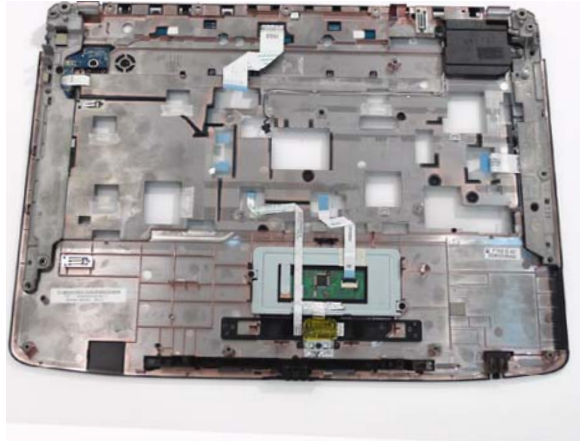

6. Turn the upper cover over. The upper cover appears as follows.

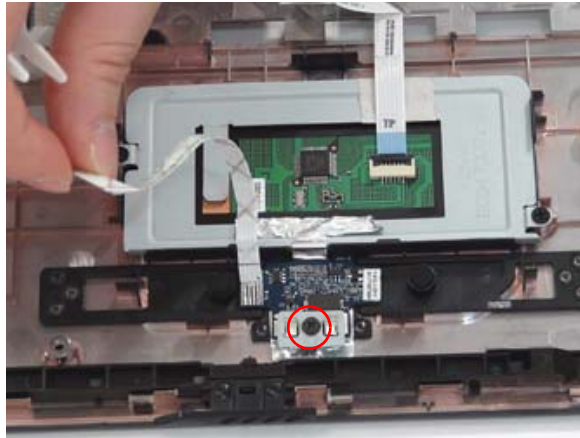

Removing the Finger Print Reader

1. See "Removing the Upper Cover" on page 68.
2. Remove the securing screw from the Finger Print Reader board, and ensure the FFC is free of the upper cover.



Step	Size	Quantity	Screw Type
Finger Print Reader	M2*3 (NL)	1	

3. Remove the board bracket from the Upper Cover.

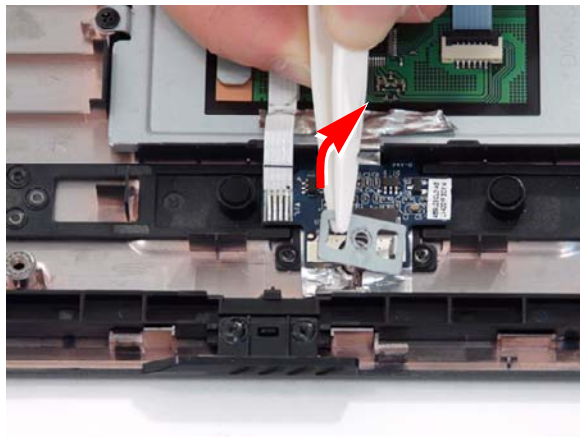

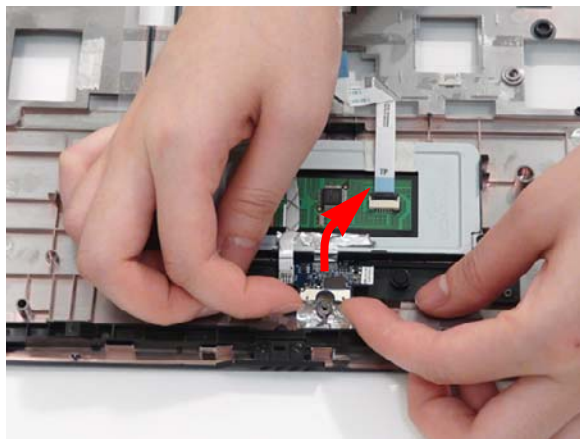

4. Using your fingers, gently lift the Finger Print Reader board from the Upper Cover.

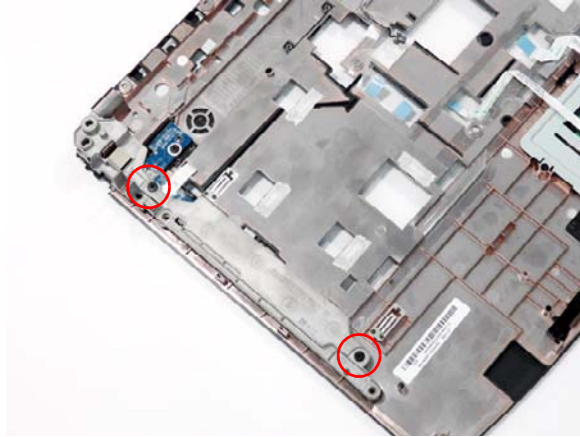

Removing the Upper Right Saddle

1. See "Removing the Upper Cover" on page 68.
2. Remove the two securing screws from the upper saddle.



Step	Size	Quantity	Screw Type
Upper Right Saddle	M2*3 (NL)	2	

3. Grasp the upper saddle and lift up to remove.

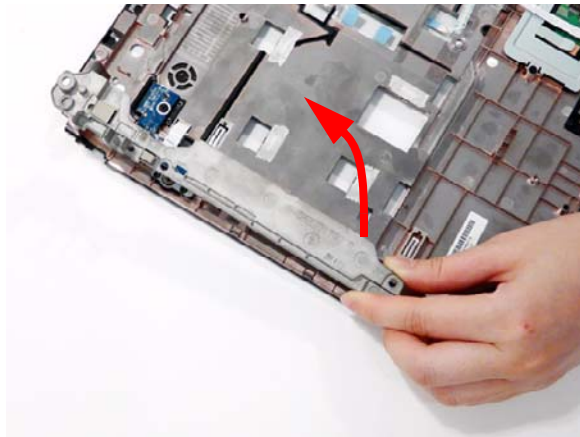

Removing the Left Speaker Module

1. See "Removing the Upper Cover" on page 68.
2. Remove the two securing screws from the left speaker.

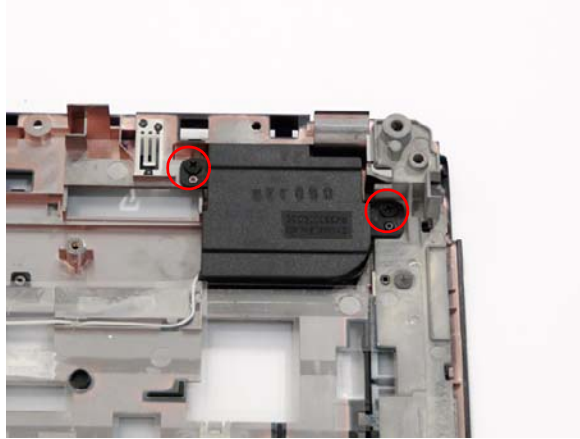

Step	Size	Quantity	Screw Type
Left Speaker Module	M2.5*4 (NL)	2	

3. Grasp both ends of the mylar cover and carefully pull back to expose the speaker cable.

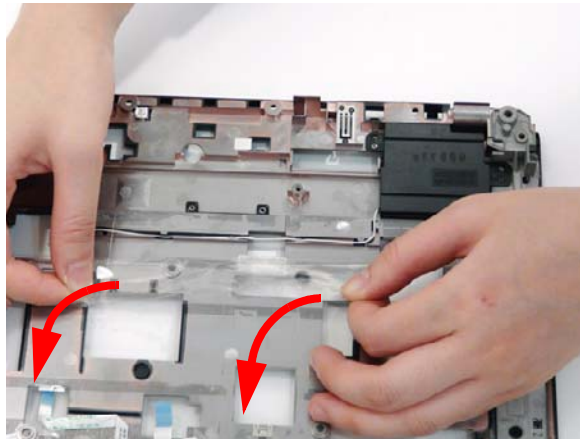

4. While holding the cover with one hand, pull back the speaker cable to remove it from the housing well.

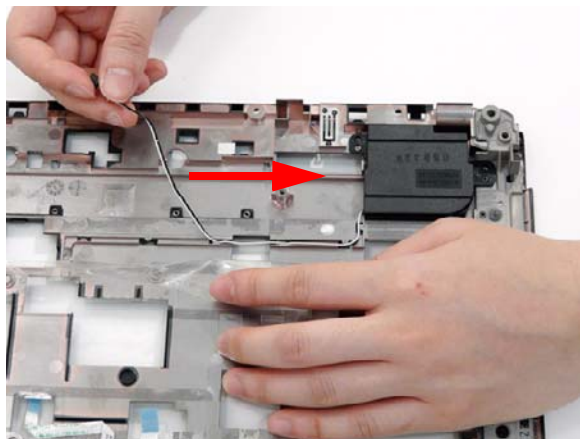

5. Remove the left speaker module as shown.

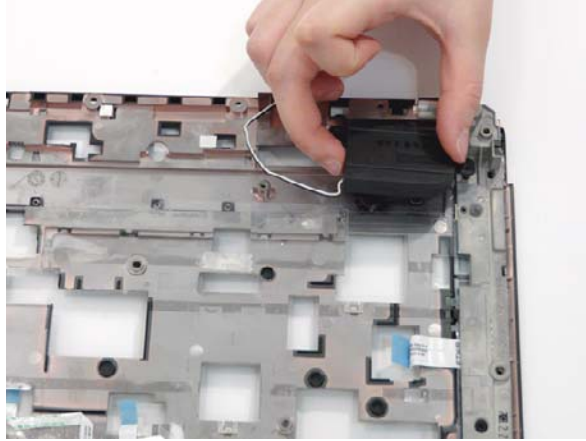

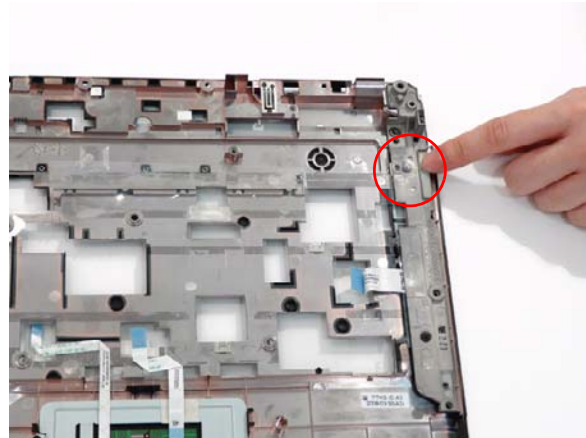

Removing the Upper Left Saddle

1. See "Removing the Upper Cover" on page 68.
2. Pull back the mylar cover to expose the top securing screw.

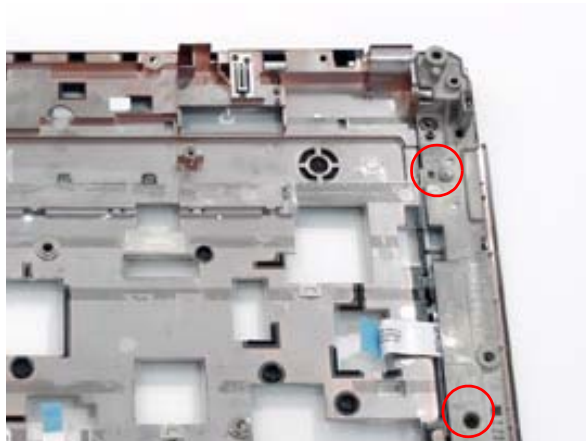

3. Remove the bottom securing screw.
4. While holding the cover back, remove the top securing screw.



Step	Size	Quantity	Screw Type
Upper Left Saddle	M2.5*4 (NL)	2	

5. Firmly lift and rotate the saddle counter-clockwise to remove, paying attention to the securing clip.

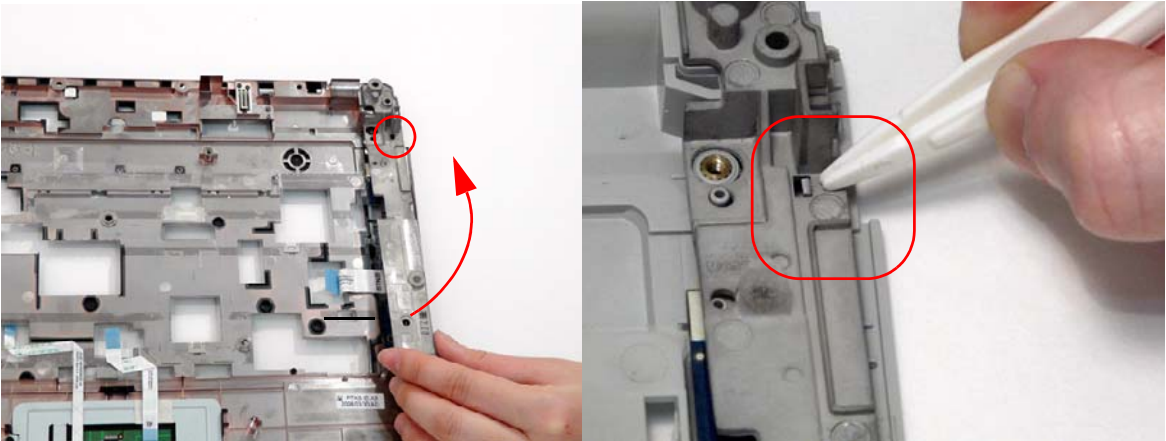

Removing the TouchPad Bracket

1. See “Removing the Upper Cover” on page 68.
2. Disconnect the TouchPad FFC from the TouchPad board.

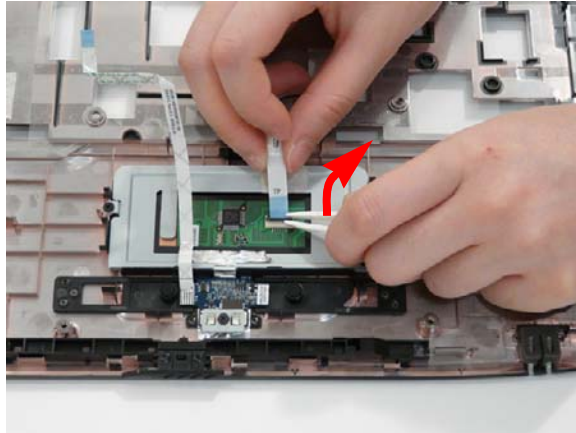

3. Move the Finger Print Reader FFC cable out of the way to prevent damage, and pull back the securing foil on the bracket.

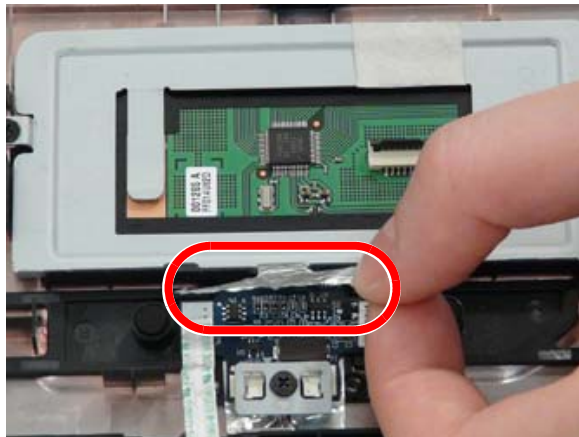

4. Remove the two securing screws from the TouchPad bracket.

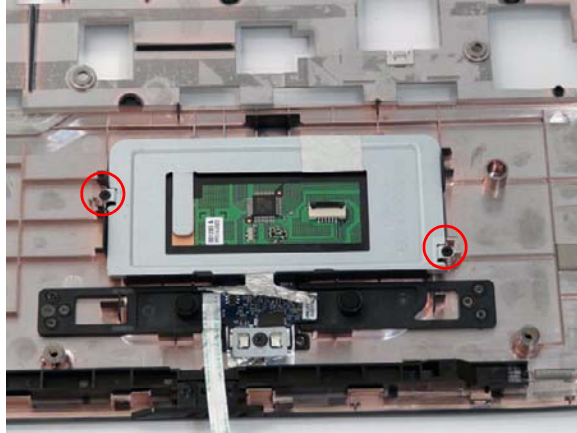

Step	Size	Quantity	Screw Type
TouchPad Bracket	M2*3 (NL)	2	

5. Remove the TouchPad bracket.

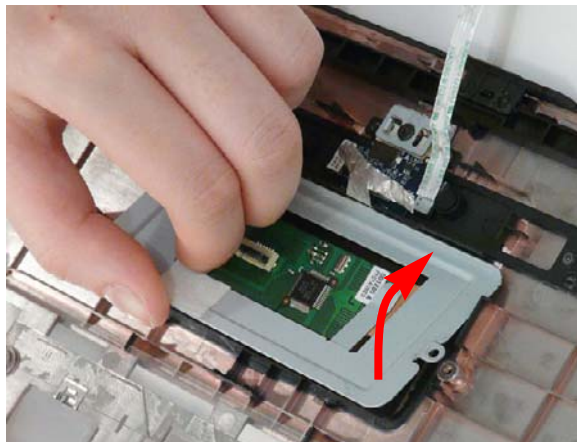

IMPORTANT:The TouchPad cannot be removed individually. To replace the TouchPad, replace the entire Upper Cover.

Removing the Launch Board

1. See “Removing the Upper Left Saddle” on page 75.
2. Grasp the Launch Board and lift up to remove from the Upper Cover.

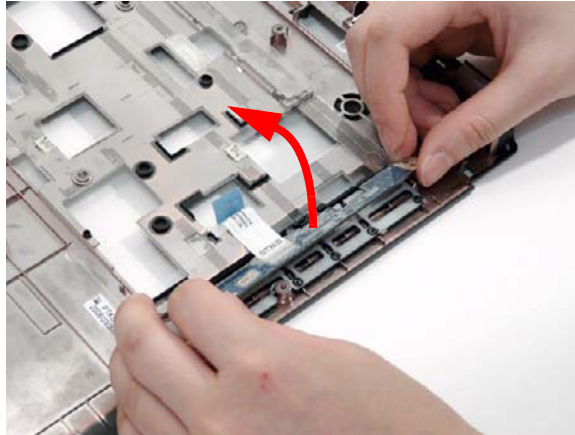

Removing the Media Board

1. See “Removing the Upper Left Saddle” on page 75.
2. Pull the FFC out of the chassis.

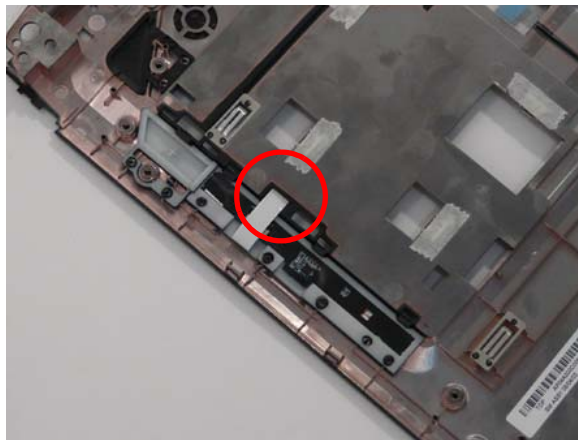

3. Insert the FFC flush with the connector and press the locking lever down to secure.

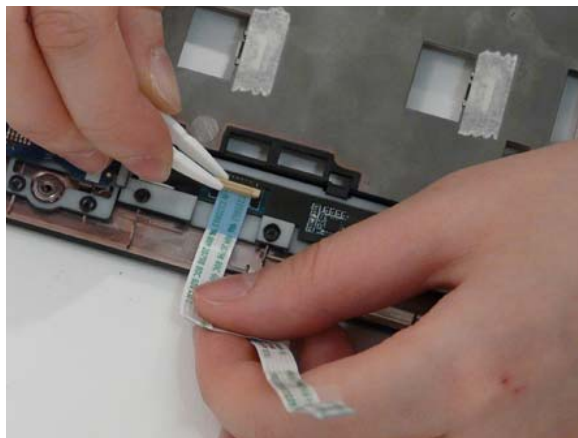

4. Use a pry to lift the Media board out of the Upper Cover.

IMPORTANT: Do not press on components to prevent damage.

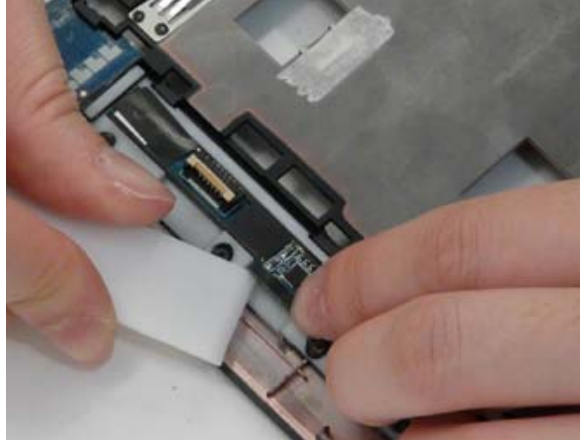

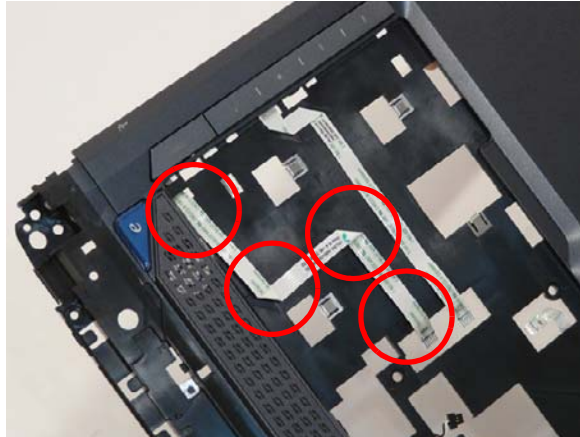

Removing the eKey Board

1. See "Removing the Upper Right Saddle" on page 73.
2. Turn the Upper Cover over and remove the FFC.

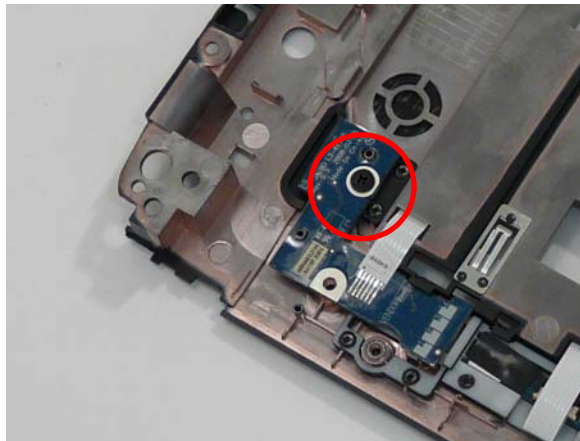

3. Remove the single screw



Step	Size	Quantity	Screw Type
eKey Board	M2*3 (NL)	1	

4. Pry the eKey board off the Upper Cover.

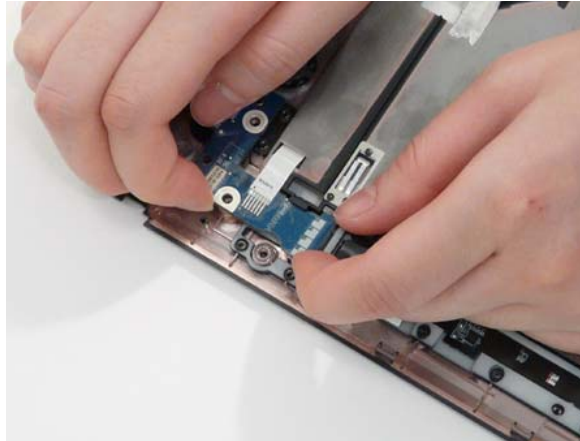

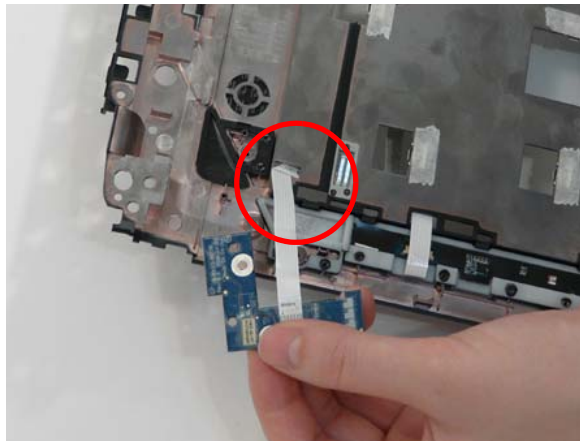

5. Grasp the board and gently pull the FFC through the Upper Cover.

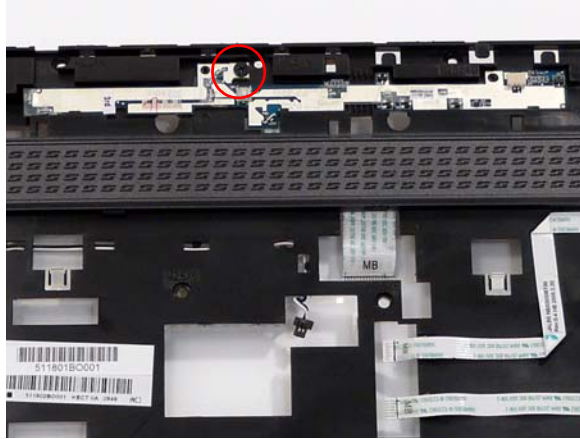

Removing the Switch Board

1. See "Removing the Upper Cover" on page 68.
2. Remove the single securing screw.



Step	Size	Quantity	Screw Type
Switch Board	M2.5*4 (NL)	1	

3. Lift the switch board and FFC up and away from the upper cover.

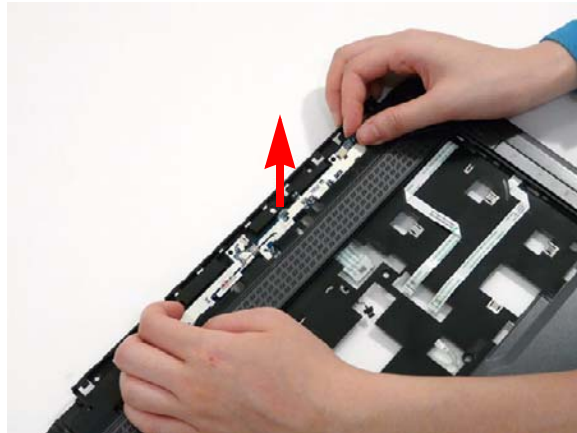

Removing the Right Speaker Module

1. Remove the Upper Cover. See "Removing the Upper Cover" on page 68.
2. Remove the two securing screws from the speaker module.

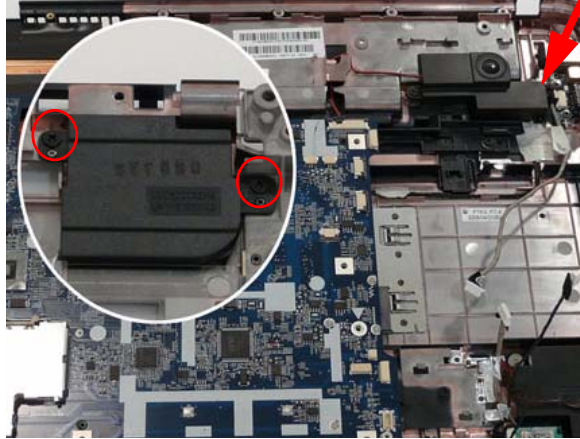

Step	Size	Quantity	Screw Type
Speaker	M2.5*4 (NL)	2	

3. Disconnect the speaker cable from the mainboard.



4. Pull the cable completely through the housing, and remove the speaker module.

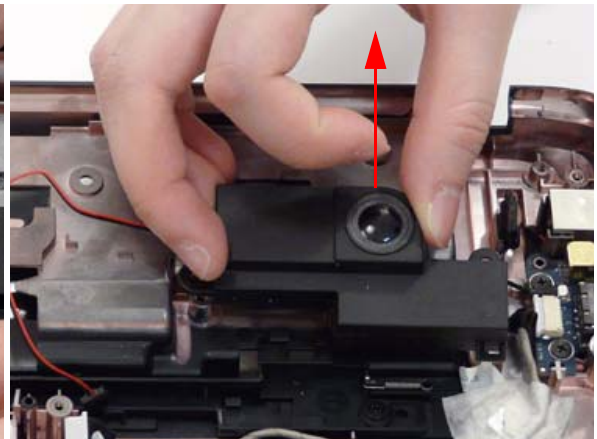
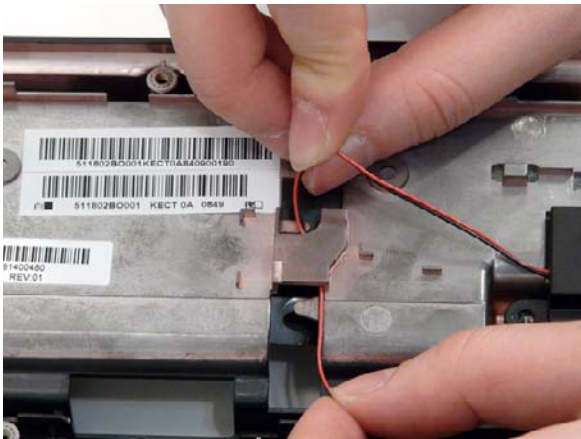

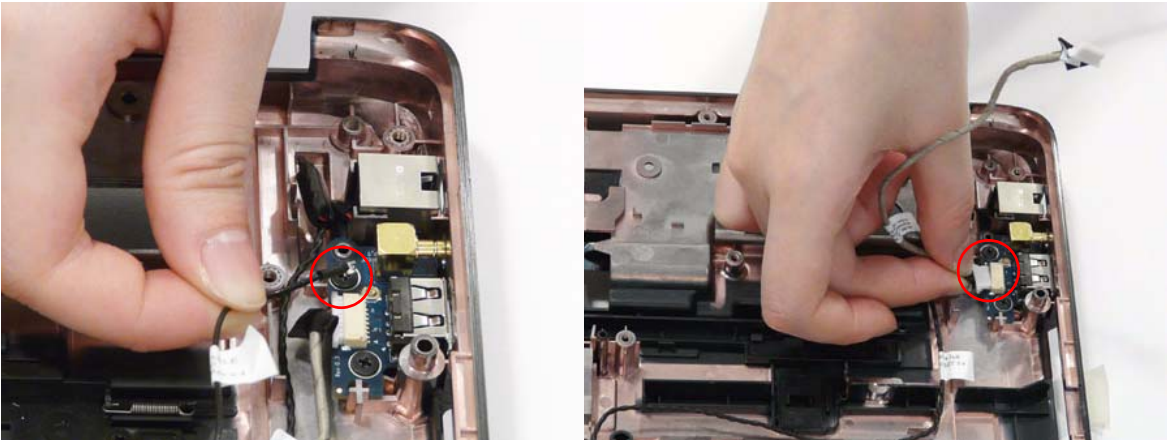

Removing the TV Board

1. See "Removing the Upper Cover" on page 68.
2. Disconnect the antenna and cable from the board.

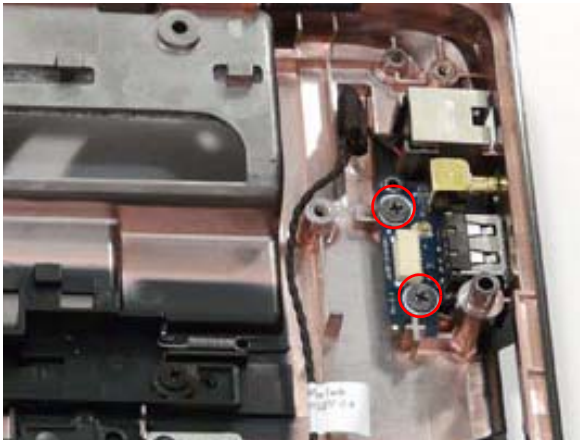

3. Remove the two securing screws from the TV board.



Step	Size	Quantity	Screw Type
TV Board	M2.5*4 (NL)	2	

4. Remove the TV board from the lower base.

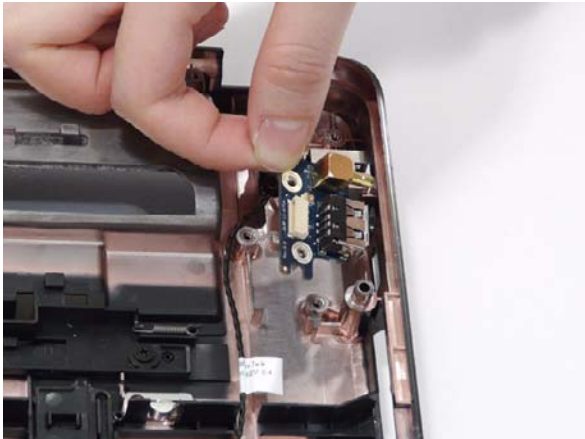

Removing the Bluetooth Module

1. See "Removing the Upper Cover" on page 68.
2. Grasp the Bluetooth module and lift to remove.

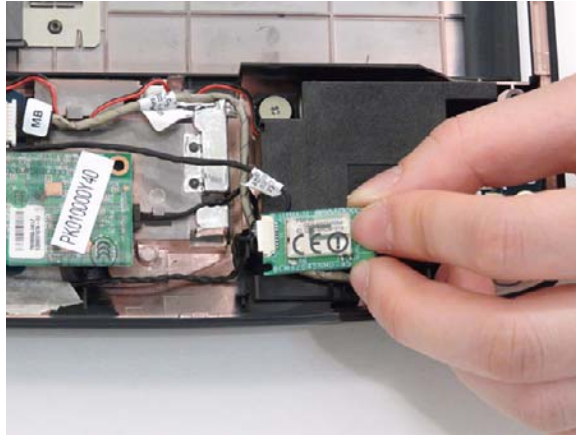

3. Lift the Bluetooth module away from the base and disconnect the bluetooth cable.

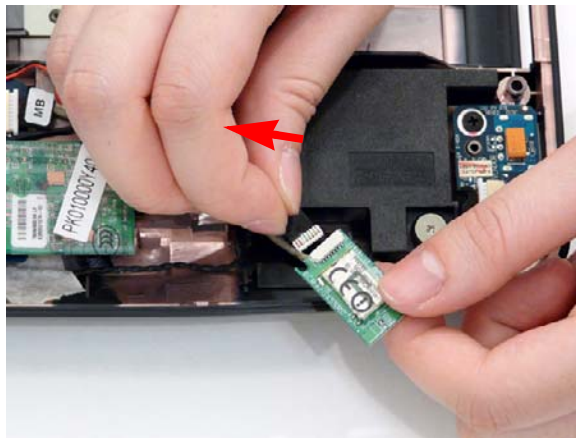

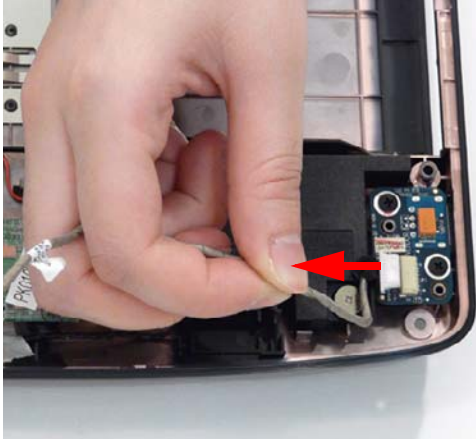

Removing the USB Board

1. See "Removing the Upper Cover" on page 68.
2. See "Removing the Bluetooth Module" on page 84.
3. Remove cable from the USB board.

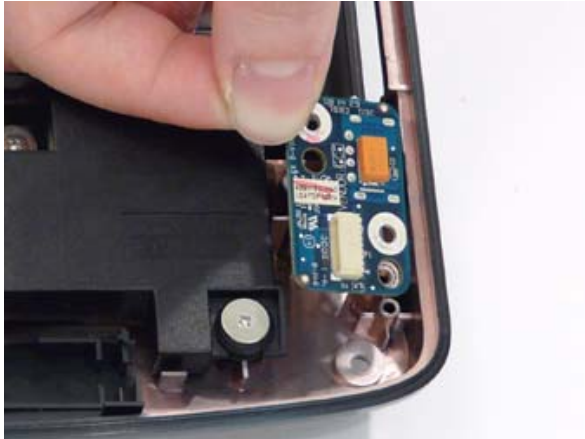
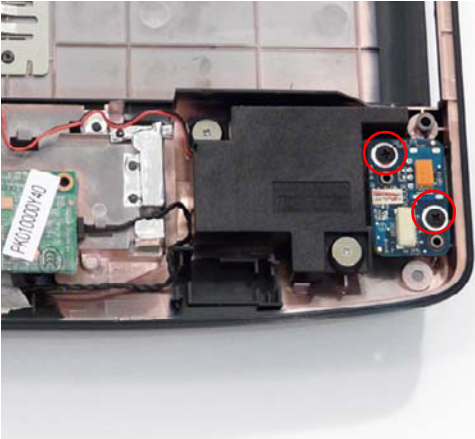

4. Remove the two securing screws from the USB board and lift clear of the chassis.



Step	Size	Quantity	Screw Type
USB board	M2.5*4 (NL)	2	

Removing the Modem Module

- 1. See "Removing the Upper Cover" on page 68.
- 2. Remove securing screw from the modem module.

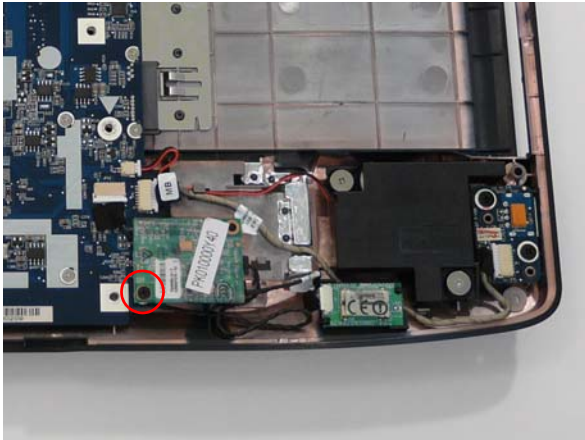

Step	Size	Quantity	Screw Type
Modem Module	M2*3 (NL)	1	

- 3. Lift the module and disconnect the modem cable as shown in the following images.

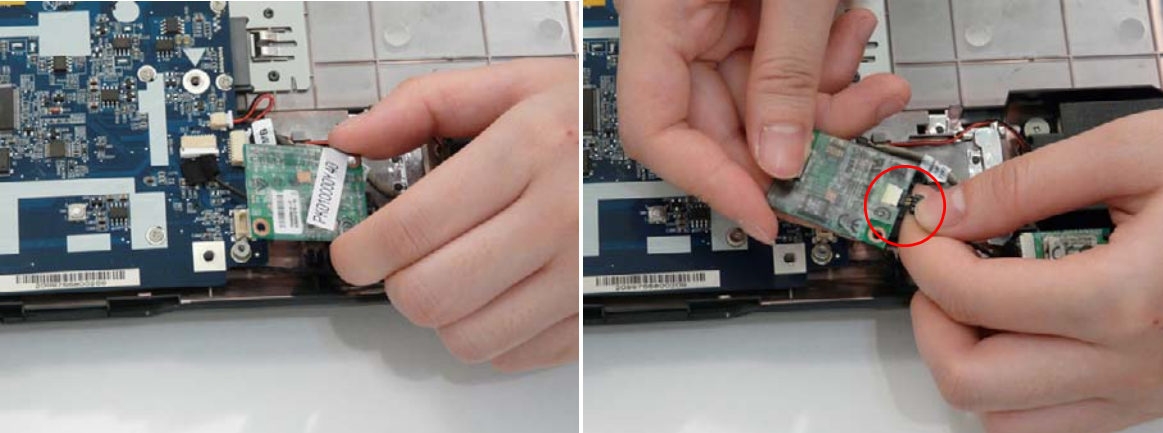

Removing the Subwoofer Module

1. See "Removing the Upper Cover" on page 68.
2. Disconnect the subwoofer cable as shown.



3. Remove the two securing screws from the subwoofer module and lift the subwoofer clear of the chassis.

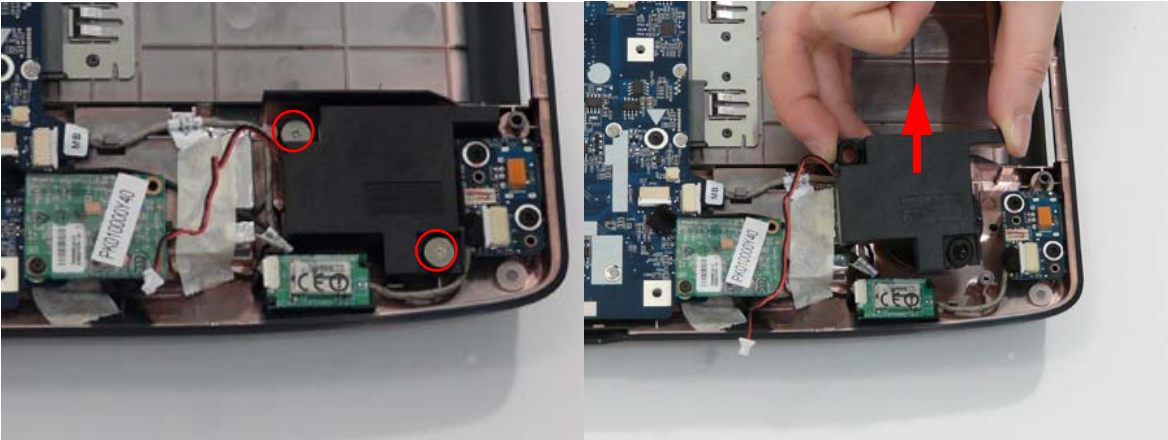

Step	Size	Quantity	Screw Type
Subwoofer	M2*3 (NL)	2	

Removing the Main Board

1. See “Removing the Battery Pack” on page 46.
2. See “Removing the Keyboard” on page 63.
3. See “Removing the LCD Module” on page 66.
4. See “Removing the Upper Cover” on page 68.
5. Disconnect the three cables from the bottom right of the mainboard as shown.

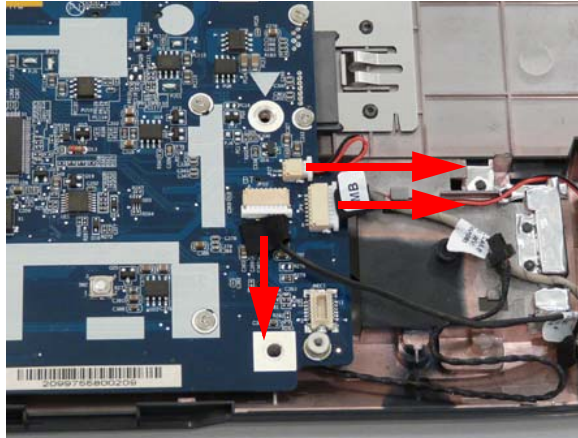

6. Disconnect the two cables from the top right of the mainboard as shown.

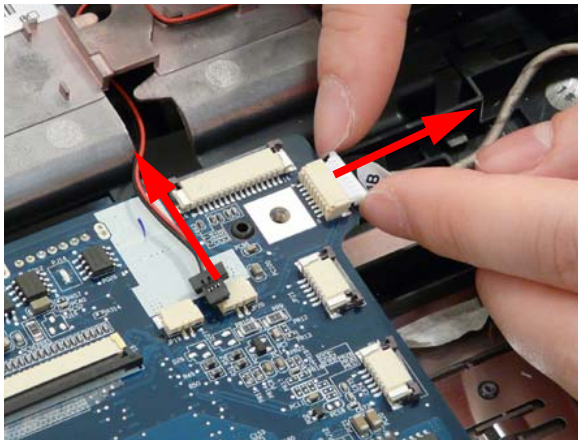

7. Remove the two securing screws from the Mainboard.

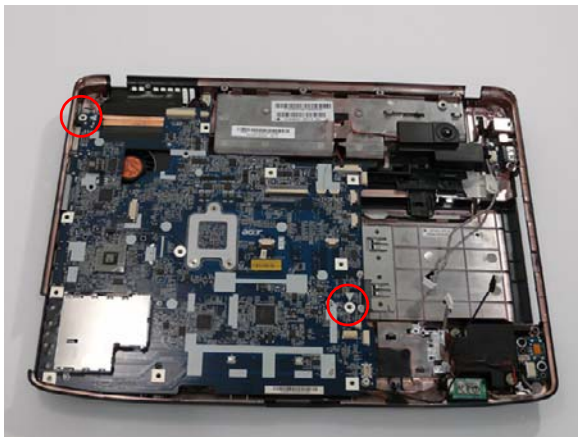

Step	Size	Quantity	Screw Type
Mainboard	M2.5*6 (NL)	2	

8. Remove the main board, rightside first, as shown.

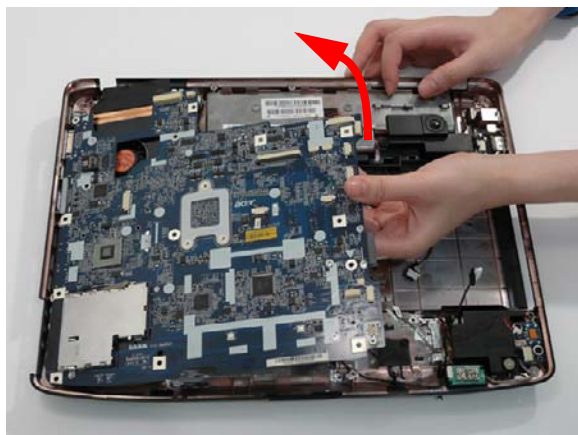

9. Lift the power jack clear of power port on the Lower Cover.

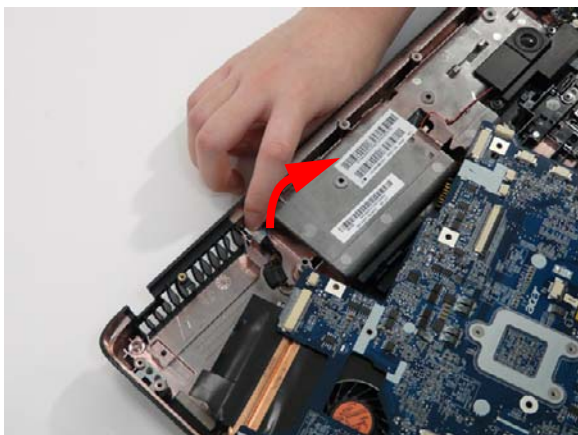

Removing the RJ-11 Port

1. See “Removing the Upper Cover” on page 68.
2. See “Removing the Right Speaker Module” on page 82.
3. See “Removing the Main Board” on page 88.
4. Remove the RJ-11 cable from its housing.

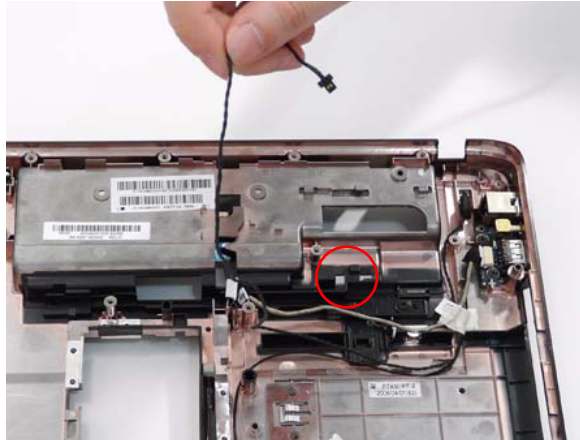

5. Using the tweezers to grasp the end of the cable to detach from the base.

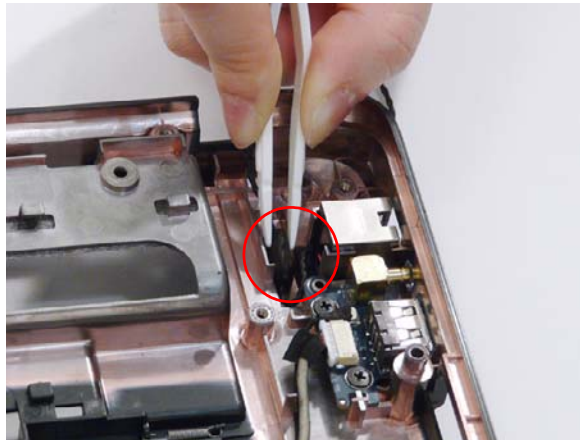

6. Insert the tweezers in the RJ-11 port and push up to detach and lift the port from the base.

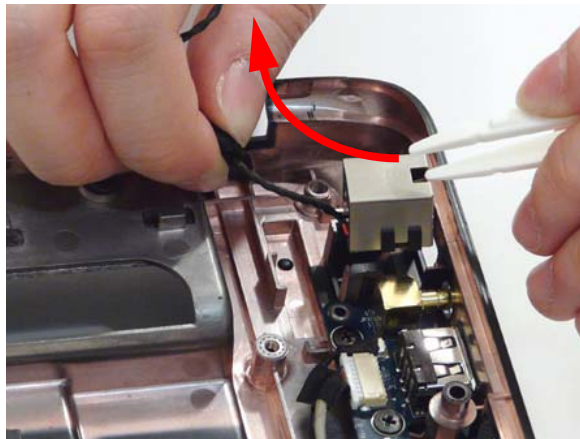

Removing the Thermal Module

1. See "Removing the Battery Pack" on page 46.
2. See "Removing the LCD Module" on page 66.
3. See "Removing the Upper Cover" on page 68.
4. See "Removing the Main Board" on page 88.
5. Remove the eight securing screws from the Thermal Modules.

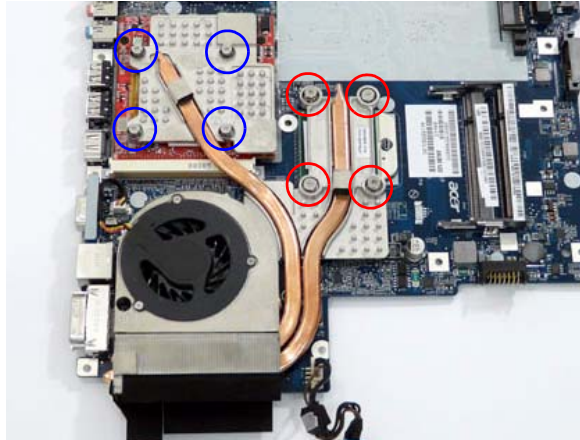

Step	Size	Quantity	Screw Type
CPU Thermal Module (red callout)	M2*6.5	4	
VGA Thermal Module (blue callout)	M2*5	4	

6. Disconnect the fan module cable from mainboard.

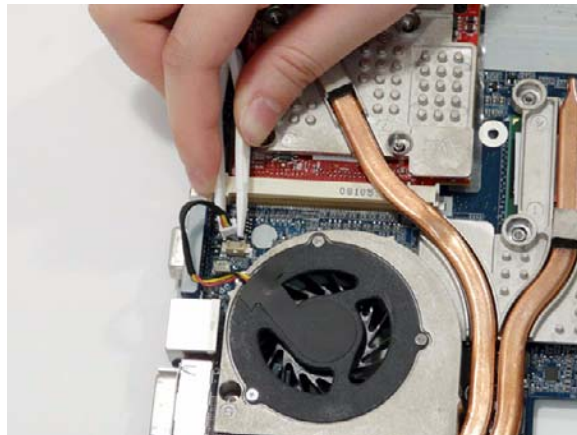

7. Lift the Thermal Module clear of the Mainboard.



Removing the CPU

1. See “Removing the Battery Pack” on page 46.
2. See “Removing the Upper Cover” on page 68.
3. See “Removing the Main Board” on page 88.
4. See “Removing the Thermal Module” on page 91.
5. Using a flat screwdriver, turn the CPU socket latch counter-clockwise 180° to release the CPU.



6. Lift the CPU clear of the Mainboard.



Removing the VGA Module

1. See "Removing the Battery Pack" on page 46.
2. See "Removing the Upper Cover" on page 68.
3. See "Removing the Main Board" on page 88.
4. Remove the two securing screws from the VGA Module.

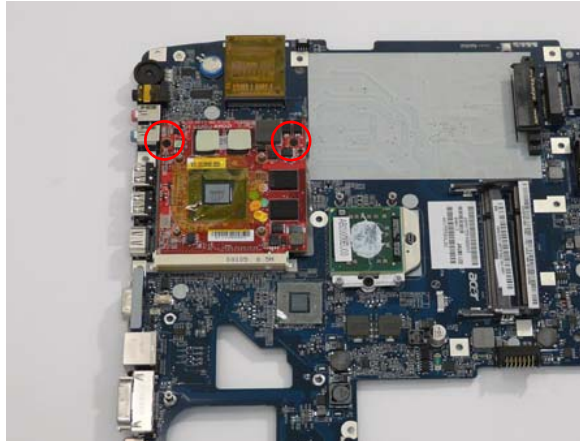

Step	Size	Quantity	Screw Type
VGA Module	M3*3 (NI)	2	

5. The VGA module lifts automatically from the mainboard. Remove the VGA Module as shown.

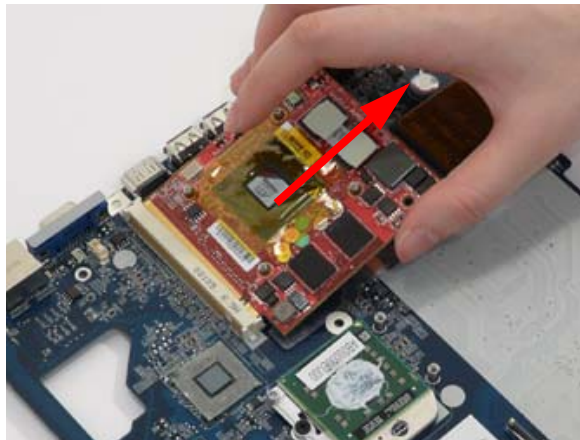

LCD Module Disassembly Process

IMPORTANT:The outside housing and color may vary from the mass produced model.

LCD Module Disassembly Flowchart

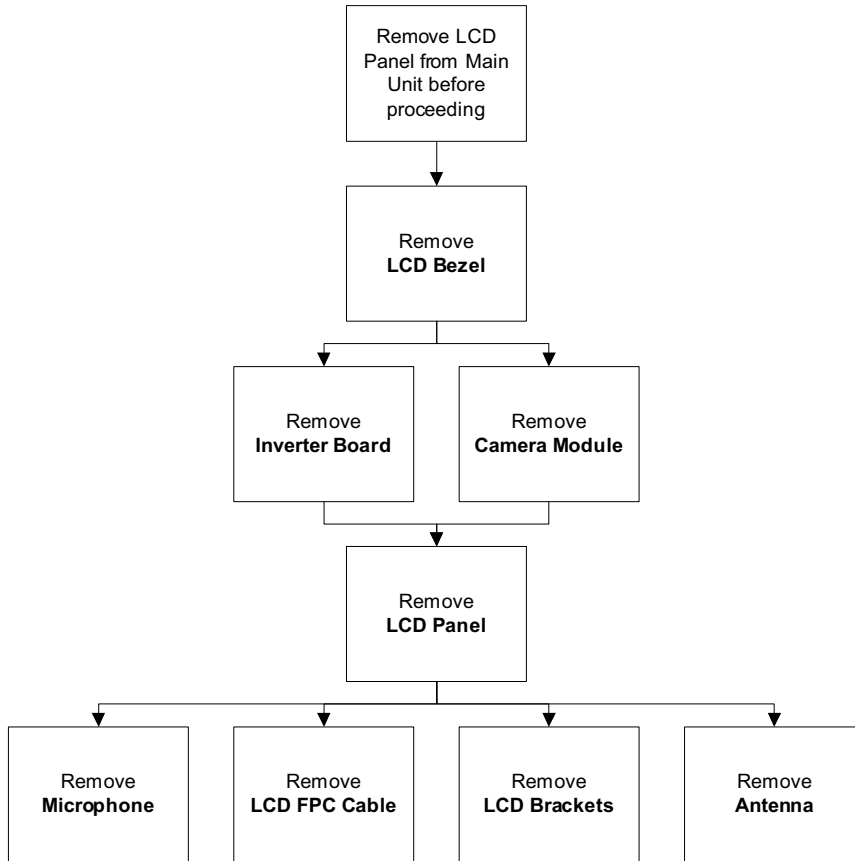

Screw List

Step	Screw	Quantity	Part No.
LCD Bezel	M2.5*6 (NL)	4	86.ATA02.002
Inverter Board	M2.5*6 (NL)	2	86.ATA02.002
Camera Module	M2*3 (NL)	2	86.ATA02.005
Camera Board	M2*3 (NL)	1	86.ATA02.005
LCD Panel	M2.5*6 (NL)	2	86.ATA02.002
LCD Brackets	M2*3 (NL)	8	86.ATA02.005

Removing the LCD Bezel

- 1. See "Removing the Battery Pack" on page 46.
- 2. See "Removing the LCD Module" on page 66.
- 3. Remove the two upper and two lower bezel screw caps. Remove the four securing screws from the LCD module.

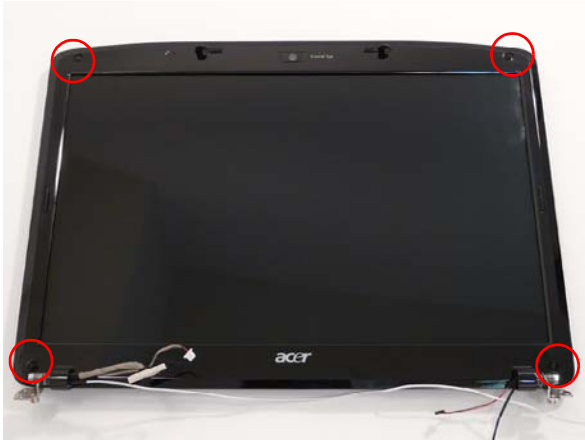

Step	Size	Quantity	Screw Type
LCD Bezel	M2.5*6 (NL)	4	

- 4. Lift up the bezel, topside first, and remove it from the LCD Module.



Removing the Inverter Board

- 1. See "Removing the Battery Pack" on page 46.
- 2. See "Removing the LCD Module" on page 66.
- 3. See "Removing the LCD Bezel" on page 96.
- 4. Remove the securing tapes from the left and right sides of the Inverter board as shown.



- 5. Remove the two securing screws from the Inverter board and lift the board clear of the LCD Module.



Step	Size	Quantity	Screw Type
Inverter Board	M2.5*6 (NL)	2	

6. Disconnect the left and right Inverter board cables as shown.

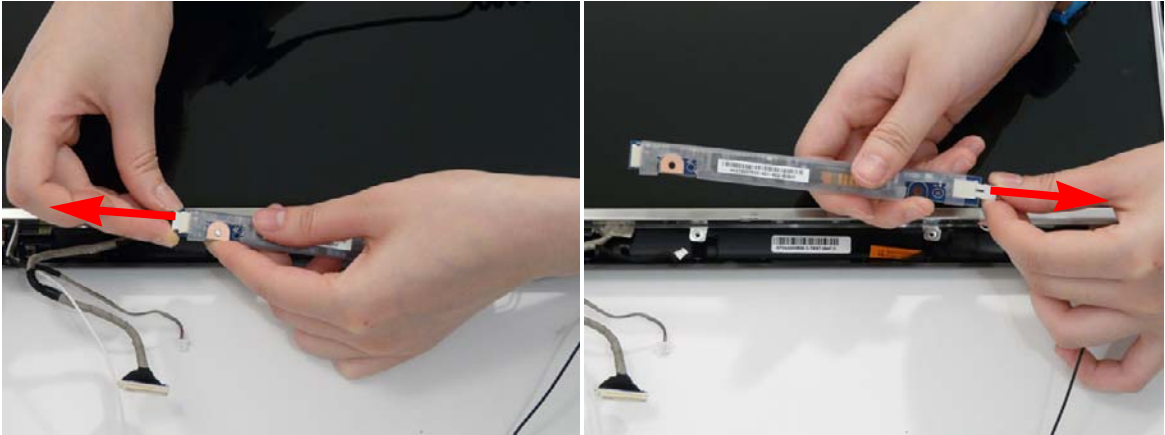

Removing the Camera Module

1. See "Removing the Battery Pack" on page 46.
2. See "Removing the Lower Covers" on page 49.
3. See "Removing the WLAN Module" on page 52.
4. See "Removing the Keyboard" on page 63.
5. See "Removing the LCD Module" on page 66.
6. See "Removing the LCD Bezel" on page 96.
7. Disconnect the Camera Module cable as shown.

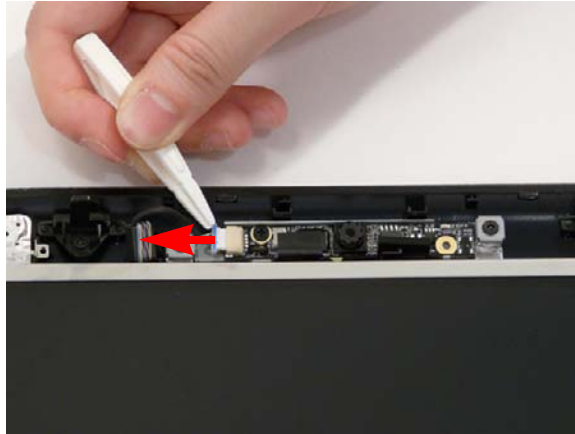

8. Remove the two securing screws from the Camera Module bracket.

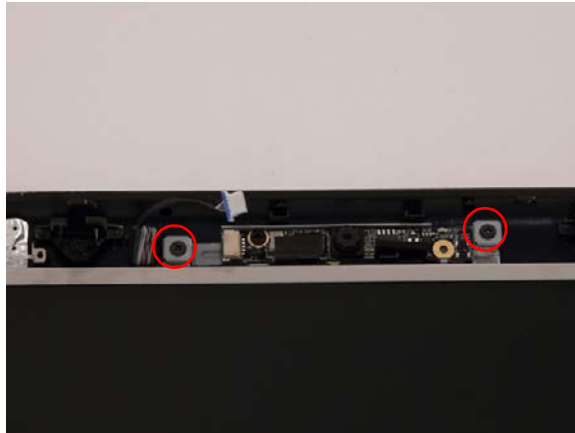

Step	Size	Quantity	Screw Type
Camera Module bracket	M2*3 (NL)	2	

9. Lift the Camera Module clear of the LCD Module.

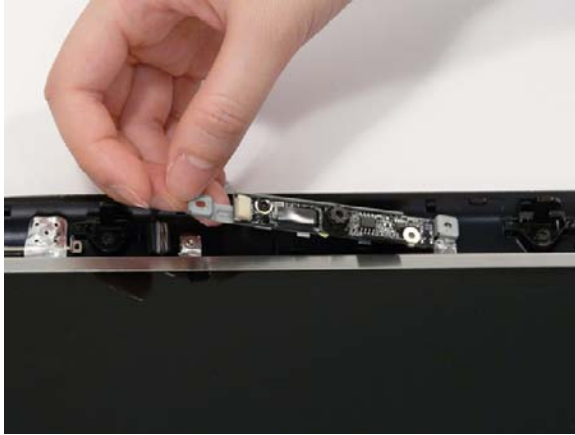

10. Remove the securing screw from the camera board.

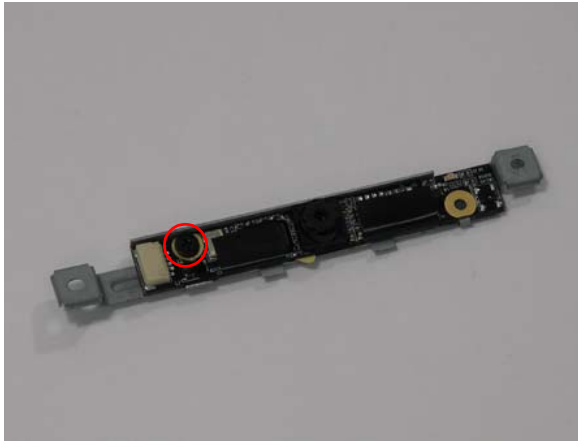

Step	Size	Quantity	Screw Type
Camera Board	M2*3 (NL)	1	

11. Remove the camera board from the bracket.

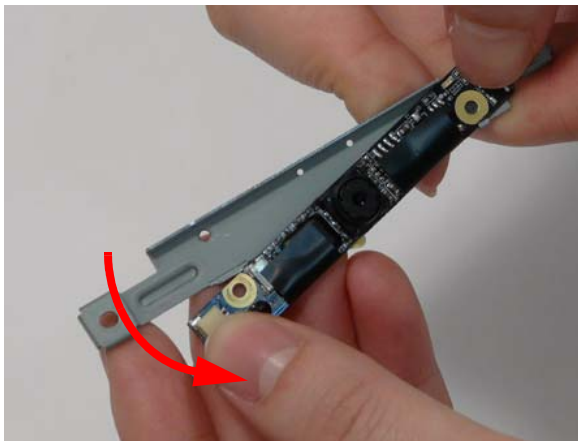

Removing the LCD Panel

1. See "Removing the Battery Pack" on page 46.
2. See "Removing the Lower Covers" on page 49.
3. See "Removing the WLAN Module" on page 52.
4. See "Removing the Keyboard" on page 63.
5. See "Removing the LCD Module" on page 66.
6. See "Removing the LCD Bezel" on page 96.
7. Remove the two securing screws from the LCD Module.

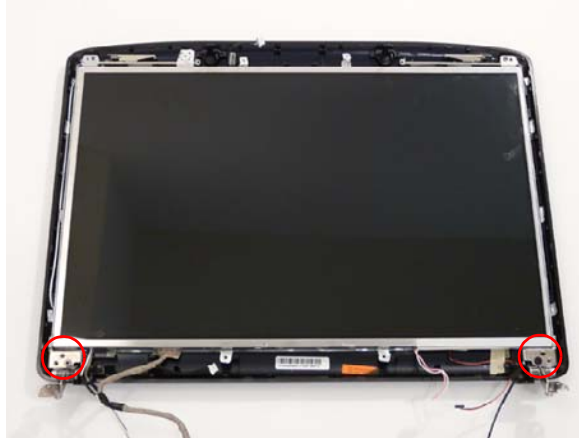

Step	Size	Quantity	Screw Type
LCD Panel	M2.5*6 (NL)	2	

8. Lift the LCD Panel clear of the LCD Module.



Removing the LCD Brackets and FPC Cable

1. See "Removing the Battery Pack" on page 46.
2. See "Removing the Lower Covers" on page 49.
3. See "Removing the WLAN Module" on page 52.
4. See "Removing the Keyboard" on page 63.
5. See "Removing the LCD Panel" on page 101.
6. Turn the LCD panel over to expose the rear. Disconnect the cable from the LCD Panel using the tab provided.



7. Grip the FPC cable and lift upward to detach the adhesive pads.
8. Remove the eight securing screws (four on each side) from the LCD Panel brackets.

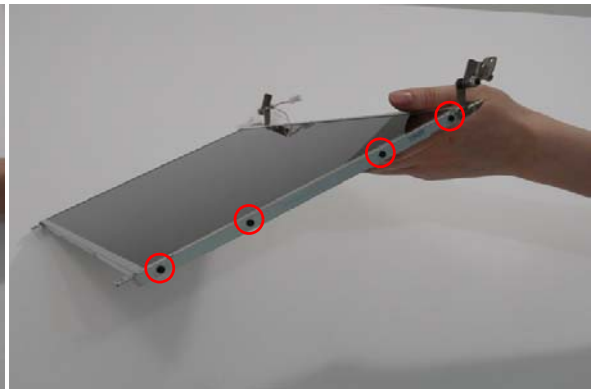
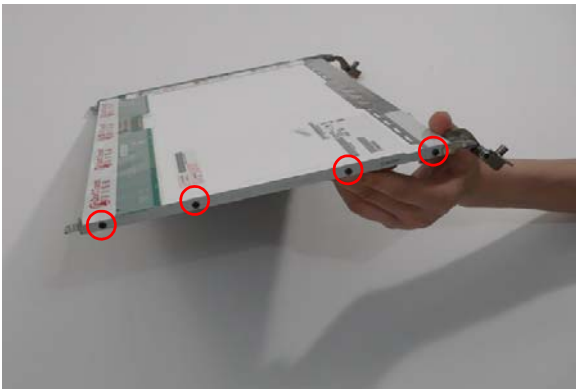

Step	Size	Quantity	Screw Type
LCD Brackets	M2*3 NL	8	

9. Remove the LCD brackets by pulling away from the LCD Panel.

Removing the Antennas

1. See "Removing the Battery Pack" on page 46.
2. See "Removing the Lower Covers" on page 49.
3. See "Removing the WLAN Module" on page 52.
4. See "Removing the LCD Panel" on page 101.
5. Remove the strips holding the antenna cables in place. Ensure the cables are free from obstructions.

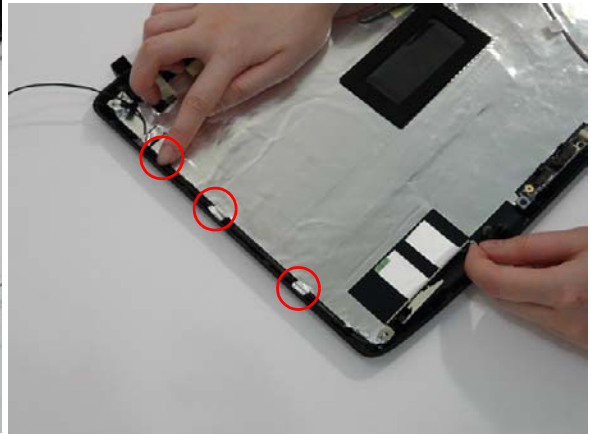
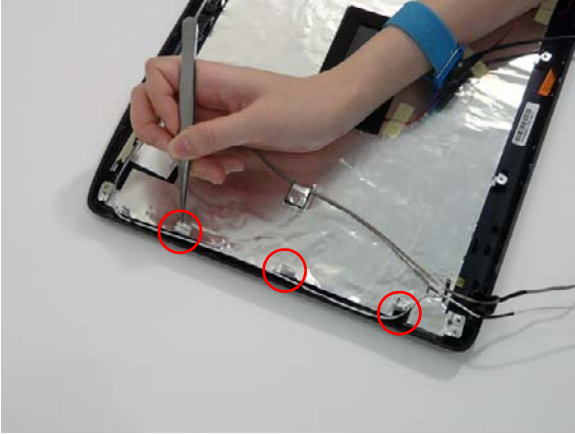

6. Remove the tabs securing the left and right antennas to the LCD module.

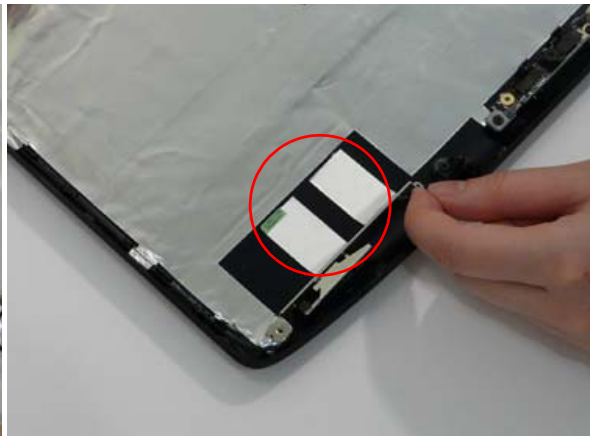
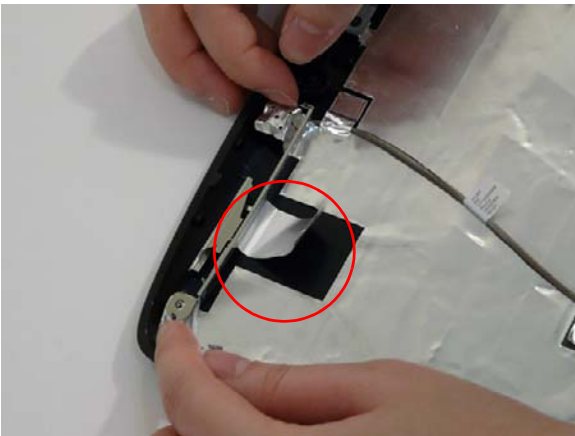

7. Remove the antenna cables and assembly from the LCD module.

Removing the MIC Module

1. See “Removing the Battery Pack” on page 46.
2. See “Removing the Lower Covers” on page 49.
3. See “Removing the WLAN Module” on page 52.
4. See “Removing the LCD Panel” on page 101.
5. Remove the strips holding the MIC Module cable in place. Ensure the cable is free from obstructions.

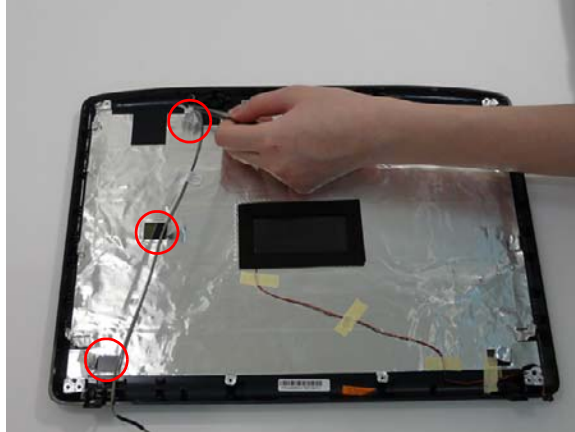

6. Remove the MIC cable and Module from the LCD module.

LCD Module Reassembly Procedure

Replacing the LCD Panel

1. Align the LCD brackets with the eight screw holes (four on each side) on the LCD Panel as shown.

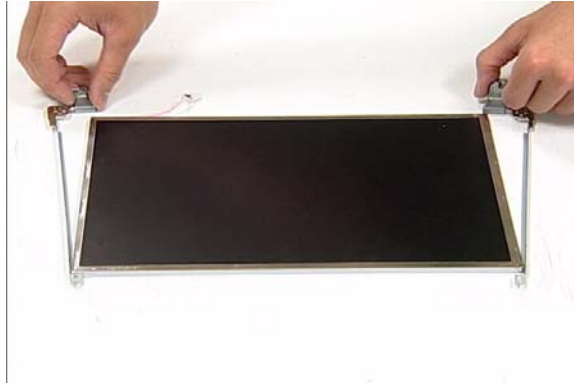

2. Secure the LCD brackets to the LCD panel.

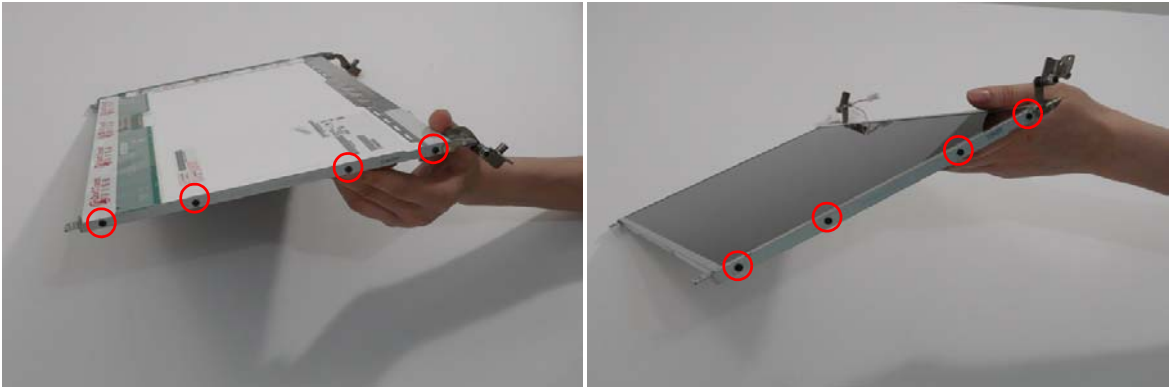

3. Turn the panel over. Insert the LCD Panel cable into the LCD Panel as shown.



4. Replace the MIC cable under the mylar tab strips, and replace the MIC as shown. Secure the cable by pressing down on the strips.

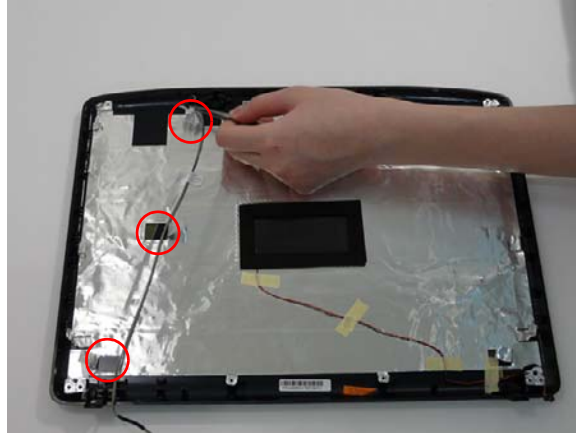

5. Replace the antenna cables and assembly.
6. Replace the tabs securing the left and right antennas to the LCD module.

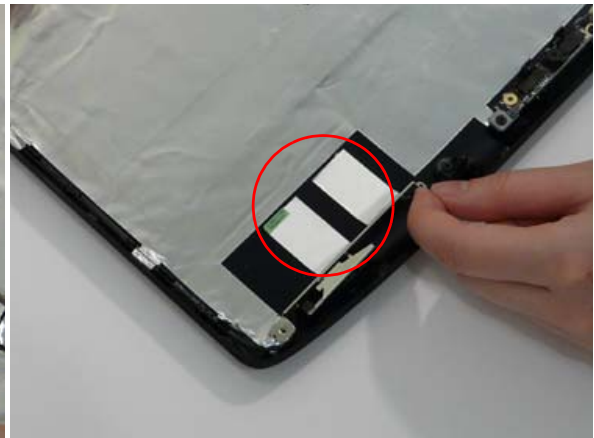
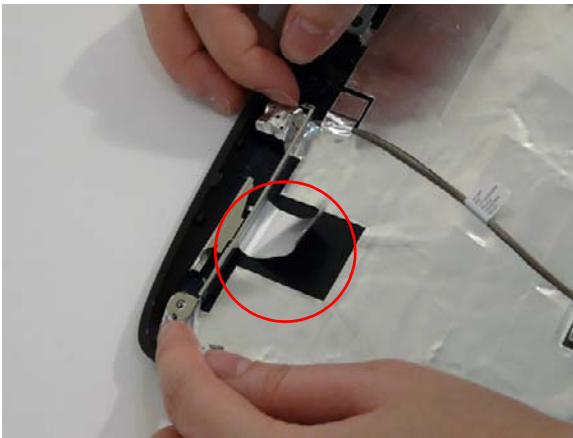

7. Replace the strips holding the antenna cables in place. Ensure the cables are free from obstructions.



8. Secure the cable by pressing down on the securing strip.



9. Replace the two securing screws on the LCD Module.



10. Replace the camera board in the bracket.

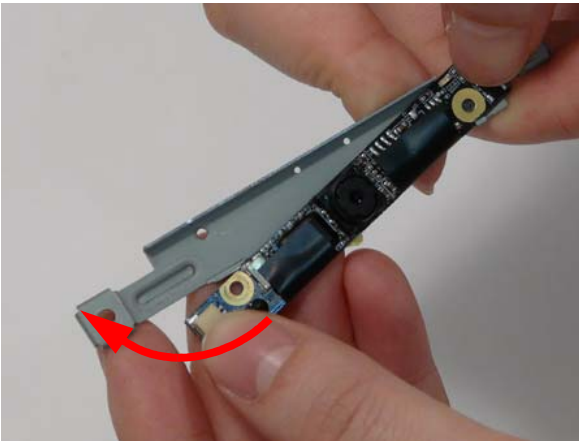

11. Replace the securing screw on the camera board.

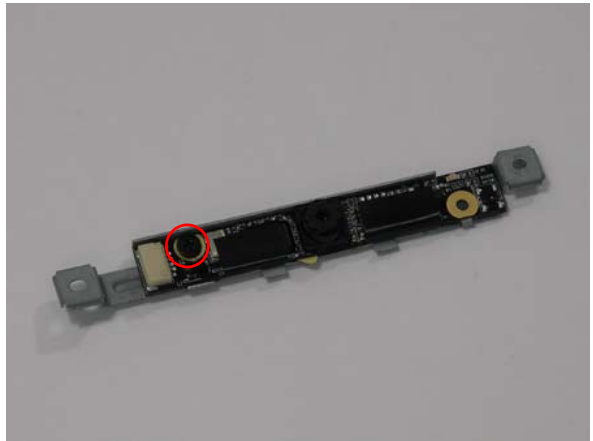

12. Replace the Camera Module in the bottom cover.

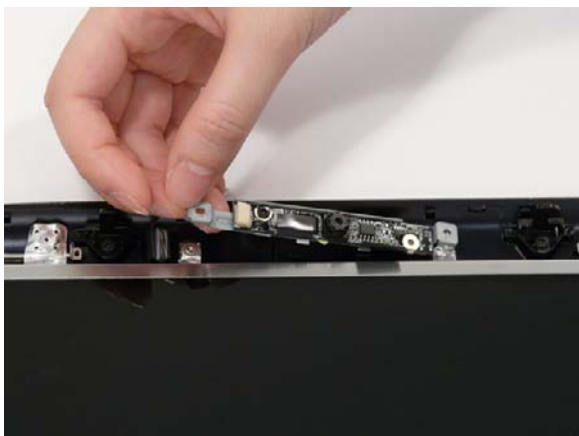

13. Replace the two securing screws on the Camera Module bracket.

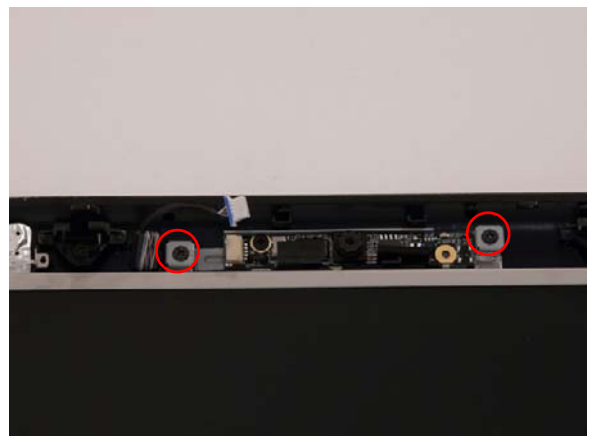

14. Connect the Camera Module cable as shown.



15. Connect the left and right Inverter board cables as shown.



16. Connect the left and right Inverter board cables as shown.

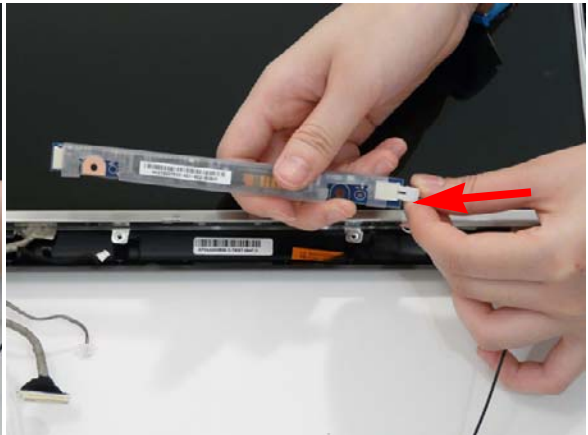
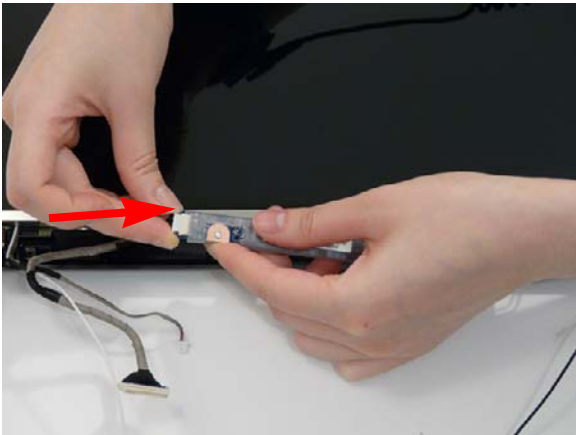

17. Replace the inverter board and secure with the two provided screws.



18. Replace the securing tapes from the left and right sides of the Inverter board as shown.

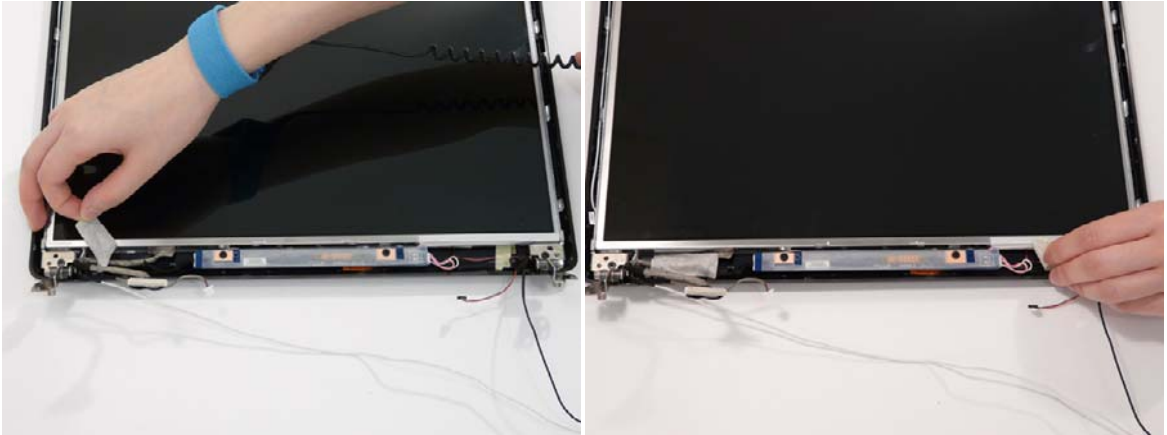

NOTE: Tuck the cables securely to prevent damage to the cables or module.

Replacing the LCD Bezel

1. Align the edge of the bezel with the bottom cover and replace the LCD Module.



2. Replace the two upper and two lower bezel screw caps. Remove the four securing screws from the LCD module.

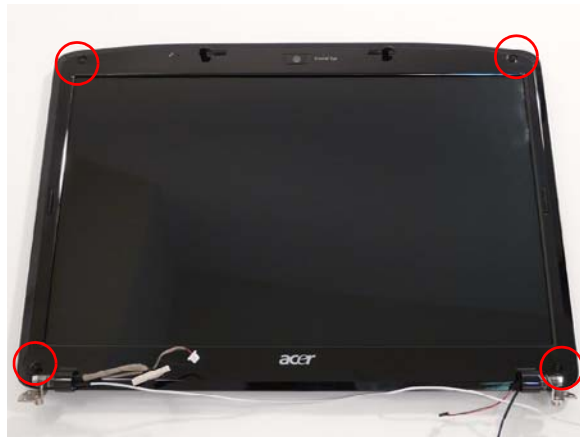

Main Module Reassembly Procedure

Replacing the VGA Module

1. Insert the VGA Module as shown.
2. Replace the two securing screws on the VGA Module.

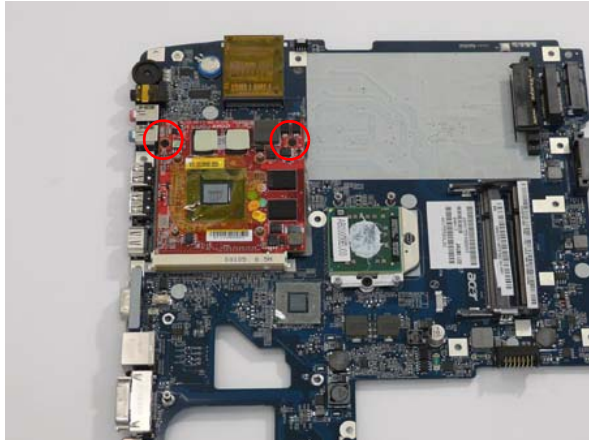
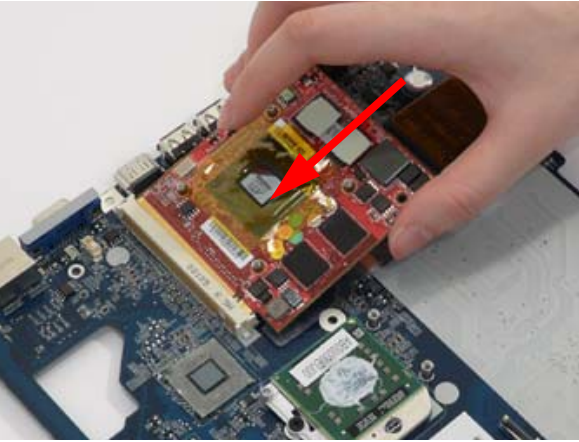

Replacing the CPU

1. Carefully turn the mainboard upside down (CPU side up), and insert the CPU into the CPU bracket as shown.
2. Using a flat-tipped screw driver, lock the CPU in the socket as shown.

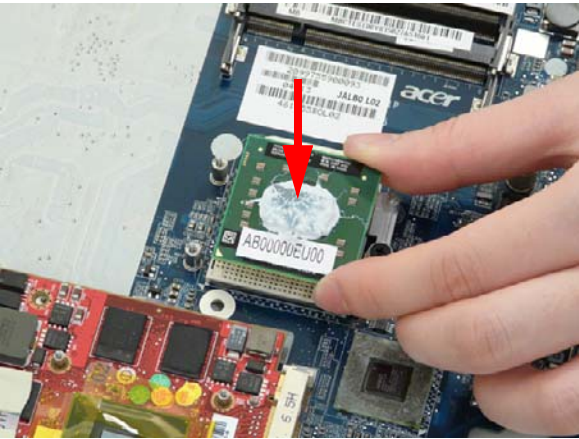

Replacing the Thermal Module

1. Align and place the Thermal Module in the mounting as shown.
2. Connect the fan module cable to the mainboard.

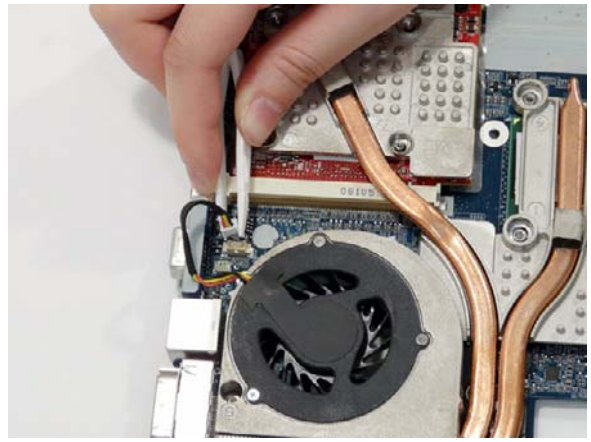
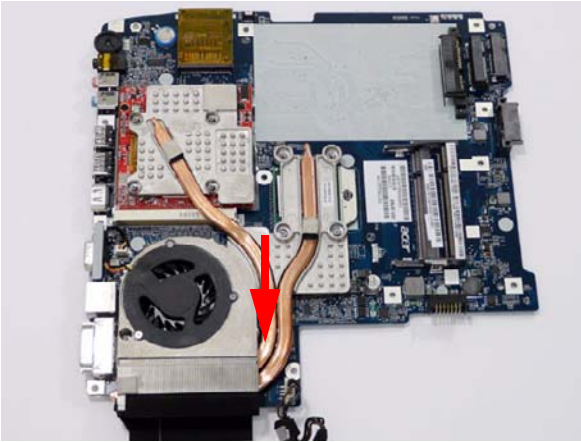

3. Replace the eight securing screws from the Thermal Module.

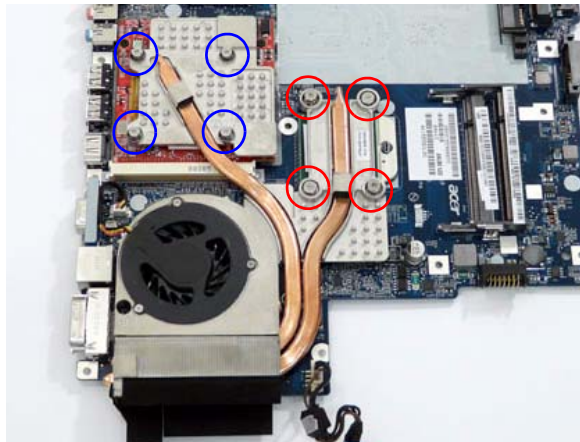

Replacing the RJ-11 Port

1. Insert the RJ-11 port into the base as shown.
2. Using the tweezers, grasp the end of the cable and press down to attach it to the base.

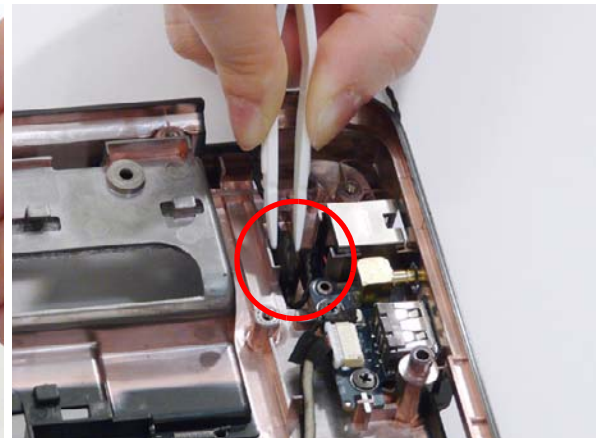
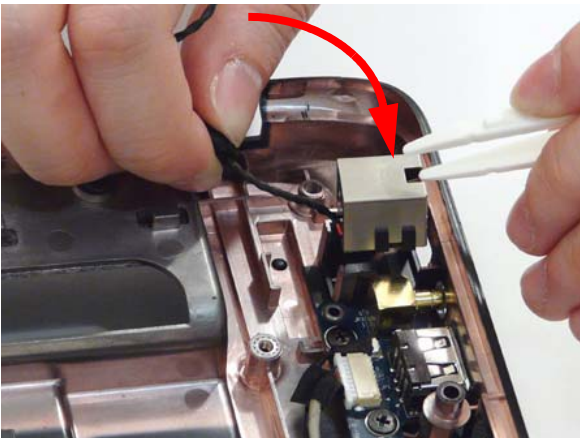

3. Replace the RJ-11 cable in its housing.

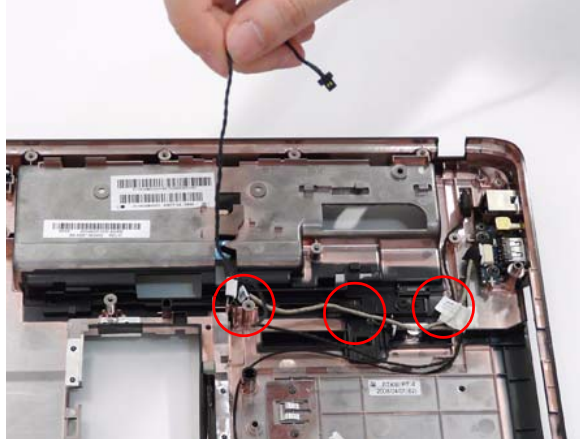

Replacing the Mainboard

1. Replace the power jack in the Lower Cover.
2. Gently lower the mainboard, leftside first, on the lower base. Ensure the screw sockets are aligned.

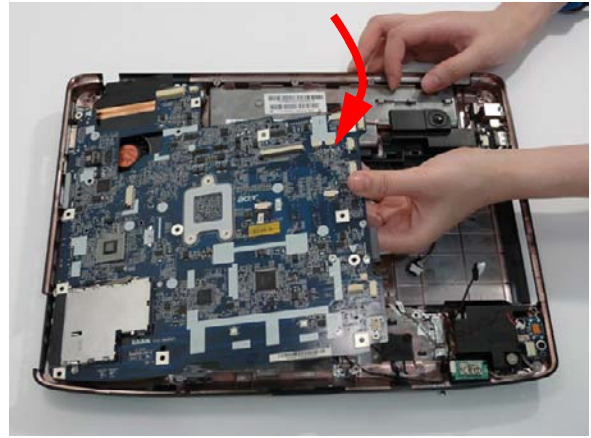
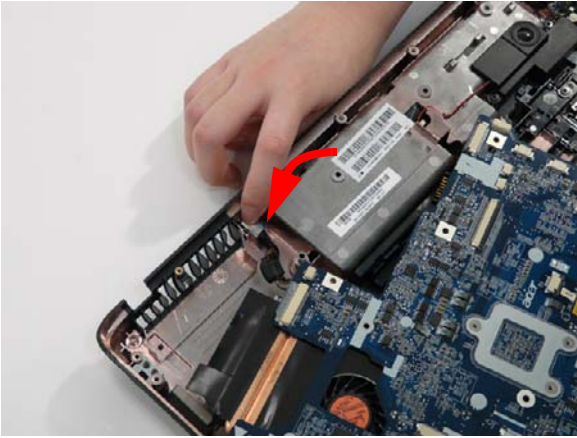

3. Ensure that the Mainboard is face up (the Heatsink and CPU are not visible). Place the Mainboard in the chassis, rear edge first, and press down to install. Replace the two securing screws as shown.
NOTE: Make sure the I/O ports are positioned correctly through the lower cover, and the screw sockets are visible through the mainboard.

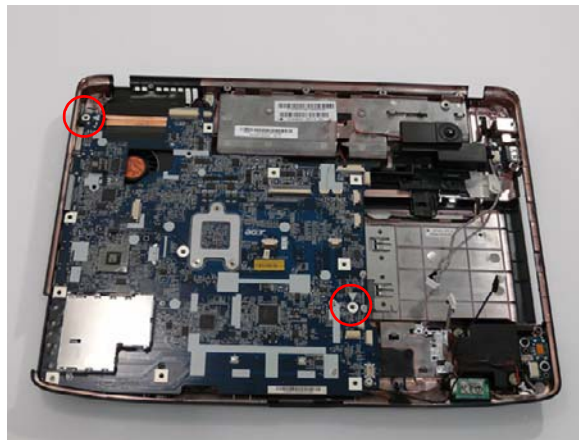

4. Connect the two cables on the top right of the mainboard as shown.
5. Connect the three cables from the bottom right of the mainboard as shown.

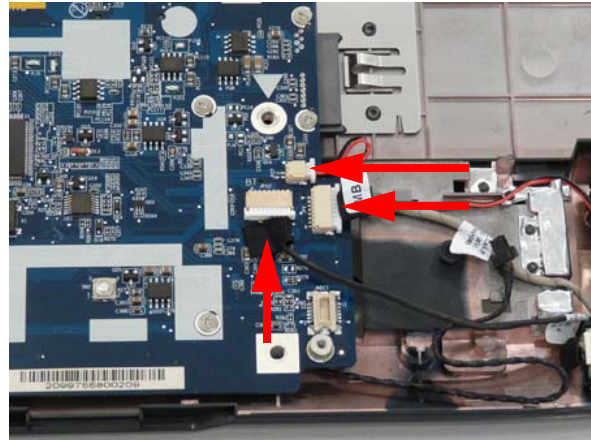
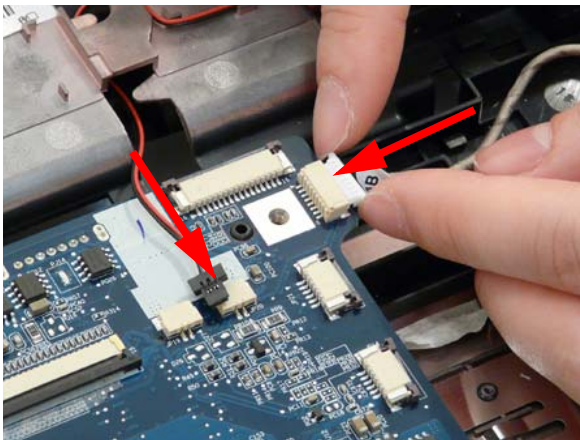

Replacing Subwoofer Module

6. Locate the Subwoofer on the lower cover, and replace the two securing screws.

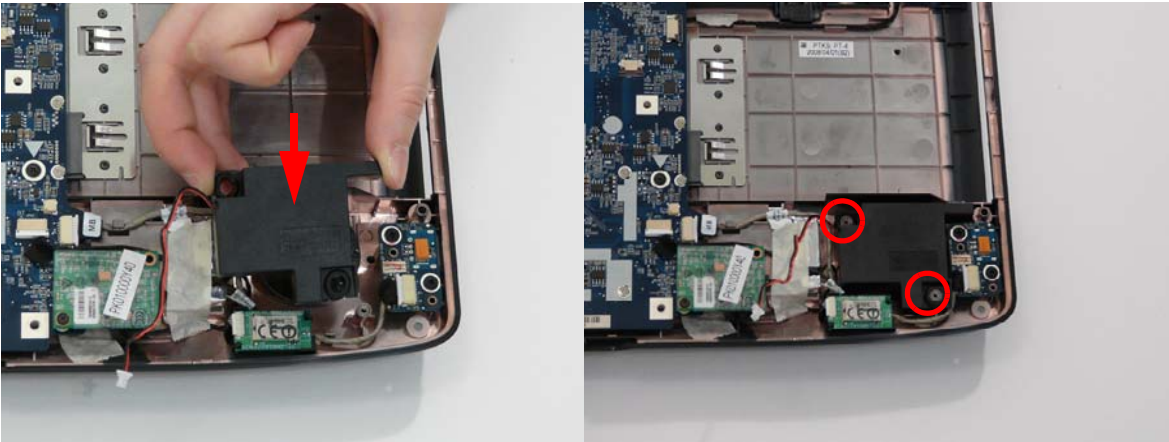

7. Connect the subwoofer cable as shown.

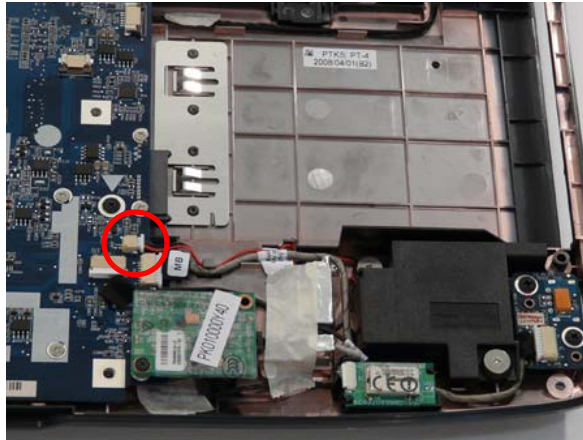

Replacing the Modem Module

1. Connect the modem cable and locate it over the screw socket.
2. Insert module in mainboard.

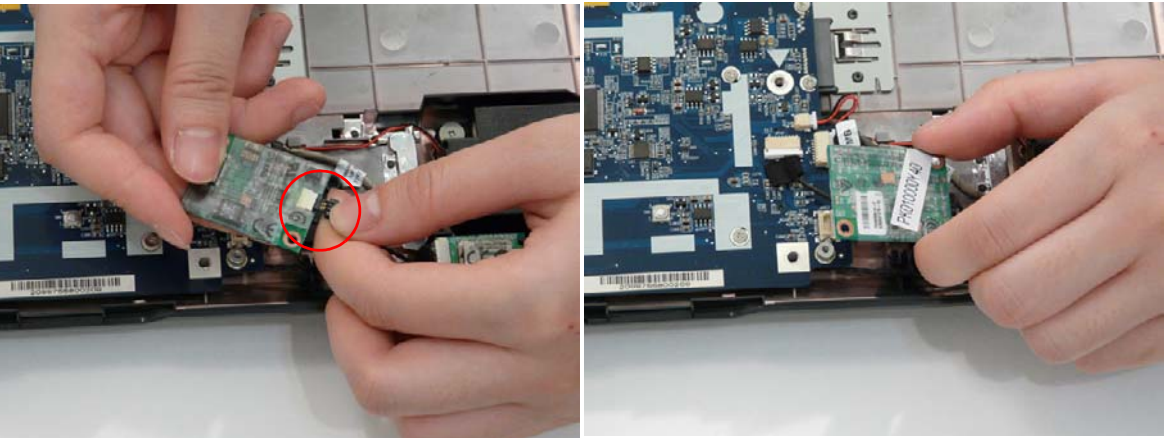

3. Replace the securing screw on the modem module.



Replacing the USB Board

1. Angle the right side of the USB board into the lower base. Align the screw sockets and replace the two securing screws.

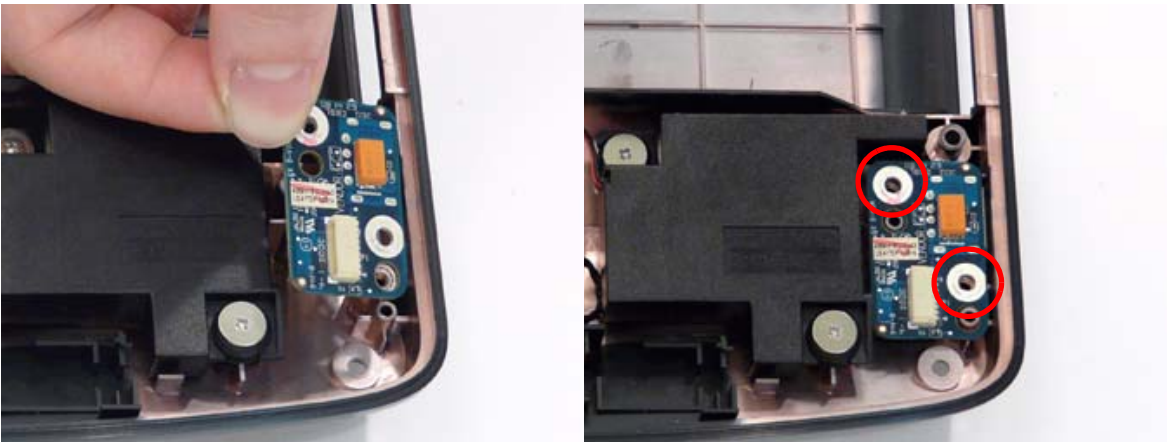

2. Replace the cable on the USB board.



Replacing the Bluetooth Board

1. While holding the Bluetooth module, connect the cable as shown.
2. Position the module over the aligning pins and insert in place.

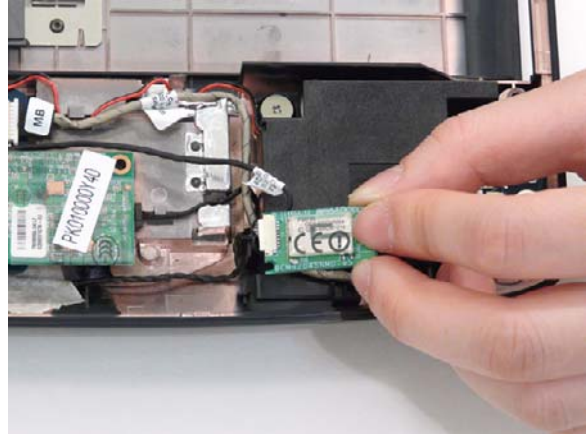
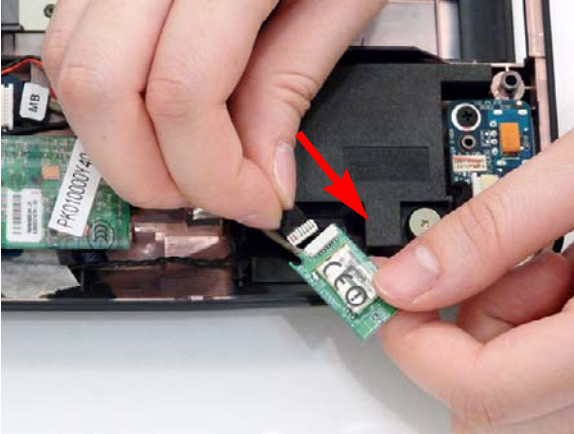

Replacing the TV Board

1. Angle the TV board into the lower base and lower into position.

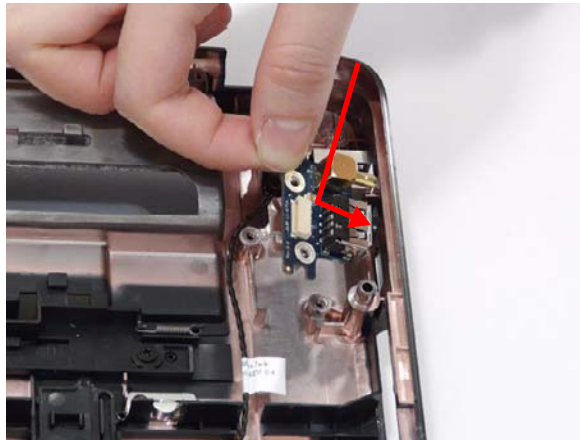

2. Replace the two securing screws on the TV board.

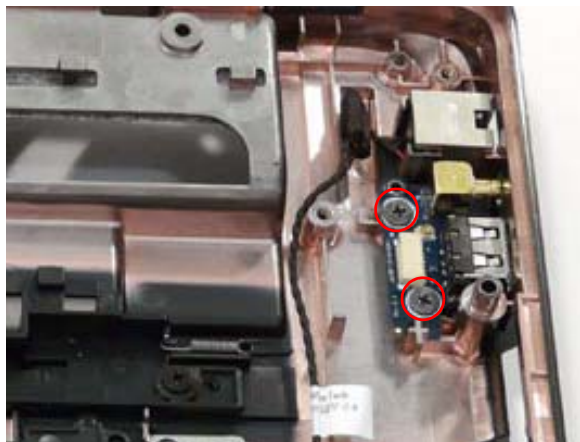

3. Connect the antenna and single cable to the board.

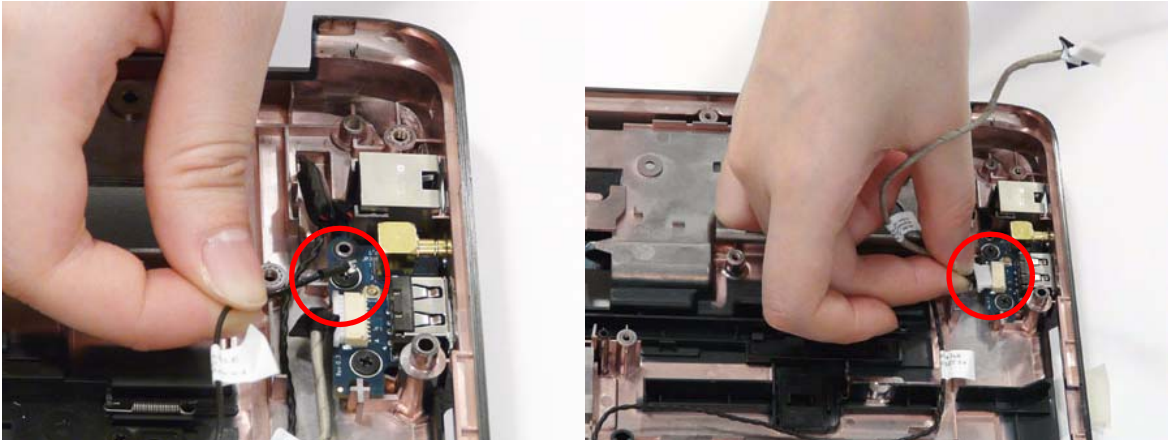

Replacing the Right Speaker Module

1. Replace the speaker module and insert the cable completely through the housing as shown.

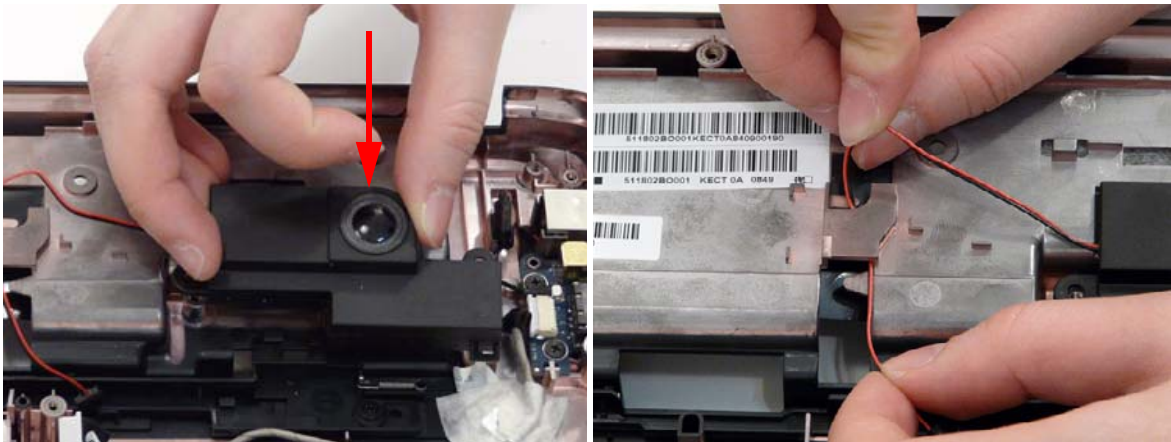

2. Connect the speaker cable to the mainboard.

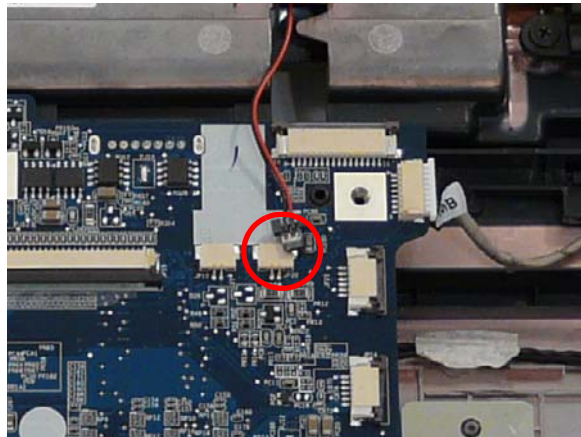

3. Replace the two securing screws on the speaker module.

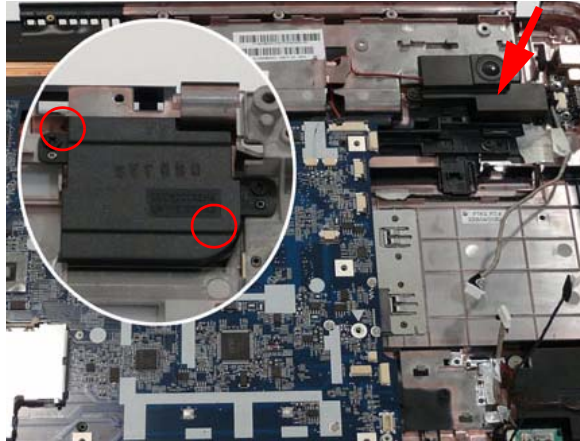

Replacing the Switch Board

1. Position the Switch Board over the screw socket.
2. Replace the single securing screw.

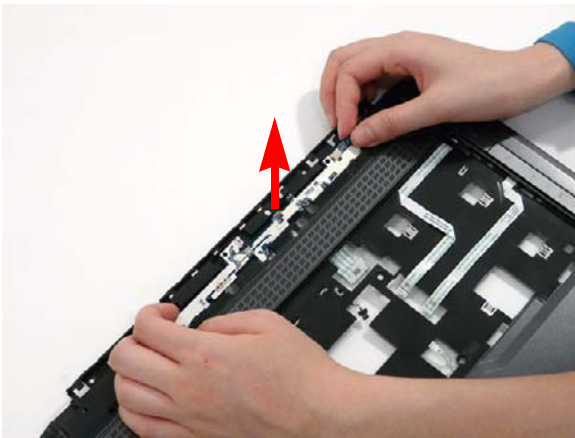

Replacing the eKey Board

1. Insert the FFC through the Upper Cover.

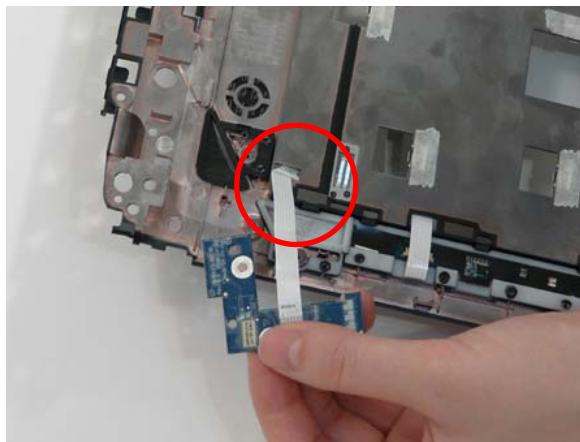

2. Insert the eKey board at an angle and press down to situate.

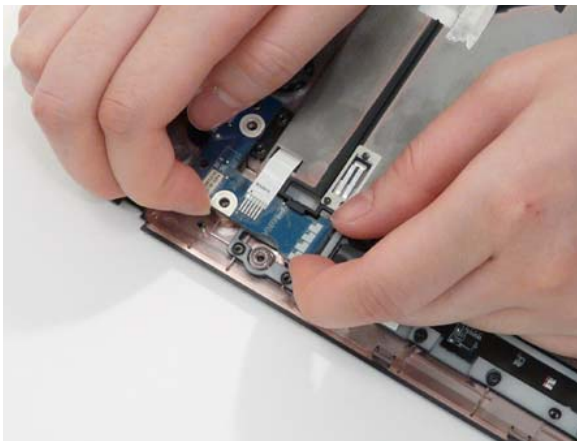

3. Replace the single screw

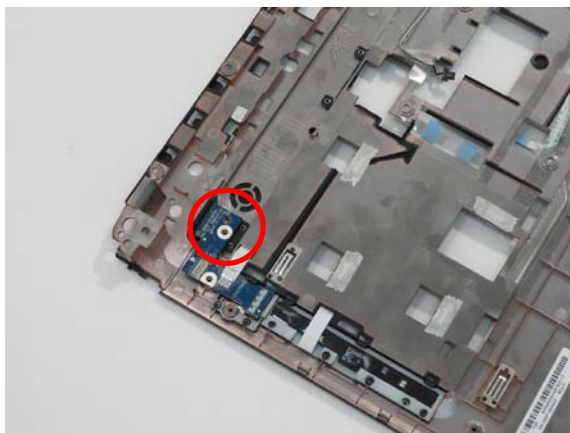

4. Turn the Upper Cover over and press the FFC down to secure in place.

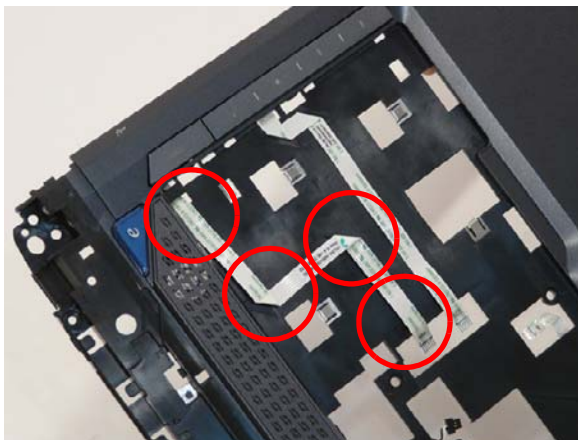

Replacing the Media Board

1. Insert the Media Board into the lower cover. If necessary, use a pry to press the board in place.

IMPORTANT: Do not press on components to prevent damage.

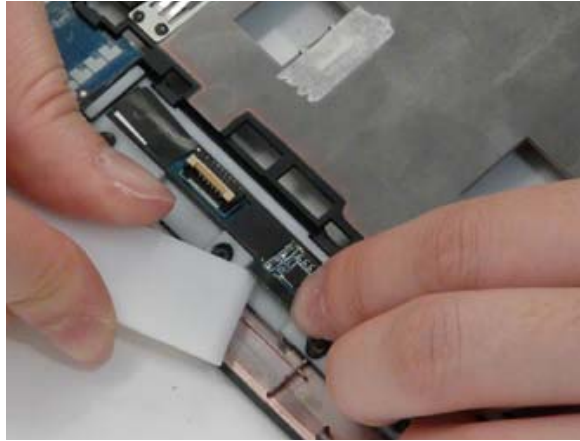

2. Insert the FFC flush with the connector and press the locking lever down to secure.

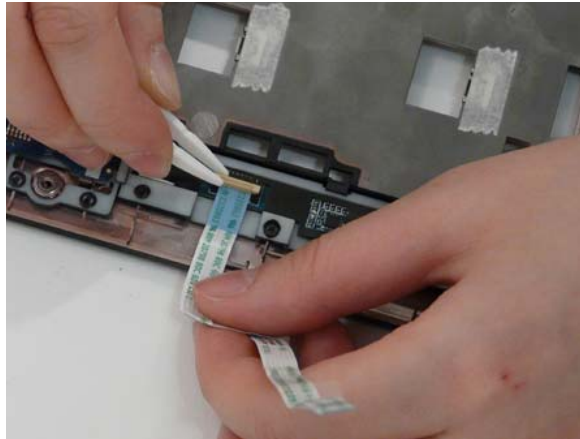

3. Insert the FFC through the chassis.

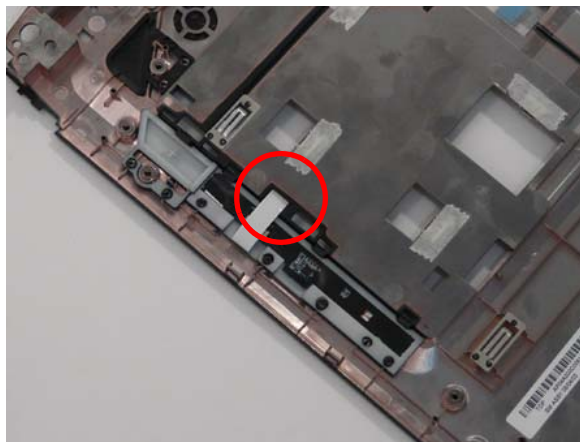

Replacing the Upper Right Saddle

1. Insert the left edge into position and pivot the upper saddle in place.

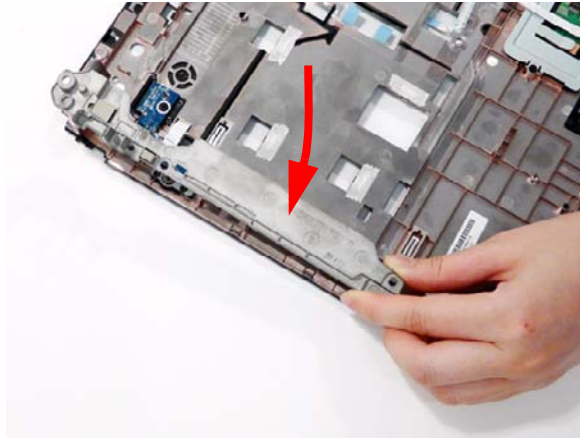

2. Replace the two securing screws on the upper saddle.

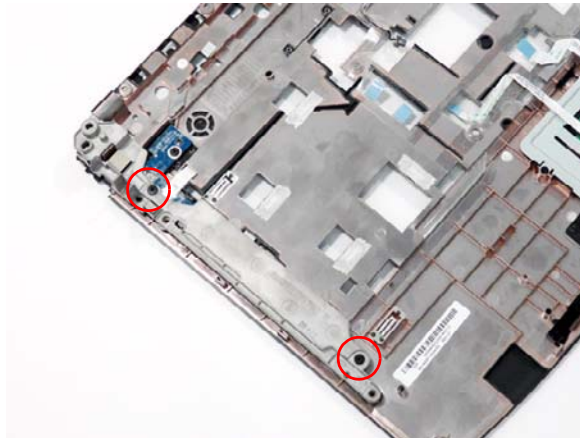

Replacing the Launch Board

1. Insert the left edge of the Launch Board into place and pivot the board down in place.
2. Insert the saddle in place, taking care to locate it over the alignment pins.

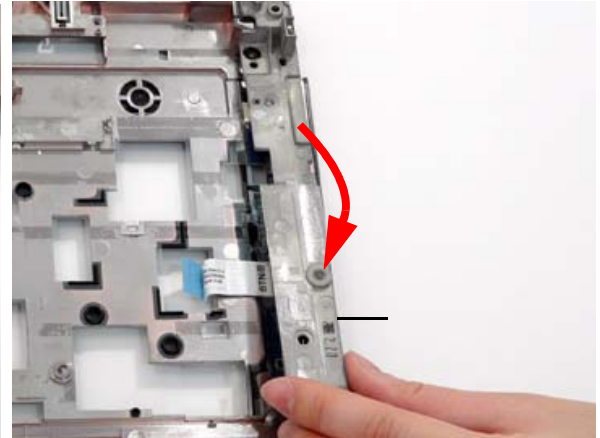
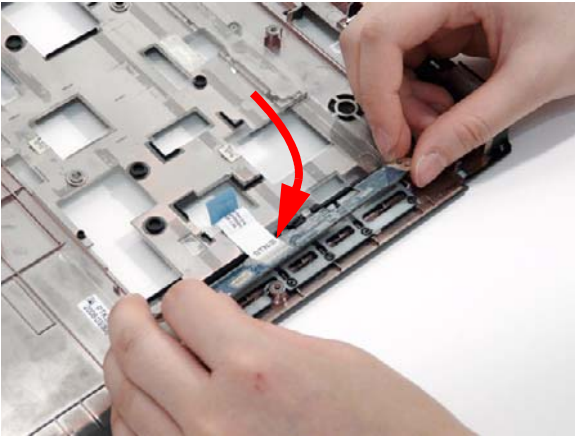

3. Replace the two securing screws.

4. Replace the mylar cover to secure the saddle.

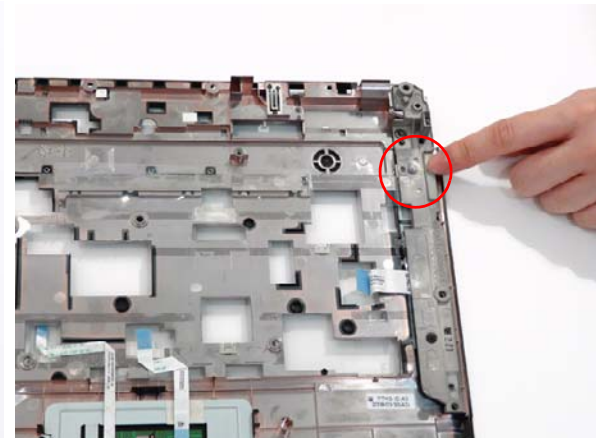
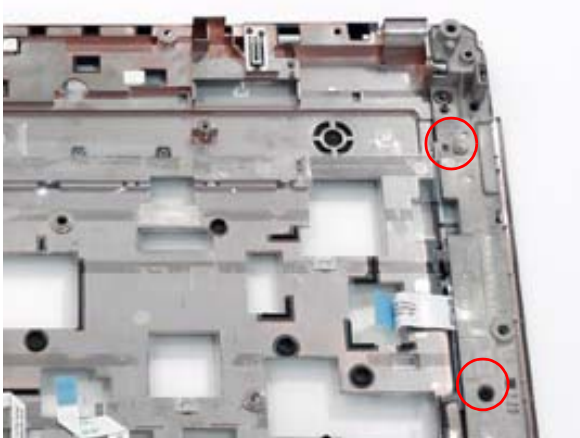

Replacing the Finger Print Reader

1. Replace the Finger Print Reader board in the upper cover.

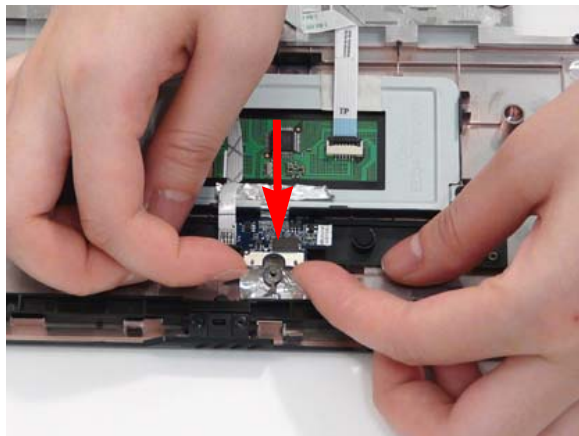

2. Replace the bracket as shown.

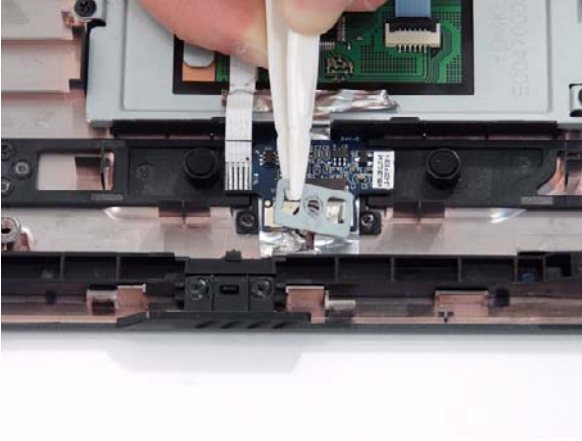

3. Replace the single securing screw.

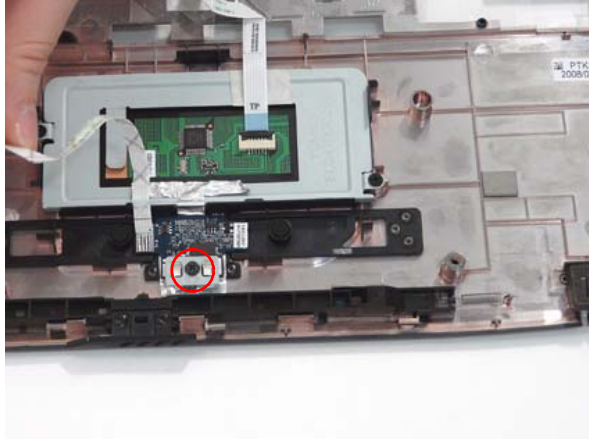

Replacing the TouchPad Bracket

IMPORTANT: The TouchPad cannot be removed individually. To replace the TouchPad, replace the entire Upper Cover.

1. Replace the TouchPad bracket.
2. Replace the two securing screws from the TouchPad bracket.

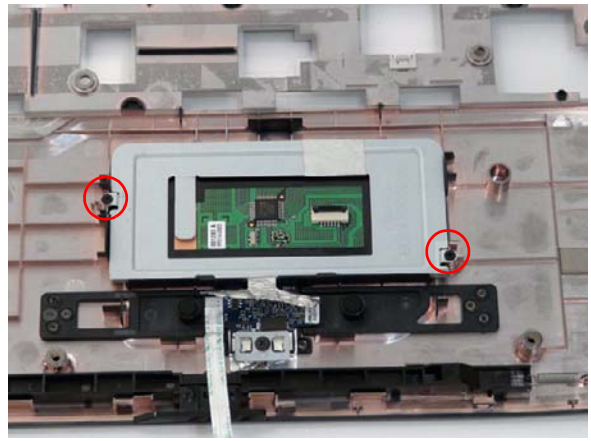
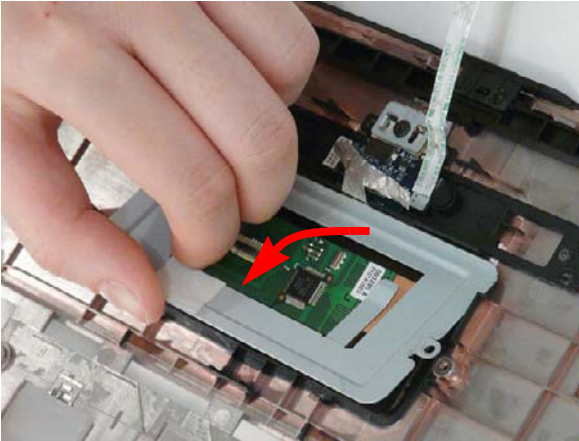

3. Replace the Finger Print reader FFC and secure with the adhesive strips.
4. Replace the TouchPad FFC as shown.

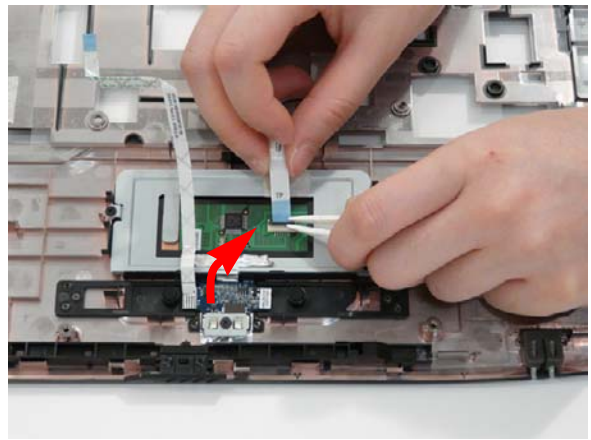
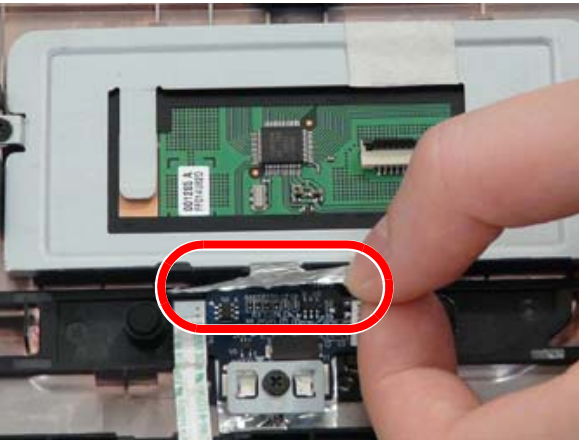

Replacing the Left Speaker Module

1. Align and replace the Speaker Module in the upper case.
2. Grasp both ends of the mylar cover to expose the housing.
3. Replace the speaker cable as shown.

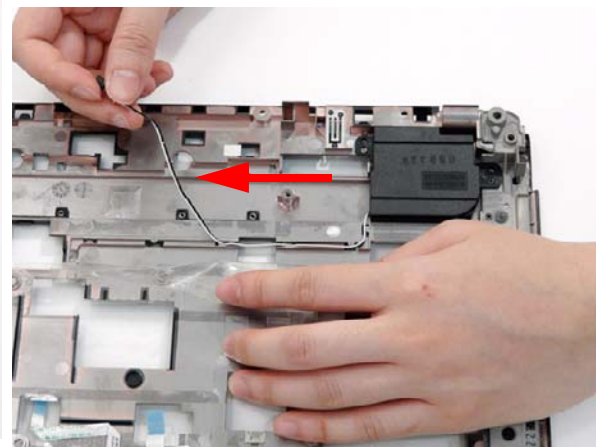
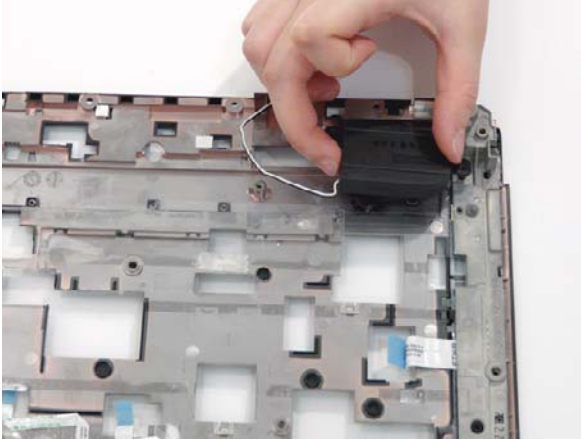

4. While holding the mylar cover back with one hand, replace the speaker cable in its housing.
5. Replace the mylar cover to secure the cable.
6. Replace the two securing screws on the left speaker.

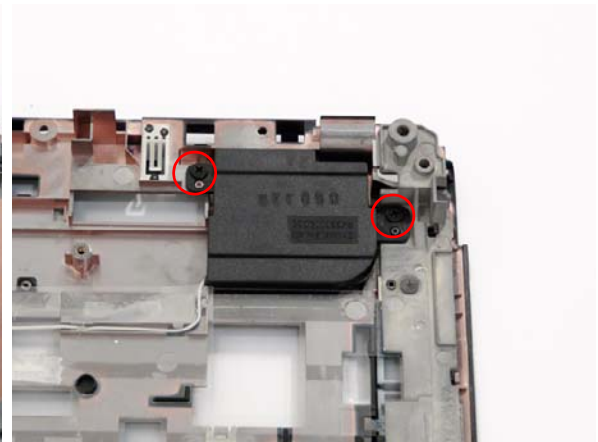
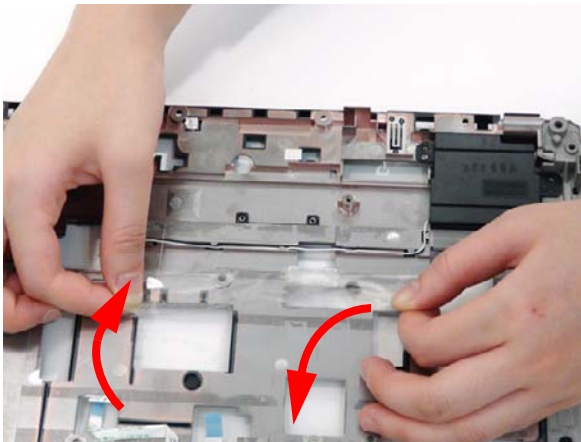

Replacing the Upper Cover

1. Starting with the rear, align the upper cover with the lower cover, taking care to not force in place.

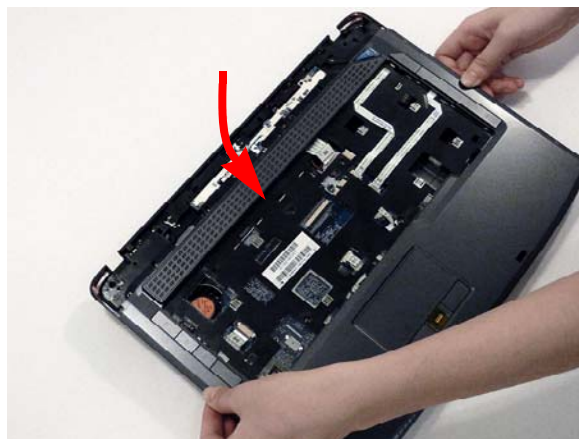

2. Connect the seven cables on the mainboard as shown.

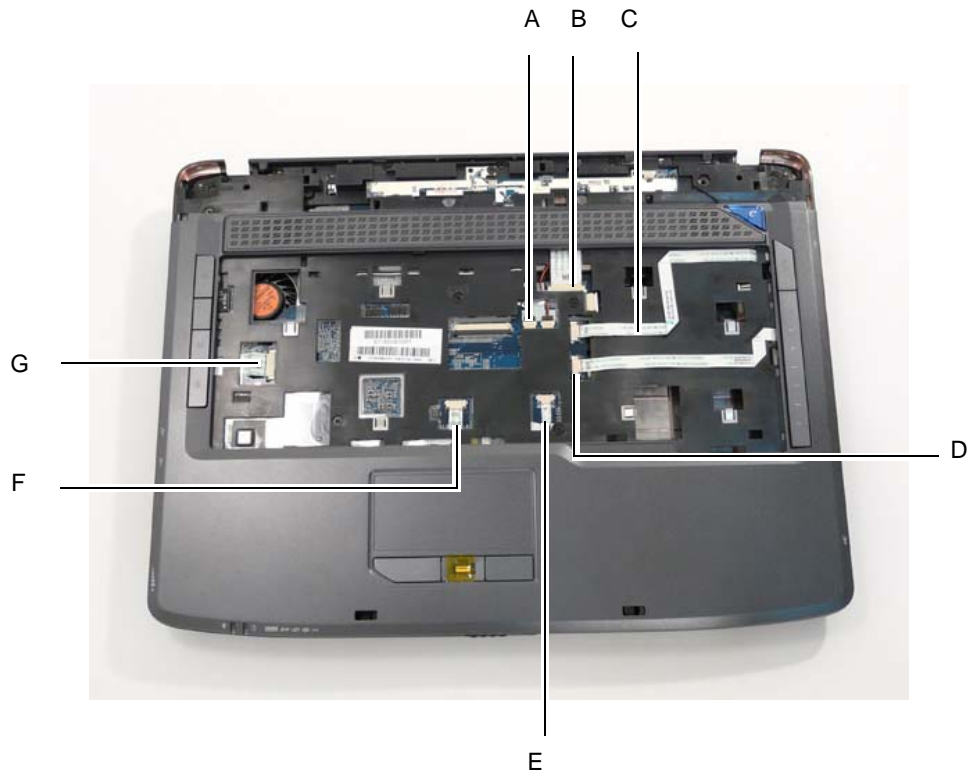

3. Replace the five screws on the top panel.



4. Turn the computer over. Replace the nine screws on the bottom panel.

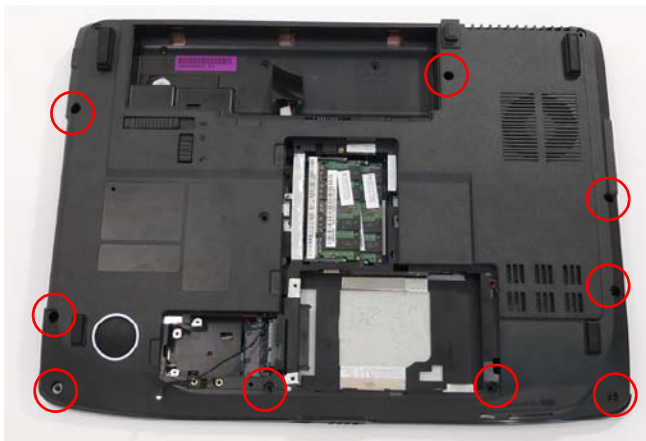

Replacing the LCD Module

1. Carefully align the LCD module over the hinge sockets and lower the module into the chassis.



2. Replace the four securing screws (two on each side) securing the LCD module.

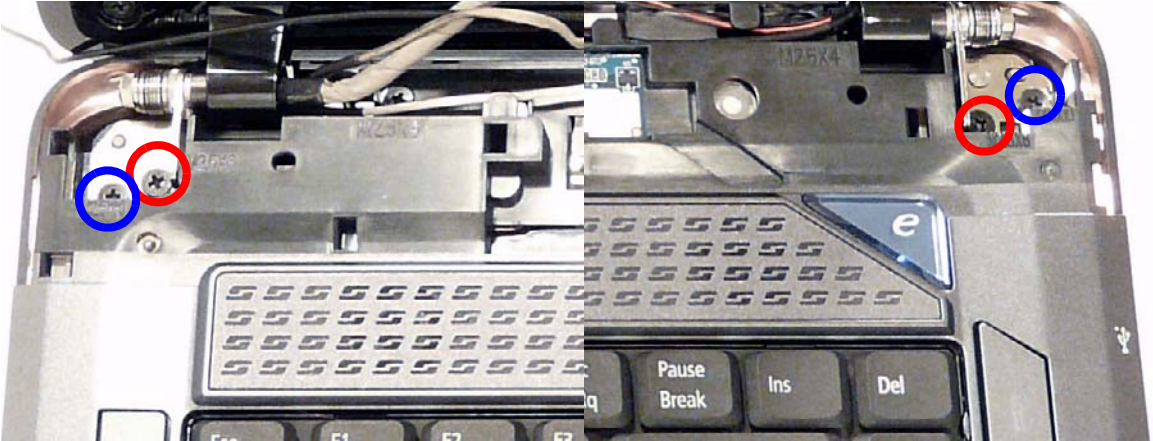

3. Connect the LCD, MIC and back light cables.

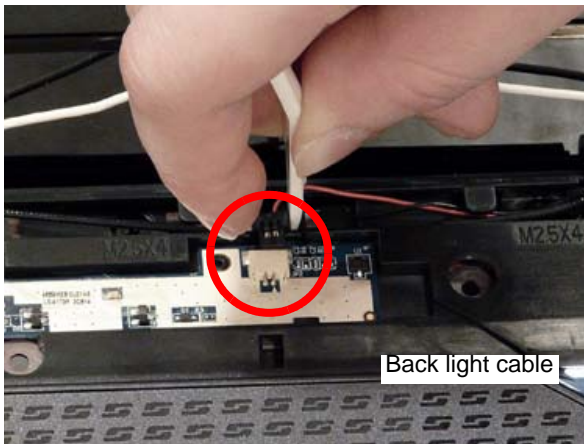
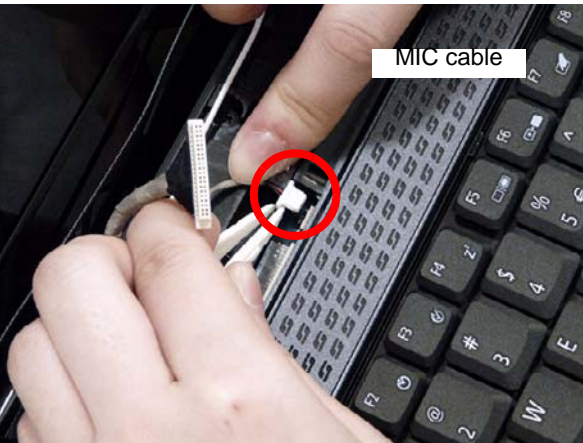
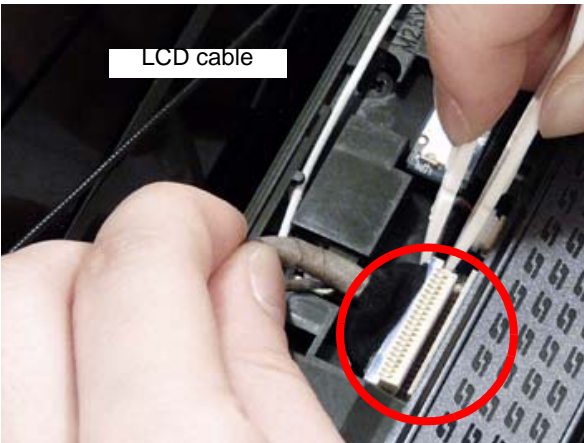

4. Turn the computer over and replace the two securing screws on the bottom of the chassis.

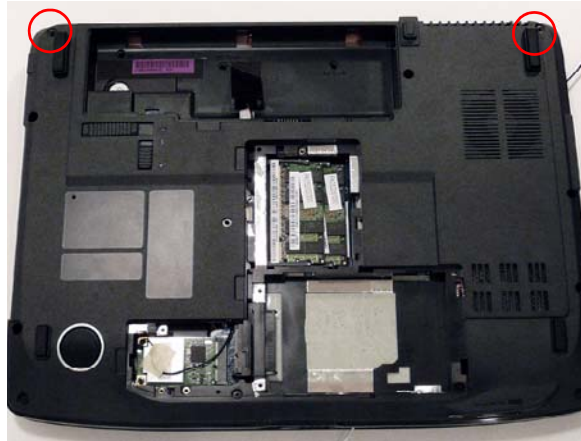

Replacing the Antenna Cables

Ensure that the three Antenna cables pass through the Mainboard and are accessible from the underside of lower cover.

1. Insert the Antenna Cables through the Upper Cover. Make sure they are accessible from the underside.
2. Pull the cables through.

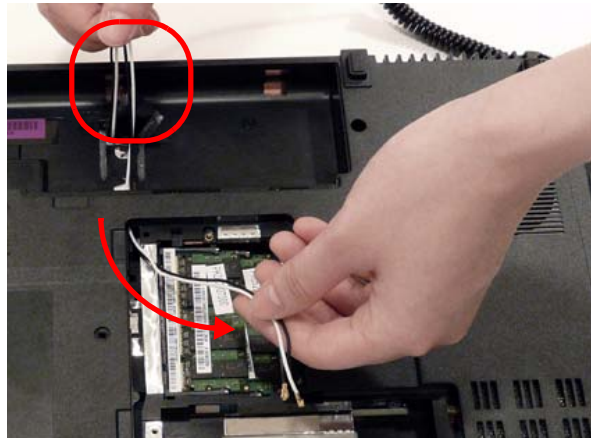

3. Secure the cables in place as shown.

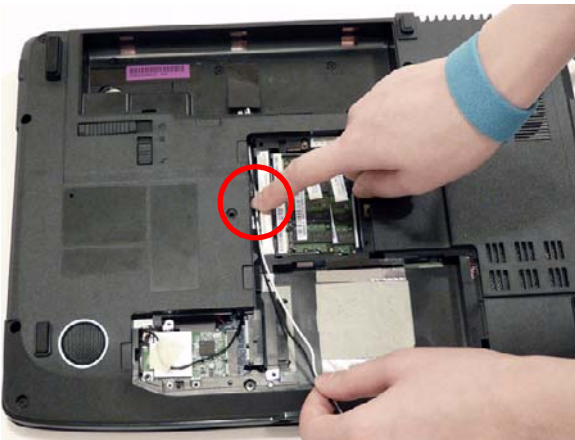

4. Place the cabling in the wiring conduit as shown.

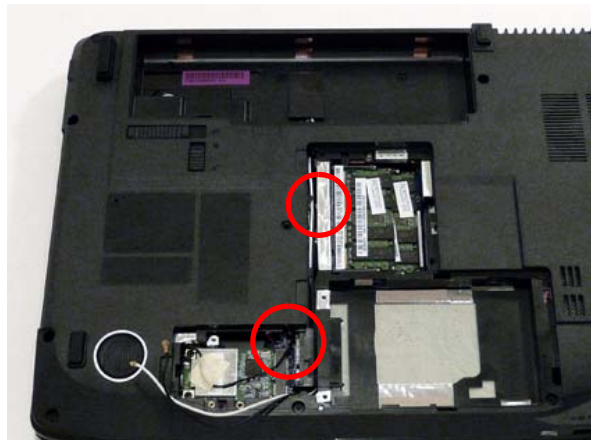

Replacing the Keyboard

1. Align the FFC with the connector and press the latch down to secure.
2. Turn the keyboard over and press down to secure.



Replacing the Switch Cover

1. Insert the left side of the switch cover and angle down in place.
2. Starting from the left, press down on the Switch Cover to secure.



3. Turn the computer over and replace the three securing screws.

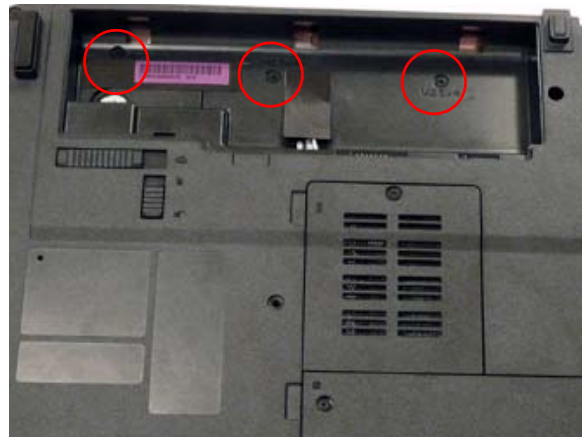

Replacing the TV Tuner Module

4. Replace the tv tuner module.

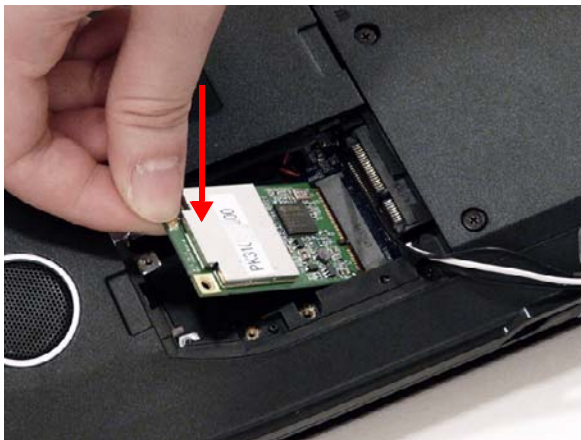

5. Replace the two securing screws.

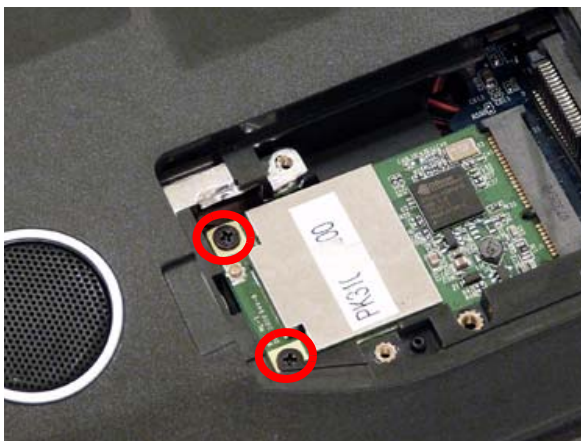

6. Connect the cable to the TV tuner module.

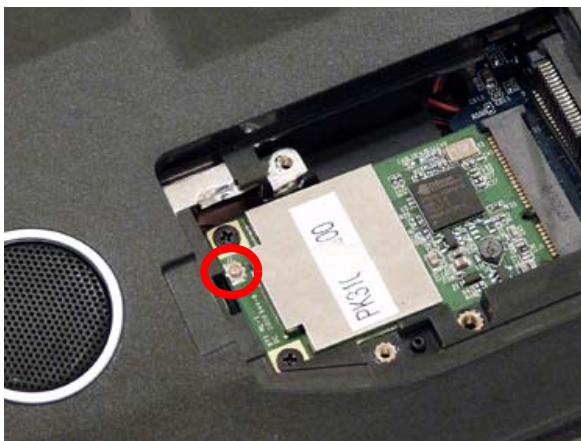

7. Replace the adhesive strip to secure the cable.



8. Replace bracket and secure with provided screw.

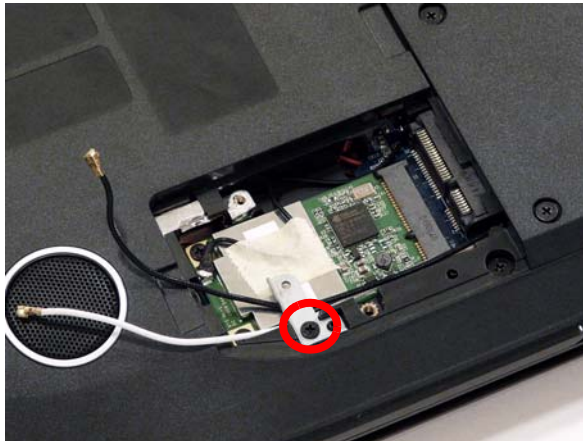

Replacing the WLAN Module

1. Insert the WLAN board into the WLAN socket.



2. Replace the two screws to secure the module.

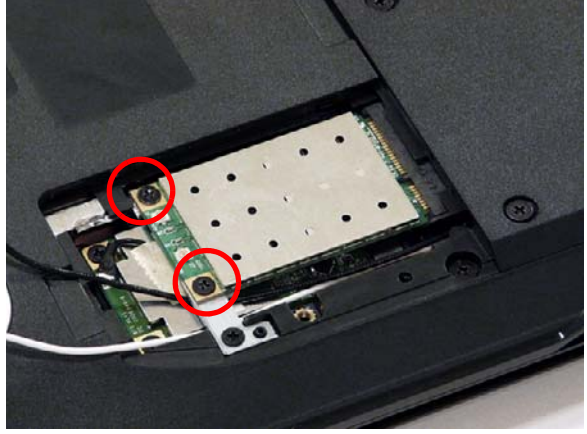

3. Connect the two antenna cables to the module.



Replacing the Hard Disk Drive Module

1. Place the HDD in the HDD carrier.



2. Replace the four screws to secure the carrier.

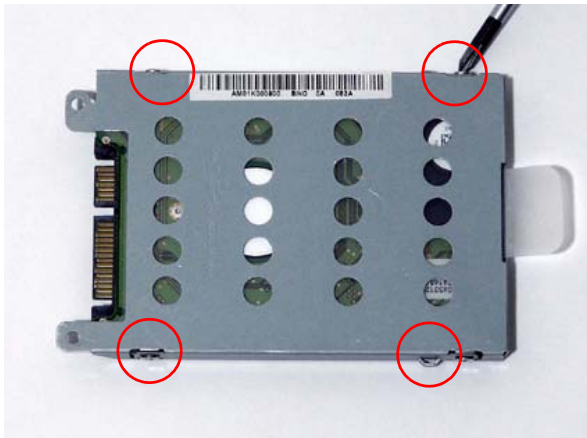

3. Insert the HDD, interface side first, until HDD firmly slides in place.

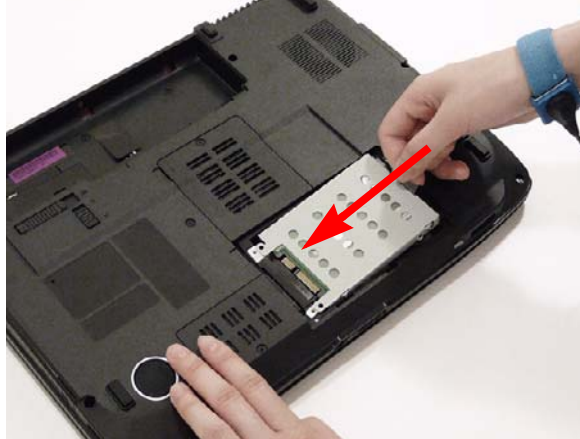

Replacing the DIMM Modules

NOTE: To replace DIMM Module 2, first remove DIMM Module 1. In this procedure, only DIMM Module 1 is shown.

1. Insert the DIMM Module flush with the connector and press down to lock in place.

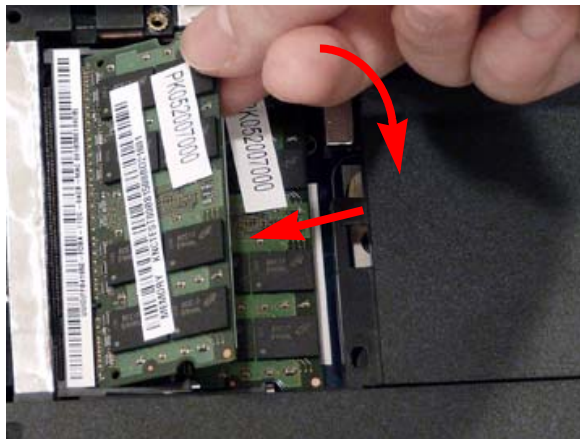

Replacing the ODD Module

1. With the ODD tray in the eject position, replace the ODD cover on the new ODD Module.
2. Press the cover into the tray, bottom edge first, to secure.

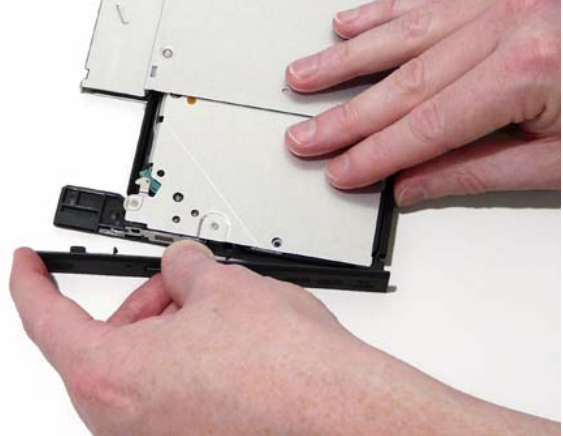
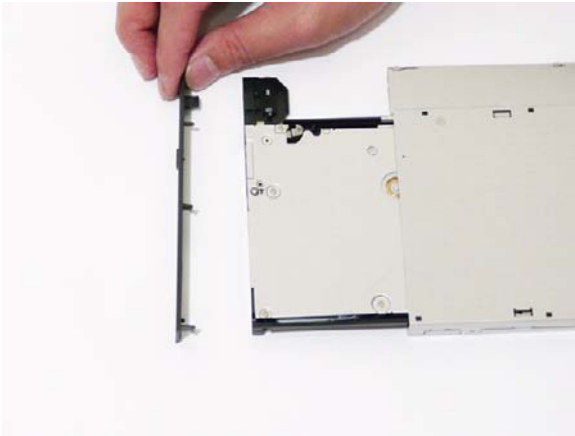

3. Turn the ODD over and replace the three securing screws.
4. Slide Module in chassis and press until Module is flush with chassis.

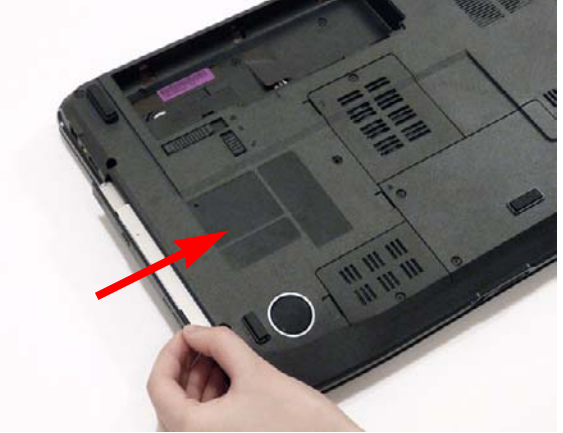

5. Replace the single screw to secure the Module.

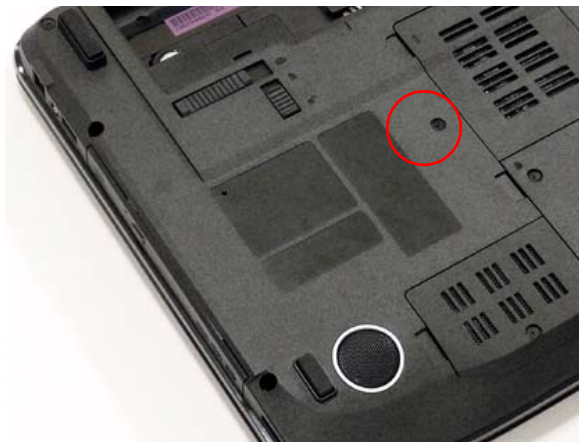

Replacing the Lower Covers

1. Replace the Memory Cover.

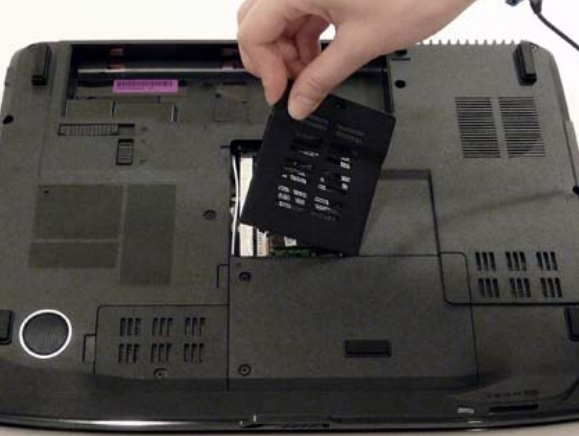

2. Replace the single screw to secure in place.



3. Replace the WLAN Cover.



4. Replace the screw to secure in place.

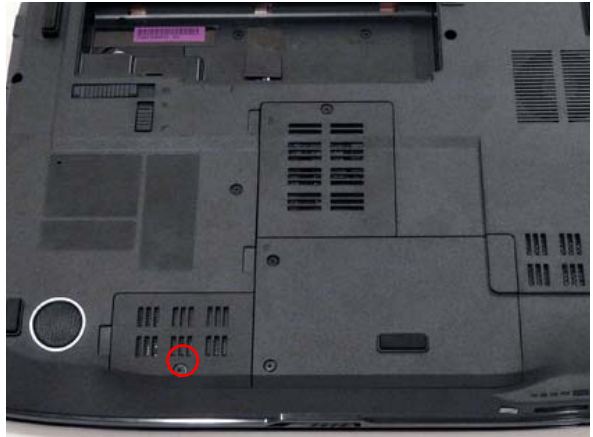

5. Replace HDD Cover.



6. Replace the two screws to secure in place.

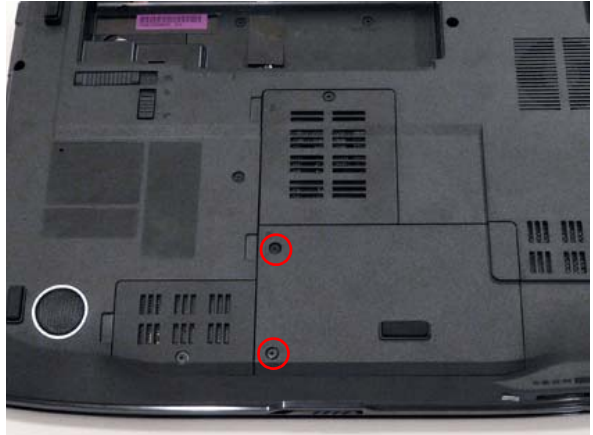

Replacing the Express and SD Card Trays

1. Insert the Express Card and push into the slot until flush with the chassis cover.
2. Insert the SD Card and push into the slot until flush with the chassis cover.



Troubleshooting

Common Problems

Use the following procedure as a guide for computer problems.

NOTE: The diagnostic tests are intended to test only Acer products. Non-Acer products, prototype cards, or modified options can give false errors and invalid system responses.

1. Obtain the failing symptoms in as much detail as possible.
2. Verify the symptoms by attempting to re-create the failure by running the diagnostic test or by repeating the same operation.
3. Use the following table with the verified symptom to determine which page to go to.

Symptoms (Verified)	Go To
Power On Issue	Page 140
No Display Issue	Page 141
LCD Failure	Page 143
Internal Keyboard Failure	Page 143
TouchPad Failure	Page 144
Internal Speaker Failure	Page 144
Internal Microphone Failure	Page 146
ODD Failure	Page 148
Rightside USB Failure	Page 151
Modem Failure	Page 151
WLAN Failure	Page 152
Acer EasyLaunch Button Failure	Page 152
Acer MediaTouch Failure	Page 153
Fingerprint Reader Failure	Page 153
Thermal Unit Failure	Page 154
HDTV Switch Failure	Page 154
Other Functions Failure	Page 155
Intermittent Failures	Page 156
Undermined Failures	Page 156

4. If the Issue is still not resolved, see "Online Support Information" on page 201.

Power On Issue

If the system doesn't power on, perform the following actions one at a time to correct the problem. Do not replace a non-defective FRUs:

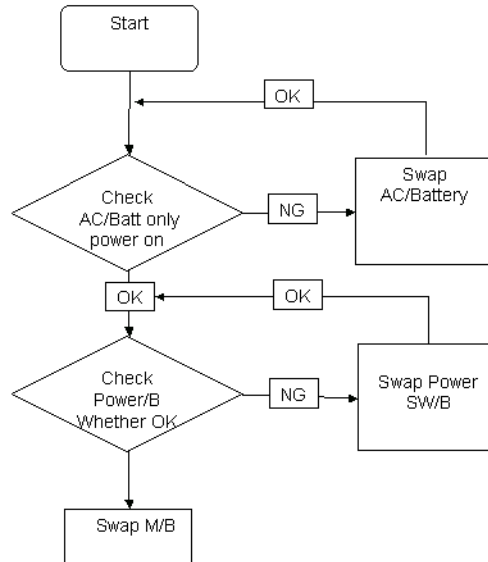

Computer Shutdown Intermittently

If the system powers off at intervals, perform the following actions one at a time to correct the problem.

1. Check the power cable is properly connected to the computer and the electrical outlet.
2. Remove any extension cables between the computer and the outlet.
3. Remove any surge protectors between the computer and the electrical outlet. Plug the computer directly into a known good electrical outlet.
4. Disconnect the power and open the casing to check the Thermal Unit (see "Thermal Unit Failure" on page 154) and fan airways are free of obstructions.
5. Disable the power management settings in the BIOS to ensure they are not the cause of the problem (see "Power" on page 31).
6. Remove all external and non-essential hardware connected to the computer that are not necessary to boot the computer to the failure point.
7. Remove any recently installed software.
8. If the Issue is still not resolved, see "Online Support Information" on page 201.

No Display Issue

If the **Display** doesn't work, perform the following actions one at a time to correct the problem. Do not replace a non-defective FRUs:

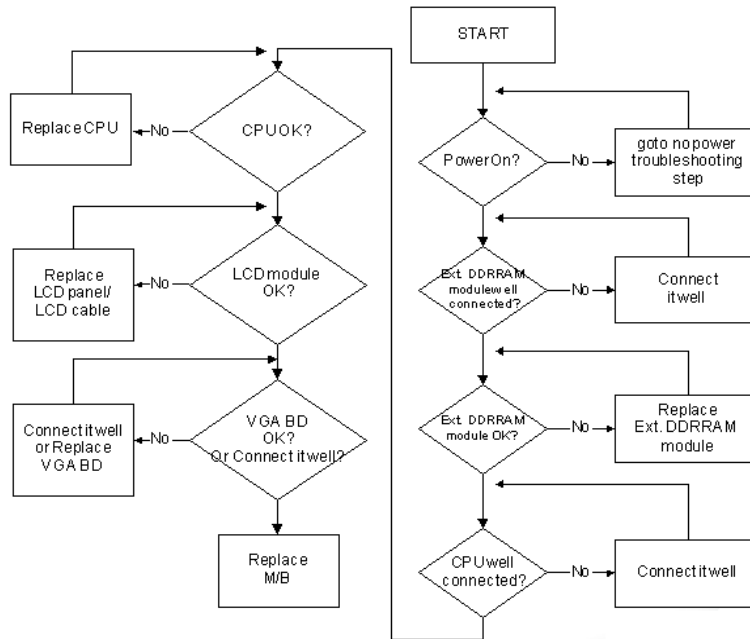

No POST or Video

If the POST or video doesn't display, perform the following actions one at a time to correct the problem.

1. Make sure that the internal display is selected. On this notebook model, switching between the internal display and the external display is done by pressing **Fn+F5**. Reference Product pages for specific model procedures.
2. Make sure the computer has power by checking at least one of the following occurs:
 - Fans start up
 - Status LEDs light up

If there is no power, see “Power On Issue” on page 140.

3. Drain any stored power by removing the power cable and battery and holding down the power button for 10 seconds. Reconnect the power and reboot the computer.
4. Connect an external monitor to the computer and switch between the internal display and the external display is by pressing **Fn+F5** (on this model).

If the POST or video appears on the external display, see “LCD Failure” on page 143.

5. Disconnect power and all external devices including port replicators or docking stations. Remove any memory cards and CD/DVD discs. Restart the computer.

If the computer boots correctly, add the devices one by one until the failure point is discovered.

6. Reseat the memory modules.
7. Remove the drives (see “Disassembly Process” on page 44).
8. If the Issue is still not resolved, see “Online Support Information” on page 201.

Abnormal Video Display

If video displays abnormally, perform the following actions one at a time to correct the problem.

1. Reboot the computer.
2. If permanent vertical/horizontal lines or dark spots display in the same location, the LCD is faulty and should be replaced. See “Disassembly Process” on page 44.
3. If extensive pixel damage is present (different colored spots in the same locations on the screen), the LCD is faulty and should be replaced. See “Disassembly Process” on page 44.
4. Adjust the brightness to its highest level. See the User Manual for instructions on adjusting settings.
NOTE: Ensure that the computer is not running on battery alone as this may reduce display brightness.
If the display is too dim at the highest brightness setting, the LCD is faulty and should be replaced. See “Disassembly Process” on page 44.
5. Check the display resolution is correctly configured:
 - a. Minimize or close all Windows.
 - b. If display size is only abnormal in an application, check the view settings and control/mouse wheel zoom feature in the application.
 - c. If desktop display resolution is not normal, right-click on the desktop and select **Personalize**→ **Display Settings**.
 - d. Click and drag the Resolution slider to the desired resolution.
 - e. Click **Apply** and check the display. Readjust if necessary.
6. Roll back the video driver to the previous version if updated.
7. Remove and reinstall the video driver.
8. Check the Device Manager to determine that:
 - The device is properly installed. There are no red Xs or yellow exclamation marks.
 - There are no device conflicts.
 - No hardware is listed under Other Devices.
9. If the Issue is still not resolved, see “Online Support Information” on page 201.
10. Run the Windows Memory Diagnostic from the operating system DVD and follow the onscreen prompts.
11. If the Issue is still not resolved, see “Online Support Information” on page 201.

Random Loss of BIOS Settings

If the computer is experiencing intermittent loss of BIOS information, perform the following actions one at a time to correct the problem.

1. If the computer is more than one year old, replace the CMOS battery.
2. Run a complete virus scan using up-to-date software to ensure the computer is virus free.
3. If the computer is experiencing HDD or ODD BIOS information loss, disconnect and reconnect the power and data cables between devices.
If the BIOS settings are still lost, replace the cables.
4. If HDD information is missing from the BIOS, the drive may be defective and should be replaced.
5. Replace the Motherboard.
6. If the Issue is still not resolved, see “Online Support Information” on page 201.

LCD Failure

If the **LCD** fails, perform the following actions one at a time to correct the problem. Do not replace a non-defective FRUs:

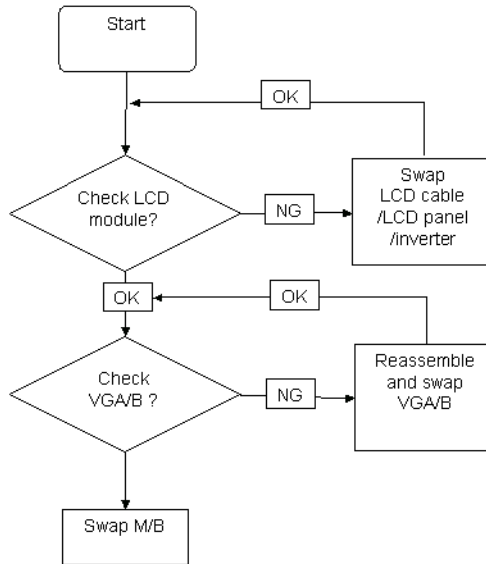

Built-In Keyboard Failure

If the built-in **Keyboard** fails, perform the following actions one at a time to correct the problem. Do not replace a non-defective FRUs:

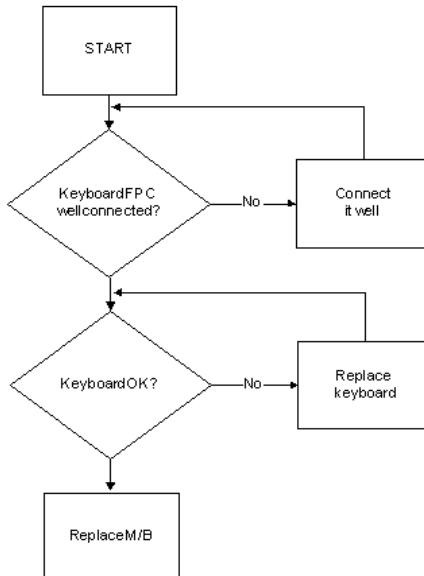

TouchPad Failure

If the **TouchPad** doesn't work, perform the following actions one at a time to correct the problem. Do not replace a non-defective FRUs:

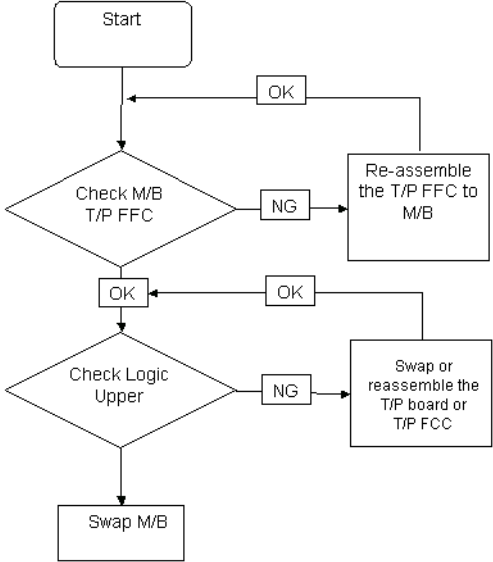

Internal Speaker Failure

If the internal **Speakers** fail, perform the following actions one at a time to correct the problem. Do not replace a non-defective FRUs:

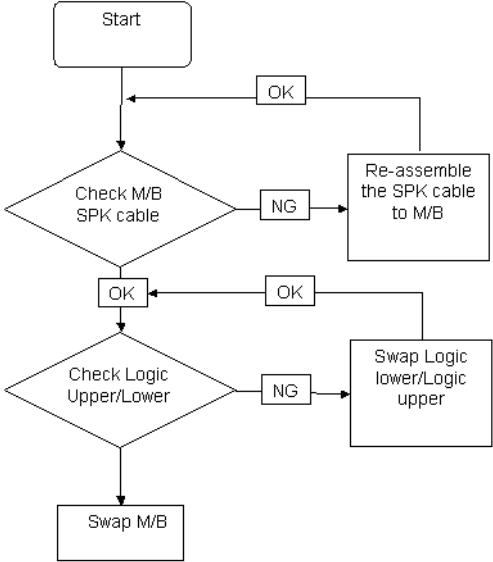

Sound Problems

If sound problems are experienced, perform the following actions one at a time to correct the problem.

1. Reboot the computer.
2. Navigate to **Start** → **Control Panel** → **System and Maintenance** → **System** → **Device Manager**. Check the Device Manager to determine that:
 - The device is properly installed.
 - There are no red Xs or yellow exclamation marks.
 - There are no device conflicts.
 - No hardware is listed under Other Devices.
3. Roll back the audio driver to the previous version, if updated recently.
4. Remove and reinstall the audio driver.
5. Ensure that all volume controls are set mid range:
 - a. Click the volume icon on the taskbar and drag the slider to 50. Ensure that the volume is not muted.
 - b. Click Mixer to verify that other audio applications are set to 50 and not muted.
6. Navigate to **Start** → **Control Panel** → **Hardware and Sound** → **Sound**. Ensure that Speakers are selected as the default audio device (green check mark).

NOTE: If Speakers does not show, right-click on the **Playback** tab and select **Show Disabled Devices** (clear by default).
7. Select Speakers and click **Configure** to start **Speaker Setup**. Follow the onscreen prompts to configure the speakers.
8. Remove and recently installed hardware or software.
9. Restore system and file settings from a known good date using **System Restore**.

If the issue is not fixed, repeat the preceding steps and select an earlier time and date.
10. Reinstall the Operating System.
11. If the Issue is still not resolved, see “Online Support Information” on page 201.

Internal Microphone Failure

If the internal **Microphone** fails, perform the following actions one at a time to correct the problem. Do not replace a non-defective FRUs:

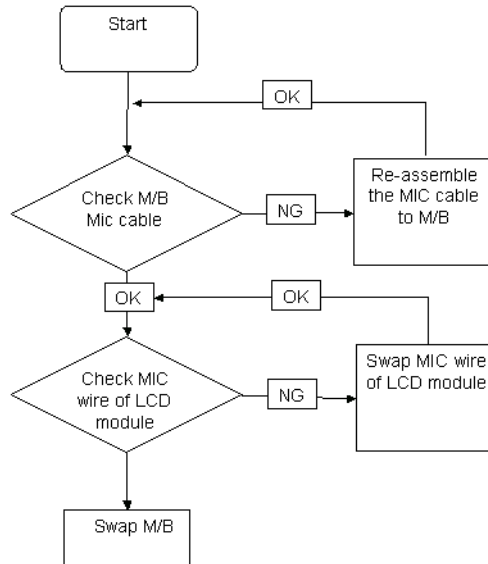

Microphone Problems

If internal or external **Microphones** do not operate correctly, perform the following actions one at a time to correct the problem.

1. Check that the microphone is enabled. Navigate to **Start** → **Control Panel** → **Hardware and Sound** → **Sound** and select the **Recording** tab.
2. Right-click on the **Recording** tab and select **Show Disabled Devices** (clear by default).
3. The microphone appears on the **Recording** tab.
4. Right-click on the microphone and select **Enable**.
5. Select the microphone then click **Properties**. Select the **Levels** tab.
6. Increase the volume to the maximum setting and click **OK**.
7. Test the microphone hardware:
 - a. Select the microphone and click **Configure**.
 - b. Select **Set up microphone**.
 - c. Select the microphone type from the list and click **Next**.
 - d. Follow the onscreen prompts to complete the test.
8. If the Issue is still not resolved, see "Online Support Information" on page 201.

HDD Not Operating Correctly

If the **HDD** does not operate correctly, perform the following actions one at a time to correct the problem.

1. Disconnect all external devices.
2. Run a complete virus scan using up-to-date software to ensure the computer is virus free.
3. Run the Windows Vista Startup Repair Utility:
 - a. insert the Windows Vista Operating System DVD in the ODD and restart the computer.
 - b. When prompted, press any key to start to the operating system DVD.
 - c. The **Install Windows** screen displays. Click **Next**.
 - d. Select **Repair your computer**.
 - e. The **System Recovery Options** screen displays. Click **Next**.
 - f. Select the appropriate operating system, and click **Next**.

NOTE: Click **Load Drivers** if controller drives are required.

- g. Select **Startup Repair**.
- h. Startup Repair attempts to locate and resolve issues with the computer.
- i. When complete, click **Finish**.

If an issue is discovered, follow the onscreen information to resolve the problem.

4. Run the Windows Memory Diagnostic Tool. For more information see Windows Help and Support.
5. Restart the computer and press F2 to enter the BIOS Utility. Check the BIOS settings are correct and that CD/DVD drive is set as the first boot device on the Boot menu.
6. Ensure all cables and jumpers on the HDD and ODD are set correctly.
7. Remove any recently added hardware and associated software.
8. Run the Windows Disk Defragmenter. For more information see Windows Help and Support.
9. Run Windows Check Disk by entering **chkdsk /r** from a command prompt. For more information see Windows Help and Support.
10. Restore system and file settings from a known good date using **System Restore**.

If the issue is not fixed, repeat the preceding steps and select an earlier time and date.
11. Replace the HDD. See "Disassembly Process" on page 44.

ODD Failure

If the **ODD** fails, perform the following actions one at a time to correct the problem. Do not replace a non-defective FRUs:

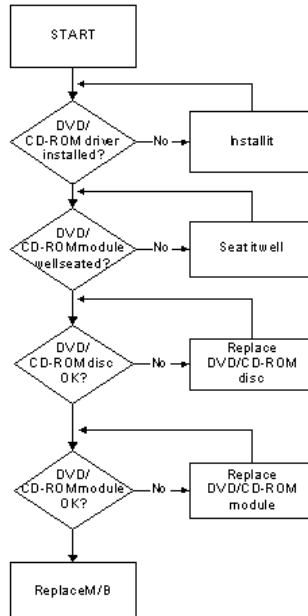

ODD Not Operating Correctly

If the **ODD** exhibits any of the following symptoms it may be faulty:

- Audio CDs do not play when loaded
- DVDs do not play when loaded
- Blank discs do not burn correctly
- DVD or CD play breaks up or jumps
- Optical drive not found or not active:
 - Not shown in My Computer or the BIOS setup
 - LED does not flash when the computer starts up
 - The tray does not eject
- Access failure screen displays
- The ODD is noisy

Perform the following general solutions one at a time to correct the problem.

1. Reboot the computer and retry the operation.
2. Try an alternate disc.
3. Navigate to **Start** → **Computer**. Check that the ODD device is displayed in the **Devices with Removable Storage** panel.
4. Navigate to **Start** → **Control Panel** → **System and Maintenance** → **System** → **Device Manager**.
 - a. Double-click **IDE ATA/ATAPI controllers**. If a device displays a down arrow, right-click on the device and click **Enable**.
 - b. Double-click **DVD/CD-ROM drives**. If the device displays a down arrow, right-click on the device and click **Enable**.

-
- c. Check that there are no yellow exclamation marks against the items in **IDE ATA/ATAPI controllers**. If a device has an exclamation mark, right-click on the device and uninstall and reinstall the driver.
 - d. Check that there are no yellow exclamation marks against the items in **DVD/CD-ROM drives**. If a device has an exclamation mark, right-click on the device and uninstall and reinstall the driver.
 - e. If the exclamation marker is not removed from the item in the lists, try removing any recently installed software and retrying the operation.

Discs Do Not Play

If discs do not play when inserted in the drive, perform the following actions one at a time to correct the problem.

1. Check that the disc is correctly seated in the drive tray and that the label on the disc is visible.
2. Check that the media is clean and scratch free.
3. Try an alternate disc in the drive.
4. Ensure that **AutoPlay** is enabled:
 - a. Navigate to **Start** → **Control Panel** → **Hardware and Sound** → **AutoPlay**.
 - b. Select **Use AutoPlay for all media and devices**.
 - c. In the Audio CD and DVD Movie fields, select the desired player from the drop down menu.
5. Check that the Regional Code is correct for the selected media:

IMPORTANT:Region can only be changed a limited number of times. After Changes remaining reaches zero, the region cannot be changed even Windows is reinstalled or the drive is moved to another computer.

- a. Navigate to **Start** → **Control Panel** → **System and Maintenance** → **System** → **Device Manager**.
- b. Double-click **DVD/CD-ROM drives**.
- c. Right-click **DVD drive** and click **Properties**, then click the **DVD Region** tab.
- d. Select the region suitable for the media inserted in the drive.

Discs Do Not Burn Properly

If discs can not be burned, perform the following actions one at a time to correct the problem.

1. Ensure that the default drive is record enabled:
 - a. Navigate to **Start** → **Computer** and right-click the writable ODD icon. Click **Properties**.
 - b. Select the **Recording** tab. In the **Desktop disc recording** panel, select the writable ODD from the drop down list.
 - c. Click **OK**.
2. Ensure that the software used for burning discs is the factory default. If using different software, refer to the software's user manual.

Playback is Choppy

If playback is choppy or jumps, perform the following actions one at a time to correct the problem.

1. Check that system resources are not running low:
 - a. Try closing some applications.
 - b. Reboot and try the operation again.
2. Check that the ODD controller transfer mode is set to DMA:
 - a. Navigate to **Start** → **Control Panel** → **System and Maintenance** → **System** → **Device Manager**.
 - b. Double-click **IDE ATA/ATAPI controllers**, then right-click ATA Device 0.
 - c. Click **Properties** and select the **Advanced Settings** tab. Ensure that the **Enable DMA** box is checked and click **OK**.

-
- d. Repeat for the other ATA Devices shown if applicable.

Drive Not Detected

If Windows cannot detect the drive, perform the following actions one at a time to correct the problem.

1. Restart the computer and press F2 to enter the BIOS Utility.
2. Check that the drive is detected in the **ATAPI Model Name** field on the Information page.
NOTE: Check that the entry is identical to one of the ODDs specified in “Hardware Specifications and Configurations” on page 16.
3. Turn off the power and remove the cover to inspect the connections to the ODD. See “Disassembly Process” on page 44.
 - a. Check for broken connectors on the drive, motherboard, and cables.
 - b. Check for bent or broken pins on the drive, motherboard, and cable connections.
 - c. Try an alternate cable, if available. If the drive works with the new cable, the original cable should be replaced.
4. Reseat the drive ensuring and all cables are connected correctly.
5. Replace the ODD. See “Disassembly Process” on page 44.

Drive Read Failure

If discs cannot be read when inserted in the drive, perform the following actions one at a time to correct the problem.

1. Remove and clean the failed disc.
2. Retry reading the CD or DVD.
 - d. Test the drive using other discs.
 - e. Play a DVD movie
 - f. Listen to a music CD

If the ODD works properly with alternate discs, the original disc is probably defective and should be replaced.

3. Turn off the power and remove the cover to inspect the connections to the ODD. See “Disassembly Process” on page 44.
 - a. Check for broken connectors on the drive, motherboard, and cables.
 - b. Check for bent or broken pins on the drive, motherboard, and cable connections.
 - c. Try an alternate cable, if available. If the drive works with the new cable, the original cable should be replaced.
4. Replace the ODD. See “Disassembly Process” on page 44.

USB Failure (Rightside)

If the rightside **USB** port fails, perform the following actions one at a time to correct the problem. Do not replace a non-defective FRUs:

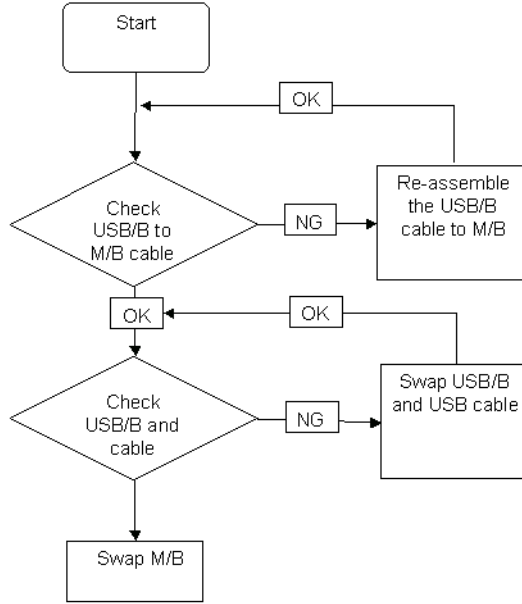

Modem Function Failure

If the internal **Modem** fails, perform the following actions one at a time to correct the problem. Do not replace a non-defective FRUs:

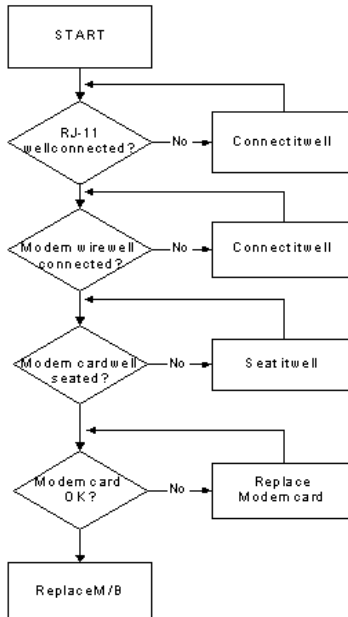

Wireless Function Failure

If the **WLAN** fails, perform the following actions one at a time to correct the problem. Do not replace a non-defective FRUs:

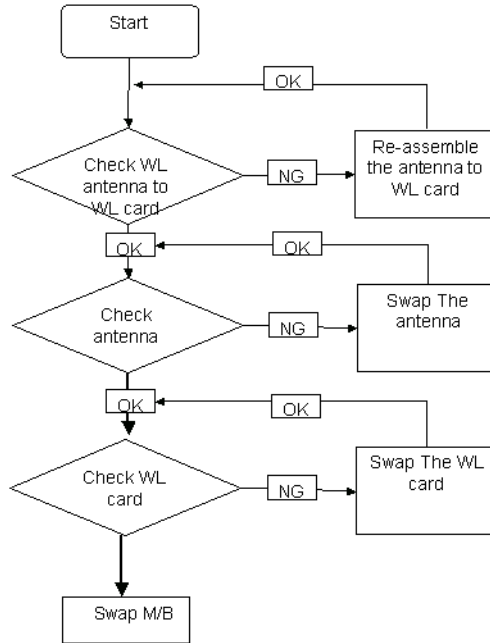

EasyTouch Button Failure

If the **Acer EasyTouch** buttons fail, perform the following actions one at a time to correct the problem. Do not replace a non-defective FRUs:

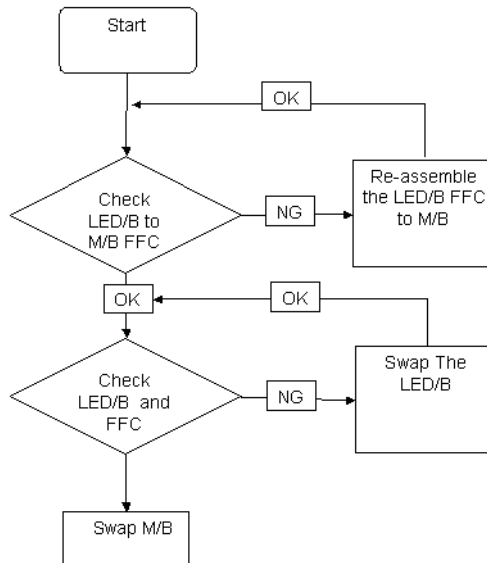

MediaTouch Button Failure

If the **Acer MediaTouch** buttons fail, perform the following actions one at a time to correct the problem. Do not replace a non-defective FRUs:

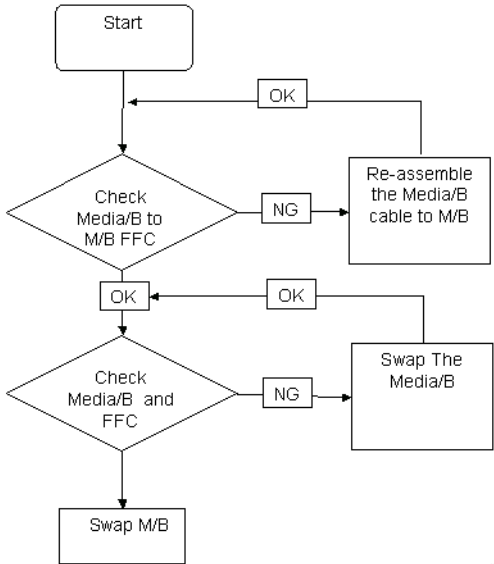

Fingerprint Reader Failure

If the **Fingerprint Reader** fails, perform the following actions one at a time to correct the problem. Do not replace a non-defective FRUs:

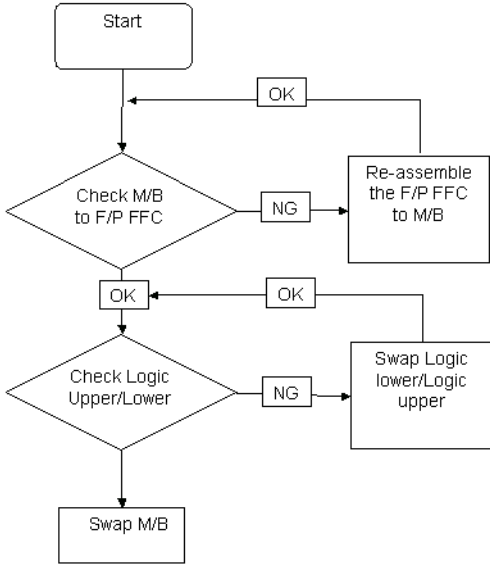

Thermal Unit Failure

If the **Thermal Unit** fails, perform the following actions one at a time to correct the problem. Do not replace a non-defective FRUs:

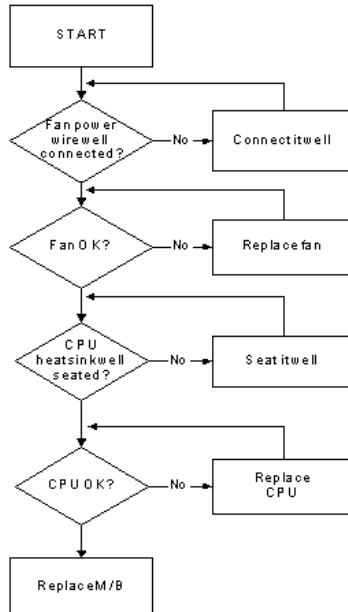

HDTV Switch Failure

If the **HDTV Switch** fails, perform the following actions one at a time to correct the problem. Do not replace a non-defective FRUs:

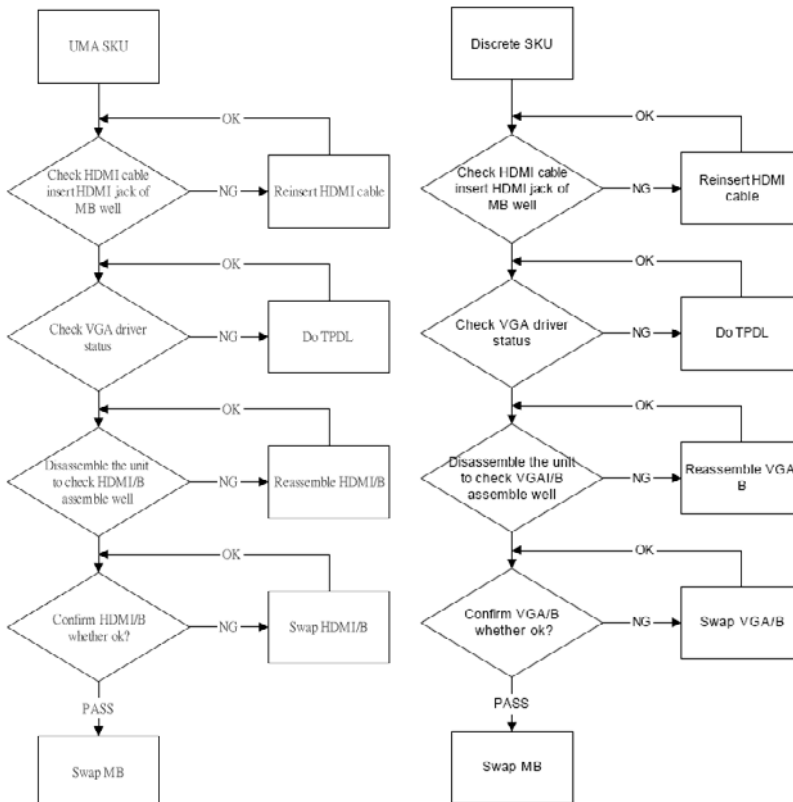

External Mouse Failure

If an external **Mouse** fails, perform the following actions one at a time to correct the problem.

1. Try an alternative mouse.
2. If the mouse uses a wireless connection, insert new batteries and confirm there is a good connection. See the mouse user manual.
3. If the mouse uses a USB connection, try an alternate USB port.
4. Try an alternative program to verify mouse operation. Reinstall the program experiencing mouse failure.
5. Restart the computer.
6. Remove any recently added hardware and associated software.
7. Remove any recently added software and reboot.
8. Restore system and file settings from a known good date using **System Restore**.

If the issue is not fixed, repeat the preceding steps and select an earlier time and date.

9. Run the Event Viewer to check the events log for errors. For more information see Windows Help and Support.
10. Roll back the mouse driver to the previous version if updated recently.
11. Remove and reinstall the mouse driver.
12. Check the Device Manager to determine that:
 - The device is properly installed. There are no red Xs or yellow exclamation marks.
 - There are no device conflicts.
 - No hardware is listed under Other Devices.
13. If the Issue is still not resolved, see "Online Support Information" on page 201.

Other Failures

If the CRT Switch, Dock, LAN Port, external MIC or Speakers, PCI Express Card, 5-in-1 Card Reader or Volume Wheel fail, perform the following general steps to correct the problem. Do not replace a non-defective FRUs:

1. Check Drive whether is OK.
2. Check Test Fixture is ok.
3. Swap M/B to Try.

Intermittent Problems

Intermittent system hang problems can be caused by a variety of reasons that have nothing to do with a hardware defect, such as: cosmic radiation, electrostatic discharge, or software errors. FRU replacement should be considered only when a recurring problem exists.

When analyzing an intermittent problem, do the following:

1. Run the advanced diagnostic test for the system board in loop mode at least 10 times.
2. If no error is detected, do not replace any FRU.
3. If any error is detected, replace the FRU. Rerun the test to verify that there are no more errors.

Undetermined Problems

The diagnostic problems does not identify which adapter or device failed, which installed devices are incorrect, whether a short circuit is suspected, or whether the system is inoperative.

Follow these procedures to isolate the failing FRU (do not isolate non-defective FRU).

NOTE: Verify that all attached devices are supported by the computer.

NOTE: Verify that the power supply being used at the time of the failure is operating correctly. (See “Power On Issue” on page 140.):

1. Power-off the computer.
2. Visually check them for damage. If any problems are found, replace the FRU.
3. Remove or disconnect all of the following devices:
 - Non-Acer devices
 - Printer, mouse, and other external devices
 - Battery pack
 - Hard disk drive
 - DIMM
 - CD-ROM/Diskette drive Module
 - PC Cards
4. Power-on the computer.
5. Determine if the problem has changed.
6. If the problem does not recur, reconnect the removed devices one at a time until you find the failing FRU.
7. If the problem remains, replace the following FRU one at a time. Do not replace a non-defective FRU:
 - System board
 - LCD assembly

POST Codes Tables

These tables describe the POST codes, functions, phases, and components for the POST.

Port 80 Codes

Driver Name	Port80 Code	Driver Name	Port80 Code
PeiEventLog	01	Cpulo	3E
OemServices	02	Cf9Reset	3F
Siolnit	03	PcRtc	40
MonoStatusCode	04	StatusCode	41
PentiumMCpuPeim	08	Variable	42
PlatformStage1	09	SmmVariable	CF
Variable	0A	EmuVariable	43
IchInit	0B	TcgDxe	A2
PlatformStage2	0D	PhysicalPresence	A3
IchSmbusArpDisabled	0E	TpmDriver	AE
ClockGen	12	TcgSmm	AE
OpPresence	13	PhysicalPresenceReadyToBoot	AE
TcgPei	14	DataHubRecordPolicy	AD
FindFv	15	Undi	86
Dxelpl	2F	SNP	90
LightMemoryInit	10	BC	91
S3ResumeSoftSmi	11	PxeDhcp4	92
Crc32SectionExtract	31	Ebc	93
OemServices	A4	IsaBus	4D
EventLog	A5	IsaSerial	4E
ScriptSave	32	Ps2Mouse	6D
AcpiS3Save	33	IdeBus	4F
SmartTimer	34	LightPciBus	50
JpegDecoder	35	UsbBot	6E
PcxDecoder	36	UsbCbi0	6F
PlatformBds	8A	UsbCbi1	70
MpCpu	37	UsbKb	71
LegacyMetronome	38	UsbMassStorage	72
FtwLite	39	UsbMouse	74
Runtime	3A	Ehci	8F
MonotonicCounter	3B	Uhci	73
WatchDogTimer	3C	UsbBus	75
SecurityStub	3D	SmmBase	C2

Port80 Codes Continued

Driver Name	Port80 Code	Driver Name	Port80 Code
SmmDisp	C5	HiiDatabase	80
SmmReloc	C4	OemSetupBrowser	82
SmmRuntime	C7	Font(English)	7E
SmmThunk	C9	Font(French)	7F
OemServices	D8	Font (Chinese)	8D
ChipsetInit	44	UnicodeCollation	B1
SmmAccess	C0	ConPlatform	5A
PciHostBridge	46	ConSplitter	5D
PciExpress	47	GraphicsConsole	79
GmchMbi	CD	Terminal	7A
IchInit	48	VgaClass	5E
IdeController	49	SaveMemoryConfig	5B
SataController	4A	AcpiSupport	5C
IchSmbusLight	4B	AcpiPlatform	53
SmmControl	C1	DataHub	5F
Ich7MSmmDispatcher	C8	DataHubStdErr	7B
IsaAcpiDriver	4C	GenericMemoryTest	61
Fwh	52	Disklo	60
SmmFwh	CE	Fat	7C
PciHotPlug	54	Partition	7D
BootOptionPolicy	51	PciPlatform	6B
SetupUtility	76	AlertStandardForma	45
Platform	55	PciSerial	A8
PlatformIde	56	AsfInit	A7
Ppm	D9	IdeRController	A9
Platform	CC	Legacy8259	63
Ihisi	D0	LegacyRegion	64
SetupMouse	f9	LegacyInterrupt	65
Int15Microcode	D1	BiosKeyboard	66
SmmPnp	D2	BiosVideo	67
Smbios	57	MonitorKey	68
MemorySubClass	58	LegacyBios	69
MiscSubclassDriver	59	LegacyBiosPlatform	6A
SysPassword	AB	LegacyMouse	77
PswdConsole	AC	SmmUsbLegacy	78
HddPswdServiceBody	D7	AmtbxInvoke	AA
HddPswdService	A6	OemBadgingSupport	83

Post Key

Key	Function
F2	Enter into Setup Menu
F12	Enter into Boot Manager

Messages Displayed during POST

Before pressing a function key
CPUID: XXXXXX
Press F2 go to Setup Utility
Press F12 go to Boot Manager
Press [PXE HOT KEY] go to PXE Setup Menu

After pressing a function key
If user pressed F2
CPUID: XXXXXX
F2 is pressed. Go to Setup Utility.
If user pressed F12
CPUID: XXXXXX
F12 is pressed. Go to Boot Manager.
If user didn't press any key
CPUID: XXXXXX
Prepare Boot to OS
If user pressed PXE HOT KEY
CPUID: XXXXXX
[PXE HOT KEY] is pressed. Go to PXE Setup Menu.

Jumper and Connector Locations

Top View

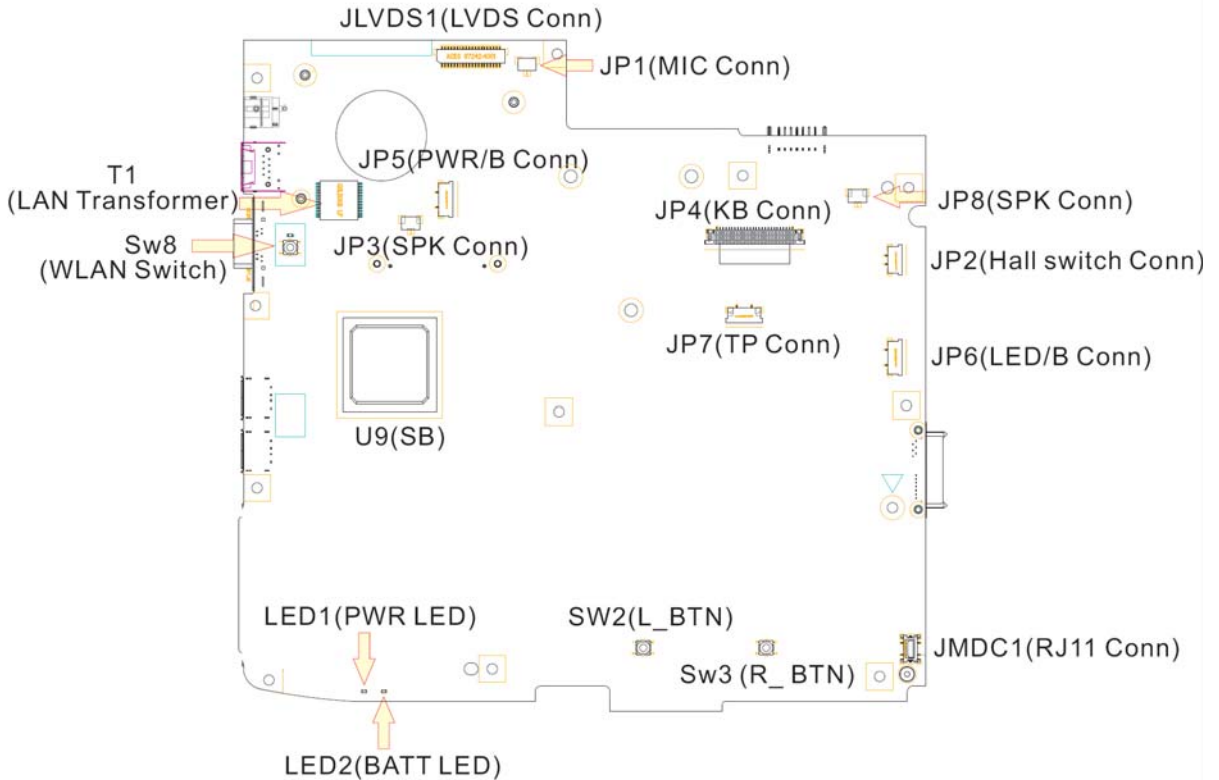

Item	Description	Item	Description
JLVDSD1	LVDS Connector	JP8	Speaker Connector
JMDC1	RJ-11 Connector	LED1	Power LED
JP1	Microphone Connector	LED2	Battery LED
JP2	Hall Switch Connector	SW2	Left TouchPad Button
JP3	Speaker Connector	SW3	Right TouchPad Button
JP4	Keyboard Connector	SW8	WLAN Switch
JP5	Power Board Connector	T1	LAN Transformer
JP6	LED Board Connector	U9	Southbridge
JP7	TouchPad Connector	U9	Southbridge

Bottom View

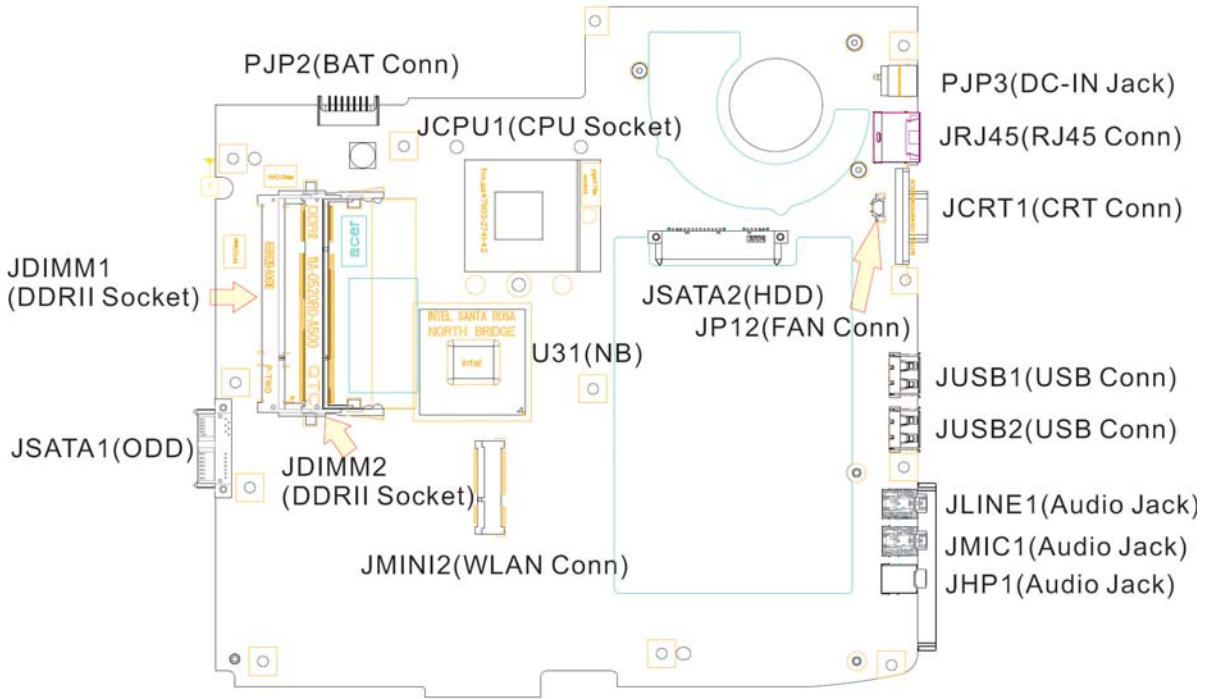

Item	Description	Item	Description
JCPU1	CPU Socket	JRJ45	RJ-45 Port
JCRT1	CRT Port	JSATA1	ODD Connector
JDIMM1	DDRII Socket	JSATA2	HDD Connector
JDIMM2	DDRII Socket	JUSB1	USB1 Port
JHP1	Headphone Jack	JUSB2	USB2 Port
JLINE1	LINE-IN Jack	PJP2	Battery Connector
JMIC1	Microphone Jack	PJP3	DC-IN Jack
JMINI2	WLAN Connector	U31	Northbridge
JP12	CPU Fan Connector		

Clearing Password Check and BIOS Recovery

This section provide you the standard operating procedures of clearing password and BIOS recovery for eMachines E720/E520. The eMachines E720/E520 Series provides one Hardware Open Gap on main board for clearing password check, and one Hotkey for enabling BIOS Recovery.

Clearing Password Check

Hardware Open Gap Description

Item	Description	Location
R347	Clear CMOS Jumper	DIMM bay

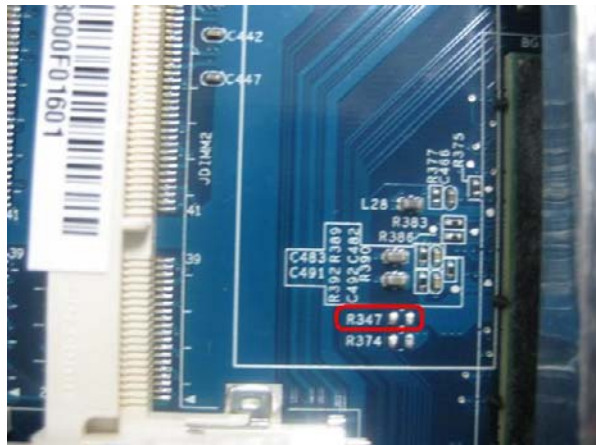

Steps for Clearing BIOS Password Check

If users set BIOS Password (Supervisor Password and/or User Password) for a security reason, BIOS will ask the password during systems POST or when systems enter to BIOS Setup menu. However, once it is necessary to bypass the password check, users need to short the HW Gap to clear the password by the following steps:

- Power Off a system, and remove HDD, AC and Battery from the machine.
- Open the back cover of the machine, and find out the HW Gap on M/B as picture.
- Use an electric conductivity tool to short the two points of the HW Gap.
- Plug in AC, keep the short condition on the HW Gap, and press Power Button to power on the system till BIOS POST finish. Then remove the tool from the HW Gap.
- Restart system. Press F2 key to enter BIOS Setup menu.
- If there is no Password request, BIOS Password is cleared. Otherwise, please follow the steps and try again.

NOTE: The steps are only for clearing BIOS Password (Supervisor Password and User Password).

BIOS Recovery by Crisis Disk

BIOS Recovery Boot Block:

BIOS Recovery Boot Block is a special block of BIOS. It is used to boot up the system with minimum BIOS initialization. Users can enable this feature to restore the BIOS firmware to a successful one once the previous BIOS flashing process failed.

BIOS Recovery Hotkey:

The system provides a function hotkey: **Fn+Esc**, for enable BIOS Recovery process when system is powered on during BIOS POST. To use this function, it is strongly recommended to have the AC adapter and Battery present. If this function is enabled, the system will force the BIOS to enter a special BIOS block, called Boot Block.

Steps for BIOS Recovery by Crisis Disk:

Before doing this, one Crisis Diskette should be prepared ready in hand. The Crisis Diskette could be made by executing the Crisis Disk program in another system with Windows XP OS.

Follow the steps below:

1. Power Off failed system.
2. Attach a USB floppy drive to the failed system.
3. Copy **jalb028.wph** to tool's folder and rename it as **BIOS.wph**.
4. Execute **wincris.exe** to start the Crisis Disk Build.
5. Select **Removable** and click **Start**.

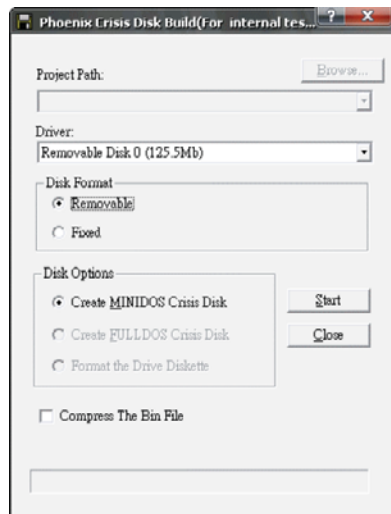

6. Select **Format Disk** and click **Start**.

A progress screen displays.

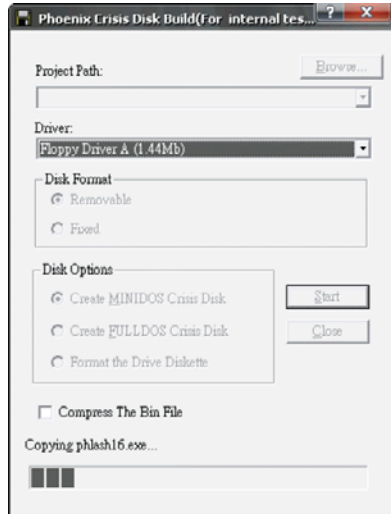

7. The following message displays when the Crisis Diskette is created successfully.



- 8. Click **OK** to complete the process.
- 9. Insert the Crisis Disk in to the USB floppy drive attached to the BIOS flash failed system.
- 10. In the power-off state, press and hold **Fn+Esc** then press the Power button.

The system powers on and the Crisis BIOS Recovery process begins.

BIOS Boot Block begins restoring the BIOS code from the Crisis floppy disk to BIOS ROM on the failed system.

When the Crisis flash process is finished, the system restarts with a workable BIOS.

Update to the latest version BIOS for the system using the regular BIOS flashing process.

Steps for BIOS Recovery by USB Disk:

Before doing this, one Crisis USB Disk should be prepared ready in hand. The Crisis Diskette could be made by executing the Crisis Disk program in another system with Windows XP OS.

1. Plug in USB Flash Disk.
2. Run the selected formatting program.

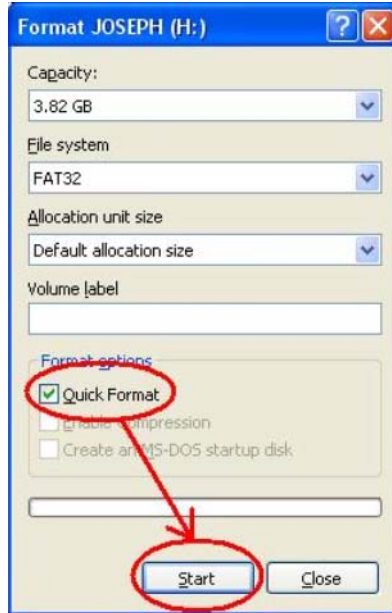

3. Select **Quick Format** and click **Start**.
4. Select **Format Final** button then exit.
5. Copy **JAT10X64.fd** to USB flash disk root directory.

IMPORTANT: Do not place any other *.fd files in the USB flash disk root directory.

6. In the power-off state, press and hold **Fn+Esc** then press the Power button.

The system powers on and the Crisis BIOS Recovery process begins.

BIOS Boot Block begins restoring the BIOS code from the Crisis USB disk to BIOS ROM on the failed system.

When the Crisis flash process is finished, the system restarts with a workable BIOS.

Update to the latest version BIOS for the system using the regular BIOS flashing process.

FRU (Field Replaceable Unit) List

This chapter gives you the FRU (Field Replaceable Unit) listing in global configurations of eMachines E720/E520 Series. Refer to this chapter whenever ordering for parts to repair or for RMA (Return Merchandise Authorization).

Please note that WHEN ORDERING FRU PARTS, you should check the most up-to-date information available on your regional web or channel. For whatever reasons a part number change is made, it will not be noted on the printed Service Guide. For ACER AUTHORIZED SERVICE PROVIDERS, your Acer office may have a DIFFERENT part number code from those given in the FRU list of this printed Service Guide. You MUST use the local FRU list provided by your regional Acer office to order FRU parts for repair and service of customer machines.

NOTE: To scrap or to return the defective parts, you should follow the local government ordinance or regulations on how to dispose it properly, or follow the rules set by your regional Acer office on how to return it.



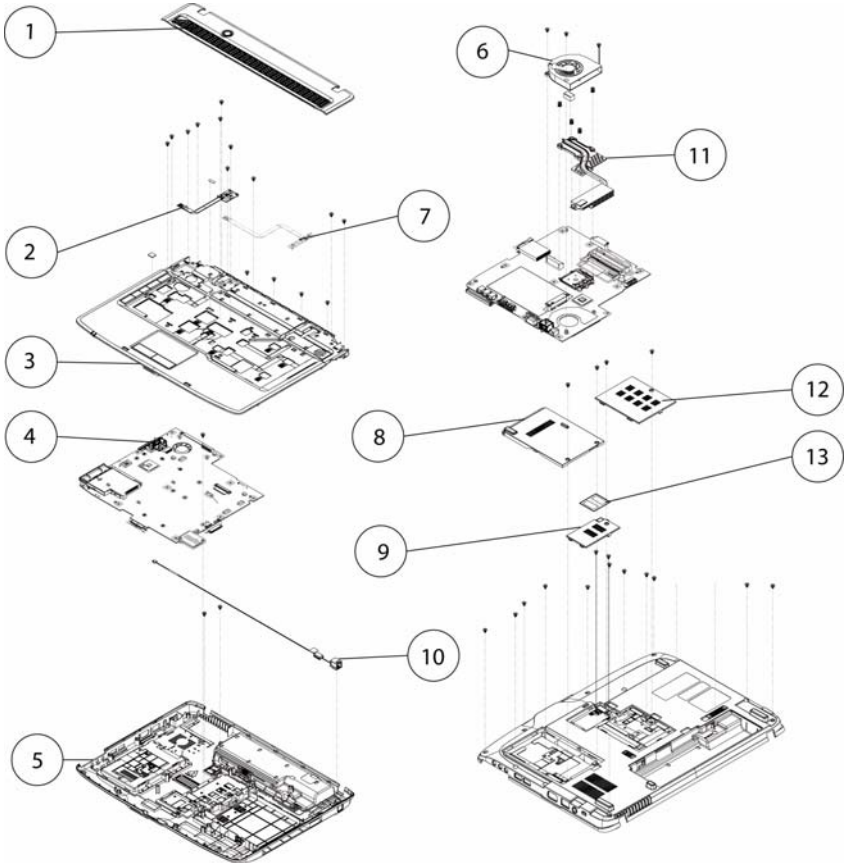

eMachines E720/E520 Exploded Diagram



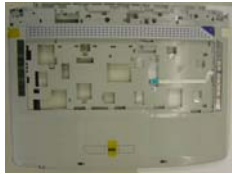

Item	Description	Part Number
1	Middle Cover	60.N0502.001
2	Power Board	55.N0502.003
3	Upper Case	60.N0502.002
4	Mainboard	MB.N0502.001
5	Lower Case	60.N0502.003
6	CPU Fan	23.N0502.001
7	Function Board	55.N0502.002
8	HDD Cover	42.N0502.003
9	Minicard Cover	42.N0502.001
10	Modem Cable	50.N0502.001
11	Thermal Module	60.N0502.007
12	Memory Cover	42.N0502.002
13	WLAN Module	NI.23600.007

eMachines E720/E520 FRU List

CATEGORY	Description	Acer PN
Adapter		
	ADAPTER 65W 3PIN DELTA SADP-65KB DFA	AP.06501.013
	ADAPTER 65W 3PIN DELTA SADP65KB BFJA OBL	AP.06501.014
	ADAPTER 65W 3PIN LITE ON PA-1650-02AC	AP.06503.016
	ADAPTER 65W 3PIN HIPRO AC-OK065B13 LF	AP.0650A.010
Battery		
	BATTERY LI-ION 6CELL 4.4KAH SANYO SA SA 3S2P	BT.00603.042
	BATTERY LI-ION 6CELL 4.4KAH SONY SY SY 3S2P	BT.00604.025
	BATTERY LI-ION 6CELL 4.4KAH SIMPLO SP PA 3S2P	BT.00607.016
	BATTERY LI-ION 6CELL 4.4KAH PANASONIC PA PA 3S2P	BT.00605.021
	BATTERY LI-ION 8CELL 4.8KAH SANYO SA SA 4S2P	BT.00803.024
	BATTERY LI-ION 8CELL 4.8KAH PANASONIC PA PA 4S2P	BT.00805.011
	BATTERY LI-ION 8CELL 4.8KAH PANASONIC PA PA 4S2P	TBD
	BATTERY LI-ION 8CELL 4.8KAH SONY SY SY 4S2P	BT.00804.020
Board		
	MODEM BOARD	TBD
	MODEM BOARD-AUS	TBD
	SWITCH BOARD	55.N0502.001
	FUNCTION BOARD	55.N0502.002
	POWER BOARD W/ LED	55.N0502.003
	POWER BOARD W/O LED	55.N0502.004
	WLAN Atheros XB63 MINI CARD B/G	NI.23600.007
	WLAN BROADCOM 4312	TBD
	WLAN CARD AR5B91 Atheros	TBD
	WLAN CARD RT2700E RALINK	TBD
Cable		
	RJ11 CABLE	50.N0502.001
	T/P FFC	50.N0502.002

CATEGORY	Description	Acer PN
	POWER CORD US 3 PIN	27.TAVV5.001
	POWER CORD EU 3 PIN	27.TAVV5.002
	POWER CORD AUS 3 PIN	27.TAVV5.003
	POWER CORD UK 3 PIN	27.TAVV5.004
	POWER CORD CHINA 3 PIN	27.TAVV5.005
	POWER CORD SWISS 3 PIN	27.TAVV5.006
	POWER CORD ITALIAN 3 PIN	27.TAVV5.007
	POWER CORD DENMARK 3 PIN	27.TAVV5.008
	POWER CORD JP 3 PIN	27.TAVV5.009
	POWER CORD SOUTH AFRICA 3 PIN	27.TAVV5.010
	POWER CORD KOERA 3 PIN	27.TAVV5.011
	POWER CORD ISRAEL 3 PIN	27.TAVV5.012
	POWER CORD INDIA 3 PIN	27.TAVV5.013
	POWER CORD TWN 3 PIN	27.TAVV5.014
	POWER CORD ARGENTINA 3 PIN	27.APV02.001
Case/Cover/Bracket Assembly		
	MIDDLE COVER	60.N0502.001
	UPPER CASE ASSY	60.N0502.002
	LOWER CASE ASSY FOR W/RJ11	60.N0502.003
	LOWER CASE ASSY FOR W/O RJ11	60.N0502.004
	MINI DOOR	42.N0502.001
	RAM DOOR	42.N0502.002
	HDD DOOR	42.N0502.003





CATEGORY	Description	Acer PN
	T/P BRACKET	33.N0502.001
CPU Processor		
	CPU INTEL MEROM PMDT3400 2.16G LF80537GF0481M QGFM M0	KC.34001.DTP
	CPU INTEL MEROM PMDT3200 2.0G LF80537GF0411M QBNT M0	KC.32001.DTP
	CPU INTEL MEROM CMT1700 1.83G LF80537NF0341MN QGGM M0	KC.17001.CMT
	CPU INTEL MEROM CMT1600 1.66G LF80537NF0281MN QGGR M0	KC.16001.CMT
	CPU INTEL MEROM CM585 2.16G LF80537NF0481M QGHD M0	KC.N0001.585
	CPU INTEL MEROM CM575 2.0G LF80537GF0411M QHEL M0	KC.N0001.575
Combo Drive		
	DVD/CDRW COMBO DRIVE MODULE	6M.N0502.001
	DVD/CDRW COMBO DRIVE TOSHIBA TS-L463A 0FA	KO.02401.006
	DVD/CDRW COMBO DRIVE SONY CRX890S 0FA	KO.0240E.009
	ODD BEZEL-COMBO	42.N0502.004
	ODD BRACKET	33.N0502.002
Super Multi Drive		
	DVD SUPER MULTI DRIVE MODULE	6M.N0502.002
	DVD SUPER MULTI DRIVE PIONEER DVR-TD08RS 0FA FW: 1.05	KU.00805.044
	DVD SUPER MULTI DRIVE PIONEER DVR-TD08RS LF W/O bezel	TBD
	DVD SUPER MULTI DRIVE HLDS GT10N 0FA	KU.0080D.039
	DVD SUPER MULTI DRIVE PLDS DS-8A2S 0FA	KU.0080F.001
	DVD SUPER MULTI DRIVE SONY AD-7580S 0FA	KU.0080E.017
	ODD BEZEL-SUPER MULTI	42.N0502.005
	ODD BRACKET	33.N0502.002

CATEGORY	Description	Acer PN
HDD		
	HDD SATA 120G 5400RPM HGST HTS543212L9A300 0FA	KH.12007.016
	HDD SATA 120G 5400RPM SEAGATE ST9120817AS 0FA	KH.12001.032
	HDD SATA 120G 5400RPM WD WD1200BEVS-22UST0 0FA	KH.12008.019
	HDD SATA 120G 5400RPM WD WD1200BEVT-22ZCT0	TBD
	HDD SATA 160G 5400RPM HGST HTS543216L9A300 Falcon-B	KH.16007.019
	HDD SATA 160G 5400RPM SEAGATE ST9160310AS Crockett	KH.16001.034
	HDD SATA 160G 5400RPM WD WD1600BEVS-22ZCT0	KH.16008.022
	HDD SATA 250G 5400RPM HGST HTS543225L9A300 0FA	KH.25007.013
	HDD SATA 250G 5400RPM SEAGATE ST9250827AS 0FA	KH.25001.011
	HDD SATA 250G 5400RPM WD WD2500BEVT-22ZCT0 0FA	KH.25008.021
	HDD SATA 320G 5400RPM WD WD3200BEVT-22ZCT0 0FA	KH.32008.013
	HDD SATA 320G 5400RPM HGST HTS543232L9A300 Falcon-B	KH.32007.004
	HDD SATA 320G 5400RPM SEAGATE ST9320320AS Crockett	KH.32001.008
	HDD CARRIER	33.N0502.003

CATEGORY	Description	Acer PN
Keyboard		
	KEYBOARD INTE(UI) US INTERNATIONAL	KB.I1400.043
	KEYBOARD (ARE) ARABIC ENGLISH	KB.I1400.075
	KEYBOARD (BE) BELGIAN	KB.I1400.074
	KEYBOARD (BZ) BRAZILIAN	KB.I1400.073
	KEYBOARD (CF) CANADIAN FRENCH	KB.I1400.072
	KEYBOARD (CH) T-CHINESE	KB.I1400.071
	KEYBOARD (DM) DENMARK	KB.I1400.069
	KEYBOARD (NL) NETHERLANDS	KB.I1400.068
	KEYBOARD (FR) FRENCH	KB.I1400.066
	KEYBOARD (GR) GERMAN	KB.I1400.065
	KEYBOARD (GK) GREEK	KB.I1400.064
	KEYBOARD (HG) HUNGARY	KB.I1400.063
	KEYBOARD (IT) ITALIAN	KB.I1400.060
	KEYBOARD (KO) KOREAN	KB.I1400.058
	KEYBOARD (NW) NORWEGIAN	KB.I1400.056
	KEYBOARD (PO) PORTUGUESE	KB.I1400.054
	KEYBOARD (RU) RUSSIAN	KB.I1400.053
	KEYBOARD (SA/CR) SLOVENIAN	KB.I1400.052
	KEYBOARD (SV) SLOVAK	KB.I1400.051
	KEYBOARD (SP) SPANISH	KB.I1400.050
	KEYBOARD (CZ/SK) CZECH-SLOVAKIAN	KB.I1400.080
	KEYBOARD (SW) SWITZERLAND	KB.I1400.048
	KEYBOARD (TI) THAILAND	KB.I1400.047
	KEYBOARD (TR) TURKISH	KB.I1400.046
	KEYBOARD UK	KB.I1400.045
KEYBOARD (HB) HEBREW	KB.I1400.044	
KEYBOARD (ND) SCANDINAVIAN	KB.I1400.077	
KEYBOARD (AR/FR) ARABIC/FRENCH	KB.I1400.076	
KEYBOARD (CB) CANADIAN BILINGUAL	KB.I1400.078	
KEYBOARD (SD) SWEDISH	KB.I1400.049	
LCD		
	ASSY LCD MODULE 15.4 IN. WXGA GLARE FOR CCD 0.3M W/ ANTENNA	6M.N0702.001
	LCD PANEL G 15.4 WXGAG AUO B154EW08 V1 3A	LK.15405.029
	LCD PANEL G 15.4 WXGAG AUO B154EW08-V1 3A (S01) w/o bracket, HW 3A LF	TBD
	LCD PANEL G 15.4 WXGAG CMO N154I3-L03	LK.1540D.022
	LCD PANEL G 15.4 WXGAG LG LP154WX4-TLB4	LK.15408.029
	LCD PANEL G 15.4 WXGAG SAMSUNG LTN154AT01-A01	TBD
	LCD PANEL G 15.4 WXGAG SAMSUNG LTN154AT01-A04	TBD
	LCD PANEL G 15.4 WXGAG SAMSUNG LTN154AT01-A02	TBD
	INVERTER BOARD	19.N0502.001
	LCD CABLE FOR W/CCD	50.N0702.001

CATEGORY	Description	Acer PN
	LCD COVER	60.N0502.005
	LCD BEZEL FOR W/CCD	60.N0702.001
	LCD BRACKET-R	33.N0502.004
	LCD BRACKET-L	33.N0502.005
	WIRELESS ANTENNA R	50.N0502.003
	WIRELESS ANTENNA L	50.N0502.004
	CAMERA MODULE 0.3M	57.N0702.001
	CAMERA BRACKET	33.N0702.001
	ASSY LCD MODULE 15.4 IN. WXGA GLARE W/ANTENNA	6M.N0502.003
	LCD PANEL G 15.4 WXGAG AUO B154EW08 V1 3A	LK.15405.029
	LCD PANEL G 15.4 WXGAG AUO B154EW08-V1 3A (S01) w/o bracket, HW 3A LF	TBD
	LCD PANEL G 15.4 WXGAG CMO N154I3-L03	LK.1540D.022
	LCD PANEL G 15.4 WXGAG LG LP154WX4-TLB4	LK.15408.029
	LCD PANEL G 15.4 WXGAG SAMSUNG LTN154AT01-A01	TBD
	LCD PANEL G 15.4 WXGAG SAMSUNG LTN154AT01-A04	TBD
	INVERTER BOARD	19.N0502.001

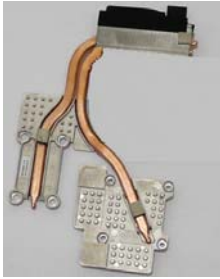
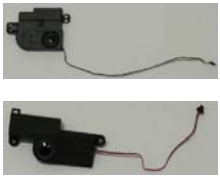
CATEGORY	Description	Acer PN
	LCD CABLE FOR W/O CCD	50.N0502.005
	LCD COVER	60.N0502.005
	LCD BEZEL FOR W/O CCD	60.N0502.006
	LCD BRACKET-R	33.N0502.004
	LCD BRACKET-L	33.N0502.005
	WIRELESS ANTENNA R	50.N0502.003
	WIRELESS ANTENNA L	50.N0502.004
Mainboard		
	MAINBOARD E520/E720 INTEL GL40 ICH9 8111C ACER LOGO W/O 1394 V1.0 LF	MB.N0502.001

CATEGORY	Description	Acer PN
Memory		
	RAM 512MB DDRII 667 NANYA NT512T64UH8B0FN-3C 512/66	KN.51203.032
	RAM 512MB DDRII 667 SAMSUNG M470T6464QZ3-CE6 512M/667	KN.5120B.026
	RAM 512MB DDRII 667 HYNIX HYMP164S64CP6-Y5 512/667	KN.5120G.024
	RAM 1G DDRII 667 SAMSUNG M470T2864QZ3-CE6 1G/667	KN.1GB0B.016
	RAM 1G DDRII 667 HYNIX HYMP112S64CP6-Y5 1G/667	KN.1GB0G.012
	RAM 1G DDRII 667 MICRON MT8HTF12864HDY-667E1 1G/66	KN.1GB04.001
	RAM 1G DDRII 667 ELPIDA EBE11UE6ACUA-6E-E 1GB/667	KN.1GB09.008
	RAM 2G DDRII 667 HYNIX HYMP125S64CP8-Y5 2GB/667	KN.2GB0G.004
	RAM 2G DDRII 667 MICRON MT16HTF25664HY-667E1 2G/66	KN.2GB04.001
	RAM 2G DDRII 667 SAMSUNG M470T5663QZ3-CE6 2G/667	KN.2GB0B.003
	RAM 2G DDRII 667 ELPIDA EBE21UE8ACUA-6E-E 2G/667	KN.2GB09.001
Fan		
	FAN	23.N0502.001
Heatsink		
	CPU THERMAL MODULE	60.N0502.007
Speaker		
	SPEAKER R&L	23.N0502.002
	MIC SET	23.N0502.003
Miscellaneous		
	THERMAL PAD-S	47.N0502.001
	THERMAL PAD-R	47.N0502.002
	NAME PLATE-E520	47.N0502.003
	NAME PLATE-E720	47.N0602.001

Screw List

Category	Description	Part Number
SCREW	M2.5X4 (NL)	86.ATA02.001
SCREW	M2.5X6 (NL)	86.ATA02.002
SCREW	M2.5X8 (NL)	86.ATA02.003
SCREW	M2X5 (NL)	86.ATA02.004
SCREW	M2X3 (NL)	86.ATA02.005
SCREW	M3X3 (NI)	86.ATA02.006
SCREW	CPU THERMAL SCREW	86.ATA02.007

Model Definition and Configuration

eMachines E720/E520 Series

Model	RO	Country	Acer Part No	Description	CPU
eME520-571G12Mi	PA	Canada	LX.N050C.004	eME520-571G12Mi LINPUSeCA1 UMA 1*1G/120/6L/CB_bg_AN_EN31	CM575
eME520-571G12Mi	PA	USA	LX.N050C.003	eME520-571G12Mi LINPUSeUS1 UMA 1*1G/120/6L/CB_bg_AN_EN31	CM575
eME520-571G12Mi	PA	ACLA-Portuguese	LX.N050C.002	eME520-571G12Mi LINPUSeXC1 UMA 1*1G/120/6L/CB_bg_AN_EN61	CM575
eME520-571G12Mi	PA	ACLA-Spanish	LX.N050C.001	eME520-571G12Mi LINPUSeEA3 UMA 1*1G/120/6L/CB_bg_AN_EN61	CM575
eME520-571G12Mi	PA	Canada	LX.N050Y.006	eME520-571G12Mi VHB32eTCA2 UMA 1*1G/120/6L/CB_bg_AN_FR31	CM575
eME520-571G12Mi	PA	USA	LX.N050Y.005	eME520-571G12Mi VHB32eTUS1 UMA 1*1G/120/6L/CB_bg_AN_EN31	CM575
eME520-571G12Mi	PA	ACLA-Portuguese	LX.N050Y.004	eME520-571G12Mi EM VHB32eTXC1 UMA 1*1G/120/6L/CB_bg_AN_XC21	CM575
eME520-571G12Mi	PA	ACLA-Portuguese	LX.N050Y.003	eME520-571G12Mi EM VHB32eTXC2 UMA 1*1G/120/6L/CB_bg_AN_XC21	CM575
eME520-571G12Mi	PA	ACLA-Spanish	LX.N050Y.002	eME520-571G12Mi EM VHB32eTEA3 UMA 1*1G/120/6L/CB_bg_AN_ES21	CM575
eME520-571G12Mi	PA	ACLA-Spanish	LX.N050Y.001	eME520-571G12Mi EM VHB32eTEA1 UMA 1*1G/120/6L/CB_bg_AN_ES21	CM575
eME520-573G16i	AAP	Australia/ New Zealand	LX.N050C.005	eME520-573G16i LINPUSeAU1 UMA 2G+1G/160/6L/CB_bg_AN_EN11	CM575
eME520-571G12Mi	AAP	Japan	LX.N050X.003	eME520-571G12Mi VHP32eJP1 UMA 1*1G/120/6L/CB_bg_AN_JA14_57	CM575
eME520-571G16Mi	EMEA	UK	LX.N050Y.008	eME520-571G16Mi VHB32eTGB1 UMA 1*1G/160/6L/CB_bg_AN_EN11	CM575
eME520-572G12Mi	AAP	Japan	LX.N050X.002	eME520-572G12Mi VHP32eJP1 UMA 1*2G/120/6L/CB_bg_AN_JA14_257	CM575
eME520-572G16Mi	AAP	Japan	LX.N050X.001	eME520-572G16Mi VHP32eJP1 UMA 1*2G/160/6L/CB_bg_AN_JA14_2657	CM575
eME520-571G12Mi	AAP	Australia/ New Zealand	LX.N050Y.007	eME520-571G12Mi VHB32eTAU1 UMA 1*1G/120/6L/CB_bg_AN_EN11	CM575
eME720-321G12Mi	PA	Canada	LX.N080C.004	eME720-321G12Mi LINPUSeCA1 UMAC 1*1G/120/6L/CB_bg_0.3D_AN_EN31	PMDT3200
eME720-321G12Mi	PA	USA	LX.N080C.003	eME720-321G12Mi LINPUSeUS1 UMAC 1*1G/120/6L/CB_bg_0.3D_AN_EN31	PMDT3200
eME720-321G12Mi	PA	ACLA-Portuguese	LX.N080C.002	eME720-321G12Mi LINPUSeXC1 UMAC 1*1G/120/6L/CB_bg_0.3D_AN_EN61	PMDT3200
eME720-321G12Mi	PA	ACLA-Spanish	LX.N080C.001	eME720-321G12Mi LINPUSeEA3 UMAC 1*1G/120/6L/CB_bg_0.3D_AN_EN61	PMDT3200
eME720-323G25Ci	AAP	Philippines	LX.N080C.005	eME720-323G25Ci LINPUSePH1 UMAC 2G+1G/250/6L/CB_bg_0.3D_AN_EN11	PMDT3200
eME720-321G12Mi	PA	Canada	LX.N080Y.004	eME720-321G12Mi VHB32eTCA2 UMAC 1*1G/120/6L/CB_bg_0.3D_AN_FR31	PMDT3200

Model	RO	Country	Acer Part No	Description	CPU
eME720-321G12Mi	PA	USA	LX.N080Y.005	eME720-321G12Mi VHB32eTUS1 UMAC 1*1G/120/6L/ CB_bg_0.3D_AN_EN31	PMDT3200
eME720-321G12Mi	PA	ACLA-Portuguese	LX.N080Y.006	eME720-321G12Mi EM VHB32eTXC1 UMAC 1*1G/120/6L/ CB_bg_0.3D_AN_XC21	PMDT3200
eME720-321G12Mi	PA	ACLA-Portuguese	LX.N080Y.003	eME720-321G12Mi EM VHB32eTXC2 UMAC 1*1G/120/6L/ CB_bg_0.3D_AN_XC21	PMDT3200
eME720-321G12Mi	PA	ACLA-Spanish	LX.N080Y.002	eME720-321G12Mi EM VHB32eTEA3 UMAC 1*1G/120/6L/ CB_bg_0.3D_AN_ES21	PMDT3200
eME720-321G12Mi	PA	ACLA-Spanish	LX.N080Y.001	eME720-321G12Mi EM VHB32eTEA1 UMAC 1*1G/120/6L/ CB_bg_0.3D_AN_ES21	PMDT3200
eME720-321G12Mi	AAP	Vietnam	LX.N080C.006	eME720-321G12Mi LIMPUSeVN1 UMAC 1*1G/120/6L/ CB_bg_0.3D_AN_EN11	PMDT3200
eME720-323G32Mi	AAP	Vietnam	LX.N060C.001	eME720-323G32Mi LIMPUSeVN1 UMA 2G+1G/320/6L/CB_bg_AN_EN11	PMDT3200
eME720-321G12Ci	AAP	Vietnam	LX.N060C.002	eME720-321G12Ci LIMPUSeVN1 UMA 1*1G/120/6L/CB_bg_AN_EN11	PMDT3200
eME520-162G12Mi	EMEA	Luxembourg	LX.N070X.073	eME520-162G12Mi VHP32eTLU1 UMAC 1*2G/120/6L/ CB_bg_0.3D_AN_IT41	CMT1600
eME520-162G12Mi	EMEA	Russia	LX.N070X.072	eME520-162G12Mi VHP32eTRU1 UMAC 1*2G/120/6L/ CB_bg_0.3D_AN_RU11	CMT1600
eME520-162G12Mi	EMEA	Denmark	LX.N070X.074	eME520-162G12Mi VHP32eTDK1 UMAC 1*2G/120/6L/ CB_bg_0.3D_AN_NO11	CMT1600
eME520-162G12Mi	EMEA	France	LX.N070X.071	eME520-162G12Mi VHP32eTFR1 UMAC 1*2G/120/6L/ CB_bg_0.3D_AN_FR21	CMT1600
eME520-162G12Mi	EMEA	Norway	LX.N070X.070	eME520-162G12Mi VHP32eTNO1 UMAC 1*2G/120/6L/ CB_bg_0.3D_AN_NO11	CMT1600
eME520-162G12Mi	EMEA	Germany	LX.N070X.069	eME520-162G12Mi VHP32eTDE1 UMAC 1*2G/120/6L/ CB_bg_0.3D_AN_DE11	CMT1600
eME520-162G12Mi	EMEA	Belgium	LX.N070X.065	eME520-162G12Mi VHP32eTBE1 UMAC 1*2G/120/6L/ CB_bg_0.3D_AN_NL11	CMT1600
eME520-162G12Mi	EMEA	South Africa	LX.N070X.064	eME520-162G12Mi EM VHP32eTZA2 UMAC 1*2G/120/6L/ CB_bg_0.3D_AN_EN11	CMT1600
eME520-162G12Mi	EMEA	Holland	LX.N070X.066	eME520-162G12Mi VHP32eTNL1 UMAC 1*2G/120/6L/ CB_bg_0.3D_AN_NL11	CMT1600
eME520-162G12Mi	EMEA	South Africa	LX.N070X.063	eME520-162G12Mi EM VHP32eTZA1 UMAC 1*2G/120/6L/ CB_bg_0.3D_AN_FR21	CMT1600
eME520-162G12Mi	EMEA	Sweden/ Finland	LX.N070X.067	eME520-162G12Mi VHP32eTSE1 UMAC 1*2G/120/6L/ CB_bg_0.3D_AN_FI11	CMT1600
eME520-582G16M	WW	WW	S2.N070X.001	eME520-582G16MVHP32eWW1 UMAC 2*1G/160/6L/CB_0.3D_AN_EN12	CM585

Model	RO	Country	Acer Part No	Description	CPU
eME520-161G12Mi	AAP	Indonesia	LX.N070C.003	eME520-161G12Mi LINPUSeID1 UMAC 1*1G/120/6L/CB_bg_0.3D_AN_ID21	CMT1600
eME520-572G12Mi	EMEA	South Africa	LX.N070Y.035	eME520-572G12Mi EM VHB32eTZA1 UMAC 1*2G/120/6L/CB_bg_0.3D_AN_FR21	CM575
eME520-572G12Mi	EMEA	South Africa	LX.N070Y.034	eME520-572G12Mi EM VHB32eTZA2 UMAC 1*2G/120/6L/CB_bg_0.3D_AN_EN11	CM575
eME520-572G12Mi	EMEA	Denmark	LX.N070Y.033	eME520-572G12Mi VHB32eTDK1 UMAC 1*2G/120/6L/CB_bg_0.3D_AN_NO11	CM575
eME520-572G12Mi	EMEA	France	LX.N070Y.032	eME520-572G12Mi VHB32eTFR1 UMAC 1*2G/120/6L/CB_bg_0.3D_AN_FR21	CM575
eME520-572G12Mi	EMEA	Germany	LX.N070Y.031	eME520-572G12Mi VHB32eTDE1 UMAC 1*2G/120/6L/CB_bg_0.3D_AN_DE11	CM575
eME520-572G12Mi	EMEA	Belgium	LX.N070Y.030	eME520-572G12Mi VHB32eTBE1 UMAC 1*2G/120/6L/CB_bg_0.3D_AN_NL11	CM575
eME520-572G12Mi	EMEA	Holland	LX.N070Y.029	eME520-572G12Mi VHB32eTNL1 UMAC 1*2G/120/6L/CB_bg_0.3D_AN_NL11	CM575
eME520-572G12Mi	EMEA	Luxembourg	LX.N070Y.028	eME520-572G12Mi VHB32eTLU1 UMAC 1*2G/120/6L/CB_bg_0.3D_AN_IT41	CM575
eME520-572G12Mi	EMEA	Norway	LX.N070Y.027	eME520-572G12Mi VHB32eTNO1 UMAC 1*2G/120/6L/CB_bg_0.3D_AN_NO11	CM575
eME520-572G12Mi	EMEA	Russia	LX.N070Y.026	eME520-572G12Mi VHB32eTRU1 UMAC 1*2G/120/6L/CB_bg_0.3D_AN_RU11	CM575
eME520-572G12Mi	EMEA	Sweden/ Finland	LX.N070Y.025	eME520-572G12Mi VHB32eTSE1 UMAC 1*2G/120/6L/CB_bg_0.3D_AN_FI11	CM575
eME520-572G12Mi	EMEA	Czech	LX.N070Y.024	eME520-572G12Mi VHB32eTCZ2 UMAC 1*2G/120/6L/CB_bg_0.3D_AN_SK11	CM575
eME520-572G12Mi	EMEA	Eastern Europe	LX.N070Y.023	eME520-572G12Mi VHB32eTEU4 UMAC 1*2G/120/6L/CB_bg_0.3D_AN_FI11	CM575
eME520-572G12Mi	EMEA	Eastern Europe	LX.N070Y.022	eME520-572G12Mi VHB32eTEU3 UMAC 1*2G/120/6L/CB_bg_0.3D_AN_RU11	CM575
eME520-572G12Mi	EMEA	Eastern Europe	LX.N070Y.021	eME520-572G12Mi VHB32eTEU7 UMAC 1*2G/120/6L/CB_bg_0.3D_AN_ENG1	CM575
eME520-572G12Mi	EMEA	Eastern Europe	LX.N070Y.020	eME520-572G12Mi VHB32eTEU1 UMAC 1*2G/120/6L/CB_bg_0.3D_AN_CS21	CM575
eME520-572G12Mi	EMEA	Eastern Europe	LX.N070Y.019	eME520-572G12Mi VHB32eTEU2 UMAC 1*2G/120/6L/CB_bg_0.3D_AN_HU21	CM575
eME520-572G12Mi	EMEA	Eastern Europe	LX.N070Y.018	eME520-572G12Mi VHB32eTEU5 UMAC 1*2G/120/6L/CB_bg_0.3D_AN_PL11	CM575

Model	RO	Country	Acer Part No	Description	CPU
eME520-572G12Mi	EMEA	Eastern Europe	LX.N070Y.017	eME520-572G12Mi VHB32eTEU6 UMAC 1*2G/120/6L/ CB_bg_0.3D_AN_CS21	CM575
eME520-572G12Mi	EMEA	Hungary	LX.N070Y.016	eME520-572G12Mi VHB32eTHU1 UMAC 1*2G/120/6L/ CB_bg_0.3D_AN_HU11	CM575
eME520-572G12Mi	EMEA	Slovenia/ Croatia	LX.N070Y.015	eME520-572G12Mi VHB32eTSI1 UMAC 1*2G/120/6L/CB_bg_0.3D_AN_EN11	CM575
eME520-572G12Mi	EMEA	Portugal	LX.N070Y.014	eME520-572G12Mi VHB32eTPT1 UMAC 1*2G/120/6L/ CB_bg_0.3D_AN_PT11	CM575
eME520-572G12Mi	EMEA	Spain	LX.N070Y.013	eME520-572G12Mi VHB32eTES1 UMAC 1*2G/120/6L/ CB_bg_0.3D_AN_ES21	CM575
eME520-572G12Mi	EMEA	Greece	LX.N070Y.012	eME520-572G12Mi VHB32eTGR1 UMAC 1*2G/120/6L/ CB_bg_0.3D_AN_EL21	CM575
eME520-572G12Mi	EMEA	Israel	LX.N070Y.011	eME520-572G12Mi VHB32eTIL1 UMAC 1*2G/120/6L/CB_bg_0.3D_AN_HE11	CM575
eME520-582G16Mi	WW	WW	S2.N070X.002	eME520-582G16Mi VHP32eWW1 UMAC 2*1G/160/6L/ CB_bg_0.3D_AN_EN12	CM585
eME520-572G12Mi	EMEA	Italy	LX.N070Y.010	eME520-572G12Mi VHB32eTIT1 UMAC 1*2G/120/6L/CB_bg_0.3D_AN_IT11	CM575
eME520-572G12Mi	EMEA	Turkey	LX.N070Y.009	eME520-572G12Mi EM VHB32eTTR1 UMAC 1*2G/120/6L/ CB_bg_0.3D_AN_TR41	CM575
eME520-572G12Mi	EMEA	Turkey	LX.N070Y.008	eME520-572G12Mi EM VHB32eTTR1 UMAC 1*2G/120/6L/ CB_bg_0.3D_AN_TR11	CM575
eME520-572G12Mi	EMEA	Middle East	LX.N070Y.007	eME520-572G12Mi EM VHB32eTME9 UMAC 1*2G/120/6L/ CB_bg_0.3D_AN_FR21	CM575
eME520-572G12Mi	EMEA	Middle East	LX.N070Y.006	eME520-572G12Mi EM VHB32eTME2 UMAC 1*2G/120/6L/ CB_bg_0.3D_AN_AR21	CM575
eME520-572G12Mi	EMEA	Middle East	LX.N070Y.005	eME520-572G12Mi EM VHB32eTME6 UMAC 1*2G/120/6L/ CB_bg_0.3D_AN_EN11	CM575
eME520-572G12Mi	EMEA	Middle East	LX.N070Y.004	eME520-572G12Mi EM VHB32eTME3 UMAC 1*2G/120/6L/ CB_bg_0.3D_AN_FR21	CM575
eME520-572G12Mi	EMEA	Middle East	LX.N070Y.003	eME520-572G12Mi EM VHB32eTME2 UMAC 1*2G/120/6L/ CB_bg_0.3D_AN_AR11	CM575
eME520-572G12Mi	EMEA	Switzerland	LX.N070Y.002	eME520-572G12Mi VHB32eTCH1 UMAC 1*2G/120/6L/ CB_bg_0.3D_AN_IT41	CM575
eME520-572G12Mi	EMEA	UK	LX.N070Y.001	eME520-572G12Mi VHB32eTGB1 UMAC 1*2G/120/6L/ CB_bg_0.3D_AN_EN11	CM575
eME520-162G12Mi	EMEA	South Africa	LX.N070Y.069	eME520-162G12Mi EM VHB32eTZA1 UMAC 1*2G/120/6L/ CB_bg_0.3D_AN_FR21	CMT1600
eME520-162G12Mi	EMEA	South Africa	LX.N070Y.068	eME520-162G12Mi EM VHB32eTZA2 UMAC 1*2G/120/6L/ CB_bg_0.3D_AN_EN11	CMT1600

Model	RO	Country	Acer Part No	Description	CPU
eME520-162G12Mi	EMEA	Denmark	LX.N070Y.070	eME520-162G12Mi VHB32eTDK1 UMAC 1*2G/120/6L/ CB_bg_0.3D_AN_NO11	CMT1600
eME520-162G12Mi	EMEA	France	LX.N070Y.067	eME520-162G12Mi VHB32eTFR1 UMAC 1*2G/120/6L/ CB_bg_0.3D_AN_FR21	CMT1600
eME520-162G12Mi	EMEA	Germany	LX.N070Y.066	eME520-162G12Mi VHB32eTDE1 UMAC 1*2G/120/6L/ CB_bg_0.3D_AN_DE11	CMT1600
eME520-162G12Mi	EMEA	Belgium	LX.N070Y.062	eME520-162G12Mi VHB32eTBE1 UMAC 1*2G/120/6L/ CB_bg_0.3D_AN_NL11	CMT1600
eME520-162G12Mi	EMEA	Holland	LX.N070Y.063	eME520-162G12Mi VHB32eTNL1 UMAC 1*2G/120/6L/ CB_bg_0.3D_AN_NL11	CMT1600
eME520-162G12Mi	EMEA	Luxembourg	LX.N070Y.064	eME520-162G12Mi VHB32eTLU1 UMAC 1*2G/120/6L/ CB_bg_0.3D_AN_IT41	CMT1600
eME520-162G12Mi	EMEA	Norway	LX.N070Y.065	eME520-162G12Mi VHB32eTNO1 UMAC 1*2G/120/6L/ CB_bg_0.3D_AN_NO11	CMT1600
eME520-162G12Mi	EMEA	Russia	LX.N070Y.061	eME520-162G12Mi VHB32eTRU1 UMAC 1*2G/120/6L/ CB_bg_0.3D_AN_RU11	CMT1600
eME520-162G12Mi	EMEA	Sweden/ Finland	LX.N070Y.059	eME520-162G12Mi VHB32eTSE1 UMAC 1*2G/120/6L/ CB_bg_0.3D_AN_FI11	CMT1600
eME520-162G12Mi	EMEA	Czech	LX.N070Y.058	eME520-162G12Mi VHB32eTCZ2 UMAC 1*2G/120/6L/ CB_bg_0.3D_AN_SK11	CMT1600
eME520-162G12Mi	EMEA	Eastern Europe	LX.N070Y.060	eME520-162G12Mi VHB32eTEU4 UMAC 1*2G/120/6L/ CB_bg_0.3D_AN_FI11	CMT1600
eME520-162G12Mi	EMEA	Eastern Europe	LX.N070Y.057	eME520-162G12Mi VHB32eTEU3 UMAC 1*2G/120/6L/ CB_bg_0.3D_AN_RU11	CMT1600
eME520-162G12Mi	EMEA	Eastern Europe	LX.N070Y.056	eME520-162G12Mi VHB32eTEU7 UMAC 1*2G/120/6L/ CB_bg_0.3D_AN_ENG1	CMT1600
eME520-162G12Mi	EMEA	Eastern Europe	LX.N070Y.052	eME520-162G12Mi VHB32eTEU1 UMAC 1*2G/120/6L/ CB_bg_0.3D_AN_CS21	CMT1600
eME520-162G12Mi	EMEA	Eastern Europe	LX.N070Y.053	eME520-162G12Mi VHB32eTEU2 UMAC 1*2G/120/6L/ CB_bg_0.3D_AN_HU21	CMT1600
eME520-162G12Mi	EMEA	Eastern Europe	LX.N070Y.054	eME520-162G12Mi VHB32eTEU5 UMAC 1*2G/120/6L/ CB_bg_0.3D_AN_PL11	CMT1600
eME520-162G12Mi	EMEA	Eastern Europe	LX.N070Y.055	eME520-162G12Mi VHB32eTEU6 UMAC 1*2G/120/6L/ CB_bg_0.3D_AN_CS21	CMT1600
eME520-162G12Mi	EMEA	Hungary	LX.N070Y.051	eME520-162G12Mi VHB32eTHU1 UMAC 1*2G/120/6L/ CB_bg_0.3D_AN_HU11	CMT1600
eME520-162G12Mi	EMEA	Slovenia/ Croatia	LX.N070Y.049	eME520-162G12Mi VHB32eTSI1 UMAC 1*2G/120/6L/CB_bg_0.3D_AN_EN11	CMT1600

Model	RO	Country	Acer Part No	Description	CPU
eME520-162G12Mi	EMEA	Portugal	LX.N070Y.048	eME520-162G12Mi VHB32eTPT1 UMAC 1*2G/120/6L/ CB_bg_0.3D_AN_PT11	CMT1600
eME520-162G12Mi	EMEA	Spain	LX.N070Y.050	eME520-162G12Mi VHB32eTES1 UMAC 1*2G/120/6L/ CB_bg_0.3D_AN_ES21	CMT1600
eME520-162G12Mi	EMEA	Greece	LX.N070Y.047	eME520-162G12Mi VHB32eTGR1 UMAC 1*2G/120/6L/ CB_bg_0.3D_AN_EL21	CMT1600
eME520-162G12Mi	EMEA	Israel	LX.N070Y.046	eME520-162G12Mi VHB32eTIL1 UMAC 1*2G/120/6L/CB_bg_0.3D_AN_HE11	CMT1600
eME520-162G12Mi	EMEA	Italy	LX.N070Y.045	eME520-162G12Mi VHB32eTIT1 UMAC 1*2G/120/6L/CB_bg_0.3D_AN_IT11	CMT1600
eME520-162G12Mi	EMEA	Turkey	LX.N070Y.044	eME520-162G12Mi EM VHB32eTTR1 UMAC 1*2G/120/6L/ CB_bg_0.3D_AN_TR41	CMT1600
eME520-162G12Mi	EMEA	Turkey	LX.N070Y.043	eME520-162G12Mi EM VHB32eTTR1 UMAC 1*2G/120/6L/ CB_bg_0.3D_AN_TR11	CMT1600
eME520-162G12Mi	EMEA	Middle East	LX.N070Y.042	eME520-162G12Mi EM VHB32eTME9 UMAC 1*2G/120/6L/ CB_bg_0.3D_AN_FR21	CMT1600
eME520-162G12Mi	EMEA	Middle East	LX.N070Y.041	eME520-162G12Mi EM VHB32eTME2 UMAC 1*2G/120/6L/ CB_bg_0.3D_AN_AR21	CMT1600
eME520-162G12Mi	EMEA	Middle East	LX.N070Y.040	eME520-162G12Mi EM VHB32eTME6 UMAC 1*2G/120/6L/ CB_bg_0.3D_AN_EN11	CMT1600
eME520-162G12Mi	EMEA	Middle East	LX.N070Y.039	eME520-162G12Mi EM VHB32eTME3 UMAC 1*2G/120/6L/ CB_bg_0.3D_AN_FR21	CMT1600
eME520-162G12Mi	EMEA	Middle East	LX.N070Y.038	eME520-162G12Mi EM VHB32eTME2 UMAC 1*2G/120/6L/ CB_bg_0.3D_AN_AR11	CMT1600
eME520-162G12Mi	EMEA	Switzerland	LX.N070Y.037	eME520-162G12Mi VHB32eTCH1 UMAC 1*2G/120/6L/ CB_bg_0.3D_AN_IT41	CMT1600
eME520-162G12Mi	EMEA	UK	LX.N070Y.036	eME520-162G12Mi VHB32eTGB1 UMAC 1*2G/120/6L/ CB_bg_0.3D_AN_EN11	CMT1600
eME520-162G12Mi	EMEA	Middle East	LX.N070X.042	eME520-162G12Mi EM VHP32eTME6 UMAC 1*2G/120/6L/ CB_bg_0.3D_AN_EN11	CMT1600
eME520-162G12Mi	EMEA	Middle East	LX.N070X.041	eME520-162G12Mi EM VHP32eTME2 UMAC 1*2G/120/6L/ CB_bg_0.3D_AN_AR11	CMT1600
eME520-162G12Mi	EMEA	Switzerland	LX.N070X.040	eME520-162G12Mi VHP32eTCH1 UMAC 1*2G/120/6L/ CB_bg_0.3D_AN_IT41	CMT1600
eME520-162G12Mi	EMEA	UK	LX.N070X.039	eME520-162G12Mi VHP32eTGB1 UMAC 1*2G/120/6L/ CB_bg_0.3D_AN_EN11	CMT1600
eME520-572G12Mi	EMEA	South Africa	LX.N070X.035	eME520-572G12Mi EM VHP32eTZA1 UMAC 1*2G/120/6L/ CB_bg_0.3D_AN_FR21	CM575

Model	RO	Country	Acer Part No	Description	CPU
eME520-572G12Mi	EMEA	South Africa	LX.N070X.036	eME520-572G12Mi EM VHP32eTZA2 UMAC 1*2G/120/6L/ CB_bg_0.3D_AN_EN11	CM575
eME520-572G12Mi	EMEA	Denmark	LX.N070X.037	eME520-572G12Mi VHP32eTDK1 UMAC 1*2G/120/6L/ CB_bg_0.3D_AN_NO11	CM575
eME520-572G12Mi	EMEA	France	LX.N070X.032	eME520-572G12Mi VHP32eTFR1 UMAC 1*2G/120/6L/ CB_bg_0.3D_AN_FR21	CM575
eME520-572G12Mi	EMEA	Germany	LX.N070X.033	eME520-572G12Mi VHP32eTDE1 UMAC 1*2G/120/6L/ CB_bg_0.3D_AN_DE11	CM575
eME520-572G12Mi	EMEA	Belgium	LX.N070X.034	eME520-572G12Mi VHP32eTBE1 UMAC 1*2G/120/6L/ CB_bg_0.3D_AN_NL11	CM575
eME520-572G12Mi	EMEA	Holland	LX.N070X.031	eME520-572G12Mi VHP32eTNL1 UMAC 1*2G/120/6L/ CB_bg_0.3D_AN_NL11	CM575
eME520-572G12Mi	EMEA	Luxembourg	LX.N070X.030	eME520-572G12Mi VHP32eTLU1 UMAC 1*2G/120/6L/ CB_bg_0.3D_AN_IT41	CM575
eME520-572G12Mi	EMEA	Norway	LX.N070X.029	eME520-572G12Mi VHP32eTNO1 UMAC 1*2G/120/6L/ CB_bg_0.3D_AN_NO11	CM575
eME520-572G12Mi	EMEA	Russia	LX.N070X.025	eME520-572G12Mi VHP32eTRU1 UMAC 1*2G/120/6L/ CB_bg_0.3D_AN_RU11	CM575
eME520-572G12Mi	EMEA	Sweden/ Finland	LX.N070X.026	eME520-572G12Mi VHP32eTSE1 UMAC 1*2G/120/6L/ CB_bg_0.3D_AN_FI11	CM575
eME520-572G12Mi	EMEA	Czech	LX.N070X.027	eME520-572G12Mi VHP32eTCZ2 UMAC 1*2G/120/6L/ CB_bg_0.3D_AN_SK11	CM575
eME520-572G12Mi	EMEA	Eastern Europe	LX.N070X.028	eME520-572G12Mi VHP32eTEU4 UMAC 1*2G/120/6L/ CB_bg_0.3D_AN_FI11	CM575
eME520-572G12Mi	EMEA	Eastern Europe	LX.N070X.022	eME520-572G12Mi VHP32eTEU3 UMAC 1*2G/120/6L/ CB_bg_0.3D_AN_RU21	CM575
eME520-572G12Mi	EMEA	Eastern Europe	LX.N070X.023	eME520-572G12Mi VHP32eTEU6 UMAC 1*2G/120/6L/ CB_bg_0.3D_AN_CS21	CM575
eME520-572G12Mi	EMEA	Eastern Europe	LX.N070X.024	eME520-572G12Mi VHP32eTEU7 UMAC 1*2G/120/6L/ CB_bg_0.3D_AN_ENG1	CM575
eME520-572G12Mi	EMEA	Eastern Europe	LX.N070X.021	eME520-572G12Mi VHP32eTEU1 UMAC 1*2G/120/6L/ CB_bg_0.3D_AN_CS21	CM575
eME520-572G12Mi	EMEA	Eastern Europe	LX.N070X.020	eME520-572G12Mi VHP32eTEU3 UMAC 1*2G/120/6L/ CB_bg_0.3D_AN_RU11	CM575
eME520-572G12Mi	EMEA	Eastern Europe	LX.N070X.019	eME520-572G12Mi VHP32eTEU5 UMAC 1*2G/120/6L/ CB_bg_0.3D_AN_PL11	CM575
eME520-572G12Mi	EMEA	Hungary	LX.N070X.015	eME520-572G12Mi VHP32eTHU1 UMAC 1*2G/120/6L/ CB_bg_0.3D_AN_HU11	CM575

Model	RO	Country	Acer Part No	Description	CPU
eME520-572G12Mi	EMEA	Slovenia/ Croatia	LX.N070X.016	eME520-572G12Mi VHP32eTSl1 UMAC 1*2G/120/6L/CB_bg_0.3D_AN_EN11	CM575
eME520-572G12Mi	EMEA	Portugal	LX.N070X.017	eME520-572G12Mi VHP32eTPT1 UMAC 1*2G/120/6L/CB_bg_0.3D_AN_PT11	CM575
eME520-572G12Mi	EMEA	Spain	LX.N070X.018	eME520-572G12Mi VHP32eTES1 UMAC 1*2G/120/6L/CB_bg_0.3D_AN_ES21	CM575
eME520-572G12Mi	EMEA	Greece	LX.N070X.012	eME520-572G12Mi VHP32eTGR1 UMAC 1*2G/120/6L/CB_bg_0.3D_AN_EL31	CM575
eME520-572G12Mi	EMEA	Greece	LX.N070X.013	eME520-572G12Mi VHP32eTGR1 UMAC 1*2G/120/6L/CB_bg_0.3D_AN_EL21	CM575
eME520-572G12Mi	EMEA	Israel	LX.N070X.014	eME520-572G12Mi VHP32eTIL1 UMAC 1*2G/120/6L/CB_bg_0.3D_AN_HE11	CM575
eME520-572G12Mi	EMEA	Italy	LX.N070X.011	eME520-572G12Mi VHP32eTIT1 UMAC 1*2G/120/6L/CB_bg_0.3D_AN_IT12	CM575
eME520-572G12Mi	EMEA	Turkey	LX.N070X.010	eME520-572G12Mi EM VHP32eTTR1 UMAC 1*2G/120/6L/CB_bg_0.3D_AN_TR31	CM575
eME520-572G12Mi	EMEA	Middle East	LX.N070X.009	eME520-572G12Mi EM VHP32eTME3 UMAC 1*2G/120/6L/CB_bg_0.3D_AN_FR21	CM575
eME520-572G12Mi	EMEA	Middle East	LX.N070X.005	eME520-572G12Mi EM VHP32eTME4 UMAC 1*2G/120/6L/CB_bg_0.3D_AN_EN11	CM575
eME520-572G12Mi	EMEA	Middle East	LX.N070X.006	eME520-572G12Mi EM VHP32eTME2 UMAC 1*2G/120/6L/CB_bg_0.3D_AN_EN11	CM575
eME520-572G12Mi	EMEA	Middle East	LX.N070X.007	eME520-572G12Mi EM VHP32eTME9 UMAC 1*2G/120/6L/CB_bg_0.3D_AN_FR21	CM575
eME520-572G12Mi	EMEA	Middle East	LX.N070X.008	eME520-572G12Mi EM VHP32eTME2 UMAC 1*2G/120/6L/CB_bg_0.3D_AN_AR21	CM575
eME520-572G12Mi	EMEA	Middle East	LX.N070X.002	eME520-572G12Mi EM VHP32eTME6 UMAC 1*2G/120/6L/CB_bg_0.3D_AN_EN11	CM575
eME520-572G12Mi	EMEA	Middle East	LX.N070X.003	eME520-572G12Mi EM VHP32eTME2 UMAC 1*2G/120/6L/CB_bg_0.3D_AN_AR11	CM575
eME520-572G12Mi	EMEA	Switzerland	LX.N070X.004	eME520-572G12Mi VHP32eTCH1 UMAC 1*2G/120/6L/CB_bg_0.3D_AN_IT41	CM575
eME520-572G12Mi	EMEA	UK	LX.N070X.001	eME520-572G12Mi VHP32eTGB1 UMAC 1*2G/120/6L/CB_bg_0.3D_AN_EN11	CM575
eME520-163G32Ci	AAP	Indonesia	LX.N070C.002	eME520-163G32Ci LIMPUSelD1 UMAC 2G+1G/320/6L/CB_bg_0.3D_AN_ID21	CMT1600
eME520-162G12Mi	EMEA	Eastern Europe	LX.N070X.062	eME520-162G12Mi VHP32eTEU3 UMAC 1*2G/120/6L/CB_bg_0.3D_AN_RU21	CMT1600
eME520-162G12Mi	EMEA	Czech	LX.N070X.068	eME520-162G12Mi VHP32eTCZ2 UMAC 1*2G/120/6L/CB_bg_0.3D_AN_SK11	CMT1600

Model	RO	Country	Acer Part No	Description	CPU
eME520-162G12Mi	EMEA	Eastern Europe	LX.N070X.061	eME520-162G12Mi VHP32eTEU4 UMAC 1*2G/120/6L/ CB_bg_0.3D_AN_FI11	CMT1600
eME520-162G12Mi	EMEA	Eastern Europe	LX.N070X.060	eME520-162G12Mi VHP32eTEU6 UMAC 1*2G/120/6L/ CB_bg_0.3D_AN_CS21	CMT1600
eME520-162G12Mi	EMEA	Eastern Europe	LX.N070X.059	eME520-162G12Mi VHP32eTEU7 UMAC 1*2G/120/6L/ CB_bg_0.3D_AN_ENG1	CMT1600
eME520-162G12Mi	EMEA	Eastern Europe	LX.N070X.055	eME520-162G12Mi VHP32eTEU1 UMAC 1*2G/120/6L/ CB_bg_0.3D_AN_CS21	CMT1600
eME520-162G12Mi	EMEA	Eastern Europe	LX.N070X.054	eME520-162G12Mi VHP32eTEU3 UMAC 1*2G/120/6L/ CB_bg_0.3D_AN_RU11	CMT1600
eME520-162G12Mi	EMEA	Eastern Europe	LX.N070X.056	eME520-162G12Mi VHP32eTEU5 UMAC 1*2G/120/6L/ CB_bg_0.3D_AN_PL11	CMT1600
eME520-162G12Mi	EMEA	Hungary	LX.N070X.053	eME520-162G12Mi VHP32eTHU1 UMAC 1*2G/120/6L/ CB_bg_0.3D_AN_HU11	CMT1600
eME520-162G12Mi	EMEA	Slovenia/ Croatia	LX.N070X.057	eME520-162G12Mi VHP32eTSI1 UMAC 1*2G/120/6L/CB_bg_0.3D_AN_EN11	CMT1600
eME520-162G12Mi	EMEA	Portugal	LX.N070X.052	eME520-162G12Mi VHP32eTPT1 UMAC 1*2G/120/6L/ CB_bg_0.3D_AN_PT11	CMT1600
eME520-162G12Mi	EMEA	Spain	LX.N070X.058	eME520-162G12Mi VHP32eTES1 UMAC 1*2G/120/6L/ CB_bg_0.3D_AN_ES21	CMT1600
eME520-162G12Mi	EMEA	Greece	LX.N070X.048	eME520-162G12Mi VHP32eTGR1 UMAC 1*2G/120/6L/ CB_bg_0.3D_AN_EL31	CMT1600
eME520-162G12Mi	EMEA	Greece	LX.N070X.051	eME520-162G12Mi VHP32eTGR1 UMAC 1*2G/120/6L/ CB_bg_0.3D_AN_EL21	CMT1600
eME520-162G12Mi	EMEA	Israel	LX.N070X.047	eME520-162G12Mi VHP32eTIL1 UMAC 1*2G/120/6L/CB_bg_0.3D_AN_HE11	CMT1600
eME520-162G12Mi	EMEA	Italy	LX.N070X.050	eME520-162G12Mi VHP32eTIT1 UMAC 1*2G/120/6L/CB_bg_0.3D_AN_IT12	CMT1600
eME520-162G12Mi	EMEA	Turkey	LX.N070X.046	eME520-162G12Mi EM VHP32eTTR1 UMAC 1*2G/120/6L/ CB_bg_0.3D_AN_TR31	CMT1600
eME520-162G12Mi	EMEA	Middle East	LX.N070X.049	eME520-162G12Mi EM VHP32eTME3 UMAC 1*2G/120/6L/ CB_bg_0.3D_AN_FR21	CMT1600
eME520-162G12Mi	EMEA	Middle East	LX.N070X.045	eME520-162G12Mi EM VHP32eTME4 UMAC 1*2G/120/6L/ CB_bg_0.3D_AN_EN11	CMT1600
eME520-162G12Mi	EMEA	Middle East	LX.N070X.044	eME520-162G12Mi EM VHP32eTME2 UMAC 1*2G/120/6L/ CB_bg_0.3D_AN_EN11	CMT1600
eME520-162G12Mi	EMEA	Middle East	LX.N070X.043	eME520-162G12Mi EM VHP32eTME9 UMAC 1*2G/120/6L/ CB_bg_0.3D_AN_FR21	CMT1600
eME520-162G12Mi	EMEA	Middle East	LX.N070X.038	eME520-162G12Mi EM VHP32eTME2 UMAC 1*2G/120/6L/ CB_bg_0.3D_AN_AR21	CMT1600

Model	RO	Country	Acer Part No	Description	CPU
eME520-573G16Mi	EMEA	Denmark	LX.N070X.075	eME520-573G16Mi VHP32eTDK1 UMAC 1G+2G/160/6L/ CB_bg_0.3D_AN_NO11	CM575
eME520-571G16Mi	EMEA	Eastern Europe	LX.N070C.005	eME520-571G16Mi LINPUSeEU2 UMAC 1*1G/160/6L/ CB_bg_0.3D_AN_EN44	CM575
eME520-571G16Mi	AAP	India	LX.N070C.013	eME520-571G16Mi LINPUSeIN1 UMAC 1*1G/160/6L/CB_bg_0.3D_AN_EN11	CM575
eME520-572G16Mi	AAP	India	LX.N070C.012	eME520-572G16Mi LINPUSeIN1 UMAC 2*1G/160/6L/CB_bg_0.3D_AN_EN11	CM575
eME520-572G25Mi	AAP	India	LX.N070C.011	eME520-572G25Mi LINPUSeIN1 UMAC 2*1G/250/6L/CB_bg_0.3D_AN_EN11	CM575
eME520-162G25Mi	AAP	India	LX.N070C.010	eME520-162G25Mi LINPUSeIN1 UMAC 2*1G/250/6L/CB_bg_0.3D_AN_EN11	CMT1600
eME520-161G16Mi	AAP	India	LX.N070C.009	eME520-161G16Mi LINPUSeIN1 UMAC 1*1G/160/6L/CB_bg_0.3D_AN_EN11	CMT1600
eME520-571G12i	PA	USA	LX.N070C.008	eME520-571G12i LINPUSeUS1 UMAC 1*1G/120/6L/CB_bg_0.3D_AN_EN31	CM575
eME520-571G12i	PA	ACLA-Portuguese	LX.N070C.007	eME520-571G12i LINPUSeXC1 UMAC 1*1G/120/6L/CB_bg_0.3D_AN_EN61	CM575
eME520-571G12i	PA	ACLA-Spanish	LX.N070C.006	eME520-571G12i LINPUSeEA3 UMAC 1*1G/120/6L/CB_bg_0.3D_AN_EN61	CM575
eME520-572G16Mi	EMEA	France	LX.N070Y.071	eME520-572G16Mi VHB32eTFR1 UMAC 1*2G/160/6L/ CB_bg_0.3D_AN_FR21	CM575

Model	LCD	Memory 1	Memory 2	HDD 1(GB)	ODD	Wireless LAN
eME520-571G12Mi	N15.4WXGAG8	SO1GBII6	N	N120GB5.4KS	NSM8XS	3rd WiFi BG
eME520-571G12Mi	N15.4WXGAG8	SO1GBII6	N	N120GB5.4KS	NSM8XS	3rd WiFi BG
eME520-571G12Mi	N15.4WXGAG8	SO1GBII6	N	N120GB5.4KS	NSM8XS	3rd WiFi BG
eME520-571G12Mi	N15.4WXGAG8	SO1GBII6	N	N120GB5.4KS	NSM8XS	3rd WiFi BG
eME520-571G12Mi	N15.4WXGAG8	SO1GBII6	N	N120GB5.4KS	NSM8XS	3rd WiFi BG
eME520-571G12Mi	N15.4WXGAG8	SO1GBII6	N	N120GB5.4KS	NSM8XS	3rd WiFi BG
eME520-571G12Mi	N15.4WXGAG8	SO1GBII6	N	N120GB5.4KS	NSM8XS	3rd WiFi BG
eME520-571G12Mi	N15.4WXGAG8	SO1GBII6	N	N120GB5.4KS	NSM8XS	3rd WiFi BG
eME520-571G12Mi	N15.4WXGAG8	SO1GBII6	N	N120GB5.4KS	NSM8XS	3rd WiFi BG
eME520-571G12Mi	N15.4WXGAG8	SO1GBII6	N	N120GB5.4KS	NSM8XS	3rd WiFi BG
eME520-573G16i	N15.4WXGAG8	SO2GBII6	SO1GBII6	N160GB5.4KS	N	3rd WiFi BG
eME520-571G12Mi	N15.4WXGAG8	SO1GBII6	N	N120GB5.4KS	NSM8XS	3rd WiFi BG
eME520-571G16Mi	N15.4WXGAG8	SO1GBII6	N	N160GB5.4KS	NSM8XS	3rd WiFi BG

Model	LCD	Memory 1	Memory 2	HDD 1(GB)	ODD	Wireless LAN
eME520-162G12Mi	N15.4WXGAG8	SO2GBII6	N	N120GB5.4KS	NSM8XS	3rd WiFi BG
eME520-162G12Mi	N15.4WXGAG8	SO2GBII6	N	N120GB5.4KS	NSM8XS	3rd WiFi BG
eME520-162G12Mi	N15.4WXGAG8	SO2GBII6	N	N120GB5.4KS	NSM8XS	3rd WiFi BG
eME520-573G16Mi	N15.4WXGAG8	SO1GBII6	SO2GBII6	N160GB5.4KS	NSM8XS	3rd WiFi BG
eME520-571G16Mi	N15.4WXGAG8	SO1GBII6	N	N160GB5.4KS	NSM8XS	3rd WiFi BG
eME520-571G16Mi	N15.4WXGAG8	SO1GBII6	N	N160GB5.4KS	NSM8XS	3rd WiFi BG
eME520-572G16Mi	N15.4WXGAG8	SO1GBII6	SO1GBII6	N160GB5.4KS	NSM8XS	3rd WiFi BG
eME520-572G25Mi	N15.4WXGAG8	SO1GBII6	SO1GBII6	N250GB5.4KS	NSM8XS	3rd WiFi BG
eME520-162G25Mi	N15.4WXGAG8	SO1GBII6	SO1GBII6	N250GB5.4KS	NSM8XS	3rd WiFi BG
eME520-161G16Mi	N15.4WXGAG8	SO1GBII6	N	N160GB5.4KS	NSM8XS	3rd WiFi BG
eME520-571G12i	N15.4WXGAG8	SO1GBII6	N	N120GB5.4KS	N	3rd WiFi BG
eME520-571G12i	N15.4WXGAG8	SO1GBII6	N	N120GB5.4KS	N	3rd WiFi BG
eME520-571G12i	N15.4WXGAG8	SO1GBII6	N	N120GB5.4KS	N	3rd WiFi BG
eME520-572G16Mi	N15.4WXGAG8	SO2GBII6	N	N160GB5.4KS	NSM8XS	3rd WiFi BG

Test Compatible Components

This computer's compatibility is tested and verified by Acer's internal testing department. All of its system functions are tested under Windows® XP Home, Windows® XP Pro environment.

Refer to the following lists for components, adapter cards, and peripherals which have passed these tests. Regarding configuration, combination and test procedures, please refer to the eMachines E720/E520 Series Compatibility Test Report released by the Acer Mobile System Testing Department.

Microsoft® Windows® Vista Environment Test

Vendor	Type	Description
Adapter Test		
F0000183 DELTA CN	65W	Adapter DELTA 65W 1.7x5.5x11 SADP-65KB DFA LF level 4
10001023 LITE-ON	65W	Adapter LITE-ON 65W 1.7x5.5x11 PA-1650-02AC LF level 4
60002015 HIPRO	65W	Adapter HIPRO 65W 19V 1.7x5.5x11 Yellow HP-OK065B13 LED LF level 4
F0000183 DELTA CN	65W-DE	Adapter DELTA 65W 1.7x5.5x11 SADP-65KB BFJA LV4 LF for OBL only
Battery Test		
60001921 SANYO	6CELL2.2	Battery SANYO AS-2007B Li-Ion 3S2P SANYO 6 cell 4400mAh Main COMMON Normal Type
10001063 SONY	6CELL2.2	Battery SONY AS-2007B Li-Ion 3S2P SONY 6 cell 4400mAh Main COMMON Normal Type
60001535 PANASONIC	6CELL2.2	Battery PANASONIC AS-2007B Li-Ion 3S2P PANASONIC 6 cell 4400mAh Main COMMON PSS
60002162 SIMPLO	6CELL2.2	Battery SIMPLO AS-2007B Li-Ion 3S2P PANASONIC 6 cell 4400mAh Main COMMON PSS
60001921 SANYO	8CELL2.4	Battery SANYO AS-2007B Li-Ion 4S2P SANYO 8 cell 4800mAh Main COMMON
10001063 SONY	8CELL2.4	Battery SONY AS-2007B Li-Ion 4S2P SONY 8 cell 4800mAh Main COMMON
60001535 PANASONIC	8CELL2.4	Battery PANASONIC AS-2007B Li-Ion 4S2P PANASONIC 8 cell 4800mAh Main COMMON
CPU Test		
10001067 INTEL	CM575	CPU Intel Celeron 575 PGA 2.0G 1M 667 MV
10001067 INTEL	CM585	CPU Intel Celeron 585 PGA 2.16G 1M 667 MV
10001067 INTEL	CMT1600	CPU Intel CeleronM T1600 1.66G 1M 667 Dual Core, MV
10001067 INTEL	CMT1700	CPU Intel CeleronM T1700 PGA 1.83G 1M 667 Dual Core, MV
HDD Test		
60002036 SEAGATE	N120GB5.4KS	HDD SEAGATE 2.5" 5400rpm 120GB ST9120817AS Corsair SATA LF F/W:3.AAA
60002005 HGST SG	N120GB5.4KS	HDD HGST 2.5" 5400rpm 120GB HTS543212L9A300 Falcon-B SATA LF F/W:C40C
60001994 WD	N120GB5.4KS	HDD WD 2.5" 5400rpm 120GB WD1200BEVS-22UST0 ML125 SATA LF F/W:01.01A01
60002005 HGST SG	N160GB5.4KS	HDD HGST 2.5" 5400rpm 160GB HTS543216L9A300 Falcon-B SATA LF F/W:C40C
60001994 WD	N160GB5.4KS	HDD WD 2.5" 5400rpm 160GB WD1600BEVT-22ZCTO ML160 SATA LF F/W:11.01A11
60002036 SEAGATE	N250GB5.4KS	HDD SEAGATE 2.5" 5400rpm 250GB ST9250827AS Corsair SATA LF F/W:3.AAA
60002005 HGST SG	N250GB5.4KS	HDD HGST 2.5" 5400rpm 250GB HTS543225L9A300 Falcon-B SATA LF F/W:C40C

Vendor	Type	Description
60002005 HGST SG	N320GB5.4KS	HDD HGST 2.5" 5400rpm 320GB HTS543232L9A300 Falcon-B SATA LF F/W:C40C
60001994 WD	N320GB5.4KS	HDD WD 2.5" 5400rpm 320GB WD3200BEVT-22ZCT0 ML160 SATA LF F/W:11.01A11
LCD Test		
60003316 AUO	N15.4WXGAG8	LCD AUO 15.4" WXGA Glare B154EW08-V1 w/o bracket, HW 3A LF 220nit 8ms
60003089 LG	N15.4WXGAG8	LCD LPL 15.4" WXGA Glare LP154WX4-TLB4 LF 220nit 8ms
10001038 CMO	N15.4WXGAG8	LCD CMO 15.4" WXGA Glare N154I3-L03 LF 220nit 8ms
Memory Test		
16081942 MICRON	SO1GBII6	Memory MICRON SO-DIMM DDRII 667 1GB MT8HTF12864HDY-667E1 LF
60002215 SAMSUNG	SO1GBII6	Memory SAMSUNG SO-DIMM DDRII 667 1GB M470T2864QZ3-CE6 LF
60002045 HYNIX	SO1GBII6	Memory HYNIX SO-DIMM DDRII 667 1GB HYMP112S64CP6-Y5 LF
16081942 MICRON	SO2GBII6	Memory MICRON SO-DIMM DDRII 667 2GB MT16HTF25664HY-667E1 LF
60002215 SAMSUNG	SO2GBII6	Memory SAMSUNG SO-DIMM DDRII 667 2GB M470T5663QZ3-CE6 LF
60002045 HYNIX	SO2GBII6	Memory HYNIX SO-DIMM DDRII 667 2GB HYMP125S64CP8-Y5 LF
ODD Test		
60001922 TOSHIBA DIGI	NCB24XS	ODD TOSHIBA COMBO 12.7mm Tray DL 24X TS-L463A LF W/O bezel SATA
10001063 SONY	NCB24XS	ODD SONY COMBO 12.7mm Tray DL 24X CRX890S LF W/O bezel SATA
60001939 PIONEER	NSM8XS	ODD PIONEER Super-Multi DRIVE 12.7mm Tray DL 8X DVR-TD08RS LF W/O bezel SATA
60001939 PIONEER	NSM8XS	ODD PIONEER Super-Multi DRIVE 12.7mm Tray DL 8X DVR-TD08RS LF W/O bezel FW 1.06 SATA
10001070 PHILIPS	NSM8XS	ODD PLDS Super-Multi DRIVE 12.7mm Tray DL 8X DS-8A2S LF W/O bezel SATA
Northbridge Chipset Test		
10001067 INTEL	GL40	NB Chipset Intel CS GL40NB
Southbridge Chipset Test		
10001067 INTEL	ICH9M	SB Chipset Intel CS ICH9M
Keyboard Test		
10001044 CHICONY	14_15KB-eM1 Black	Keyboard 14_15KB-eM1 Black Elbe Internal Standard Black
LAN Test		
9999995 ONE TIME VENDER	RTL8111C	Realtek Lan RTL8111C

Vendor	Type	Description
Audio Codec Test		
9999995 ONE TIME VENDER	ALC268	ALC268
LCD Camera Test		
9999995 ONE TIME VENDER	0.3M DV	Suyin 0.3M DV Camellia_2
9999995 ONE TIME VENDER	0.3M DV	Chicony 0.3M DV Calla_2
Software Test		
10000981 MISC	NIS	Antivirus application NIS
WLAN Test		
23707801 FOXCONN TW	3rd WiFi BG	Foxconn FOX_ATH_XB63 Foxconn Atheros XB63 minicard b/g
9999995 ONE TIME VENDER	3rd WiFi BG	Foxconn Wireless LAN Broadcom 4312 minicard b/g

Online Support Information

This section describes online technical support services available to help you repair your Acer Systems.

If you are a distributor, dealer, ASP or TPM, please refer your technical queries to your local Acer branch office. Acer Branch Offices and Regional Business Units may access our website. However some information sources will require a user i.d. and password. These can be obtained directly from Acer CSD Taiwan.

Acer's Website offers you convenient and valuable support resources whenever you need them.

In the Technical Information section you can download information on all of Acer's Notebook, Desktop and Server models including:

- Service guides for all models
- User's manuals
- Training materials
- Bios updates
- Software utilities
- Spare parts lists
- TABs (Technical Announcement Bulletin)

For these purposes, we have included an Acrobat File to facilitate the problem-free downloading of our technical material.

Also contained on this website are:

- Detailed information on Acer's International Traveler's Warranty (ITW)
- Returned material authorization procedures
- An overview of all the support services we offer, accompanied by a list of telephone, fax and email contacts for all your technical queries.

We are always looking for ways to optimize and improve our services, so if you have any suggestions or comments, please do not hesitate to communicate these to us.

A

AFLASH Utility 35
Antennas 103

B

Battery Pack 46
BIOS
 ROM size 16
 ROM type 16
BIOS Supports protocol 16
BIOS Utility 25–35
 Boot 33
 Exit 34
 Navigating 25
 Onboard Device Configuration 29
 Power 31
 Save and Exit 34
 Security 28
 System Security 34
Bluetooth module 84
Board Layout
 Top View 161
brightness
 hotkeys 12

C

Cache
 controller 16
 size 16
Camera Module 99
caps lock
 on indicator 9
Common Problems 140
computer
 on indicator 9
CPU 93

D

DIMM Module 51
Display 3
display
 hotkeys 12

E

EasyTouch Failure 152
Ekey Board 79
eKey Board 79
Euro 13
External Module Disassembly
 Flowchart 45

F

Features 1
Fingerprint Reader Failure 153
Flash Utility 35
FPC Cable 102
FRU (Field Replaceable Unit) List 167

H

Hard Disk Drive Module 56
HDTV Switch Failure 154
Hibernation mode
 hotkey 12
Hot Keys 10

I

Indicators 9
Intermittent Problems 156
Internal Microphone Failure 146
Internal Speaker Failure 144
inverter board 97

J

Jumper and Connector Locations 161
 Top View 161

K

Keyboard 63
Keyboard Failure 143

L

Launch Board 78

- LCD Bezel 96
- LCD Brackets 102
- LCD Failure 143
- LCD Module Disassembly
 - Flowchart 95
- LCD Panel 101
- lower cover 49

M

- Main Unit Disassembly
 - Flowchart 60
- Mainboard 88
- media access
 - on indicator 9
- MediaTouch Button Failure 153
- Memory Check 140
- Model Definition 178
- Modem Failure 151
- Modem Module 86

N

- No Display Issue 141
- Notebook Manager
 - hotkey 12
- num lock
 - on indicator 9

O

- ODD Failure 148
- Online Support Information 201
- optical drive module 58

P

- Panel 4
 - Bottom 8
 - left 4
- PC Card 9
- Power On Failure 140

R

- Right Speaker Module 82

S

- speakers
 - hotkey 12
- System
 - Block Diagram 3

T

- Test Compatible Components 197
- Thermal Unit Failure 154
- Top 161
- TouchPad
 - hotkey 12
- TouchPad Bracket 76
- TouchPad Failure 144
- Troubleshooting
 - Built-in KB Failure 143
 - EasyTouch Buttons 152
 - Fingerprint Reader 153
 - HDTV Switch 154
 - Internal Microphone 146
 - Internal Speakers 144
 - LCD Failure 143
 - MediTouch Buttons 153
 - Modem 151
 - No Display 141
 - ODD 148
 - Other Failures 155
 - Power On 140
 - Thermal Unit 154
 - TouchPad 144
 - USB 151
 - WLAN 152
- TV tuner 54

U

- Undetermined Problems 156
- USB Failure (Rightside) 151
- utility
 - BIOS 25–35

V

- VGA Module 94

W

- Windows 2000 Environment Test 198
- Wireless Function Failure 152
- WLAN Board 52

Free Manuals Download Website

<http://myh66.com>

<http://usermanuals.us>

<http://www.somanuals.com>

<http://www.4manuals.cc>

<http://www.manual-lib.com>

<http://www.404manual.com>

<http://www.luxmanual.com>

<http://aubethermostatmanual.com>

Golf course search by state

<http://golfingnear.com>

Email search by domain

<http://emailbydomain.com>

Auto manuals search

<http://auto.somanuals.com>

TV manuals search

<http://tv.somanuals.com>