

Acer Projector

P7505/F155/PF-807/P7605/F165/PF-
WU07/H9505BD/E255D/HE-822J/
P7305W/F125/PF-W07 Series
User's Guide

Copyright © 2013. Acer Incorporated.
All Rights Reserved.

Acer Projector User's Guide
Original Issue: 11/2013

Changes may be made periodically to the information in this publication without obligation to notify any person of such revisions or changes. Such changes will be incorporated in new editions of this manual or supplementary documents and publications. This company makes no representations or warranties, either expressed or implied, with respect to the contents hereof and specifically disclaims the implied warranties of merchantability or fitness for a particular purpose.

Record the model number, serial number, purchase date and place of purchase information in the space provided below. The serial number and model number are recorded on the label affixed to your projector. All correspondence concerning your unit should include the serial number, model number and purchase information.

No part of this publication may be reproduced, stored in a retrieval system, or transmitted, in any form or by any means, electronically, mechanically, by photocopy, recording or otherwise, without the prior written permission of Acer Incorporated.

Model number: _____

Serial number: _____

Date of purchase: _____

Place of purchase: _____

Acer and the Acer logo are registered trademarks of Acer Incorporated. Other companies' product names or trademarks are used herein for identification purposes only and belong to their respective companies.

"HDMI™, the HDMI logo and High-Definition Multimedia Interface are trademarks or registered trademarks of HDMI Licensing LLC."

Information for your safety and comfort

Read these instructions carefully. Keep this document for future reference. Follow all warnings and instructions marked on the product.

Turning the product off before cleaning

Unplug this product from the wall outlet before cleaning. Do not use liquid cleaners or aerosol cleaners. Use a damp cloth for cleaning.

Caution for plug as disconnecting device

Observe the following guidelines when connecting and disconnecting power to the external power supply unit:

- Install the power supply unit before connecting the power cord to the AC power outlet.
- Unplug the power cord before removing the power supply unit from the projector.
- If the system has multiple sources of power, disconnect power from the system by unplugging all power cords from the power supplies.

Caution for Accessibility

Be sure that the power outlet you plug the power cord into is easily accessible and located as close to the equipment operator as possible. When you need to disconnect power to the equipment, be sure to unplug the power cord from the electrical outlet.



Warnings!

- Do not use this product near water.
- Do not place this product on an unstable cart, stand or table. If the product falls, it could be seriously damaged.
- Slots and openings are provided for ventilation to ensure reliable operation of the product and to protect it from overheating. These openings must not be blocked or covered. The openings should never be blocked by placing the product on a bed, sofa, rug or other similar surface.

This product should never be placed near or over a radiator or heat register, or in a built-in installation unless proper ventilation is provided.

- Never push objects of any kind into this product through cabinet slots as they may touch dangerous voltage points or short-out parts that could result in a fire or electric shock. Never spill liquid of any kind onto or into the product.

- To avoid damage of internal components and to prevent battery leakage, do not place the product on a vibrating surface.
- Never use it under sporting, exercising, or any vibrating environment which will probably cause unexpected short current or damage rotor devices, lamp.

Using electrical power

- This product should be operated from the type of power indicated on the marking label. If you are not sure of the type of power available, consult your dealer or local power company.
- Do not allow anything to rest on the power cord. Do not locate this product where people will walk on the cord.
- If an extension cord is used with this product, make sure that the total ampere rating of the equipment plugged into the extension cord does not exceed the extension cord ampere rating. Also, make sure that the total rating of all products plugged into the wall outlet does not exceed the fuse rating.
- Do not overload a power outlet, strip or receptacle by plugging in too many devices. The overall system load must not exceed 80% of the branch circuit rating. If power strips are used, the load should not exceed 80% of the power strip's input rating.
- This product's AC adapter is equipped with a three-wire grounded plug. The plug only fits in a grounded power outlet. Make sure the power outlet is properly grounded before inserting the AC adapter plug. Do not insert the plug into a non-grounded power outlet. Contact your electrician for details.



.....
Warning! The grounding pin is a safety feature. Using a power outlet that is not properly grounded may result in electric shock and/or injury.



.....
Note: The grounding pin also provides good protection from unexpected noise produced by other nearby electrical devices that may interfere with the performance of this product.

- Use the product only with the supplied power supply cord set. If you need to replace the power cord set, make sure that the new power cord meets the following requirements: detachable type, UL listed/CSA certified, VDE approved or its equivalent, 4.5 meters (15 feet) maximum length.

Product servicing

Do not attempt to service this product yourself, as opening or removing covers may expose you to dangerous voltage points or other risks. Refer all servicing to qualified service personnel.

Unplug this product from the wall outlet and refer servicing to qualified service personnel when:

- the power cord or plug is damaged, cut or frayed
- liquid was spilled into the product
- the product was exposed to rain or water
- the product has been dropped or the case has been damaged
- the product exhibits a distinct change in performance, indicating a need for service
- the product does not operate normally after following the operating instructions



.....

Note: Adjust only those controls that are covered by the operating instructions, since improper adjustment of other controls may result in damage and will often require extensive work by a qualified technician to restore the product to normal condition.



.....

Warning! For safety reasons, do not use non-compliant parts when adding or changing components. Consult your reseller for purchase options.

Your device and its enhancements may contain small parts. Keep them out of the reach of small children.

Additional safety information

- Do not look into the projector's lens when the lamp is on. The bright may hurt your eyes.
- Turn on the projector first and then signal sources
- Do not place the product in following environments:
 - Space that is poorly ventilated or confined. At least 50cm clearance from walls and free flow of air around the projector is necessary.
 - Locations where temperatures may become excessively high, such as inside of a car with all windows rolled up.
 - Locations where excessive humidity, dust, or cigarette smoke may contaminate optical components, shortening the life span and darkening the image.
 - Locations near fire alarms.
 - Locations with an ambient temperature above 40 °C/104 °F.
 - Locations where the altitudes are higher than 10000 feet.
- Unplug immediately if there is something wrong with your projector. Do not operate if smoke, strange noise or odor comes out of your projector. It

might cause fire or electric shock. In this case, unplug immediately and contact your dealer.

- Do not keep using this product to break or drop it. In this case contact your dealer for inspection.
- Do not face the projector lens to the sun. It can lead to fire.
- When switching the projector off, suggest to ensure the projector completes its cooling cycle before disconnecting power.
- Do not frequently turn off the main power abruptly or unplug the projector during operation. The best way is to wait for the fan to turn off before turning main power off.
- Do not touch air outlet grille and bottom plate which becomes hot.
- Clean the air filter frequently if have. The temperature inside may rise and cause damage when the filter/ventilation slots clogged with dirt or dust.
- Do not look into the air outlet grille when projector is operating. It may hurt your eyes.
- Always open the lens shutter or remove the lens cap when the projector is on.
- Do not block the projector lens with any object when the projector is under operation as this could cause the object to become heated and deformed or even cause a fire. To temporarily turn off the lamp, press **HIDE** on the remote control.
- The lamp becomes extremely hot during operation. Allow the projector to cool for approximately 45 minutes prior to removing the lamp assembly for replacement.
- Do not operate lamps beyond the rated lamp life. It could cause it to break on rare occasions.
- Never replace the lamp assembly or any electronic components unless the projector is unplugged.
- The product will detect the life of the lamp itself. Please be sure to change the lamp when is showing warning message.
- When changing the lamp, please allow unit to cool down, and follow all changing instructions.
- Reset the "Lamp Hour Reset" function from the Onscreen display "Management" menu after replacing the lamp module.
- Do not attempt to disassemble this projector. There are dangerous high voltages inside which may hurt you. The only user serviceable part is the lamp which has its own removable cover. Refer servicing only to suitable qualified professional service personnel.
- Do not stand the projector on end vertically. It may cause the projector to fall over, causing injury or damage.
- This product is capable of displaying inverted images for ceiling mount installation. Only use acer ceiling mount kit for mounting the projector and ensure it is securely installed.

Caution for Listening

To protect your hearing, follow these instructions.

- Increase the volume gradually until you can hear clearly and comfortably.
- Do not increase the volume level after your ears have adjusted.
- Do not listen to music at high volumes for extended periods.
- Do not increase the volume to block out noisy surroundings.
- Decrease the volume if you can't hear people speaking near you.

Disposal instructions

Do not throw this electronic device into the trash when discarding. To minimize pollution and ensure utmost protection of the global environment, please recycle. For more information on the Waste from Electrical and Electronics Equipment (WEEE) regulations, visit

<http://www.acer-group.com/public/Sustainability/index.htm>



Mercury advisory

For projectors or electronic products containing an LCD/CRT monitor or display:



“Lamp(s) contain Mercury,
Dispose Properly.”

Lamp(s) inside this product contain mercury and must be recycled or disposed of according to local, state or federal laws. For more information, contact the Electronic Industries Alliance at www.eiae.org. For lamp-specific disposal information, check www.lamprecycle.org

First things first

Usage Notes

Do:

- Turn off the product before cleaning.
- Use a soft cloth moistened with mild detergent to clean the display housing.
- Disconnect the power plug from AC outlet if the product is not being used for a long period of time.

Don't:

- Block the slots and openings on the unit provided for ventilation.
- Use abrasive cleaners, waxes or solvents to clean the unit.
- Use under the following conditions:
 - In extremely hot, cold or humid environments.
 - In areas susceptible to excessive dust and dirt.
 - Near any appliance that generates a strong magnetic field.
 - Place In direct sunlight.

Precautions

Follow all warnings, precautions and maintenance as recommended in this user's guide to maximize the life of your unit.



Warning:

- Do not look into the projector's lens when the lamp is on. The bright light may hurt your eyes.
- To reduce the risk of fire or electric shock, do not expose this product to rain or moisture.
- Please do not open or disassemble the product as this may cause electric shock.
- When changing the lamp, please allow unit to cool down, and follow all changing instructions.
- This product will detect the life of the lamp itself. Please be sure to change the lamp when it shows warning messages.
- Reset the "Lamp Hour Reset" function from the Onscreen display "Management" menu after replacing the lamp module.
- When switching the projector off, please ensure the projector completes its cooling cycle before disconnecting power.
- Turn on the projector first and then the signal sources.
- Do not use lens cap when projector is in operation.
- When the lamp reaches the end of its life, it will burn out and may make a loud popping sound. If this happens, the projector will not turn back on until the lamp module has been replaced. To replace the lamp, follow the procedures listed under "Replacing the Lamp".

Information for your safety and comfort	iii
First things first	viii
Usage Notes	viii
Precautions	viii
Introduction	1
Product Features	1
Package Overview	3
Projector Overview	4
Projector Outlook	4
Control Panel	6
Remote Control Layout	7
Getting Started	9
Connecting the Projector	9
Turning the Projector On/Off	11
Turning on the Projector	11
Turning the projector off	12
Adjusting the Projected Image	13
Adjusting the Height of Projected Image	13
How to optimize image size and distance	14
How to get a preferred image size by adjusting distance and zoom	17
How to get a preferred image position by adjusting lens shift	20
User Controls	23
Installation menu	23
Onscreen Display (OSD) Menus	25
Color	26
Image	28
Setting	30
Management	33
Audio	34
3D	35
Language	36

Contents

Appendices	37
Troubleshooting	37
LED & Alarm Definition Listing	41
Cleaning and replacing the dust filters	42
Replacing the Lamp	43
Ceiling Mount Installation	44
Specifications	47
Compatibility modes	50
Regulations and safety notices	54

Introduction

Product Features

This product is a single-chip DLP® projector. Outstanding features include:

- DLP® technology
- P7305W/F125/PF-W07 series: True 1280x800 WXGA resolution
P7505/F155/PF-807/H9505BD/E255D/HE-822J series: True 1920x1080 1080p resolution
P7605/F165/PF-WU07 series: True 1920x1200 WUXGA resolution
Full/4:3/16:9/L.Box aspect ratio supported
- Acer ColorBoost technology delivers nature's true colors for vivid, life-like images
- Acer ColorSafe II technology ensures consistent color rendition over time
- Enables projecting 3D content via DLP Link Technology: Blue-Ray 3D supported and Nvidia 3DTV Play Ready
- Enriches 3D experience for 2D contents via 2D to 3D convert function
- High brightness and contrast ratio
- Versatile display modes (Bright, Presentation, Standard, Video, Movie, Dark Cinema, Game, Sports, User) enable optimum performance in any situation
- NTSC / PAL / SECAM compatible and HDTV (720p, 1080i, 1080p) supported
- Side-sliding lamp design allows easy lamp replacement
- Lower power consumption and economy (ECO) mode extends lamp life
- Acer EcoProjecton Technology delivers Intelligent power management approach and physical efficiency improvement
- Equipped with HDMI™ connection supporting HDCP
- Advanced digital keystone correction optimizes presentations
- Smart detection delivers quick, intelligent source detection
- Multi-language on screen display (OSD) menus
- Full-function remote control
- Manual focus projection lens zooms up to 1.5x
- 2x digital zoom and pan move function

- Microsoft® Windows® 2000, XP, Vista®, Windows® 7, Windows® 8, OS compliant
- Manual lens shift adjustment



.....

Note: Functions vary depending on model definition.

Package Overview

This projector comes with all the items shown below. Check to make sure your unit is complete. Contact your dealer immediately if any thing is missing.

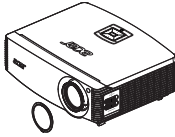

Projector with lens cap



Power cord



VGA cable



Composite video cable



Security card



User's guide

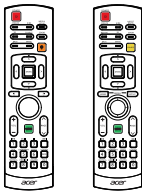

Remote control
(option)

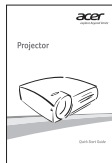

Quick start guide



2 x Batteries
(option)



Carrying case



USB WiFi adapter
(option)



Dust filter
(option)



User's guide
(for multi-media and
wireless functions)

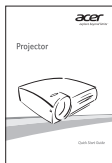

Quick start guide
(for multi-media and
wireless functions)

Projector Overview

Projector Outlook

Front / upper side

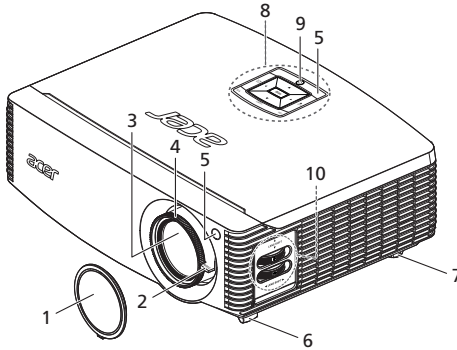

#	Description	#	Description
1	Lens cap	6	Elevator feet
2	Zoom lever	7	Tilt adjusting wheels
3	Zoom Lens	8	Control panel
4	Focus ring	9	Power button
5	Remote control receivers	10	Lens shift control rings

Rear side

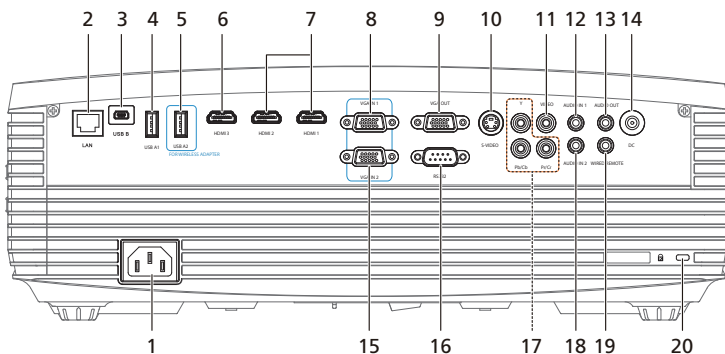

#	Description	#	Description
1	Power socket	11	Composite video input connector
2	LAN (RJ45 Port for 10/100M Ethernet)	12	Audio input 1 connector (VGA IN 1/VGA IN 2)
3	Mini USB Ctrl connector (for firmware upgrade and USB display)	13	Audio output connector
4	USB A1 connector	14	12V DC output connector
5	USB A2 connector (supports USB wireless adapter)	15	PC analog input connector (VGA IN 2)
6	HDMI 3 connector	16	RS232 connector
7	HDMI 1/HDMI 2 connector (supports 2D to 3D feature)	17	YPbPr/YCbCr input connector
8	PC analog signal/HDTV/SCART/component video input connector (VGA IN 1)	18	Audio input 2 connector (Component/Composite/S-Video)
9	Monitor loop-through output connector (for VGA IN 1 only)	19	Wired IR remote input connector
10	S-Video input connector	20	Kensington™ lock port



Note: Functions vary depending on model definition.

Control Panel

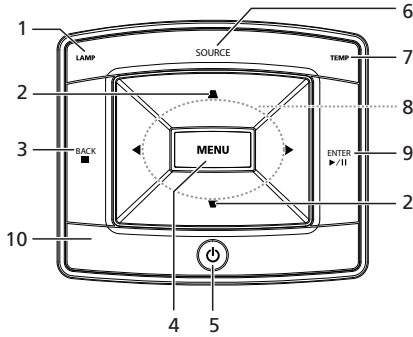





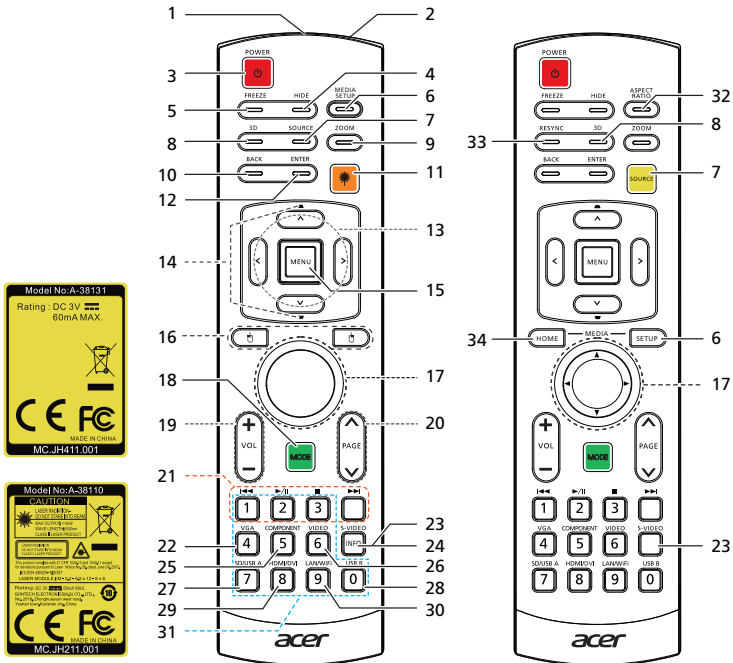



#	Icon	Function	Description
1		LAMP	Lamp Indicator LED
2		KEystone	Adjusts the image to compensate for distortion caused by tilting the projector.
3	BACK ■	Back/Stop	Press "Back/Stop" to stop playing media file or go back to upper data folder.
4		MENU	<ul style="list-style-type: none"> Press "MENU" to launch the Onscreen display (OSD) menu, back to the previous step for the OSD menu operation or exit the OSD menu. Confirm your selection of items.
5	⏻	POWER	See the contents in " Turning the Projector On/Off " section.
6		SOURCE	Press " SOURCE " to choose RGB, Component, S-Video, Composite, SCART, HDTV and HDMI™ sources.
7		TEMP	Temp Indicator LED
8	⬆️⬇️⬅️⬇️	Four directional select keys	Use to ⬆️⬇️⬅️⬇️ select items or make adjustments to your selection.
9	ENTER ▶️/⏸️	Enter/Play/Pause	Press "Enter/Play/Pause" to play/pause media file.
10		IR Receiver	Remote control receiver.

Remote Control Layout



#	Icon	Function	Description
1		Infrared transmitter	Sends signals to the projector.
2		Laser pointer	Aim the remote at the viewing screen.
3		POWER	Please see " Turning the Projector On/Off " section.
4		HIDE	Temporarily turns off the video. Press " HIDE " to hide the image, press again to display the image.
5		FREEZE	Pause the screen image.
6		MEDIA_SETUP	Press " MEDIA SETUP "/" SETUP " to enter media OSD setting.
7		SOURCE	Changes the active source.
8		3D	Press " 3D " to select 3D models.
9		ZOOM	Zooms the projector display in or out.
10		Back	Press " BACK " to go back one menu step.
11		Laser button	Aim the remote at the viewing screen, press and hold this button to activate the laser pointer. This function is not supported in Japanese market.
12		Enter	Press " ENTER " to play media file.
13		Four directional select keys	Use up, down, left, right buttons to select items or make adjustments to your selection.
14		KEYSTONE	Adjusts the image to compensate for distortion caused by tilting the projector (± 40 degrees).

#	Icon	Function	Description
15		MENU	<ul style="list-style-type: none"> Press "MENU" to launch the Onscreen display (OSD) menu, back to the previous step for the OSD menu operation or exit the OSD menu. Confirm your selection of items.
16		MOUSE_Left/ Right Click	Left-/right-click buttons are on the left and right, respectively; the center button works as a multidirectional pointer stick. To enable this function, a USB cable must be connected to projector from your PC.
17		MOUSE_Four directional select keys	
18		MODE	Press " MODE " to select the display mode.
19		VOLUME +/-	Increases/decreases the volume.
20		PAGE	For computer mode only. Use this button to select the next or previous page. This function is only available when connected to a computer via a USB cable.
21		Prev	Press " Prev " to go to previous index or page in file list view.
		Next	Press " Next " to go to next index or page in file list view.
		Play/Pause	Press " Play/Pause " to play/pause media file.
		Stop	Press " Stop " to stop playing media file.
22		VGA	Press " VGA " to change source to the VGA connector. This connector supports analog RGB, YPbPr (480p/576p/720p/1080i), YCbCr (480i/576i) and RGBsync.
23		S-VIDEO	To change source to S-Video.
24		INFO	Press " INFO " to display media information.
25		COMPONENT	Press " COMPONENT " to change source to Component video. This connection supports YPbPr (480p/576p/720p/1080i) and YCbCr (480i/576i).
26		VIDEO	To change source to COMPOSITE VIDEO.
27		SD/USB A	Press " SD/USB A " to change source to USB A. (no SD function)
28		USB B	Press " USB B " to change source to USB B.
29		HDMI™/DVI	Press " HDMI™/DVI " to change source to HDMI™ (no DVI function).
30		LAN/WiFi	Press " LAN/WiFi " to display the image which is wire or wirelessly transmitted from the PC to the projector via the " Acer LAN webpage management " utility. (Acer Projector Multimedia CD)
31		KeyPad 0~9	Press " 0-9 " to input a password in the " Security ".
32		ASPECT RATIO	Choose the desired aspect ratio.
33		RESYNC	Automatically synchronizes the projector to the input source.
34		MEDIA_HOME	Press " HOME " to return to the home page of media mode.



Note: Functions vary depending on model definition.

Getting Started

Connecting the Projector

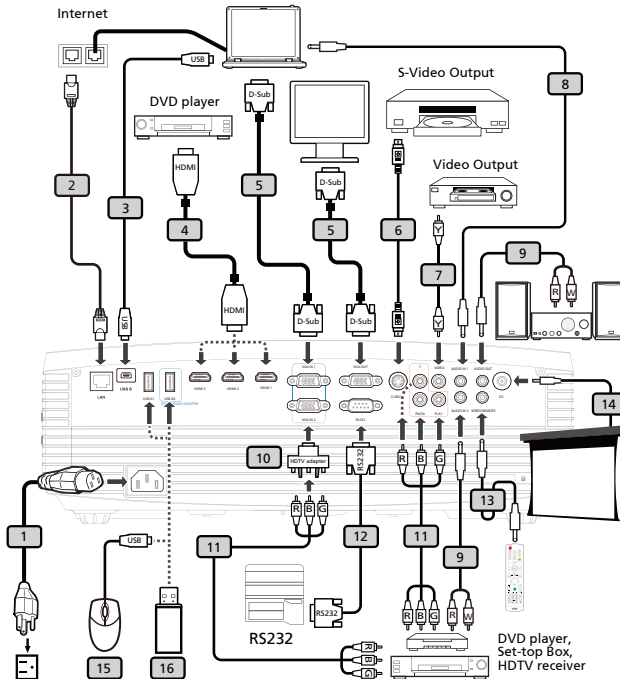

#	Description	#	Description
1	Power cord	9	Audio cable Jack/RCA
2	LAN cable	10	VGA to component/HDTV adapter
3	USB cable	11	3 RCA component cable
4	HDMI cable	12	RS232 cable
5	VGA cable	13	Audio cable jack for wired remote
6	S-Video cable	14	12V DC cable
7	Composite video cable	15	Mouse
8	Audio cable jack/jack	16 ^(*)	USB disk/stick USB WiFi adapter (for USB A2 only)



Note: To ensure the projector works well with your computer, please make sure the timing of the display mode is compatible with the projector.

Note: "*" USB drive limitation, do not support power consumption over 500mA. Please have external power for USB device.

Note: To enable wireless function, the USB wireless adapter must be plugged into the USB A2 port.

Note: Functions vary depending on model definition.

Turning the Projector On/Off

Turning on the Projector

- 1 Remove the lens cap.(Illustration #1)
- 2 Ensure that the power cord and signal cable are securely connected. The Power indicator LED will flash red.
- 3 Turn on the projector by pressing "**Power**" button on the control panel, and the Power indicator LED will turn blue.(Illustration #2)
- 4 Turn on your source (computer, notebook, video player ,etc.). The projector will detect your source automatically.
 - If the screen displays "Lock" and "Source" icons, it means the projector is locked onto a specific source type and there is no such type of input signal detected.
 - If the screen displays "No Signal", please make sure the signal cables are securely connected.
 - If you connect to multiple sources at the same time, use the "Source" button on either control panel or the remote control or direct source key on the remote control to switch between inputs.

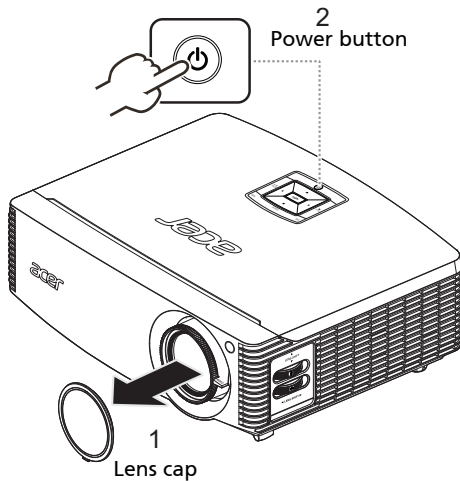

Turning the projector off

- 1 To turn the projector off, press the power button. This message appears: **"Please press the power button again to complete the shutdown process."** Press the power button again.
- 2 The LED power indicator will turn RED and blink rapidly after the projector is turned off, and the fan(s) will continue to operate for about 2 minutes to ensure that the system cools properly. (only supported under "Instant Resume" mode)
- 3 As long as the power cord remains plugged in, you can press the power button to turn the projector immediately back on anytime during the 2-minute shutdown process. (only supported under "Instant Resume" mode)
- 4 Once the system has finished cooling, the LED power indicator will stop blinking and turn solid red to indicate standby mode.
- 5 It is now safe to unplug the power cord.



Warning indicators:

- **"Please press the power button again to complete the shutdown process."**
This onscreen message indicates that the projector has overheated. The lamp will automatically turn off, the projector will automatically shut down, and the LED temp indicator will turn solid red. Contact your local dealer or service center.
- **"Fan failed. Lamp will automatically turn off soon."**
This onscreen message indicates that the fan has failed. The lamp will automatically turn off, the projector will automatically shut down, and the LED temp indicator will blink. Contact your local dealer or service center.



Note: Whenever the projector automatically shuts down and the LED lamp indicator turns solid red, contact your local reseller or service center.

Adjusting the Projected Image

Adjusting the Height of Projected Image

The projector is equipped with elevator feet for adjusting the height of image.

To raise/lower the image:

- 1 Raise the image to the desired height angle (Illustration #1), then pull out the stand feet into position.
- 2 Use Tilt adjusting wheel (Illustration #2) to fine-tune the display angle.
- 3 Use Lens shift control rings to move the image to the ideal position. (refer to page 20)

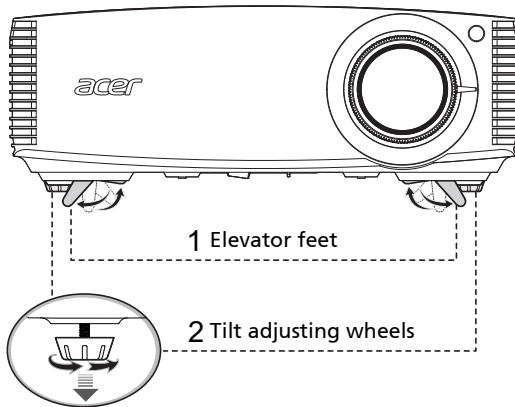

How to optimize image size and distance

Consult the table below to find the optimal image sizes achievable when the projector is positioned at a desired distance from the screen.

- WUXGA series

If the projector is 2.0 m from the screen, good image quality is possible for image sizes between 41" and 62".



Note: Remind as below figure, the space of 100 cm height is required when located at 2.0 m distance.

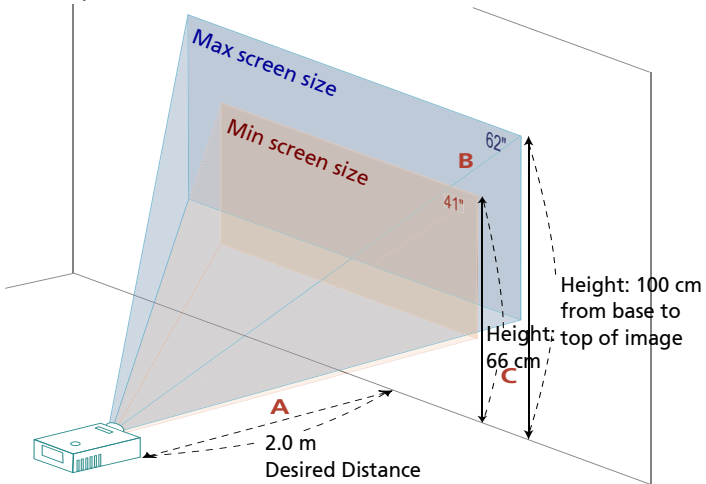

Desired Distance (m) <A>	Screen size		Top	Screen size		Top
	(Min zoom)			(Max zoom)		
	Diagonal (inch) 	W (cm) x H (cm)	From base to top of image (cm) <C>	Diagonal (inch) 	W (cm) x H (cm)	From base to top of image (cm) <C>
1.5	31	66 x 41	49	47	100 x 63	75
2	41	88 x 55	66	62	134 x 84	100
2.5	51	110 x 69	82	78	167 x 105	126
3	61	132 x 82	99	93	201 x 126	151
3.5	71	154 x 96	115	109	234 x 146	176
4	81	176 x 110	132	124	268 x 167	201
4.5	92	197 x 123	148	140	301 x 188	226
5	102	219 x 137	165	155	335 x 209	251
6	122	263 x 165	197	186	402 x 251	301
7	143	307 x 192	230	218	469 x 293	351
8	163	351 x 219	263	249	535 x 335	402
9	183	395 x 247	296	280	602 x 377	452
10	204	439 x 274	329	311	669 x 418	502
11	224	483 x 302	362	342	736 x 460	552
12	244	527 x 329	395	373	803 x 502	602

Zoom Ratio: 1.5x

- 1080p series

If the projector is 2.0 m from the screen, good image quality is possible for image sizes between 40" and 60".



Note: Remind as below figure, the space of 98 cm height is required when located at 2.0 m distance.

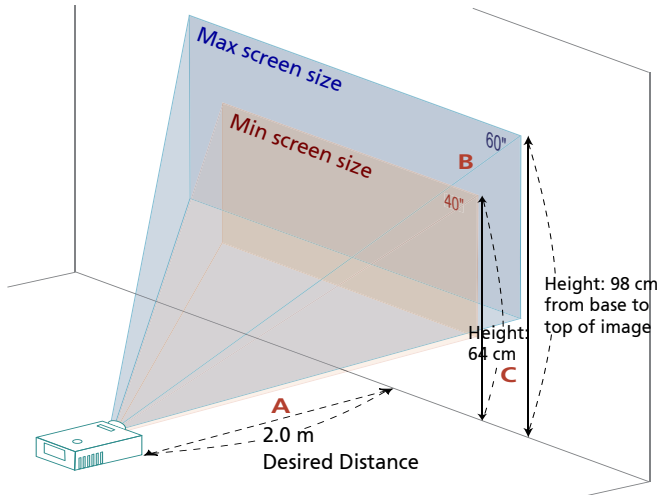

Desired Distance (m) <A>	Screen size		Top	Screen size		Top
	(Min zoom)			(Max zoom)		
	Diagonal (inch) 	W (cm) x H (cm)	From base to top of image (cm) <C>	Diagonal (inch) 	W (cm) x H (cm)	From base to top of image (cm) <C>
1.5	30	66 x 37	48	45	110 x 56	73
2	40	88 x 49	64	60	134 x 75	98
2.5	50	110 x 62	80	76	167 x 94	122
3	59	132 x 74	96	91	201 x 113	147
3.5	69	154 x 86	112	106	234 x 132	171
4	79	176 x 99	128	121	268 x 151	196
4.5	89	197 x 111	144	136	301 x 169	220
5	99	219 x 123	160	151	335 x 188	245
6	119	263 x 148	193	181	402 x 226	294
7	139	307 x 173	225	212	469 x 264	343
8	159	351 x 197	257	242	535 x 301	392
9	178	395 x 222	289	272	602 x 339	441
10	198	439 x 247	321	302	669 x 377	489
11	218	483 x 272	353	333	736 x 414	538
12	238	527 x 296	385	363	803 x 452	587

Zoom Ratio: 1.5x

• WXGA series

If the projector is 2.0 m from the screen, good image quality is possible for image sizes between 39" and 59".



Note: Remind as below figure, the space of 104 cm height is required when located at 2.0 m distance.

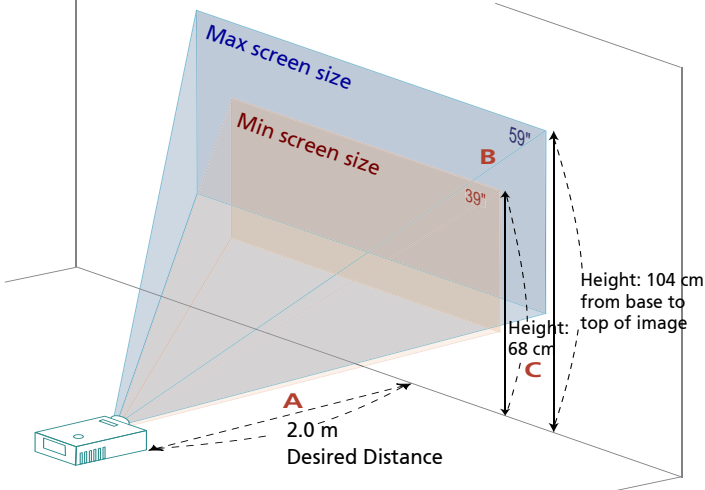

Desired Distance (m) <A>	Screen size			Screen size		
	(Min zoom)			(Max zoom)		
	Diagonal (inch) 	W (cm) x H (cm)	From base to top of image (cm) <C>	Diagonal (inch) 	W (cm) x H (cm)	From base to top of image (cm) <C>
1.5	29	63 x 39	51	44	96 x 60	78
2	39	84 x 52	68	59	127 x 80	104
2.5	49	105 x 65	85	74	159 x 100	129
3	58	125 x 78	102	89	191 x 120	155
3.5	68	146 x 91	119	104	223 x 139	181
4	78	167 x 105	136	118	255 x 159	207
4.5	87	188 x 118	153	133	287 x 179	233
5	97	209 x 131	170	148	319 x 199	259
6	117	251 x 157	204	178	382 x 239	311
7	136	293 x 183	238	207	446 x 279	362
8	155	334 x 209	272	237	510 x 319	414
9	175	376 x 235	306	266	574 x 359	466
10	194	418 x 261	340	296	637 x 398	518
11	214	460 x 287	374	325	701 x 438	570
12	233	502 x 314	408	355	765 x 478	621

Zoom Ratio: 1.5x

How to get a preferred image size by adjusting distance and zoom

The table below shows how to achieve a desired image size by adjusting either the position or the zoom ring.

- WUXGA series

To obtain an image size of 60" set the projector at a distance 1.9 m and 2.9 m from the screen.

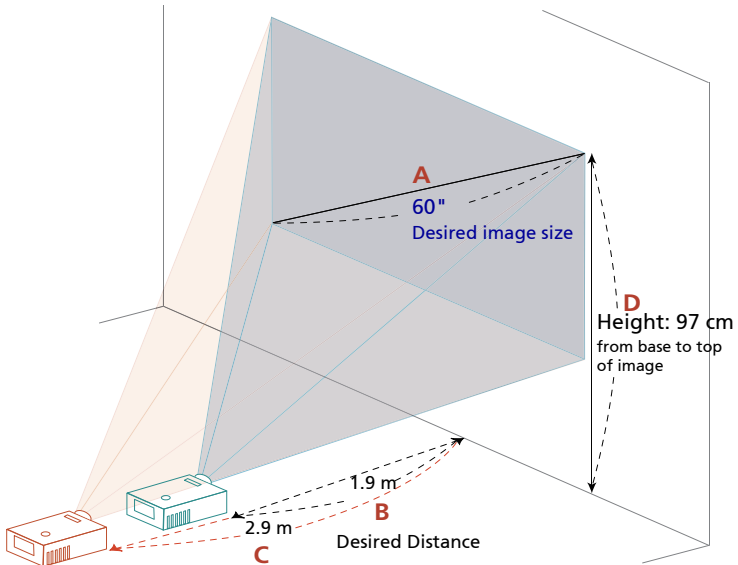

Desired Image Size		Distance (m)		Top (cm)
Diagonal (inch) <A>	W (cm) x H (cm)	Max zoom 	Min zoom <C>	From base to top of image <D>
30	65 x 40	1.0	1.5	48
40	86 x 54	1.3	2.0	65
50	108 x 67	1.6	2.5	81
60	129 x 81	1.9	2.9	97
70	151 x 94	2.3	3.4	113
80	172 x 108	2.6	3.9	129
90	194 x 121	2.9	4.4	145
100	215 x 135	3.2	4.9	162
120	258 x 162	3.9	5.9	194
150	323 x 202	4.8	7.4	242
180	388 x 242	5.8	8.8	291
200	431 x 269	6.4	9.8	323
250	538 x 337	8.0	12.3	404
300	646 x 404	9.7		485

Zoom Ratio: 1.5x

- 1080p series

To obtain an image size of 60" set the projector at a distance 2.0 m and 3.0 m from the screen.

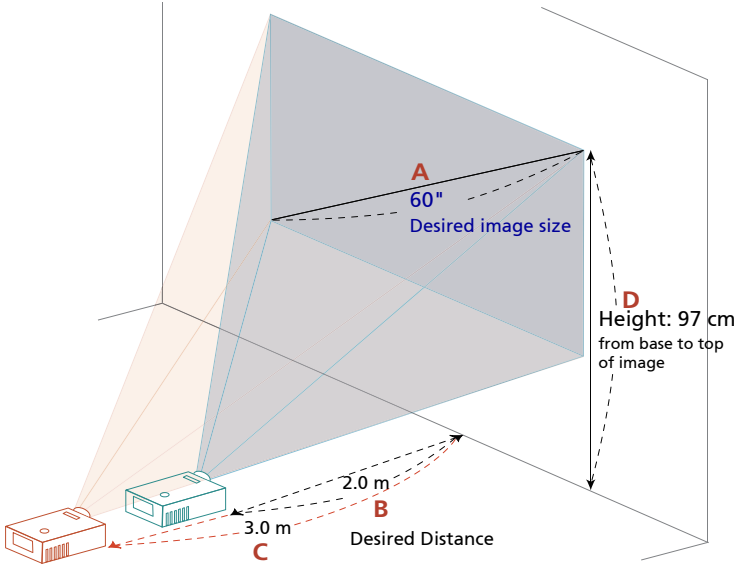

Desired Image Size		Distance (m)		Top (cm)
Diagonal (inch) <A>	W (cm) x H (cm)	Max zoom 	Min zoom <C>	From base to top of image <D>
30	66 x 37	1.0	1.5	49
40	89 x 50	1.3	2.0	65
50	111 x 62	1.7	2.5	81
60	133 x 75	2.0	3.0	97
70	155 x 87	2.3	3.5	113
80	177 x 100	2.6	4.0	130
90	199 x 112	3.0	4.5	146
100	221 x 125	3.3	5.0	162
120	266 x 149	4.0	6.1	194
150	332 x 187	5.0	7.6	243
180	398 x 224	6.0	9.1	291
200	443 x 249	6.6	10.1	324
250	553 x 311	8.3	12.6	405
300	664 x 374	9.9	***	486

Zoom Ratio: 1.5x

- WXGA series

To obtain an image size of 60" set the projector at a distance 2.0 m and 3.1 m from the screen.

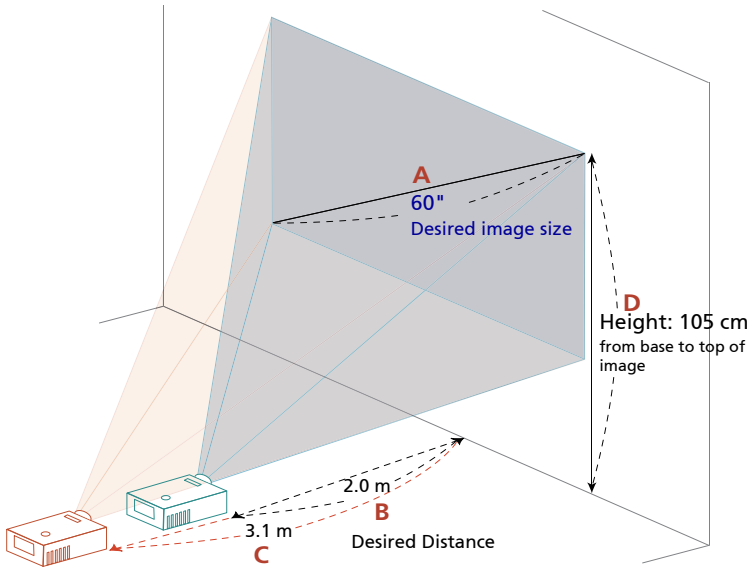

Desired Image Size		Distance (m)		Top (cm)
Diagonal (inch) <A>	W (cm) x H (cm)	Max zoom 	Min zoom <C>	From base to top of image <D>
30	65 x 40	1.0	1.5	53
40	86 x 54	1.4	2.1	70
50	108 x 67	1.7	2.6	88
60	129 x 81	2.0	3.1	105
70	151 x 94	2.4	3.6	123
80	172 x 108	2.7	4.1	140
90	194 x 121	3.0	4.6	158
100	215 x 135	3.4	5.2	175
120	258 x 162	4.1	6.2	210
150	323 x 202	5.1	7.7	263
180	388 x 242	6.1	9.3	315
200	431 x 269	6.8	10.3	350
250	538 x 337	8.4	12.9	438
300	646 x 404	10.1	***	525

Zoom Ratio: 1.5x

How to get a preferred image position by adjusting lens shift

The projector is equipped with lens shift for adjusting the position of projected image right and left or up and down without requiring you to physically move the projector.

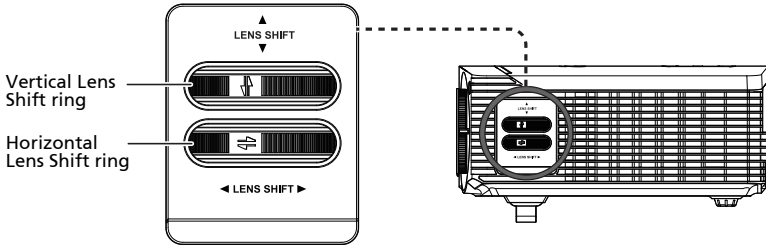

Note: The figures shown in this section are for reference only not approximate value. The figures between units can be different due to assembly tolerance.

Adjusting the horizontal or vertical image position

- WUXGA series

The vertical image height can be adjusted 20% of the image height.

With the lens in the centre position the horizontal image position can be adjusted to the left or right by up to a maximum of 15% of the image width.

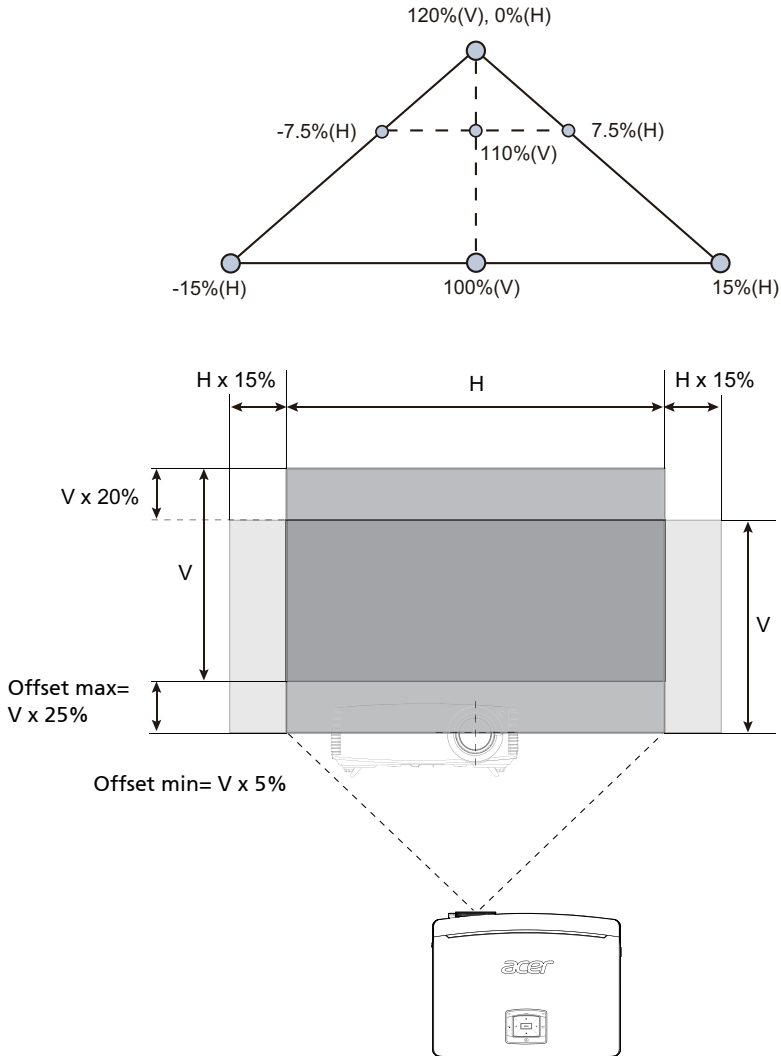

- WXGA/1080p series

The vertical image height can be adjusted between 5% and 30% of the image height. (The minimum vertical image offset is fixed at 5% of the image height above the centre of the projector lens.)

With the lens in the centre position the horizontal image position can be adjusted to the left or right by up to a maximum of 15% of the image width.

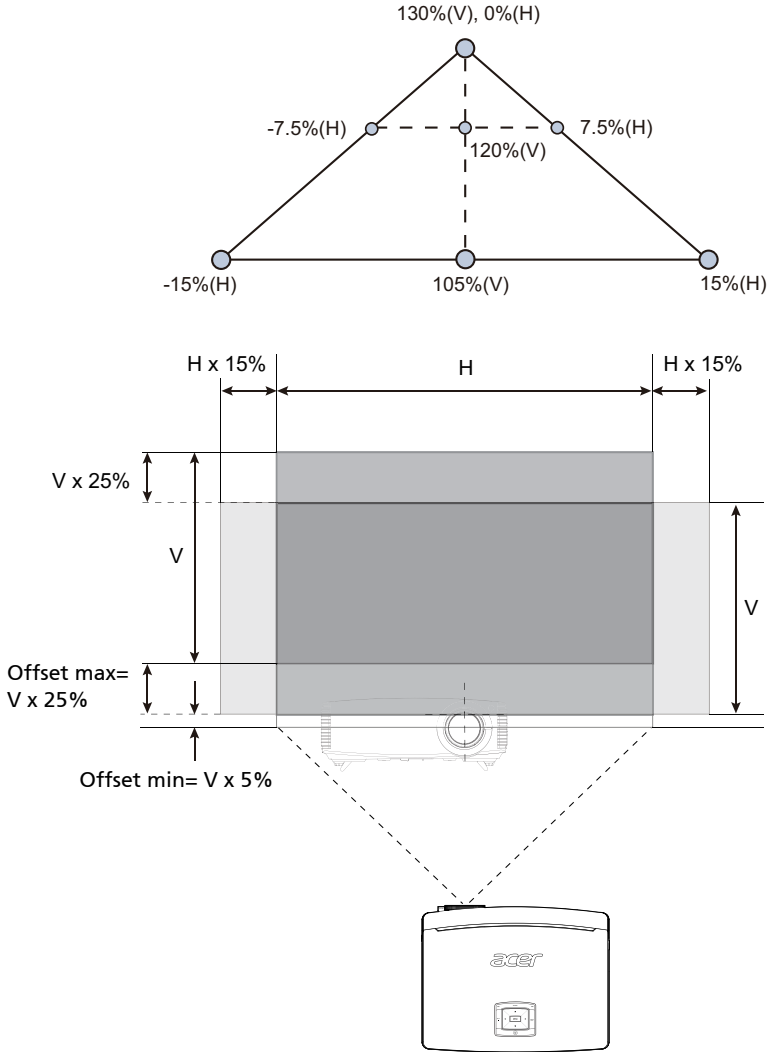

User Controls

Installation menu

The installation menu provides an onscreen display (OSD) for projector installation and maintenance. Use the OSD only when the message "No signal input" is displayed on the screen.

The menu options include settings and adjustments for screen size and distance, focus, keystone correction and more .

- 1 Turn on the projector by pressing "**Power**" button on the control pad.
- 2 Press the "**MENU**" button on the control pad to launch the OSD for projector installation and maintenance.

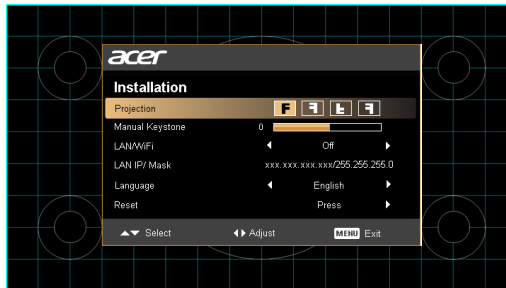

- 3 The background pattern acts as a guide to adjusting the calibration and alignment settings, such as screen size and distance, focus and more .
- 4 The Installation menu includes the following options:

- Projection method
- Manual Keystone settings
- LAN/WiFi settings
- LAN IP/ Mask settings
- Language settings
- Reset to factory default function

Use the up and down arrow keys to select an option, the left and right arrow keys to adjust selected option settings, and the right arrow key to enter a submenu for feature setting. The new settings will be saved automatically upon exiting the menu.

- 5 Push the menu button anytime to exit the menu and return to the Acer welcome screen.









.....

Note: Functions vary depending on model definition.

Onscreen Display (OSD) Menus

The projector has multilingual OSD that allow you to make image adjustments and change a variety of settings.

Using the OSD menus

- To open the OSD menu, press **"MENU"** on the remote control or control panel.
- When the OSD is displayed, use the   keys to select any item in the main menu. After selecting the desired main menu item, press  to enter submenu for feature setting.
- Use the   keys to select the desired item and adjust the settings by using the   keys.
- Select the next item to be adjusted in the submenu and adjust as described above.
- Press **"MENU"** on the remote control or control panel, the screen will return to the main menu.
- To exit OSD, press **"MENU"** on the remote control or control panel again. The OSD menu will close and the projector will automatically save the new settings.

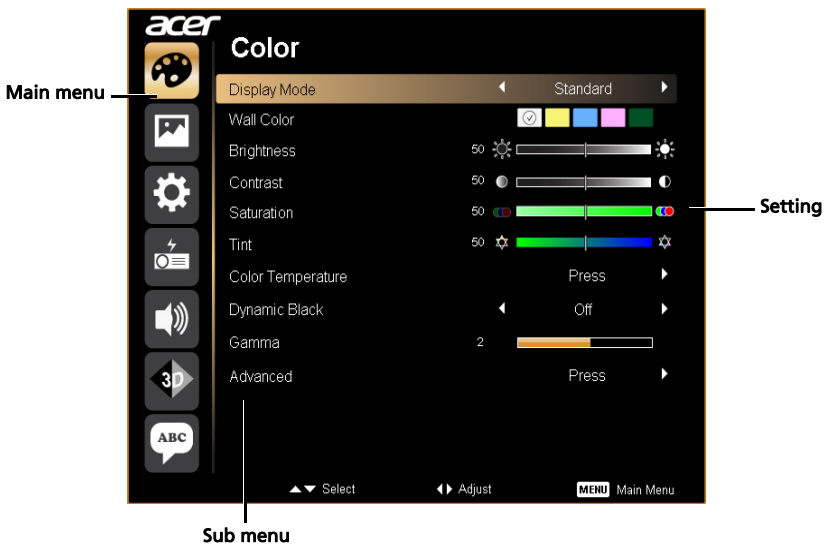

Note: Some of the following OSD settings may not be available. Please refer to the actual OSD of your projector.

Note: Functions vary depending on model definition.

Color

Display Mode	<p>There are many factory presets optimized for various types of images.</p> <ul style="list-style-type: none"> • Bright: For brightness optimization. • Presentation: For meeting presentation. • Standard: For common environment. • Video: For playing video in a bright environment. • Movie: For brighter and general movie/video/photo playing. • Dark Cinema: For dark movie content. • Game: For game content. • Sports: For sport picture. • User: Memorize user's settings.
Wall color	<p>Use this function to choose a proper color according to the wall. There are several choices, including white, light yellow, light blue, pink, dark green. It will compensate the color deviation due to the wall color to show the correct image tone.</p>
Brightness	<p>Adjust the brightness of the image.</p> <ul style="list-style-type: none"> • Press ◀ to darken the image. • Press ▶ to lighten the image.
Contrast	<p>"Contrast" controls the difference between the lightest and darkest parts of the picture. Adjusting the contrast changes the amount of black and white in the image.</p> <ul style="list-style-type: none"> • Press ◀ to decrease the contrast. • Press ▶ to increase the contrast.
Saturation	<p>Adjusts a video image from black and white to fully saturated color.</p> <ul style="list-style-type: none"> • Press ◀ to decrease the amount of color in the image. • Press ▶ to increase the amount of color in the image.
Tint	<p>Adjusts the color balance of red and green.</p> <ul style="list-style-type: none"> • Press ◀ to increase the amount of green in the image. • Press ▶ to increase the amount of red in the image.
Color Temperature	<p>Mode Use this function to choose CT1, CT2 (Native), CT3, User mode.</p>
	<p>R Gain Adjusts the red gain for color temperature optimization.</p>
	<p>G Gain Adjusts the green gain for color temperature optimization.</p>
	<p>B Gain Adjusts the blue gain for color temperature optimization.</p>
Dynamic Black	<p>Choose "On" to automatically optimize the display of dark movie scenes enabling them to be shown in incredible detail.</p>
Gamma	<p>Effects the representation of dark scenery. With greater gamma value, dark scenery looks brighter.</p>











Advanced	Ind. Color Management Adjusts the red, green, blue, cyan, yellow and magenta colors.
	Ind. Hue Adjusts the color balance of red and green.
	Ind. Saturation Adjusts the selected color to be less or more saturated color.
	Ind. Gain Adjusts the selected color's contrast.
	Brilliant Color Produces an expanded on-screen color spectrum that delivers enhanced color saturation for bright, true-to-life images.
	White Peaking Increases the brightness of whites that are near 100%. (video sources only)
	Film Mode Sets the image optimized to 24-frame True Film mode.
	Noise Reduction Adjusts signal noise reduction. "0" means the noise reduction is off, ">0" increase noise reduction.
	Black Extension This ensures optimum black level for each analog source.



Note: "Saturation" and "Tint" functions are not supported under computer or HDMI mode.

Note: Functions vary depending on model definition.

Image

Projection	<ul style="list-style-type: none"> •  Front-Desktop: The factory default setting. •  Rear-Desktop: When you select this function, the projector reverses the image so you can project from behind a translucent screen. •  Rear-Ceiling: When you select this function, the projector reverses and inverts the image at same time. You can project from behind a translucent screen with ceiling mounted projection. •  Front-Ceiling: When you select this function, the projector inverts the image for ceiling-mounted projection.
Aspect Ratio	<p>Use this function to choose your desired aspect ratio.</p> <ul style="list-style-type: none"> • Auto: Keep the image with original width-high ratio and maximize the image to fit native horizontal or vertical pixels. • Full: Resize image to fit full screen by width (1280 pixels) and height (800 pixels). • 4:3: The image will be scaled to fit the screen and displayed using a 4:3 ratio. • 16:9: The image will be scaled to fit the width of the screen and the height adjusted to display the image using a 16:9 ratio. • L.Box: Keep original signal aspect ratio and zoom in by 1.333 times.
Manual Keystone	<p>Adjust image distortion caused by tilting projection. (±40 degrees)</p> <div style="text-align: center;">  </div> <p><Note> The Manual Keystone function is unavailable under Auto Keystone setting to "On".</p>
Sharpness	<p>Adjusts the sharpness of the image.</p> <ul style="list-style-type: none"> • Press  to decrease the sharpness. • Press  to increase the sharpness.
H. Position	<ul style="list-style-type: none"> • Press  to move the image left. • Press  to move the image right.
V. Position	<ul style="list-style-type: none"> • Press  to move the image down. • Press  to move the image up.
Frequency	<p>"Frequency" changes the projector's refresh rate to match the frequency of your computer's graphics card. If you can see a vertical flickering bar in the projected image, use this function to make the necessary adjustments.</p>
Tracking	<p>Synchronizes the signal timing of the projector with the graphics card. If you experience an unstable or flickering image, use this function to correct it.</p>

HDMI Color Range	Adjust the color range of the HDMI image data to correct color display error. <ul style="list-style-type: none"> • Auto: Automatically adjust by information from player. • Limited Range: Process the input image as limited color range data. • Full Range: Process the input image as full color range data.
HDMI Scan Info	Adjust the overscan ratio of the HDMI image on screen. <ul style="list-style-type: none"> • Auto: Automatically adjust by information from player. • Underscan: Always no overscan on HDMI image. • Overscan: Always keep overscan on HDMI image.



.....







Note: "H. Position", "V. Position", "Frequency" and "Tracking" functions are not supported under HDMI or Video mode.

Note: "HDMI Color Range" and "HDMI Scan Info" functions are only supported under HDMI mode.

Note: Functions vary depending on model definition.

Setting

Startup Screen	<p>Use this function to select your desired startup screen. If you change the setting, the changes will take effect when you exit the OSD menu.</p> <ul style="list-style-type: none"> • Acer: The default startup screen of your Acer projector. • User: Use memorize picture from "Screen Capture" function.
Screen Capture	<p>Use this function to customize the startup screen. To capture the image that you want to use as the startup screen, follow the instructions below.</p> <p>Notice:</p> <p>Before proceeding with the following steps, make sure that the "Keystone" is set to the default value 0 and the aspect ratio is set to 4:3. For details, refer to the "Image" section.</p> <ul style="list-style-type: none"> • Change the "Startup Screen" from the default setting "Acer" to "User". • Press "Screen Capture" to customize the startup screen. • A dialog box appears to confirm the action. Choose "Yes" to use the current image as your customized startup screen. The capture range is the red rectangular area. Choose "No" to cancel the screen capture and exit the onscreen display (OSD). • A message appears, stating that the screen capture is in progress. • When the screen capture is finished, the message disappears and the original display is shown. • The customized startup screen, as shown below, takes effect when there is a new input signal or when you restart the projector.
Source Lock	<p>When source lock is turned "off", the projector will search for other signals if the current input signal is lost. When source lock is turned "on", it will "lock" the current source channel unless you press "Source" button on the remote control for the next channel.</p>
Closed Caption	<p>Selects a preferred closed captioning mode from CC1, CC2, CC3, CC4, (CC1 displays captions in the primary language in your area). Select "Off" to turn off the captioning feature. This function is only available when a composite video or S-Video input signal is selected and its system format is NTSC.</p> <p><Note> Set your screen aspect ratio to 4:3. This function is not available when the aspect ratio is "16:9" or "Auto" .</p>
Auto Screen	<p>Default is "On", the down/up move of electronic screen will be related with power on/off of Projector.</p>
VGA OUT (Standby)	<p>Default is "Off". Choose "On" to enable VGA OUT connection.</p>
LAN/WiFi	<p>LAN/WiFi Default is "Off". Choose "On" to enable LAN connection. <Note> If users want to do LAN control under standby mode, change VGA OUT (Standby) from Off to On.</p>
	<p>LAN IP/ Mask Identify IP and Mask address.</p>
	<p>LAN Reset Reset LAN function.</p>
Reset	<ul style="list-style-type: none"> • Press the  button and choose "Yes" to return the parameters on all menus to the factory default settings.

Security	<p>Security This projector provides a useful security function for the administrator to manage usage of the projector .</p> <p>Press  to change the "Security" setting. If the security function is enabled, you must enter the "Administrator Password" first before changing the security settings.</p> <ul style="list-style-type: none"> • Select "On" to enable the security function. The user has to enter a password to operate the projector. Please refer to the "User Password" section for details. • If "Off" is selected, then the user can turn on the projector without password.
	<p>Timeout(Min.) Once "Security" is activated to "On", the administrator can set timeout function.</p> <ul style="list-style-type: none"> • Press  or  to select the timeout interval. • The range is from 10 minute to 990 minutes. • When the time is up, the projector will prompt the user to enter the password again. • The factory default setting of "Timeout(Min.)" is "Off". • Once the security function is enabled, the projector will request user to enter password when switch on the projector . Both "User Password" and "Administrator Password" can be accepted for this dialogue.
	<p>User Password</p> <ul style="list-style-type: none"> • Press  to setup or change the "User Password". • Press number keys to set your password on the remote control and press "MENU" to confirm. • Press  to delete character. • Enter the password when you see "Confirm Password" displayed. • The password should be between 4 and 8 characters long. • If you select "Request password only when plugging the power cord in.", the projector will prompt the user to enter the password every time the power cord is plugged. • If you select "Always request password while projector turns on.", the user has to enter the password every time when the projector is turned on.
	<p>Administrator Password The "Administrator Password" can be used in both the "Enter Administrator Password" and "Enter Password" dialog boxes.</p> <ul style="list-style-type: none"> • Press  to change the "Administrator Password". • The factory default of "Administrator Password" is "1234". <p>If you forgot your administrator password, do the following to retrieve the administrator password:</p> <ul style="list-style-type: none"> • An unique 6-digit "Universal Password" which is printed on the Security Card (please check accessory in the box). This unique password is the number which will be accepted by projector anytime no matter what the Administrator Password is. • If losing this security card and number, please contact with an Acer service center.

	<p>Lock to user startup screen Default Lock User Startup Screen is "Off". If lock user startup screen is "On", users cannot change startup screen anymore and avoid other users change that arbitrarily. Choose "Off" to unlock startup screen.</p>
--	--



Note: Functions vary depending on model definition.

Management



ECO Mode	Choose "On" to dim the projector lamp which will lower power consumption, extend the lamp life and reduce noise. Choose "Off" to return normal mode.
High Altitude	Choose "On" to turn on High Altitude mode. Operate the fans at full speed continuously to allow for proper high altitude cooling of the projector.
Turn Off Mode	Instant Off: Shuts down the projector without fan cooling. Instant Resume: Resumes the system when the Power button is pressed again within 2 minutes.
Timer	Start (or Stop) Press to start (or stop) the timer.
	Period Press ◀ or ▶ to adjust the timer period.
	Alarm Select this function to adjust the notification volume when the timer function is enabled and time is up.
	Timer Display Choose "On" or "Off" to which timer mode to display on the screen.
	Location Choose the location of the timer on the screen.
Auto Shutdown	The projector will automatically shutdown when there is no signal input after the allocated time. (default is 120 minutes)
Lamp Hour Elapse	Displays the lamp's elapsed operating time (in hours).
Lamp Reminding	Activate this function to display a reminder to change the lamp 30 hours before its expected end-of-life.
Lamp Hour Reset	Press the ▶ button and choose "Yes" to turn the lamp hour counter to 0 hours.



.....

Note: Functions vary depending on model definition.

Audio

Volume	<ul style="list-style-type: none"> • Press  to decrease the volume. • Press  to increase the volume.
Mute	<ul style="list-style-type: none"> • Choose "On" to mute the volume. • Choose "Off" to restore the volume.
Power On/Off Volume	Select this function to adjust the notification volume when turning the projector on/off.
Alarm Volume	Select this function to adjust the volume of any warning notifications.



.....

Note: Functions vary depending on model definition.

3D

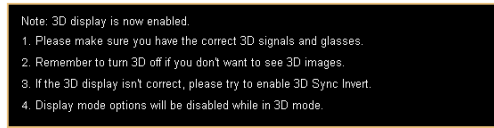
3D	<p>Choose "On" to enable DLP 3D function.</p> <ul style="list-style-type: none"> On: Choose this item while using DLP 3D glasses, 120Hz 3D capable graphics cards and HQFS format file or DVD with corresponding SW player. Off: Turn off 3D mode.
24P Boost	Choose "96Hz" or "144Hz" to compatible with 3D glasses.
2D to 3D	<p>2D to 3D Support most of the 2D contents. Choose "On" to enable 2D to 3D function supported by DLP 3D technology. Please use DLP 3D glasses to have correct performance.</p> <p>Mode Choose mode of "Photo", "Movie", "Jump-Out" and "User" as your preferred 3D setting.</p> <p>Convergence Choose convergence effect of "Inward", "Middle" and "Outward" as your preferred 3D setting in "User" mode.</p> <p>Depth Choose depth effect of "Low", "Middle" and "Strong" as your preferred 3D setting in "User" mode.</p>
3D Format	If the 3D content is not displayed correctly, you can select a 3D format that suits the 3D content you are viewing and obtain the best result.
3D L/R Invert	If you see a discrete or overlapping image while wearing DLP 3D glasses, you may need to execute "Invert" to get best match of left/right image sequence to get the correct image (for DLP 3D).
3D Warning Message	<p>Choose "On" to display the 3D warning message.</p>  <p>Note: 3D display is now enabled. 1. Please make sure you have the correct 3D signals and glasses. 2. Remember to turn 3D off if you don't want to see 3D images. 3. If the 3D display isn't correct, please try to enable 3D Sync Invert. 4. Display mode options will be disabled while in 3D mode.</p>



Note: It needs correct settings on graphic card 3D application program for correct 3D display.

Note: The SW players, such as Stereoscopic Player and DDD TriDef Media Player can support 3D format files. You can download these three players on web page below,

- Stereoscopic Player (Trial):

http://www.3dtv.at/Downloads/Index_en.aspx

- DDD TriDef Media Player (Trial):

<http://www.tridef.com/download/TriDef-3-D-Experience-4.0.2.html>



Note: "3D L/R Invert" is only available when 3D is enabled.

Note: There has reminder screen if 3D still enable when power on projector. Please adjust setting depended on your purpose.

Note: It will takes much time and some garbage screen might happen while switching between 2D mode, 3D mode and 2D to 3D mode.

Note: Functions vary depending on model definition.

Language

Language	<p>Choose the multilingual OSD menu. Use the  or  key to select your preferred menu language.</p> <ul style="list-style-type: none">• Press  to confirm the selection.
----------	---

Appendices

Troubleshooting

If you experience a problem with your Acer projector, refer to the following troubleshooting guide. If the problem persists, please contact your local reseller or service center.

Image Problems and Solutions

#	Problem	Solution
1	No image appears onscreen	<ul style="list-style-type: none"> • Connected as described in the "Getting Started" section. • Ensure none of the connector pins are bent or broken. • Check if the projector lamp has been securely installed. Please refer to the "Replacing the Lamp" section. • Make sure you have removed the lens cap and the projector is switched on.
2	Partial, scrolling or incorrectly displayed image (For PC (Windows 2000/XP/ Vista/Windows 7/ Windows 8))	<ul style="list-style-type: none"> • Press "RESYNC" on the remote control or control panel. • For an incorrectly displayed image: <ul style="list-style-type: none"> • Open "My Computer," open the "Control Panel," and then double-click the "Display" icon. • Select the "Settings" tab. • Verify that your display resolution setting is lower than or equal to UXGA (1600 x 1200). • Click the "Advanced Properties" button. <p>If the problem still appears, change the monitor display you are using and follow the steps below:</p> <ul style="list-style-type: none"> • Verify that the resolution setting is lower than or equal to UXGA (1600 x 1200). • Click the "Change" button under the "Monitor" tab. • Click "Show all devices". Next, select "Standard monitor types" under the SP box, and choose the resolution mode you need under the "Models" box. • Verify that the resolution setting of the monitor display is lower than or equal to UXGA (1600 x 1200).

3	Partial, scrolling or incorrectly displayed image (for notebooks)	<ul style="list-style-type: none"> • Press "RESYNC" on the remote control or control panel. • For an incorrectly displayed image: <ul style="list-style-type: none"> • Follow the steps for item 2 (above) to adjust the resolution of your computer. • Press the toggle output settings. Example: [Fn]+[F4], Compaq [Fn]+[F4], Dell [Fn]+[F8], Gateway [Fn]+[F4], IBM [Fn]+[F7], HP [Fn]+[F4], NEC [Fn]+[F3], Toshiba [Fn]+[F5] • If you experience difficulty changing resolutions or your monitor freezes, restart all equipment including the projector.
4	The screen of the notebook computer is not displaying your presentation	<ul style="list-style-type: none"> • If you are using a Microsoft® Windows® based notebook: Some notebook PCs may deactivate their own screens when a second display device is in use. Each has a different way to be reactivated. Refer to your computer's manual for detailed information. • If you are using an Apple® Mac® OS based notebook: In System Preferences, open Display and select Video Mirroring "On".
5	Image is unstable or flickering	<ul style="list-style-type: none"> • Adjust the "Tracking" to correct it. Refer to the "Image" section for more information. • Change the display color depth settings on your computer.
6	Image has vertical flickering bar	<ul style="list-style-type: none"> • Use "Frequency" to make an adjustment. Refer to the "Image" section for more information. • Check and reconfigure the display mode of your graphics card to make it compatible with the projector.
7	Image is out of focus	<ul style="list-style-type: none"> • Make sure the lens cap is removed. • Adjusts the focus ring on the projector lens. • Make sure the projection screen is within the required distance of 4.9 to 33.3 feet (1.5 to 10.1 meters) (WXGA series) / 4.9 to 32.6 feet (1.5 to 9.9 meters) (1080P series) / 4.9 to 31.7 feet (1.5 to 9.7 meters) (WUXGA series) from the projector. Refer to the "How to Get a Preferred Image Size by Adjusting Distance and Zoom" section for more information.

8	Image is stretched when displaying a "widescreen" DVD title	<p>When you play a DVD encoded in anamorphic or 16:9 aspect ratio you may need to adjust the following settings:</p> <ul style="list-style-type: none"> • If you play a 4:3 format DVD title, please change the format to 4:3 in the projector OSD. • If the image is still stretched, you will also need to adjust the aspect ratio. Set up the display format to 16:9 (wide) aspect ratio on your DVD player. • If you play an Letterbox (LBX) format DVD title, please change the format to Letterbox (LBX) in the projector OSD.
9	Image is too small or too large	<ul style="list-style-type: none"> • Adjust the zoom ring on the top of the projector. • Move the projector closer to or further from the screen. • Press "MENU" on the remote control or on the control panel. Go to "Image --> Aspect Ratio" and try different settings.
10	Image has slanted sides	<ul style="list-style-type: none"> • If possible, reposition the projector so that it is centered on the screen. • Press the "Keystone Δ / ∇" on the control panel or on the remote control until the sides are vertical. • Press the "Keystone" on the OSD until the sides are vertical.
11	Image is reversed	<ul style="list-style-type: none"> • Select "Image --> Projection" on the OSD and adjust the projection direction.

Problems with the Projector

#	Condition	Solution
1	The projector stops responding to all controls	If possible, turn off the projector, then unplug the power cord and wait at least 30 seconds before reconnecting power.
2	Lamp burns out or makes a popping sound	When the lamp reaches the end of its useful life, it will burn out and may make a loud popping sound. If this happens, the projector will not turn on until the lamp module has been replaced. To replace the lamp, follow the procedures in the "Replacing the Lamp" section.

OSD Messages

#	Condition	Message Reminder
1	Message	<ul style="list-style-type: none"> <li data-bbox="369 280 736 304">• Fan Fail - the system fan is not working. <div data-bbox="363 304 915 384" style="background-color: black; color: white; padding: 5px; text-align: center;"> <p data-bbox="598 320 663 341">Fan Fail.</p> <p data-bbox="494 344 773 365">Lamp will automatically turn off soon.</p> </div> <ul style="list-style-type: none"> <li data-bbox="369 411 904 496">• Projector Overheated - the projector has exceeded its recommended operating temperature and must be allowed to cool down before it may be used. Please check the following message. <div data-bbox="363 507 915 643" style="background-color: black; color: white; padding: 5px;"> <p data-bbox="380 515 787 536">Projector overheated, system will turn off automatically soon, please:</p> <ol style="list-style-type: none"> <li data-bbox="385 539 834 560">1. Check if operation ambient temperature between 5 degree and 40 degree. <li data-bbox="385 563 604 584">2. Check if filter needs to be cleaned. <li data-bbox="385 587 598 608">3. Check if inlet or outlet is blocked. <li data-bbox="385 611 896 632">4. Check if high altitude mode is set when the projector operating at high altitude area. </div> <p data-bbox="369 651 899 711">Please also check the dust filters if they are installed. If the dust filter is clogged with dust, please clean it. Please refer to "Cleaning and replacing the dust filter" for details.</p> <ul style="list-style-type: none"> <li data-bbox="369 743 899 788">• Replace the lamp - the lamp is about to reach its maximum lifetime. Prepare to replace it soon. <div data-bbox="363 788 915 855" style="background-color: black; color: white; padding: 5px; text-align: center;"> <p data-bbox="380 799 877 820">Lamp is approaching the end of its useful life in full power operation.</p> <p data-bbox="543 823 725 844">Replacement suggested!</p> </div>

LED & Alarm Definition Listing

LED Messages

Message	Lamp LED	Temp LED	Power LED	
	Red	Red	Red	Blue
Standby (power cord plugged in)	--	--	V	--
Power button ON	--	--	--	V
Lamp retry	--	--	--	Quick flashing
Turning off (cooling state)	--	--	Quick flashing	--
Turning off (cooling completed)	--	--	V	--
Error (thermal failure)	--	V	--	V
Error (fan lock failure)	--	Quick flashing	--	V
Error (lamp breakdown)	V	--	--	V
Error (color Wheel fail)	Quick flashing	--	--	V

Cleaning and replacing the dust filters

Cleaning the dust filters

Clean the dust filters after every 1000 hours of use. If they are not cleaned periodically, they can become clogged with dust, preventing proper ventilation. This can cause overheating and damage the projector.

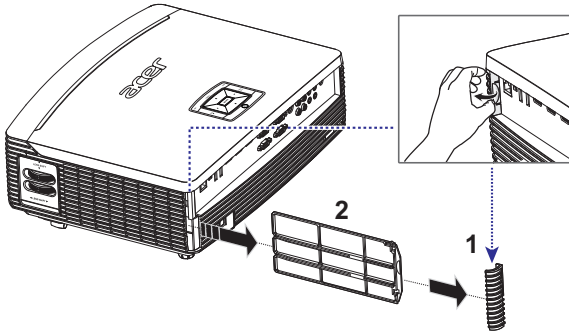

Follow these steps:

- 1 Turn the projector off. Wait for the Power LED to stop flashing then unplug the power cord.
- 2 Allow the projector at least 30 mins to cool down.
- 3 Unplug the corner (Illustration #1)
- 4 Pull out the dust filter (Illustration #2)
- 5 To clean the dust filters, use a small vacuum cleaner designed for computers and other office equipment.
- 6 If the dirt is difficult to remove or the filter is broken, please contact your local dealer or service center to obtain a new filter.

Replacing the Lamp

Use a screwdriver to remove the screw(s) from the cover, and then pull out the lamp.

The projector will detect the lamp life. You will be shown a warning message "Lamp is approaching the end of its useful life in full power operation. Replacement suggested!" When you see this message, change the lamp as soon as possible. Make sure the projector has been cooling down for at least 30 minutes before changing the lamp.



Warning: The lamp compartment is hot! Allow it to cool down before changing the lamp.

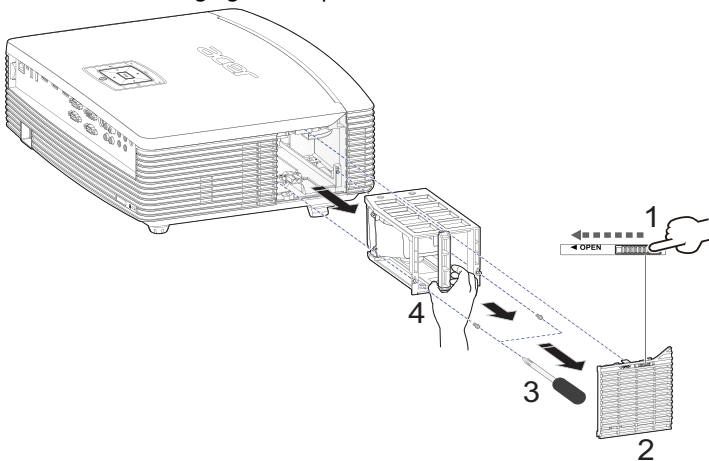

To Change the Lamp

- 1 Turn off the projector by pressing the power button.
- 2 Allow the projector at least 30 mins to cool down.
- 3 Disconnect the power cord.
- 4 Find the "OPEN" button on side of the projector and push it to open the cover. (Illustration #1)
- 5 Open the cover. (Illustration #2)
- 6 Remove the two screws that secure the lamp module.(Illustration #3)
- 7 Pull out the lamp module by force. (Illustration #4)

To replace the lamp module, reverse the previous step.



Warning: To reduce the risk of personal injury, do not drop the lamp module or touch the lamp bulb. The bulb may shatter and cause injury if it is dropped.

Ceiling Mount Installation

If you wish to install the projector using a ceiling mount, please refer to the steps below:

- 1 Drill four holes into a solid, structurally sound part of the ceiling, and secure the mount base.

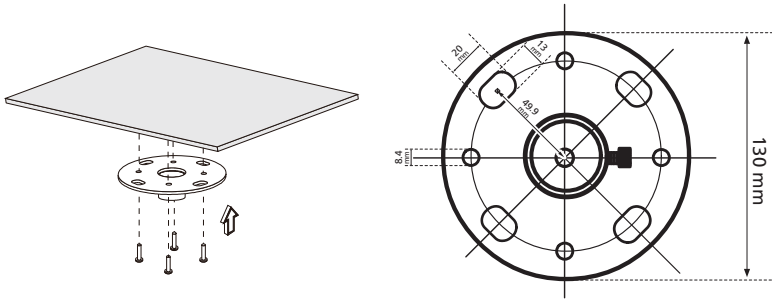

Note: Screws are not included. Please obtain the appropriate screws for your type of ceiling.

- 2 Secure the ceiling rod using the appropriate type of four-cylinder screws.

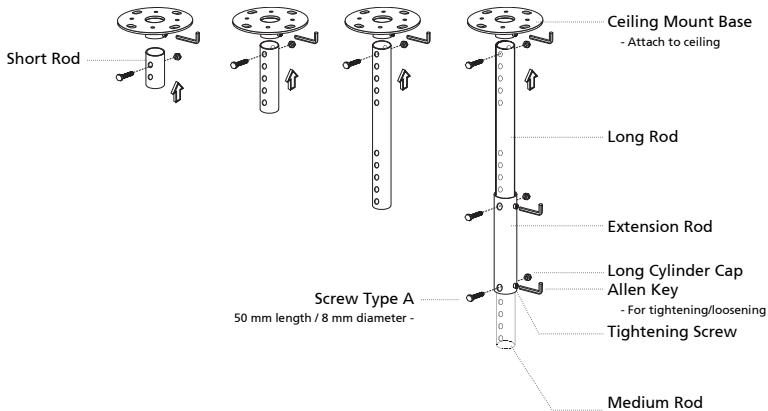

- 3 Use the appropriate number of screws for the projector size to attach the projector to the ceiling mount bracket.

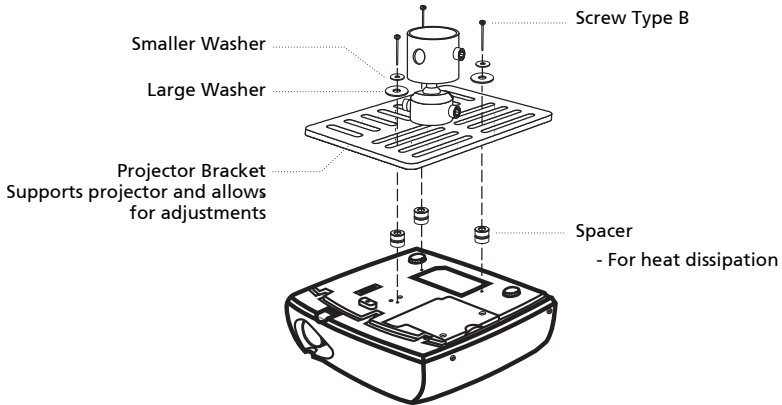

Note: It is recommended that you keep a reasonable space between the bracket and the projector to allow for proper heat distribution. Use two washers for extra support, if deemed necessary.

- 4 Attach the ceiling bracket to the ceiling rod.

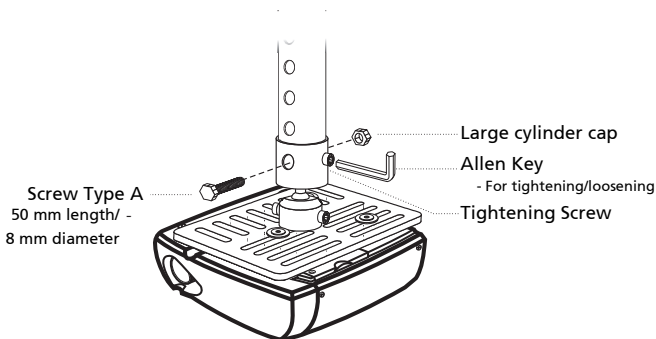

- 5 Adjust the angle and positioning as necessary.

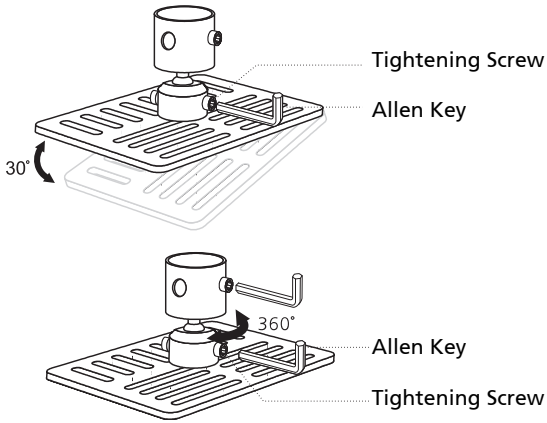

Note: The appropriate type of screw and washer for each model is listed in the table below. 4 mm diameter screws are enclosed in the screw pack.

Screw Type B		Washer Type	
Diameter (mm)	Length (mm)	Large	Small
4	25	V	V

SCREW SPEC. M4 x 25 mm

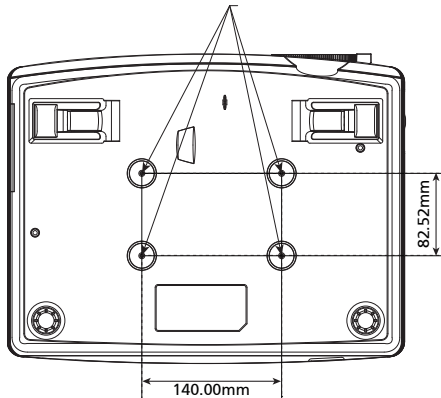

Specifications

The specifications listed below are subject to change without notice. For final specs, please refer to Acer's published marketing specifications.

Projection system	DLP®
Resolution	<ul style="list-style-type: none"> P7305W/F125/PF-W07 series: True 1280x800 WXGA resolution P7505/F155/PF-807/H9505BD/E255D/HE-822J series: True 1920x1080 1080p resolution P7605/F165/PF-WU07 series: True 1920x1200 WUXGA resolution Maximum: UXGA (1600 x 1200), WSXGA+ (1680x1050), 1080p (1920x1080), WUXGA-RB (1920 x 1200)
Computer compatibility	IBM PC and compatibles, Apple Macintosh, iMac and VESA standards: SXGA, XGA, VGA, SVGA, SXGA+, WXGA, WXGA+, WSXGA+
Video compatibility	NTSC (3.58/4.43), PAL (B/D/G/H/I/M/N), SECAM (B/D/G/K/K1/L), HDTV (720p, 1080i/p), EDTV (480p, 576p), SDTV (480i, 576i)
Aspect ratio	Full, 4:3, 16:9, L.Box
Displayable colors	1.07 billion colors
Projection lens	F = 2.45 ~ 2.9, f = 22.18mm ~ 33.27mm, 1:1.5 Manual Zoom and Manual Focus
Projection screen size (diagonal)	<ul style="list-style-type: none"> P7305W/F125/PF-W07 series: 29" (74 cm) ~ 300" (762 cm) P7505/F155/PF-807/H9505BD/E255D/HE-822J series: 30" (76cm) ~ 300" (762cm) P7605/F165/PF-WU07: 31" (78cm) ~ 300" (762cm)
Projection distance	<ul style="list-style-type: none"> P7305W/F125/PF-W07 series: 4.9' (1.5 m) ~ 33.3' (10.1 m) P7505/F155/PF-807/H9505BD/E255D/HE-822J series: 4.9' (1.5 m) ~ 32.6' (9.9 m) P7605/F165/PF-WU07 series: 4.9' (1.5m) ~ 31.7' (9.7m)
Throw ratio	<ul style="list-style-type: none"> P7305W/F125/PF-W07 series: 59" @2m (1.57 ~ 2.39:1) P7505/F155/PF-807/H9505BD/E255D/HE-822J series: 60" @2m (1.49 ~ 2.28:1) P7605/F165/PF-WU07 series: 62" @2m (1.49 ~ 2.28:1)
Horizontal scan rate	15k ~ 100kHz
Vertical refresh scan rate	24 ~ 120 Hz

Lamp type	<ul style="list-style-type: none"> • P7505/F155/PF-807/P7605/F165/PF-WU07/P7305W/F125/PF-W07 series: 370 W user-replaceable lamp • H9505BD/E255D/HE-822J series: 280 W user-replaceable lamp
Keystone correction	+/- 40 degrees
Audio	Internal speaker with 3 W x 2 output
Weight	7.5 kg (16.5 lbs.)
Dimensions (W x D x H)	398 mm x 310 mm x 140 mm (15.7" x 12.2" x 5.5")
Digital Zoom	2x
Power supply	AC input 100 - 240 V, 50 - 60 Hz
Power consumption	<ul style="list-style-type: none"> • P7505/F155/PF-807/P7605/F165/PF-WU07/P7305W/F125/PF-W07 series: Normal mode: 460W ± 10% @ 110VAC ECO mode: 350W ± 10% @ 110VAC Standby mode < 0.5W • H9505BD/E255D/HE-822J series: Normal mode: 337W ± 10% @ 110VAC ECO mode: 290W ± 10% @ 110VAC Standby mode < 0.5W
Operating temperature	0°C to 40°C / 32°F to 104°F
I/O connectors	<ul style="list-style-type: none"> • Power socket x1 • VGA input x2 • Composite input x1 • S-Video x1 • VGA output x1 • HDMI x3 • RS232 x1: 9-pin male connector for projector remote control • Mini USBx1: for firmware upgrade • USB A x2 • 3.5 mm audio jack input x2 • 3.5 mm audio jack output x1 • SPDIF RCA jack output x1 • 3 RCA Component video x1 • 3.5 mm jack input x1: for wired IR remote control • RJ45 x1 • DC Jack x1

Standard package contents

- AC power cord x1
 - VGA cable x1
 - Composite video cable x1
 - Remote control x1
 - Battery x 2 (for remote control) (option)
 - User's Guide (CD-ROM) x1
 - User's guide (CD-ROM) x1 (for multi-media and wireless functions)
 - Quick start guide x1
 - Quick start guide x1 (for multi-media and wireless functions)
 - Security card x1
 - Carrying case x1
 - Dust filter x1
-



.....

Note: Design and specifications are subject to change without notice.

Compatibility modes

A. VGA Analog

1 VGA Analog - PC Signal

Modes	Resolution	V.Frequency [Hz]	H.Frequency [KHz]
VGA	640x480	60	31.5
	640x480	72	37.9
	640x480	75	37.5
	640x480	85	43.3
	640x480	120	61.9
SVGA	800x600	56	35.1
	800x600	60	37.9
	800x600	72	48.1
	800x600	75	46.9
	800x600	85	53.7
XGA	800x600	120	77.4
	1024x768	60	48.4
	1024x768	70	56.5
	1024x768	75	60.0
	1024x768	85	68.7
SXGA	1024x768	120	99.0
	1152x864	70	63.8
	1152x864	75	67.5
	1152x864	85	77.1
	1280X1024	60	64.0
QuadVGA	1280X1024	72	77.0
	1280X1024	75	80.0
	1280X1024	85	91.1
	1280x960	60	60.0
	1280x960	75	75.2
SXGA+	1400x1050	60	65.3
UXGA	1600x1200	60	75.0
Power Mac G4	640x480	60	31.4
	640x480	66.6(67)	34.9
	800x600	60	37.9
	1024x768	60	48.4
	1152x870	75	68.7
i Mac DV (G3)	1280x960	75	75.0
	1024x768	75	60.0

2 VGA Analog - Extended Wide timing

Modes	Resolution	V.Frequency [Hz]	H.Frequency [KHz]
WXGA	1280x768	60	47.8
	1280x768	75	60.3
	1280x768	85	68.6
	1280x720	60	44.8
	1280x720	120	92.9
	1280x800	60	49.6
WSXGA+	1440x900	60	59.9
	1920x1200-RB	60	74.0
	1680x1050	60	65.3
	1920x1080-RB (1080P)	60	67.5
	1366x768	60	47.7

3 VGA Analog -Component Signal

Modes	Resolution	V.Frequency [Hz]	H.Frequency [KHz]
480i	720x480(1440x480)	59.94 (29.97)	15.7
576i	720x576(1440x576)	50(25)	15.6
480p	720x480	59.94	31.5
576p	720x576	50	31.3
720p	1280x720	60	45.0
720p	1280x720	50	37.5
1080i	1920x1080	60(30)	33.8
1080i	1920x1080	50(25)	28.1
1080p	1920x1080	23.97/24	27.0
1080p	1920x1080	60	67.5
1080p	1920x1080	50	56.3

B. HDMI Digital

1 HDMI - PC Signal

Modes	Resolution	V.Frequency [Hz]	H.Frequency [KHz]
VGA	640x480	60	31.5
	640x480	72	37.9
	640x480	75	37.5
	640x480	85	43.3
	640x480	120	61.9
SVGA	800x600	56	35.1

	800x600	60	37.9
	800x600	72	48.1
	800x600	75	46.9
	800x600	85	53.7
	800x600	120	77.4
XGA	1024x768	60	48.4
	1024x768	70	56.5
	1024x768	75	60.0
	1024x768	85	68.7
	1024x768	120	99.0
SXGA	1152x864	70	63.8
	1152x864	75	67.5
	1152x864	85	77.1
	1280x1024	60	64.0
	1280x1024	72	77.0
	1280x1024	75	80.0
	1280x1024	85	91.1
QuadVGA	1280x960	60	60.0
	1280x960	75	75.2
SXGA+	1400x1050	60	65.3
UXGA	1600x1200	60	75.0
Power Mac G4	640x480	60	31.4
	640x480	66.6(67)	34.9
	800x600	60	37.9
	1024x768	60	48.4
	1152x870	75	68.7
	1280x960	75	75.0
i Mac DV (G3)	1024x768	75	60.0

2 HDMI - Extended Wide timing

Modes	Resolution	V.Frequency [Hz]	H.Frequency [KHz]
WXGA	1280x768	60	47.8
	1280x768	75	60.3
	1280x768	85	68.6
	1280x720	60	44.8
	1280x720	120	92.9
	1280x800	60	49.6
	1440x900	60	59.9
	1920x1200-RB	60	74.0
WSXGA+	1680x1050	60	65.3
	1920x1080-RB (1080P)	60	67.5

	1366x768	60	47.7
--	----------	----	------

3 HDMI - Video Signal

Modes	Resolution	V.Frequency [Hz]	H.Frequency [KHz]
480i	720x480(1440x480)	59.94 (29.97)	15.7
576i	720x576(1440x576)	50(25)	15.6
480p	720x480	59.94	31.5
576p	720x576	50	31.3
720p	1280x720	60	45.0
720p	1280x720	50	37.5
1080i	1920x1080	60(30)	33.8
1080i	1920x1080	50(25)	28.1
1080p	1920x1080	23.97/24	27.0
1080p	1920x1080	60	67.5
1080p	1920x1080	50	56.3

4 HDMI - 1.4a 3D Timing

Modes	Resolution	V.Frequency [Hz]	H.Frequency [KHz]
720p (Frame Packing)	1280 x 720	50	37.5
720p (Frame Packing)	1280 x 720	60	45.0
1080p (Frame Packing)	1920 x1080	24	27.0
720p (Top and Bottom)	1280 x 720	50	37.5
720p (Top and Bottom)	1280 x 720	60	45.0
1080i (Top and Bottom)	1920 x1080	50 (25)	28.1
1080i (Top and Bottom)	1920 x1080	60 (30)	33.8
1080p (Top and Bottom)	1920 x1080	24	27.0
1080p (Top and Bottom)	1920 x1080	50	56.3
1080p (Top and Bottom)	1920 x1080	60	67.5
720p (Side by Side (Half))	1280 x 720	60	45.0
1080i (Side by Side (Half))	1920 x1080	50 (25)	28.1
1080i (Side by Side (Half))	1920 x1080	60 (30)	33.8
1080p (Side by Side (Half))	1920 x1080	50	56.3
1080p (Side by Side (Half))	1920 x1080	60	67.5
Graphic source monitor range limits	Horizontal scan rate:		15k-100kHz
	Vertical scan rate:		24-120 Hz
	Max. pixel rate:		Analog:165MHz Digital:165MHz

Regulations and safety notices

FCC notice

This device has been tested and found to comply with the limits for a Class B digital device pursuant to Part 15 of the FCC rules. These limits are designed to provide reasonable protection against harmful interference in a residential installation. This device generates, uses, and can radiate radio frequency energy and, if not installed and used in accordance with the instructions, may cause harmful interference to radio communications.

However, there is no guarantee that interference will not occur in a particular installation. If this device does cause harmful interference to radio or television reception, which can be determined by turning the device off and on, the user is encouraged to try to correct the interference by one or more of the following measures:

- Reorient or relocate the receiving antenna.
- Increase the separation between the device and receiver.
- Connect the device into an outlet on a circuit different from that to which the receiver is connected.
- Consult the dealer or an experienced radio/television technician for help.

Notice: Shielded cables

All connections to other computing devices must be made using shielded cables to maintain compliance with FCC regulations.

Notice: Peripheral devices

Only peripherals (input/output devices, terminals, printers, etc.) certified to comply with the Class B limits may be attached to this equipment. Operation with non-certified peripherals is likely to result in interference to radio and TV reception.

Caution

Changes or modifications not expressly approved by the manufacturer could void the user's authority, which is granted by the Federal Communications Commission, to operate this device.

Operation conditions

This device complies with Part 15 of the FCC Rules. Operation is subject to the following two conditions: (1) this device may not cause harmful interference, and (2) this device must accept any interference received, including interference that may cause undesired operation.

Notice: Canadian users

This Class B digital apparatus complies with Canadian ICES-003.

Remarque à l'intention des utilisateurs canadiens

Cet appareil numérique de la classe B est conforme à la norme NMB-003 du Canada.

Declaration of Conformity for EU countries

Acer hereby declares that this projector series is in compliance with the essential requirements and other relevant provisions of Directive 1999/5/EC.

Compliant with Russian regulatory certification



Radio device regulatory notice



Note: The regulatory information below is for models with wireless LAN and/or Bluetooth only.

General

This product complies with the radio frequency and safety standards of any country or region in which it has been approved for wireless use. Depending on configurations, this product may or may not contain wireless radio devices (such as wireless LAN and/or Bluetooth modules).

Canada — Low-power license-exempt radio communication devices (RSS-210)

- a Common information
 - Operation is subject to the following two conditions:
 1. This device may not cause interference, and
 2. This device must accept any interference, including interference that may cause undesired operation of the device.
- b Operation in 2.4 GHz band
 - To prevent radio interference to the licensed service, this device is intended to be operated indoors and installation outdoors is subject to licensing.

List of applicable countries

This device must be used in strict accordance with the regulations and constraints in the country of use. For further information, please contact the local office in the country of use. Please see <http://ec.europa.eu/enterprise/rte/implem.htm> for the latest country list.



Acer Incorporated
8F, 88, Sec. 1, Xintai 5th Rd., Xizhi
New Taipei City 221, Taiwan

Declaration of Conformity

We,

Acer Incorporated

8F, 88, Sec. 1, Xintai 5th Rd., Xizhi, New Taipei City 221, Taiwan

Contact Person: Mr. RU Jan, e-mail: ru.jan@acer.com

And,

Acer Italy s.r.l

Via Lepetit, 40, 20020 Lainate (MI) Italy

Tel: +39-02-939-921 ,Fax: +39-02 9399-2913

www.acer.it

Declare under our own responsibility that the product:

Product:	DLP Projector
Trade Name:	Acer
Model Number:	M1P1336/DWU1335/D1P1334/ DWX1333 P7505/F155/PF-807/P7605/F165/PF-WU07/H9505BD/ E255D/HE-822J/P7305W/F125/PF-W07

To which this declaration refers conforms to the relevant standard or other standardizing documents:

- EN55022:2010 Class B; EN 55024:2010
- EN61000-3-2:2006+A1:2009+A2:2009, Class A
- EN61000-3-3:2008
- EN 60950-1:2006/A11:2009/A1:2010+A12:2011
- Regulation (EC) No. 1275/ 2008; EN 62301:2005
- EN50581:2012

We hereby declare above product is in compliance with the essential requirements and other relevant provisions of EMC Directive 2004/108/EC, Low Voltage Directive 2006/95/EC and RoHS Directive 2011/65/EU and Directive 2009/125/EC with regard to establishing a framework for the setting of ecodesign requirements for energy-related product.

Year to begin affixing CE marking 2013.

**RU Jan / Sr. Manager
Regulation, Acer Inc.**

Nov. 1, 2013

Date



Acer America Corporation
333 West San Carlos St.,
Suite 1500
San Jose, CA 95110
U. S. A.
Tel: 254-298-4000
Fax: 254-298-4147
www.acer.com



Federal Communications Commission Declaration of Conformity

This device complies with Part 15 of the FCC Rules. Operation is subject to the following two conditions: (1) this device may not cause harmful interference, and (2) this device must accept any interference received, including interference that may cause undesired operation.

The following local Manufacturer / Importer is responsible for this declaration:

Product:	DLP Projector
Model Number:	MIP1336/DWU1335/D1P1334/ DWX1333
Machine Type:	P1183/M403/PE-S42/X1183A/D603P/EV-S62T/ P7505/F155/PF-807/P7605/F165/PF-WU07/ H9505BD/E255D/HE-822J/P7305W/F125/PF-W07
Name of Responsible Party:	Acer America Corporation
Address of Responsible Party:	333 West San Carlos St. Suite 1500 San Jose, CA 95110 U. S. A.
Contact Person:	Acer Representative
Phone No.:	254-298-4000
Fax No.:	254-298-4147

Free Manuals Download Website

<http://myh66.com>

<http://usermanuals.us>

<http://www.somanuals.com>

<http://www.4manuals.cc>

<http://www.manual-lib.com>

<http://www.404manual.com>

<http://www.luxmanual.com>

<http://aubethermostatmanual.com>

Golf course search by state

<http://golfingnear.com>

Email search by domain

<http://emailbydomain.com>

Auto manuals search

<http://auto.somanuals.com>

TV manuals search

<http://tv.somanuals.com>