

# Acer Projector

## K520/H112/PH-X01 Series User's Guide

Copyright © 2012. Acer Incorporated.  
All Rights Reserved.

Acer Projector K520/H112/PH-X01 Series User's Guide  
Original Issue: 03/2012

Changes may be made periodically to the information in this publication without obligation to notify any person of such revisions or changes. Such changes will be incorporated in new editions of this manual or supplementary documents and publications. This company makes no representations or warranties, either expressed or implied, with respect to the contents hereof and specifically disclaims the implied warranties of merchantability or fitness for a particular purpose.

Record the model number, serial number, purchase date and place of purchase information in the space provided below. The serial number and model number are recorded on the label affixed to your projector. All correspondence concerning your unit should include the serial number, model number and purchase information.

No part of this publication may be reproduced, stored in a retrieval system, or transmitted, in any form or by any means, electronically, mechanically, by photocopy, recording or otherwise, without the prior written permission of Acer Incorporated.

Acer Projector K520/H112/PH-X01 Series

Model number: \_\_\_\_\_

Serial number: \_\_\_\_\_

Date of purchase: \_\_\_\_\_

Place of purchase: \_\_\_\_\_

Acer and the Acer logo are registered trademarks of Acer Incorporated. Other companies' product names or trademarks are used herein for identification purposes only and belong to their respective companies.

"HDMI™, the HDMI logo and High-Definition Multimedia Interface are trademarks or registered trademarks of HDMI Licensing LLC."

# Information for your safety and comfort

Read these instructions carefully. Keep this document for future reference. Follow all warnings and instructions marked on the product.

## Turning the product off before cleaning

Unplug this product from the wall outlet before cleaning. Do not use liquid cleaners or aerosol cleaners. Use a damp cloth for cleaning.

## Caution for plug as disconnecting device

Observe the following guidelines when connecting and disconnecting power to the external power supply unit:

- Install the power supply unit before connecting the power cord to the AC power outlet.
- Unplug the power cord before removing the power supply unit from the projector.
- If the system has multiple sources of power, disconnect power from the system by unplugging all power cords from the power supplies.

## Caution for Accessibility

Be sure that the power outlet you plug the power cord into is easily accessible and located as close to the equipment operator as possible. When you need to disconnect power to the equipment, be sure to unplug the power cord from the electrical outlet.



### Warnings!

- Do not use this product near water.
- Do not place this product on an unstable cart, stand or table. If the product falls, it could be seriously damaged.
- Slots and openings are provided for ventilation to ensure reliable operation of the product and to protect it from overheating. These openings must not be blocked or covered. The openings should never be blocked by placing the product on a bed, sofa, rug or other similar surface.

This product should never be placed near or over a radiator or heat register, or in a built-in installation unless proper ventilation is provided.

- Never push objects of any kind into this product through cabinet slots as they may touch dangerous voltage points or short-out parts that could result in a fire or electric shock. Never spill liquid of any kind onto or into the product.

- To avoid damage of internal components and to prevent battery leakage, do not place the product on a vibrating surface.
- Never use it under sporting, exercising, or any vibrating environment which will probably cause unexpected short current or damage rotor devices.

## Using electrical power

- This product should be operated from the type of power indicated on the marking label. If you are not sure of the type of power available, consult your dealer or local power company.
- Do not allow anything to rest on the power cord. Do not locate this product where people will walk on the cord.
- If an extension cord is used with this product, make sure that the total ampere rating of the equipment plugged into the extension cord does not exceed the extension cord ampere rating. Also, make sure that the total rating of all products plugged into the wall outlet does not exceed the fuse rating.
- Do not overload a power outlet, strip or receptacle by plugging in too many devices. The overall system load must not exceed 80% of the branch circuit rating. If power strips are used, the load should not exceed 80% of the power strip's input rating.
- This product's AC adapter is equipped with a three-wire grounded plug. The plug only fits in a grounded power outlet. Make sure the power outlet is properly grounded before inserting the AC adapter plug. Do not insert the plug into a non-grounded power outlet. Contact your electrician for details.



.....  
**Warning! The grounding pin is a safety feature. Using a power outlet that is not properly grounded may result in electric shock and/or injury.**



.....  
**Note: The grounding pin also provides good protection from unexpected noise produced by other nearby electrical devices that may interfere with the performance of this product.**

- Use the product only with the supplied power supply cord set. If you need to replace the power cord set, make sure that the new power cord meets the following requirements: detachable type, UL listed/CSA certified, VDE approved or its equivalent, 4.5 meters (15 feet) maximum length.

## Product servicing

Do not attempt to service this product yourself, as opening or removing covers may expose you to dangerous voltage points or other risks. Refer all servicing to qualified service personnel.

Unplug this product from the wall outlet and refer servicing to qualified service personnel when:

- the power cord or plug is damaged, cut or frayed
- liquid was spilled into the product
- the product was exposed to rain or water
- the product has been dropped or the case has been damaged
- the product exhibits a distinct change in performance, indicating a need for service
- the product does not operate normally after following the operating instructions



.....

**Note:** Adjust only those controls that are covered by the operating instructions, since improper adjustment of other controls may result in damage and will often require extensive work by a qualified technician to restore the product to normal condition.



.....

**Warning!** For safety reasons, do not use non-compliant parts when adding or changing components. Consult your reseller for purchase options.

Your device and its enhancements may contain small parts. Keep them out of the reach of small children.

## Additional safety information

- Do not look into the projector's lens when the light is on. The bright may hurt your eyes.
- Turn on the projector first and then signal sources
- Do not place the product in following environments:
  - Space that is poorly ventilated or confined. At least 50cm clearance from walls and free flow of air around the projector is necessary.
  - Locations where temperatures may become excessively high, such as inside of a car with all windows rolled up.
  - Locations where excessive humidity, dust, or cigarette smoke may contaminate optical components, shortening the life span and darkening the image.
  - Locations near fire alarms.
  - Locations with an ambient temperature above 40 °C/104 °F.
  - Locations where the altitudes are higher than 10000 feet.
- Unplug immediately if there is something wrong with your projector. Do not operate if smoke, strange noise or odor comes out of your projector. It

might cause fire or electric shock. In this case, unplug immediately and contact your dealer.

- Do not keep using this product to break or drop it. In this case contact your dealer for inspection.
- Do not face the projector lens to the sun. It can lead to fire.
- When switching the projector off, suggest to ensure the projector completes its cooling cycle before disconnecting power.
- Do not frequently turn off the main power abruptly or unplug the projector during operation. The best way is to wait for the fan to turn off before turning main power off.
- Do not touch air outlet grille and bottom plate which becomes hot.
- Clean the air filter frequently if have. The temperature inside may rise and cause damage when the filter/ventilation slots clogged with dirt or dust.
- Do not look into the air outlet grille when projector is operating. It may hurt your eyes.
- Always open the lens shutter or remove the lens cap when the projector is on.
- Do not block the projector lens with any object when the projector is under operation as this could cause the object to become heated and deformed or even cause a fire.
- Do not attempt to disassemble this projector. There are dangerous high voltages inside which may hurt you. Refer servicing only to suitable qualified professional service personnel.
- Do not stand the projector on end vertically. It may cause the projector to fall over, causing injury or damage.

## Caution for Listening

To protect your hearing, follow these instructions.

- Increase the volume gradually until you can hear clearly and comfortably.
- Do not increase the volume level after your ears have adjusted.
- Do not listen to music at high volumes for extended periods.
- Do not increase the volume to block out noisy surroundings.
- Decrease the volume if you can't hear people speaking near you.

## Disposal instructions

Do not throw this electronic device into the trash when discarding. To minimize pollution and ensure utmost protection of the global environment, please recycle. For more information on the Waste from Electrical and Electronics Equipment (WEEE) regulations, visit

<http://www.acer-group.com/public/Sustainability/sustainability01.htm>



# First things first

## Usage Notes

### Do:

- Turn off the product before cleaning.
- Use a soft cloth moistened with mild detergent to clean the display housing.
- Disconnect the power plug from AC outlet if the product is not being used for a long period of time.

### Don't:

- Block the slots and openings on the unit provided for ventilation.
- Use abrasive cleaners, waxes or solvents to clean the unit.
- Use under the following conditions:
  - In extremely hot, cold or humid environments.
  - In areas susceptible to excessive dust and dirt.
  - Near any appliance that generates a strong magnetic field.
  - Place In direct sunlight.

## Precautions

Follow all warnings, precautions and maintenance as recommended in this user's guide to maximize the life of your unit.



### **Warning:**

- Do not look into the projector's lens when the light is on. The bright may hurt your eyes.
- To reduce the risk of fire or electric shock, do not expose this product to rain or moisture.
- Please do not open or disassemble the product as this may cause electric shock.
- When switching the projector off, please ensure the projector completes its cooling cycle before disconnecting power.
- Turn on the projector first and then the signal sources.
- Do not use lens cap when projector is in operation.



Information for your safety and comfort	iii
First things first	viii
Usage Notes	viii
Precautions	viii
Introduction	1
Product Features	1
Package Overview	2
Projector Overview	3
Projector Outlook	3
Control Panel	4
Remote Control Layout	5
Getting Started	7
Connecting the Projector	7
Turning the Projector On/Off	8
Turning on the Projector	8
Turning the projector off	9
Adjusting the Projected Image	10
Adjusting the Height of Projected Image	10
How to optimize image size and distance	11
How to get a preferred image size by adjusting distance and zoom	13
User Controls	15
Installation menu	15
Acer Empowering Technology	16
Onscreen Display (OSD) Menus	17
Color	18
Image	20
Setting	22
Management	25
Audio	25
3D	26
Language	27
Appendices	28

# Contents

Troubleshooting	28
LED & Alarm Definition Listing	32
Ceiling Mount Installation	33
Specifications	36
Compatibility modes	38
<b>Regulations and safety notices</b>	<b>42</b>

# Introduction

## Product Features

This product is a single-chip DLP® projector. Outstanding features include:

- DLP® technology
- 1024 x 768 XGA resolution  
4:3/16:9 aspect ratio supported
- Versatile display modes (Bright, Presentation, Standard, Video, Picture, Game, Education, User) enable optimum performance in any situation
- NTSC/PAL/SECAM compatible and HDTV (480i/p, 576i/p, 720p, 1080i/p) supported
- Compact size projector facilitates business purposes and home entertainment.
- Acer EcoProjection Technology delivers Intelligent power management approach and physical efficiency improvement
- Empowering Key reveals Acer Empowering Technology utilities (Acer eView, eTimer, e3D, ePower Management) for easy adjustment of settings
- Equipped with HDMI™ connection supporting HDCP
- Advanced digital keystone correction delivers optimum presentations
- Multi-language on screen display (OSD) menus
- Environmental light source and longer life by Laser/LED solution.
- Microsoft® Windows® 2000, XP, Vista® Windows® 7, Macintosh® OS compliant

## Package Overview

This projector comes with all the items shown below. Check to make sure your unit is complete. Contact your dealer immediately if any thing is missing.

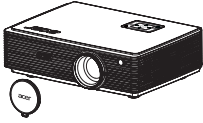

Projector with lens cap

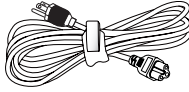

Power cord



Composite video cable



Quick start guide

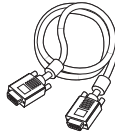

VGA cable



Remote control



2 x Battery

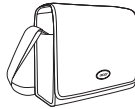

Carrying case



User's Guide

# Projector Overview

## Projector Outlook

Front / upper side

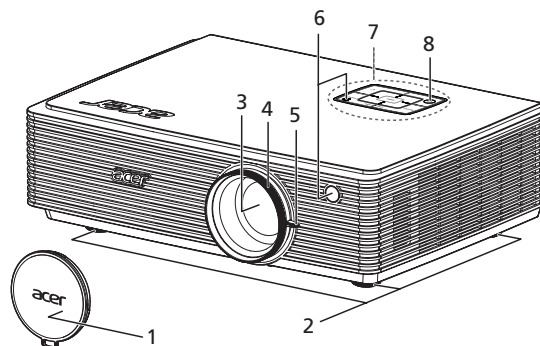

#	Description	#	Description
1	Lens cap	5	Zoom lever
2	Tilt adjusting wheels	6	Remote control receivers
3	Zoom Lens	7	Control panel
4	Focus ring	8	Power button

Rear side

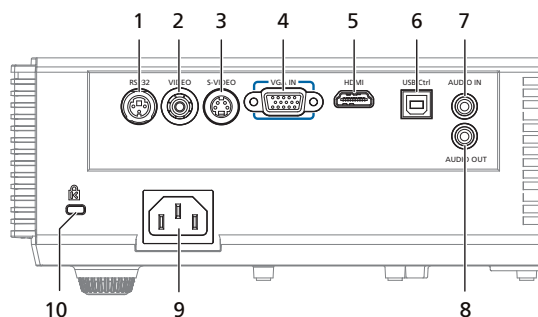

#	Description	#	Description
1	RS232 connector	6	USB ctrl connector
2	Composite video input connector	7	Audio input connector
3	S-Video input connector	8	Audio output connector
4	PC analog signal/HDTV/component video input connector	9	Power socket
5	HDMI connector	10	Kensington™ lock port

## Control Panel

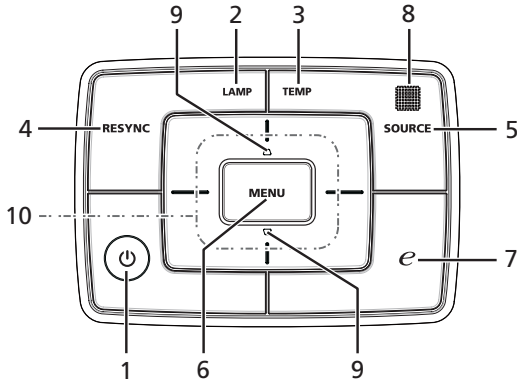





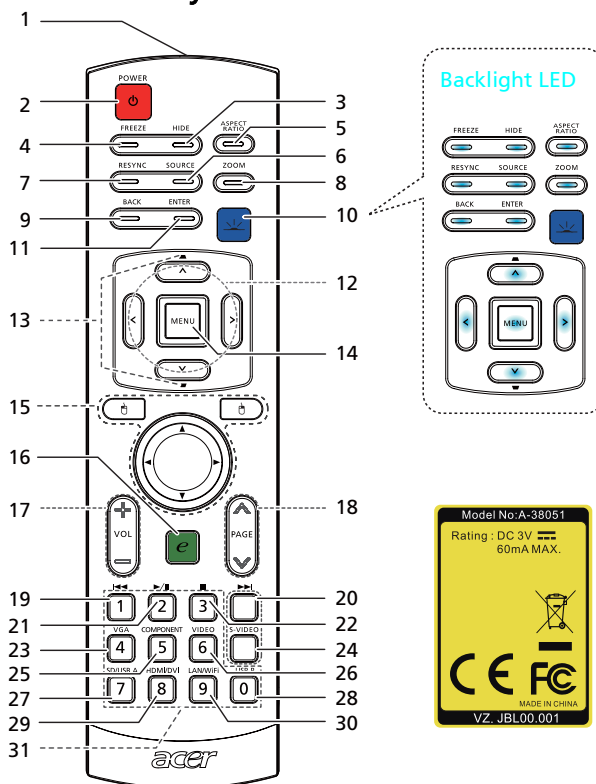





#	Icon	Function	Description
1		POWER	Power button and Power Indicator LED. See the contents in "Turning the Projector On/Off" section.
2		LAMP	Lamp Indicator LED
3		TEMP	Temp Indicator LED
4		RESYNC	Automatically synchronizes the projector to the input source.
5		SOURCE	Changes the active source.
6		MENU	<ul style="list-style-type: none"> <li>Press "MENU" to launch the Onscreen display (OSD) menu, back to the previous step for the OSD menu operation or exit the OSD menu.</li> </ul>
7	<i>e</i>	Empowering key	Unique Acer functions: eView, eTimer, e3D and ePower Management.
8		Remote control receiver	Receives signals from remote control.
9		Keystone	Adjusts the image to compensate for distortion caused by tilting the projector ( $\pm 40$ degrees).
10		Four directional select keys	Use the keys to select items or make adjustments to your selection.

## Remote Control Layout



#	Icon	Function	Description
1		Infrared transmitter	Sends signals to the projector.
2		POWER	Refer to the "Turning the Projector On/Off" section.
3		HIDE	Momentarily turns off the video. Press "HIDE" to hide the image, press again to display the image.
4		FREEZE	To pause the screen image.
5		ASPECT RATIO	To choose the desired aspect ratio (Auto/4:3/16:9)
6		SOURCE	Press "SOURCE" to choose from RGB, Component, S-Video, Composite, HDTV and HDMI™ sources.
7		RESYNC	Automatically synchronizes the projector to the input source.
8		ZOOM	Zooms the projector display in or out.
9		Back	No function.

#	Icon	Function	Description
10		Backlight	Press "  " to trigger backlight mode <ul style="list-style-type: none"> <li>Continue to light 3 sec then disappear if no action.</li> <li>Continue to light if action and keep 3 sec finally.</li> </ul>
11		Enter	No function.
12		Four directional select keys	Use up, down, left, right buttons to select items or make adjustments to your selection.
13		KEYSTONE	Adjusts the image to compensate for distortion caused by tilting the projector ( $\pm 40$ degrees).
14		MENU	<ul style="list-style-type: none"> <li>Press "<b>MENU</b>" to launch the Onscreen display (OSD) menu, back to the previous step for the OSD menu operation or exit the OSD menu.</li> <li>Confirm your selection of items.</li> </ul>
15		MOUSE Left/ Right Click	Left-/right-click buttons are on the left and right, respectively; the center button works as a multidirectional pointer stick. To enable this function, an USB cable must be connected to projector from your PC.
16		Empowering key	Unique Acer functions: eView, eTimer, e3D, ePower Management.
17		VOLUME	Increases/decreases the volume.
18		PAGE	For computer mode only. Use this button to select the next or previous page. This function is only available when connected to a computer via a USB cable.
19		Prev	No function.
20		Next	No function.
21		Play/Pause	No function.
22		Stop	No function.
23		VGA	Press " <b>VGA</b> " to change source to the VGA connector. This connector supports analog RGB, YPbPr (480p/576p/720p/1080i), YCbCr (480i/576i) and RGBsync.
24		S-VIDEO	To change source to S-Video.
25		COMPONENT	No function.
26		VIDEO	To change source to COMPOSITE VIDEO.
27		SD/USB A	No function.
28		USB B	No function.
29		HDMI™/DVI	Press " <b>HDMI™/DVI</b> " to change source to HDMI™.
30		LAN/WiFi	No function.
31		KeyPad 0~9	Press " <b>0~9</b> " to input a password in the " <b>Security</b> ".



# Getting Started

## Connecting the Projector

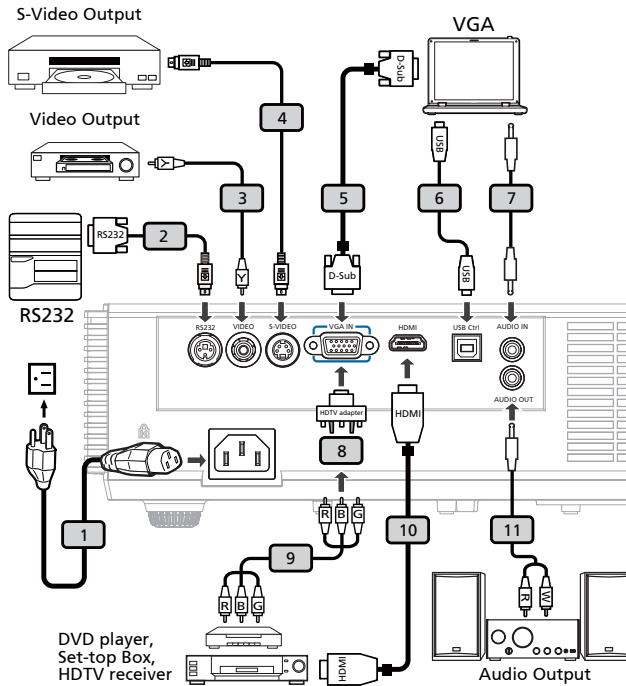

#	Description	#	Description
1	Power cord	7	Audio cable jack/jack
2	RS232 cable	8	VGA to component/HDTV adapter
3	Composite video cable	9	3 RCA component cable
4	S-Video cable	10	HDMI cable
5	VGA cable	11	Audio cable Jack/RCA
6	USB cable		



**Note:** To ensure the projector works well with your computer, please make sure the timing of the display mode is compatible with the projector.

# Turning the Projector On/Off

## Turning on the Projector

- 1 Remove the lens cap.(Illustration #1)
- 2 Ensure that the power cord and signal cable are securely connected. The Power indicator LED will flash red.
- 3 Turn on the projector by pressing "**Power**" button on the control panel, and the Power indicator LED will turn blue.(Illustration #2)
- 4 Turn on your source (computer, notebook, video player ,etc.). The projector will detect your source automatically.
  - If the screen displays "Lock" and "Source" icons, it means the projector is locked onto a specific source type and there is no such type of input signal detected.
  - If the screen displays "No Signal", please make sure the signal cables are securely connected.
  - If you connect to multiple sources at the same time, use the "Source" button on either control panel or the remote control or direct source key on the remote control to switch between inputs.

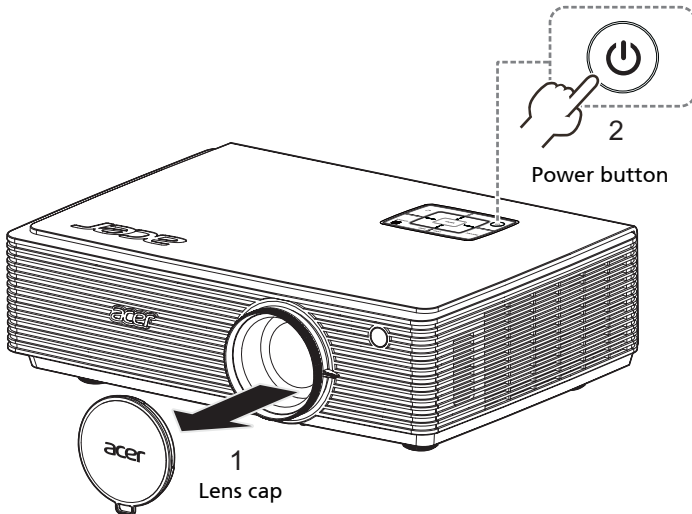

## Turning the projector off

- 1 To turn the projector off, press the power button. This message appears:  
**"Please press the power button again to complete the shutdown process."**  
Press the power button again.
- 2 It is now safe to unplug the power cord.



### Warning indicators:

- **"Projector Overheated. Will automatically turn off soon."**  
This onscreen message indicates that the projector has overheated. The projector will automatically shut down. Contact your local dealer or service center.
- **"Fan failed. Will automatically turn off soon."**  
This onscreen message indicates that the fan has failed. The projector will automatically shut down. Contact your local dealer or service center.



**Note:** Whenever the projector automatically shuts down, contact your local reseller or service center.

## Adjusting the Projected Image

### Adjusting the Height of Projected Image

The projector is equipped with tilt adjusting wheels for adjusting the height of image.

To raise/lower the image:

Use Tilt adjusting wheels to fine-tune the display angle.

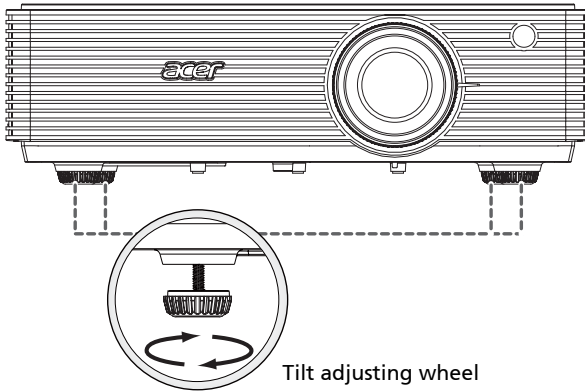

## How to optimize image size and distance

Consult the table below to find the optimal image sizes achievable when the projector is positioned at a desired distance from the screen. Example: If the projector is 2.5 m from the screen, good image quality is possible for image sizes between 57" and 63".



**Note:** Remind as below figure, the space of 111 cm height is required when located at 2.5 m distance.

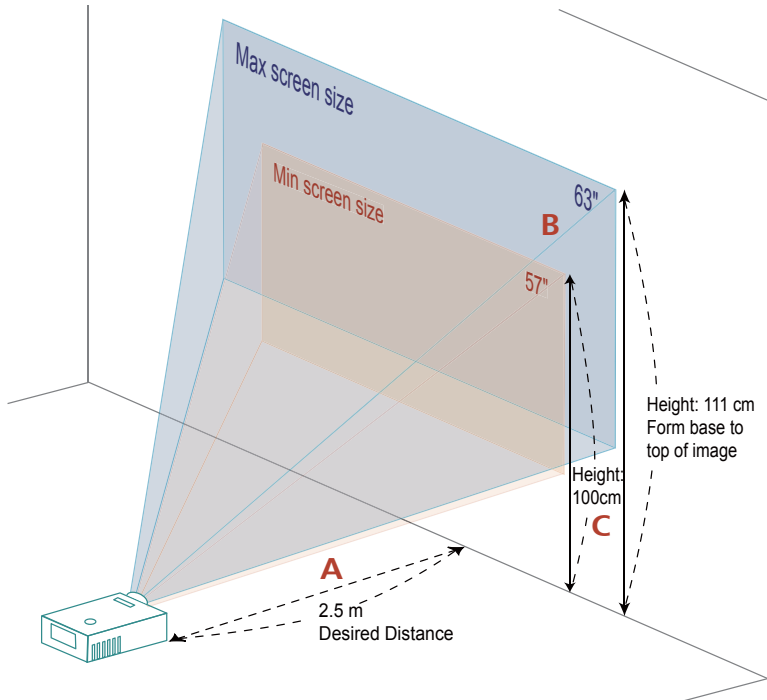
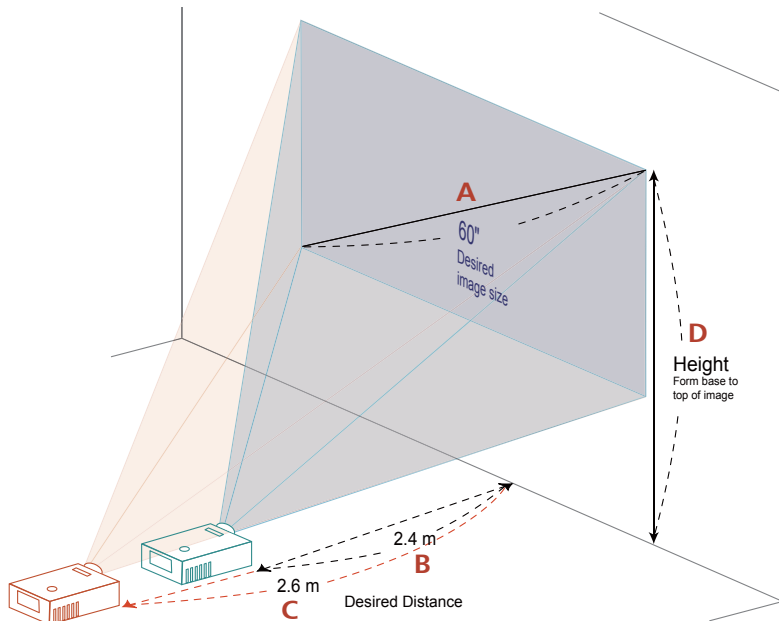

**Figure:** Fixed distance with different zoom and screen size.

Desired Distance (m) <A>	Screen size		Top	Screen size		Top
	(Min zoom)			(Max zoom)		
	Diagonal (inch) <B>	W (cm) x H (cm)	From base to top of image (cm) <C>	Diagonal (inch) <B>	W (cm) x H (cm)	From base to top of image (cm) <C>
1	23	47 x 35	40	25	51 x 38	44
2	46	93 x 70	80	50	103 x 77	88
2.5	57	116 x 87	100	63	128 x 96	111
3	69	140 x 105	120	76	154 x 115	133
3.5	80	163 x 122	140	88	179 x 135	155
4	92	186 x 140	160	101	205 x 154	177
4.5	103	209 x 157	181	114	231 x 173	199
5	114	233 x 174	201	126	256 x 192	221
6	137	279 x 209	241	151	308 x 231	265
7	160	326 x 244	281	177	359 x 269	310
8	183	372 x 279	321	202	410 x 308	354
9	206	419 x 314	361	227	462 x 346	398
10	229	465 x 349	401	252	513 x 385	442

Zoom Ratio: 1.1x

## How to get a preferred image size by adjusting distance and zoom



The table below shows how to achieve a desired image size by adjusting either the position or the zoom ring. For example: to obtain an image size of 60" set the projector at a distance 2.4 m and 2.6 m from the screen and adjust the zoom level accordingly.

Screen size		Distance (m)		Top (cm)
Diagonal (inch) <A>	W (cm) x H (cm)	Max zoom <B>	Min zoom <C>	From base to top of image <D>
30	61 X 46	1.2	1.3	53
40	81 X 61	1.6	1.7	70
50	102 X 76	2.0	2.2	88
60	122 x 91	2.4	2.6	105
70	142 X 107	2.8	3.1	123
80	163 X 122	3.2	3.5	140
90	183 X 137	3.6	3.9	158
100	203 X 152	4.0	4.4	175
120	244 X 183	4.8	5.2	210
150	305 X 229	5.9	6.6	263
180	366 X 274	7.1	7.9	315
200	406 X 305	7.9	8.7	351
250	508 X 381	9.9	10.9	438
300	610 X 457	11.9		526

Zoom Ratio: 1.1x



# User Controls

## Installation menu

The installation menu provides an onscreen display (OSD) for projector installation and maintenance. Use the OSD only when the message "No signal input" is displayed on the screen.

The menu options include settings and adjustments for screen size and distance, focus, keystone correction and more .

- 1 Turn on the projector by pressing "**Power**" button on the control pad.
- 2 Press the "**MENU**" button on the control pad to launch the OSD for projector installation and maintenance.

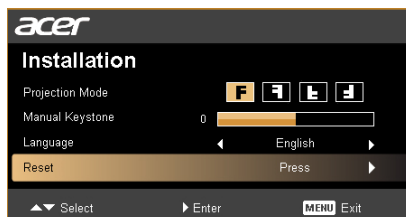
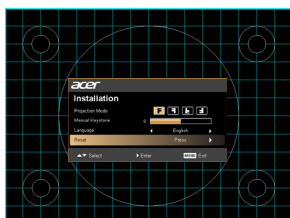

- 3 The background pattern acts as a guide to adjusting the calibration and alignment settings, such as screen size and distance, focus and more .
- 4 The Installation menu includes the following options:
  - Projection Mode
  - Manual Keystone settings
  - Language settings
  - Reset to factory default function

Use the up and down arrow keys to select an option, the left and right arrow keys to adjust selected option settings, and the right arrow key to enter a submenu for feature setting. The new settings will be saved automatically upon exiting the menu.



- 5 Push the menu button anytime to exit the menu and return to the Acer welcome screen.

## Acer Empowering Technology

Acer Empowering Key provide four Acer unique functions, they are "Acer eView Management", "Acer eTimer Management", "Acer ePower Management" and "Acer e3D Management" respectively.

Press "e" key to launch the Onscreen display main menu to modify its function.

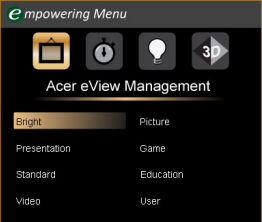
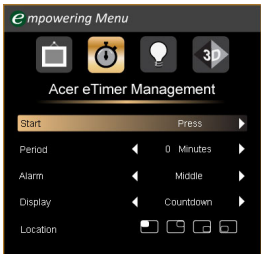
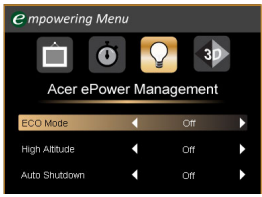





When the Empowering Menu is displayed, use the "e" key to select the main menu.

<p><b>Acer eView Management</b></p> 	<p>"Acer eView Management" is for display mode selection. Please refer to Onscreen Display Menus section for more detail.</p>
<p><b>Acer eTimer Management</b></p> 	<p>"Acer eTimer Management" provides the reminding function for presentation time control. Please refer to Onscreen Display Menus section for more detail.</p>
<p><b>Acer ePower Management</b></p> 	<p>"Acer ePower Management" provides user one shortcut to save the projector life. Please refer to Onscreen Display section for more detail.</p>
<p><b>Acer e3D Management</b></p> 	<p>"Acer e3D Management" provides the 3D functions. Please refer to Onscreen Display Menus section for more detail.</p>

## Onscreen Display (OSD) Menus

The projector has multilingual OSD that allow you to make image adjustments and change a variety of settings.

### Using the OSD menus

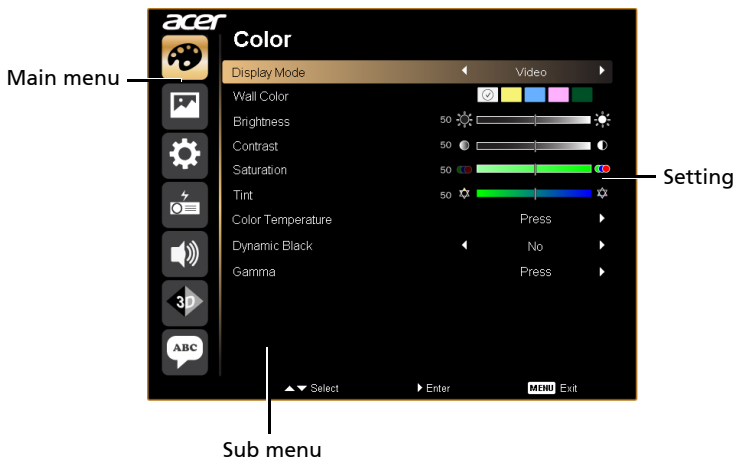

- To open the OSD menu, press **"MENU"** on the remote control or control panel.
- When the OSD is displayed, use the   keys to select any item in the main menu. After selecting the desired main menu item, press  to enter submenu for feature setting.
- Use the   keys to select the desired item and adjust the settings by using the   keys.
- Select the next item to be adjusted in the submenu and adjust as described above.
- Press **"MENU"** on the remote control or control panel, the screen will return to the main menu.
- To exit OSD, press **"MENU"** on the remote control or control panel again. The OSD menu will close and the projector will automatically save the new settings.

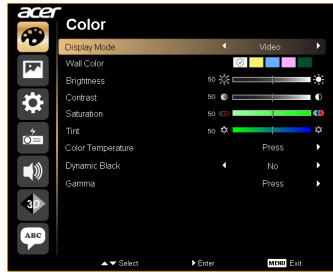

# Color

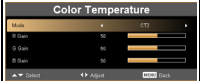

Display Mode	<p>There are many factory presets optimized for various types of images.</p> <ul style="list-style-type: none"> <li>• Bright: For brightness optimization.</li> <li>• Presentation: For meeting presentation.</li> <li>• Standard: For common environment.</li> <li>• Video: For playing video in a bright environment.</li> <li>• Picture: For graphic picture.</li> <li>• Game: For game content.</li> <li>• Education: For education environment.</li> <li>• User: Memorize user's settings.</li> </ul>
Wall color	<p>Use this function to choose a proper color according to the wall. There are several choices, including white, light yellow, light blue, pink, dark green. It will compensate the color deviation due to the wall color to show the correct image tone.</p>
Brightness	<p>Adjust the brightness of the image.</p> <ul style="list-style-type: none"> <li>• Press ◀ to darken image.</li> <li>• Press ▶ to lighten the image.</li> </ul>
Contrast	<p>"Contrast" controls the difference between the lightest and darkest parts of the picture. Adjusting the contrast changes the amount of black and white in the image.</p> <ul style="list-style-type: none"> <li>• Press ◀ to decrease the contrast.</li> <li>• Press ▶ to increase the contrast.</li> </ul>
Saturation	<p>Adjusts a video image from black and white to fully saturated color.</p> <ul style="list-style-type: none"> <li>• Press ◀ to decrease the amount of color in the image.</li> <li>• Press ▶ to increase the amount of color in the image.</li> </ul>
Tint	<p>Adjusts the color balance of red and green.</p> <ul style="list-style-type: none"> <li>• Press ◀ to increase the amount of green in the image.</li> <li>• Press ▶ to increase the amount of red in the image.</li> </ul>

Dynamic Black	Choose "On" to automatically optimize the display of dark movie scenes enabling them to be shown in incredible detail.
Color Temperature	<p>Mode Use this function to choose CT1 (6500K), CT2 (Native CT), CT3 (7500K), User mode.</p>
	R Gain Adjusts the red gain for color temperature optimization.
	G Gain Adjusts the green gain for color temperature optimization.
	B Gain Adjusts the blue gain for color temperature optimization.
	Gamma Effects the representation of dark scenery. With greater gamma value, dark scenery looks brighter.









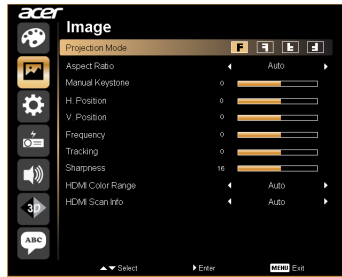



.....

**Note:** "Saturation" and "Tint" functions are not supported under computer mode or HDMI mode.

# Image



<b>Projection</b> 	<b>Front-Desktop</b> <ul style="list-style-type: none"> <li>The factory default setting.</li> </ul>
	<b>Rear-Desktop</b> <ul style="list-style-type: none"> <li>When you select this function, the projector reverses the image so you can project from behind a translucent screen.</li> </ul>
	<b>Rear-Ceiling</b> <ul style="list-style-type: none"> <li>When you select this function, the projector reverses and inverts the image at same time. You can project from behind a translucent screen with ceiling mounted projection.</li> </ul>
	<b>Front-Ceiling</b> <ul style="list-style-type: none"> <li>When you select this function, the projector inverts the image for ceiling-mounted projection.</li> </ul>
<b>Aspect Ratio</b> 	Use this function to choose your desired aspect ratio. <ul style="list-style-type: none"> <li>Auto: Keep the image with original width-highth ratio and maximize the image to fit native horizontal or vertical pixels.</li> <li>4:3: The image will be scaled to fit the screen and displayed using a 4:3 ratio.</li> <li>16:9: The image will be scaled to fit the width of the screen and the height adjusted to display the image using a 16:10 ratio.</li> </ul>
<b>Manual Keystone</b>	Adjust image distortion caused by tilting projection. (±40 degrees)  <b>&lt;Note&gt;</b> The Manual Keystone function is unavailable under Auto Keystone setting to "On".
<b>H. Position</b> (Horizontal position)	<ul style="list-style-type: none"> <li>Press  to move the image left.</li> <li>Press  to move the image right.</li> </ul>
<b>V. Position</b> (Vertical position)	<ul style="list-style-type: none"> <li>Press  to move the image down.</li> <li>Press  to move the image up.</li> </ul>
<b>Frequency</b>	"Frequency" changes the projector's refresh rate to match the frequency of your computer's graphics card. If you can see a vertical flickering bar in the projected image, use this function to make the necessary adjustments.

Tracking	Synchronizes the signal timing of the projector with the graphics card. If you experience an unstable or flickering image, use this function to correct it.
Sharpeness	Adjusts the sharpness of the image. <ul style="list-style-type: none"> <li>• Press ◀ to decrease the sharpness.</li> <li>• Press ▶ to increase the sharpness.</li> </ul>
HDMI Color Range	Adjust the color range of the HDMI image data to correct color display error. <ul style="list-style-type: none"> <li>• Auto: Automatically adjust by information from player.</li> <li>• Limited Range: Process the input image as limited color range data.</li> <li>• Full Range: Process the input image as full color range data.</li> </ul>
HDMI Scan Info	Adjust the overscan ratio of the HDMI image on screen. <ul style="list-style-type: none"> <li>• Auto: Automatically adjust by information from player.</li> <li>• Underscan: Always no overscan on HDMI image.</li> <li>• Overscan: Always keep overscan on HDMI image.</li> </ul>



.....

**Note:** "H. Position", "V. Position", "Frequency" and "Tracking" functions are not supported under HDMI or Video mode.

**Note:** "Sharpeness" functions is not supported under HDMI and Computer mode.

**Note:** "HDMI Color Range" and "HDMI Scan Info" functions are only supported under HDMI mode.

# Setting

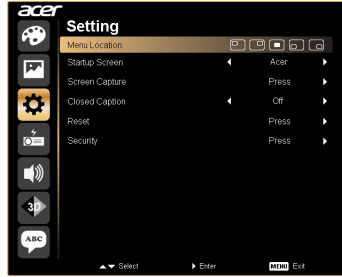

Menu Location	Choose the menu location on the display screen.
Startup Screen	Use this function to select your desired startup screen. If you change the setting, the changes will take effect when you exit the OSD menu. <ul style="list-style-type: none"> <li>• Acer: The default startup screen of your Acer projector.</li> <li>• User: Use memorize picture from "Screen Capture" function.</li> </ul>
Screen Capture	Use this function to customize the startup screen. To capture the image that you want to use as the startup screen, follow the instructions below. <b>Notice:</b> Before proceeding with the following steps, make sure that the "Keystone" is set to the default value 0 and the aspect ratio is set to 4:3. For details, refer to the "Image" section. <ul style="list-style-type: none"> <li>• Change the "Startup Screen" from the default setting "Acer" to "User".</li> <li>• Press "Screen Capture" to customize the startup screen.</li> <li>• A dialog box appears to confirm the action. Choose "Yes" to use the current image as your customized startup screen. The capture range is the red rectangular area. Choose "No" to cancel the screen capture and exit the onscreen display (OSD).</li> <li>• A message appears, stating that the screen capture is in progress.</li> <li>• When the screen capture is finished, the message disappears and the original display is shown.</li> <li>• The customized startup screen, as shown below, takes effect when there is a new input signal or when you restart the projector.</li> </ul>
Closed Caption	Selects a preferred closed captioning mode from CC1, CC2, CC3, CC4, (CC1 displays captions in the primary language in your area). Select "Off" to turn off the captioning feature. This function is only available when a composite video or S-Video input signal is selected and its system format is NTSC. <Note> Set your screen aspect ratio to 4:3. This function is not available when the aspect ratio is "16:9" or "Auto" .













**Note:** This screen capture function is limited by 4:3 aspect ratio only.

**Note:** For XGA models, to get best quality for you desired image, suggest end-user set PC resolution to 1024 x 768 before you use this function.

**Note:** For WXGA models, to get best quality for you desired image, suggest end-user set PC resolution to 1280 x 800 before you use this function.



<p><b>Reset</b></p>	<p>Press the  button and choose "Yes" to return the parameters on all menus to the factory default settings.</p>
<p><b>Security</b></p> 	<p><b>Security</b> This projector provides a useful security function for the administrator to manage usage of the projector .</p> <p>Press  to change the "Security" setting. If the security function is enabled, your must enter the "Administrator Password" first before changing the security settings.</p> <ul style="list-style-type: none"> <li>• Select "On" to enable the security function. The user has to enter a password to operate the projector. Please refer to the "User Password" section for details.</li> <li>• If "Off" is selected, then the user can turn on the projector without password.</li> </ul>
	<p><b>Timeout(Min.)</b> Once "Security" is activated to "On", the administrator can set timeout function.</p> <ul style="list-style-type: none"> <li>• Press  or  to select the timeout interval.</li> <li>• The range is from 10 minute to 990 minutes.</li> <li>• When the time is up, the projector will prompt the user to enter the password again.</li> <li>• The factory default setting of "Timeout(Min.)" is "Off".</li> <li>• Once the security function is enabled, the projector will request user to enter password when switch on the projector . Both "User Password" and "Administrator Password" can be accepted for this dialogue.</li> </ul>
 	<p><b>User password</b></p> <ul style="list-style-type: none"> <li>• Press  to setup or change the "User Password".</li> <li>• Press number keys to set your password on the remote control and press "MENU" to confirm.</li> <li>• Press  to delete character.</li> <li>• Enter the password when you see "Confirm Password" displayed.</li> <li>• The password should be between 4 and 8 characters long.</li> <li>• If you select "Request password only when plugging the power cord in.", the projector will prompt the user to enter the password every time the power cord is plugged.</li> <li>• If you select "Always request the password when turning the projector on.", the user has to enter the password every time when the projector is turned on.</li> </ul>

	<p><b>Administrator Password</b></p> <p>The "Administrator Password" can be used in both the "Enter Administrator Password" and "Enter Password" dialog boxes.</p> <ul style="list-style-type: none"> <li>• Press  to change the "Administrator Password".</li> <li>• The factory default of "Administrator Password" is "1234".</li> </ul> <p>If you forgot your administrator password, do the following to retrieve the administrator password:</p> <ul style="list-style-type: none"> <li>• An unique 6-digit "Universal Password" which is printed on the Security Card (please check accessory in the box). This unique password is the number which will be accepted by projector anytime no matter what the Administrator Password is.</li> <li>• If losing this security card and number, please contact with an Acer service center.</li> </ul>
	<p><b>Lock User Startup Screen</b></p> <ul style="list-style-type: none"> <li>• Default Lock User Startup Screen is "OFF". If lock user startup screen is "ON", users cannot change startup screen anymore and avoid other users change that arbitrarily. Choose "OFF" to unlock startup screen.</li> </ul>

## Management



ECO Mode	Choose "On" to dim the projector lamp which will lower power consumption, extend the lamp life and reduce noise. Choose "Off" to return normal mode.
High Altitude	Choose "On" to turn on High Altitude mode. Operate the fans at full speed continuously to allow for proper high altitude cooling of the projector.
Auto Shutdown	The projector will automatically shutdown when there is no signal input after the allocated time. (in minutes)
LED Calibration	The color will be automatically fine tuned while the system is turning off after continuous running over 30 min. (it will need 10 seconds to complete the process)

## Audio



Volume	<ul style="list-style-type: none"> <li>Press ◀ to decrease the volume.</li> <li>Press ▶ to increase the volume.</li> </ul>
Mute	<ul style="list-style-type: none"> <li>Choose "On" to mute the volume.</li> <li>Choose "Off" to restore the volume.</li> </ul>
Power On/Off Volume	<ul style="list-style-type: none"> <li>Select this function to adjust the notification volume when turning the projector on/off.</li> </ul>
Alarm Volume	<ul style="list-style-type: none"> <li>Select this function to adjust the volume of any warning notifications.</li> </ul>

## 3D



3D	Choose "On" to enable DLP 3D function. <ul style="list-style-type: none"> <li>On: Choose this item while using DLP 3D glasses, 3D 120 Hz capable (NVIDIA/ATI...) graphic card and HQFS format file or DVD with corresponding SW player.</li> <li>Off: Turn off 3D mode.</li> </ul>
3D Sync Invert	If you see a discrete or overlapping image while wearing DLP 3D glasses, you may need to execute "Invert" to get best match of left/right image sequence to get the correct image (for DLP 3D).
3D Warning Message	Choose "On" to display the 3D warning message. <div style="border: 1px solid black; padding: 5px; margin-top: 10px;"> <p>Note: 3D display is now enabled.</p> <ol style="list-style-type: none"> <li>Please make sure you have the correct 3D signals and glasses.</li> <li>Remember to turn 3D off if you don't want to see 3D images.</li> <li>If the 3D display isn't correct, please try to enable 3D Sync Invert.</li> <li>Display mode options will be disabled while in 3D mode.</li> </ol> </div>



**Note:** It needs correct settings on graphic card 3D application program for correct 3D display.

**Note:** The SW players, such as Stereoscopic Player and DDD TriDef Media Player can support 3D format files. You can download these three players on web page below,

- Stereoscopic Player (Trial): [http://www.3dtv.at/Downloads/Index\\_en.aspx](http://www.3dtv.at/Downloads/Index_en.aspx)

- DDD TriDef Media Player (Trial):

<http://www.tridef.com/download/TriDef-3-D-Experience-4.0.2.html>



**Note:** "3D Sync Invert" is only available when 3D is enabled.

**Note:** There has reminder screen if 3D still enable when power on projector. Please adjust setting depended on your purpose.

# Language



## Language

Choose the multilingual OSD menu. Use the  or  key to select your preferred menu language.

- Press  to confirm the selection.

# Appendices

## Troubleshooting

If you experience a problem with your Acer projector, refer to the following troubleshooting guide. If the problem persists, please contact your local reseller or service center.

### Image Problems and Solutions

#	Problem	Solution
1	No image appears onscreen	<ul style="list-style-type: none"> <li>• Connected as described in the "Getting Started" section.</li> <li>• Ensure none of the connector pins are bent or broken.</li> <li>• Make sure you have removed the lens cap and the projector is switched on.</li> </ul>
2	Partial, scrolling or incorrectly displayed image (For PC (Windows 95/98/2000/XP/Vista/Win7))	<ul style="list-style-type: none"> <li>• Press "RESYNC" on the remote control or control panel.</li> <li>• For an incorrectly displayed image:             <ul style="list-style-type: none"> <li>• Open "My Computer," open the "Control Panel," and then double-click the "Display" icon.</li> <li>• Select the "Settings" tab.</li> <li>• Verify that your display resolution setting is lower than or equal to 1080P-EIA.</li> <li>• Click the "Advanced Properties" button.</li> </ul> </li> </ul> <p>If the problem still appears, change the monitor display you are using and follow the steps below:</p> <ul style="list-style-type: none"> <li>• Verify that the resolution setting is lower than or equal to 1080P-EIA.</li> <li>• Click the "Change" button under the "Monitor" tab.</li> <li>• Click "Show all devices". Next, select "Standard monitor types" under the SP box, and choose the resolution mode you need under the "Models" box.</li> <li>• Verify that the resolution setting of the monitor display is lower than or equal to 1080P-EIA.</li> </ul>

3	Partial, scrolling or incorrectly displayed image (for notebooks)	<ul style="list-style-type: none"> <li>• Press "RESYNC" on the remote control or control panel.</li> <li>• For an incorrectly displayed image: <ul style="list-style-type: none"> <li>• Follow the steps for item 2 (above) to adjust the resolution of your computer.</li> <li>• Press the toggle output settings. Example: [Fn]+[F4], Compaq [Fn]+[F4], Dell [Fn]+[F8], Gateway [Fn]+[F4], IBM [Fn]+[F7], HP [Fn]+[F4], NEC [Fn]+[F3], Toshiba [Fn]+[F5]</li> </ul> </li> <li>• If you experience difficulty changing resolutions or your monitor freezes, restart all equipment including the projector.</li> </ul>
4	The screen of the notebook computer is not displaying your presentation	<ul style="list-style-type: none"> <li>• If you are using a Microsoft® Windows® based notebook: Some notebook PCs may deactivate their own screens when a second display device is in use. Each has a different way to be reactivated. Refer to your computer's manual for detailed information.</li> <li>• If you are using an Apple® Mac® OS based notebook: In System Preferences, open Display and select Video Mirroring "On".</li> </ul>
5	Image is unstable or flickering	<ul style="list-style-type: none"> <li>• Adjust the "Tracking" to correct it. Refer to the "Image" section for more information.</li> <li>• Change the display color depth settings on your computer.</li> </ul>
6	Image has vertical flickering bar	<ul style="list-style-type: none"> <li>• Use "Frequency" to make an adjustment. Refer to the "Image" section for more information.</li> <li>• Check and reconfigure the display mode of your graphics card to make it compatible with the projector.</li> </ul>
7	Image is out of focus	<ul style="list-style-type: none"> <li>• Make sure the lens cap is removed.</li> <li>• Adjusts the focus ring on the projector lens.</li> <li>• Make sure the projection screen is within the required distance of 3.9 - 39.0 feet (1.2 - 11.9 meters) from the projector. Refer to the "How to Get a Preferred Image Size by Adjusting Distance and Zoom" section for more information.</li> </ul>
8	Image is stretched when displaying a "widescreen" DVD title	<p>When you play a DVD encoded in anamorphic or 16:9 aspect ratio you may need to adjust the following settings:</p> <ul style="list-style-type: none"> <li>• If you play a 4:3 format DVD title, please change the format to 4:3 in the projector OSD.</li> <li>• If the image is still stretched, you will also need to adjust the aspect ratio. Set up the display format to 16:9 (wide) aspect ratio on your DVD player.</li> </ul>

9	Image is too small or too large	<ul style="list-style-type: none"> <li>• Adjust the zoom ring on the top of the projector.</li> <li>• Move the projector closer to or further from the screen.</li> <li>• Press "MENU" on the remote control or on the control panel. Go to "Image --&gt; Aspect Ratio" and try different settings.</li> </ul>
10	Image has slanted sides	<ul style="list-style-type: none"> <li>• If possible, reposition the projector so that it is centered on the screen.</li> <li>• Press the "Keystone <math>\Delta</math> / <math>\nabla</math>" on the OSD or the remote control until the sides are vertical.</li> </ul>
11	Image is reversed	<ul style="list-style-type: none"> <li>• Select "Image --&gt; Projection" on the OSD and adjust the projection direction.</li> </ul>

### Problems with the Projector

#	Condition	Solution
1	The projector stops responding to all controls	If possible, turn off the projector, then unplug the power cord and wait at least 30 seconds before reconnecting power.



## OSD Messages

#	Condition	Message Reminder
1	Message	<p data-bbox="396 274 754 300">Fan Fail - the system fan is not working.</p> <div data-bbox="396 320 965 384" style="background-color: black; color: white; padding: 5px; text-align: center;"><p data-bbox="658 330 714 347">Fan Fail.</p><p data-bbox="586 349 788 367">Will automatically turn off soon</p></div> <p data-bbox="396 403 956 467">Projector Overheated - the projector has exceeded its recommended operating temperature and must be allowed to cool down before it may be used.</p> <div data-bbox="396 488 965 552" style="background-color: black; color: white; padding: 5px; text-align: center;"><p data-bbox="624 497 766 515">Projector Overheated.</p><p data-bbox="598 517 795 534">Will automatically turn off soon</p></div>

# LED & Alarm Definition Listing

## LED Messages

Message	Lamp_LED	Temp_LED	Power_LED	Power_LED
	Red	Red	Red	Blue
Power Plug	Flash ON to OFF 100ms	Flash ON to OFF 100ms	Flash ON to OFF 100ms	--
Standby	--	--	ON	--
Power button ON	--	--	--	ON
Lamp retry	--	--	--	0.5 second H(On), 0.5 second L(Off) flashing
Cooling state	--	--	0.5 second H(ON), 0.5 second L(OFF) flashing	--
Power button OFF: Cooling completed; Standby Mode	--	--	ON	--
Firmware Download	ON	ON	ON	--
Thermistor error ( $T \geq 70^{\circ}\text{C}$ ) (Laser light source over temperature), OSD shows "Projector Overheated"	--	ON	--	ON
Fan lock error OSD shows red "Fan Fail, Will automatically turn off soon"	--	0.5 second H(On), 0.5 second L(Off) flashing	--	ON
Lamp error (Lamp, ballast)	ON	--	--	ON
Phosphor Wheel error	0.5 second H(ON), 0.5 second L(OFF) flashing	--	--	ON

## Ceiling Mount Installation

If you wish to install the projector using a ceiling mount, please refer to the steps below:

- 1 Drill four holes into a solid, structurally sound part of the ceiling, and secure the mount base.

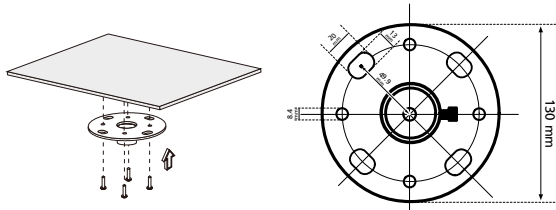

**Note:** Screws are not included. Please obtain the appropriate screws for your type of ceiling.

- 2 Secure the ceiling rod using the appropriate type of four-cylinder screws.

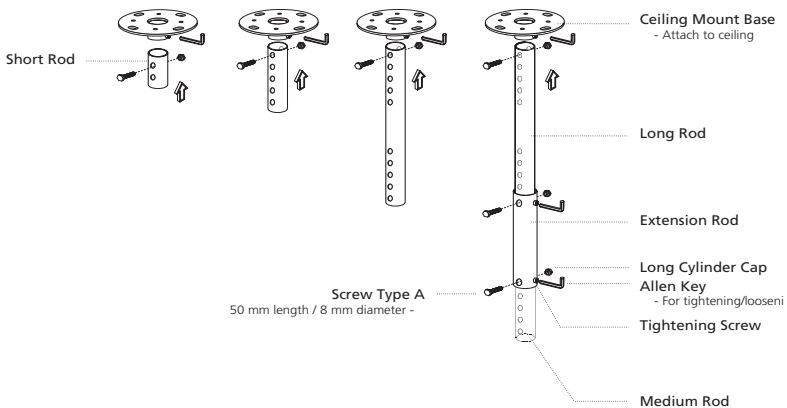

- 3 Use the appropriate number of screws for the projector size to attach the projector to the ceiling mount bracket.

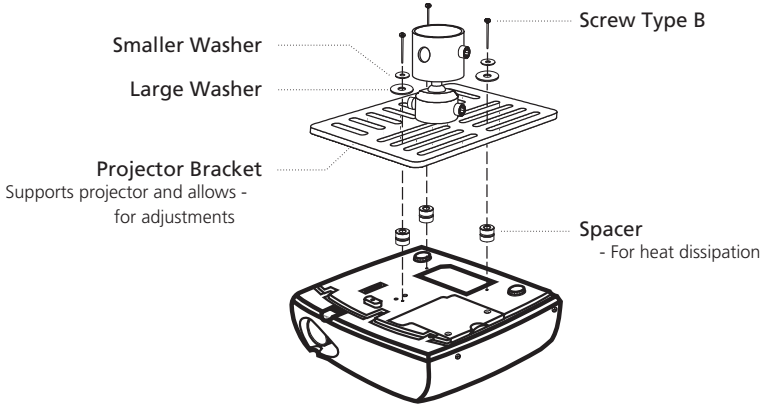

**Note:** It is recommended that you keep a reasonable space between the bracket and the projector to allow for proper heat distribution. Use two washers for extra support, if deemed necessary.

- 4 Attach the ceiling bracket to the ceiling rod.

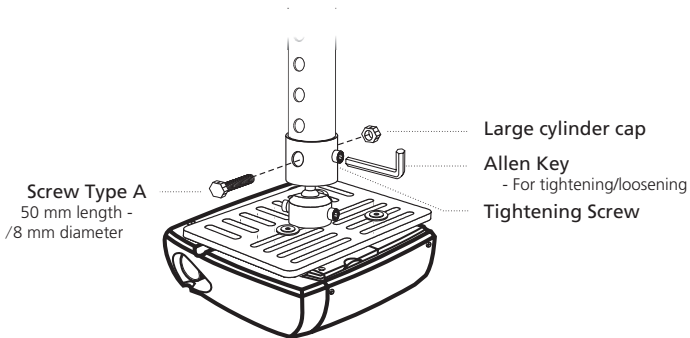

- 5 Adjust the angle and positioning as necessary.

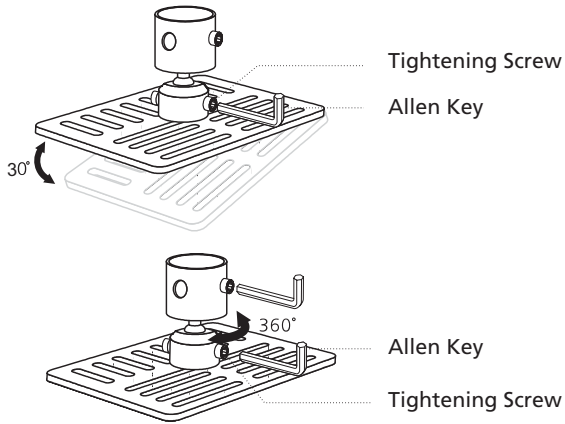

**Note:** The appropriate type of screw and washer for each model is listed in the table below. 3 mm diameter screws are enclosed in the screw pack.

Models	Screw Type B		Washer Type	
	Diameter (mm)	Length (mm)	Large	Small
K520/H112/PH-X01	3	25	V	V

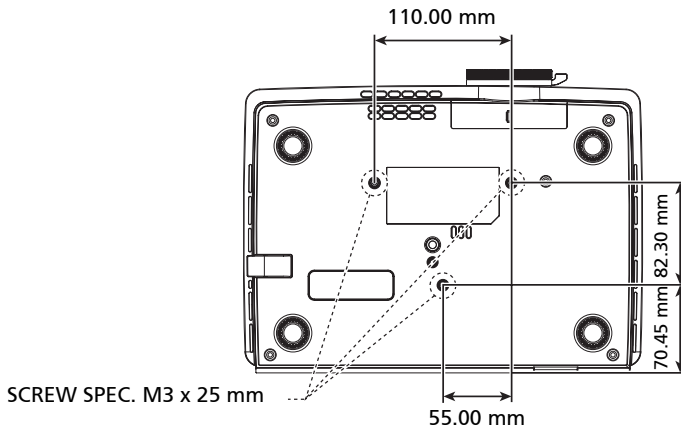

## Specifications

The specifications listed below are subject to change without notice. For final specs, please refer to Acer's published marketing specifications.

Projection system	DLP®
Resolution	XGA (1024 x 768)
Computer compatibility	IBM PC and compatibles, Apple Macintosh, iMac and VESA standards: SXGA, XGA, SVGA, VGA, WXGA
Video compatibility	NTSC (3.58/4.43), PAL (B/D/G/H/I/M/N), SECAM (B/D/G/K/K1/L), HDTV (720p, 1080i, 1080p), EDTV (480p, 576p), SDTV (480i, 576i)
Aspect ratio	Auto, 4:3, 16:9
Displayable colors	1.07 billion colors
Projection lens	F = 2.41 ~ 2.55, f = 21.79 mm ~ 23.99 mm, 1:1.1 Manual Zoom and Manual Focus
Projection screen size (diagonal)	27" (70 cm) ~ 300" (762 cm)
Projection distance	3.9' (1.2 m) ~ 39.0' (11.9 m)
Throw ratio	50"@2 m (1.95 ~ 2.15:1)
Horizontal scan rate	30 k - 100 kHz
Vertical refresh scan rate	50 - 120 Hz
Keystone correction	+/- 40 degrees
Weight	3.95 Kg (8.71 lbs)
Dimensions (W x D x H)	321 mm x 231 mm x 87 mm (12.64" x 9.09" x 3.43")
Power supply	AC 100 – 240 V, 50-60 Hz
Power consumption	Normal mode: 197 W +/- 10% @ 110 Vac (Bright mode @ full power) ECO mode: 158 @ 110 Vac (Video mode @ eco power) Standby < 0.5 W
Operating temperature	5°C to 35°C / 41°F to 95°F
I/O connectors	<ul style="list-style-type: none"> <li>• Power socket x1</li> <li>• RS232 x1</li> <li>• Composite input x1</li> <li>• S-Video x1</li> <li>• VGA input x1</li> <li>• HDMI x1</li> <li>• USB x1: for firmware upgrade</li> <li>• Audio input x1</li> <li>• Audio output x 1</li> </ul>

## Standard package contents

- AC power cord x1
  - VGA cable x1
  - Composite video cable x1
  - Remote control x1
  - Battery x 2 (for remote control)
  - User's Guide (CD-ROM) x1 (for projector function)
  - Quick start guide x1
  - Carrying case x1
- 

\* Design and specifications are subject to change without notice.

# Compatibility modes

## A. VGA Analog

### 1 VGA Analog - PC Signal

Modes	Resolution	V.Frequency [Hz]	H.Frequency [KHz]
VGA	640x480	60	31.5
	640x480	72	37.9
	640x480	75	37.5
	640x480	85	43.3
	640x480	119.51	61.0
SVGA	800x600	56	35.1
	800x600	60	37.9
	800x600	72	48.1
	800x600	75	46.9
	800x600	85	53.7
	800x600	119.85	77.20
XGA	1024x768	60	48.4
	1024x768	70	56.5
	1024x768	75	60.0
	1024x768	85	68.7
	1024x768	119.804	98.80
SXGA	1152x864	70	63.8
	1152x864	75	67.5
	1152x864	85	77.1
	1280x1024	60	64.0
	1280x1024	72	77.0
	1280x1024	75	80.0
QuadVGA	1280x960	60	60.0
	1280x960	75	75.2
	1600x1200	60	75.0
PowerBook G4	640x480	60	31.4
PowerBook G4	640x480	66.6 (67)	34.9
PowerBook G4	800x600	60	37.9
PowerBook G4	1024x768	60	48.4
PowerBook G4	1152x870	75	68.7
PowerBook G4	1280x960	75	75.0
i Mac DV (G3)	1024x768	75	60.0



## 2 VGA Analog - Extended Wide timing

Modes	Resolution	V.Frequency [Hz]	H.Frequency [KHz]
WXGA	1280x768	60	47.8
	1280x768	75	60.3
	1280x768	85	68.6
	1280x720	60	44.8
	1280x800	60	49.6
	1440x900	60	59.9
WSXGA+	1680x1050	60	65.3
	1366x768	60	47.7
	1920x1080-RB	60	66.60
	1920x1080-EIA	60	66.60
	1024x600	60	37.3
	1920x1080 (Reduced Blanking Timing)	60	66.6
	1366x768	60	47.7

## 3 VGA Analog - Component Signal

Modes	Resolution	V.Frequency [Hz]	H.Frequency [KHz]
480i	720x480	59.94(29.97)	15.7
576i	720x576	50(25)	15.6
480p	720x480	59.94	31.5
576p	720x576	50	31.3
720p	1280x720	60	45.0
720p	1280x720	50	37.5
1080i	1920x1080	60 (30)	33.8
1080i	1920x1080	50 (25)	28.1
1080p	1920x1080	23.97/24	27.0
1080p	1920x1080	60	67.5
1080p	1920x1080	50	56.3

## B. HDMI Digital

### 1 HDMI - PC Signal

Modes	Resolution	V.Frequency [Hz]	H.Frequency [KHz]
VGA	640x480	60	31.5
	640x480	72	37.9
	640x480	75	37.5
	640x480	85	43.3
	640x480	119.51	61.61

SVGA	800x600	56	35.1
	800x600	60	37.9
	800x600	72	48.1
	800x600	75	46.9
	800x600	85	53.7
	800x600	119.85	77.20
XGA	1024x768	60	48.4
	1024x768	70	56.5
	1024x768	75	60.0
	1024x768	119.804	98.80
SXGA	1152x864	75	67.5
	1152x864	85	77.1
	1280x1024	60	64.0
	1280x1024	72	77.0
	1280x1024	75	80.0
	1280x1024	85	91.1
QuadVGA	1280x960	75	75.2
PowerBook G4	640x480	60	31.4
PowerBook G4	640x480	66.6 (67)	34.9
PowerBook G4	800x600	60	37.9
PowerBook G4	1024x768	60	48.4
PowerBook G4	1152x870	75	68.7
PowerBook G4	1280x960	75	75.0
i Mac DV (G3)	1024x768	75	60.0

## 2 HDMI - Extended Wide timing

Modes	Resolution	V.Frequency [Hz]	H.Frequency [KHz]
WXGA	1280x768	60	47.8
	1280x768	75	60.3
	1280x768	85	68.6
	1280x720	60	44.8
	1280x800	60	49.6
	1440x900	60	59.9
WSXGA+	1680x1050	60	65.3
	1366x768	60	47.7
	1024x600	60	37.3

## 3 HDMI - Video Signal

Modes	Resolution	V.Frequency [Hz]	H.Frequency [KHz]
480i	720x480(1440x480)	59.94 (29.97)	15.7
576i	720x576(1440x576)	50 (25)	15.6
480p	720x480	59.94	31.5
576p	720x576	50	31.3
720p	1280x720	60	45.0
720p	1280x720	50	37.5
1080i	1920x1080	60 (30)	33.8
1080i	1920x1080	50 (25)	28.1
1080p	1920x1080	23.97/24	27.0
Graphic source monitor range limits	Horizontal scan rate:	30k~100kHz	
	Vertical scan rate:	50~120Hz	
	Max. pixel rate	165MHz	

# Regulations and safety notices

## FCC notice

This device has been tested and found to comply with the limits for a Class B digital device pursuant to Part 15 of the FCC rules. These limits are designed to provide reasonable protection against harmful interference in a residential installation. This device generates, uses, and can radiate radio frequency energy and, if not installed and used in accordance with the instructions, may cause harmful interference to radio communications.

However, there is no guarantee that interference will not occur in a particular installation. If this device does cause harmful interference to radio or television reception, which can be determined by turning the device off and on, the user is encouraged to try to correct the interference by one or more of the following measures:

- Reorient or relocate the receiving antenna.
- Increase the separation between the device and receiver.
- Connect the device into an outlet on a circuit different from that to which the receiver is connected.
- Consult the dealer or an experienced radio/television technician for help.

## Notice: Shielded cables

All connections to other computing devices must be made using shielded cables to maintain compliance with FCC regulations.

## Notice: Peripheral devices

Only peripherals (input/output devices, terminals, printers, etc.) certified to comply with the Class B limits may be attached to this equipment. Operation with non-certified peripherals is likely to result in interference to radio and TV reception.

## Caution

Changes or modifications not expressly approved by the manufacturer could void the user's authority, which is granted by the Federal Communications Commission, to operate this device.

## Operation conditions

This device complies with Part 15 of the FCC Rules. Operation is subject to the following two conditions: (1) this device may not cause harmful interference, and (2) this device must accept any interference received, including interference that may cause undesired operation.

## Notice: Canadian users

This Class B digital apparatus complies with Canadian ICES-003.

## Remarque à l'intention des utilisateurs canadiens

Cet appareil numérique de la classe B est conforme à la norme NMB-003 du Canada.

## Declaration of Conformity for EU countries

Acer hereby declares that this projector series is in compliance with the essential requirements and other relevant provisions of Directive 1999/5/EC.

Compliant with Russian regulatory certification



## Radio device regulatory notice



**Note:** The regulatory information below is for models with wireless LAN and/or Bluetooth only.

## General

This product complies with the radio frequency and safety standards of any country or region in which it has been approved for wireless use. Depending on configurations, this product may or may not contain wireless radio devices (such as wireless LAN and/or Bluetooth modules).

## Canada — Low-power license-exempt radio communication devices (RSS-210)

- a Common information
  - Operation is subject to the following two conditions:
    1. This device may not cause interference, and
    2. This device must accept any interference, including interference that may cause undesired operation of the device.
- b Operation in 2.4 GHz band
  - To prevent radio interference to the licensed service, this device is intended to be operated indoors and installation outdoors is subject to licensing.

## List of applicable countries

This device must be used in strict accordance with the regulations and constraints in the country of use. For further information, please contact the local office in the country of use. Please see <http://ec.europa.eu/enterprise/rte/implem.htm> for the latest country list.

## Laser regulation

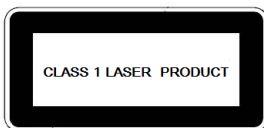

Complies with 21 CFR 1040.10 and 1040.11 except for deviations pursuant to Laser Notice No. 50, dated June 24, 2007.  
IEC 60825-1:2007

Important !

Laser Precautions

- This projector is a Class 1 laser device that conforms with IEC 60825-1:2007.
- This projector has built-in laser module. Disassembly or modification is very dangerous and should never be attempted.
- Any operation or adjustment not specifically instructed by the user's guide creates the risk of hazardous laser radiation exposure.



**Acer Incorporated**  
8F, 88, Sec. 1, Xintai 5th Rd., Xizhi,  
New Taipei City 221, Taiwan



## Declaration of Conformity

We,

**Acer Incorporated**

8F, 88, Sec. 1, Xintai 5th Rd., Xizhi, New Taipei City 221, Taiwan

Contact Person: Mr. RU Jan, e-mail:ru\_jan@acer.com.tw

And,

**Acer Italy s.r.l**

Via Lepetit, 40, 20020 Lainate (MI) Italy

Tel: +39-02-939-921, Fax: +39-02 9399-2913, www.acer.it

Hereby declare that:

<b>Product:</b>	<b>Projector</b>
<b>Trade Name:</b>	<b>Acer</b>
<b>Model Number:</b>	<b>CNX1114</b>
<b>Machine Type:</b>	<b>K520/H112/PH-X01</b>

Is compliant with the essential requirements and other relevant provisions of the following EC directives, and that all the necessary steps have been taken and are in force to assure that production units of the same product will continue comply with the requirements.

**EMC Directive 2004/108/EC as attested by conformity with the following harmonized standards:**

- EN55022, AS/NZS CISPR22, Class B
- EN55024
- EN61000-3-2 Class A
- EN61000-3-3

**Low Voltage Directive 2006/95/EC as attested by conformity with the following harmonized standard:**

- EN60950-1

**RoHS Directive 2002/95/EC on the Restriction of the Use of certain Hazardous Substances in Electrical and Electronic Equipment**

- The maximum concentration values of the restricted substances by weight in homogenous material are:

Lead	0.1%	Polybrominated Biphenyls (PBB's)	0.1%
Mercury	0.1%	Polybrominated Diphenyl Ethers (PBDE's)	0.1%
Hexavalent Chromium	0.1%	Cadmium	0.01%

**Directive 2009/125/EC with regard to establishing a framework for the setting of ecodesign requirements for energy-related product.**



Acer Incorporated  
8F, 88, Sec. 1, Xintai 5th Rd., Xizhi,  
New Taipei City 221, Taiwan

The standards listed below are applied to the product if built with WLAN module or wireless keyboard and mouse.



R&TTE Directive 1999/5/EC as attested by conformity with the following harmonized standard:

● **Article 3.1(a) Health and Safety**

- EN60950-1
- EN62311

● **Article 3.1(b) EMC**

- EN301 489-1
- EN301 489-17

● **Article 3.2 Spectrum Usages**

- EN300 328
- EN301 893 (Applicable to 5GHz high performance RLAN).

**Year to begin affixing CE marking 2012.**

RU Jan/Sr. Manager  
Regulation Center, Acer Inc.

Mar. 30, 2012 -  
Date





**Acer America Corporation**

333 West San Carlos St., San Jose  
CA 95110, U. S. A.  
Tel : 254-298-4000  
Fax : 254-298-4147  
www.acer.com



## **Federal Communications Commission Declaration of Conformity**

**This device complies with Part 15 of the FCC Rules. Operation is subject to the following two conditions: (1) this device may not cause harmful interference, and (2) this device must accept any interference received, including interference that may cause undesired operation.**

**The following local Manufacturer / Importer is responsible for this declaration:**

<b>Product:</b>	<b>DLP Projector</b>
<b>Model Number:</b>	<b>CNX1114</b>
<b>Machine Type:</b>	<b>K520/H112/PH-X01</b>
<b>Name of Responsible Party:</b>	<b>Acer America Corporation</b>
<b>Address of Responsible Party:</b>	<b>333 West San Carlos St. San Jose, CA 95110 U. S. A.</b>
<b>Contact Person:</b>	<b>Acer Representative</b>
<b>Phone No.:</b>	<b>254-298-4000</b>
<b>Fax No.:</b>	<b>254-298-4147</b>

## Free Manuals Download Website

<http://myh66.com>

<http://usermanuals.us>

<http://www.somanuals.com>

<http://www.4manuals.cc>

<http://www.manual-lib.com>

<http://www.404manual.com>

<http://www.luxmanual.com>

<http://aubethermostatmanual.com>

Golf course search by state

<http://golfingnear.com>

Email search by domain

<http://emailbydomain.com>

Auto manuals search

<http://auto.somanuals.com>

TV manuals search

<http://tv.somanuals.com>