

TravelMate 5730 Series

Quick Guide

Copyright © 2008. Acer Incorporated.
All Rights Reserved.

Travelmate 5730 Series Quick Guide
Original Issue: 08/2008

Changes may be made periodically to the information in this publication without obligation to notify any person of such revisions or changes. Such changes will be incorporated in new editions of this manual or supplementary documents and publications. This company makes no representations or warranties, either expressed or implied, with respect to the contents hereof and specifically disclaims the implied warranties of merchantability or fitness for a particular purpose.

Record the model number, serial number, purchase date and place of purchase information in the space provided below. The serial number and model number are recorded on the label affixed to your computer. All correspondence concerning your unit should include the serial number, model number and purchase information.

No part of this publication may be reproduced, stored in a retrieval system, or transmitted, in any form or by any means, electronically, mechanically, by photocopy, recording or otherwise, without the prior written permission of Acer Incorporated.

TravelMate 5730 Series Notebook PC

Model number: _____

Serial number: _____

Date of purchase: _____

Place of purchase: _____

Acer and the Acer logo are registered trademarks of Acer Incorporated. Other companies' product names or trademarks are used herein for identification purposes only and belong to their respective companies.

CE Declaration of Conformity



We,

Acer Incorporated
8F, 88, Sec. 1, Hsin Tai Wu Rd., Hsichih, Taipei Hsien 221, Taiwan

Contact person: Mr. Easy Lai
Tel: 886-2-8691-3089, Fax: 886-2-8691-3120
Email: easy_lai@acer.com.tw
Hereby declare that:

Product: Notebook Computer Trade name: Acer
Model number: MS2231 Machine type: TravelMate 5730
SKU number: TravelMate 5730-xxxxx ("x" = 0-9, a - z, or A - Z)

Is compliant with the essential requirements and other relevant provisions of the following EC directives, and that all the necessary steps have been taken and are in force to assure that production units of the same product will continue comply with the requirements.

EMC Directive 2004/108/EC as attested by conformity with the following harmonized standards:

- EN55022: 2006, AS/NZS CISPR22: 2006, Class B
- EN55024: 1998 + A1: 2001 + A2: 2003
- EN55013: 2001 + A1: 2003 + A2:2006
(Applicable to product built with TV tuner module)
- EN55020:2007 (Applicable to product built with TV tuner module)
- EN61000-3-2: 2006, Class D
- EN61000-3-3: 1995 + A1: 2001+A2: 2005

Low Voltage Directive 2006/95/EC as attested by conformity with the following harmonized standard:

- EN60950-1: 2001 + A11: 2004
- EN60065: 2002 + A1: 2006 (Applicable to product built with TV tuner module)

Council Decision 98/482/EC (CTR21) for pan- European single terminal connection to the Public Switched Telephone Network (PSTN).

RoHS Directive 2002/95/EC on the Restriction of the Use of certain Hazardous Substances in Electrical and Electronic Equipment.

R&TTE Directive 1999/5/EC as attested by conformity with the following harmonized standards:

- **Article 3.1(a) Health and Safety**
 - EN60950-1:2001 + A11:2004
 - EN50371:2002
- **Article 3.1(b) EMC**
 - EN301 489-1 V1.6.1
 - EN301 489-3 V1.4.1 (Applicable to non-bluetooth wireless keyboard mouse set)
 - EN301 489-17 V1.2.1
- **Article 3.2 Spectrum Usages**
 - EN300 440-2 V1.1.2 (Applicable to non-bluetooth wireless keyboard mouse set)
 - EN300 328 V1.7.1
 - EN301 893 V1.4.1 (Applicable to 5GHz high performance RLAN).

CE marking affixed starting from 2008

Easy Lai
Easy Lai / Manager
Regulation Center, Acer Inc.

4 Aug 2008
Date

Federal Communications Commission

Declaration of Conformity

This device complies with Part 15 of the FCC Rules. Operation is subject to the following two conditions: (1) This device may not cause harmful interference, and (2) This device must accept any interference received, including interference that may cause undesired operation.

The following local manufacturer/importer is responsible for this declaration:

Product name:	Notebook PC
Brand name	Acer
Model number:	MS2231
Machine type:	TravelMate 5730
SKU number:	TravelMate 5730-xxxx ("x" = 0 - 9, a - z, or A - Z)
Name of responsible party:	Acer America Corporation
Address of responsible party:	333 West San Carlos St., San Jose, CA 95110 USA
Contact person:	Acer Representative
Tel:	1-254-298-4000
Fax:	1-254-298-4147

First things first

We would like to thank you for making an Acer notebook your choice for meeting your mobile computing needs.

Your guides

To help you use your Acer notebook, we have designed a set of guides:

First off, the **Just for Starters...** poster helps you get started with setting up your computer.

TravelMate Series Generic User Guide contains useful information applying to all models in the TravelMate product series. It covers basic topics such as Acer's Empowering Technology, using the keyboard, Audio, etc. Please understand that due to its nature, the **Generic User Guide** as well as the **AcerSystem User Guide** mentioned below will occasionally refer to functions or features which are only contained in certain models of the series, but not necessarily in the model you purchased. Such instances are marked in the text with language such as "only for certain models".

Quick Guide introduces you to the basic features and functions of your new computer. For more on how your computer can help you to be more productive, please refer to the **AcerSystem User Guide**. This guide contains detailed information on such subjects as system utilities, data recovery, expansion options and troubleshooting. In addition it contains warranty information and the general regulations and safety notices for your notebook. It is available in Portable Document Format (PDF) and comes preloaded on your notebook. Follow these steps to access it:

- 1 Click on  **Start, All Programs, AcerSystem.**
- 2 Click on **AcerSystem User Guide.**



Note: Viewing the file requires Adobe Reader. If Adobe Reader is not installed on your computer, clicking on **AcerSystem User Guide** will run the Adobe Reader setup program first. Follow the instructions on the screen to complete the installation. For instructions on how to use Adobe Reader, access the **Help and Support** menu.

Your Acer notebook tour

After setting up your computer as illustrated in the **Just for Starters...** poster, let us show you around your new Acer notebook.

Top view







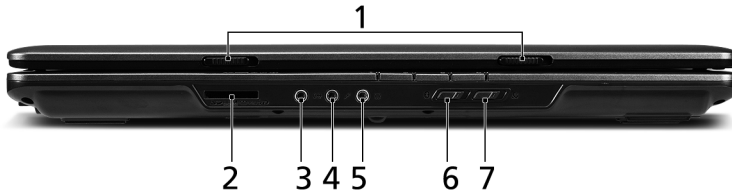

#	Item	Description
1	Acer Crystal Eye	Web camera for video communication (only for certain models).

#	Item	Description
2	Acer PureZone	Two internal stereo microphones for sound recording.
3	Display screen	Also called Liquid-Crystal Display (LCD), displays computer output.
4	Speakers	Left and right speakers deliver stereo audio output.
5	Empowering key	Launch Acer Empowering Technology
6	Productivity keys	Three productivity keys give users one-touch access to protection and manageability features for a more secure, smarter and easier way to work. Please refer to " Generic User Guide " for more details.
7	Easy-launch buttons	Buttons for launching frequently used programs. Please refer to " Generic User Guide " for more details.
8	Palmrest	Comfortable support area for your hands when you use the computer.
9	Touchpad	Touch-sensitive pointing device which functions like a computer mouse.
10	Click buttons (left, center* and right)	The left and right buttons function like the left and right mouse buttons. *The center button serves as Acer BioProtect fingerprint reader supporting Acer FingerNav 4-way control function (manufacturing option).
11	Acer Bio-Protection fingerprint reader	The center button serves as Acer Bio-Protection fingerprint reader supporting Acer FingerNav 4-way control function (only for certain models).
12/15	Status indicators	Light-Emitting Diodes (LEDs) that light up to show the status of the computer's functions and components. Please refer to " Generic User Guide " for more details.
13	Keyboard	For entering data into your computer.
14	Power button	Turns the computer on and off.







Closed front view

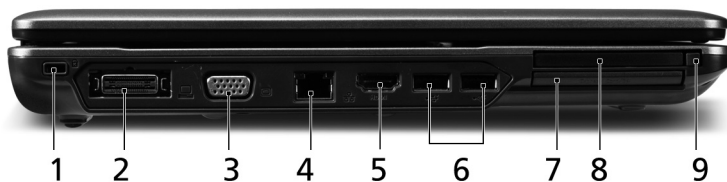

#	Icon	Item	Description
1		Latch	Locks and releases the lid.
2		5-in-1 card reader	Accepts Secure Digital (SD), MultiMediaCard (MMC), Memory Stick (MS), Memory Stick Pro (MS PRO), and xD-Picture Card. Note: Only one card can operate at any given time.
3		Line-in jack	Accepts audio line-in devices (e.g., audio CD player, stereo walkman, mp3 player)
4		Microphone jack	Accepts inputs from external microphones.
5		Headphones/speaker/line-out jack.	Connects to audio line-out devices (e.g., speakers, headphones).
6		Bluetooth communication switch	Enable/disable the Bluetooth function.
7		Wireless communication switch	Enable/disable the wireless function.

Left view



#	Icon	Item	Description
1		Kensington lock slot	Connects to a Kensington-compatible computer security lock.
2		Acer EasyPort IV connector	Connects to Acer EasyPort IV.
3		External display (VGA) port	Connects to a display device (e.g., external monitor, LCD projector).
4		Ethernet (RJ-45) port	Connects to an Ethernet 10/100/1000-based network.
5	HDMI	HDMI port	Supports high definition digital video connections.
6		Two USB 2.0 ports	Connect to USB 2.0 devices (e.g., USB mouse, USB camera).
7		PC Card slot	Accepts one Type II PC Card.
8		ExpressCard/54 slot	Accepts one ExpressCard/54 module.
9		PC Card slot eject button	Ejects the PC Card from the slot.



Right view



#	Item	Description
1	Optical drive	Internal optical drive; accepts CDs or DVDs.
2	Optical disk access indicator	Lights up when the optical drive is active.
3	Optical drive eject button	Ejects the optical disk from the drive.
4	Emergency eject hole	Ejects the optical drive tray when the computer is turned off. Note: Insert a paper clip to the emergency eject hole to eject the optical drive tray when the computer is off.



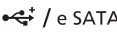

Rear view

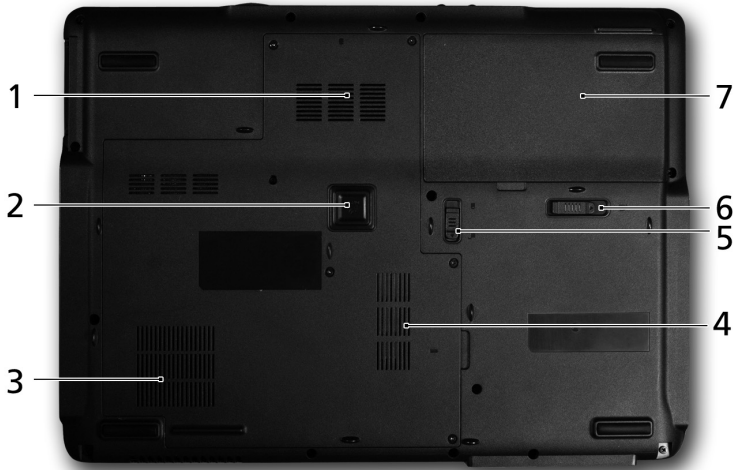

#	Icon	Item	Description
1		USB 2.0 port	Connects to USB 2.0 devices (e.g., USB mouse, USB camera).
2		USB 2.0/ eSATA port	Connects to USB 2.0 or eSATA devices. Note: If you plug an eSATA device you will have three USB ports available in the mean time.
3		Modem (RJ-11) port	Connects to a phone line.
4		DC-in jack	Connects to an AC adapter.
5		Ventilation slots	Enable the computer to stay cool, even after prolonged use.

Base view



#	Icon	Item	Description
1		Hard disk bay	Houses the computer's hard disk (secured with screws)
2		Acer DASP (Disk Anti-Shock Protection)	Protects the hard disk drive from shocks and bumps.
3		Ventilation slots and cooling fan	Enable the computer to stay cool, even after prolonged use. Note: Do not cover or obstruct the opening of the fan.
4		Memory compartment	Houses the computer's main memory.
5		Battery lock	Locks the battery in position.
6		Battery release latch	Releases the battery to remove the battery pack.
7		Battery bay	Houses the computer's battery pack.

Specifications

Operating system	<ul style="list-style-type: none"> Windows Vista™
Platform	<ul style="list-style-type: none"> Intel® Centrino® 2 processor technology, featuring: <ul style="list-style-type: none"> Intel® Core™ 2 Duo mobile processor Mobile Intel® GM45/PM45 Express Chipset* Intel® Wireless WiFi Link 5100/5300
System memory	<ul style="list-style-type: none"> Dual-Channel DDR2 support Up to 2 GB of DDR2 667 MHz memory, upgradeable to 4 GB using two soDIMM modules*
Display	<ul style="list-style-type: none"> 15.4" WXGA 1280 x 800
Graphics	<ul style="list-style-type: none"> Mobile Intel® GM45 Express Chipset* ATI Mobility Radeon™ HD 3470* ATI Mobility Radeon™ HD 3650* NVIDIA® GeForce® 9300M GS*
Storage subsystem	<ul style="list-style-type: none"> 2.5" hard disk drive Optical drive options: <ul style="list-style-type: none"> Blu-ray Disc™/DVD-Super Multi double-layer drive DVD-Super Multi double-layer drive DVD/CD-RW combo drive 5-in-1 card reader
Audio	<ul style="list-style-type: none"> Two built-in Acer 3DSonic stereo speakers High-definition audio support MS-Sound compatible Acer PureZone technology with two built-in stereo microphones Built-in microphone
Communication	<ul style="list-style-type: none"> Acer Video Conference, featuring: <ul style="list-style-type: none"> Integrated Acer Crystal Eye webcam* Optional Acer Xpress VoIP phone WLAN: Intel® Wireless WiFi Link 5100/5300 WPAN: Bluetooth® 2.0+EDR LAN: Gigabit Ethernet, Wake-on-LAN ready Modem: 56K ITU V.92
Privacy control	<ul style="list-style-type: none"> Enhanced Acer DASP (Disk Anti-Shock Protection) Acer Bio-Protection fingerprint solution* BIOS user, supervisor, HDD passwords Kensington lock slot

Dimensions	<ul style="list-style-type: none"> • 360 (W) x 267 (D) x 30.3/43 (H) mm (14.17 x 10.51 x 1.09/1.69 inches) • 3.02 kg (6.64 lbs)* • 2.88 kg (6.34 lbs)*
Power subsystem	<ul style="list-style-type: none"> • ACPI 3.0 • 71 W 4800 mAh* • 44.4W 4000 mAh* • 3-pin 65/90 W AC adapter* • Energy Star 4.0
Input devices	<ul style="list-style-type: none"> • 88-/89-key keyboard
I/O interface	<ul style="list-style-type: none"> • Acer EasyPort IV connector • ExpressCard™/54 slot • PC Card slot (Type II) • Acer Bio-Protection fingerprint reader* • 5-in-1 card reader (SD™, MMC, MS, MS PRO, xD) • HDMI™ port with HDCP support • Three USB 2.0 ports • USB 2.0/ eSATA port <div style="margin-top: 10px;">  <p>Note: If you plug an eSATA device you will have three USB ports available in the mean time.</p> <ul style="list-style-type: none"> • External display (VGA) port • Headphone/speaker/line-out jack • Microphone-in jack • Line-in jack • Ethernet (RJ-45) port • Modem (RJ-11) port • DC-in jack for AC adapter </div>
Environment	<ul style="list-style-type: none"> • Temperature: <ul style="list-style-type: none"> • Operating: 5 °C to 35 °C • Non-operating: -20 °C to 65 °C • Humidity (non-condensing): <ul style="list-style-type: none"> • Operating: 20% to 80% • Non-operating: 20% to 80%



Note: "*" "only for certain models".



Note: The specifications listed above are for reference only. The exact configuration of your PC depends on the model purchased.

Free Manuals Download Website

<http://myh66.com>

<http://usermanuals.us>

<http://www.somanuals.com>

<http://www.4manuals.cc>

<http://www.manual-lib.com>

<http://www.404manual.com>

<http://www.luxmanual.com>

<http://aubethermostatmanual.com>

Golf course search by state

<http://golfingnear.com>

Email search by domain

<http://emailbydomain.com>

Auto manuals search

<http://auto.somanuals.com>

TV manuals search

<http://tv.somanuals.com>