

TravelMate 8172/8172Z Series Service Guide

Service guide files and updates are available on the ACER/CSD web; for more information, please refer to <http://csd.acer.com.tw>

PRINTED IN TAIWAN

Revision History

Please refer to the table below for the updates made on TravelMate 8172/8172Z service guide.

Date	Chapter	Updates

Copyright

Copyright © 2010 by Acer Incorporated. All rights reserved. No part of this publication may be reproduced, transmitted, transcribed, stored in a retrieval system, or translated into any language or computer language, in any form or by any means, electronic, mechanical, magnetic, optical, chemical, manual or otherwise, without the prior written permission of Acer Incorporated.

Disclaimer

The information in this guide is subject to change without notice.

Acer Incorporated makes no representations or warranties, either expressed or implied, with respect to the contents hereof and specifically disclaims any warranties of merchantability or fitness for any particular purpose. Any Acer Incorporated software described in this manual is sold or licensed “as is”. Should the programs prove defective following their purchase, the buyer (and not Acer Incorporated, its distributor, or its dealer) assumes the entire cost of all necessary servicing, repair, and any incidental or consequential damages resulting from any defect in the software.

Acer is a registered trademark of Acer Corporation.

Intel is a registered trademark of Intel Corporation.

Pentium and Pentium II/III are trademarks of Intel Corporation.

Other brand and product names are trademarks and/or registered trademarks of their respective holders.

Conventions

The following conventions are used in this manual:

SCREEN MESSAGES	Denotes actual messages that appear on screen.
NOTE	Gives bits and pieces of additional information related to the current topic.
WARNING	Alerts you to any damage that might result from doing or not doing specific actions.
CAUTION	Gives precautionary measures to avoid possible hardware or software problems.
IMPORTANT	Reminds you to do specific actions relevant to the accomplishment of procedures.

Preface

Before using this information and the product it supports, please read the following general information.

1. This Service Guide provides you with all technical information relating to the BASIC CONFIGURATION decided for Acer's "global" product offering. To better fit local market requirements and enhance product competitiveness, your regional office MAY have decided to extend the functionality of a machine (e.g. add-on card, modem, or extra memory capability). These LOCALIZED FEATURES will NOT be covered in this generic service guide. In such cases, please contact your regional offices or the responsible personnel/channel to provide you with further technical details.
2. Please note WHEN ORDERING FRU PARTS, that you should check the most up-to-date information available on your regional web or channel. If, for whatever reason, a part number change is made, it will not be noted in the printed Service Guide. For ACER-AUTHORIZED SERVICE PROVIDERS, your Acer office may have a DIFFERENT part number code to those given in the FRU list of this printed Service Guide. You MUST use the list provided by your regional Acer office to order FRU parts for repair and service of customer machines.

System Specifications	1
System Block Diagram	5
Board Layout	6
Top View	6
Bottom View	7
Your Acer Notebook tour	9
Top View	9
Closed Front View	10
Rear view	10
Left View	11
Right View	11
Base view	12
Touchpad Basics (with fingerprint reader)	13
Touchpad basics (with two-click buttons)	14
Using the Keyboard	15
Lock Keys and embedded numeric keypad*	15
Windows Keys	16
Hot Keys	17
Using the system utilities	18
Acer Backup Manager	20
Power management	21
Acer PowerSmart key	21
Acer eRecovery Management	21
Burn backup discs	22
Restore	22
Hardware Specifications and Configurations	24
BIOS Setup Utility	29
System Utilities	29
Invoking BIOS Setup	30
Information	30
Main	31
Security	33
Boot	36
Exit	36
BIOS Flash Utility	39
DOS flash BIOS SOP	40
Clean BIOS Password SOP	43
Clean HDD Password SOP	48
Crisis Disk SOP	54
DMI Utility SOP	57
LAN EEPROM Utility SOP	61
Winflash SOP	65
Disassembly Requirements	69
Related Information	69
Replacement Requirements	69
.....	69
Machine Disassembly and Replacement	69
Pre-disassembly Instructions	70
Disassemble Process	71
External Module Disassembly Process	71
Removing the Battery Pack	72
Removing the HDD.	74

Table of Contents

Removing the DIMM module	78
Remove the Wireless module	81
LCD Module Disassembly Process	83
Removing the keyboard	84
Removing the Upper Case	87
Removing the LCD Module	91
Removing the Bluetooth Module	98
Removing the Mainboard	100
LCD Module Disassembly Process	113
Removing the Mainboard	114
Removing the Camera Board	118
Remove the Antennas	119
LCD Reassembly	124
Replacing the Antenna	124
Replacing the Camera Board	128
Replace the Wireless LAN Module	129
Replacing LCM Module	130
Replacing the Mainboard	135
Replacing the Panel	144
Replacing the Bluetooth Module	151
Replacing the Upper Case	152
Replacing the keyboard	156
Replace the Wireless LAN Module	158
Replace the DIMM module	159
Replacing HDD module	162
Replacing the battery	164
Troubleshooting	165
System Check Procedures	166
External Diskette Drive Check	166
External CD-ROM Drive Check	166
Keyboard or Auxiliary Input Device Check	166
Memory check	167
Power System Check	167
Touchpad Check	168
Power-On Self-Test (POST) Error Message	169
Index of Error Messages	170
InsydeH2O BIOS Beep Codes	173
Index of Symptom-to-FRU Error Message	177
Intermittent Problems	181
Undetermined Problems	182
Jumper and Connector Locations	183
Top View	183
Bottom View	184
FRU (Field Replaceable Unit) List	187
TravelMate 8172/8172Z Exploded Diagram	188
TravelMate 8172/8172Z FRU List	191
Model Definition and Configuration	203
Test Compatible Components	223
Online Support Information	231

System Specifications

Features

Below is a brief summary of the computer's many features:

Operating system

- Genuine Windows® 7 Professional 32-bit
- Genuine Windows® 7 Home Premium 64-bit

CPU and chipset

- Intel® Core™ i5-430UM/i5-520UM/i5-540UM processor (3 MB L3 cache, 1.20/1.06/1.20 GHz with Turbo Boost up to 1.73/1.86/2 GHz, DDR3 800 MHz, 18 W), supporting Intel® 64 architecture, Intel® Smart Cache
- Intel® Core™ i3-330UM processor (3 MB L3 cache, 1.20 GHz, DDR3 800 MHz, 18 W), supporting Intel® 64 architecture, Intel® Smart Cache
- Mobile Intel® HM55 Express Chipset (for TM8172Z)

Memory

- Dual-channel DDR3 SDRAM support:
 - Up to 2 GB of DDR3 system memory, upgradable to 4 GB using two soDIMM modules

Display and graphics

- 11.6" HD 1366 x 768 (WXGA) pixel resolution, high-brightness (200-nit) LED-backlit TFT LCD
- Mercury-free environment friendly
- Intel® HD Graphics with 128 MB of dedicated system memory, supporting Microsoft® DirectX® 10
- Dual independent display support
- 16.7 million colors
- External resolution / refresh rate:
 - VGA port up to 2560 x 1600 : 60 Hz
- MPEG-2/DVD decoding
- WMV9 (VC-1) and H.264 (AVC) decoding

Storage subsystem

- Hard disk drive:
 - 160/250/320/500/640 GB or larger
- Multi-in-1 card reader, supporting:
 - Secure Digital™ (SD) Card, MultiMediaCard™(MMC), Memory Stick™ (MS), Memory Stick PRO™(MS PRO), xD-Picture Card™(xD)
 - Supported 8GB (test pass)

Dimensions and weight

- ❑ Dimensions:
 - 285 (W) x 206.3 (D) x 20.2/29.1 (H) mm (11.22 x 8.12 x 0.795/ 1.146 inches)
- ❑ Weight:
 - 1.35 kg (2.97 lbs.) with 6-cell battery pack (non-3G model)

Power adapter and battery

ACPI 3.0 CPU power management standard: supports Standby and Hibernation power-saving modes

- ❑ Power adapter: 2-pin 40 W Acer MiniGo AC adapter
 - 93.2 (W) x 32.2 (D) x 42.5 (H) mm (3.66 x 1.26 x 1.67 inches)
 - 180 g (0.39 lbs.) with 250 cm DC cable
 - 210 g (0.47 lbs.) with 250 cm DC cable and one AC power plug
- ❑ Battery
- ❑ 24 W 2200 mAh 3-cell Li-ion battery pack
Battery life: 3 hours
- ❑ 48 W 4400 mAh 6-cell Li-ion battery pack
Battery life: 6 hours
- ❑ 63 W 5600 mAh 6-cell Li-ion battery pack
Battery life: 8 hours
- ❑ ENERGY STAR®

Input and control

- ❑ Keyboard
 - 84-/85-/88-key full-size Acer FineTip keyboard with international language support
- ❑ Touchpad
 - Multi-gesture touchpad, supporting two-finger scroll, pinch, rotate, flip
- ❑ Control key
 - Acer Bio-Protection fingerprint reader

Audio

- ❑ Two built-in stereo speakers
- ❑ High-definition audio support
- ❑ MS-Sound compatible
- ❑ Built-in microphone

Webcam

- ❑ Acer Video Conference, featuring:
 - Acer Crystal Eye webcam with 1280 x 1024 resolution
 - Acer Video Conference Manager software, featuring Video Quality Enhancement (VQE) technology, supporting 640 x 480 resolution online video calls

Wireless and networking

- ❑ WLAN:
 - Acer InviLink™ Nplify™ 802.11b/g/n Wi-Fi CERTIFIED™
 - Acer InviLink™ 802.11b/g Wi-Fi CERTIFIED™
 - Supporting Acer SignalUp™ wireless technology

-
- WPAN: BluetoothR 3.0+HS
 - WWAN: UMTS/HSPA at 900/2100 MHz and quad-band GSM/GPRS/EDGE at 850/900/1800/1900 MHz, upgradable to 7.2 Mb/s HSDPA and 5.7 Mb/s HSUPA (for 3G model)
 - LAN: Gigabit Ethernet, Wake-on-LAN ready

Input and output

- Acer Easyport IV connector
- Multi-in-1 card reader (SD, MMC, MS, MS PRO, xD)
- Three USB 2.0 ports
- External display (VGA) port
- Headphone/speaker/line-out jack
- Microphone-in jack
- Ethernet (RJ-45) port
- DC-in jack for AC adapter

Security

- Acer Bio-Protection fingerprint solution, featuring Pre-Boot Authentication (PBA), computer protection, Acer FingerLaunch
- BIOS user, supervisor, HDD passwords
- Kensington lock slot

Software

- Productivity
 - Acer ePower Management
 - Acer eRecovery Management
 - Adobe® Flash® Player 10
 - Adobe® Reader® 9.1
 - eSobi™
 - Google Toolbar™
 - Microsoft® Office Personal 2007 (Service Pack 2)(Japan only, subject to customer request)
 - Microsoft® Office Ready (Service Pack 2)
 - Norton™ Online Backup
- Security
 - Acer Bio-Protection
 - McAfee® Internet Security Suite Trial
- InstantOn
 - Instant View
- Multimedia
 - Corel® WinDVD
- Communication and ISP
 - Acer Crystal Eye
 - Acer Video Conference Manager
 - Microsoft® Silverlight™
 - Skype™
 - Windows Live™ Essentials-Wave 3.2 (Mail, Photo Gallery, Live™ Messenger, Movie Maker, Writer)

-
- ❑ Web links and utilities
 - Acer Accessory Store (Belgium, France, Germany, Italy, Netherlands, Spain, Sweden, UK only)
 - Acer Identity Card
 - Acer Registration
 - Acer Updater
 - eBay® shortcut 2009 (Canada, France, Germany, Italy, Mexico, Spain, UK, US only)
 - Netflix shortcut (US only)

Options and accessories

- ❑ 1 GB / 2 GB / DDR3 1066 MHz soDIMM module
- ❑ 6-cell Li-ion battery pack
- ❑ 3-pin 30 W AC adapter
- ❑ External USB HDD
- ❑ External USB optical disc drive
- ❑ Acer Easyport IV

System compliance

- ❑ Wi-Fi®
- ❑ ACPI 3.0
- ❑ Mobile PC 2002
- ❑ DMI 2.0

Warranty

- ❑ One-year International Travelers Warranty (ITW)

Quality and reliability tests

- ❑ Temperature and humidity
- ❑ Hinge life
- ❑ Weight and pressure
- ❑ Acoustics
- ❑ Spillage
- ❑ Free drop
- ❑ Shock and vibration
- ❑ Electrostatic discharge immunity
- ❑ Keyboard-switch life
- ❑ MTBF (mean time between failures)

System Block Diagram

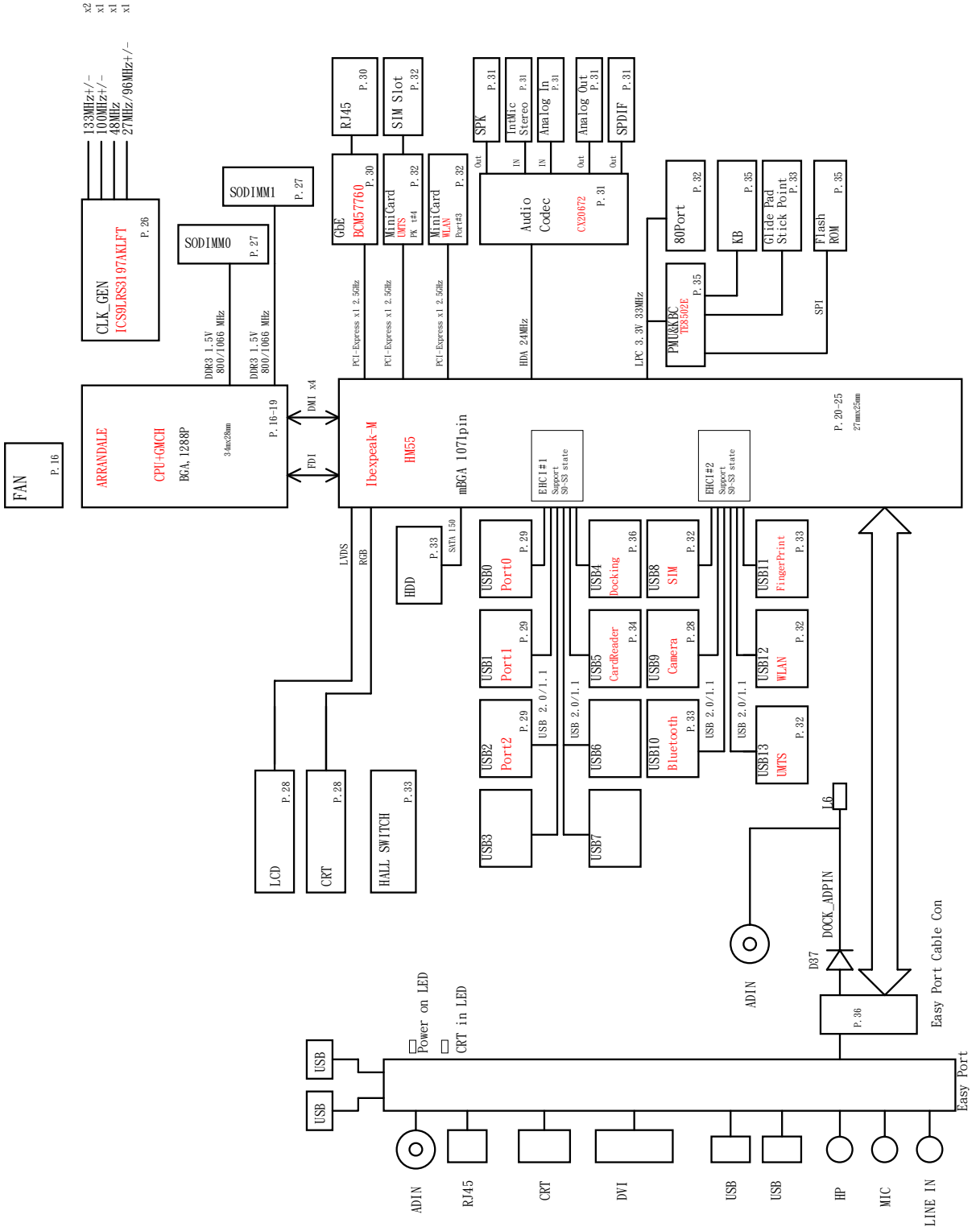

x2
x1
x1
x1

Board Layout

Top View

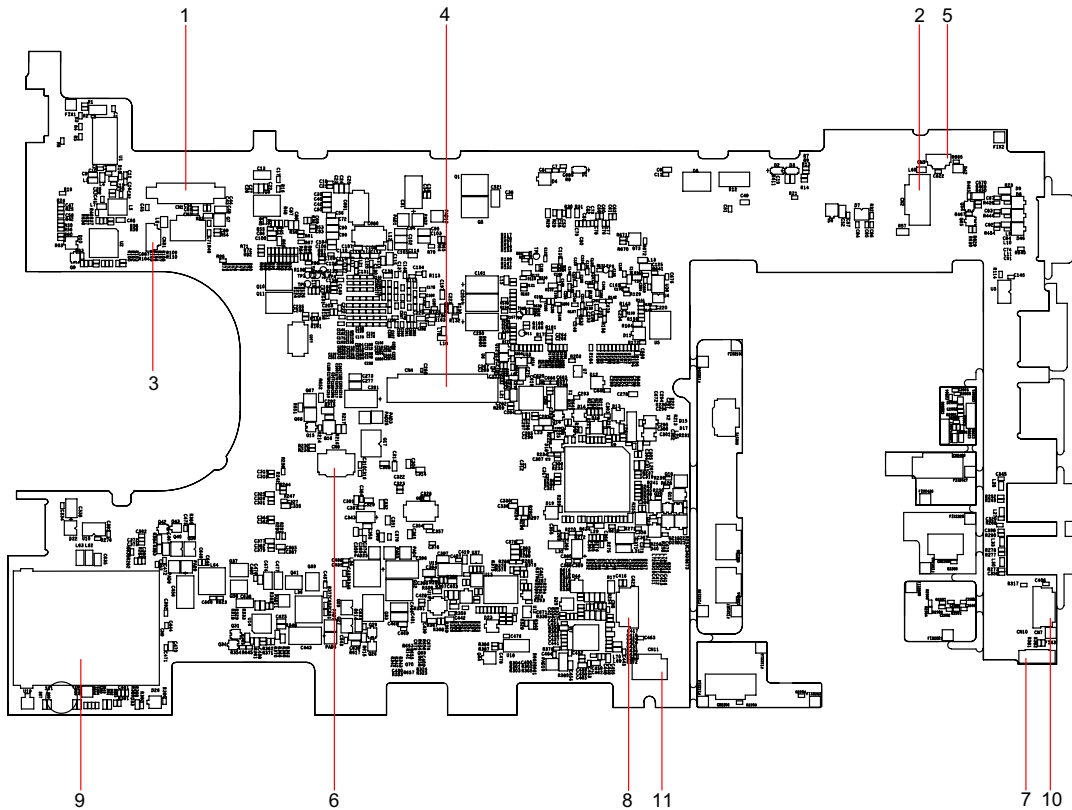

TravelMate 8172/8172Z M/B layout and connector location TOP view		
No.	Name	Description
1	CN1	LCM connector
2	CN2	Power
3	CN4	Keyboard connector
4	CN5	Microphone connector
5	CN6	Touch pad connector
6	CN7	Audio cable connector 1
7	CN8	Audio cable connector 2
8	CN9	Card reader slot
9	CN10	Bluetooth connector
10	CN11	Speaker connector
11	CN31	Webcam connector

Bottom View

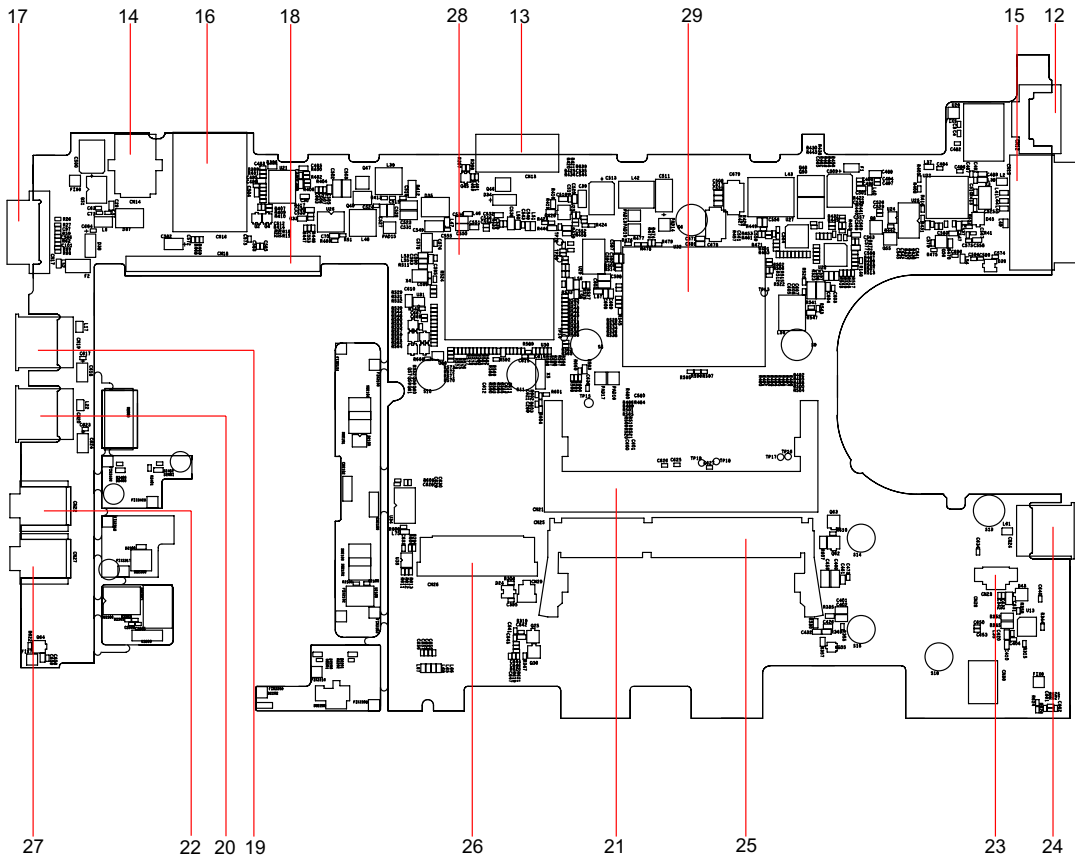

TravelMate 8172/8172Z M/B layout and connector location Bottom view		
No.	Name	Description
12	CN12	LAN slot
13	CN13	Battery connector
14	CN14	DC-in jack
15	CN15	EZ-Docking slot
16	CN16	SIM Card slot
17	CN17	VGA port
18	CN18	HDD connector
19	CN18	USB slot 1
20	CN20	USB slot 2
21	CN21	DIMM-0
22	CN22	MIC jack
23	CN23	Fan connector
24	CN24	USB slot-3
25	CN25	DIMM-1
26	CN26	3G card slot

TravelMate 8172/8172Z M/B layout and connector location Bottom view		
No.	Name	Description
27	CN27	Earphone connector
28	U30	South bridge
29	U32	CPU+ North bridge

Your Acer Notebook tour

After setting up your computer as illustrated in the Just for Starters... poster, let us show you around your new Acer notebook.

Top View







No.	Icon	Item	Description
1		Microphones	Stereo internal microphones for sound recording.
2		Display screen	Also called Liquid-Crystal Display (LCD), displays computer output (Configuration may vary by models).
3		Keyboard	For entering data into your computer.
4		Touchpad	Touch-sensitive pointing device which functions like a computer mouse.
5		Acer Bio-Protection fingerprint reader	The center button serves as the Acer Bio-Protection fingerprint reader, supporting Pre-Boot Authentication (PBA) computer protection, Acer FingerLaunch.
6		Click buttons (left and right)	The left and right buttons function like the left and right mouse buttons.

No.	Icon	Item	Description
7		Power switch	Turns the computer on and off.
8		Acer Crystal Eye webcam	Web camera for video communication.

Closed Front View



No.	Icon	Item	Description
1		Power indicator	Indicates the computer's power status.
		Battery indicator	Indicates the computer's battery status. 1. Charging: The light shows amber when the battery is charging. 2. Fully charged: The light shows blue when in AC mode.
		Communication indicator	Indicates the computer's wireless connectivity device status.
		HDD indicator	Indicates when the hard disk drive is active.



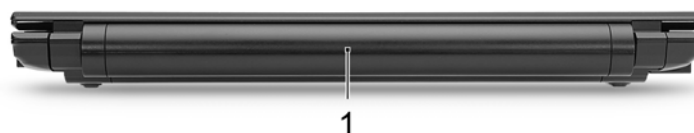

Rear view

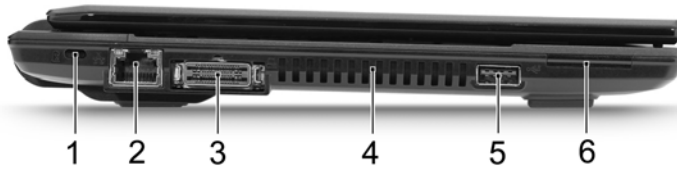

No.	Icon	Item	Description
1		Battery	Provides power for the computer to be used while unplugged.

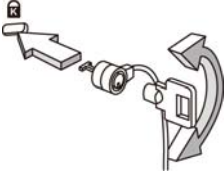

Left View



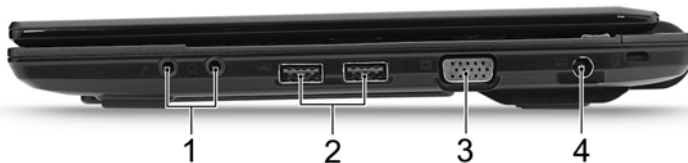

No.	Icon	Item	Description
1		Kensington lock slot 	Connects to a Kensington-compatible computer security lock. NOTE: Wrap the computer security lock cable around an immovable object such as a table or handle of a locked drawer. Insert the lock into the notch and turn the key to secure the lock. Some keyless models are also available.
2		Ethernet (RJ-45) port	Connects to an Ethernet 10/100/1000- based network.
3		Acer EasyPort connector	Connects to Acer EasyPort.
4		Ventilation slots	Enable the computer to stay cool, even after prolonged use.
5		USB 2.0 ports	Connect to USB 2.0 devices (e.g., USB mouse, USB camera).
6		Multi-in-1 card reader	Accepts Secure Digital (SD), MultiMediaCard (MMC), Memory Stick (MS), Memory Stick PRO (MS PRO), xD-Picture Card (xD). NOTE: Push to remove/install the card. Only one card can operate at any given time.

Right View







No.	Icon	Item	Description
1		Microphone-in jack	Accepts inputs from external microphones.
		Headphones/speaker/line-out jack	Connects to audio line-out devices (e.g., speakers, headphones).

No.	Icon	Item	Description
2		USB 2.0 port	Connects to USB 2.0 devices (e.g., USB mouse, USB camera).
3		External display (VGA) port	Connects to a display device (e.g., external monitor, LCD projector).
4		DC-in jack	Connects to an AC adapter.

Base view



No.	Icon	Item	Description
1		Battery bay	Houses the computer's battery pack.
2		Battery lock	Locks the battery in position.
3		Hard disk bay	Houses the computer's hard disk (secured with screws).
4		Acer DASP (Disk Anti-Shock Protection)	Protects the hard disk from shocks and bumps.
5		Memory compartment	Houses the computer's main memory.
6		Battery release latch	Releases the battery for removal.

Environment

- Temperature:
 - Operating: 5°C to 35°C
 - Non-operating: -20°C to 65°C
- Humidity (non-condensing):
 - Operating: 20% to 80%
 - Non-operating: 20% to 80%

Touchpad Basics (with fingerprint reader)

The following items show you how to use the touchpad with Acer Bio-Protection fingerprint reader.

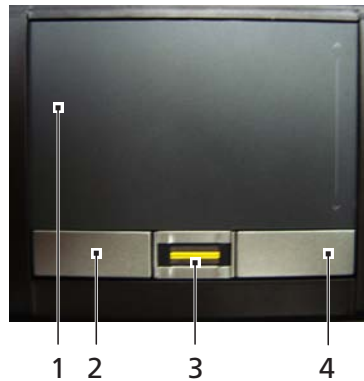

- ❑ Move your finger across the touchpad **(1)** to move the cursor.
- ❑ Press the left **(2)** and right **(4)** buttons located beneath the touchpad to perform selection and execution functions. These two buttons are similar to the left and right buttons on a mouse. Tapping on the touchpad is the same as clicking the left button.
- ❑ Use Acer Bio-Protection fingerprint reader **(3)** supporting Acer FingerNav 4-way control function (only for certain models) to scroll up or down and move left or right a page. This fingerprint reader or button mimics your cursor pressing on the right scroll bar of Windows applications.

Function	Left Button (2)	Right Button (4)	Main touchpad (1)	Center button (3)
Execute	Quickly click twice.		Tap twice (at the same speed as double-clicking a mouse button).	
Select	Click once.		Tap once.	
Drag	Click and hold, then use finger on the touchpad to drag the cursor.		Tap twice (at the same speed as double-clicking a mouse button); rest your finger on the touchpad on the second tap and drag the cursor.	
Access context menu		Click once.		
Scroll				Swipe up/down/left/right using Acer FingerNav 4-way control function(Manufacturing option).

Touchpad basics (with two-click buttons)

The following items show you how to use the touchpad with two-click buttons.

- ❑ Move your finger across the touchpad to move the cursor.
- ❑ Press the left and right buttons located beneath the touchpad to perform selection and execution functions. These two buttons are similar to the left and right buttons on a mouse. Tapping on the touchpad is the same as clicking the left button.

Function	Left Button	Right Button	Main touchpad
Execute	Quickly click twice.		Tap twice (at the same speed as double-clicking a mouse button).
Select	Click once.		Tap once.
Drag	Click and hold, then use finger on the touchpad to drag the cursor.		Tap twice (at the same speed as double-clicking a mouse button); rest your finger on the touchpad on the second tap and drag the cursor.
Access context menu		Click once.	

NOTE: Illustrations for reference only. The exact configuration of your PC depends on the model purchased.

NOTE: When using the touchpad, keep it — and your fingers — dry and clean. The touchpad is sensitive to finger movement; hence, the lighter the touch, the better the response. Tapping harder will not increase the touchpad's responsiveness.

NOTE: By default, vertical and horizontal scrolling is enabled on your touchpad. It can be disabled under Mouse settings in Windows Control Panel.

Using the Keyboard

The keyboard has full-sized keys and an embedded numeric keypad*, separate cursor, lock, Windows, function and special keys.

Lock Keys and embedded numeric keypad*

The keyboard has three lock keys which you can toggle on and off.

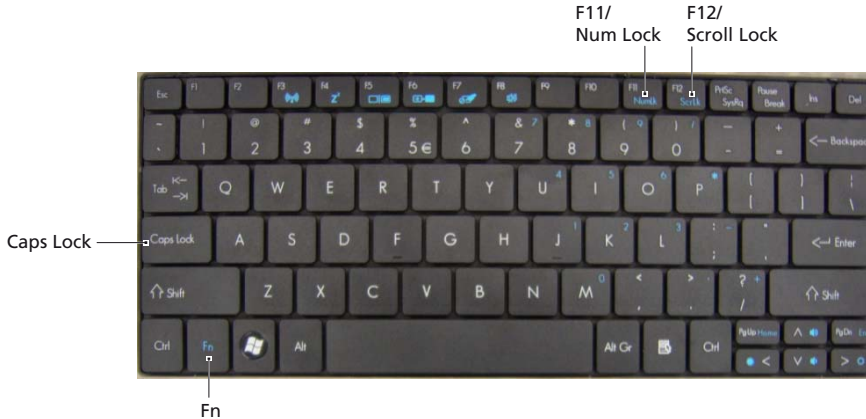

Lock key	Description
Caps Lock	When Caps Lock is on, all alphabetic characters typed are in uppercase.
Num Lock <Fn> + <F11>*	When Num Lock is on, the embedded keypad is in numeric mode. The keys function as a calculator (complete with the arithmetic operators +, -, *, and /). Use this mode when you need to do a lot of numeric data entry. A better solution would be to connect an external keypad.
Scroll Lock <Fn> + <F12>	When Scroll Lock is on, the screen moves one line up or down when you press the up or down arrow keys respectively. Scroll Lock does not work with some applications.



















The embedded numeric keypad functions like a desktop numeric keypad. It is indicated by small characters located on the upper right corner of the keycaps. To simplify the keyboard legend, cursor-control key symbols are not printed on the keys.

Desired access	Num Lock on	Num Lock off
Number keys on embedded keypad	Type numbers in a normal manner.	
Cursor-control keys on embedded keypad	Hold <Shift> while using cursor-control keys.	Hold <Fn> while using cursor-control keys.
Main keyboard keys	Hold <Fn> while typing letters on embedded keypad.	Type the letters in a normal manner.

* only for certain models

Windows Keys

The keyboard has two keys that perform Windows-specific functions.









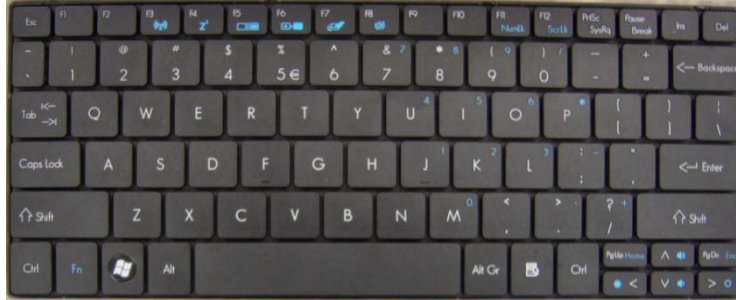

Key	Description
 Windows key	<p>Pressed alone, this key has the same effect as clicking on the Windows Start button; it launches the Start menu.</p> <p>It can also be used with other keys to provide a variety of functions:</p> <ul style="list-style-type: none"><  > : Open or close the Start menu.<  > + < D >: Display the desktop.<  > + < E >: Open Windows Explore.<  > + < F >: Search for a file or folder.<  > + < G >: Cycle through Sidebar gadgets.<  > + < L >: Lock your computer (if you are connected to a network domain), or switch users (if you're not connected to a network domain).<  > + < M >: Minimizes all windows.<  > + < R >: Open the Run dialog box.<  > + < T >: Cycle through programs on the taskbar.<  > + < U >: Open Ease of Access Center.<  > + < X >: Open Windows Mobility Center.<  > + < BREAK >: Display the System Properties dialog box.<  > + < SHIFT+M >: Restore minimized windows to the desktop.<  > + < TAB >: Cycle through programs on the taskbar by using Windows Flip 3-D.<  > + < SPACEBAR >: Bring all gadgets to the front and select Windows Sidebar.< CTRL > + <  > + < F >: Search for computers (if you are on a network).< CTRL > + <  > + < TAB >: Use the arrow keys to cycle through programs on the taskbar by using Windows Flip 3-D. <p>NOTE: Depending on your edition of Windows Vista, some shortcuts may not function as described.</p>
 Application key	<p>This key has the same effect as clicking the right mouse button; it opens the application's context menu.</p>

Hot Keys

The computer employs hotkeys or key combinations to access most of the computer's controls like screen brightness and volume output.

To activate hot keys, press and hold the <Fn> key before pressing the other key in the hotkey combination.



Hotkey	Icon	Function	Description
<Fn> + <F3>		Communication	Enables / disables the computer's communication devices. (Communication devices may vary by configuration.)
<Fn> + <F4>		Sleep	Puts the computer in Sleep mode.
<Fn> + <F5>		Display toggle	Switches display output between the display screen, external monitor (if connected) and both.
<Fn> + <F6>		Display off	Turns the display screen backlight off to save power. Press any key to return.
<Fn> + <F7>		Touchpad toggle	Turns the touchpad on and off.
<Fn> + <F8>		Speaker toggle	Turns the speakers on and off.
<Fn> + <Δ>		Volume up	Increases the sound volume.
<Fn> + <∇>		Volume down	Decreases the sound volume.
<Fn> + <▷>		Brightness up	Increases the screen brightness.
<Fn> + <◁>		Brightness down	Decreases the screen brightness.

Using the system utilities

Acer Bio-Protection (only for certain models)

Acer Bio-Protection Fingerprint Solution is a multi-purpose fingerprint software package integrated with the Microsoft Windows operating system. Utilizing the uniqueness of one's fingerprint, Acer Bio-Protection Fingerprint Solution incorporates protection against unauthorized access to your computer with centralized password management via Password Bank; easy music player launching with Acer MusicLaunch*; secure Internet favorites via Acer MyLaunch*; and fast application/website launching and login with Acer FingerLaunch. Acer ProfileLaunch** can launch up to three applications/ websites with a single finger swipe.

Acer Bio-Protection Fingerprint Solution also allows you to navigate through web browsers and documents using Acer FingerNav*. With Acer Bio-Protection Fingerprint Solution, you can now enjoy an extra layer of protection for your personal computer, as well as the convenience of accessing your daily tasks with a simple swipe of your finger!

For more information, refer to the Acer Bio-Protection help files.

NOTE:

* Acer ProfileLaunch, MusicLaunch, MyLaunch and FingerNav are only available on select models.

** In models without Acer ProfileLaunch, Acer FingerLaunch can be used to open applications in the Acer ProfileLaunch icons area; a single finger swipe will launch only one application at a time.

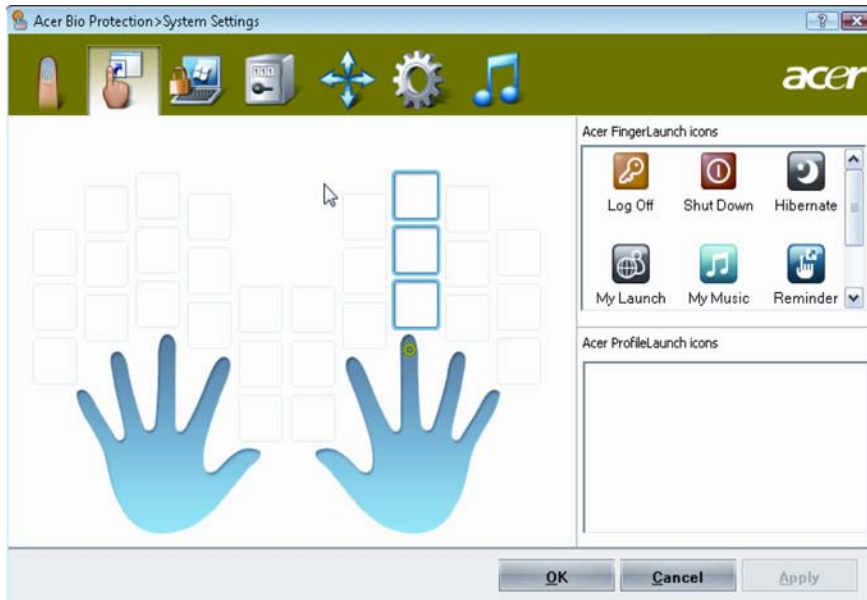

Acer GridVista (dual-display compatible)

NOTE: This feature is only available on certain models.

To enable the dual display feature of your notebook, first ensure that a second display is connected, then, open the Display Settings properties box using the Control Panel or by right-clicking the Windows desktop and selecting **Personalize**. Select the secondary monitor (**2**) icon in the display box and then click the check box **Extend the desktop onto this monitor**. Finally, click **Apply** to confirm the new settings and click **OK** to complete the process.

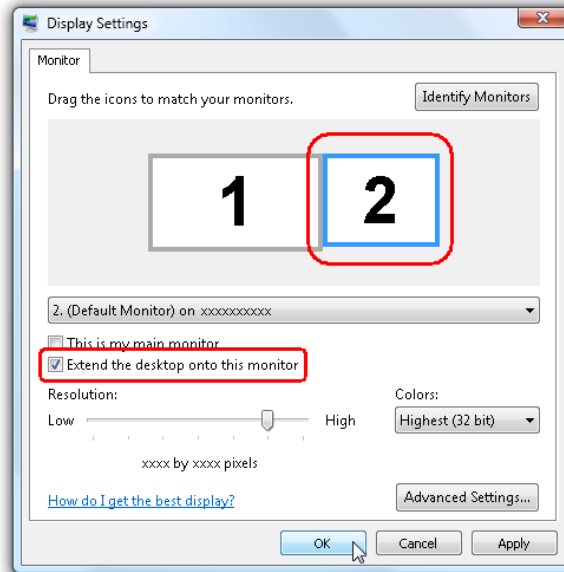

Acer GridVista is a handy utility that offers four pre-defined display settings so you can view multiple windows on the same screen. To access this function, please go to **Start, All Programs** and click on **Acer GridVista**. You may choose any one of the four display settings indicated below:

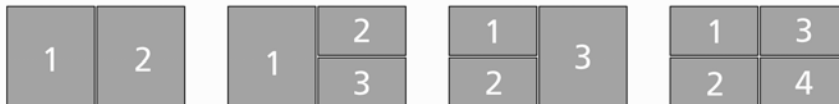

Double (vertical), Triple (primary at left), Triple (primary at right), or Quad.

Acer GridVista is dual-display compatible, allowing two displays to be partitioned independently.

Acer GridVista is simple to set up:

1. Run Acer GridVista and select your preferred screen configuration for each display from the taskbar.
2. Drag and drop each window into the appropriate grid.

3. Enjoy the convenience of a well-organized desktop.

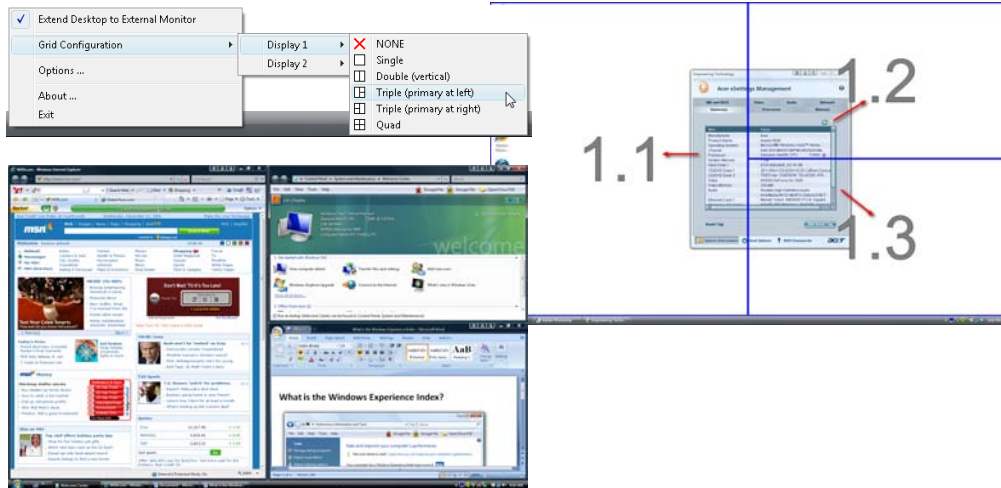

NOTE: Please ensure that the resolution setting of the second monitor is set to the manufacturer's recommended value.

Acer Backup Manager

NOTE: This feature is only available on certain models.

Acer Backup Manager is a simple three-step process that allows you to create backup copies of your entire system or selected files and folders according to a schedule or as you need to.

To start Acer Backup Manager, press the Acer Backup Manager key above the keyboard. Alternatively, you can go to **Start > All Programs > Acer Backup Manager > Acer Backup Manager**. This will open the Welcome screen; from this screen you will be taken through the three steps to setup scheduled backups.

Click **Continue** to proceed to the following screen. Click the + button and follow the onscreen instructions:

1. Select the content you want to back up. The less content you select, the quicker the process will be, but it will increase your risks of losing data.
2. Select where you want the backup copies to be stored. You will need to select an external drive or your D: drive; Acer Backup Manager cannot store a backup on the source drive.
3. Select how often you want Acer Backup Manager to create backups.

Once you have finished these three steps, backups will be created according to the schedule. You can also create backups manually by pressing the Acer Backup Manager key.

If you wish to change your settings at any time, run Acer Backup Manager from the **Start** menu and go through the steps outlined above.

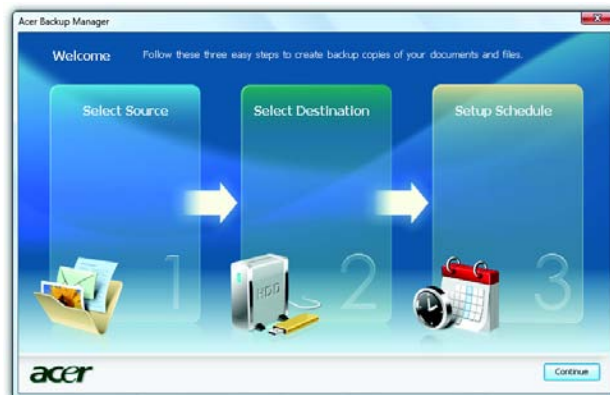

Power management

This computer has a built-in power management unit that monitors system activity. System activity refers to any activity involving one or more of the following devices: keyboard, mouse, hard disk, peripherals connected to the computer, and video memory. If no activity is detected for a period of time (called an inactivity timeout), the computer stops some or all of these devices in order to conserve energy.

This computer employs a power management scheme that supports the advanced configuration and power interface (ACPI), which allows for maximum power conservation and maximum performance at the same time. Windows handles all power-saving chores for your computer.

Acer PowerSmart key

The Acer PowerSmart key uses the power-saving features of your computer's graphics sub-system to reduce overall power consumption. When you press the Acer PowerSmart key, the screen brightness is reduced and the graphics chip switched to a lower speed; PCI and WLAN switch to power-saving modes. Press the Acer PowerSmart key again to return to your previous settings.

NOTE: This feature is only available on certain models.

Acer eRecovery Management

Acer eRecovery Management is a tool to quickly restore the system. You can back up/restore the factory default image, and reinstall applications and drivers.

NOTE: All of the following content is for general reference only. Actual product specifications may vary.

Acer eRecovery Management consists of the following functions:

1. Backup:
 - Create Factory Default Disc
 - Create Drivers and Applications Disc
2. Restore:
 - Completely Restore System to Factory Defaults
 - Restore Operating System and Retain User Data
 - Reinstall Drivers or Applications

This chapter will guide you through each process.

NOTE: This feature is only available on certain models. For systems that do not have a built-in optical disc burner, plug in an external optical disc burner before entering Acer eRecovery Management for optical disc-related tasks.

To use the password protection feature of Acer eRecovery Management, you must first set the password. The password is set by launching Acer eRecovery Management and clicking **Settings**.



Burn backup discs

From the Backup page of Acer eRecovery Management, you can burn the factory default image or back up drivers and applications.

1. Click on **Start > All Programs > Acer > Acer eRecovery Management**.
2. Acer eRecovery Management opens to the **Backup** page.



3. Select the type of backup (factory default or drivers and applications) you would like to burn to disc.
4. Follow the instructions on screen to complete the process.

NOTE: Create a factory default image when you want to burn a bootable disc that contains your computer's entire operating system as it was delivered to you from the factory. If you wish to have a disc that will allow you to browse the contents and install selected drivers and applications, create a drivers and application backup instead — this disc will not be bootable.

Restore

The restore feature allows you to restore or recover the system from a factory default image or from previously created CD and DVD backups. You can also reinstall applications and drivers for your Acer system.

1. Click on **Start, All Programs, Acer, Acer eRecovery Management**.
2. Switch to the **Restore** page by clicking **Restore**.



-
3. You can choose to restore the system from a factory default image or reinstall applications and drivers.
 4. Follow the instructions on screen to complete the process.

Restore Windows Vista from backup discs

To restore Windows Vista from your previously burned backup discs, you will need to insert the first backup disc and enable the **F12 Boot Menu** via the BIOS Setup Utility.

1. Turn on your computer and insert the first system recovery disc into the optical disc drive. Restart your computer.
2. During startup when the Acer logo shows, press the **F2** key to enter **BIOS Setup**, where you can set system parameters.
3. Use the left and right arrow keys to select the **Main** submenu.
4. Use the up and down arrow keys to select **F12 Boot Menu**.
5. Use the **F5** or **F6** key to change **F12 Boot Menu** to **Enabled**.
6. Press the **ESC** key to enter the **Exit** submenu, press the **ENTER** key to **Exit Saving Changes**. Press the **ENTER** key again to select **Yes**. The system will reboot.
7. After rebooting, when the Acer logo shows, press the **F12** key to open the **Boot Menu**. Here you can select which device to boot from.
8. Use the arrow keys to select the **IDE CD**, then press the **ENTER** key. Windows will be installed from the recovery disc.
9. Insert the second recovery disc when prompted, then follow the onscreen prompts to complete the restore.
10. Remove the recovery disc from the optical drive once the restore is complete. Do this before rebooting your computer.

If you prefer to set the boot priority for long-term use, you should select the **Boot** submenu.

1. Turn on your computer and insert the first system recovery disc into the optical disc drive. Restart your computer.
2. During startup when the Acer logo shows, press the **F2** key to enter **BIOS Setup**, where you can set system parameters.
3. Use the left and right arrow keys to select the **Boot** submenu.
4. Use the up and down arrow keys to select the **IDE CD** device.
5. Use the **F6** key to move the **IDE CD** device to the highest boot priority, or use the **F5** key to move other devices to a lower boot priority. Ensure that the **IDE CD** device is the highest priority.
6. Press the **ESC** key to enter the **Exit** submenu, press the **ENTER** key to **Exit Saving Changes**. Press the **ENTER** key again to select **Yes**. The system will reboot.
7. When you reboot, Windows will be installed from the recovery disc.
8. Insert the second recovery disc when prompted, then follow the onscreen prompts to complete the restore.
9. Remove the recovery disc from the optical drive once the restore is complete. Do this before rebooting your computer.

Hardware Specifications and Configurations

Processor

Item	Specification
Type	Core i5-540UM
Description	CPU intel Core i5 540UM 1.2G 18W
L3 Cache	8MB
FSB	1.20GHz
TDP (Thermal)	10W
Socket type	BGA

Second Level Cache

Item	Specification
North Bridge	CPU + GMCH
South Bridge	Ibexpeak-M HM55

System Memory

Item	Specification
Technology	DDR3 1066 / 1333MHz
Base memory	DDR3 SO-DIMM x 1 slot (1024) / 2048 / 4096MB DDR3 SDRAM
Expansion memory	DDR3 SO-DIMM x 1 slot (1024) / 2048 / 4096MB DDR3 SDRAM
Maximum memory size	8GB (Thermal evaluation based on 8GB)

Lan Interface

Item	Specification
Controller (AVAP)	Broadcom BCM57760
SPEED	10 / 100 / 1000Mb/s

Wireless LAN

Item	Specification
Module	Intel PP / CP 3rd WiFi 1x2 / 2x2 / BGN/N
Interface	Mini Card
Antenna	2

Pointing Device

Item	Specification
Glide	Multi-touch touch PAD

Bluetooth Interface

Item	Specification
Module	FOX_BRM_2046 T60G928.11
Antenna	on board
controller	CSR
Bluetooth module	Internal USB 2.0

Hard Disk Drive Interface

Item	Specification
HDD form factor	9.5 mm high / 12.5 mm high / solid state disks
Media I/F	SATA
IDE Controller	SATA 150 MB/s

Audio Interface

Item	Specification
Sound Codec (AVAP)	Conexant CX20672-11Z
Internal Speakers	2 (1.5 Watt)
Internal Microphone	Array MIC x 1
Sound Volume	By Hot Key

LCD panel

Item	Specification
Vendor and model name	LED LCD AUO 11.6" WXGA B116XW02 V0 8ms 500:1 LED LCD LPL 11.6" WXGA LP116WH1-TLN1 LF 200nit 8ms 500:1 LED LCD CMO 11.6" WXGA N116B6-L02 C2 LF 200nit 10ms 500:1 LED LCD SAMSUNG 11.6" WXGA LTN116AT03 LF 200nit 16ms 500:1
Screen Diagonal [mm]	293.83
Active Area [mm]	256.125 X 144.0
Pixels H x V	1366x3(RGB) x 768
Pixel Pitch [mm]	0.1875 x 0.1875
Pixel Format	R.G.B. Vertical Stripe
Display Mode	Normally White
White Luminance (ILED=20mA) [cd/m ²] (Note: ILED is LED current)	200 typ. (5 points average) 170 min. (5 points average)
Luminance Uniformity	1.25 max. (5 points)
Contrast Ratio	500:1 typ
Response Time [ms]	8 typ / 16 Max
Nominal Input Voltage VDD [Volt]	+3.3 typ.
Power Consumption [Watt]	4.0 max. (Include Logic and Blu power)
Weight[Grams]	255g max.

Item	Specification			
Physical Size Include bracket [mm]		Min.	Typ.	Max
	Length	267.5	268.0	268.5
	Width	161.0	161.5	162.0
	Thickness	-	-	5.2
Electrical Interface	1 channel LVDS			
Glass Thickness [mm]	0.5			
Surface Treatment	Glare, Hardness 3H, Reflection <4%			
Support Color	262K colors (RGB 6-bit)			
Temperature Range	0 to +50			
Operating[°C]	-20 to +60			
Storage (Non-Operating)[°C]				
RoHS Compliance	RoHS Compliance			
Viewing Angle [degree]		Min.	Typ.	
	Horizontal(Right)	40	45	
	CR=10(Left)	40	45	
	Veritical(Upper)	10	15	
	CR=10(Lower)	30	30	
Brightness	Brightness controlled by Hot Keys			

Card Slot

Item	Specification
5 in 1 card reader (SD/MMC/MS/MSPPro/xD)	RTS5128, supported 8GB (test pass)

WebCAM

Item	Specification
Module	1.3M
Interface	USB

Keyboard

Item	Specification
Controller	Acer NT1T

I/O

Item	Specification
Monitor(VGA)	Yes
HDMI	No
USB	3
Stereo Mic-in	1
SPDIF	1
RJ45	1
mini card socket(Full size)	Full mini card (3G) x 1 & Half mini card (SP WLAN) x 1

Button

Item	Specification
Power on/off (with Visible LED)	1 (mechanical, Blue)
WLAN	None
3G/BT	None
Launch key module(Follow spec)	None
Back up key	None
Power consumption key	None
Volume Control	None

Software

Item	Specification
Operation system	Windows 7
BIOS	Insyde H2O

Power Management

Item	Specification
Controller	ITE ITE8512F
Interface	LPC
AC adapter (AVAP)	30W
1st Battery (AVAP)	3-cell 2.2Ah 6-cell 4.4Ah 6-cell 5.6Ah

LED Status Indicator

Item	Specification
Power Status	1 (Blue / Orange)
1st Battery Status	1 (Blue / Orange)
HDD	1 (Blue)
Caps Lock	1 (Blue)
Num Lock	1 (Blue)
Wireless LAN	1 (Blue / Orange)
Bluetooth	1 (Blue)

Security Features

Item	Specification
Kensington Lock Hole(7.5 mm diameter)	1
Fingerprint	Optional
TPM	None

FAN

Item	Specification
Not Noise	as low as possible
Number	1

Physical Characteristics

Item	Specification
Dimensions	285mm x 206.3mm
Thickness (maximum)	20.2 ~ 29.1mm
Weight (incl 1st Battery & super multi ODD)	Target < 1.35kg

System Utilities

BIOS Setup Utility

The BIOS Setup Utility is a hardware configuration program built into your computer's BIOS (Basic Input / Output System).

Your computer is already properly configured and optimized, and you do not need to run this utility. However, if you encounter configuration problems, you may need to run Setup. Please also refer to Chapter 4 Troubleshooting when problem arises.

To activate the BIOS Utility, press **m** during POST (when "Press <F2> to enter Setup" message is prompted on the bottom of screen).

Press **m** to enter setup. The default parameter of **F12** Boot Menu is set to "**disabled**". If you want to change boot device without entering BIOS Setup Utility, please set the parameter to "**enabled**".

Press <F12> during POST to enter multi-boot menu. In this menu, user can change boot device without entering BIOS SETUP Utility.

InsydeH2O Setup Utility		Rev. 3.0
Information	Main	Advanced
	Security	Boot
		Exit
CPU Type:	Genuine Intel(R) CPU	
CPU Speed:	T2300 @ 1.66GHz	
IDE 0 Model Name:	ST960821A-(PM)	
IDE0 Serial Number:	3LF005DB	
ATAPI Model Name:	MATSHITADVD	
System BIOS Version:	V1.00	
VGA BIOS Version:	ATI V008.0501.0-26.00	
Serial Number:	xxxxxxxxxxxxxxxxxxxx (Max: 22 Byte)	
Asset Tag Number:	xxxxxxxxxxxxxxxxxxxx (Max: 32 Byte)	
Product Name:	xxxxxxxxxxxxxxxxxxxx (Max: 16 Byte)	
UUID:	xxxxxxxxxxxxxxxxxxxx (Max: 16 Byte)	
F1 Help	↑↓ Select Item	F5/F6 Change Values
		F9 Setup defaults
Esc Exit	←→ Select Menu	Enter Select ▸ Sub-Menu
		F10 Save and Exit

Invoking BIOS Setup

The setup function can only be invoked by pressing **F2** when Press <F2> to enter Setup message is prompted on the bottom of screen during POST.

The setup uses a menu driven interface to allow the user to configure their system. The features are divided into 5 parts as follows:

- Information** Display the system informations.
- Main** allows the user to specify standard IBM PC AT system parameters.
- Security** Provides security settings of the system.
- Boot** Allows the user to specify the boot options.
- Exit** Allows the user to save CMOS setting and exit Setup.

NOTE: You can change the value of a parameter if it is enclosed in square brackets. Navigation keys for a particular menu are shown on the bottom of the screen. Help for parameters are found in the Item Specific Help part of the screen. Read this carefully when making changes to parameter values.
Please note that system information is subject to different models.

Information

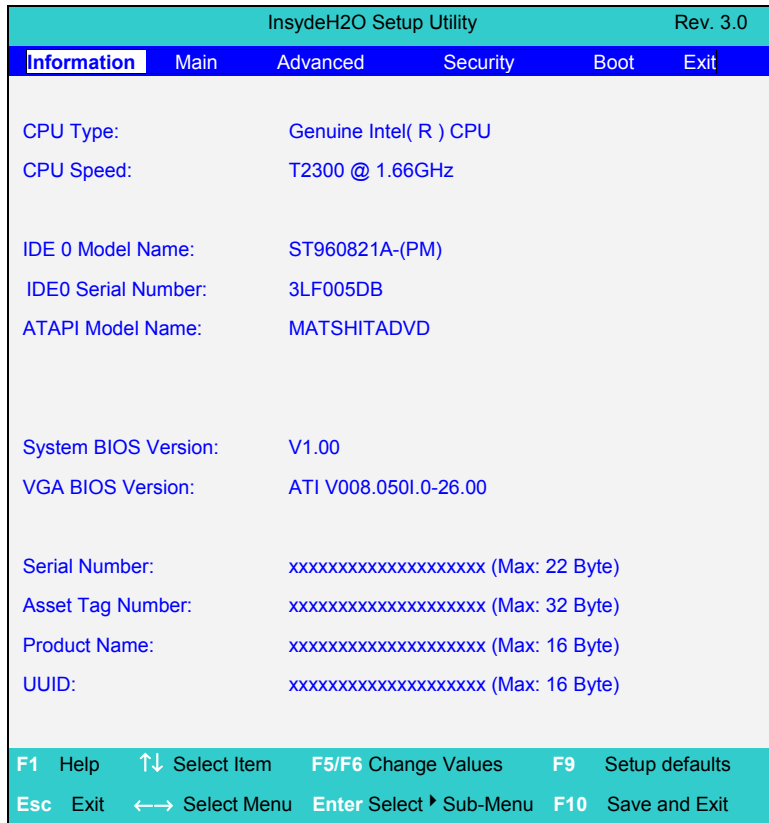

NOTE: Other fields are informational items and are unit dependent.

Parameter	Description
CPU Type	This field shows the CPU type of the system.
CPU Speed	This field shows the CPU speed of the system.
IDE0 Model Name	The field shows the Model name of HDD installed on Primary IDE master.

Parameter	Description
IDE0 Serial Number	The field shows the Serial number of HDD installed on Primary IDE master.
ATAPI Model Name	The field shows the Model name of ATAPI.
System BIOS version	Displays system BIOS version.
VGA BIOS Version	This field displays the VGA firmware version of the system.
Serial Number	This field displays the serial number of this unit.
Asset Tag Number	This field displays the asset tag number of the system.
Product Name	This field shows product name of the system.
UUID Number	This will be visible only when an internal LAN device is presenting. UUID=32bytes

Main

The Main screen displays a summary of your computer hardware information, and also includes basic setup parameters. It allows the user to specify standard IBM PC AT system parameters.

InsydeH2O Setup Utility		Rev. 3.0
Information	Main	Advanced Security Boot Exit
		Item specific Help
System Time:	[09:00:00]	<Tab>, <Shift-Tab>, or
System Date:	[01/01/2003]	<Enter> selects field
Total Memory	[xxxxMB]	
Video Memory:	[XMB]	
Graphic mode	[Switchable]	
Quiet Boot:	[Enabled]	
Network boot:	[Enabled]	
F12 Boot Menu:	[Disabled]	
D2D Recovery:	[Enabled]	
F1 Help	↑↓ Select Item	F5/F6 Change Values F9 Setup defaults
Esc Exit	←→ Select Menu	Enter Select ▸ Sub-Menu F10 Save and Exit

NOTE: The screen above is for your reference only. Actual values may differ.

The table below describes the parameters in this screen. Settings in **boldface** are the default and suggested parameter settings.

Parameter	Description	Format/Option
System Time	Sets the system time. The hours are displayed with 24-hour format.	Format: HH:MM:SS (hour:minute:second) System Time
System Date	Sets the system date.	Format: MM/DD/YYYY (month/day/year) System Date
Total Memory	This field reports the memory size of total memory in the system.	
Video Memor	Shows the Video memory size.	
Graphic mode	The following define the options of graphic mode for different skus: For Mux_less projects: Switchable/ Integrated Others: Switchable/Discrete	
Quiet Boot	Determines if Customer Logo will be displayed or not; shows Summary Screen is disabled or enabled. Enabled: Customer Logo is displayed, and Summary Screen is disabled. Disabled: Customer Logo is not displayed, and Summary Screen is enabled.	Option: Enabled or Disabled
Network Boot	Enables, disables the system boot from LAN (remote server).	Option: Enabled or Disabled
F12 Boot Menu	Enables, disables Boot Menu during POST.	Option: Disabled or Enabled
D2D Recovery	Enables, disables D2D Recovery function. The function allows the user to create a hidden partition on hard disc drive to store operation system and restore the system to factory defaults.	Option: Enabled or Disabled

NOTE: The sub-items under each device will not be shown if the device control is set to disable or auto. This is because the user is not allowed to control the settings in these cases.

NOTE: Please refer to Acer's VGA TAG table. For Intel switchable graphic platforms, Video memory refers to the dedicated VRAM size of discrete graphics.

AMD or NV UMA:

System memory >=512M, VRAM set to 256M

System memory < 512M, VRAM set to 64M

Others: (please refer to Acer VGA tAG table)

Security

The Security screen contains parameters that help safeguard and protect your computer from unauthorized use.

InsydeH2O Setup Utility		Rev. 3.0			
Information.	Main	Advanced	Security	Boot	Exit
			Item specific Help		
Supervisor Password Is	Clear				
User Password Is	Clear	Supervisor Password controls			
HDD Password	Clear	access to the whole setup			
Set Supervisor Password	[Enter]	utility. It can be used to boot			
Set User Password	[Enter]	up when Password on boot is			
Set HDD Password	[Enter]	enabled.			
Password on Boot:	[Disabled]				
F1 Help	↑↓ Select Item	F5/F6 Change Values	F9 Setup defaults		
Esc Exit	←→ Select Menu	Enter Select ▸ Sub-Menu	F10 Save and Exit		

The table below describes the parameters in this screen. Settings in **boldface** are the default and suggested parameter settings.

Parameter	Description	Option
Supervisor Password is	Shows the setting of the Supervisor password.	Clear or Set
User Password is	Shows the setting of the user password.	Clear or Set
HDD Password is	Shows the setting of HDD password.	Clear or Set
Set Supervisor Password	Press Enter to set the supervisor password. When set, this password protects the BIOS Setup Utility from unauthorized access. The user can not enter the Setup menu and change the value of parameters.	
Set User Password	Press Enter to set the user password. When user password is set, this password protects the BIOS Setup Utility from unauthorized access. The user can enter Setup menu only and does not have right to change the value of parameters.	
Set Hdd Passwor	Press Enter to set the Hdd password. When Hdd password is set, this password protects the Hdd . Other user can't steal information.	
Password on Boot	Defines whether a password is required or not while the events defined in this group happened. The following sub-options are all requires the Supervisor password for changes and should be grayed out if the user password was used to enter setup.	Disabled or Enabled

NOTE: When you are prompted to enter a password, you have three tries before the system halts. Don't forget your password. If you forget your password, you may have to return your notebook computer to your dealer to reset it.

Set Supervisor Password

While these fields are highlighted and press "Enter" , a window similar to the following is shown:

Set Supervisor Password

Enter New Password []

Confirm New Password []

If there is an old password then setup will prompt with the following window instead and a current password will be required to be entered at first:

Set Supervisor Password

Enter current password []

Enter New Password []

Confirm New Password []

User can now type password in field “ Enter New Password“, and re-enter password in field “Confirm New Password“ for verification.

Set Supervisor Password	
Enter current password	[]
Enter New Password	[]
Confirm New Password	[]

If the verification is OK:

Setup Notice
Changes have been saved.
[continue]

The password setting is complete after user presses enter.

Setup Warning
Invalid password
Re-enter Password
[continue]

If the new password and confirm new password strings do not match:

Setup Warning
Password do not match
Re-enter Password

The format of the password is as follows:

Password Max Length : 8 characters.

Characters List Table:

A-Z	Alphabets A through Z (Not Case Sensitive)
0-9	Numerical Characters.
-	Dash
=	Equal Sign
[Left Bracket
]	Right Bracket
.	Period
,	Comma
;	Semi-colon
/	Slash
\	Back-slash

Boot

This menu allows the user to decide the order of boot devices to load the operating system. Bootable devices includes the distette drive in module bay, the onboard hard disk drive and the CD-ROM in module bay.



Exit

The Exit screen contains parameters that help safeguard and protect your computer from unauthorized use.

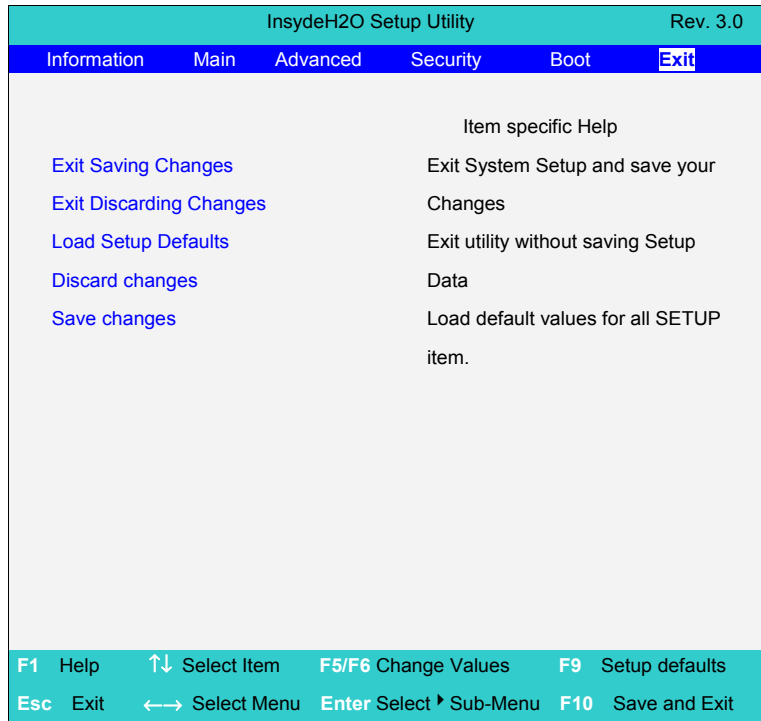

The table below describes the parameters in this screen.

Parameter	Description
Exit Saving Changes	Exit System Setup and save your changes to CMOS.
Exit Discarding Changes	Exit utility without saving setup data to CMOS.
Load Setup Default	Load default values for all SETUP item.
Discard Changes	Load previous values from CMOS for all SETUP items.
Save Changes	Save Setup Data to CMOS.

Exit Saving Changes

Allows the user to save changes and reboot the system.

The following message is shown when user presses “Enter” on the item

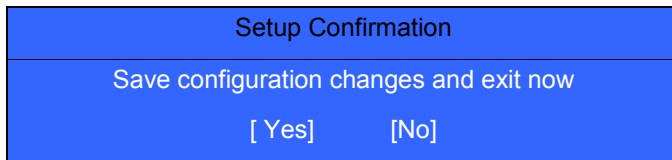

System will reboot if Yes is selected and will stay in Setup if No is selected..

Exit Discarding Changes

Allows the user to not save changes before exiting Setup.

The following message is shown when user presses “Enter” on this item.

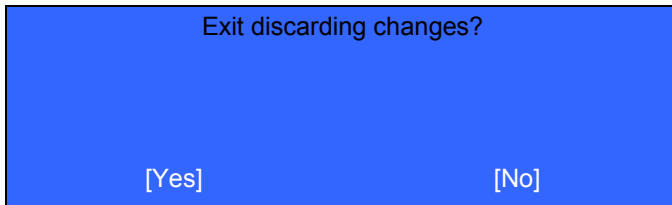

System will reboot after either selection.

Load Setup Default

Allows the user to load default values in Setup. The following message is shown when user presses “Enter” on this item..

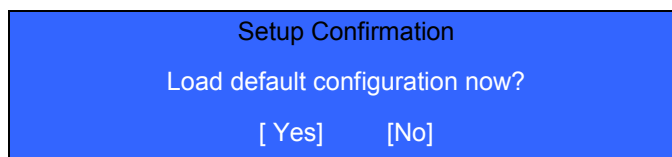

It still stay in Setup after either selection.

Discard Changes

Allows the user to discard previous changes in Setup.

The following message is shown when user presses “Enter” on this item:

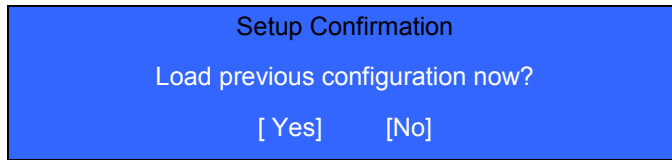

Save Changes

Allows the user to save current changes in Setup.

The following message is shown when user presses “Enter” on this item:

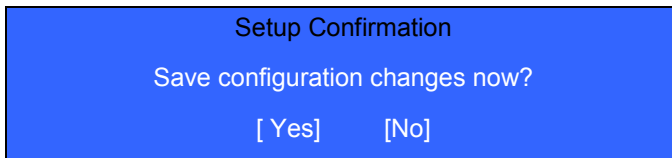

BIOS Flash Utility

The BIOS flash memory update is required for the following conditions:

- New versions of system programs
- New features or options
- Restore a BIOS when it becomes corrupted.

Use the Phlash utility to update the system BIOS flash ROM.

NOTE: If you do not have a crisis recovery diskette at hand, then you should create a **Crisis Recovery Diskette** before you use the Phlash utility.

NOTE: Do not install memory-related drivers (XMS, EMS, DPMS) when you use the Phlash.

NOTE: Please use the AC adaptor power supply when you run the Phlash utility. If the battery pack does not contain enough power to finish BIOS flash, you may not boot the system because the BIOS is not completely loaded.

Follow the steps below to run the Phlash.

1. Prepare a bootable diskette.
2. Copy the flash utilities to the bootable diskette.
3. Then boot the system from the bootable diskette. The flash utility has auto-execution function.

DOS flash BIOS SOP

1. Please prepare a bootable flash disk.



2. Unzip the “BIOS” and leave the DOS file in the bootable flash disk.

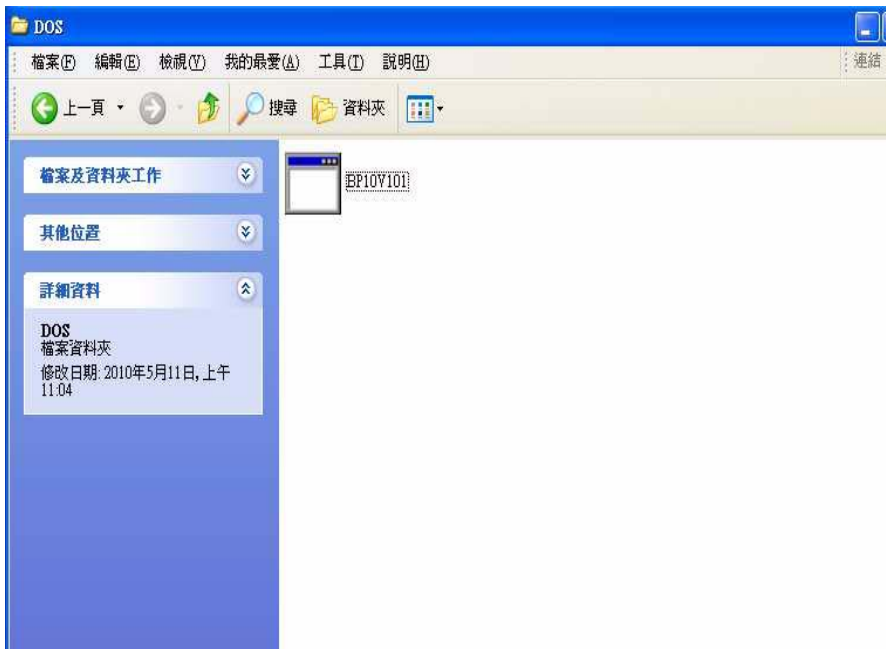

-
3. Insert the flash disk with the unzip file.



4. Connect the adapter.



-
5. Log in the DOS by bootable flash disk and type the name of “exe file” and press Enter. The system will flash BIOS automatically.

NOTE: The version of BIOS must be newer than original version.

NOTE: Adapter have to be connected.

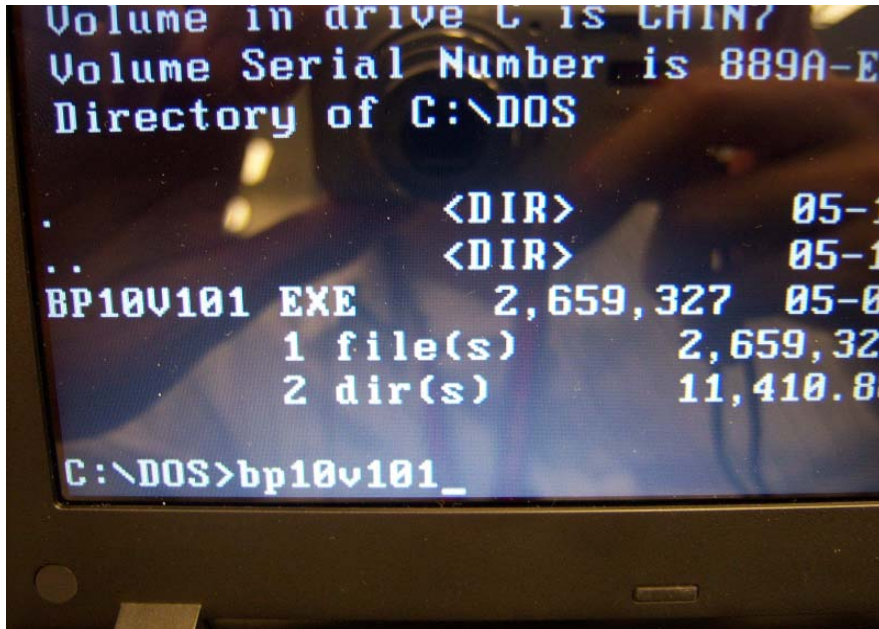

Clean BIOS Password SOP

1. Please prepare a bootable flash disk.



2. Unzip the “CleanBIOSPassword” and leave it in the bootable flash disk.

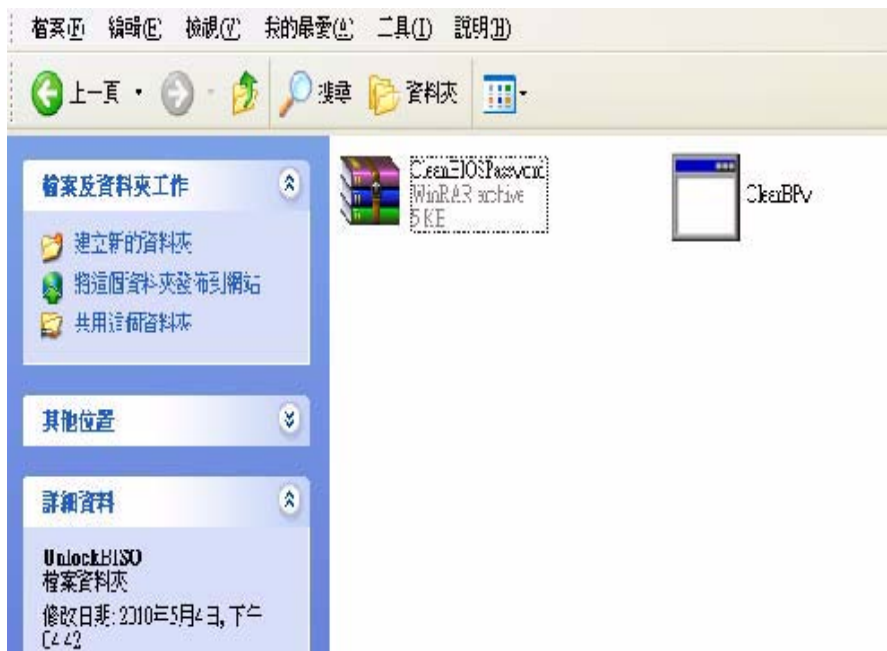

-
3. Insert the flash disk with the unzip file.



4. Connect the adapter.



5. Set the supervisor BIOS and enable Power on Password.

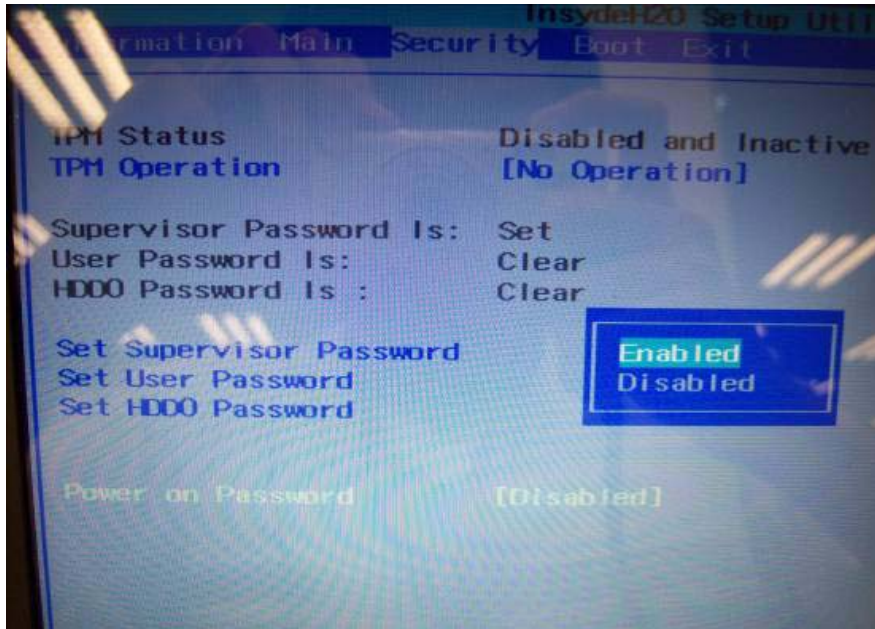

6. Please insert bootable USB device, and press “alt gr+backspace+Esc” and press power button.



- The system will automatically ignore the power on password and log in the bootable flash disk.



- Insert "clearbpw" .

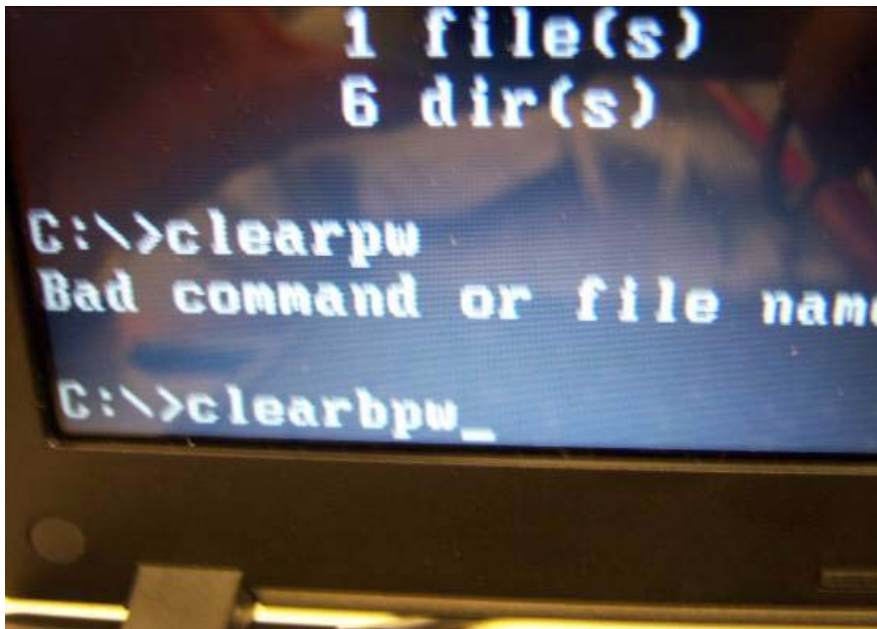

-
9. When the screen show “Clear the SU PWs completely” means the BIOS password removed completely.

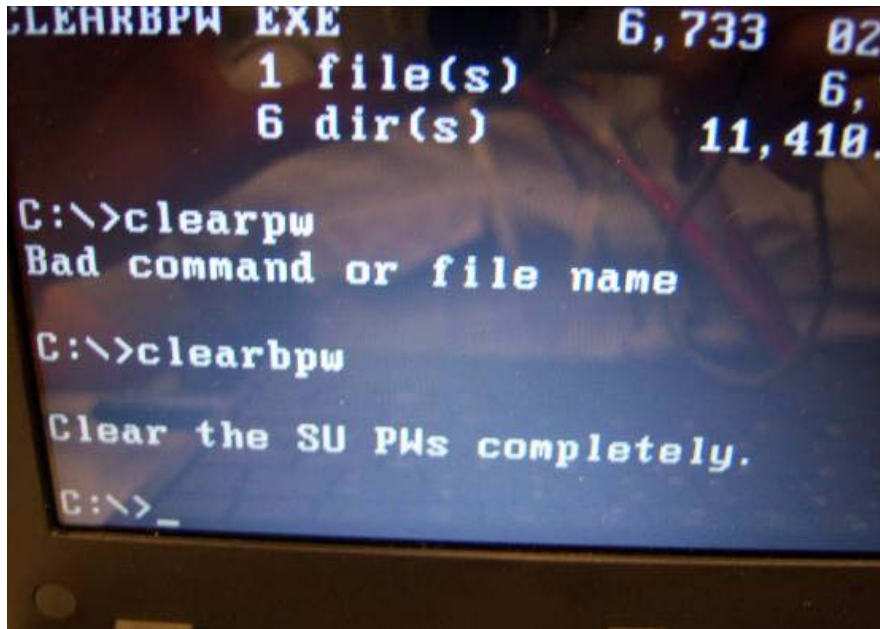

Clean HDD Password SOP

1. Please prepare a bootable flash disk.



2. Unzip the “CleanHDDPassword” and leave it in the bootable flash disk.

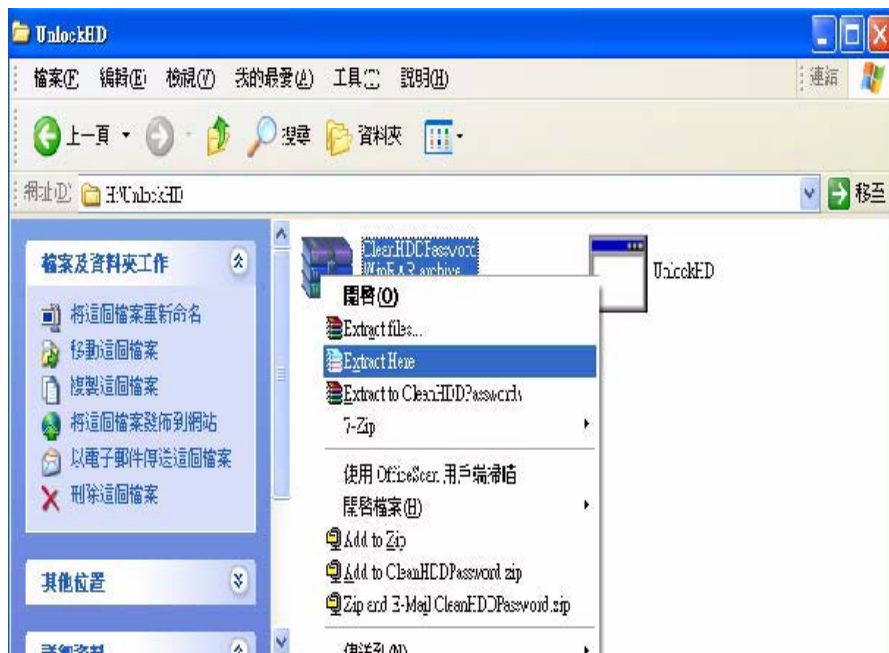

-
3. Insert the flash disk with the unzip file.



4. Connect the adapter.



-
5. After inserting the wrong HDD password three times. The system will show select item screen.



6. Memorize the error code behind the “Enter Unlock Password” .

NOTE: the number will be created by system in disorder.



-
7. Remove the disk and insert it in other system.



8. Log in DOS mode in other system. Execute the "Unlockhd" in the bootable flash disk by insert the keyword: "unlockhd+ space + error code" .

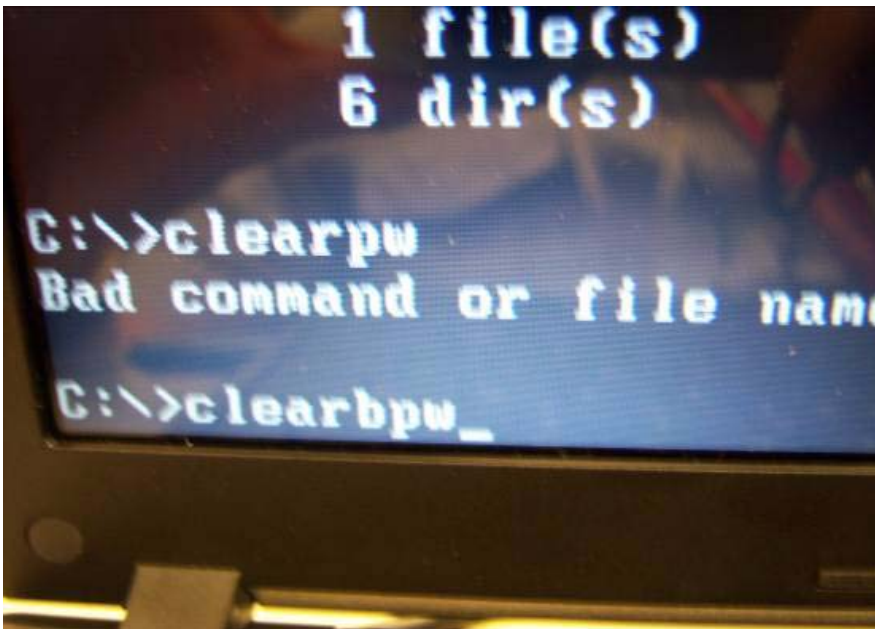

9. The program will create a password. Please memorize it.



10. Remove the bootable flash disk and re-install in the original system.



11. Enter the password and the HDD lock will be released.



Crisis Disk SOP

1. Please prepare a bootable flash disk.



2. Unzip the “Crisis disk” and leave it in the bootable flash disk.

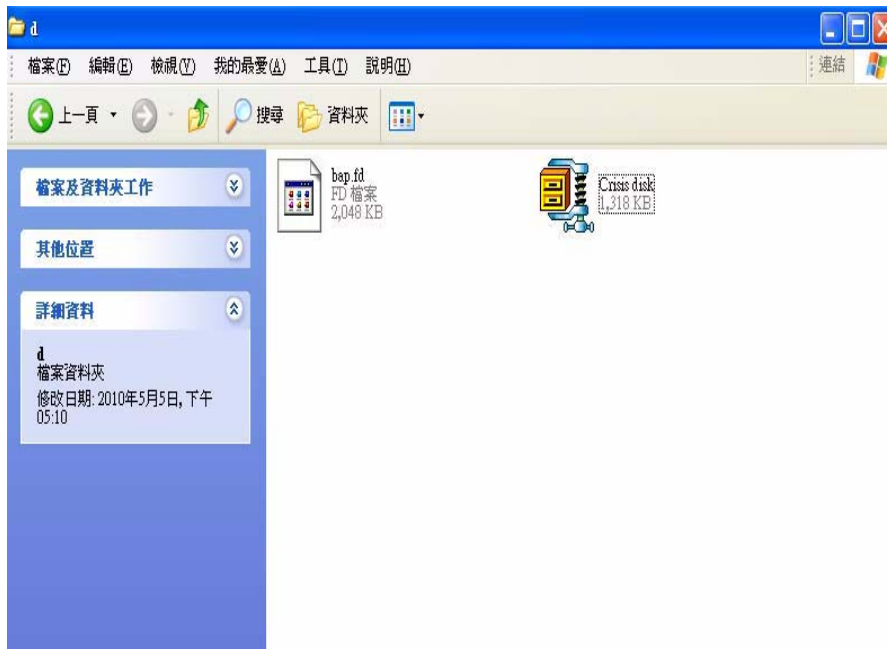

-
3. Insert the flash disk with the unzip file.



4. Connect the adapter.



5. Press “Fn+ESC+Power” to power on the system.



6. The system will automatically power on after several minutes.
7. Please use normal BIOS flash procedure to flash BIOS again when the machine be rescued.

DMI Utility SOP

1. Please prepare a bootable flash disk.



2. Unzip the “dmi174” and leave it in the bootable flash disk.

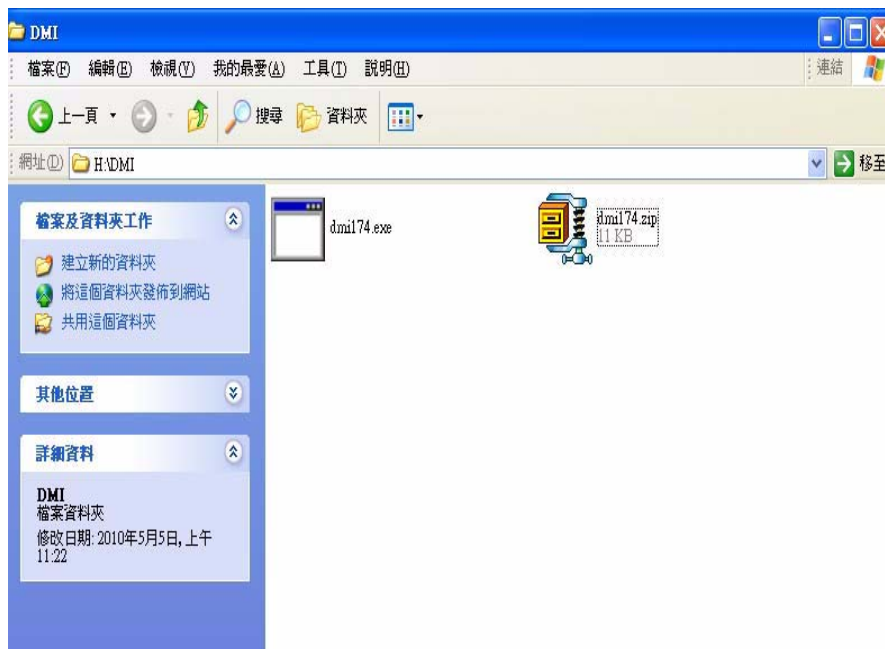

3. Insert the flash disk with the unzip file.



4. Connect the adapter.



5. Log in dos mode and type "dmi174r" to execute the program.

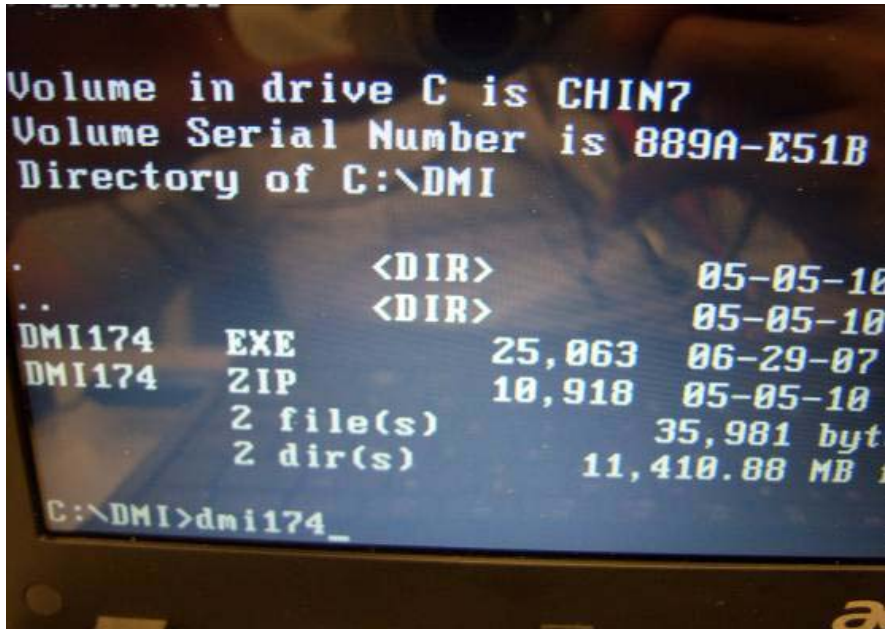

6. Activate the program.

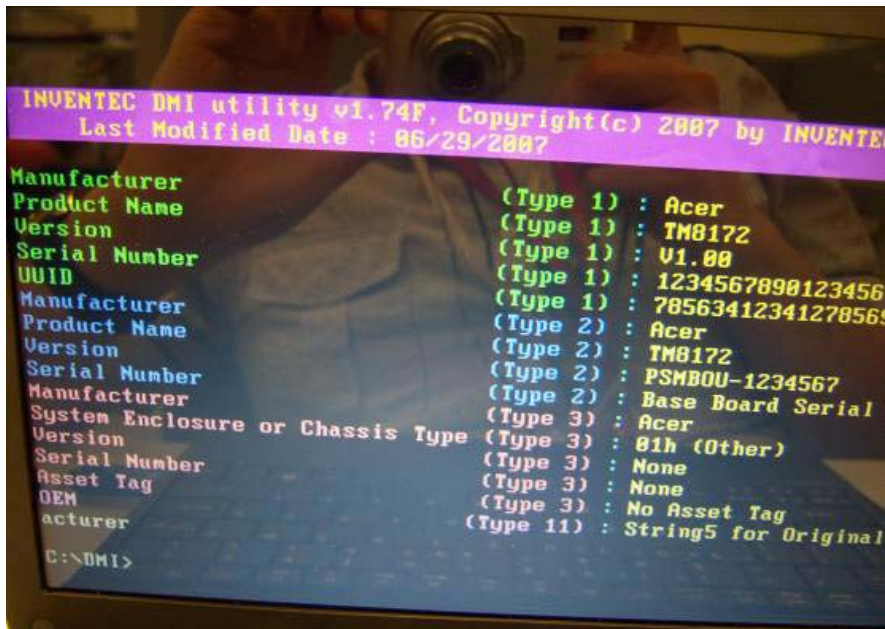

7. Type "DMI174 /?" can check all of the function of DMI.



LAN EEPROM Utility SOP

1. Please prepare a bootable flash disk.



2. Unzip the MAC.zip and leave it in the bootable flash disk.

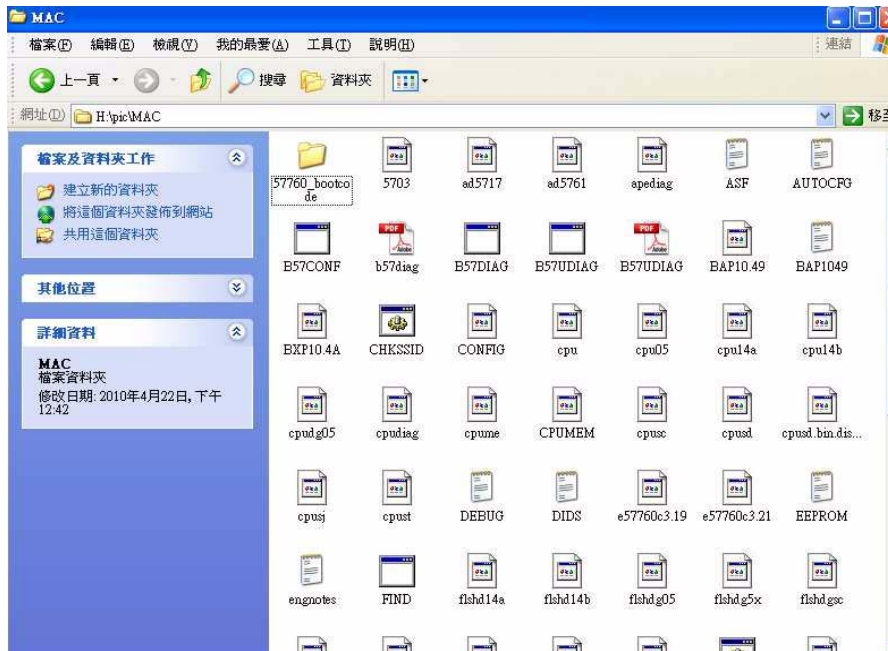

3. Insert the flash disk with the unzip file.



4. Connect the adapter.



5. Power on the system and press F2 to log in the BIOS. Select the USB HDD to the first priority.



6. Save the BIOS setting, the system will reboot automatically and log in DOS.



7. Go in to the file of MAC. Insert the "βmacin.bat" .



8. Input the MAC address.



Winflash SOP

1. Please prepare a bootable flash disk.



2. Unzip the file and leave it in the flash disk.

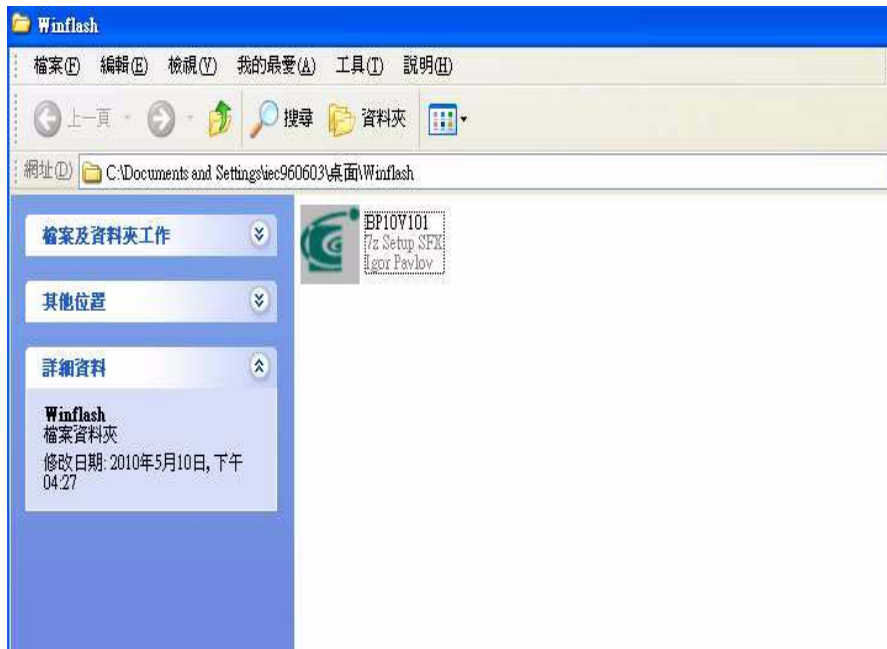

3. Insert the flash disk with the unzip file.



4. Connect the adapter.



5. Double click the Winflash tool and begin to flash BIOS.

NOTE: The version of BIOS must be newer than original version.

NOTE: Adapter have to be connected.

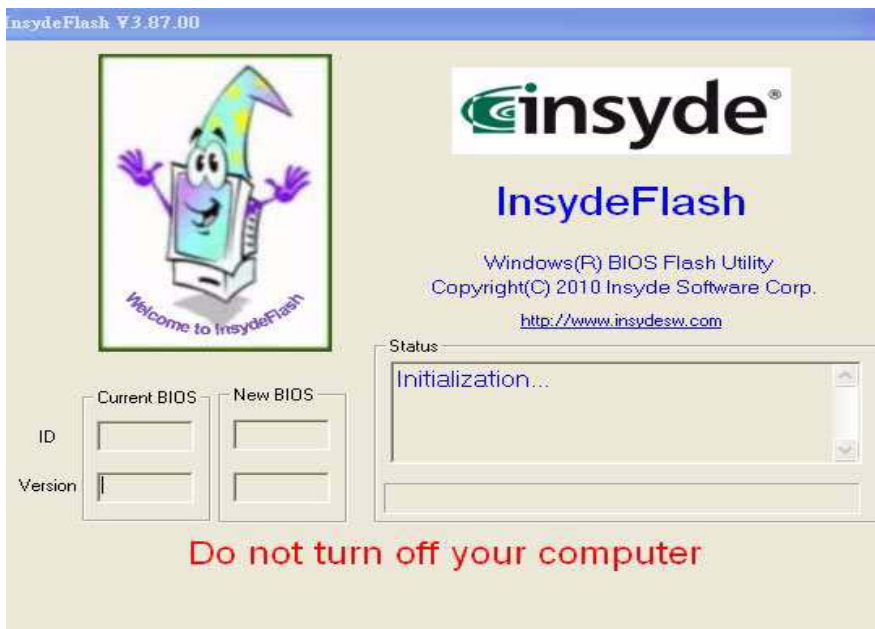

Machine Disassembly and Replacement

Disassembly Requirements

To disassemble the computer, you need the following tools:

Wrist grounding strap and conductive mat for preventing electrostatic discharge

- Flat screwdriver
- Philips screwdriver
- Plastic flat screwdriver
- Plastic tweezers

NOTE: The screws for the different components vary in size. During the disassembly process, group the screws with the corresponding components to avoid mismatch when putting back the components

Related Information

The product previews seen in the disassembly procedures may not represent the final product color or configuration.

IMPORTANT: Cable paths and positioning may not represent the actual model. During the removal and replacement of components, ensure all available cable channels and clips are used and that the cables are replaced in the same position.

Replacement Requirements

NOTE: Cabling and components require adhesive to be applied during the replacement and reassembly process.

NOTE: During manufacture a cyanoacrylate glue is used provided by Holdtite Adhesives LTD. This is not a specified requirement. The reassembler is free to select an alternative appropriate adhesive.

Pre-disassembly Instructions

Before proceeding with the disassembly procedure, make sure that you do the following:

1. Turn off the power to the system and all peripherals.
2. Unplug the AC adapter and all power and signal cables from the system.



3. Place the system on a flat, stable surface.

Disassemble Process

The disassembly process is divided into the following sections:

- ❑ External components disassembly
- ❑ Main unit disassembly
- ❑ LCD module disassembly

The flowcharts provided in the succeeding disassembly sections illustrate the entire disassembly sequence.

Observe the order of the sequence to avoid damage to any of the hardware components. For example, if you want to remove the Mainboard, you must first remove the Keyboard, and LCD Module then disassemble the inside assembly frame in that order.

Main Screw List

Screw	Quantity	Acer part no
M2.5*4L	12	
M2*6L	11	
M2*3	7	
M2*2.5	4	

External Module Disassembly Process

NOTE: The product previews seen in the disassembly procedures may not represent the final product color or configuration.

Screw List

Step	Screw	Quantity	part no
Wireless Module Disassembly	M2.5*4L	2	

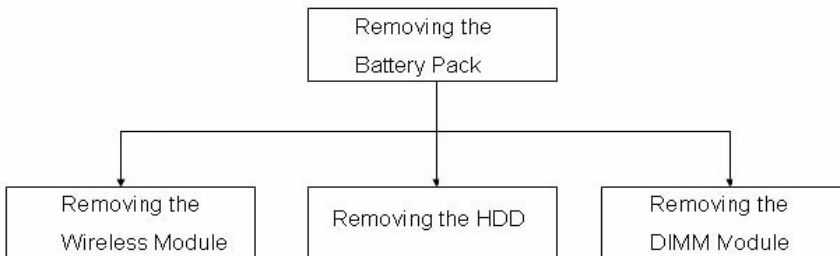

Removing the Battery Pack

1. Turn the computer over.

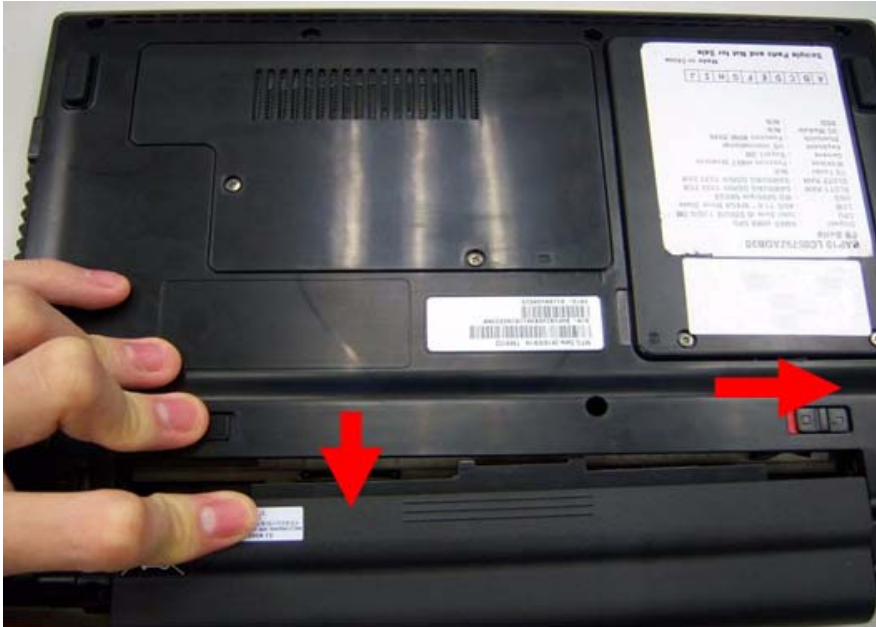

2. Slide the battery lock/unlock latch to the unlock position.



3. Slide and hold the battery to the release position (1) and remove the battery from the main unit (2).



NOTE: Battery has been highlighted with the yellow circle as above image shows. Please detach the battery and follow local regulations for disposal.

Removing the HDD



1. Remove two (2) screws on the HDD cover.



2. Remove the HDD cover.



3. Grasp the pull tab on the top of HDD.



-
4. Lift the HDD out of lower case.

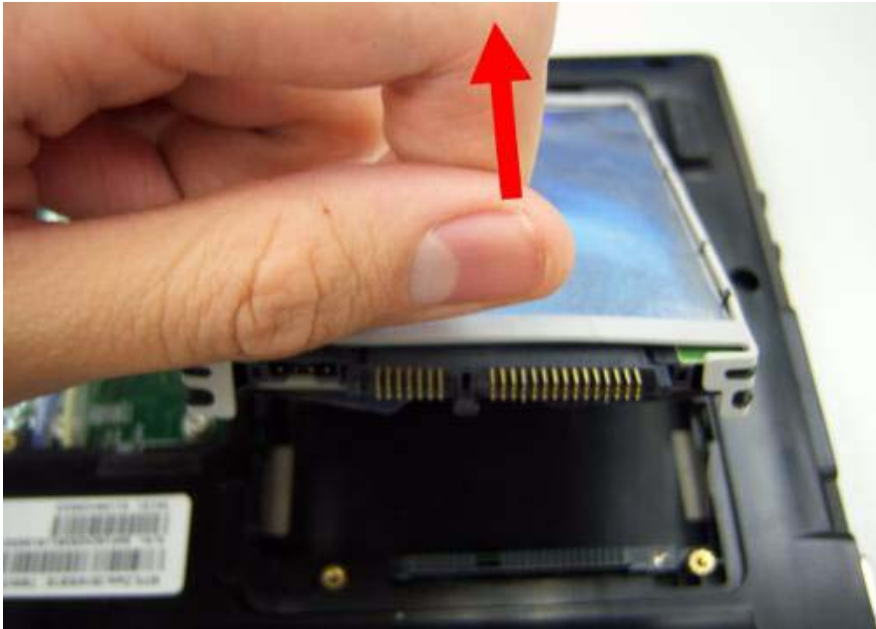

5. Remove the HDD connector.



6. Remove the HDD bracket.

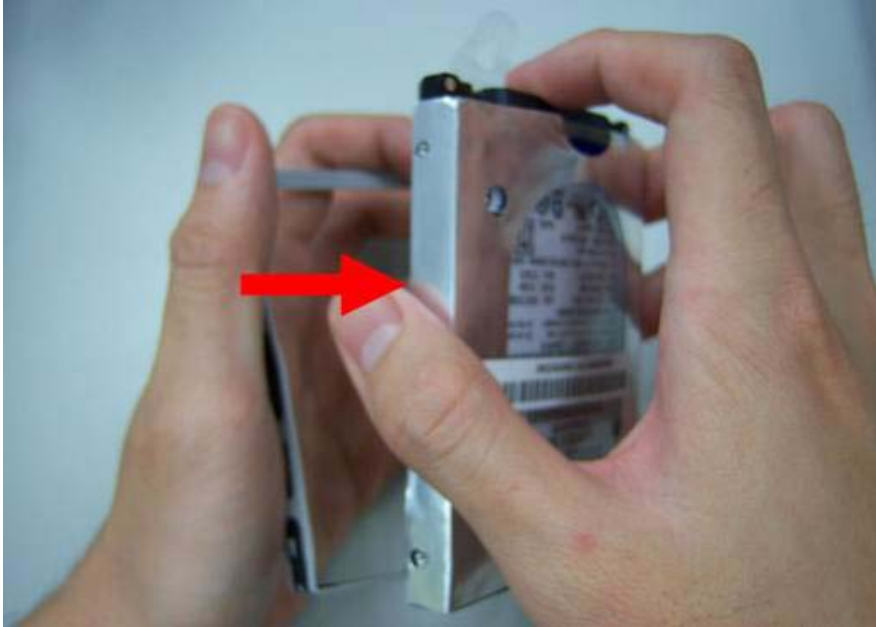

7. Remove the HDD pocket.



Removing the DIMM module

- 1. Remove two screws on the RAM cover.

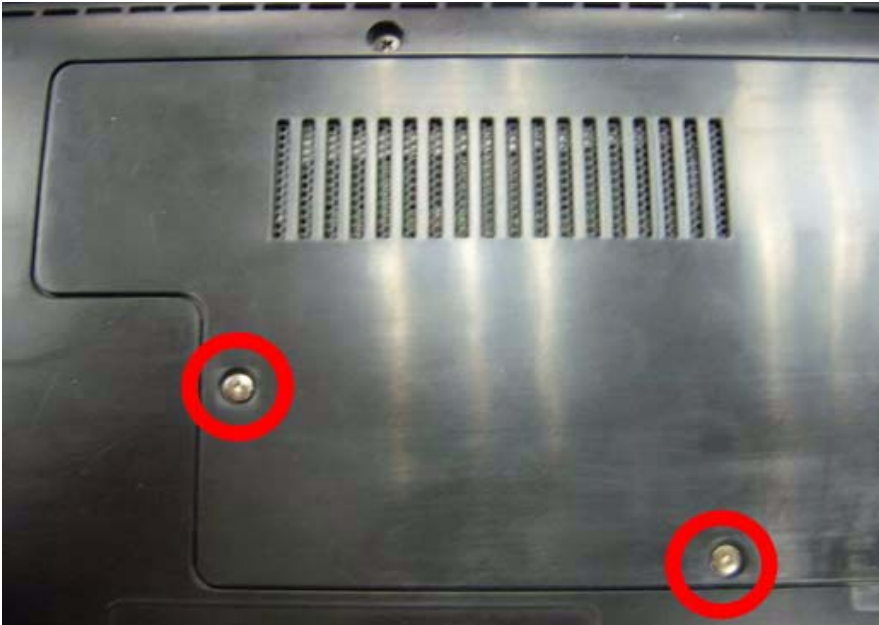

2. Remove the RAM cover. Remove the RAM cover.



3. Remove the first RAM from RAM slot.

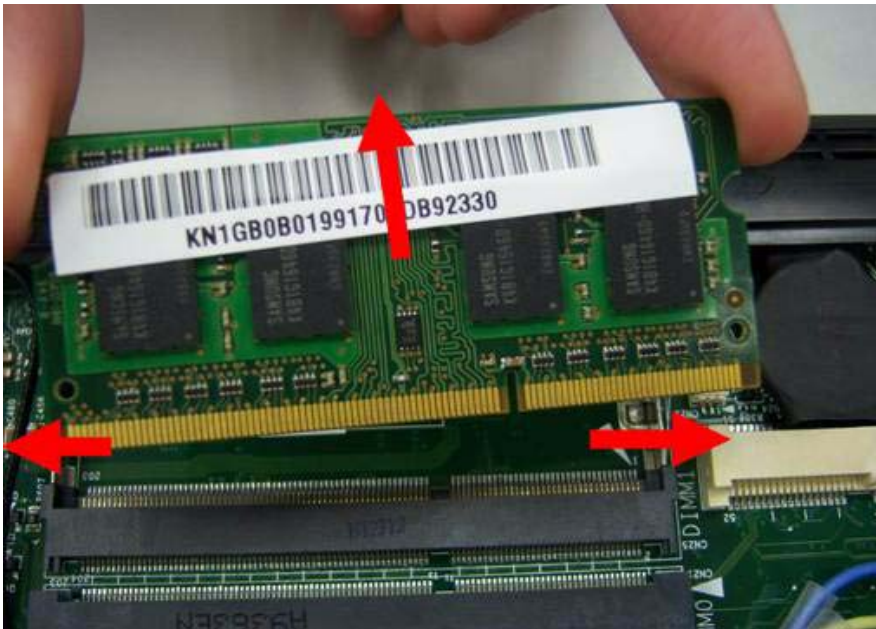

4. Remove the second RAM from RAM slot.

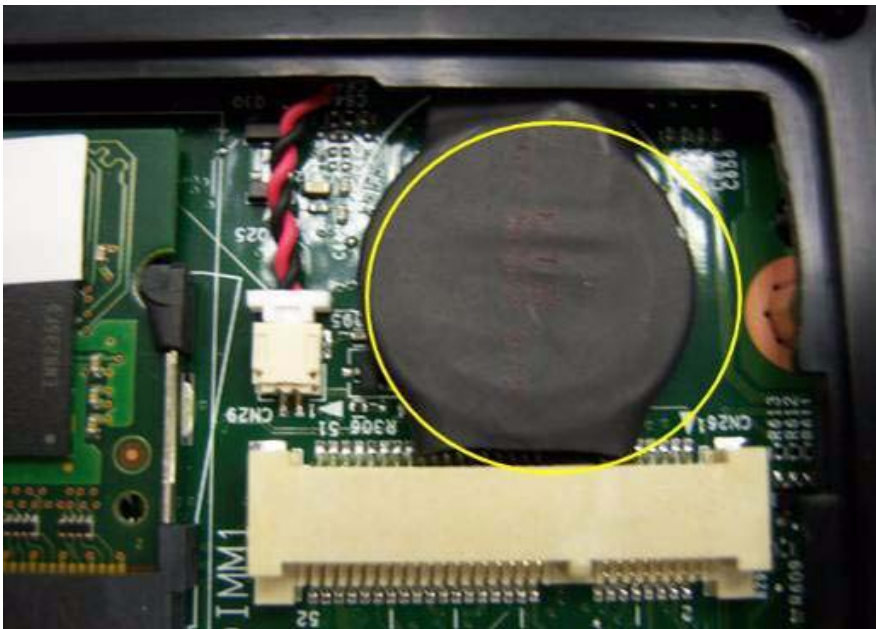
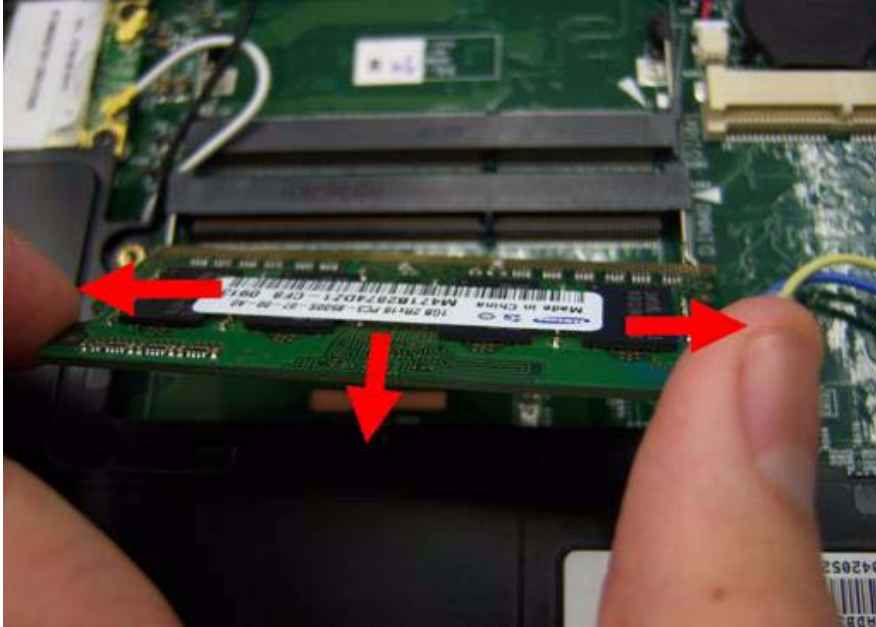

NOTE: RTC battery has been highlighted with the yellow circle as above image shows. Please detach the RTC battery and follow local regulations for disposal.

Remove the Wireless module

1. Notice the antenna color on the wireless card.

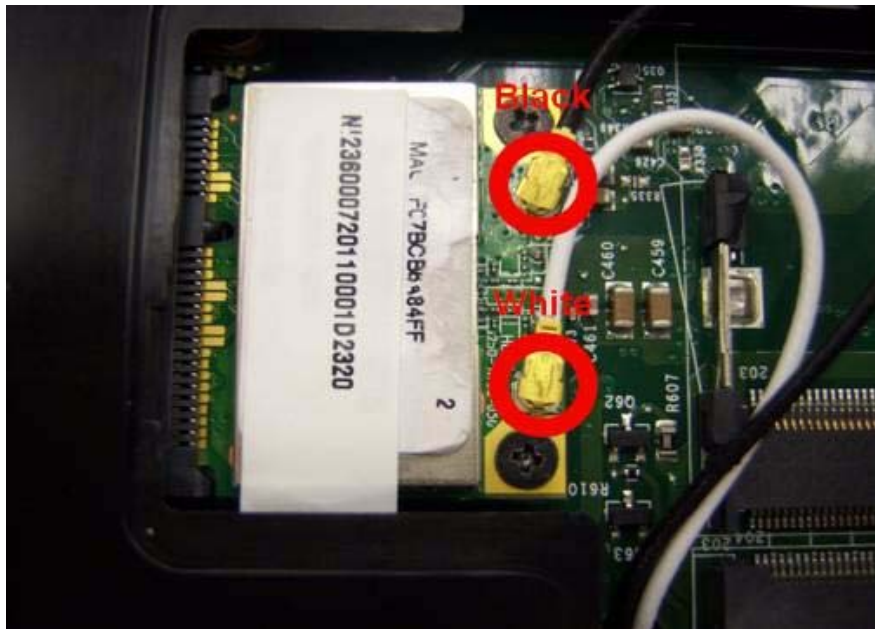

2. Release the cable of the wireless module.



- Release two screws on the wireless module.



	Type	Number
	M2.5*4	2

- Remove wireless module.



LCD Module Disassembly Process

IMPORTANT: Cable paths and positioning may not represent the actual model. During the removal and replacement of components, ensure all available cable channels and clips are used and that the cables are replaced in the same position.

NOTE: The product previews seen in the disassembly procedures may not represent the final product color or configuration.

1. Main Unit Disassembly Flowchar.

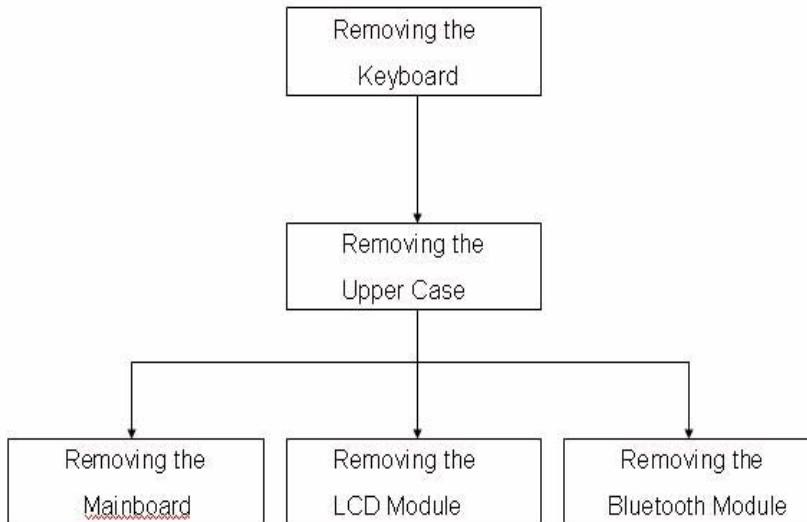

Screw List

Step	Screw	Quantity	part no
Upper Cover Disassembly	M2.5*6L	2	
Lower Cover Disassembly	M2*6L	9	
LCD Module Disassembly	M2.5*4L	2	
Power bracket Disassembly	M2*3L	1	
Mainboard Disassembly	M2*3L	4	
Mainboard Disassembly	M2.5*4L	4	

Removing the keyboard

1. Use tool to disconnect four latches which hold the keyboard.



2. Gently pry up the keyboard.



3. Carefully flip the keyboard over.

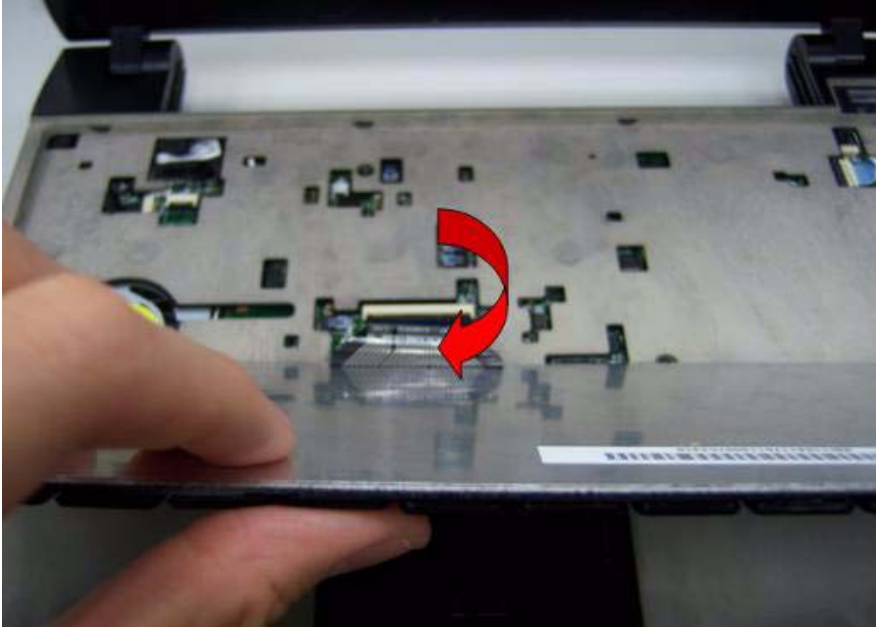

4. Unlock the keyboard FFC.

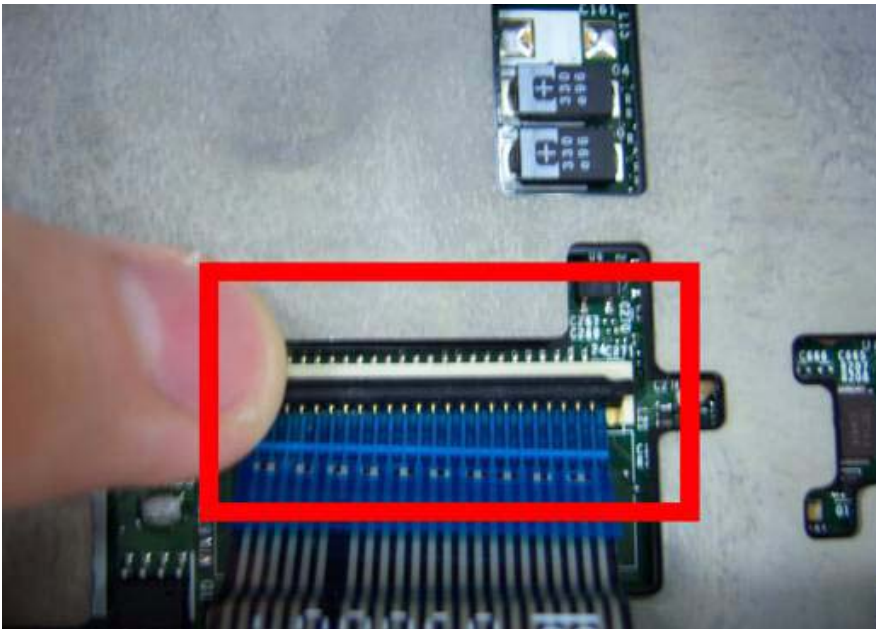

-
5. Disconnect the keyboard FFC.

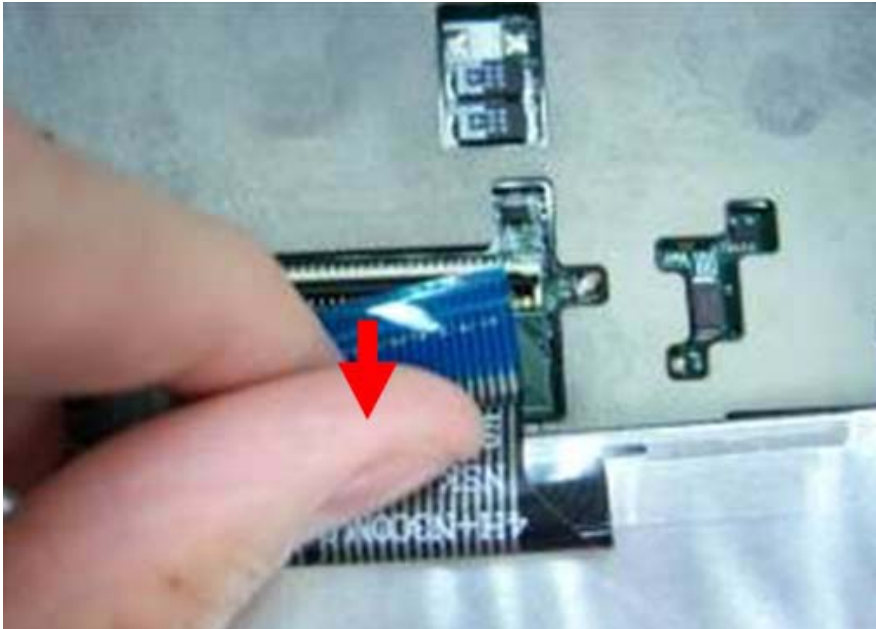

Removing the Upper Case

1. Unlock the touch pad FFC.

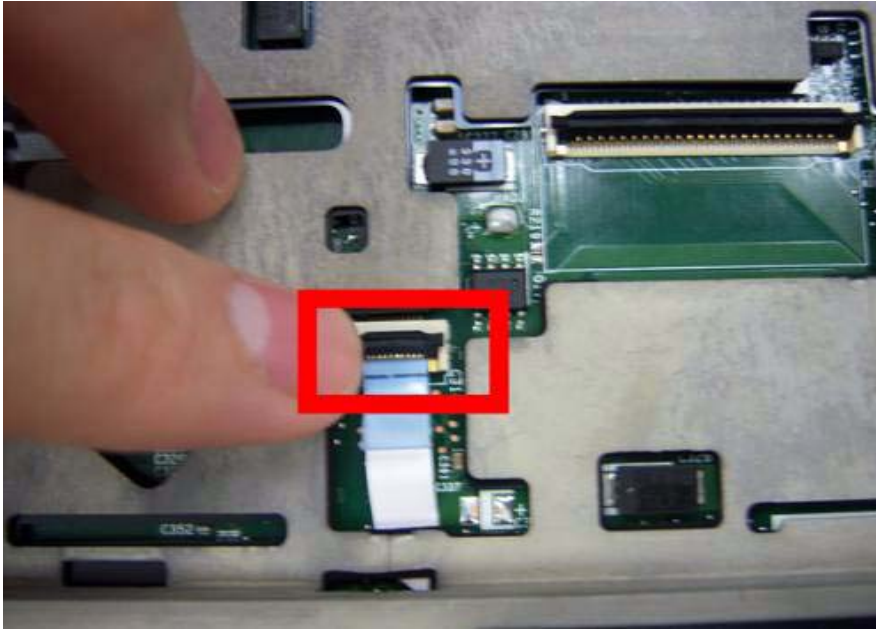

2. Disconnect the Touch Pad FFC.

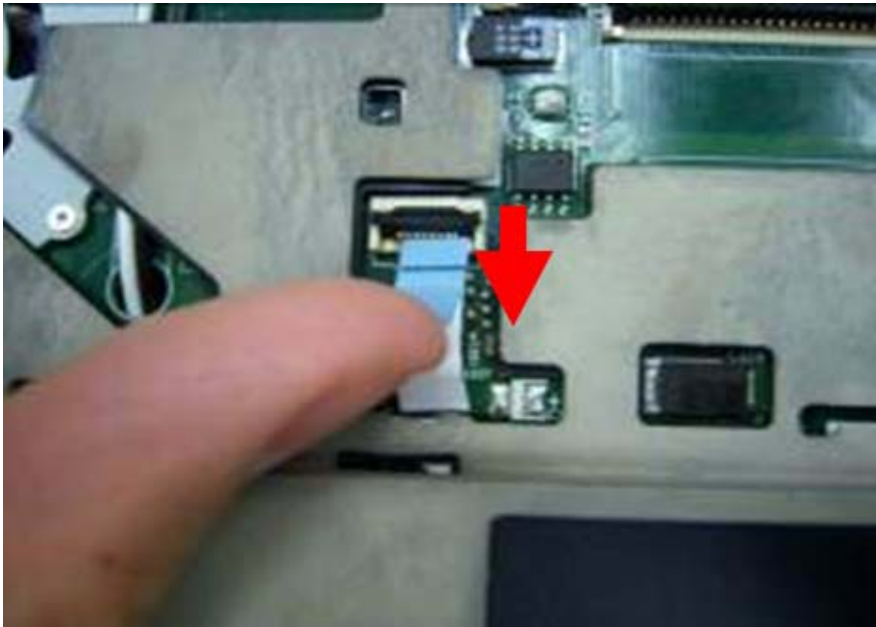

3. Unlock the power board FFC.



4. Disconnect the power board FFC.

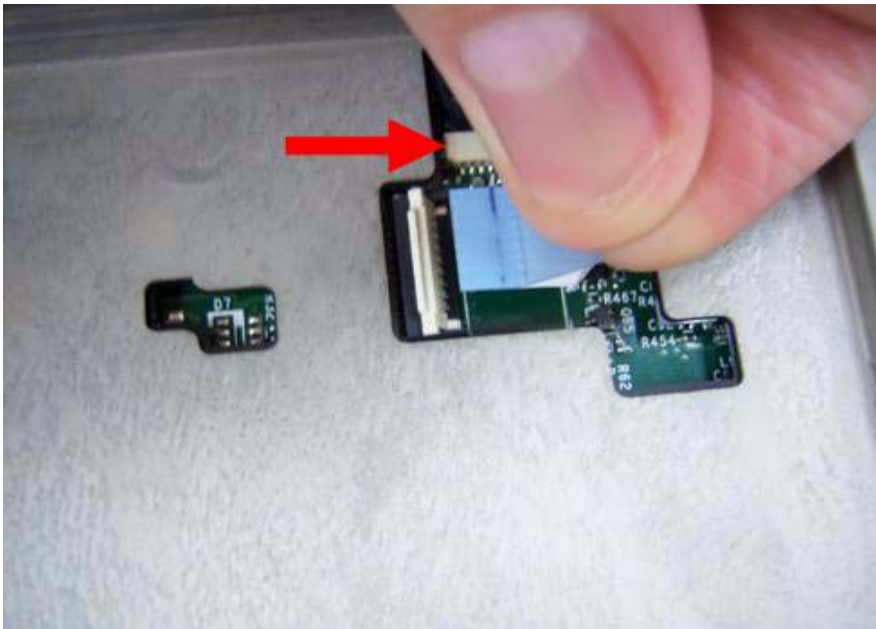

5. Remove two screws on the topper case.

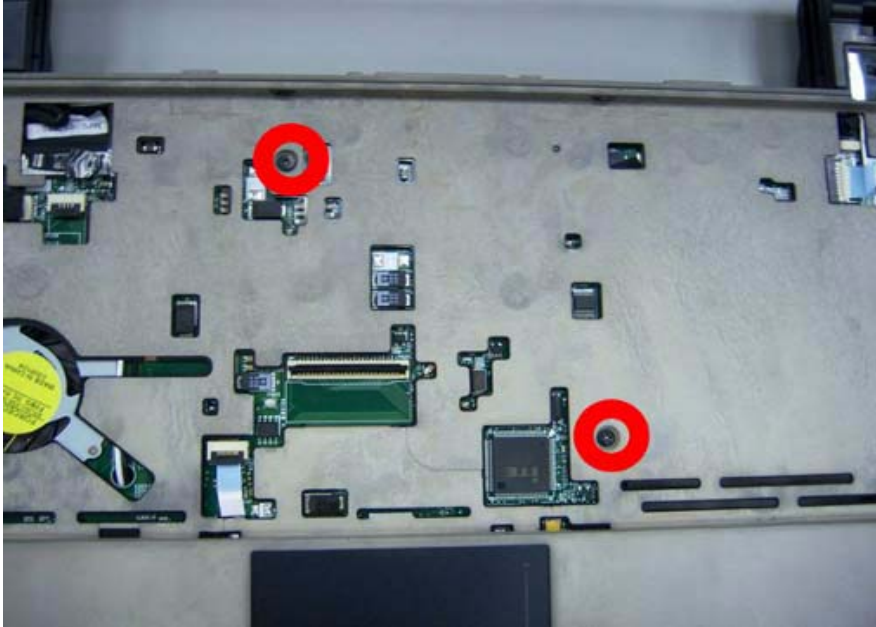

	Type	Number
	M2*6	2

6. Remove all of the screws on the back of the notebook.



	Type	Number
	M2*6	9

7. Remove the upper case.



Removing the LCD Module

1. Use the pull tab and Grab the LVDS cable.

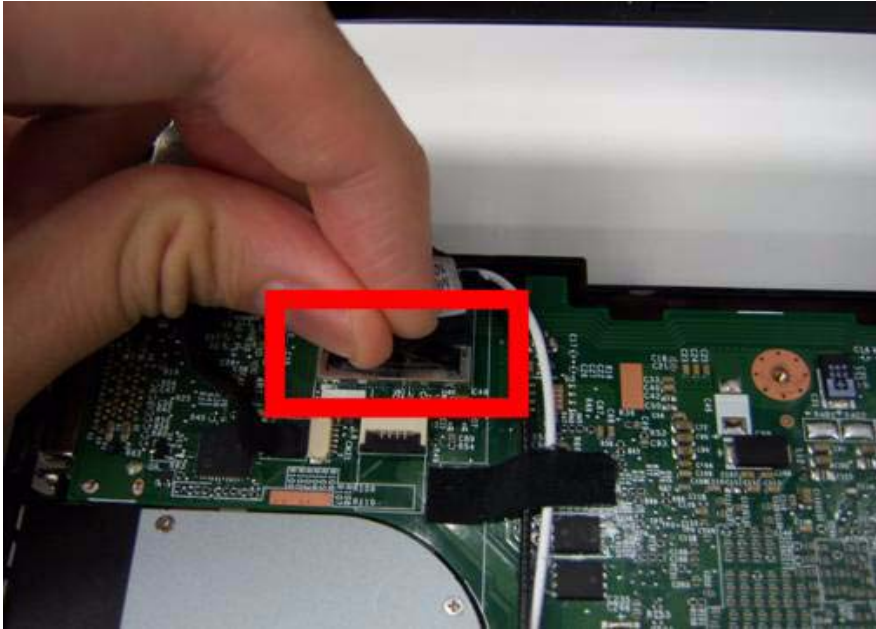

2. Disconnect the LVDS cable.

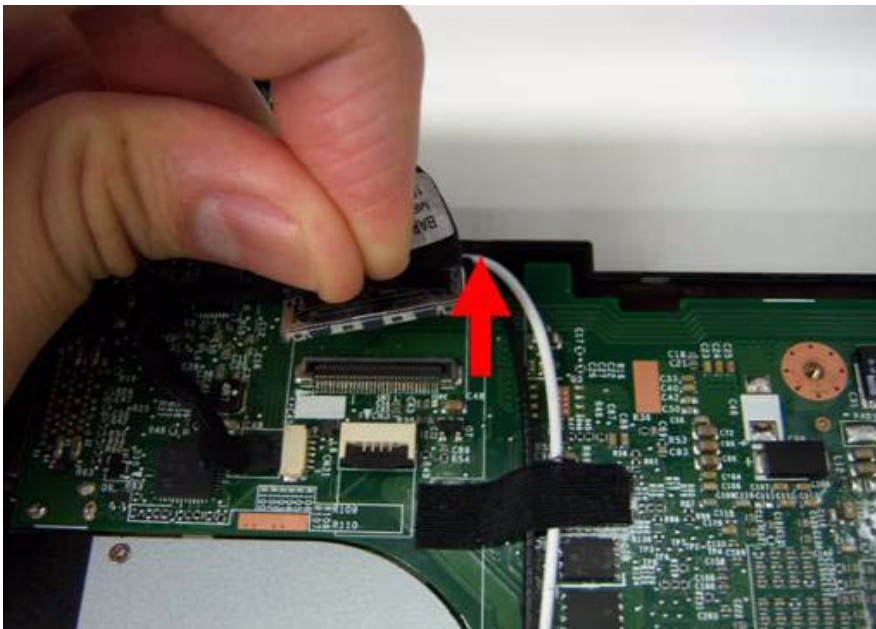

3. Grab the tape on the WLAN cable.

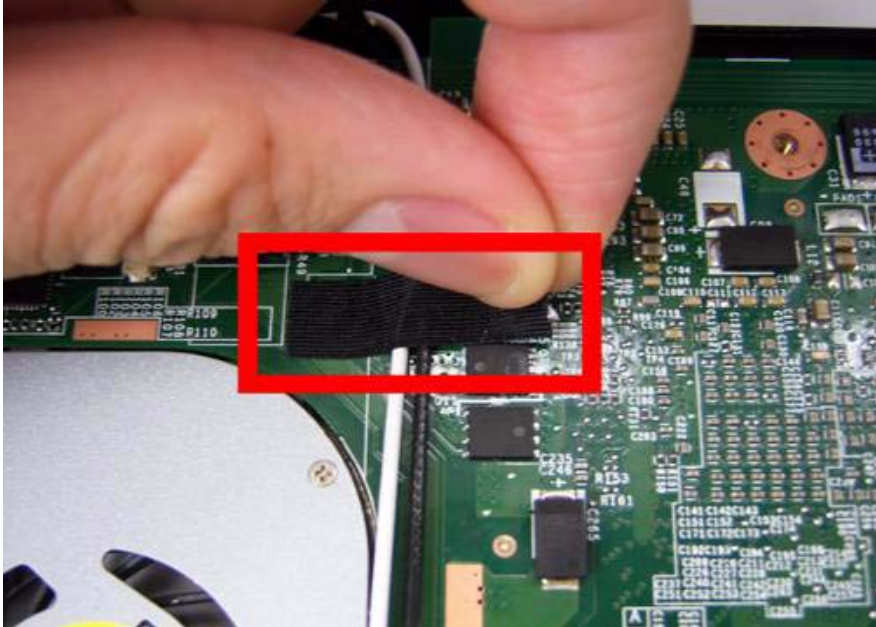

4. Remove the tape on the WLAN cable.



5. Release WLAN cable.



6. Remove 3G tape with the same method.

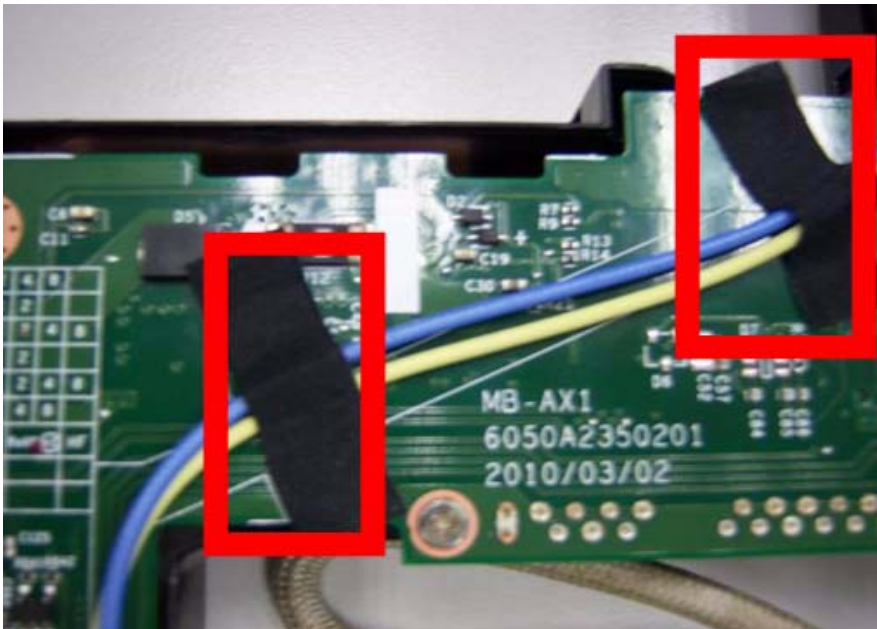

7. Release the 3G cable.



8. Grab the CCD connector.

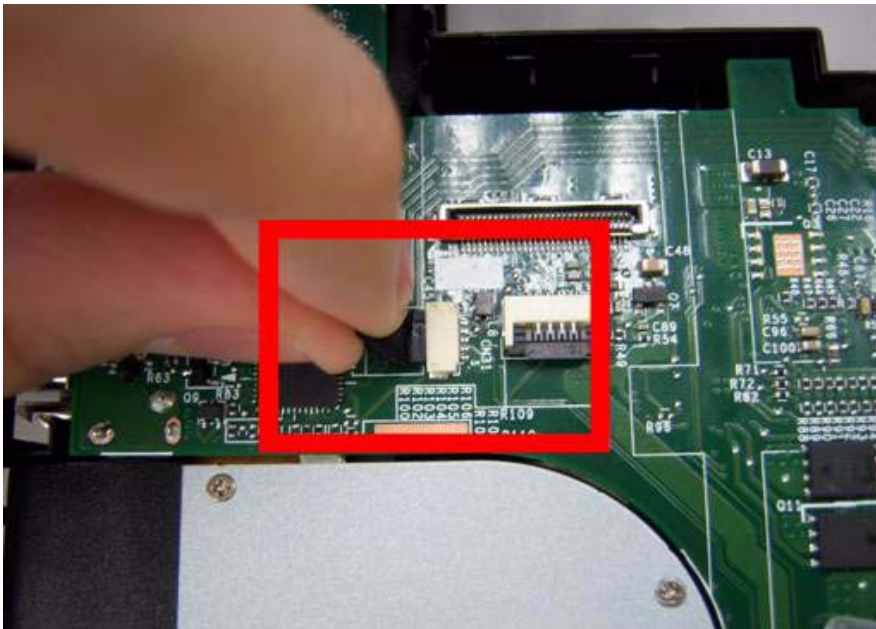

9. Disconnect the CCD connector.

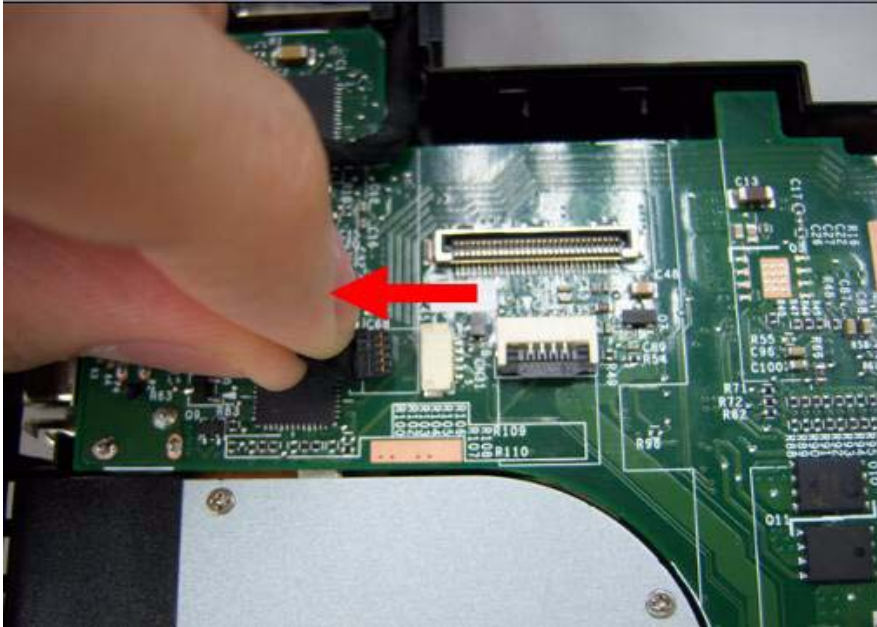

10. Grab the MIC cable.

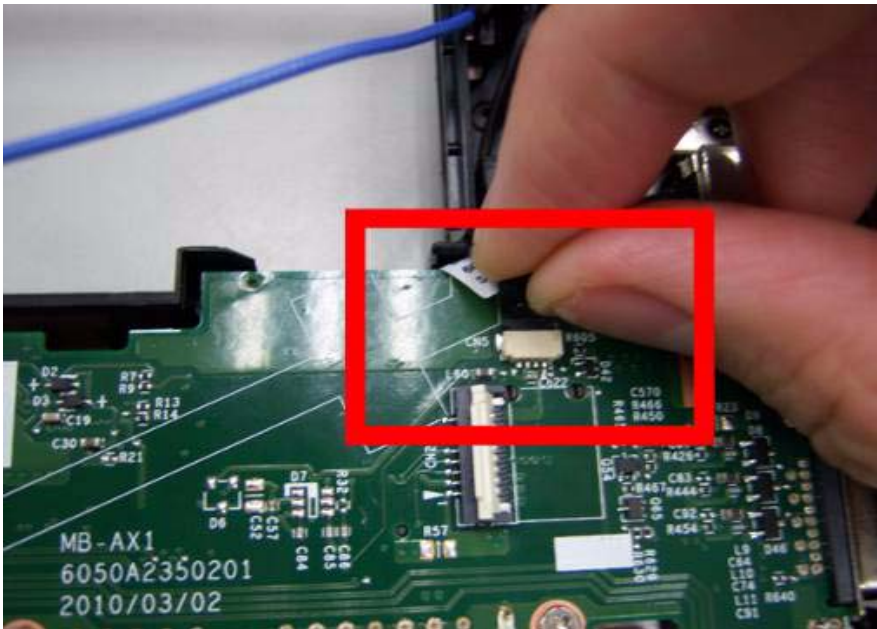

11. Disconnect the MIC cable.



12. Remove the screw from left hinge.



13. Remove the screws from right hinge.



	Type	Number
	M2.5*4	2

14. Remove the LCD module from the chassis

CAUTION: Make sure all cables are pulled back and away from the device to avoid damage during removal.

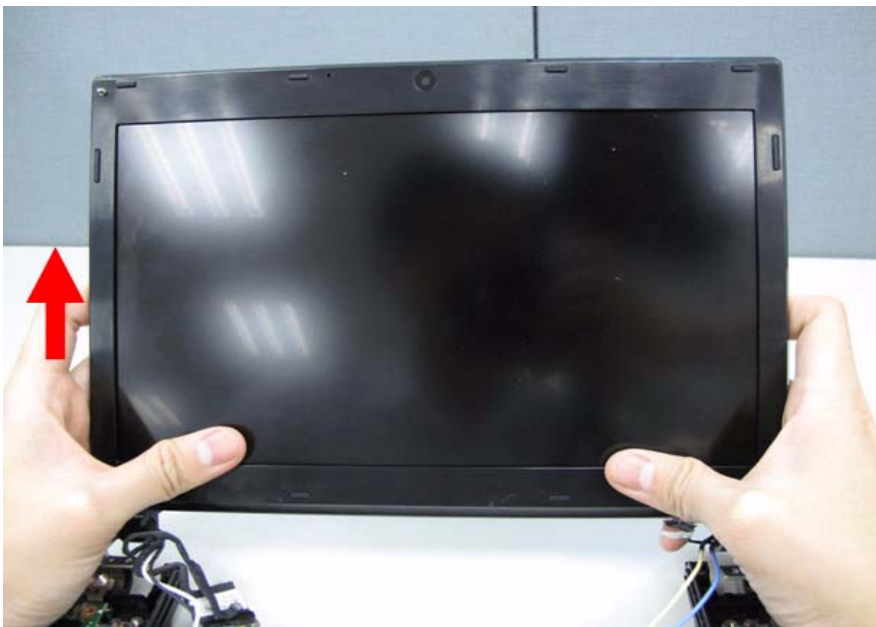

Removing the Bluetooth Module

IMPORTANT: Bluetooth Module may not represent the actual model. During the removal and replacement of components, ensure all available cable channels and clips are used and that the cables are replaced in the same position.

1. Grab the Bluetooth cable.

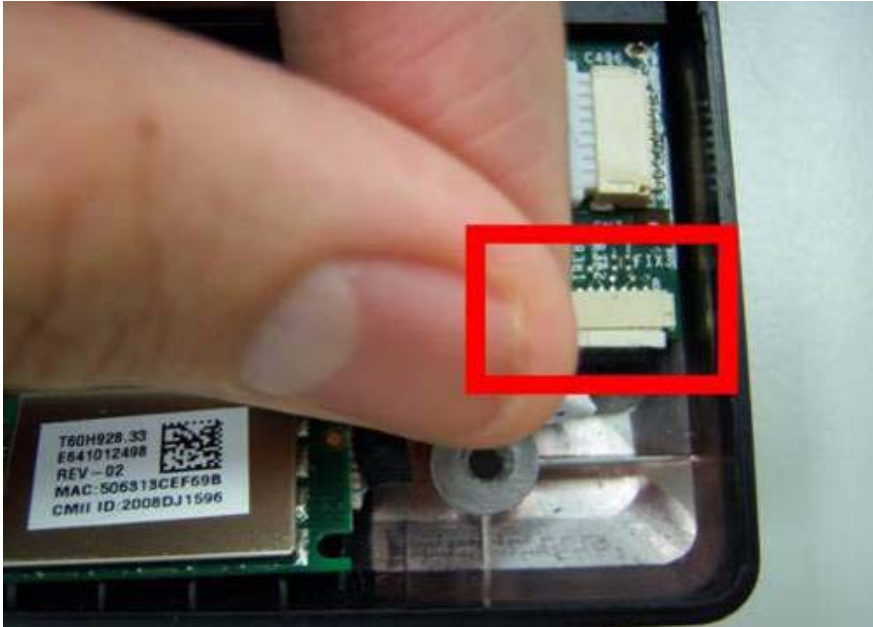

2. Disconnect the Bluetooth cable.

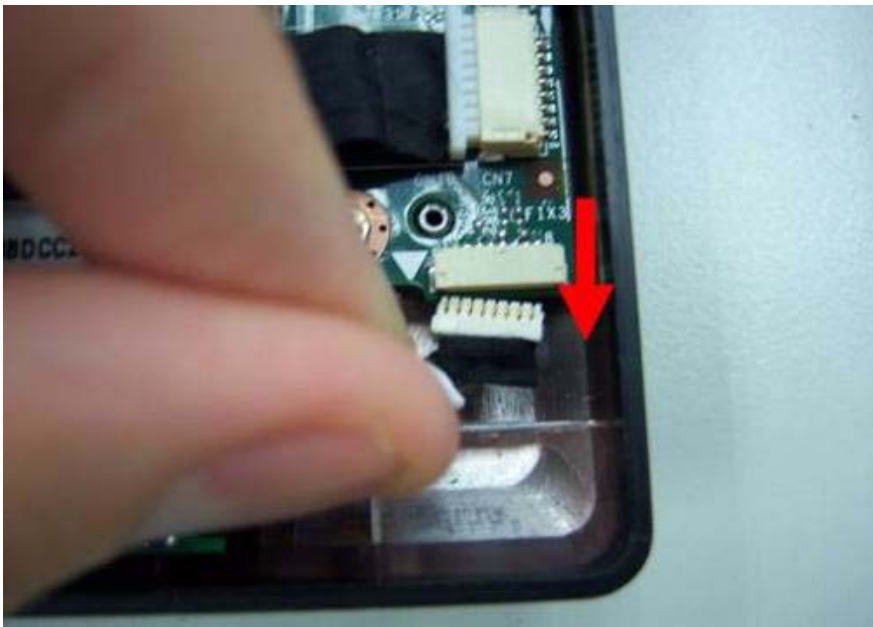

3. Remove the Bluetooth module.

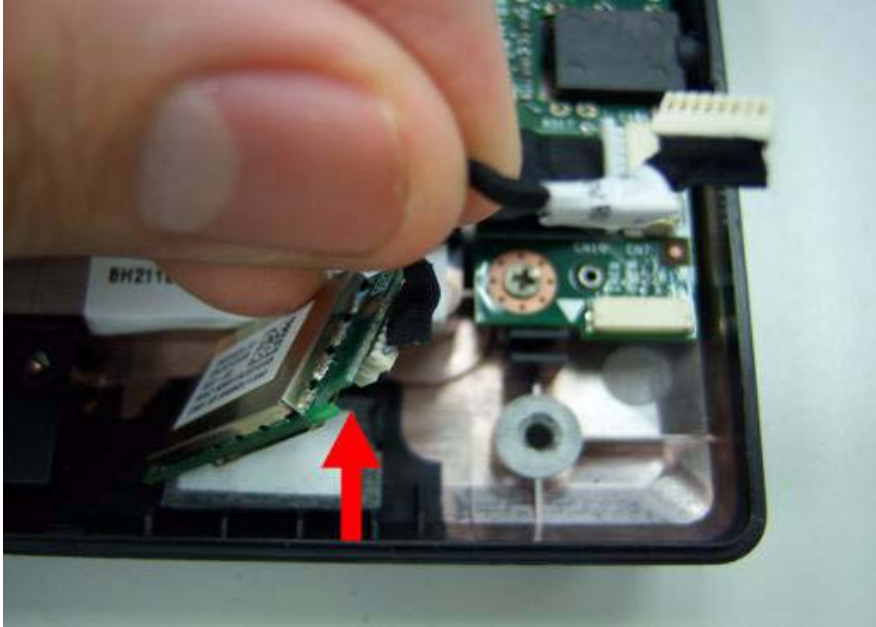

Removing the Mainboard

1. Disconnect the Audio cable.

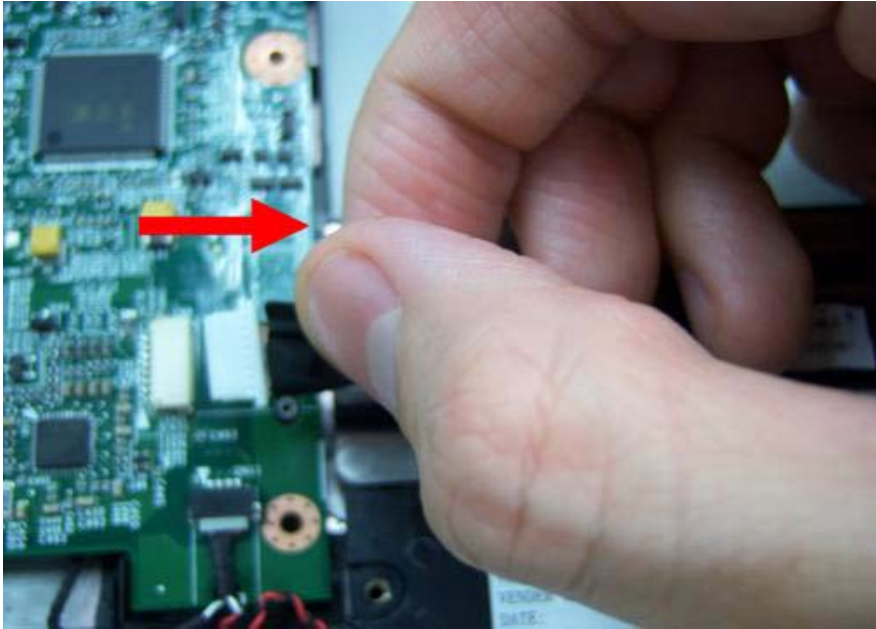

2. Disconnect another side of Audio cable.

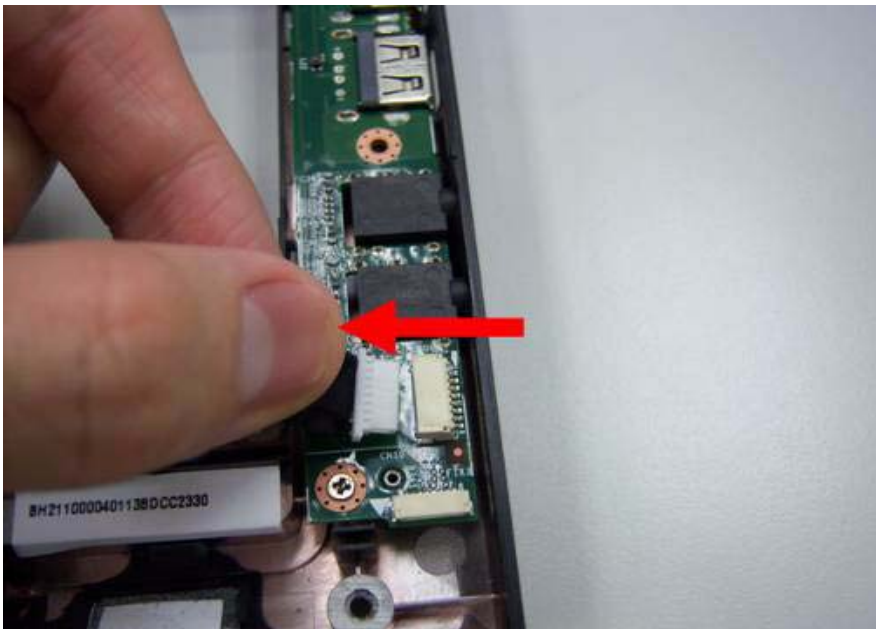

3. Remove the audio cable.

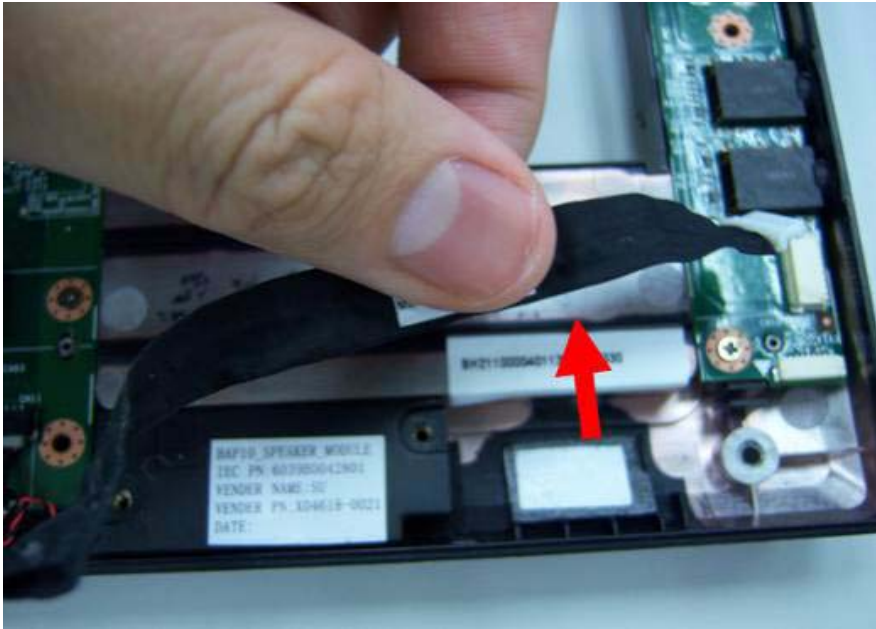

4. Remove the screws on the power bracket.



	Type	Number
	M2*3	1

5. Lift the power bracket from the mainboard.

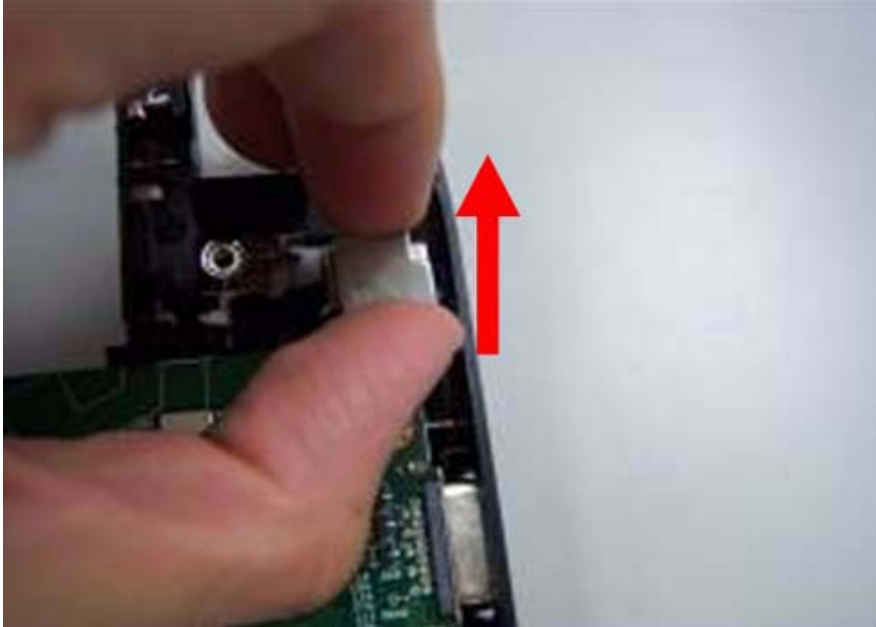

6. Grab the speaker connector.

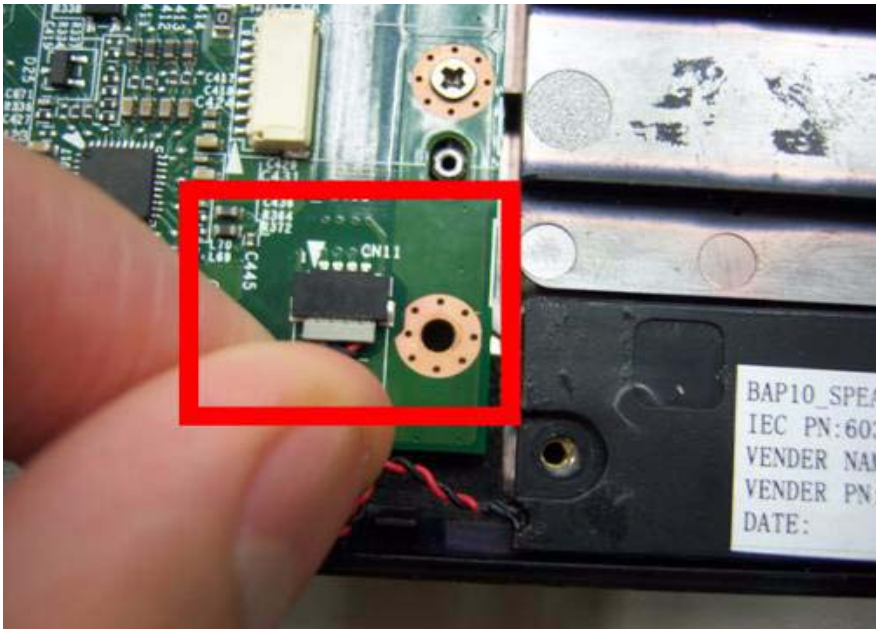

7. Remove the speaker connector.

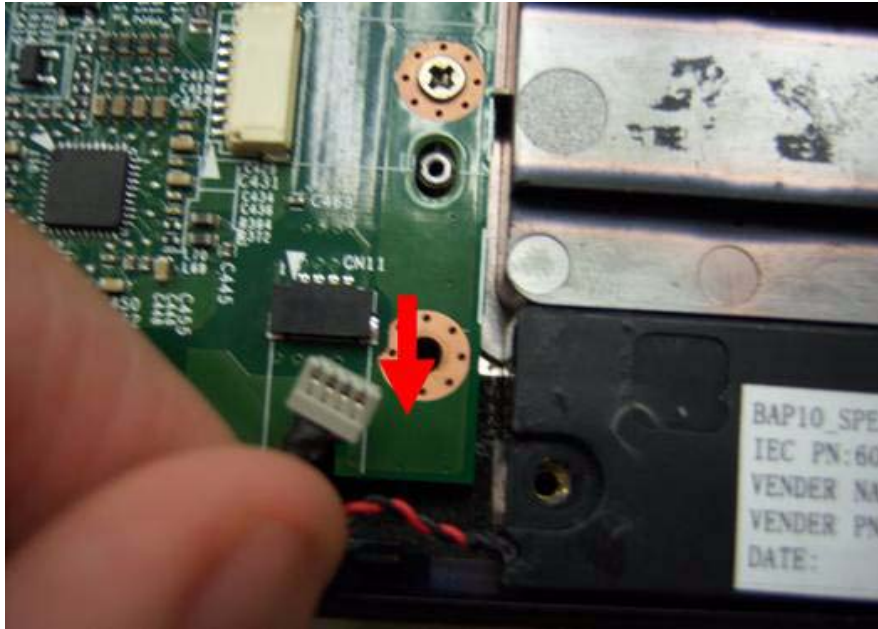

8. Remove four screws on the mainboard.



	Type	Number
	M2*3	1

9. Remove the Mainboard from button case.



NOTE: Circuit boards $>10\text{ cm}^2$ has been highlighted with the yellow rectangle as above image shows. Please detach the Circuit boards and follow local regulations for disposal.

10. Remove speaker module.

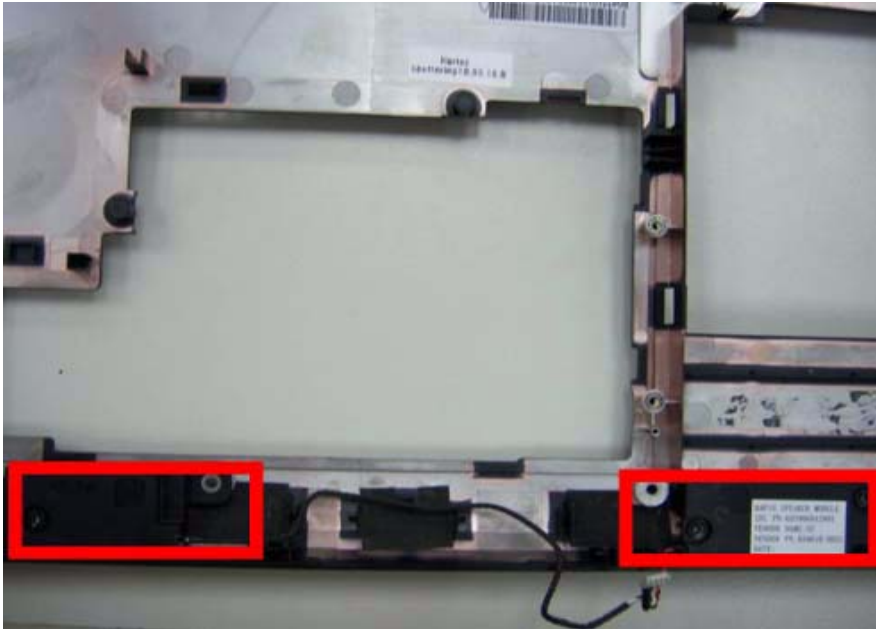

11. Grab the speaker module and remove it carefully.

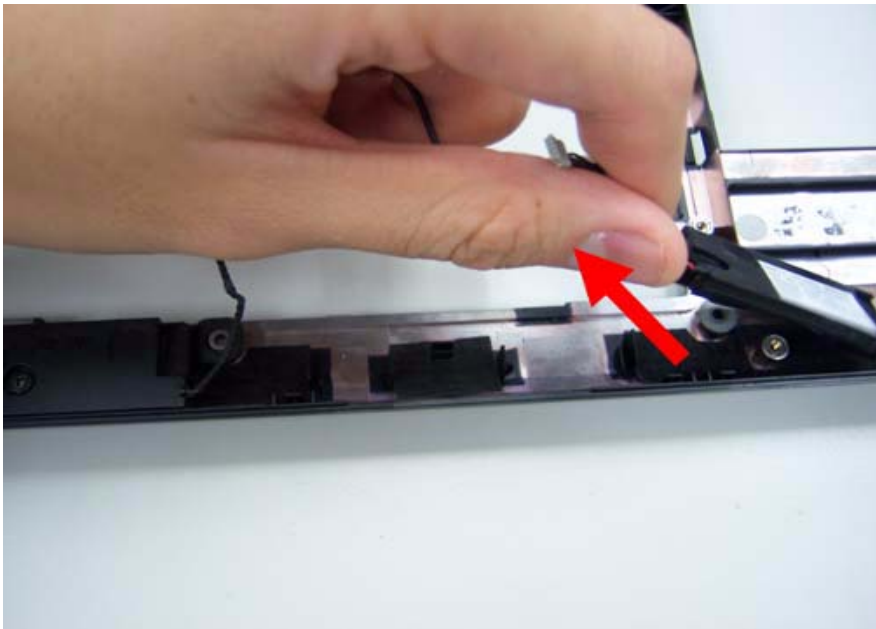

12. Disassemble the power connection.

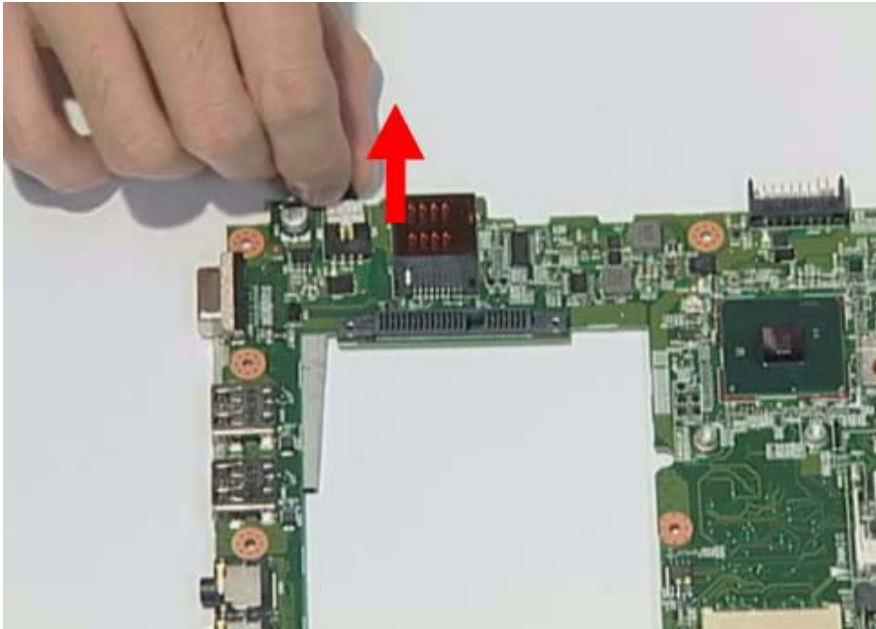

13. Disassemble fan connector.

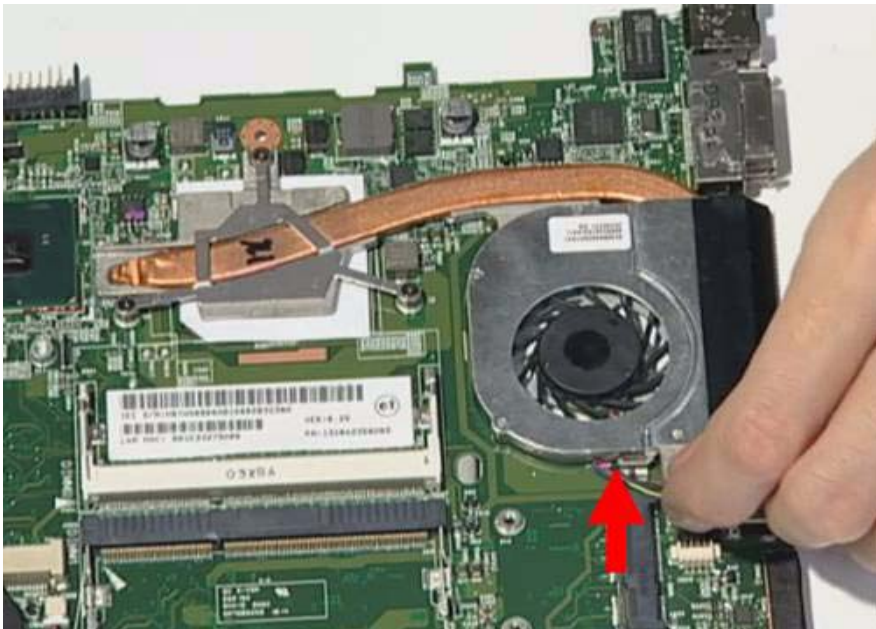

14. Release four screws on the thermal module.

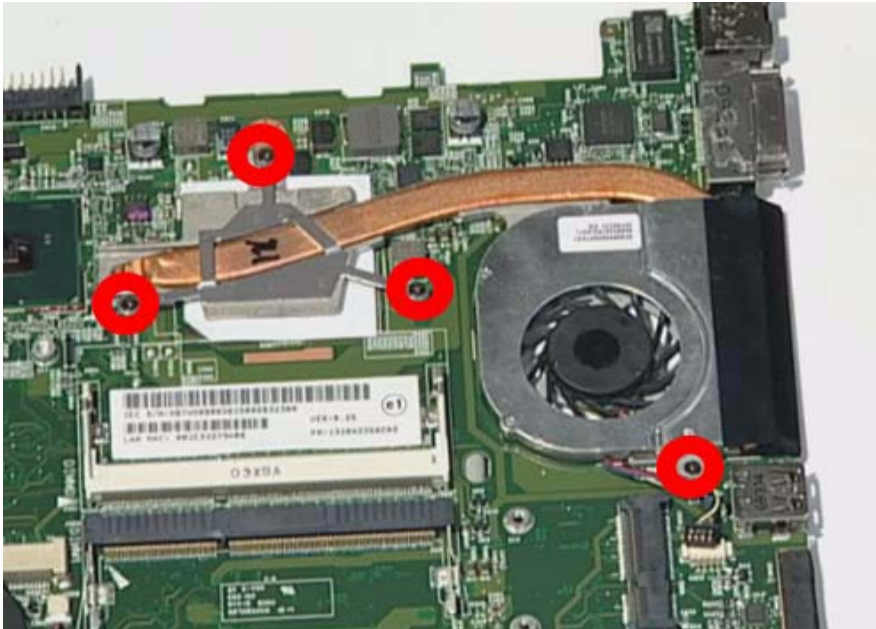

15. Remove thermal module.

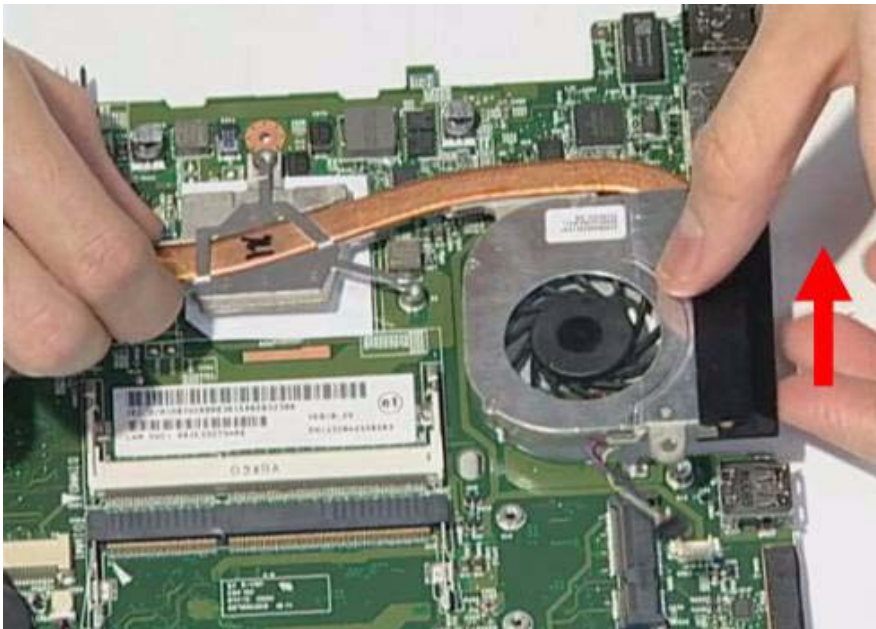

16. Release the connector of LED board.

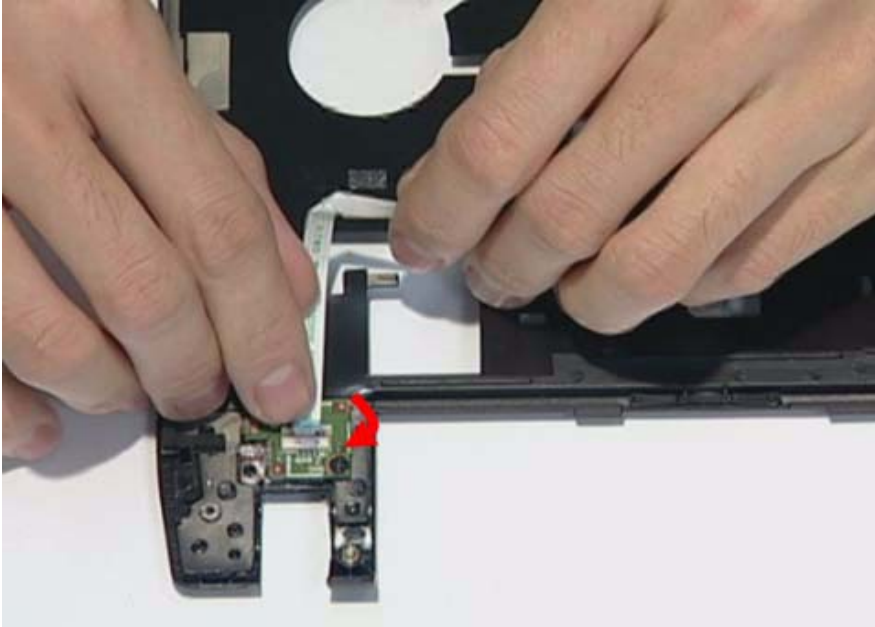

17. Release one screw on the LED board.

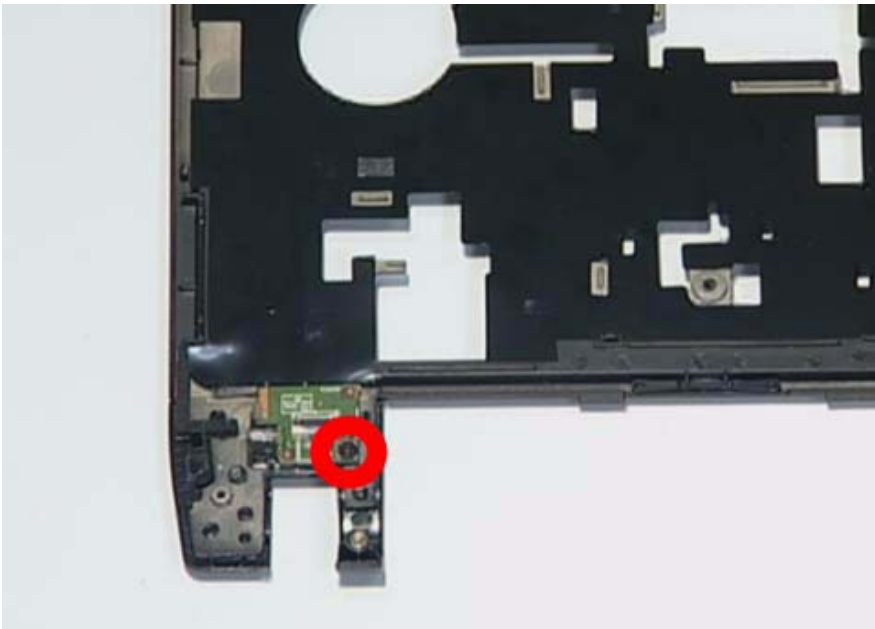

	Type	Number
	M2.5*4	1

18. Remove the LED board.

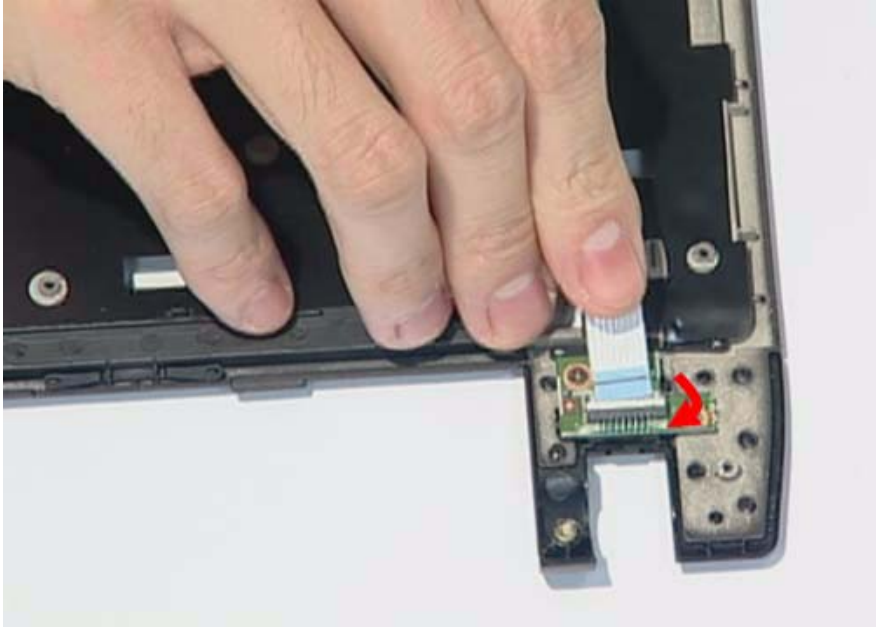

19. Release the connector of power board.

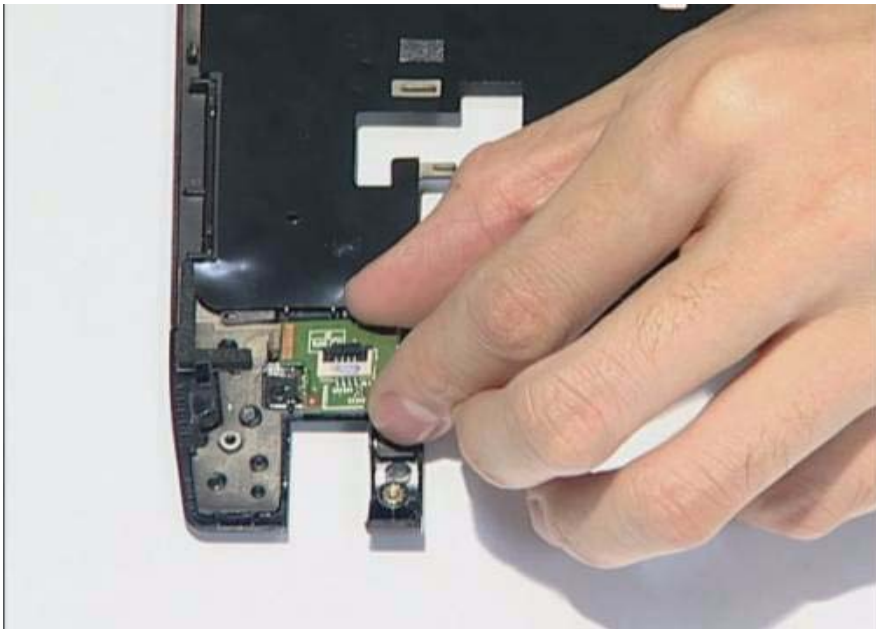

20. Release the screw on the power board.

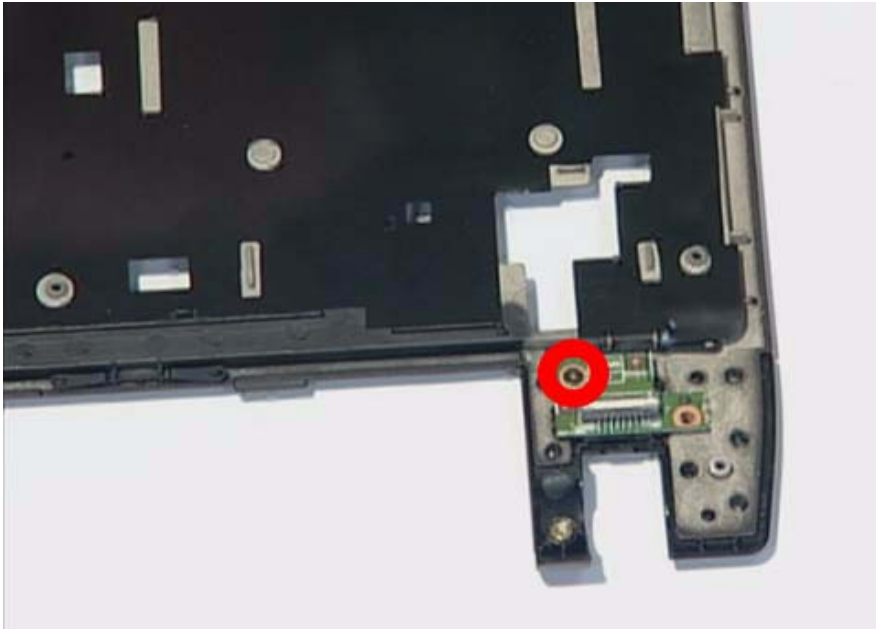

	Type	Number
	M2.5*4	1

21. Remove the power board.

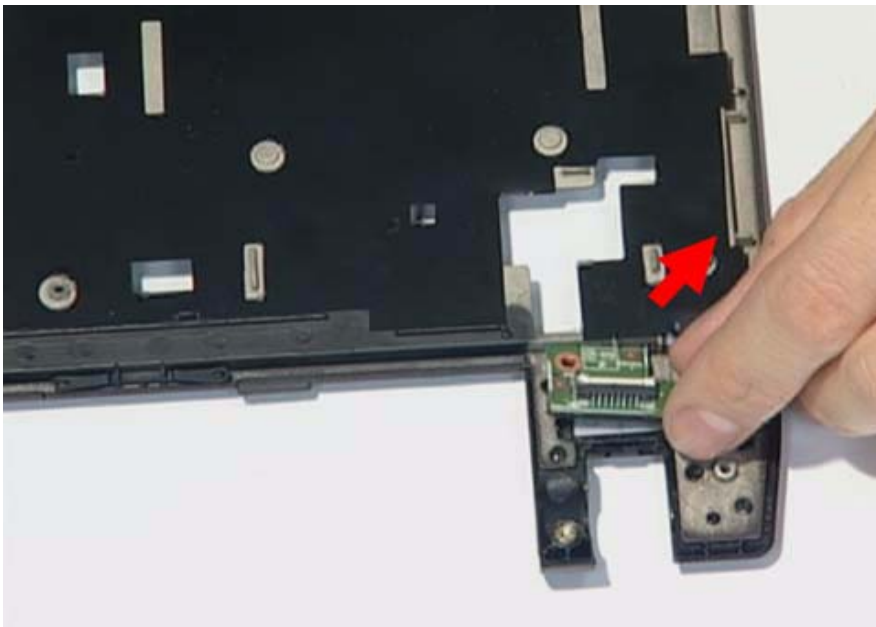

22. Release the connector of touch pad board and release the FFC on it.

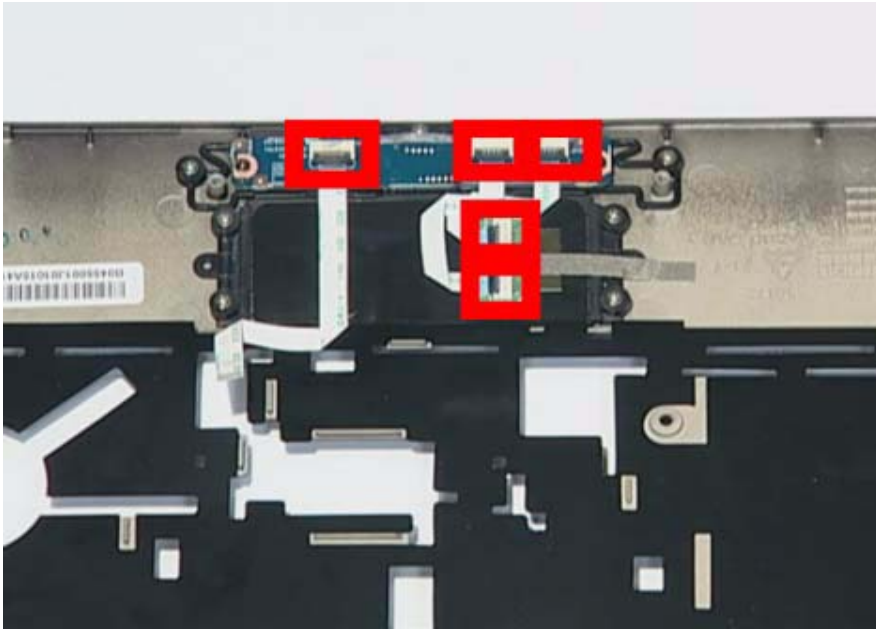

23. Remove two screws on the touch pad board.

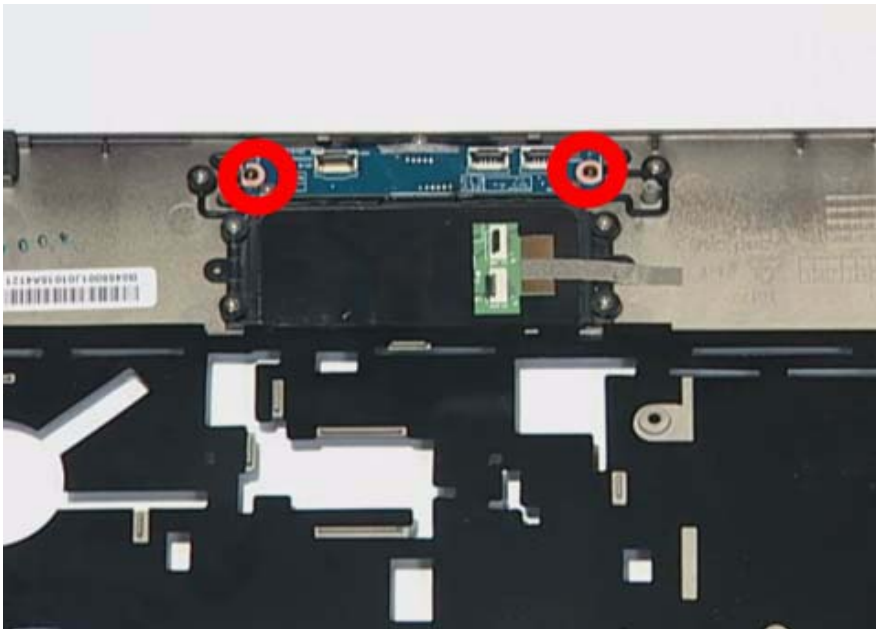

	Type	Number
	M2.5*4	2

24. Remove the touch pad board.

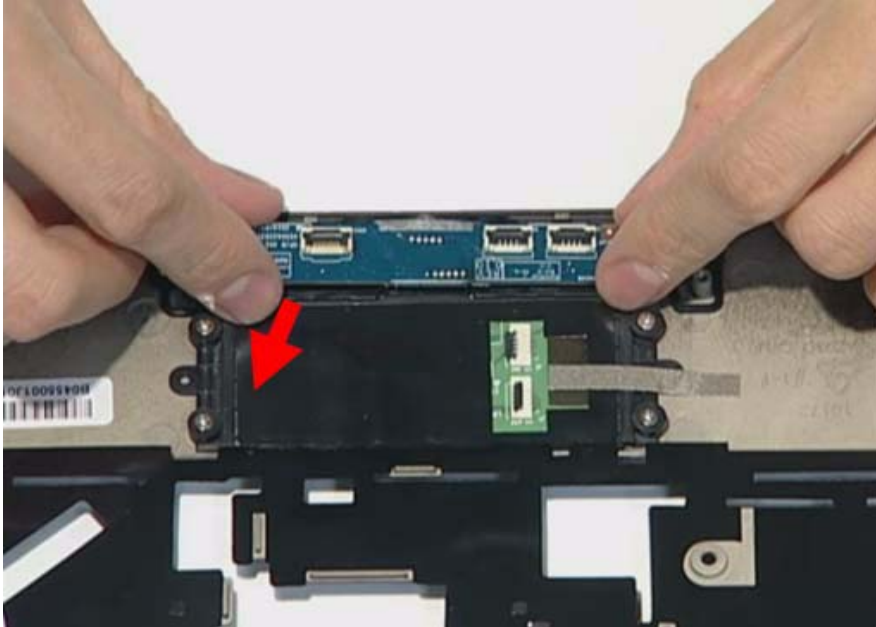

LCD Module Disassembly Process

IMPORTANT: Cable paths and positioning may not represent the actual model. During the removal and replacement of components, ensure all available cable channels and clips are used and that the cables are replaced in the same position.

NOTE: The product previews seen in the disassembly procedures may not represent the final product color or configuration.

LCD Module Disassembly Flowchart

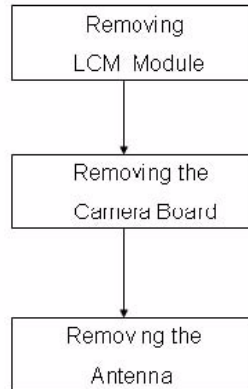

Screw List

Step	Screw	Quantity	part no
LCD Bazel Disassembly	M2.5*4L	2	
LCD Panel Disassembly(Down)	M2.5*4L	2	
LCD Panel Disassembly(Up)	M2*3L	2	
Hinge Disassembly	M2*2.5L	4	

Removing the Mainboard

- 1. Use the tweezers to remove the gasket on the bezel.



	Type	Number
	M2.5*4	2

- 2. Remove two screws under the gaskets.



-
3. Pry the bezel away from the top-center and then work around until the entire bezel is detached.

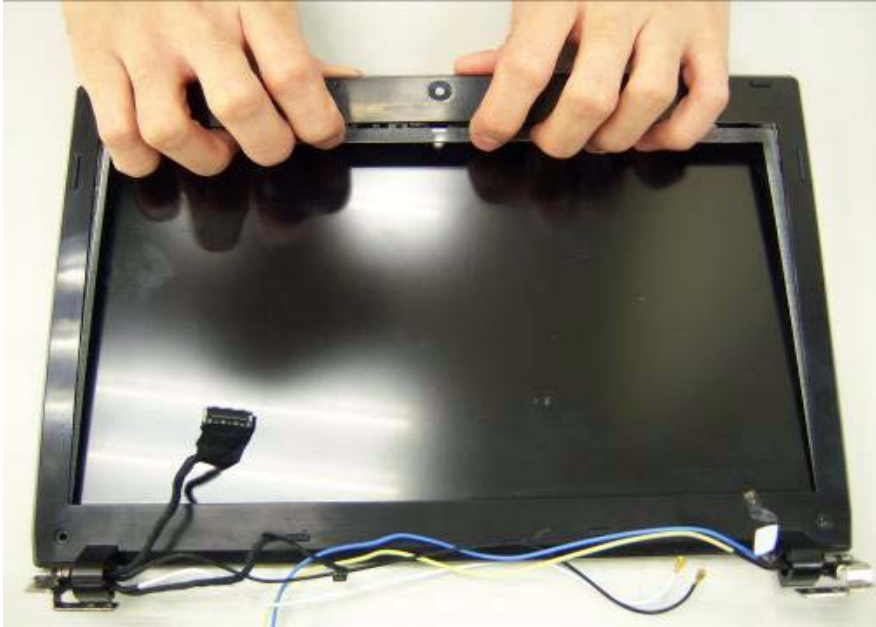

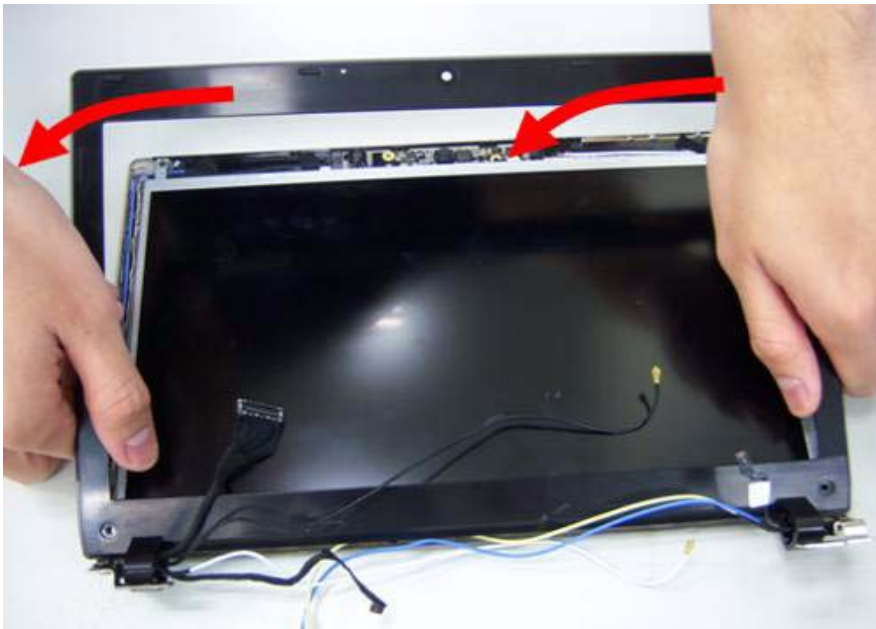

4. Remove the bezel from LCD module.



5. Remove four screws on the corner of LCM.



	Type	Number
	M2.5*4	2
	M2*3	1

6. Lift the panel out.

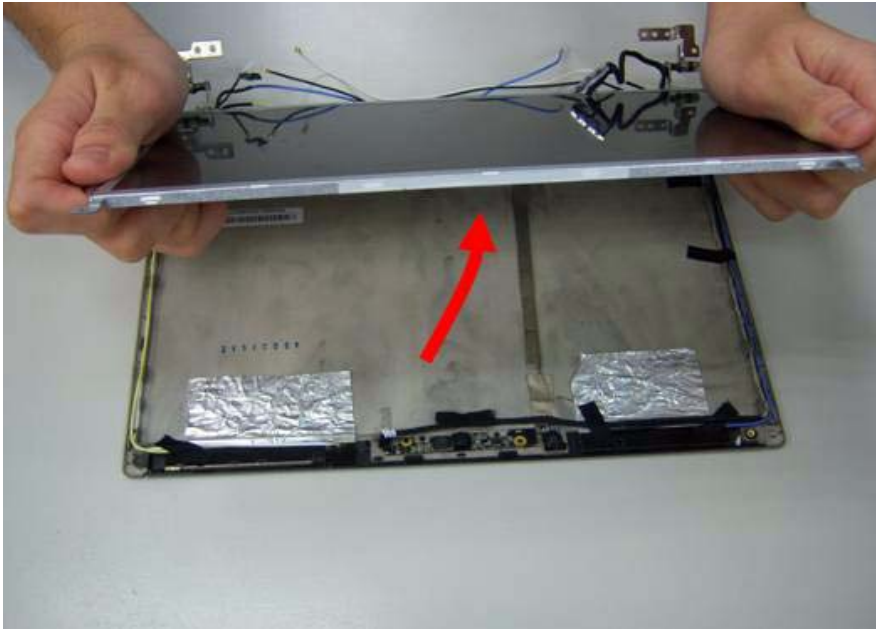

Removing the Camera Board

1. Disconnect the webcam.

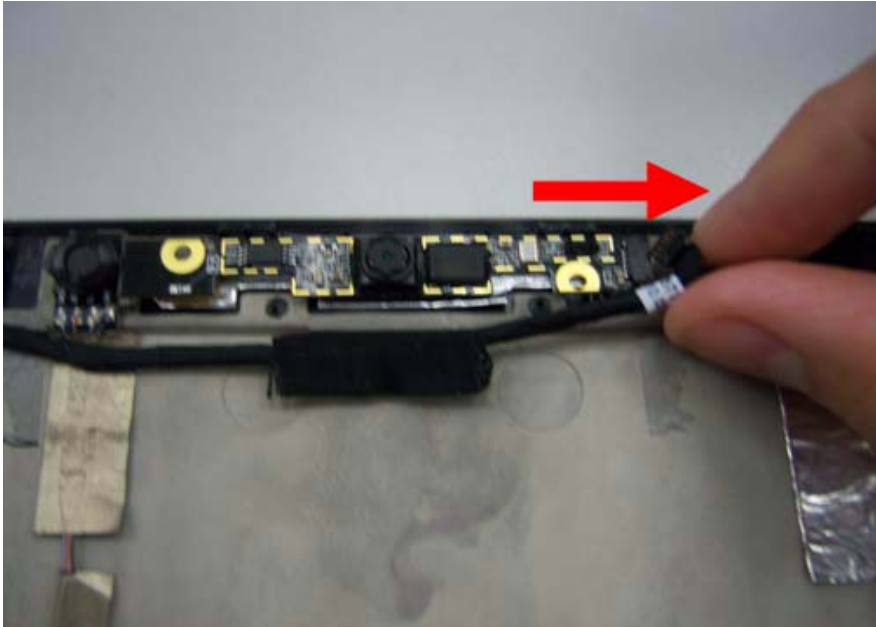

2. Remove webcam module.

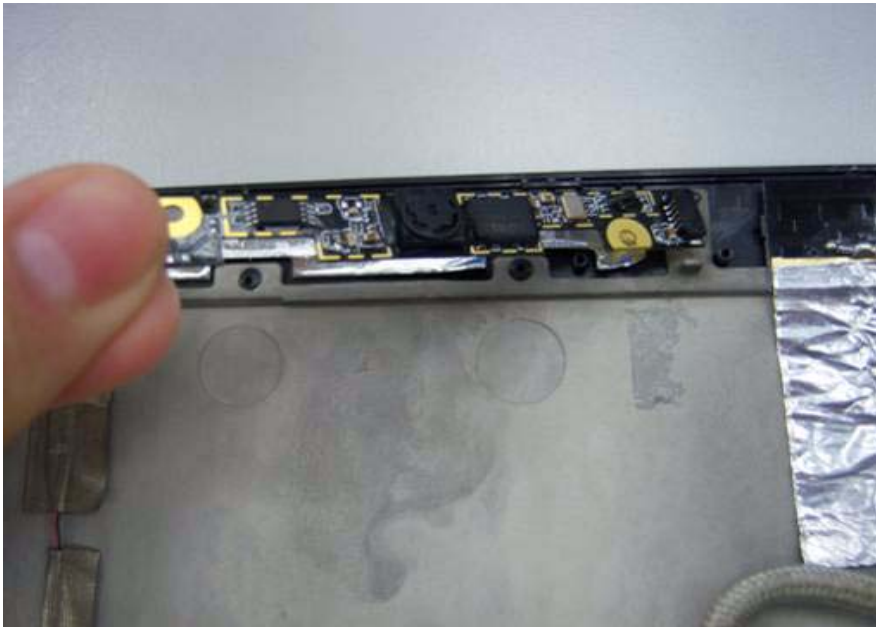

Remove the Antennas

- 1. Release four screws from the LCD bracket.

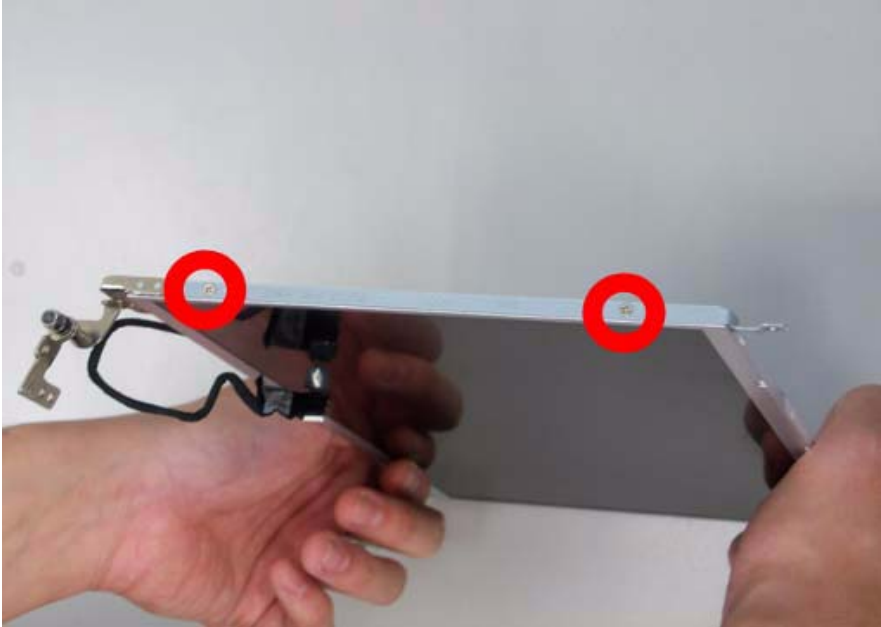
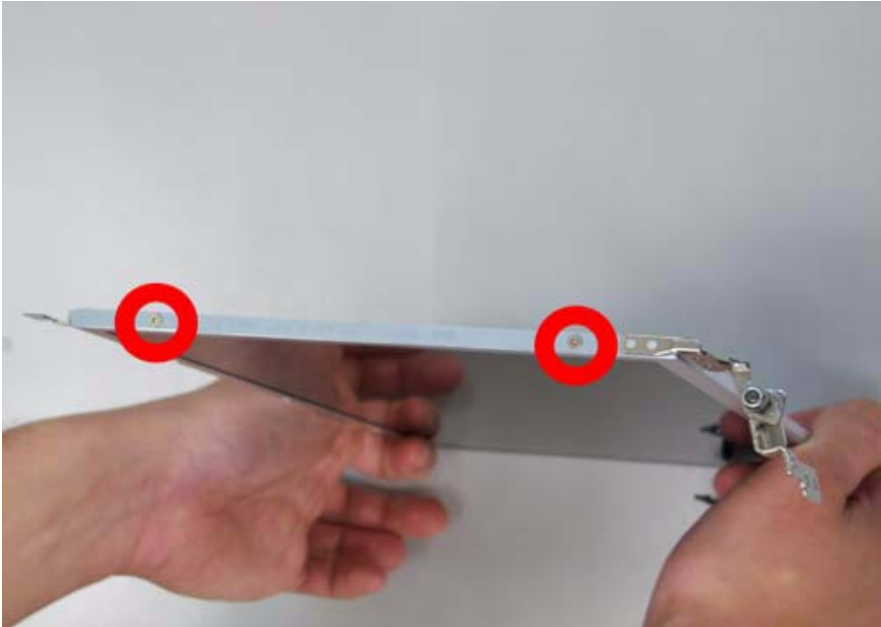

2. Remove the LCD bracket.



	Type	Number
	M2*2.5	4

3. Remove the two tapes on the microphone cable.



-
4. Remove the microphone.



5. Remove the three tapes on the antenna cable.

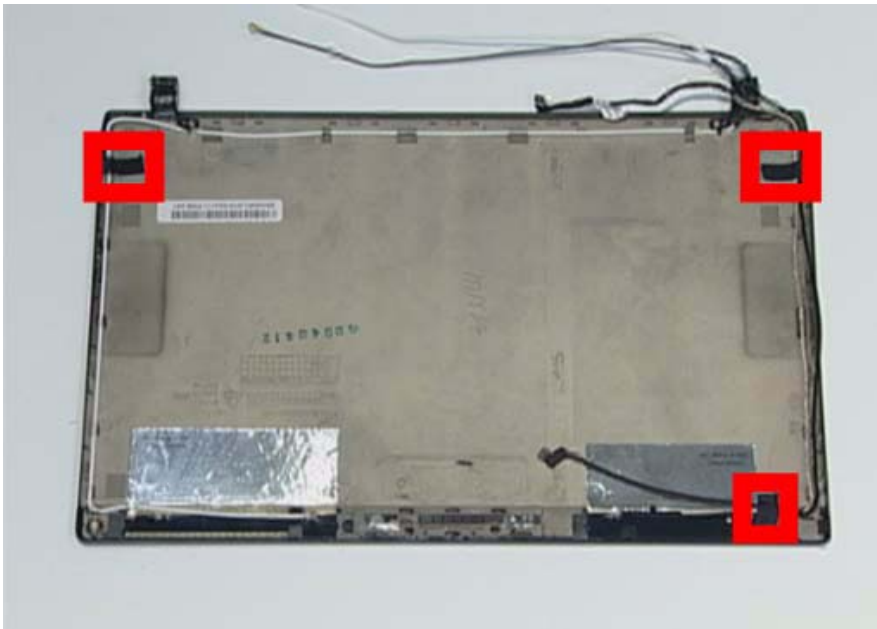

6. Remove the microphone cable.

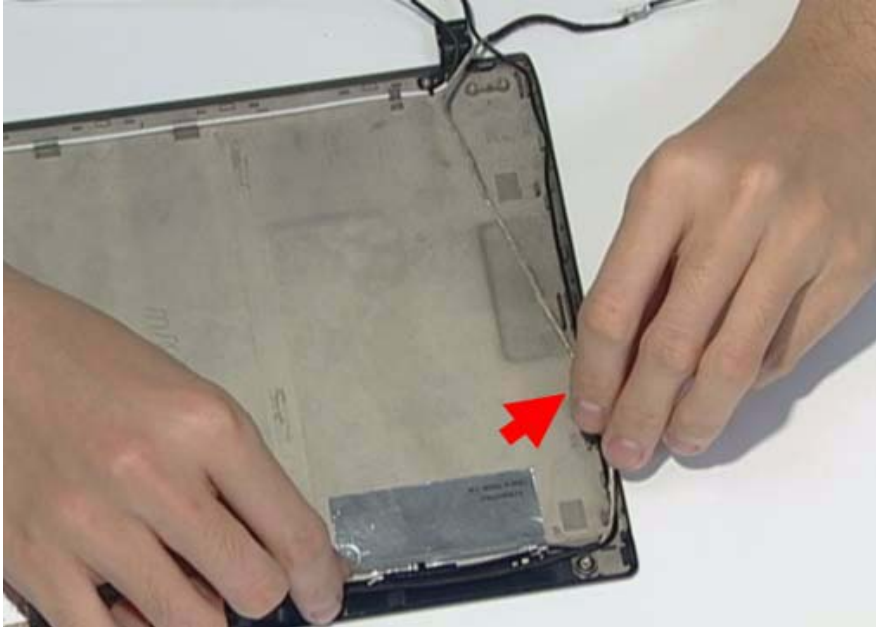

7. Remove the LAN black antenna aluminum foil.

NOTE: The aluminum foil only use one time. Please prepare new replacement for assemble.

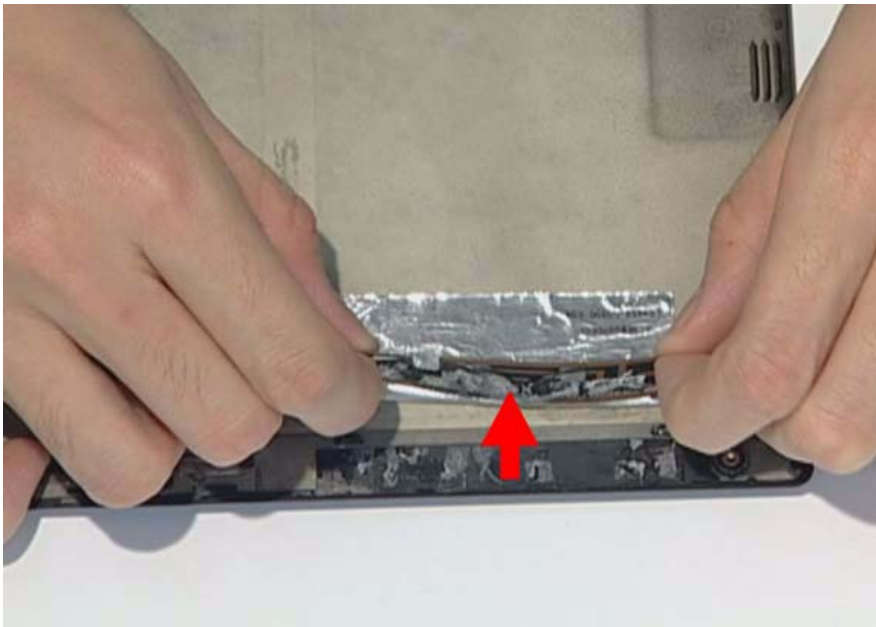

8. Remove the LAN white antenna.

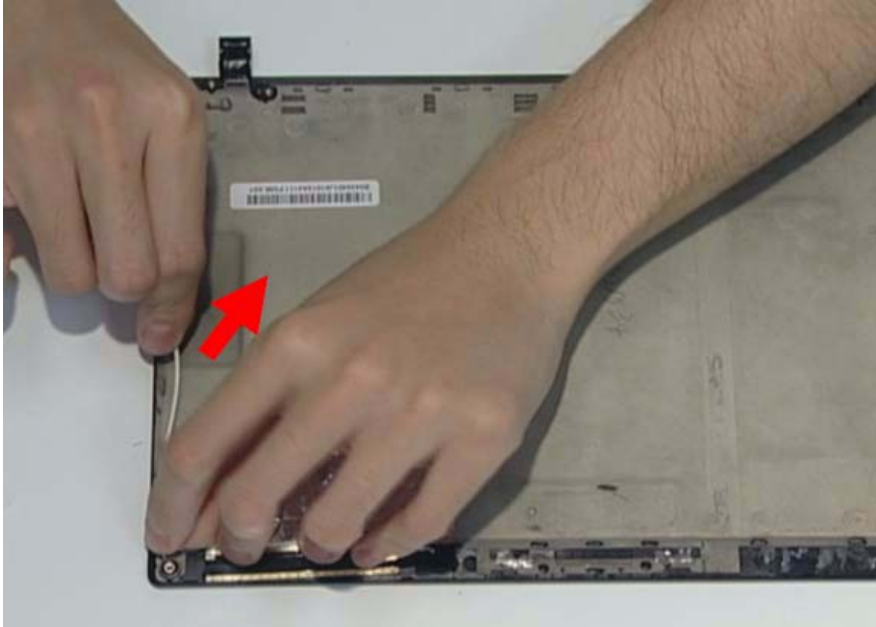

9. Remove the LAN white antenna aluminum foil.

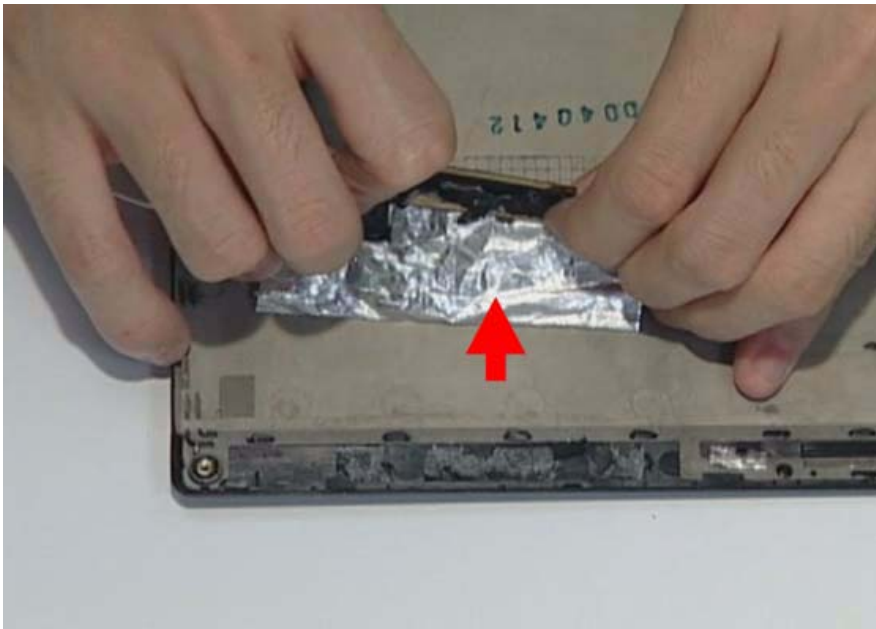

LCD Reassembly

Replacing the Antenna

1. Replace the LAN white antenna aluminum foil.



2. Replace the LAN white antenna.



-
3. Replace the LAN black antenna aluminum foil.

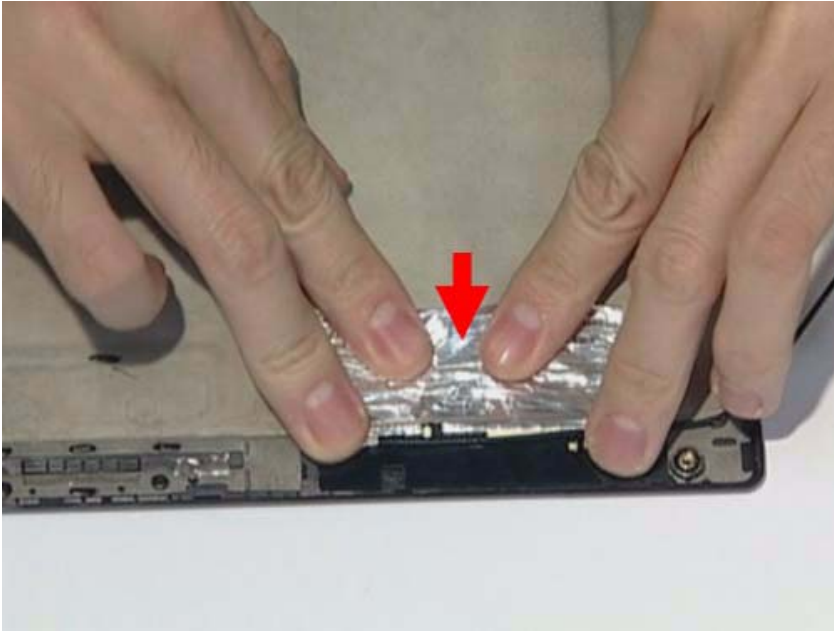

4. Replace the LAN black antenna.

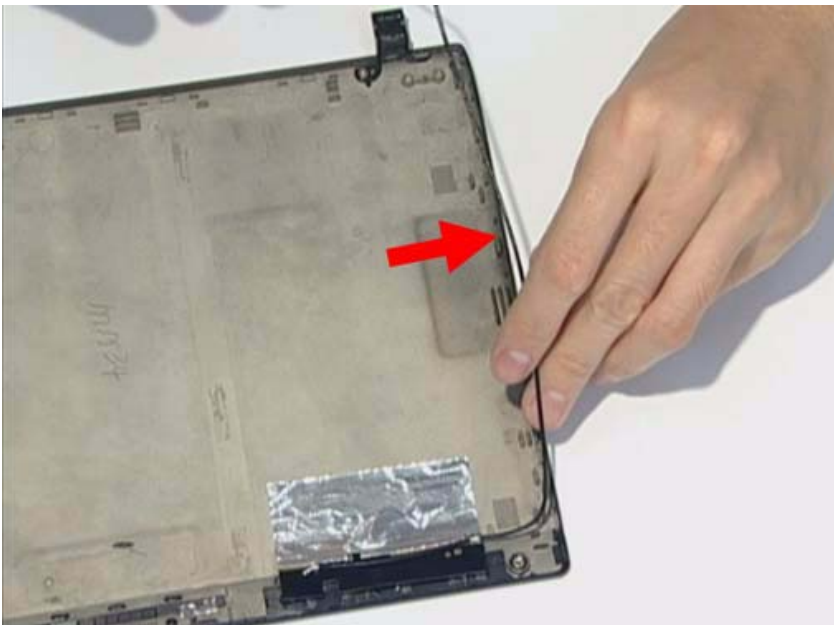

5. Replace the microphone cable.

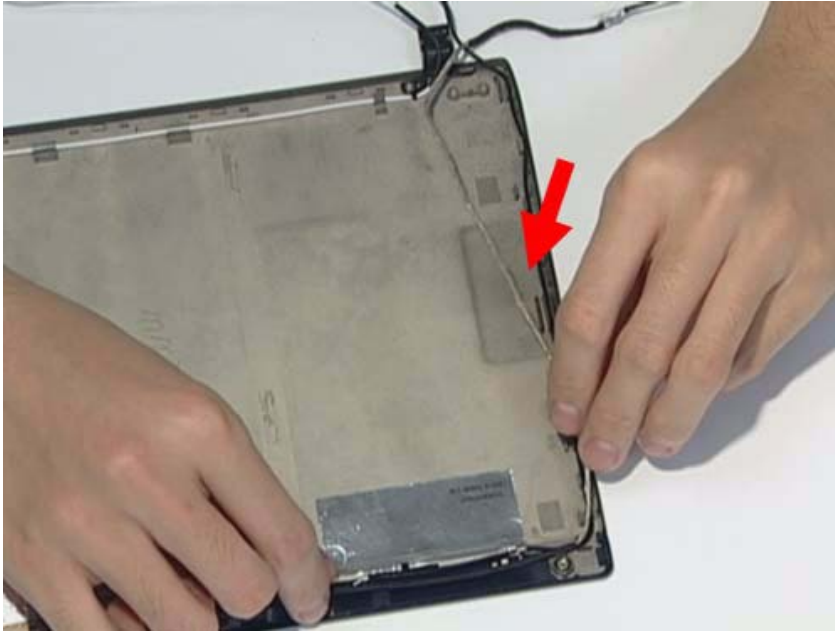

6. Replace the three tapes on the antenna cable.

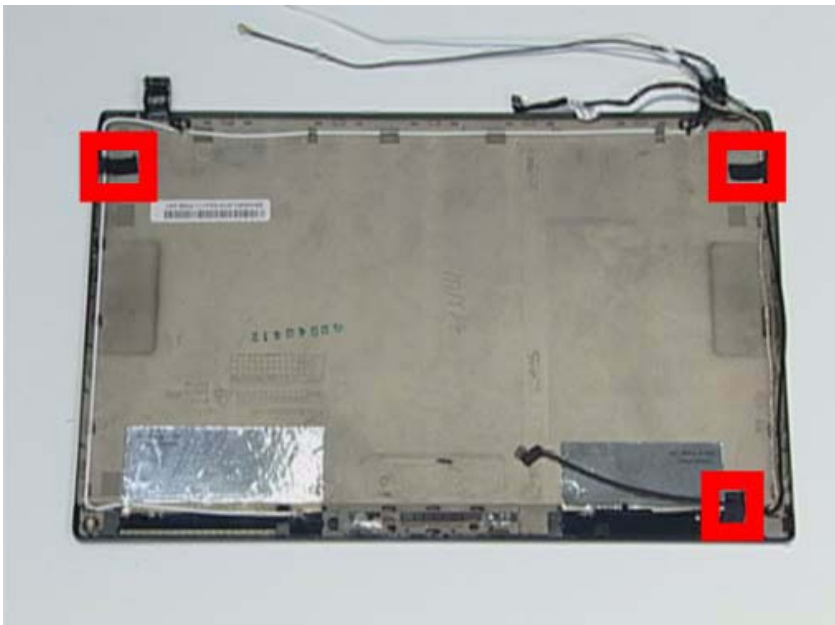

-
7. Lay the microphone cable in the LCD cover.



8. Replace the microphone.

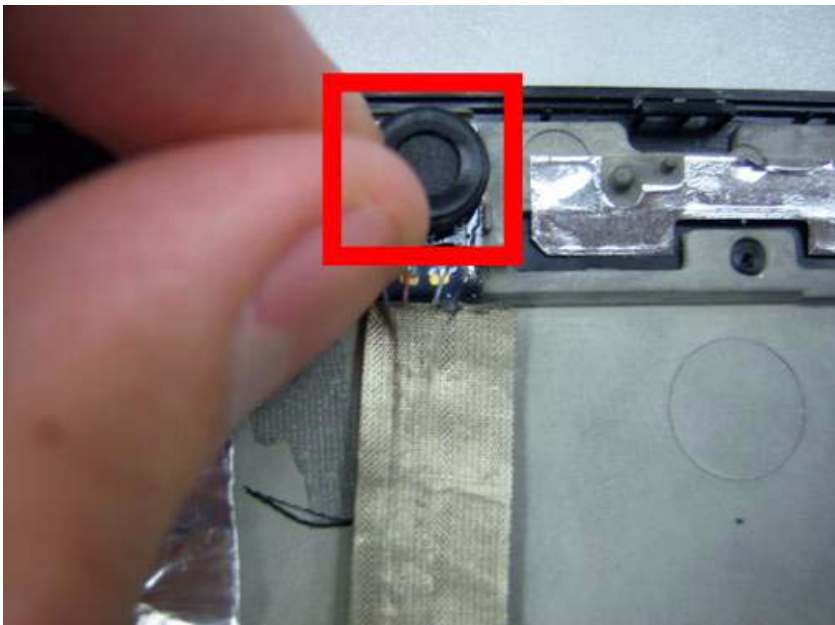

Replacing the Camera Board

1. Replace the webcam connector.

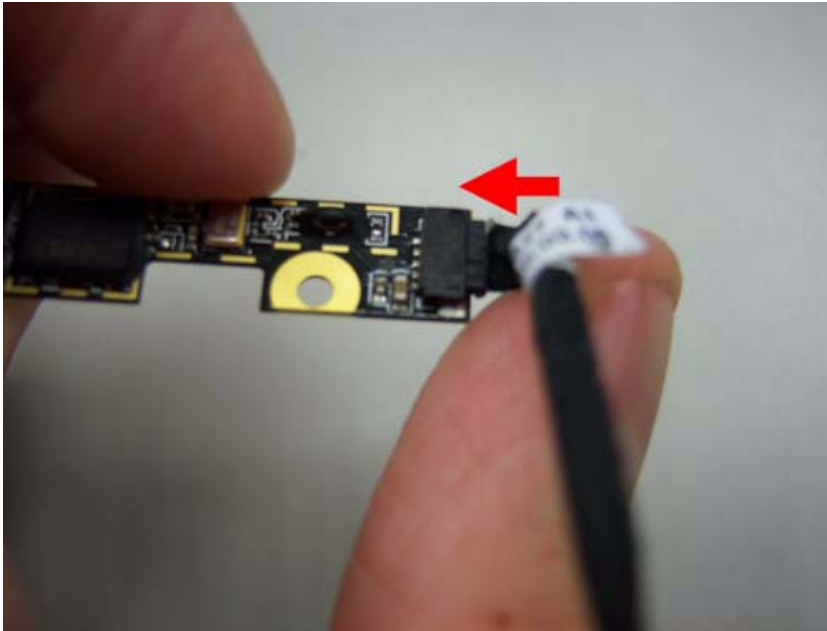

2. Place the webcam in the slot.

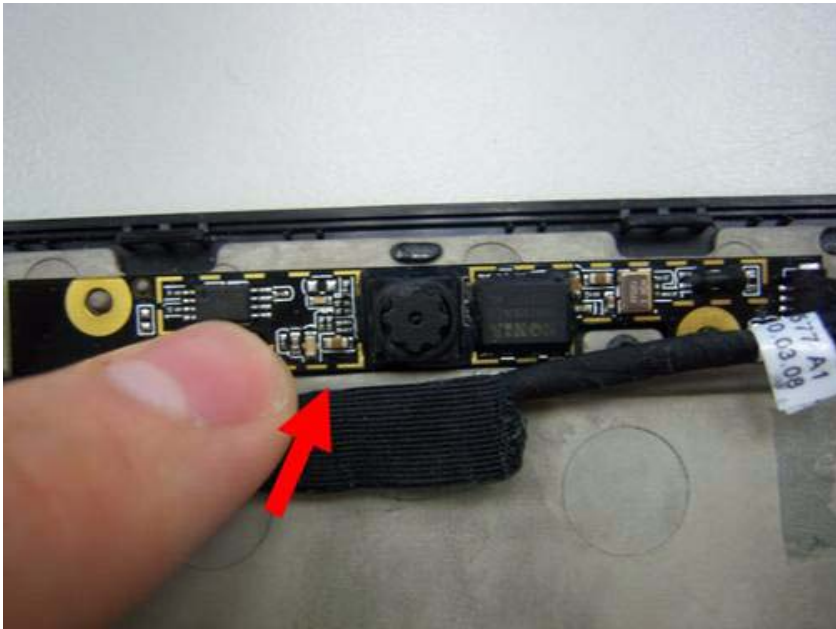

Replace the Wireless LAN Module

1. Insert the wireless LAN module into the connector.

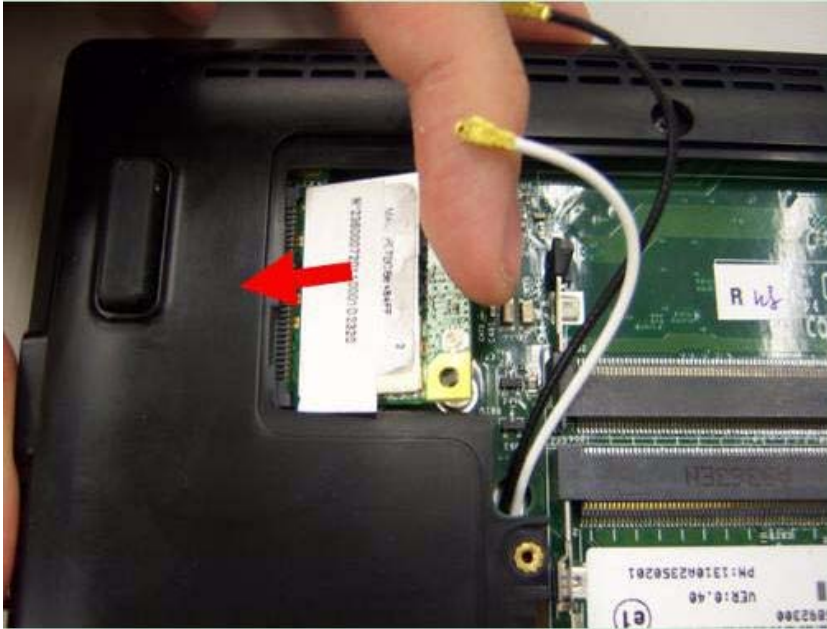

2. Fasten two screws on the wireless LAN module and connect black and white antenna line to the wireless LAN module.



Replacing LCM Module

1. Replace the bracket to the panel.



2. Replace four screws on the bracket of the panel.

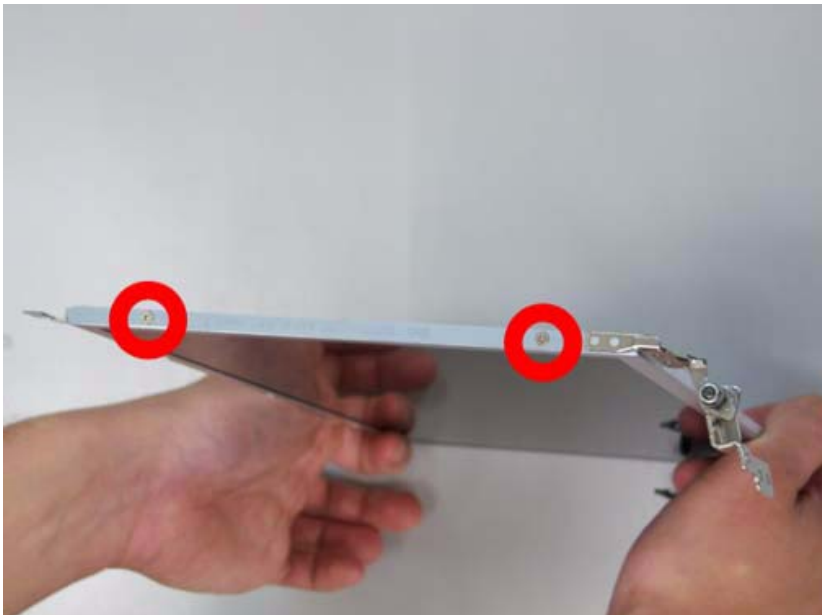

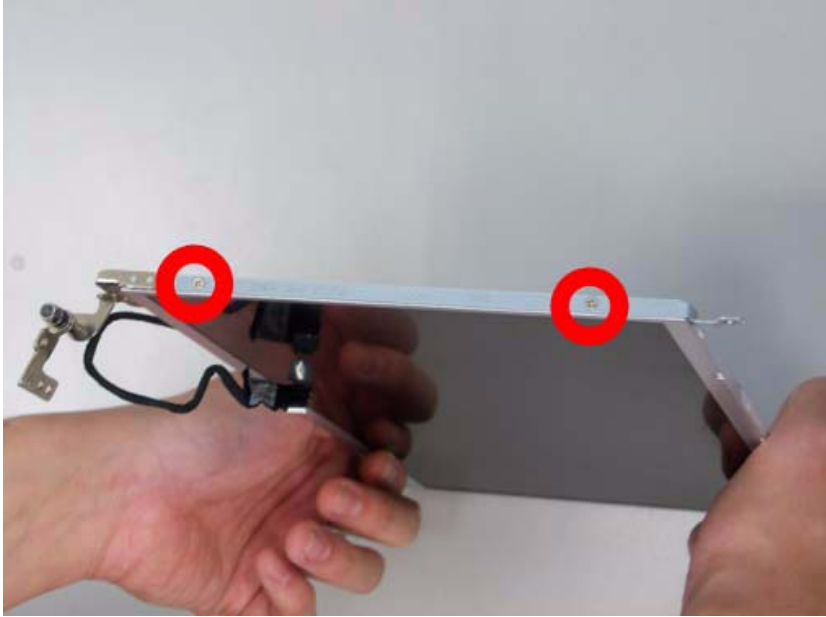

3. Replace the panel on the top case.

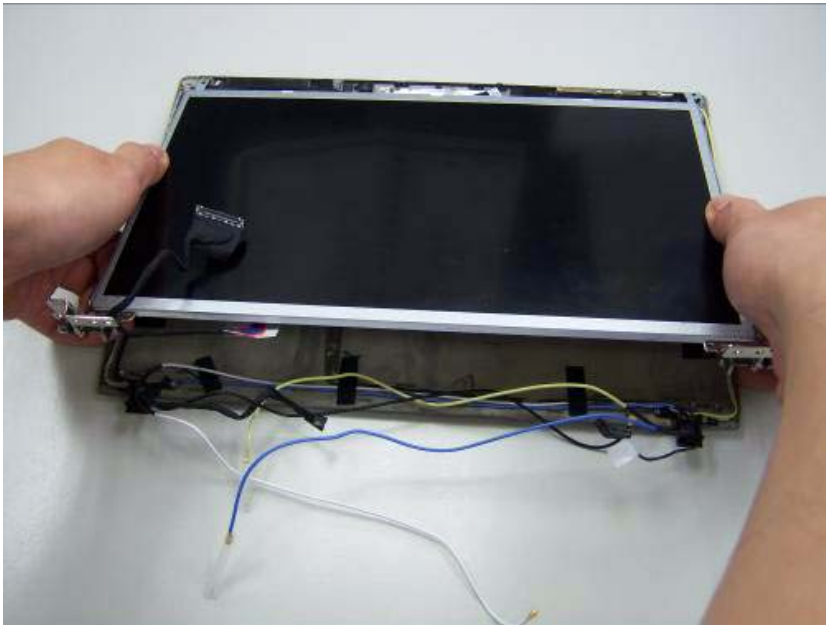

-
4. Fasten four screws on the panel.



5. Place the bezel hinge covers over the hinges. Ensure the cables are correctly exiting the hinges.

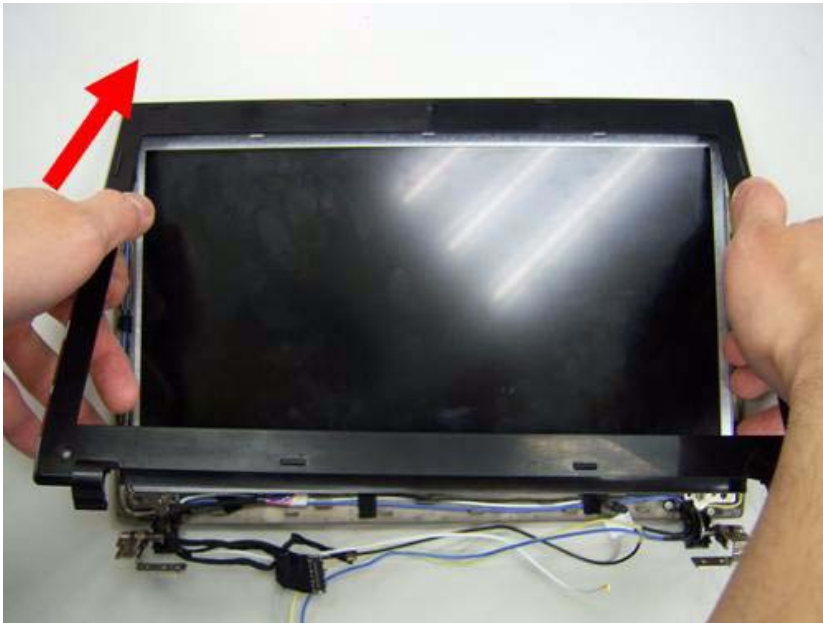

-
6. Press down on the top middle edge of the bezel to engage the locking clips.



7. Press down on the bezel edge working simultaneously around the edges to the bottom.



8. Replace the two screws on the panel.



9. Replace two gaskets on the screws of panel.



Replacing the Mainboard

1. Assemble the touch pad board.

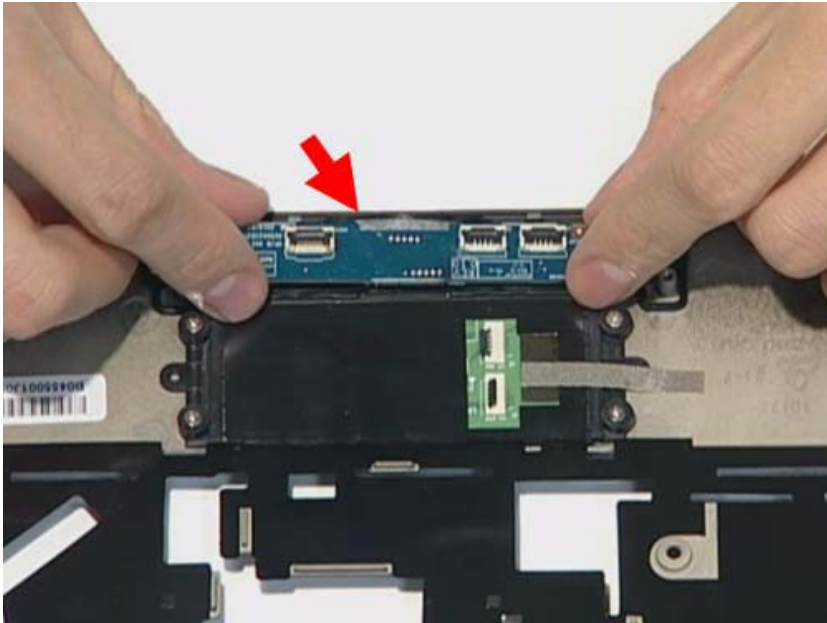

2. Fasten the touch pad.

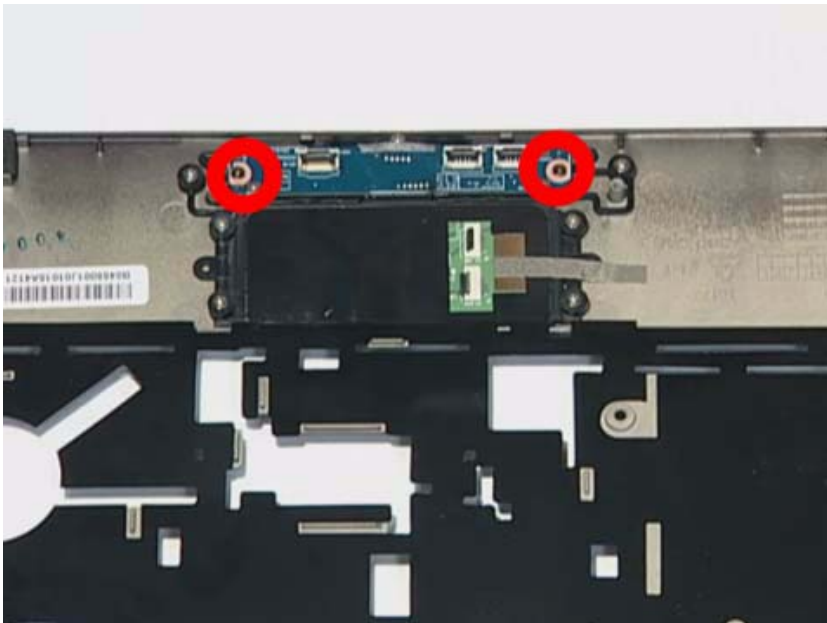

3. Install the three FFCs on the Touch pad board and stable it.

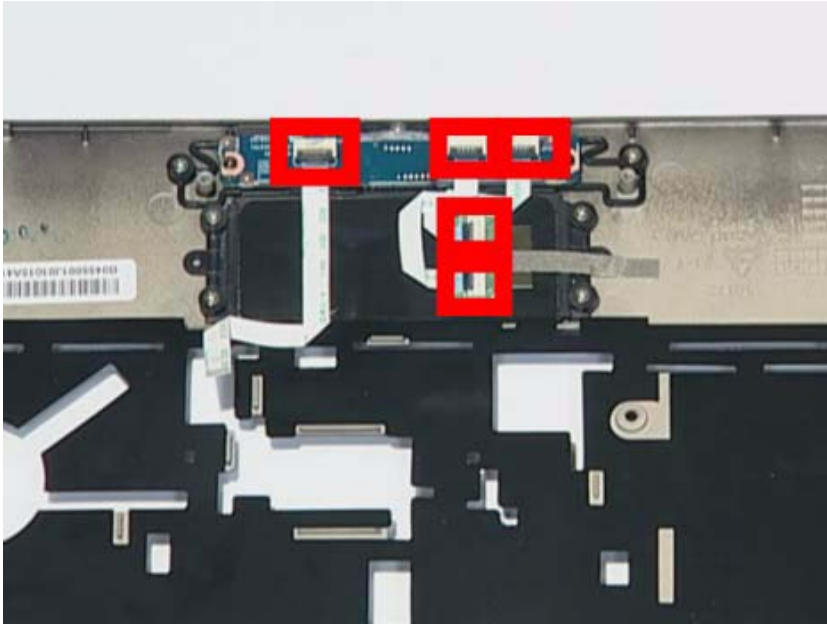

4. Install the power board on the slot.

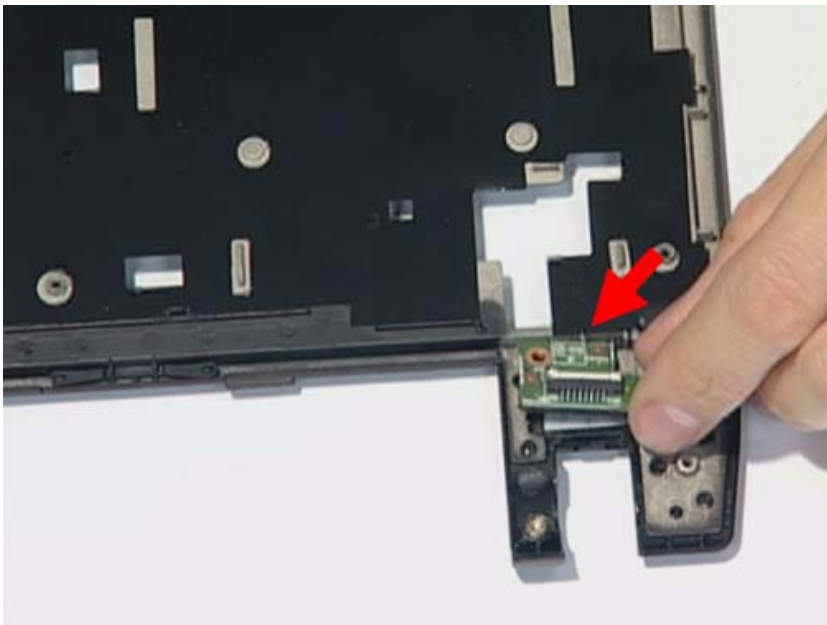

-
5. Fasten the screw of the power board.



6. Install the FFC to the power board.

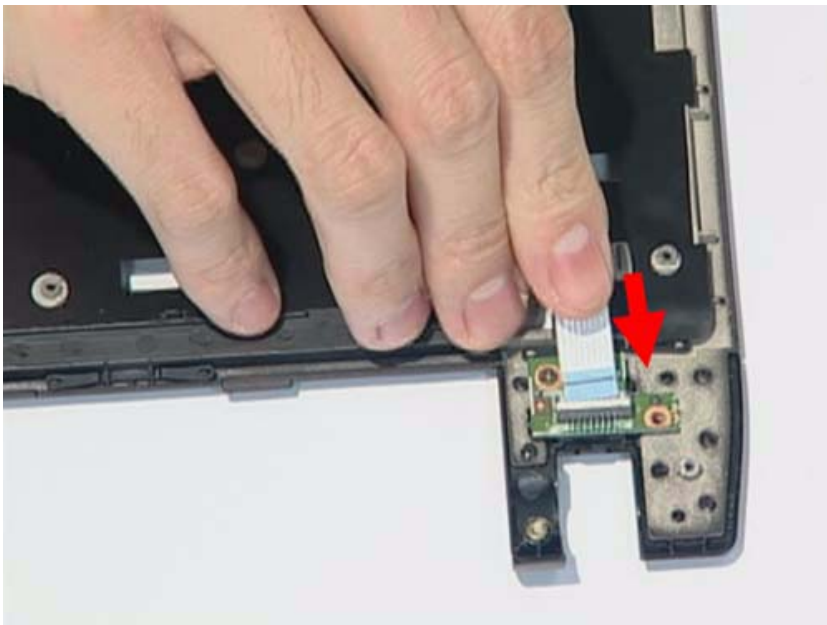

7. Install the LED board.

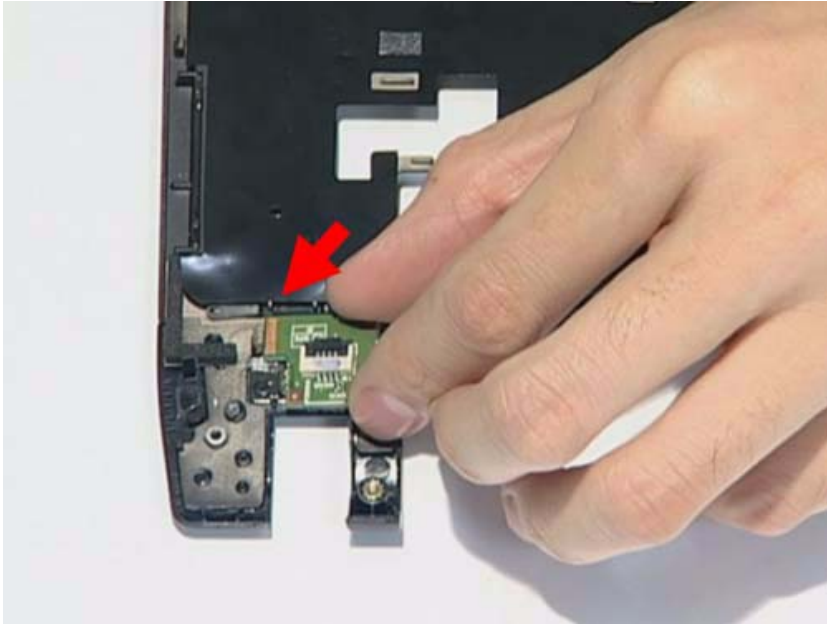

8. Fasten the screw of the LED board.

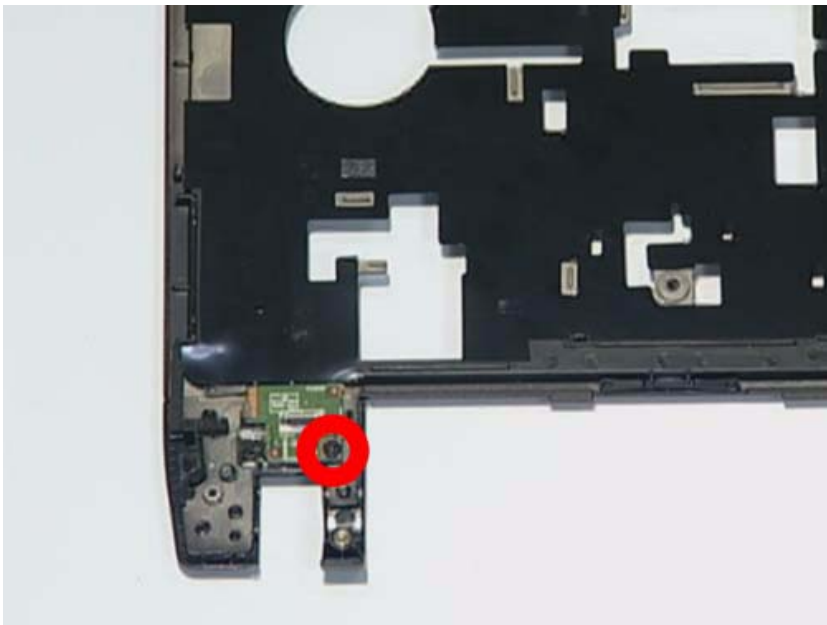

9. Install the FFC on the LED board and stable it..

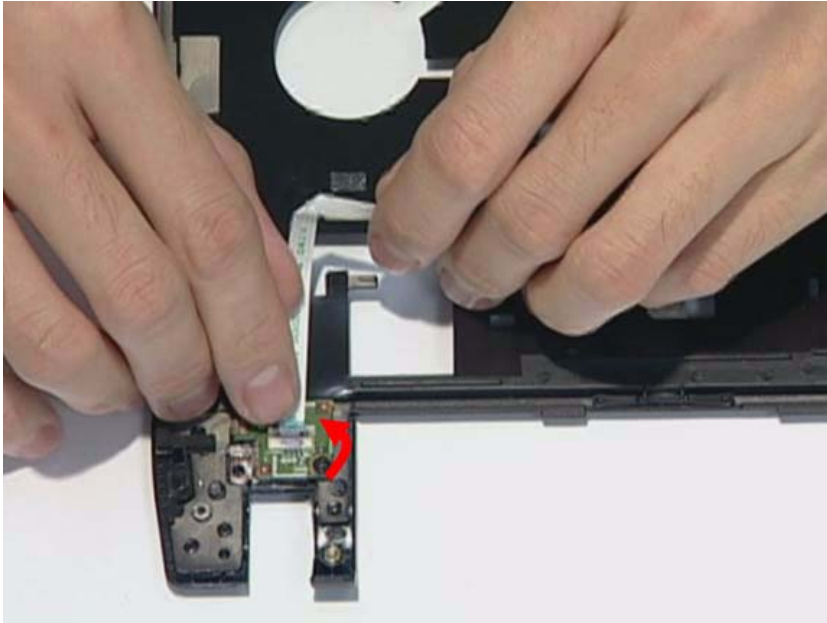

10. Install the thermal module.

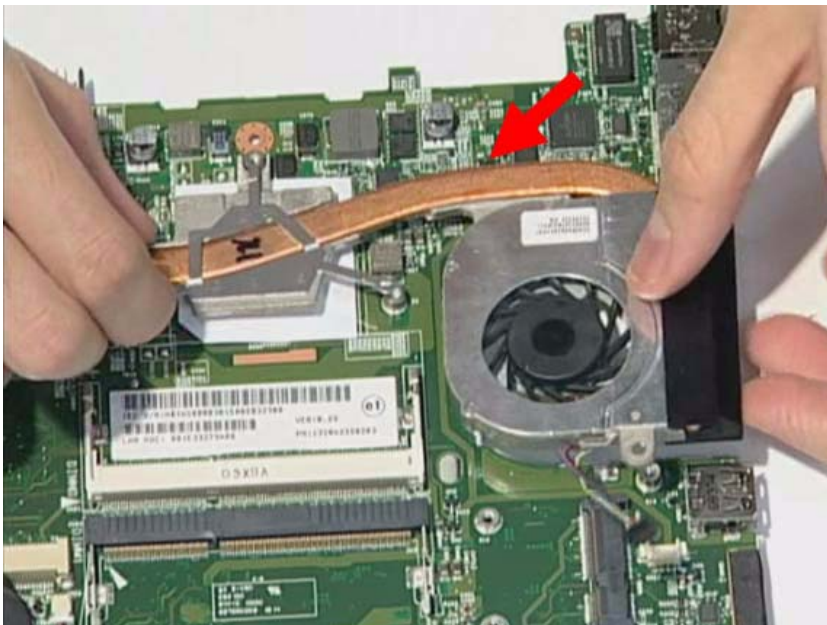

11. Fasten four screws on the thermal module.

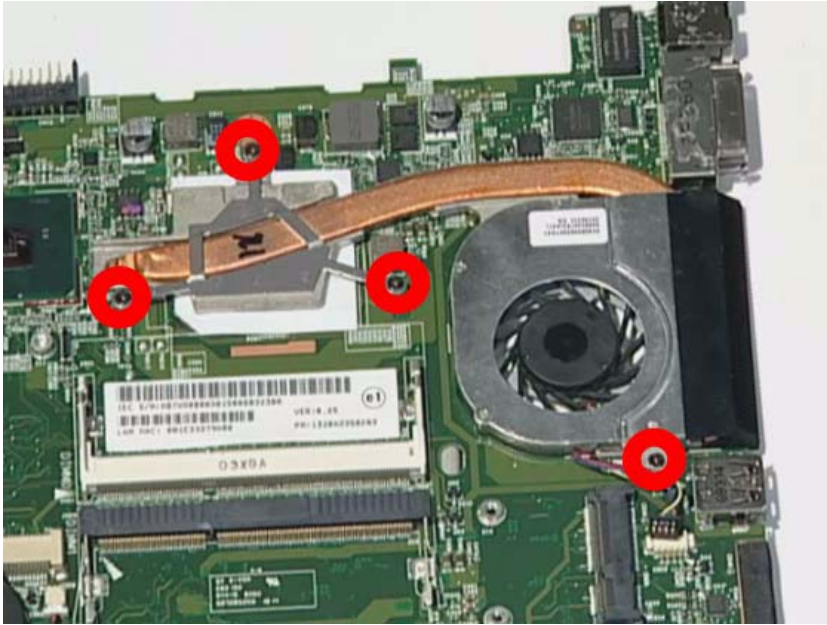

12. Replace the fan connector.

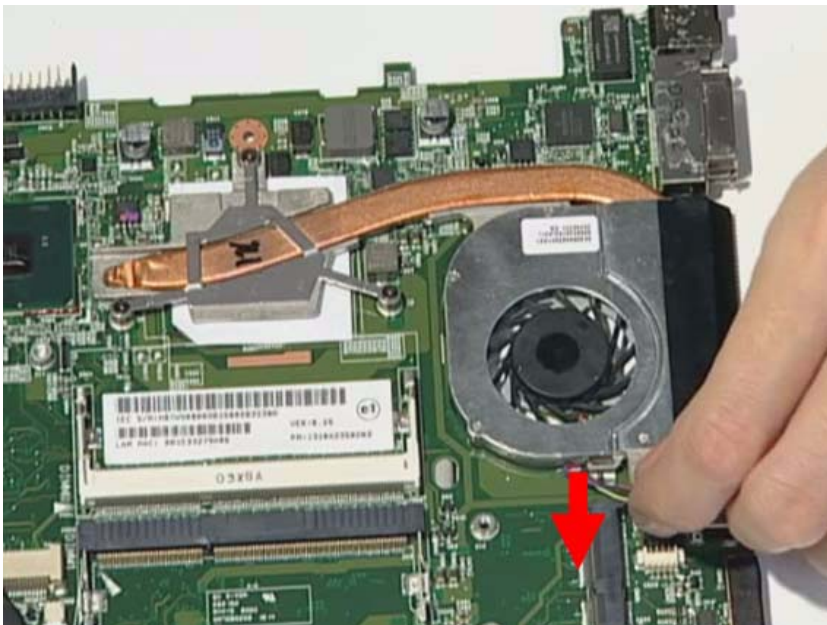

13. Replace the power connection.

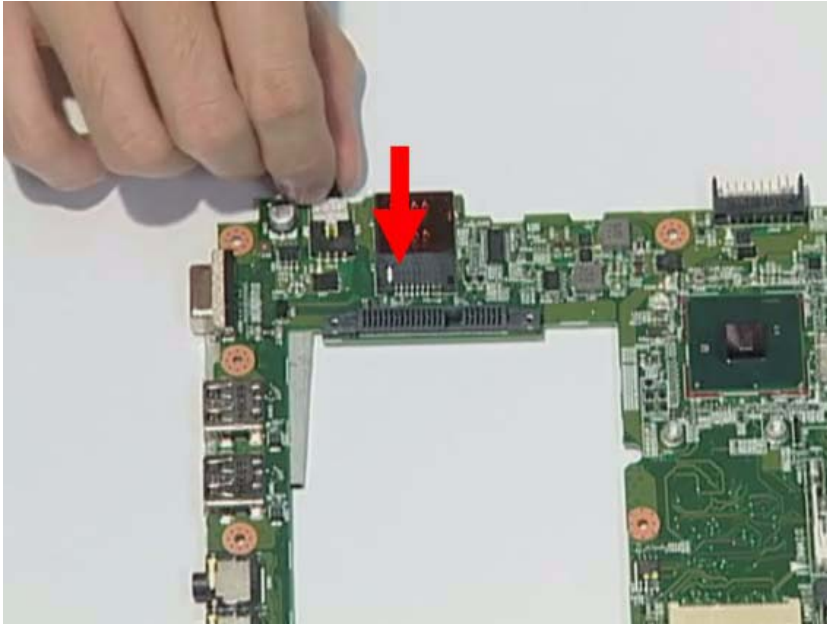

14. Insert the speaker module in the slot.

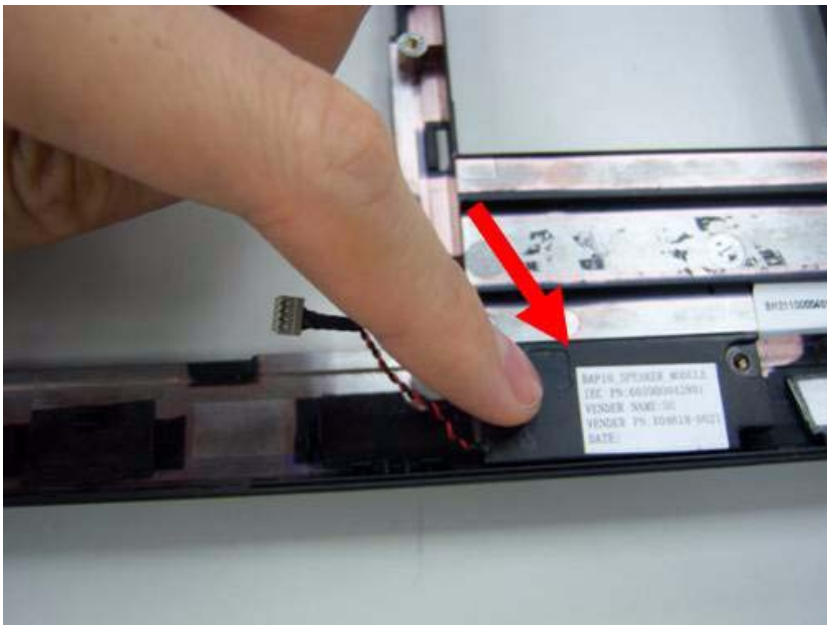

15. Assemble the mainboard to the bottom case.

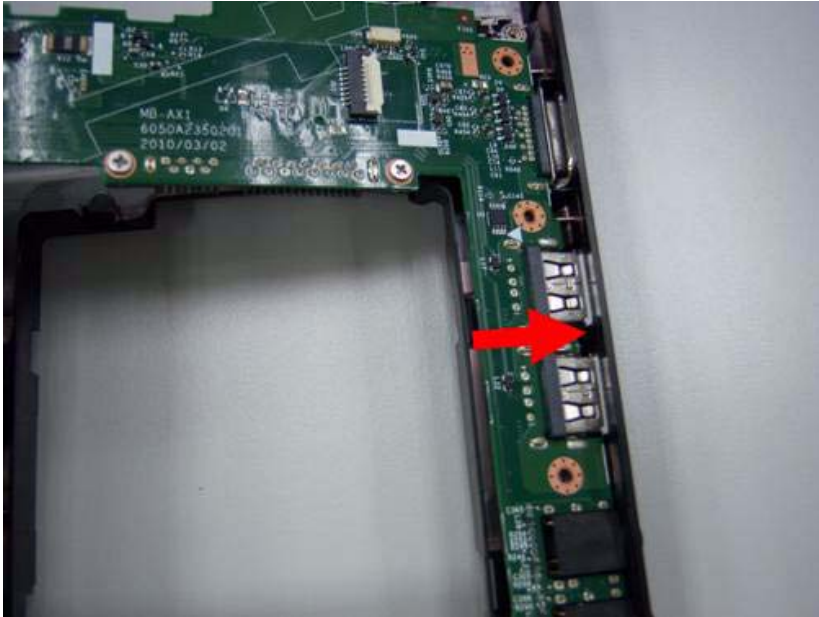

16. Assemble the mainboard to the left side of bottom case.

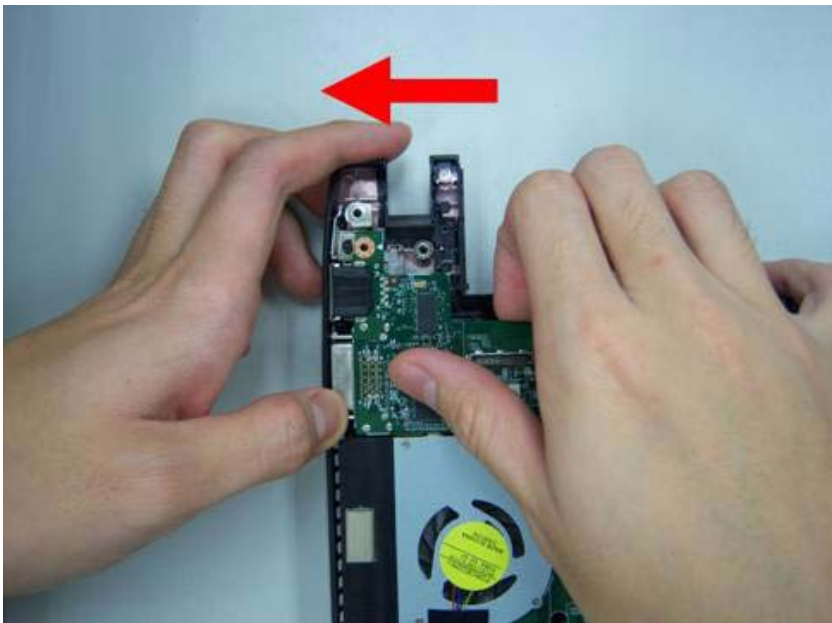

17. Fasten four screws on the mainboard.



18. Insert the power bracket.

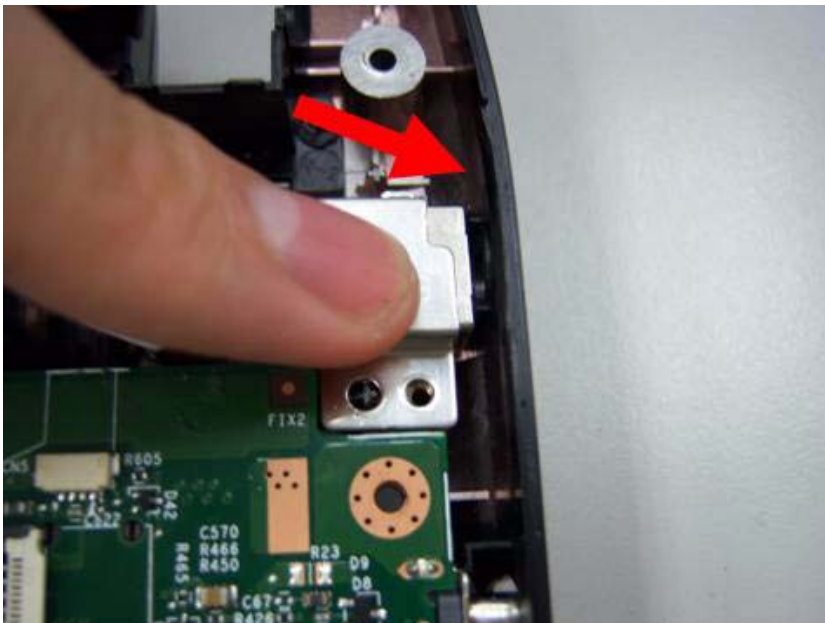

19. Fasten one screw on the power bracket.



Replacing the Panel

1. Assemble the panel to the mainboard.

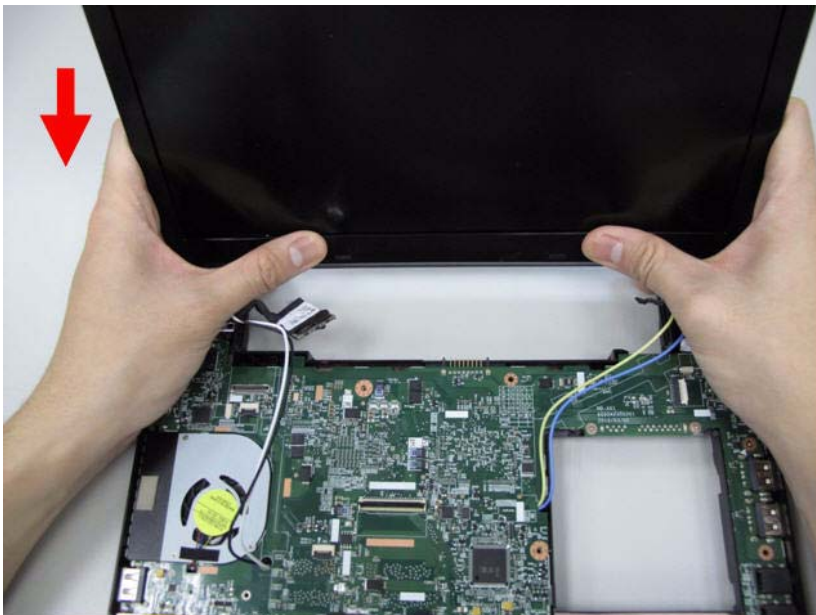

2. Fasten two screws on the left and right hinge.



3. Replace the CCD connector.

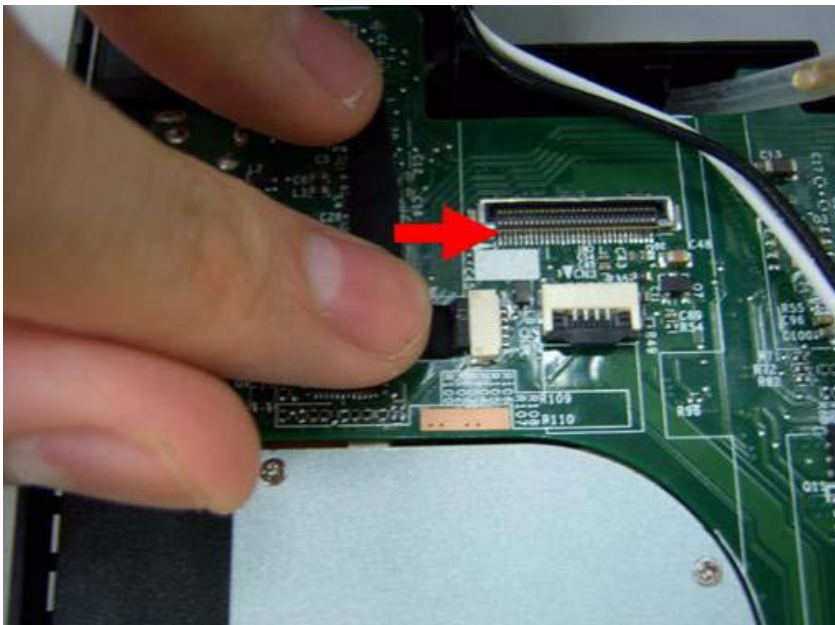

4. Let the antenna cable along the red line and put in the hole beside the thermal module.

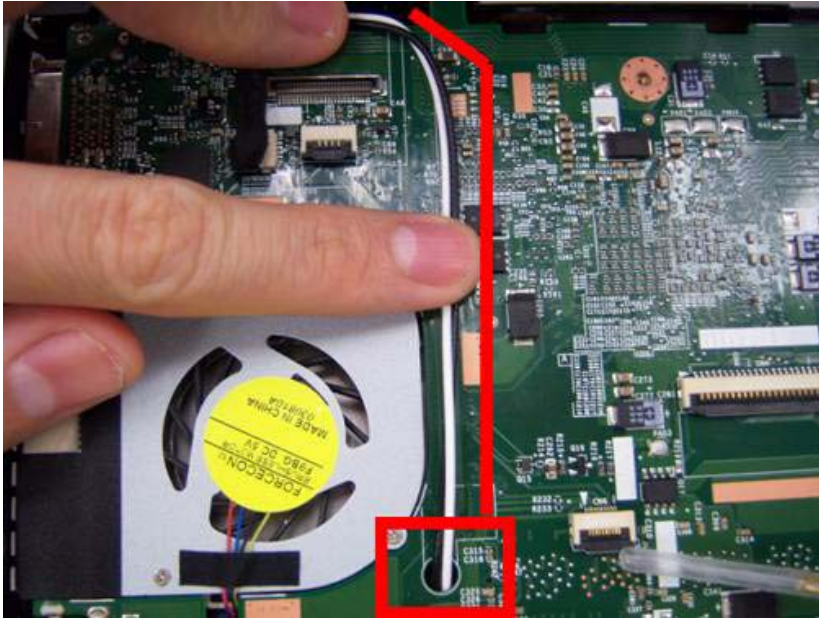

5. Stick the tape on the cable in order to stable it.

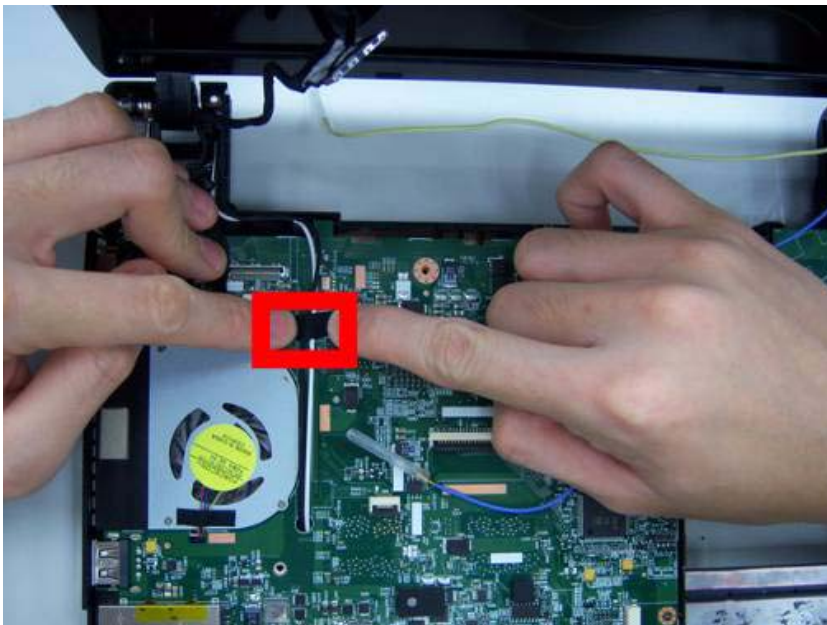

6. Replace the LVDS cable.



7. Replace the MIC cable.

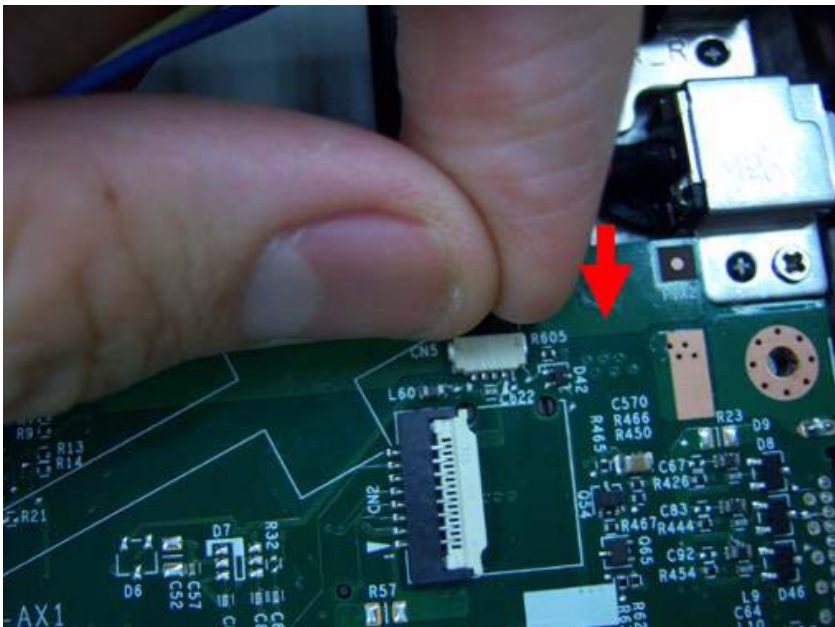

8. Let the 3G cable along the red line.

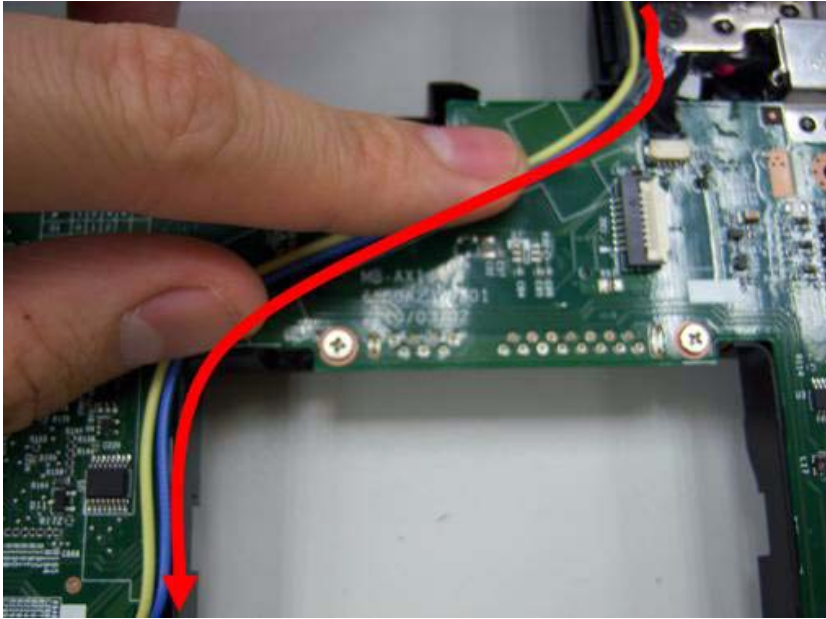

9. Put the 3G cable into the hole in the side of mainboard.

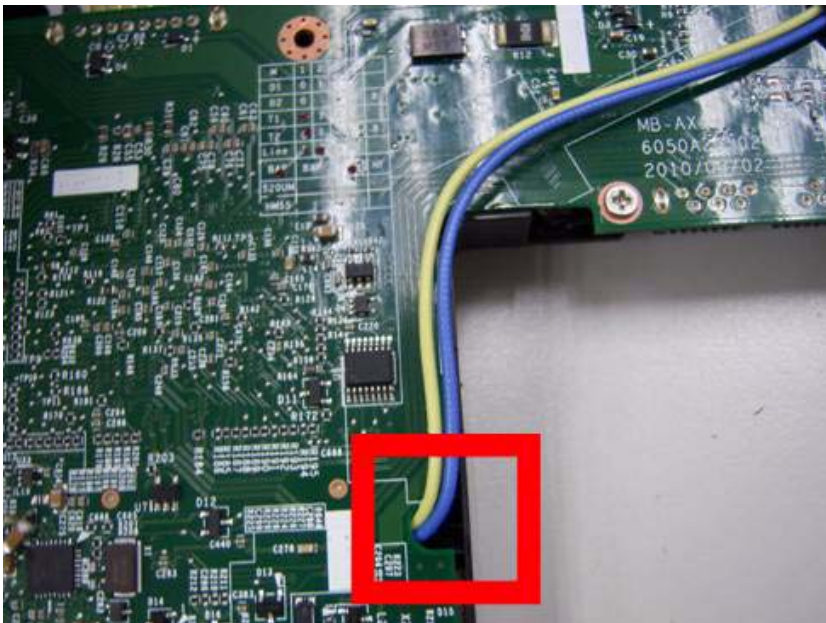

10. Add two tapes on the 3G cable.

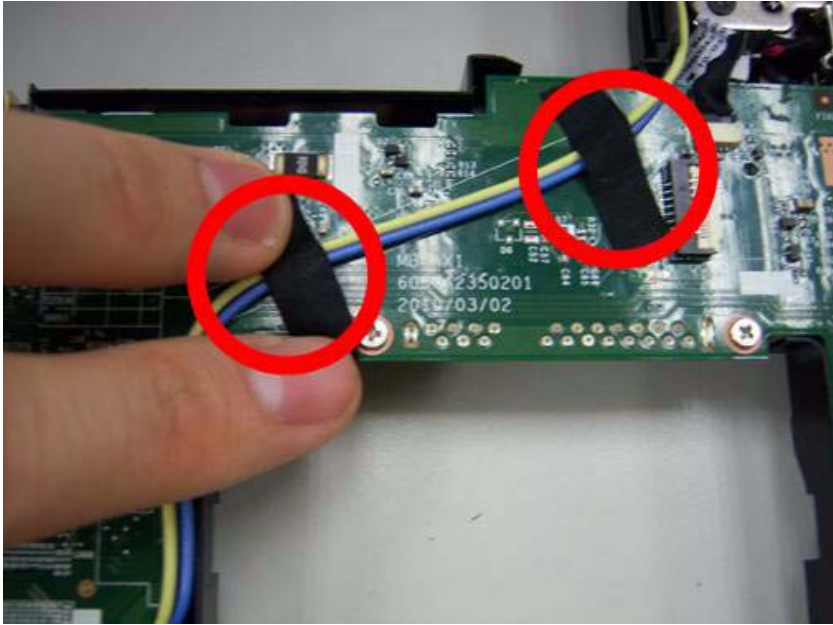

11. Assemble the speaker connector.



12. Replace the connection of audio board.



13. Replace another side connection of Audio board.

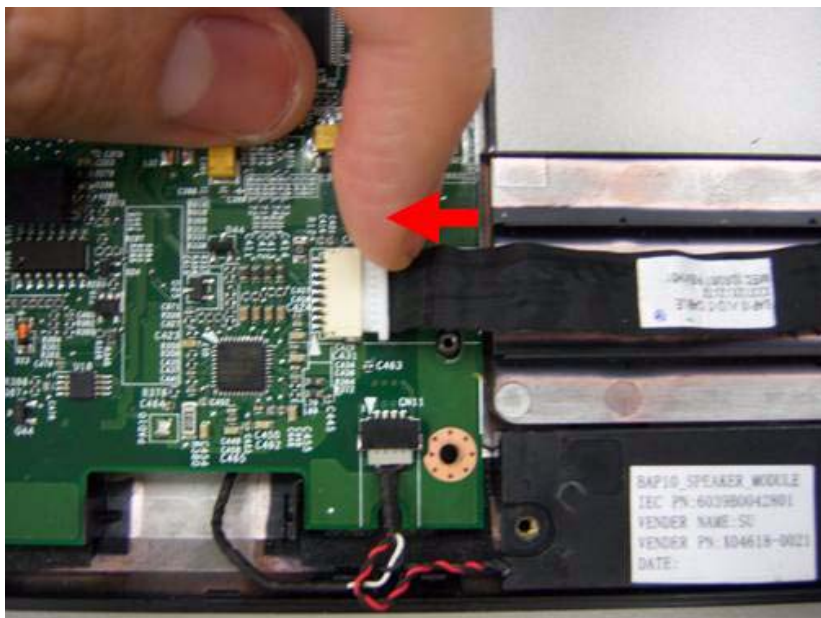

Replacing the Bluetooth Module

IMPORTANT: Bluetooth Module may not represent the actual model. During the removal and replacement of components, ensure all available cable channels and clips are used and that the cables are replaced in the same position.

1. Assemble the Bluetooth device into the main.

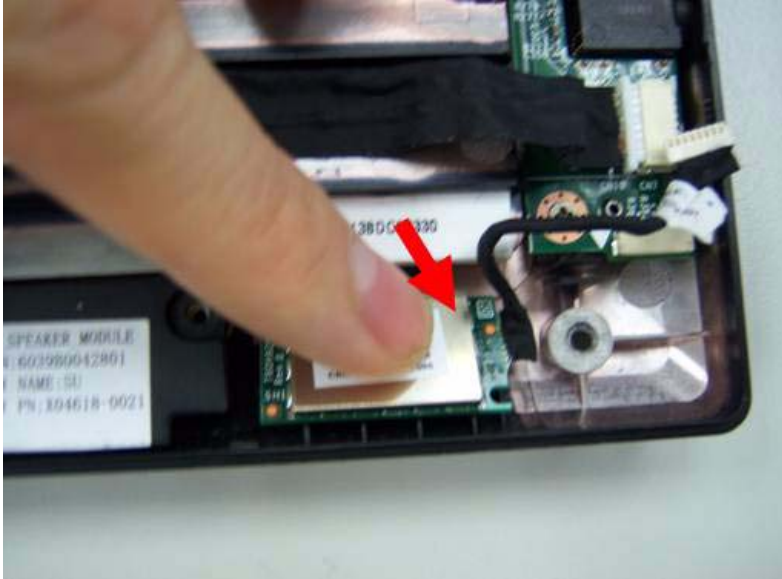

2. Replace the connection of Bluetooth.



Replacing the Upper Case

1. Assemble the upper case.

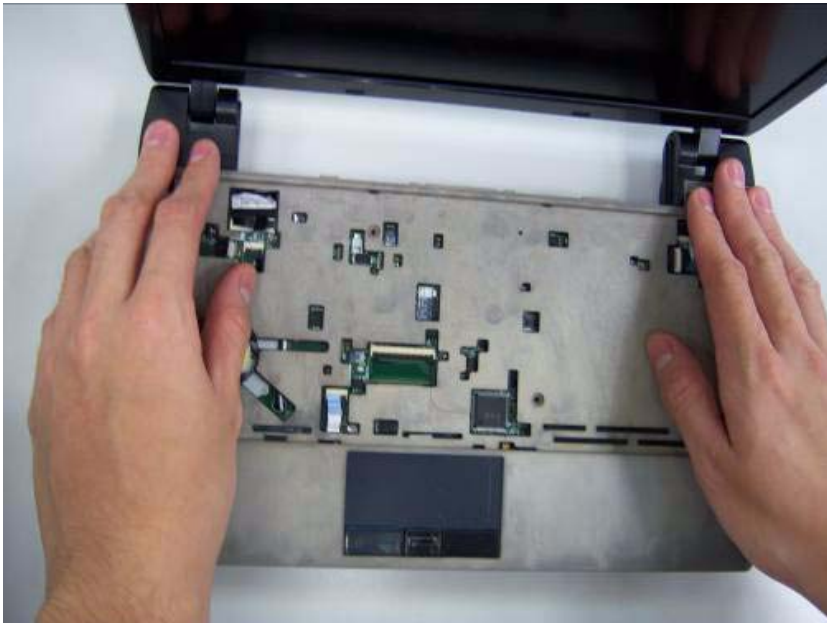
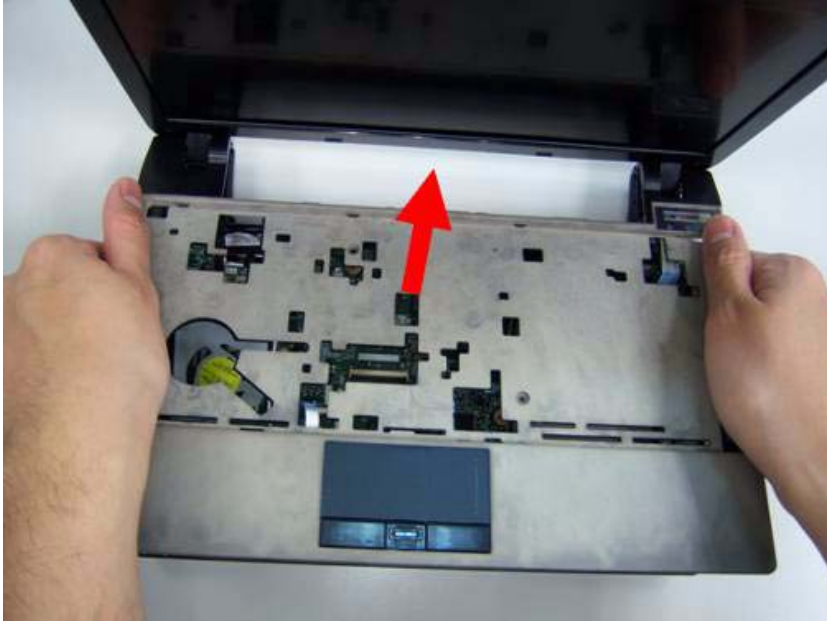



2. Fasten two screws on the upper case.

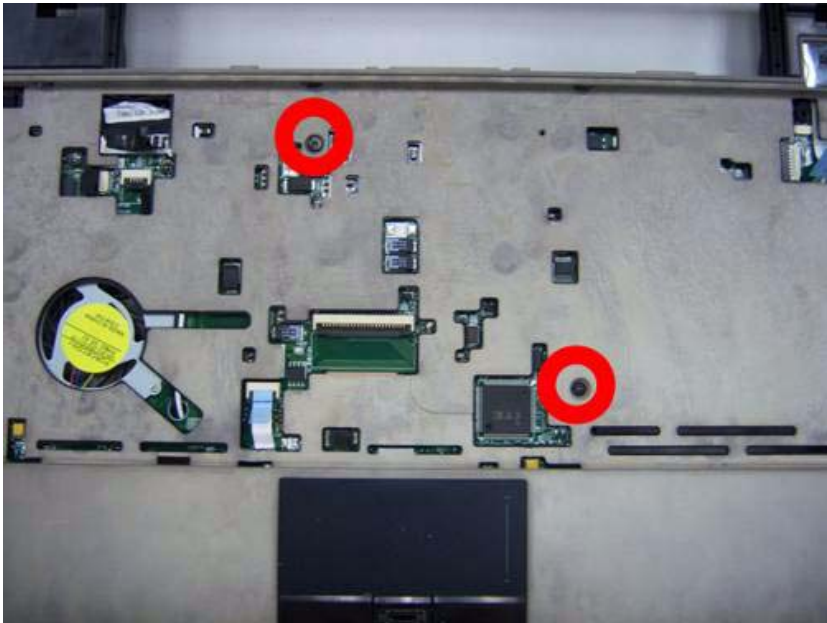

3. Turn the computer over and fasten nine screws on the button cover.



4. Release the lock of speaker connector.

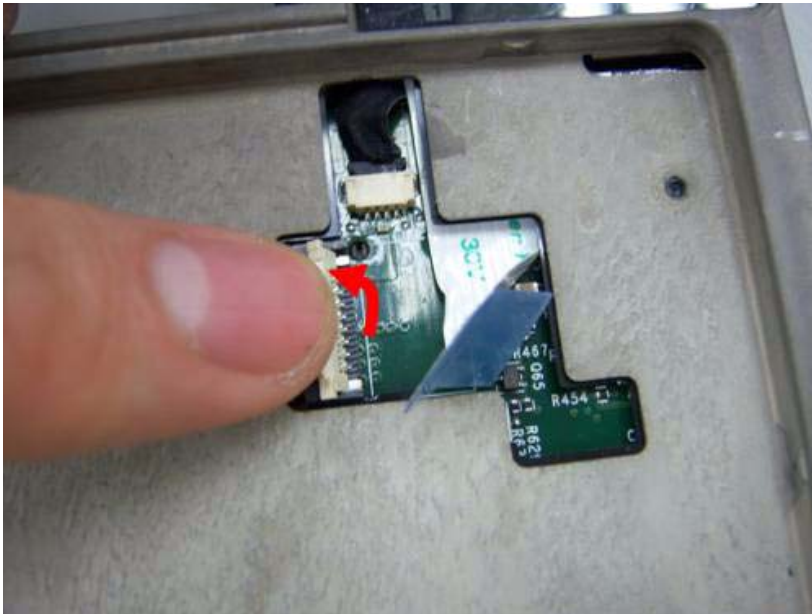

-
5. Replace the speaker connection.

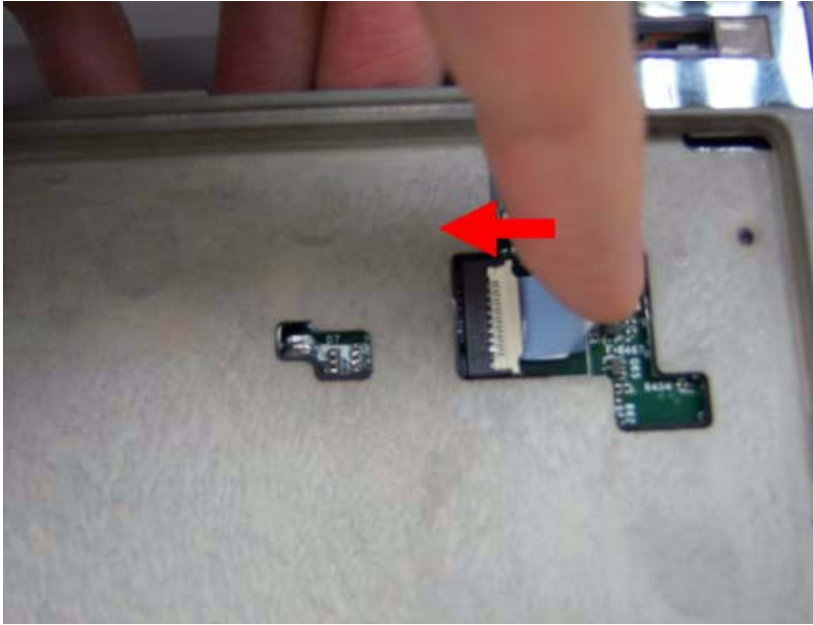

6. Release the lock of the touch pad connection.



7. Connect the touch pad connection..

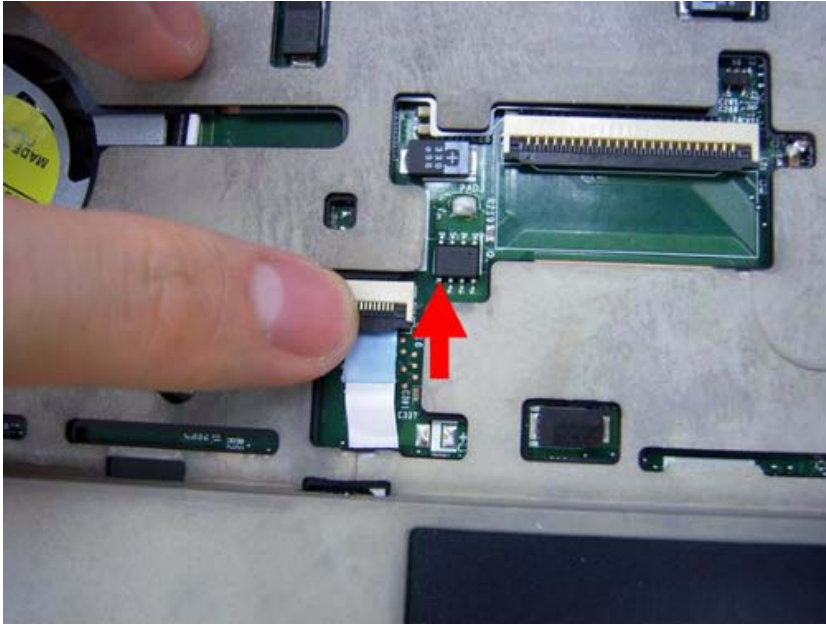

Replacing the keyboard

1. Release the lock of keyboard connection.

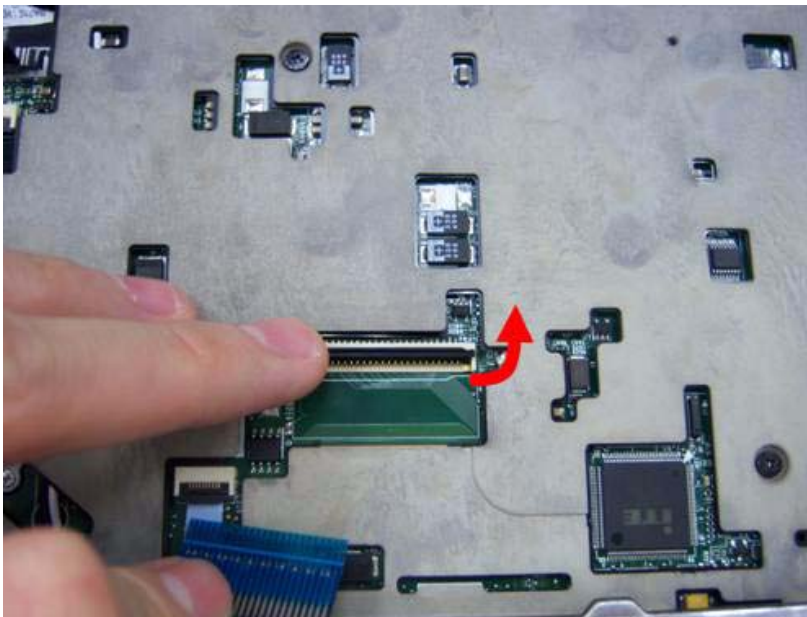

2. Connect the lock of keyboard connection.

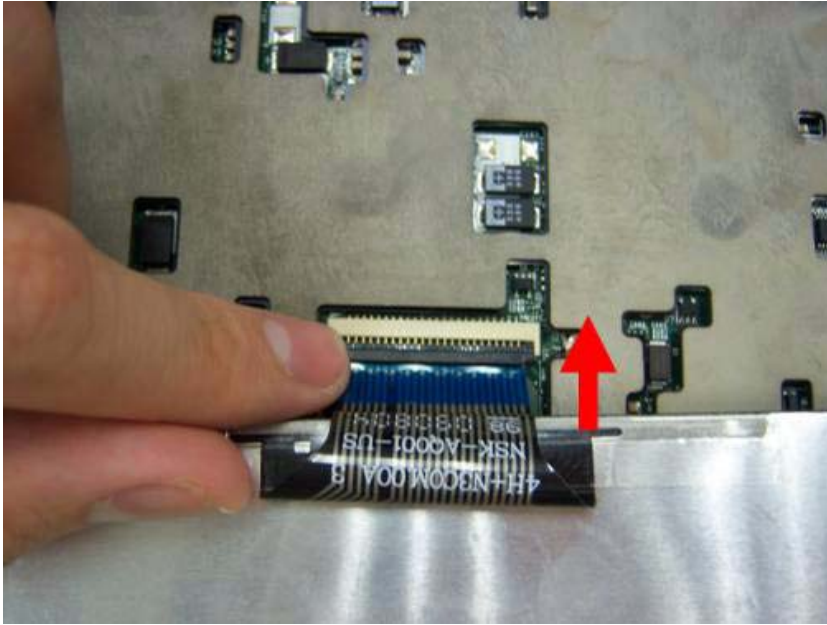

3. Turn the keyboard over and insert the bottom edge in first then push to down ensure the five latches across the top are fully secured.



Replace the Wireless LAN Module

1. Insert the wireless LAN module into the connector.



2. Fasten two screws on the wireless LAN module and connect black and white antenna line to the wireless LAN module.

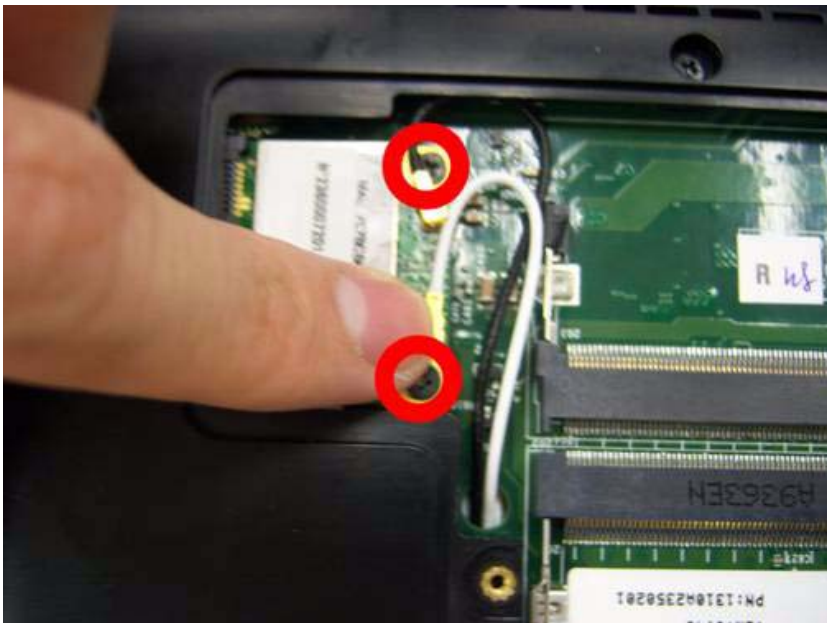

Replace the DIMM module

1. Slide the DIMM module into the connector.

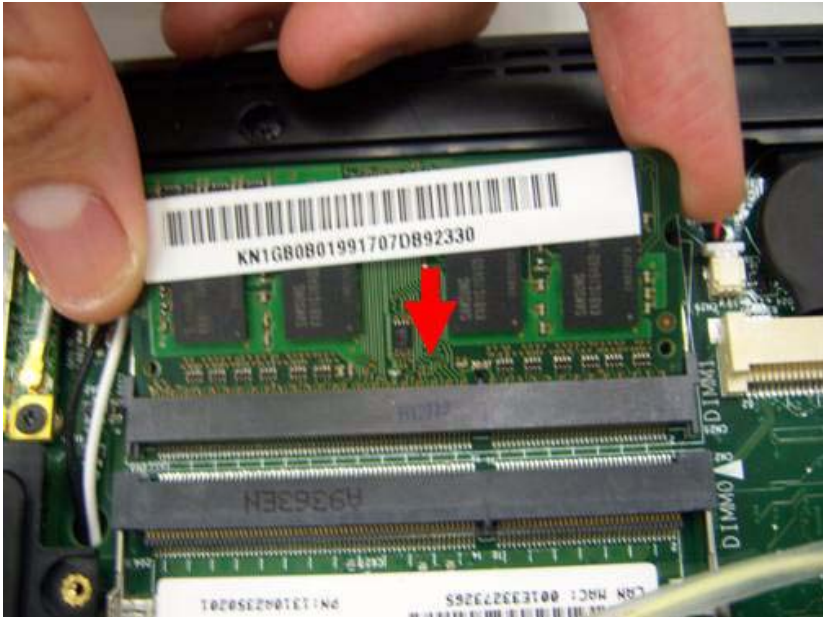

2. Press down until the locking springs click into place.

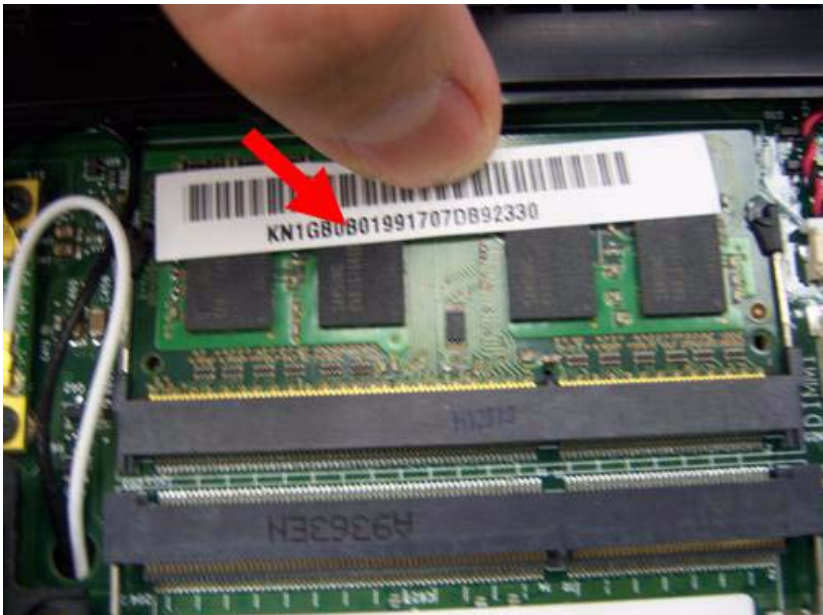

3. Insert another DIMM with the same method.



4. Insert the RAM door.



-
5. Press down the RAM door.



6. Fasten two screws on the RAM door.

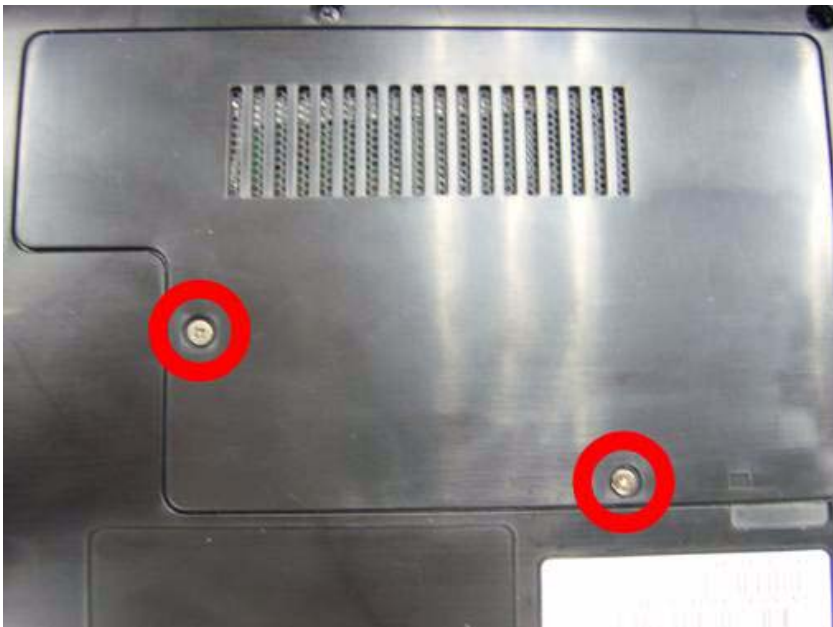

Replacing HDD module

1. Insert HDD connector.



2. Insert the HDD into the HDD slot.

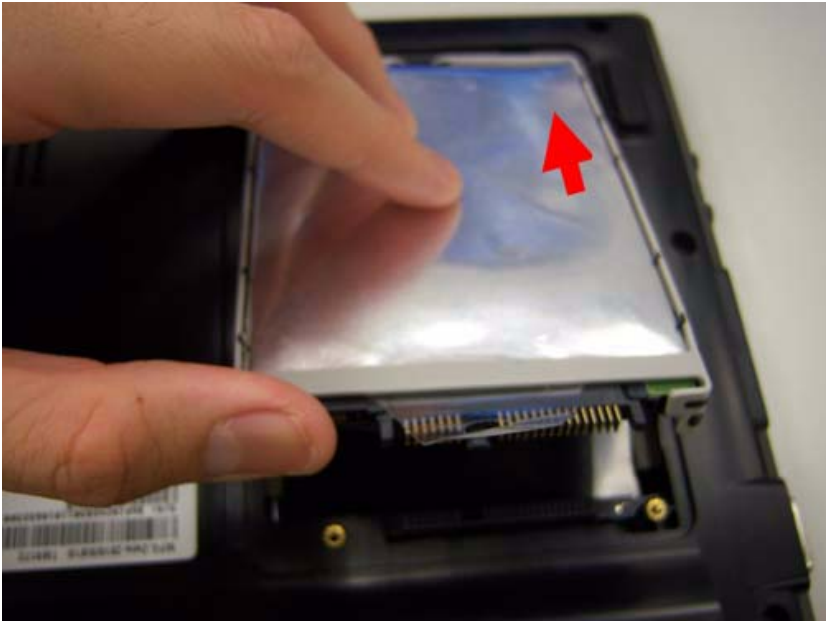

3. Press down the HDD and make sure it stable.

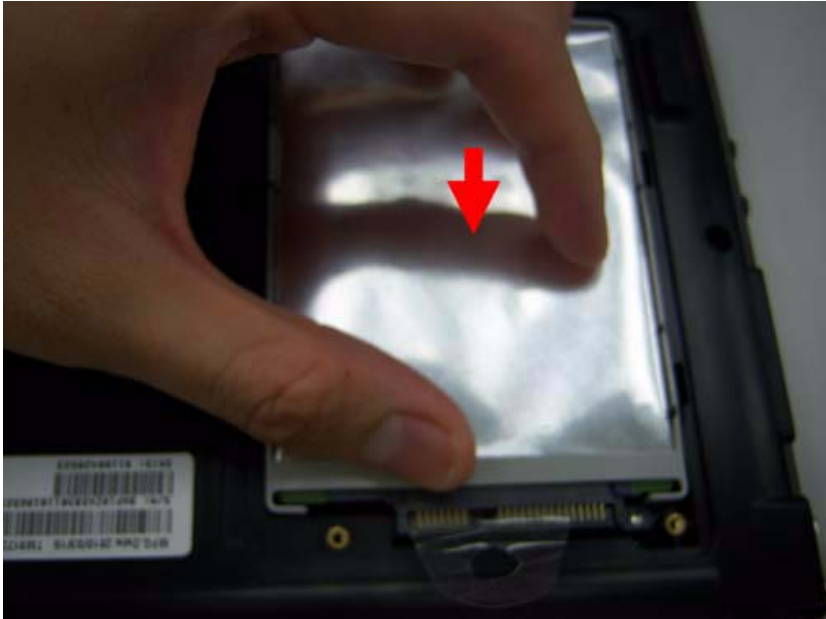

4. Replace the HDD cover and fasten two screws on it.



Replacing the battery

- 1. Insert the battery carefully.



- 2. Lock the battery lock.



Troubleshooting

Use the following procedure as a guide for computer problems.

NOTE: The diagnostic tests are intended to test only Acer products. Non-Acer products, prototype cards, or modified options can give false errors and invalid system responses.

1. Obtain the failing symptoms in as much detail as possible.
2. Verify the symptoms by attempting to re-create the failure by running the diagnostic test or by repeating the same operation.
3. Use the following table with the verified symptom to determine which page to go to.
4. If any problem occurs, you can perform visual inspection before you follow this chapter's instructions. You can check the following:
 - power cords are properly connected and secured;
 - there are no obvious shorts or opens;
 - there are no obviously burned or heated components;
 - all components appear normal.
5. Use the following table with the verified symptom to determine which page to go to.

Symptoms (Verified)	Go To
Power failure. (The power indicator does not go on or stay on.)	"Power System Check" on page 167.
POST does not complete. No beep or error codes are indicated.	"Power-On Self-Test (POST) Error Message" on page 169. "Undetermined Problems" on page 182.
POST detects an error and displayed messages on screen.	"Error Message List" on page 170.
Other symptoms (i.e. LCD display problems or others).	"Power-On Self-Test (POST) Error Message" on page 169.
Symptoms cannot be re-created (intermittent problems).	Use the customer-reported symptoms and go to "Power-On Self-Test (POST) Error Message" on page 169. "Intermittent Problems" on page 181. "Undetermined Problems" on page 182.

System Check Procedures

External Diskette Drive Check

Do the following to isolate the problem to a controller, driver, or diskette. A write-enabled, diagnostic diskette is required.

NOTE: Make sure that the diskette does not have more than one label attached to it. Multiple labels can cause damage to the drive or cause the drive to fail.

Do the following to select the test device.

1. Boot from the diagnostics diskette and start the diagnostics program.
2. See if FDD Test is passed as the program runs to FDD Test.
3. Follow the instructions in the message window.

If an error occurs with the internal diskette drive, reconnect the diskette connector on the system board.

If the error still remains:

1. Reconnect the external diskette drive/DVD-ROM module.
2. Replace the external diskette drive/CD-ROM module.
3. Replace the main board.

External CD-ROM Drive Check

Do the following to isolate the problem to a controller, drive, or CD-ROM. Make sure that the CD-ROM does not have any label attached to it. The label can cause damage to the drive or can cause the drive to fail.

Do the following to select the test device:

1. Boot from the diagnostics diskette and start the diagnostics program.
2. See if CD-ROM Test is passed when the program runs to CD-ROM Test.
3. Follow the instructions in the message window.

If an error occurs, reconnect the connector on the System board. If the error still remains:

1. Reconnect the external diskette drive/CD-ROM module.
2. Replace the external diskette drive/CD-ROM module.
3. Replace the main board.

Keyboard or Auxiliary Input Device Check

Remove the external keyboard if the internal keyboard is to be tested.

If the internal keyboard does not work or an unexpected character appears, make sure that the flexible cable extending from the keyboard is correctly seated in the connector on the system board.

If the keyboard cable connection is correct, run the Keyboard Test.

If the tests detect a keyboard problem, do the following one at a time to correct the problem. Do not replace a non-defective FRU:

1. Reconnect the keyboard cables.
2. Replace the keyboard.
3. Replace the main board.

The following auxiliary input devices are supported by this computer:

- Numeric keypad
- External keyboard

If any of these devices do not work, reconnect the cable connector and repeat the failing operation.

Memory check

Memory errors might stop system operations, show error messages on the screen, or hang the system.

1. Boot from the diagnostics diskette and start the doagmpstotics program (please refer to main board.)
2. Go to the diagnostic memory in the test items.
3. Press F2 in the test items.
4. Follow the instructions in the message window.

NOTE: Make sure that the DIMM is fully installed into the connector. A loose connection can cause an error.

Power System Check

To verify the symptom of the problem, power on the computer using each of the following power sources:

1. Remove the battery pack.
2. Connect the power adapter and check that power is supplied.
3. Disconnect the power adapter and install the charged battery pack; then check that power is supplied by the battery pack.

If you suspect a power problem, see the appropriate power supply check in the following list:

- “Check the Power Adapter” on page 167
- “Check the Battery Pack” on page 167

Check the Power Adapter

Unplug the power adapter cable from the computer and measure the output voltage at the plug of the power adapter cable. See the following figure:

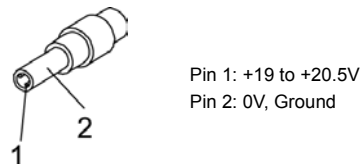

1. If the voltage is not correct, replace the power adapter.
2. If the voltage is within the range, do the following:
 - Replace the System board.
 - If the problem is not corrected, see “Undetermined Problems” on page 182.
 - If the voltage is not correct, go to the next step.

NOTE: An audible noise from the power adapter does not always indicate a defect.

3. If the power-on indicator does not light up, check the power cord of the power adapter for correct continuity and installation.
4. If the operational charge does not work, see “Check the Battery Pack” on page 167.

Check the Battery Pack

To check the battery pack, do the following:

From Software:

1. Check out the Power Management in control Panel.
2. In Power Meter, confirm that if the parameters shown in the screen for Current Power Source and Total Battery Power Remaining are correct.
3. Repeat the steps 1 and 2, for both battery and adapter.
4. This helps you identify first the problem is on recharging or discharging.

From Hardware:

1. Power off the computer.
2. Remove the battery pack and measure the voltage between battery terminals 1(+) and 6(ground). See the following figure.

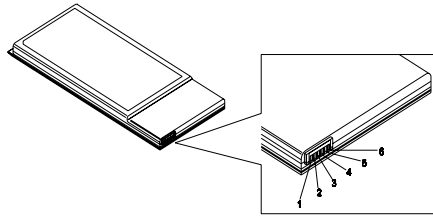

3. If the voltage is still less than 7.5 Vdc after recharging, replace the battery.

To check the battery charge operation, use a discharged battery pack or a battery pack that has less than 50% of the total power remaining when installed in the computer.

If the battery status indicator does not light up, remove the battery pack and let it return to room temperature. Re-install the battery pack.

If the charge indicator still does not light up, replace the battery pack. If the charge indicator still does not light up, replace the DC/DC charger board.

Touchpad Check

If the touchpad doesn't work, do the following actions one at a time to correct the problem. Do not replace a non-defective FRU:

1. Reconnect the touchpad cables.
2. Replace the touchpad.
3. Replace the system board.

After you use the touchpad, the pointer drifts on the screen for a short time. This self-acting pointer movement can occur when a slight, steady pressure is applied to the touchpad pointer. This symptom is not a hardware problem. No service actions are necessary if the pointer movement stops in a short period of time.

Power-On Self-Test (POST) Error Message

The POST error message index lists the error message and their possible causes. The most likely cause is listed first.

NOTE: Perform the FRU replacement or actions in the sequence shown in FRU/Action column, if the FRU replacement does not solve the problem, put the original part back in the computer. Do not replace a non-defective FRU.

This index can also help you determine the next possible FRU to be replaced when servicing a computer.

If the symptom is not listed, see “Undetermined Problems” on page 182.

The following lists the error messages that the BIOS displays on the screen and the error symptoms classified by function.

NOTE: Most of the error messages occur during POST. Some of them display information about a hardware device, e.g., the amount of memory installed. Others may indicate a problem with a device, such as the way it has been configured.

NOTE: If the system fails after you make changes in the BIOS Setup Utility menus, reset the computer, enter Setup and install Setup defaults or correct the error.

Index of Error Messages

Error Code List

Error Codes	Error Messages
006	Equipment Configuration Error Causes: 1. CPU BIOS Update Code Mismatch. 2. IDE Primary Channel Master Drive Error. (The causes will be shown before "Equipment Configuration Error")
010	Memory Error at xxxx:xxxx:xxxxh (R:xxxxh, W:xxxxh) .
070	Real Time Clock Error.
071	CMOS Battery Bad.
072	CMOS Checksum Error.
110	System disabled. Incorrect password is specified.
<No error code>	Battery critical LOW. In this situation BIOS will issue 4 short beeps then shut down system, no message will show.
<No error code>	Thermal critical High. In this situation BIOS will shut down system, not show message.

Error Message List

Error Messages	FRU/Action in Sequence
Failure Fixed Disk	Reconnect hard disk drive connector. "Load Default Settings" in BIOS Setup Utility. Hard disk drive System board
Stuck Key	see "Keyboard or Auxiliary Input Device Check" on page 166.
Keyboard error	see "Keyboard or Auxiliary Input Device Check" on page 166.
Keyboard Controller Failed	see "Keyboard or Auxiliary Input Device Check" on page 166.
Keyboard locked - Unlock key switch	Unlock external keyboard.
Monitor type does not match CMOS - Run Setup	Run "Load Default Settings" in BIOS Setup Utility.
Shadow RAM Failed at offset: nnnn	BIOS ROM System board
System RAM Failed at offset: nnnn	DIMM System board
Extended RAM Failed at offset: nnnn	DIMM System board

Error Messages	FRU/Action in Sequence
System battery is dead - Replace and run Setup	Replace RTC battery and Run BIOS Setup Utility to reconfigure system time, then reboot system.
System CMOS checksum bad - Default configuration used	RTC battery Run BIOS Setup Utility to reconfigure system time, then reboot system.
System timer error	RTC battery Run BIOS Setup Utility to reconfigure system time, then reboot system. System board
Real time clock error	RTC battery Run BIOS Setup Utility to reconfigure system time, then reboot system. System board
Previous boot incomplete - Default configuration used	Run "Load Default Settings" in BIOS Setup Utility. RTC battery System board
Memory size found by POST differed from CMOS	Run "Load Default Settings" in BIOS Setup Utility. DIMM System board
Diskette drive A error	Check the drive is defined with the proper diskette type in BIOS Setup Utility. See "External Diskette Drive Check" on page 166.
Incorrect Drive A type - run SETUP	Check the drive is defined with the proper diskette type in BIOS Setup Utility.
System cache error - Cache disabled	System board
CPU ID:	System board
DMA Test Failed	DIMM System board
Software NMI Failed	DIMM System board
Fail-Safe Timer NMI Failed	DIMM System board
Device Address Conflict	Run "Load Default Settings" in BIOS Setup Utility. RTC battery System board
Allocation Error for device	Run "Load Default Settings" in BIOS Setup Utility. RTC battery System board
Failing Bits: nnnn	DIMM BIOS ROM System board
Fixed Disk n	None

Error Messages	FRU/Action in Sequence
Invalid System Configuration Data	BIOS ROM System board
I/O device IRQ conflict	Run "Load Default Settings" in BIOS Setup Utility. RTC battery System board
Operating system not found	Enter Setup and see if fixed disk and drive A are properly identified. Diskette drive Hard disk drive System board

Error Message List

No beep Error Messages	FRU/Action in Sequence
No beep, power-on indicator turns off and LCD is blank.	Power source (battery pack and power adapter). See "Power System Check" on page 167. Ensure every connector is connected tightly and correctly. Reconnect the DIMM. LED board System board
No beep, power-on indicator turns on and LCD is blank.	Power source (battery pack and power adapter). See "Power System Check" on page 167. Reconnect the LCD connector. Hard disk drive LCD inverter ID LCD cable LCD Inverter LCD System board
No beep, power-on indicator turns on and LCD is blank. But you can see POST on an external CRT.	Reconnect the LCD connectors. LCD inverter ID LCD cable LCD inverter LCD System board
No beep, power-on indicator turns on and a blinking cursor shown on LCD during POST.	Ensure every connector is connected tightly and correctly. System board
No beep during POST but system runs correctly.	Speaker System board

InsydeH2O BIOS Beep Codes

Code	Beeps	POST Routine Description
02h		Verify Real Mode
03h		Disable Non-Maskable Interrupt (NMI)
04h		Get CPU type
06h		Initialize system hardware
08h		Initialize chipset with initial POST values
09h		Set IN POST flag
0Ah		Initialize CPU registers
0Bh		Enable CPU cache
0Ch		Initialize caches to initial POST values
0Eh		Initialize I/O component
0Fh		Initialize the local bus IDE
10h		Initialize Power Management
11h		Load alternate registers with initial POST values
12h		Restore CPU control word during warm boot
13h		Initialize PCI Bus Mastering devices
14h		Initialize keyboard controller
16h	1-2-2-3	BIOS ROM checksum
17h		Initialize cache before memory autosize
18h		8254 timer initialization
1Ah		8237 DMA controller initialization
1Ch		Reset Programmable Interrupt Controller
20h	1-3-1-1	Test DRAM refresh
22h	1-3-1-3	Test 8742 Keyboard Controller
24h		Set ES segment register to 4 GB
26h		Enable A20 line
28h		Autosize DRAM
29h		Initialize POST Memory Manager
2Ah		Clear 215 KB base RAM
2Ch	1-3-4-1	RAM failure on address line xxxx
2Eh	1-3-4-3	RAM failure on data bits xxxx of low byte of memory bus
2Fh		Enable cache before system BIOS shadow
30h	1-4-1-1	RAM failure on data bits xxxx of high byte of memory bus
32h		Test CPU bus-clock frequency
33h		Initialize InsydeH2O Dispatch Manager
36h		Warm start shut down
38h		Shadow system BIOS ROM
3Ah		Autosize cache
3Ch		Advanced configuration of chipset registers
3Dh		Load alternate registers with CMOS values
42h		Initialize interrupt vectors

Code	Beeps	POST Routine Description
45h		POST device initialization
46h	2-1-2-3	Check ROM copyright notice
48h		Check video configuration against CMOS
49h		Initialize PCI bus and devices
4Ah		Initialize all video adapters in system
4Bh		QuietBoot start (optional)
4Ch		Shadow video BIOS ROM
4Eh		Display BIOS copyright notice
50h		Display CPU type and speed
51h		Initialize EISA board
52h		Test keyboard
54h		Set key click if enabled
58h	2-2-3-1	Test for unexpected interrupts
59h		Initialize POST display service
5Ah		Display prompt "Press F2 to enter SETUP"
5Bh		Disable CPU cache
5Ch		Test RAM between 512 and 640 KB
60h		Test extended memory
62h		Test extended memory address lines
64h		Jump to User Patch1
66h		Configure advanced cache registers
67h		Initialize Multi Processor APIC
68h		Enable external and CPU caches
69h		Setup System Management Mode (SMM) area
6Ah		Display external L2 cache size
6Bh		Load custom defaults (optional)
6Ch		Display shadow-area message
6Eh		Display possible high address for UMB recovery
70h		Display error messages
72h		Check for configuration errors
76h		Check for keyboard errors
7Ch		Set up hardware interrupt vectors
7Eh		Initialize coprocessor if present
80h		Disable onboard Super I/O ports and IRQs
81h		Late POST device initialization
82h		Detect and install external RS232 ports
83h		Configure non-MCD IDE controllers
84h		Detect and install external parallel ports
85h		Initialize PC-compatible PnP ISA devices
86h		Re-initialize onboard I/O ports
87h		Configure Motherboard Configurable Devices (optional)
88h		Initialize BIOS Area
89h		Enable Non-Maskable Interrupts (NMIs)

Code	Beeps	POST Routine Description
8Ah		Initialize Extended BIOS Data Area
8Bh		Test and initialize PS/2 mouse
8Ch		Initialize floppy controller
8Fh		Determine number of ATA drives (optional)
90h		Initialize hard-disk controllers
91h		Initialize local-bus hard-disk controllers
92h		Jump to UserPatch2
93h		Build MPTABLE for multi-processor boards
95h		Install CD ROM for boot
96h		Clear huge ES segment register
97h		Fixup Multi Processor table
98h	1-2	Search for option ROMs. One long, two short beeps on checksum failure.
99h		Check for SMART drive (optional)
9Ah		Shadow option ROMs
9Ch		Set up Power Management
9Dh		Initialize security engine (optional)
9Eh		Enable hardware interrupts
9Fh		Determine number of ATA and SCSI drives
A0h		Set time of day
A2h		Check key lock
A4h		Initialize Typematic rate
A8h		Erase F2 prompt
AAh		Scan for F2 key stroke
ACh		Enter SETUP
AEh		Clear Boot flag
B0h		Check for errors
B2h		POST done- prepare to boot operating system
B4h	1	One short beep before boot
B5h		Terminate QuietBoot (optional)
B6h		Check password (optional)
B9h		Prepare Boot
BAh		Initialize DMI parameters
BBh		Initialize PnP Option ROMs
BCh		Clear parity checkers
BDh		Display MultiBoot menu
BEh		Clear screen (optional)
BFh		Check virus and backup reminders
C0h		Try to boot with INT 19
C1h		Initialize POST Error Manager (PEM)
C2h		Initialize error logging
C3h		Initialize error display function
C4h		Initialize system error handler

Code	Beeps	POST Routine Description
C5h		PnPnd dual CMOS (optional)
C6h		Initialize notebook docking (optional)
C7h		Initialize notebook docking late
C8h		Force check (optional)
C9h		Extended checksum (optional)
D2h		Unknown interrupt
E0h		Initialize the chipset
E1h		Initialize the bridge
E2h		Initialize the CPU
E3h		Initialize the system timer
E4h		Initialize system I/O
E5h		Check force recovery boot
E6h		Checksum BIOS ROM
E7h		Go to BIOS
E8h		Set Huge Segment
E9h		Initialize Multi Processor
EAh		Initialize OEM special code
EBh		Initialize PIC and DMA
ECh		Initialize Memory type
EDh		Initialize Memory size
EEh		Shadow Boot Block
EFh		System memory test
F0h		Initialize interrupt vectors
F1h		Initialize Run Time Clock
F2h		Initialize video
F3h		Initialize System Management Mode
F4h	1	Output one beep before boot
F5h		Boot to Mini DOS
F6h		Clear Huge Segment
F7h		Boot to Full DOS

Index of Symptom-to-FRU Error Message

LCD-Related Symptoms

Symptom / Error	Action in Sequence
LCD backlight doesn't work LCD is too dark LCD brightness cannot be adjusted LCD contrast cannot be adjusted	Enter BIOS Utility to execute "Load Setup Default Settings", then reboot system. Reconnect the LCD connectors. Keyboard (if contrast and brightness function key doesn't work). LCD inverter ID LCD cable LCD inverter LCD System board
Unreadable LCD screen Missing pels in characters Abnormal screen Wrong color displayed	Reconnect the LCD connector LCD inverter ID LCD cable LCD inverter LCD System board
LCD has extra horizontal or vertical lines displayed.	LCD inverter ID LCD inverter LCD cable LCD System board

Indicator-Related Symptoms

Symptom / Error	Action in Sequence
Indicator incorrectly remains off or on, but system runs correctly.	Reconnect the inverter board Inverter board System board

Power-Related Symptoms

Symptom / Error	Action in Sequence
Power shuts down during operation.	Power source (battery pack and power adapter). See "Power System Check" on page 167. Battery pack Power adapter Hard drive & battery connection board System board
The system doesn't power-on.	Power source (battery pack and power adapter). See "Power System Check" on page 167. Battery pack Power adapter Hard drive & battery connection board System board

Symptom / Error	Action in Sequence
The system doesn't power-off.	Power source (battery pack and power adapter). See "Power System Check" on page 167. Hold and press the power switch for more than 4 seconds. System board
Battery can't be charged.	See "Check the Battery Pack" on page 167. Battery pack System board

PCMCIA-Related Symptoms

Symptom / Error	Action in Sequence
System cannot detect the PC Card (PCMCIA).	PCMCIA slot assembly System board
PCMCIA slot pin is damaged.	PCMCIA slot assembly

Memory-Related Symptoms

Symptom / Error	Action in Sequence
Memory count (size) appears different from actual size.	Enter BIOS Setup Utility to execute "Load Default Settings", then reboot system. DIMM System board

Speaker-Related Symptoms

Symptom / Error	Action in Sequence
In Windows, multimedia programs, no sound comes from the computer.	Audio driver Speaker System board
Internal speakers make noise or emit no sound.	Speaker System board

Power Management-Related Symptoms

Symptom / Error	Action in Sequence
The system will not enter hibernation.	Keyboard (if control is from the keyboard) Hard disk drive System board
The system doesn't enter hibernation mode and four short beeps every minute.	Press Fn+0 and see if the computer enters hibernation mode. Touchpad Keyboard Hard disk connection board Hard disk drive System board
The system doesn't enter standby mode after closing the LCD.	LCD cover switch System board

Symptom / Error	Action in Sequence
The system doesn't resume from hibernation mode.	Hard disk connection board Hard disk drive System board
The system doesn't resume from standby mode after opening the LCD.	LCD cover switch System board
Battery fuel gauge in Windows doesn't go higher than 90%.	Remove battery pack and let it cool for 2 hours. Refresh battery (continue use battery until power off, then charge battery). Battery pack System board
System hangs intermittently.	Reconnect hard disk/CD-ROM drives. Hard disk connection board System board

Peripheral-Related Symptoms

Symptom / Error	Action in Sequence
System configuration does not match the installed devices.	Enter BIOS Setup Utility to execute “Load Default Settings”, then reboot system. Reconnect hard disk/CD-ROM/diskette drives.
External display does not work correctly.	Press Fn+F5, LCD/CRT/Both display switching. System board
USB does not work correctly.	System board
Print problems.	Ensure the “Parallel Port” in the “Onboard Devices Configuration” of BIOS Setup Utility is set to Enabled. Onboard Devices Configuration Run printer self-test. Printer driver Printer cable Printer System Board
Serial or parallel port device problems.	Ensure the “Serial Port” in the Devices Configuration” of BIOS Setup Utility is set to Enabled. Device driver Device cable Device System board

Keyboard/Touchpad-Related Symptoms

Symptom / Error	Action in Sequence
Keyboard (one or more keys) does not work.	Reconnect the keyboard cable. Keyboard System board
Touchpad does not work.	Reconnect touchpad cable. Touchpad board System board

Modem-Related Symptoms

Symptom / Error	Action in Sequence
Internal modem does not work correctly.	Modem phone port modem combo board System board

NOTE: If you cannot find a symptom or an error in this list and the problem remains, see “Undetermined Problems” on page 182.

Intermittent Problems

Intermittent system hang problems can be caused by a variety of reasons that have nothing to do with a hardware defect, such as: cosmic radiation, electrostatic discharge, or software errors. FRU replacement should be considered only when a recurring problem exists.

When analyzing an intermittent problem, do the following:

1. Run the advanced diagnostic test for the system board in loop mode at least 10 times.
2. If no error is detected, do not replace any FRU.
3. If any error is detected, replace the FRU. Rerun the test to verify that there are no more errors.

Undetermined Problems

The diagnostic problems does not identify which adapter or device failed, which installed devices are incorrect, whether a short circuit is suspected, or whether the system is inoperative.

Follow these procedures to isolate the failing FRU (do not isolate non-defective FRU).

NOTE: Verify that all attached devices are supported by the computer.

NOTE: Verify that the power supply being used at the time of the failure is operating correctly. (See “Power System Check” on page 167).

1. Power-off the computer.
2. Visually check them for damage. If any problems are found, replace the FRU.
3. Remove or disconnect all of the following devices:
 - Non-Acer devices
 - Printer, mouse, and other external devices
 - Battery pack
 - Hard disk drive
 - DIMM
 - CD-ROM/Diskette drive Module
 - PC Cards
4. Power-on the computer.
5. Determine if the problem has changed.
6. If the problem does not recur, reconnect the removed devices one at a time until you find the failing FRU.
7. If the problem remains, replace the following FRU one at a time. Do not replace a non-defective FRU:
 - System board
 - LCD assembly

Jumper and Connector Locations

Top View

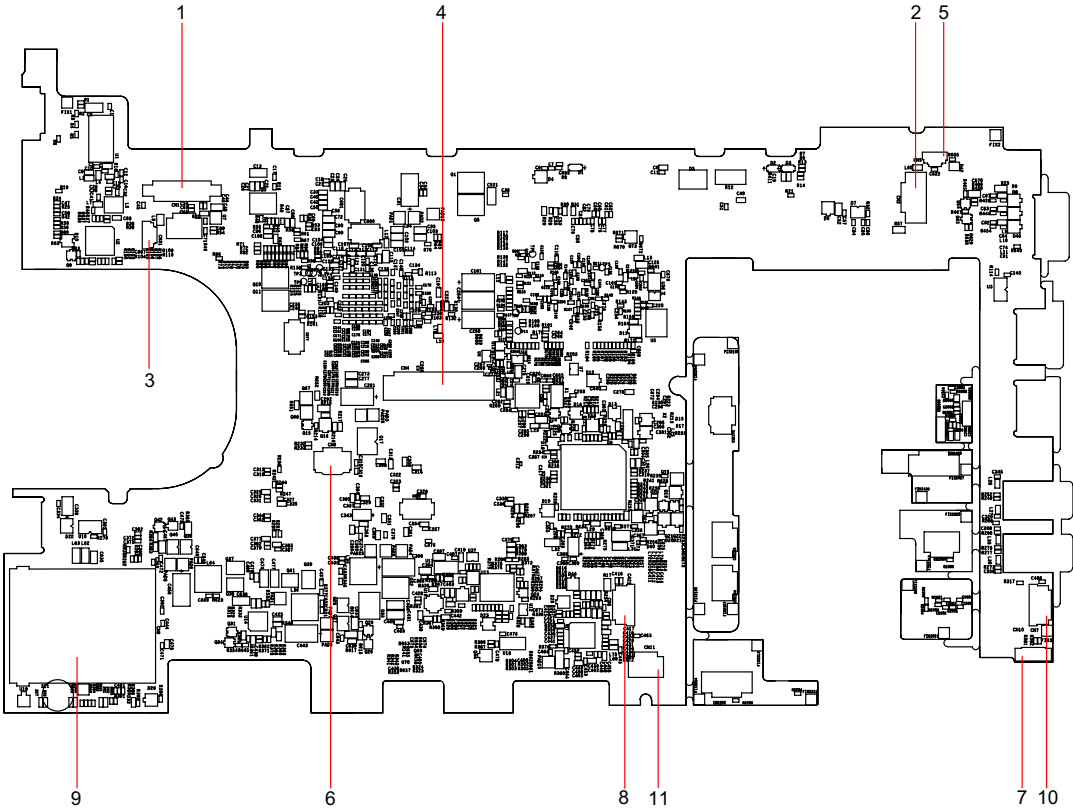

TravelMate 8172/8172Z M/B layout and connector location TOP view		
No.	Name	Description
1	CN1	LCM connector
2	CN2	Power
3	CN4	Keyboard connector
4	CN5	Microphone connector
5	CN6	Touch pad connector
6	CN7	Audio cable connector 1
7	CN8	Audio cable connector 2
8	CN9	Card reader slot
9	CN10	Bluetooth connector
10	CN11	Speaker connector

Bottom View

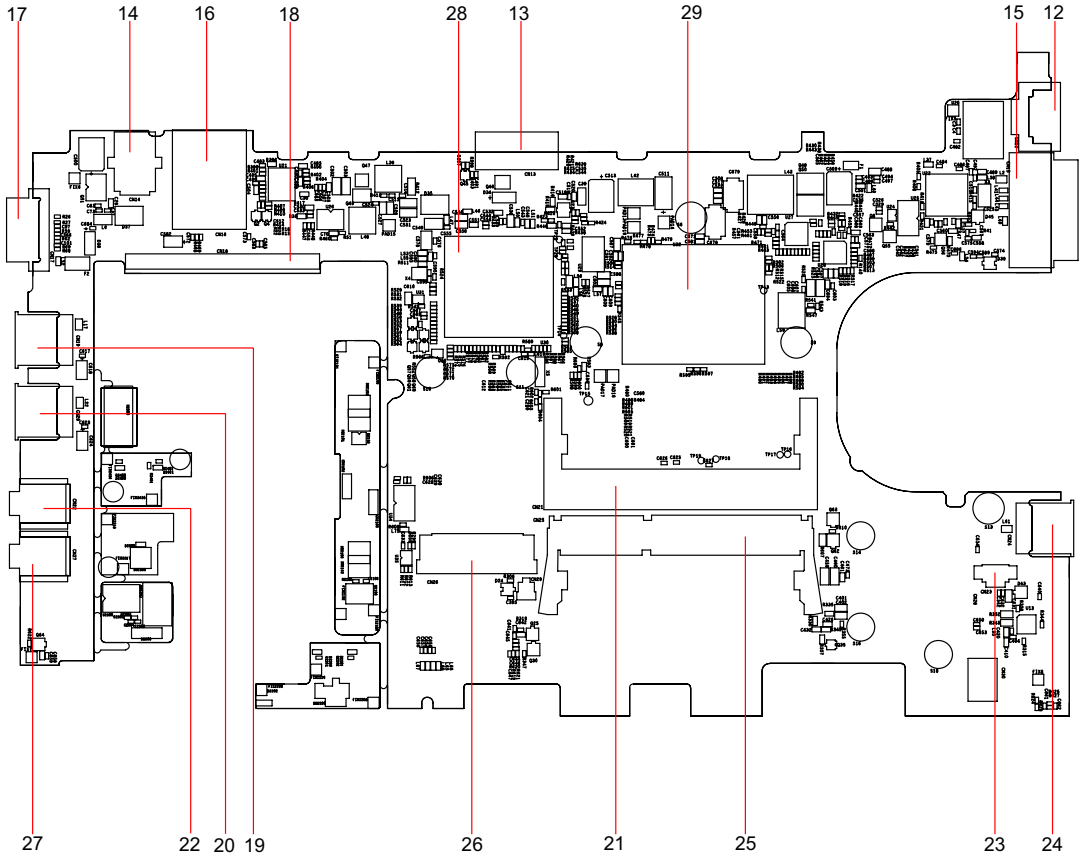

TravelMate 8172/8172Z M/B layout and connector location Bottom view		
No.	Name	Description
12	CN12	LAN slot
13	CN13	Battery connector
14	CN14	DC-in jack
15	CN15	EZ-Docking slot
16	CN16	SIM Card slot
17	CN17	VGA port
18	CN18	HDD connector
19	CN18	USB slot 1
20	CN20	USB slot 2
21	CN21	DIMM-0
22	CN22	MIC jack
23	CN23	Fan connector
24	CN24	USB slot-3
25	CN25	DIMM-1
26	CN26	3G card slot

TravelMate 8172/8172Z M/B layout and connector location Bottom view		
No.	Name	Description
27	CN27	Earphone connector
28	U30	South bridge
29	U32	CPU+ North bridge

FRU (Field Replaceable Unit) List

This chapter gives you the FRU (Field Replaceable Unit) listing in global configurations of TravelMate 8172/8172Z. Refer to this chapter whenever ordering for parts to repair or for RMA (Return Merchandise Authorization).

Please note that WHEN ORDERING FRU PARTS, you should check the most up-to-date information available on your regional web or channel. For whatever reasons a part number change is made, it will not be noted on the printed Service Guide. For ACER AUTHORIZED SERVICE PROVIDERS, your Acer office may have a DIFFERENT part number code from those given in the FRU list of this printed Service Guide. You MUST use the local FRU list provided by your regional Acer office to order FRU parts for repair and service of customer machines.

NOTE: To scrap or to return the defective parts, you should follow the local government ordinance or regulations on how to dispose it properly, or follow the rules set by your regional Acer office on how to return it.

TravelMate 8172/8172Z Exploded Diagram

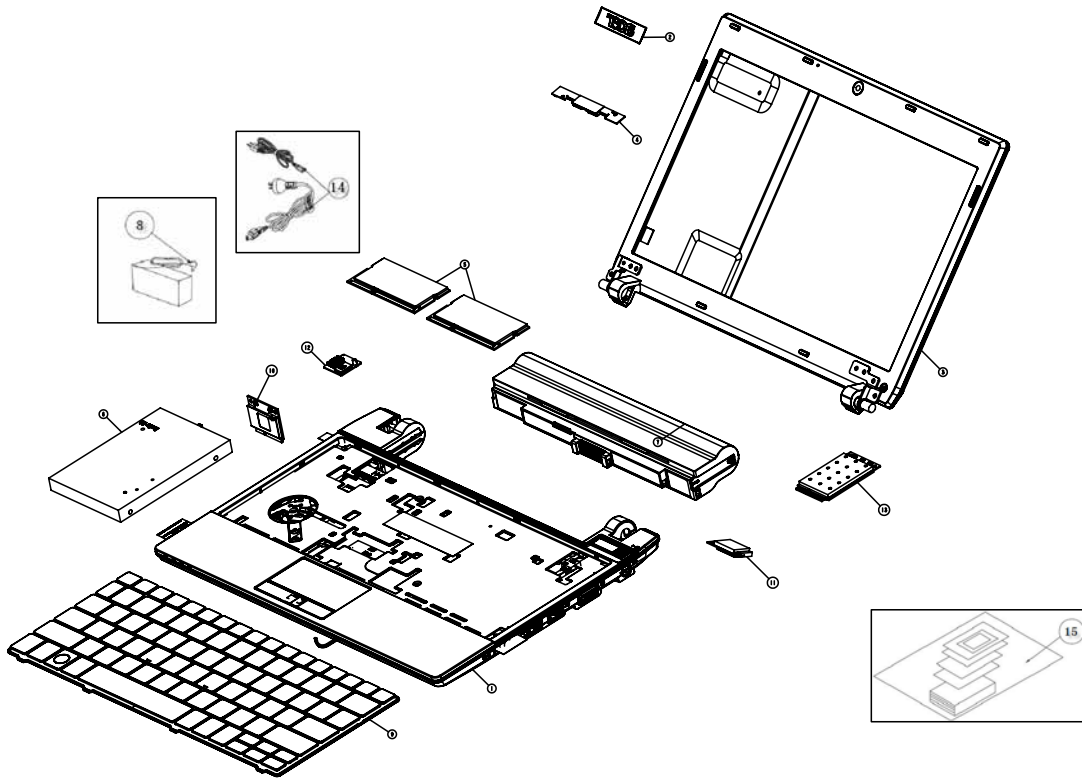

NO.	PART NUMBER	DESCRIPTION	QTY
1	1510B0928401	ASSEMBLY, BASE	1
2	6053B0630801	ASSEMBLY, Nameplate	1
3	1510B0929601	ASSEMBLY, DISPLAY	1
4	1510B0929701	ASSEMBLY, CAMERA	1
5	1510B0929101	ASSEMBLY, MEMORY	3
6	1510B0930101	ASSEMBLY, HDD	1
7	1510B0931701	ASSEMBLY, BATTERY	1
8	1700B0271001	AC Adapter	1
9	1510B0925301	ASSEMBLY, KEYBOARD	1
10	1510B0931901	ASSEMBLY, WIFI	1
11	1510B0932001	ASSEMBLY, BULETOOTH	1
12	1397B0093201	ASSEMBLY, MODULE, TPM	1
13	1510B0934101	ASSEMBLY, 3G	1
14	6017A0034801	Power Cord	1
15	NA	ASSEMBLY, PACKAGING, UNIT KIT	1

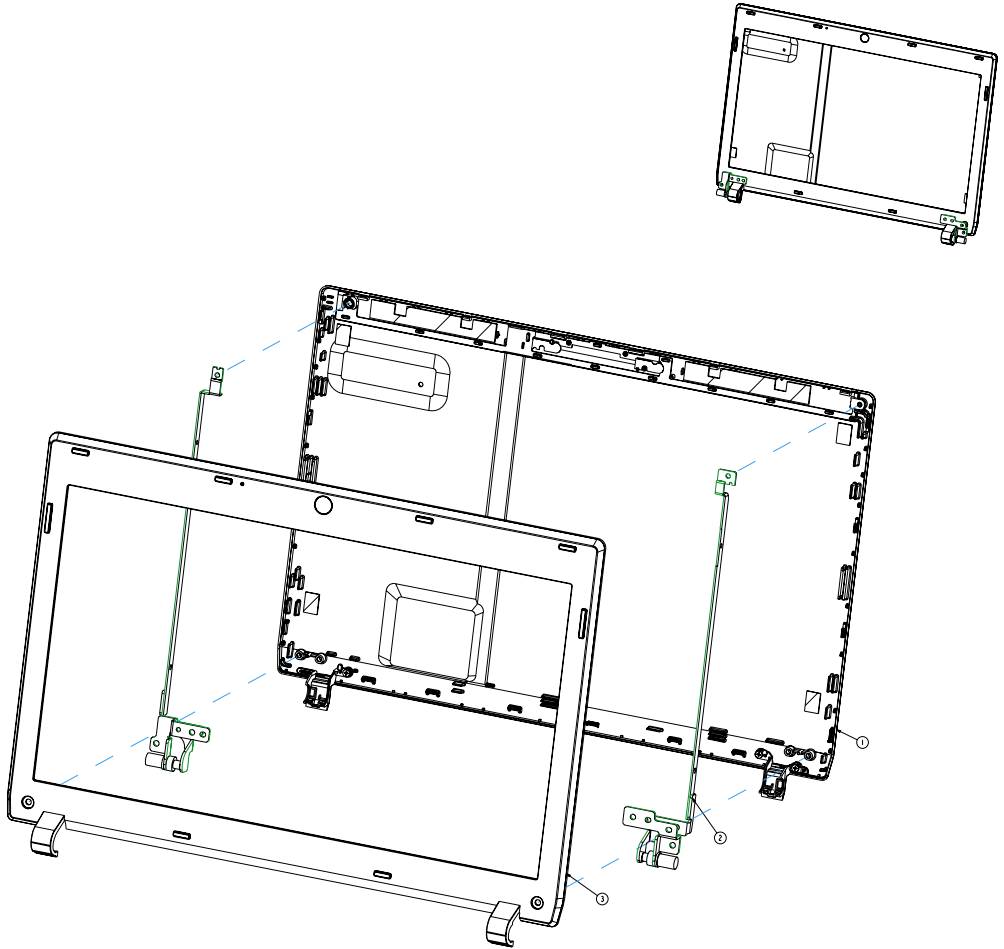

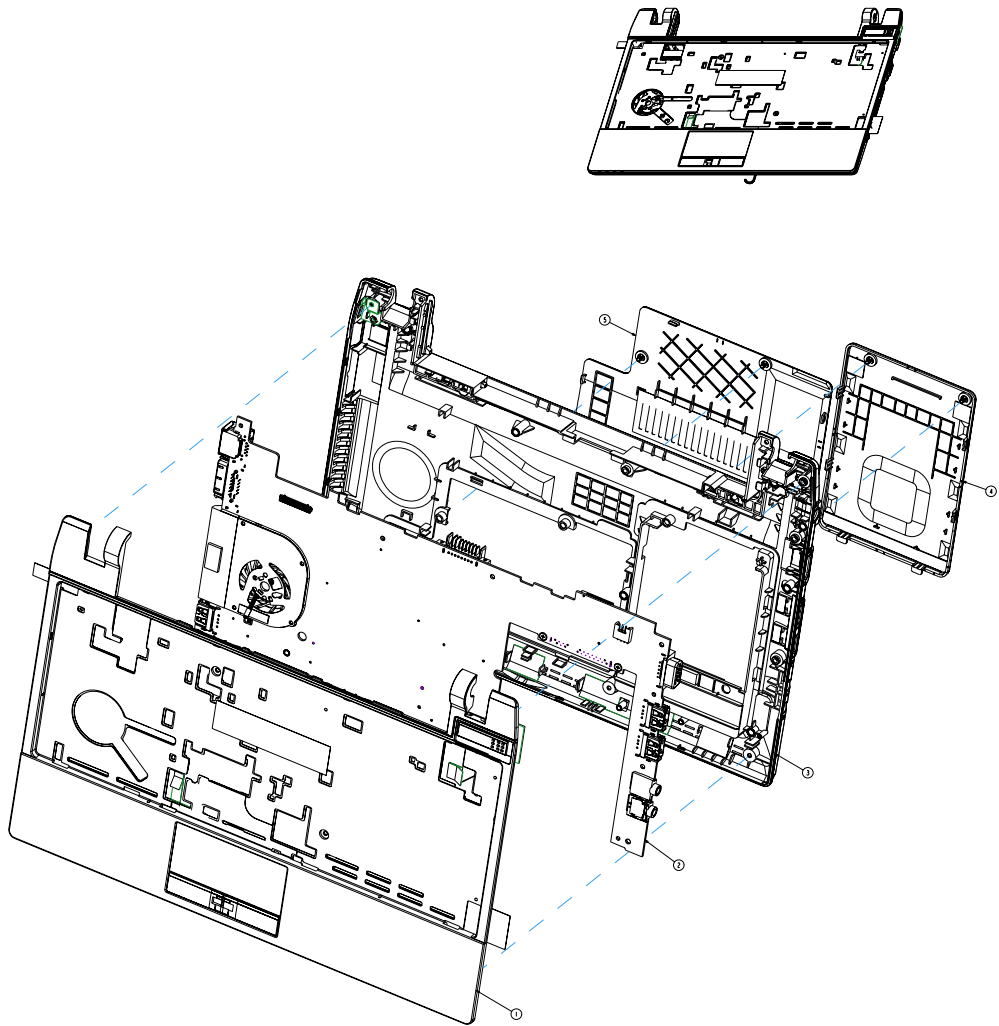

NO.	PART NUMBER	DESCRIPTION	QTY
1	1510B0922401	ASSEMBLY, CASE, REAR, DISPLAY, OFFLINE	1
2	1510B0935401	HINGE Set	1
3	1510B0922501	ASSEMBLY, CASE, FRONT, DISPLAY, OFFLINE	1



NO.	PART NUMBER	DESCRIPTION	QTY
1	1510B0928701	ASSEMBLY, CASE, TOP	1
2	1397B0092701	ASSEMBLY, MODULE, MAIN, OFFLINE	1
3	1510B0922001	ASSEMBLY, CASE, BOTTOM OFFLINE	1
4	1510B0922301	ASSEMBLY, CASE, HDD COVER	1
5	1510B0935201	ASSEMBLY, CASE, DDR COVER	1

TravelMate 8172/8172Z FRU List

Accessory

Category	Part Name and Description	Acer Part No.
	WIRELESS ANTENNA RIGHT	50.TWR0N.001
	WIRELESS ANTENNA LEFT	50.TWR0N.002
	ANTENNA - R	50.TWM0N.003
	ANTENNA - L	50.TWM0N.004

Adapter

Category	Part Name and Description	Acer Part No.
	Adapter DELTA 40W 19V 1.7x5.5x11 Black ADP-40 TH AA, LV5 wall-mounted, OBL LF	AP.04001.002
	Adapter Leader 40W 19V 1.7x5.5x11 Black IU40-11190-011S, wall-mounted, LV5+OBL LF	AP.04007.002

Battery

Category	Part Name and Description	Acer Part No.
	Battery SANYO UM-2009E Li-Ion 3S2P SANYO 6 cell 5600mAh Main COMMON for HSF ID:UM09E36,for HSF	BT.00603.122
	Battery PANASONIC UM-2009E Li-Ion 3S2P PANASONIC 6 cell 5800mAh Main COMMON for Halogen-Free ID:UM09E56,for Halogen-Free	BT.00605.069

Board

Category	Part Name and Description	Acer Part No.
	Liteon Wireless LAN Atheros HB93 2x2 BGN (HM) WN6602AH	NI.23600.063

Category	Part Name and Description	Acer Part No.
	Foxconn Wireless LAN Atheros HB97 2x2 BGN (HM)	NI.23600.072
	Liteon Wireless LAN Atheris HB97 2x2 BGN (HM) WN6603AH	NI.23600.073
	Foxconn Wirelss LAN Atheros HB95BG (HM) T77H121.10	NI.23600.077
	Foxconn Wireless LAN Broadcomm 43225 2x2 BGN (HM) T77H103.00	NI.23600.066
	Foxconn Wireless LAN Atheros HB93 2x2 BGN (HM)	NI.23600.062
	Foxconn Wirelss LAN Broadcom 4313 1x1 BGN (HM) T77H194.00	NI.23600.076
	Ericsson F3307-900MHz	LC.21300.039
	Foxconn Bluetooth BRM 2046 BT2.1 (T60H928.33 Ver.3/PCB V015) HSF	BH.21100.006
	Foxconn Bluetooth ATH AR3011	BH.21100.009
	Foxconn Bluetooth BRM 2070 (T77H114.01) BT 3.0	BH.21100.010
	POWER SWITCH BOARD	55.TWN0N.001
	TOUCH PAD BUTTON BOARD W/FP	55.TZV0N.001
	TOUCH PAD BUTTON BOARD WO/FP	55.TZV0N.002

Cable

Category	Part Name and Description	Acer Part No.
	BLUETOOTH CABLE_8 Pin (BT 2.1)	50.TWM0N.006
	BLUETOOTH CABLE_6 Pin (BT 3.0)	50.TWM0N.005
	AUDIO CABLE	50.TWN0N.001
	DC IN CABLE	50.TWN0N.002
	POWER SWITCH BOARD CABLE	50.TWN0N.003
	TOUCH PAD BUTTON BOARD CABLE	50.TWN0N.004
	TOUCH PAD CABLE_RIGHT	50.TWN0N.005
	TOUCH PAD CABLE_LEFT	50.TWN0N.006
	CCD CABLE	50.TWM0N.001

Category	Part Name and Description	Acer Part No.
	LCD CABLE	50.TWM0N.002

Camera

Category	Part Name and Description	Acer Part No.
	CAMERA MODULE 1.3M - SUYIN	57.TWM0N.001
	CAMERA MODULE 1.3M - CHICONY	57.TWM0N.002
	CAMERA MODULE 1.3M - LITEON	57.TWM0N.003

CASE/COVER/BRACKET ASSEMBLY

Category	Part Name and Description	Acer Part No.
	AC Power Clip IU40-1-UL Rev 1.0	LZ.20400.315
	AC Power Clip IU40-1-EU Rev 1.0	LZ.20400.311
	AC Power Clip IU40-1-SAA Rev 1.0	LZ.20400.312
	AC Power Clip IU40-1-UK Rev 1.0	LZ.20400.314
	AC power clip IU40-1-ARG Rev 1.0	LZ.20400.308
	AC Power Clip IU40-1-CCC Rev 1.0	LZ.20400.309
	AC power Clip IU40-1-BRZ Rev 1.0	LZ.20400.307
	AC Power Clip IU40-1-SABS Rev 1.0	LZ.20400.313
	AC Power Clip IU40-1-EK Rev 1.0	LZ.20400.310
	AC Power Clip IU40-1-AF Rev 1.0	LZ.20400.324
	HDD COVER	42.TWN0N.001
	RAM COVER	42.TWN0N.002
	LOWER CASE	60.TWN0N.001
	LOWER CASE_3G	60.TZW0N.001
	DC IN BRACKET	33.TWN0N.001

Category	Part Name and Description	Acer Part No.
	DUMMY CARD	42.TWN0N.003
	UPPER CASE ASSY W/ TP, W/ FP	60.TWN0N.002
	UPPER CASE ASSY W/ TP, W/ O FP	60.TWM0N.001
	HDD CONNECTOR	20.TWN0N.001
	LCD HINGE R	33.TWM0N.001
	LCD HINGE L	33.TWM0N.002
	LCD BEZEL 11.6" W/CCD	60.TWM0N.003
	LCD COVER 11.6" W/CCD	60.TWM0N.004
	LCD COVER 11.6" W/CCD, NON 3G	60.TWM0N.006

HDD/HARD DISK DRIVER

Category	Part Name and Description	Acer Part No.
	HDD SEAGATE 2.5" 5400rpm 160GB ST9160314AS Wyatt SATA LF F/W:0001SDM1	KH.16001.042
	HDD TOSHIBA 2.5" 5400rpm 160GB MK1665GSX, Capricorn BS, 320G/P SATA 8MB LF F/W:GJ002J	KH.16004.008
	HDD HGST 2.5" 5400rpm 160GB HTS545016B9A300 Panther B SATA LF F/W:C60F Disk imbalance criteria = 0.014g-cm	KH.16007.026
	HDD WD 2.5" 5400rpm 160GB WD1600BEVT-22A23T0 , WD, ML320S SATA 8MB LF F/W:01.01A01	KH.16008.027
	HDD SEAGATE 2.5" 5400RPM 250GB ST9250315AS WYATT SATA LF F/W:0001SDM1	KH.25001.016
	HDD TOSHIBA 2.5" 5400rpm 250GB MK2565GSX, Capricorn BS, 320G/P SATA 8MB LF F/W:GJ002J	KH.25004.005
	HDD HGST 2.5" 5400rpm 250GB HTS545025B9A300 Panther B SATA LF F/W:C60F Disk imbalance criteria = 0.014g-cm	KH.25007.016
	HDD WD 2.5" 5400rpm 250GB WD2500BEVT-22A23T0, WD, ML320S SATA 8MB LF F/W:01.01A01.	KH.25008.025
	HDD SEAGATE 2.5" 7200rpm 250GB ST9250410AS Holiday SATA LF F/W:0002SDM1	KH.25001.017
	HDD HGST 2.5" 7200rpm 250GB HTS725025A9A364 SATA 8MB LF F/W:C70E	KH.25007.018
	HDD SEAGATE 2.5" 5400rpm 320GB ST9320325AS Wyatt SATA LF F/W:0001SDM1	KH.32001.017
	HDD TOSHIBA 2.5" 5400rpm 320GB Capricorn BS ,MK3265GSX SATA 8MB LF F/W:GJ002J	KH.32004.004
	HDD HGST 2.5" 5400rpm 320GB HTS545032B9A300 Panther B SATA LF F/W:C60F Disk imbalance criteria = 0.014g-cm	KH.32007.008
	HDD WD 2.5" 5400rpm 320GB WD3200BEVT-22A23T0,ML320S,WD SATA 8MB LF F/W:01.01A01	KH.32008.019
	HDD SEAGATE 2.5" 7200rpm 320GB ST9320423AS Holiday SATA LF F/W:0002SDM1	KH.32001.016
	HDD HGST 2.5" 7200rpm 320GB HTS725032A9A364 SATA 8MB LF F/W:C70E	KH.32007.010
HDD 500GB 5400RPM SEAGATE ST9500325AS WYATT SATA LF F/W:0001SDM1	KH.50001.011	
HDD TOSHIBA 2.5" 5400rpm 500GB MK5065GSX,Capricorn BS, 320G/P SATA 8MB LF F/W:GJ002J	KH.50004.002	

Category	Part Name and Description	Acer Part No.
	HDD HGST 2.5" 5400RPM 500GB HTS545050B9A300 PANTHER B SATA LF F/W:C60F	KH.50007.010
	HDD WD 2.5" 5400rpm 500GB WD5000BEVT-22A0RT0, ML320M,WD SATA 8MB LF F/W:01.01A01	KH.50008.017
	HDD SEAGATE 2.5" 7200rpm 500GB ST9500420AS Holiday SATA LF F/W:0002SDM1	KH.50001.013
	HDD HGST 2.5" 7200rpm 500GB HTS725050A9A364 SATA 8MB LF F/W: C70E	KH.50007.011
	HDD TOSHIBA 2.5" 5400rpm 640GB MK6465GSX,Capricorn BS,320G/P SATA 8MB LF F/W:GJ002J	KH.64004.001
	HDD WD 2.5" 5400rpm 640GB WD6400BEVT-22A0RT0, ML320 SATA 8MB LF F/W:01.01A01	KH.64008.004

HEATSINK

Category	Part Name and Description	Acer Part No.
	THERMAL MODULE UMA	60.TWM0N.005

KEYBOARD

Category	Part Name and Description	Acer Part No.
	Keyboard ACER NT1T_A10B NT1T Internal 11 Standard 84KS Black Arabic Texture	KB.I110A.092
	Keyboard ACER NT1T_A10B NT1T Internal 11 Standard 85KS Black Belgium Texture	KB.I110A.093
	Keyboard ACER NT1T_A10B NT1T Internal 11 Standard 85KS Black Brazilian Portuguese Texture	KB.I110A.094
	Keyboard ACER NT1T_A10B NT1T Internal 11 Standard 85KS Black CZ/SK Texture	KB.I110A.095
	Keyboard ACER NT1T_A10B NT1T Internal 11 Standard 84KS Black Chinese Texture	KB.I110A.096
	Keyboard ACER NT1T_A10B NT1T Internal 11 Standard 85KS Black Danish Texture	KB.I110A.097
	Keyboard ACER NT1T_A10B NT1T Internal 11 Standard 85KS Black FR/Arabic Texture	KB.I110A.098
	Keyboard ACER NT1T_A10B NT1T Internal 11 Standard 85KS Black French Texture	KB.I110A.099
	Keyboard ACER NT1T_A10B NT1T Internal 11 Standard 85KS Black German Texture	KB.I110A.100
	Keyboard ACER NT1T_A10B NT1T Internal 11 Standard 84KS Black Greek Texture	KB.I110A.101
	Keyboard ACER NT1T_A10B NT1T Internal 11 Standard 85KS Black Hungarian Texture	KB.I110A.102
	Keyboard ACER NT1T_A10B NT1T Internal 11 Standard 85KS Black Italian Texture	KB.I110A.103
	Keyboard ACER NT1T_A10B NT1T Internal 11 Standard 88KS Black Japanese Texture	KB.I110A.104

Category	Part Name and Description	Acer Part No.
	Keyboard ACER NT1T_A10B NT1T Internal 11 Standard 84KS Black Korean Texture	KB.I110A.105
	Keyboard ACER NT1T_A10B NT1T Internal 11 Standard 85KS Black Nordic Texture	KB.I110A.106
	Keyboard ACER NT1T_A10B NT1T Internal 11 Standard 85KS Black Norwegian Texture	KB.I110A.107
	Keyboard ACER NT1T_A10B NT1T Internal 11 Standard 85KS Black Portuguese Texture	KB.I110A.108
	Keyboard ACER NT1T_A10B NT1T Internal 11 Standard 84KS Black Russian Texture	KB.I110A.109
	Keyboard ACER NT1T_A10B NT1T Internal 11 Standard 85KS Black SLO/CRO Texture	KB.I110A.110
	Keyboard ACER NT1T_A10B NT1T Internal 11 Standard 85KS Black Spanish Texture	KB.I110A.111
	Keyboard ACER NT1T_A10B NT1T Internal 11 Standard 85KS Black Sweden Texture	KB.I110A.112
	Keyboard ACER NT1T_A10B NT1T Internal 11 Standard 85KS Black Swiss/G Texture	KB.I110A.113
	Keyboard ACER NT1T_A10B NT1T Internal 11 Standard 84KS Black Thailand Texture	KB.I110A.114
	Keyboard ACER NT1T_A10B NT1T Internal 11 Standard 85KS Black Turkish Texture	KB.I110A.115
	Keyboard ACER NT1T_A10B NT1T Internal 11 Standard 85KS Black UK Texture	KB.I110A.116
	Keyboard ACER NT1T_A10B NT1T Internal 11 Standard 84KS Black US International Texture	KB.I110A.117
	Keyboard ACER NT1T_A10B NT1T Internal 11 Standard 84KS Black US International w/ Hebrew Texture	KB.I110A.118
	Keyboard ACER NT1T_A10B NT1T Internal 11 Standard 85KS Black US w/ Canadian French Texture	KB.I110A.119

LCD PANEL

Category	Part Name and Description	Acer Part No.
	LED LCD AUO 11.6" WXGA Glare B116XW02 V0 1A (3G) LF 200nit 8ms 500:1	LK.11605.003
	LED LCD LPL 11.6" WXGA Glare LP116WH1-TLN1 LF 200nit 16ms 400:1 (Power saving)	LK.11608.003
	LED LCD CMO 11.6" WXGA Glare N116B6-L02 C2 LF 200nit 10ms 500:1	LK.1160D.005
	LED LCD SAMSUNG 11.6" WXGA Glare LTN116AT03-A01 LF 200nit 16ms 500:1	LK.11606.003
	LED LCD AUO 11.6" WXGA None Glare B116XW02 V1 LF 200nit 8ms 500:1	LK.11605.006
	LED LCD SAMSUNG 11.6" WXGA None Glare LTN116AT03-002 LF 200nit 16ms 300:1	LK.11606.005
	LED LCD LPL 11.6" WXGA None Glare LP116WH1-TLP1 LF 200nit 16ms	LK.11608.004

MIAN BOARD

Category	Part Name and Description	Acer Part No.
	Mainboard NS10C/TM8172Z PMDU5400B 3G LF+HF	MB.WTN0B.001
	Mainboard NS10i/TM8172 Ci5540UMB 3G LF+HF	MB.WTS0B.004
	Mainboard NS10i/TM8172 Ci5430UMB 3G LF+HF	MB.WTS0B.006
	Mainboard NS10i/TM8172 Ci5520UMB 3G LF+HF	MB.WTS0B.005
	Mainboard NS10i/TM8172 Ci3330UMB 3G LF+HF	MB.WTS0B.007
	Mainboard NS10i/TM8172 Ci5470UMB 3G LF+HF	MB.WTS0B.002
	Mainboard NS10i/TM8172 Ci3380UMB 3G LF+HF	MB.WTS0B.001
	Mainboard NS10i/TM8172 Ci5560UMB 3G LF+HF	MB.WTS0B.003
	Mainboard NS10i/TM8172 Ci5430UMB LF+HF	MB.WTP0B.006
	Mainboard NS10i/TM8172 Ci5540UMB LF+HF	MB.WTP0B.004
	Mainboard NS10i/TM8172 Ci5520UMB LF+HF	MB.WTP0B.005
	Mainboard NS10i/TM8172 Ci3330UMB LF+HF	MB.WTP0B.007
	Mainboard NS10C/TM8172Z PMDU5400B LF+HF	MB.WTM0B.001
	Mainboard NS10i, TM8172 LF	MB.WTP0B.002
	Mainboard NS10i, TM8172 Intel LF	MB.WTP0B.001
Mainboard NS10i, TM8172 Ci5560UMB Intel LF	MB.WTP0B.003	

MEMORY

Category	Part Name and Description	Acer Part No.
	Memory ELPIDA SO-DIMM DDRIII 1066 1GB EBJ10UE8BDS0-AE-F LF 128*8 0.065um	KN.1GB09.012
	MEMORY SAMSUNG SO-DIMM DDRIII 1066 1GB M471B2873EH1-CF8 LF 64*16 0.055UM	KN.1GB0B.028
	Memory HYNIX SO-DIMM DDRIII 1066 1GB HMT112S6BFR6C-G7 N0 LF 64*16 0.055um	KN.1GB0G.025
	Memory ELPIDA SO-DIMM DDRIII 1333 1GB EBJ10UE8BDS0-DJ-F LF 128*8 0.065um	KN.1GB09.015
	Memory HYNIX SO-DIMM DDRIII 1333 1GB HMT112S6TFR8C-H9 LF 128*8 0.055um	KN.1GB0G.026
	Memory SAMSUNG SO-DIMM DDRIII 1333 1GB M471B2873FHS-CH9 LF 128*8 46nm	KN.1GB0B.035
	Memory KINGSTON SO-DIMM DDRIII 1066 2GB ACR256X64D3S1066C7 LF 128*8 0.07um	KN.2GB07.001
	Memory ELPIDA SO-DIMM DDRIII 1066 2GB EBJ21UE8BDS0-AE-F LF 128*8 0.065um	KN.2GB09.006

Category	Part Name and Description	Acer Part No.
	Memory A-DATA SO-DIMM DDRIII 1066 2GB HY7YG1B1674ZM LF 128*8 0.065um	KN.2GB0C.002
	Memory HYNIX SO-DIMM DDRIII 1066 2GB HMT125S6BFR8C-G7 N0 LF 128*8 0.055um	KN.2GB0G.014
	Memory NANYA SO-DIMM DDRIII 1333 2GB NT2GC64B8HC0NS-CG LF 128*8 0.065um	KN.2GB03.017
	Memory KINGSTON SO-DIMM DDRIII 1333 2GB ACR256X64D3S1333C9 LF 128*8 0.065um	KN.2GB07.004
	Memory HYNIX SO-DIMM DDRIII 1333 2GB HMT125S6TFR8C-H9 LF 128*8 0.055um	KN.2GB0G.016
	Memory ELPIDA SO-DIMM DDRIII 1333 2GB EBJ21UE8BDS0-DJ-F LF 128*8 0.065um	KN.2GB09.007
	Memory SAMSUNG SO-DIMM DDRIII 1333 2GB M471B5673FH0-CH9 LF 128*8 46nm	KN.2GB0B.023

MICROPHONE

Category	Part Name and Description	Acer Part No.
	MICROPHONE	23.TZV0N.001

MISCELLANEOUS

Category	Part Name and Description	Acer Part No.
	HDD INSULATOR	47.TLK0N.005
	HDD HOLDER	42.TLK0N.006
	LCD BUMPER	47.TWM0N.005
	BLUETOOTH INSULATOR (8 PIN)	47.TWM0N.003
	BLUETOOTH INSULATOR (6 PIN)	47.TWM0N.004

Category	Part Name and Description	Acer Part No.
	BLUETOOTH FOIL	47.WPP0N.004

SCREW

Category	Part Name and Description	Acer Part No.
	SCREW-I25040M PATCH	86.PCR0N.002
	SCREW,I,M2,6mm,M,4.5mm,0.8mm,PHIL,BK,PATCH	86.APQ0N.004
	SCREW M2.5 2.5MM CROSS BNI PATCH	86.TQP0N.002
	SCREW,I,M2.0,3mm,MACH,3.5mm,0.5mm,CROSS,BNI,PATCH	86.TWM0N.001
	SCREW,I,M2.0,2.5mm,MACH,3.5mm,0.5mm,CROSS,NI,PATCH	86.TWM0N.002

SPEAKER

Category	Part Name and Description	Acer Part No.
	SPEAKER	23.TWM0N.002

Model Definition and Configuration

TravelMate 8172/8172Z

Model	Acer Part No	RO	Country	Description
TM8172Z-U542G25nkk	LX.TX903.002	AAP	Japan	TM8172Z-U542G25nkk W7PR32TJP1 MC XPP UMACFkk_3 1*2G/250/6L2.8/5R/ bgn_FP_1.3C_AL_JA11_CF23
TM8172Z-U542G16nkk	LX.TX903.001	AAP	Japan	TM8172Z-U542G16nkk W7PR32TJP1 MC XPP UMACFkk_3 1*2G/160/BT/6L2.8/5R/ bgn_FP_1.3C_AL_JA11_CF26
TM8172Z-U542G25nkk	LX.TX903.004	AAP	Japan	TM8172Z-U542G25nkk W7PR32TJP1 MC XPP UMACFkk_3 1*2G/250/6L2.8/5R/ bgn_FP_1.3C_AL_JA11_CF24
TM8172Z-U542G25nkk	LX.TX903.003	AAP	Japan	TM8172Z-U542G25nkk W7PR32TJP1 MC XPP UMACFkk_3 1*2G/250/BT/6L2.8/5R/ bgn_FP_1.3C_AL_JA11_CF25
TM8172Z-U542G25n	S2.TX903.001	WW	WW	TM8172Z-U542G25n W7PR32TWW1 MC UMACFkk_3 1*2G/250/6L2.2/5R/ bgn_FP_1.3C_AL_ES62
TM8172Z-U542G16nkk	LX.TXB03.001	AAP	Japan	TM8172Z-U542G16nkk W7PR32TJP1 MC XPP UMACKk_3 1*2G/160/BT/6L2.8/5R/ bgn_1.3C_AL_JA11_C26
TM8172Z-U542G25nkk	LX.TXB03.004	AAP	Japan	TM8172Z-U542G25nkk W7PR32TJP1 MC XPP UMACKk_3 1*2G/250/6L2.8/5R/ bgn_1.3C_AL_JA11_C23
TM8172Z-U542G25nkk	LX.TXB03.002	AAP	Japan	TM8172Z-U542G25nkk W7PR32TJP1 MC XPP UMACKk_3 1*2G/250/BT/6L2.8/5R/ bgn_1.3C_AL_JA11_C25
TM8172Z-U542G16nkk	LX.TXB03.003	AAP	Japan	TM8172Z-U542G16nkk W7PR32TJP1 MC XPP UMACKk_3 1*2G/160/6L2.8/5R/ bgn_1.3C_AL_JA11_C24
TM8172Z-U542G25n	S2.TXB03.001	WW	WW	TM8172Z-U542G25n W7PR32TWW1 MC UMACKk_3 1*2G/250/6L2.2/5R/ bgn_1.3C_AL_ES62
TM8172Z-U542G25n	S2.TX803.003	WW	WW	TM8172Z-U542G25n W7PR32TWW1 MC XPP UMAGCFkk_3 1*2G/250/BT/6L2.2/ 5R/bgn_FP_1.3C_F33- 900_AL_ES62

Model	Acer Part No	RO	Country	Description
TM8172Z-U542G25n	S2.TX803.002	WW	WW	TM8172Z-U542G25n W7PR32TWW1 MC UMAGCFkk_3 1*2G/250/BT/6L2.2/5R/ bgn_FP_1.3C_F33-900_AL_ES62
TM8172Z-U542G25n	S2.TX803.001	WW	WW	TM8172Z-U542G25n W7PR32TWW1 MC UMAGCFkk_3 1*2G/250/6L2.2/5R/ bgn_FP_1.3C_F33-900_AL_ES62
TM8172Z-U542G25n	S2.TXA03.001	WW	WW	TM8172Z-U542G25n W7PR32TWW1 MC UMAGCkk_3 1*2G/250/6L2.2/5R/bgn_1.3C_F33-900_AL_ES62
TM8172-33U2G25nkk	LX.TWN02.00 2	TWN	GCTWN	TM8172-33U2G25nkk W7HP64TRTW1 MC UMACFkk_3 1*2G/250/BT/6L2.8/5R/ bgn_FP_1.3C_AL_TC11
TM8172-52U2G25nkk	LX.TWN02.00 1	TWN	GCTWN	TM8172-52U2G25nkk W7HP64TRTW1 MC UMACFkk_3 1*2G/250/BT/6L2.8/5R/ bgn_FP_1.3C_AL_TC11
TM8172-52U2G25nkk	LX.TWN03.00 3	AAP	Thailand	TM8172-52U2G25nkk EM W7PR32EMTRTH1 MC UMACFkk_3 1*2G/250/BT/6L2.2/5R/ bgn_FP_1.3C_AL_TH41
TM8172-33U2G32nkk	LX.TWN03.00 4	AAP	Thailand	TM8172-33U2G32nkk EM W7PR32EMTRTH1 MC UMACFkk_3 1*2G/320/BT/6L2.2/5R/ bgn_FP_1.3C_AL_TH41
TM8172-52U2G25nkk	LX.TWN03.00 2	EMEA	South Africa	TM8172-52U2G25nkk EM W7PR32EMTRZA2 MC UMACFkk_3 1*2G/250/6L2.2/5R/ bgn_FP_1.3C_AL_ES61
TM8172-52U2G25nkk	LX.TWN03.00 1	EMEA	Italy	TM8172-52U2G25nkk W7PR32TRIT1 MC UMACFkk_3 1*2G/250/BT/6L2.2/5R/ bgn_FP_1.3C_AL_IT11
TM8172-33U2G25nk	LX.TWN03.03 2	EMEA	South Africa	TM8172-33U2G25nk EM W7PR32EMTRZA2 MC XPP UMACFkk_3 1*2G/250/BT/6L2.2/5R/ bgn_FP_1.3C_AL_ES61
TM8172-33U4G25nk	LX.TWN03.03 1	EMEA	South Africa	TM8172-33U4G25nk EM W7PR32EMTRZA2 MC XPP UMACFkk_3 2*2G/250/BT/6L2.2/5R/ bgn_FP_1.3C_AL_ES61
TM8172-33U4G32nk	LX.TWN03.03 0	EMEA	South Africa	TM8172-33U4G32nk EM W7PR32EMTRZA2 MC XPP UMACFkk_3 2*2G/320/BT/6L2.2/5R/ bgn_FP_1.3C_AL_ES61
TM8172-33U4G50nk	LX.TWN03.02 9	EMEA	South Africa	TM8172-33U4G50nk EM W7PR32EMTRZA2 MC XPP UMACFkk_3 2*2G/500_L/BT/6L2.2/ 5R/bgn_FP_1.3C_AL_ES61

Model	Acer Part No	RO	Country	Description
TM8172-5434G50nk	LX.TWN03.02 8	EMEA	South Africa	TM8172-5434G50nk EM W7PR32EMTRZA2 MC XPP UMACFkk_3 2*2G/500_L/BT/6L2.2/ 5R/bgn_FP_1.3C_AL_ES61
TM8172-5434G32nk	LX.TWN03.02 7	EMEA	South Africa	TM8172-5434G32nk EM W7PR32EMTRZA2 MC XPP UMACFkk_3 2*2G/320/BT/6L2.2/5R/ bgn_FP_1.3C_AL_ES61
TM8172-52U4G32nk	LX.TWN03.02 6	EMEA	South Africa	TM8172-52U4G32nk EM W7PR32EMTRZA2 MC XPP UMACFkk_3 2*2G/320/BT/6L2.2/5R/ bgn_FP_1.3C_AL_ES61
TM8172-52U4G50nk	LX.TWN03.02 5	EMEA	South Africa	TM8172-52U4G50nk EM W7PR32EMTRZA2 MC XPP UMACFkk_3 2*2G/500_L/BT/6L2.2/ 5R/bgn_FP_1.3C_AL_ES61
TM8172-52U2G50nk	LX.TWN03.02 4	EMEA	South Africa	TM8172-52U2G50nk EM W7PR32EMTRZA2 MC XPP UMACFkk_3 1*2G/500_L/BT/6L2.2/ 5R/bgn_FP_1.3C_AL_ES61
TM8172-52U2G32nk	LX.TWN03.02 3	EMEA	South Africa	TM8172-52U2G32nk EM W7PR32EMTRZA2 MC XPP UMACFkk_3 1*2G/320/BT/6L2.2/5R/ bgn_FP_1.3C_AL_ES61
TM8172-52U2G25nk	LX.TWN03.02 2	EMEA	South Africa	TM8172-52U2G32nk EM W7PR32EMTRZA2 MC XPP UMACFkk_3 1*2G/320/BT/6L2.2/5R/ bgn_FP_1.3C_AL_ES61
TM8172-33U2G32nk	LX.TWN03.02 1	EMEA	South Africa	TM8172-52U2G25nk EM W7PR32EMTRZA2 MC XPP UMACFkk_3 1*2G/250/BT/6L2.2/5R/ bgn_FP_1.3C_AL_ES61
TM8172-5432G16nkk	LX.TWN03.02 0	AAP	Japan	TM8172-5432G16nkk W7PR32JJP1 MC XPP UMACFkk_3 1*2G/160/ 6L2.8/5R/ bgn_FP_1.3C_AL_JA11FC524
TM8172-33U2G16nkk	LX.TWN03.01 9	AAP	Japan	TM8172-33U2G16nkk W7PR32JJP1 MC XPP UMACFkk_3 1*2G/160/ 6L2.8/5R/ bgn_FP_1.3C_AL_JA11_FC323
TM8172-5432G25nkk	LX.TWN03.01 8	AAP	Japan	TM8172-5432G25nkk W7PR32JJP1 MC XPP UMACFkk_3 1*2G/250/BT/ 6L2.8/5R/ bgn_FP_1.3C_AL_JA11_FC525
TM8172-5432G16nkk	LX.TWN03.01 7	AAP	Japan	TM8172-5432G16nkk W7PR32JJP1 MC XPP UMACFkk_3 1*2G/160/BT/ 6L2.8/5R/ bgn_FP_1.3C_AL_JA11_FC526
TM8172-33U2G16nkk	LX.TWN03.01 6	AAP	Japan	TM8172-33U2G16nkk W7PR32JJP1 MC XPP UMACFkk_3 1*2G/160/BT/ 6L2.8/5R/ bgn_FP_1.3C_AL_JA11_FC326

Model	Acer Part No	RO	Country	Description
TM8172-33U2G16nkk	LX.TWN03.015	AAP	Japan	TM8172-33U2G16nkk W7PR32TJP1 MC XPP UMACFkk_3 1*2G/160/6L2.8/5R/bgn_FP_1.3C_AL_JA11_FC324
TM8172-33U2G25nkk	LX.TWN03.014	AAP	Japan	TM8172-33U2G25nkk W7PR32TJP1 MC XPP UMACFkk_3 1*2G/250/BT/6L2.8/5R/bgn_FP_1.3C_AL_JA11_FC325
TM8172-33U3G32n	LX.TWN03.008	EMEA	Germany	TM8172-33U3G32n W7PR32TRDE1 MC XPP UMACFkk_3 2G+1G/320/BT/6L2.8/5R/bgn_FP_1.3C_AL_DE62
TM8172-33U2G32n	LX.TWN03.013	AAP	Singapore	TM8172-33U2G32n W7PR32TRSG1 MC XPP UMACFkk_3 1*2G/320/BT/6L2.2/5R/bgn_FP_1.3C_AL_ZH31
TM8172-52U3G32n	LX.TWN03.012	AAP	Singapore	TM8172-52U3G32n W7PR32TRSG1 MC XPP UMACFkk_3 2G+1G/320/BT/6L2.2/5R/bgn_FP_1.3C_AL_ZH31
TM8172-33U3G32n	LX.TWN03.011	AAP	Singapore	TM8172-33U3G32n W7PR32TRSG1 MC XPP UMACFkk_3 2G+1G/320/BT/6L2.2/5R/bgn_FP_1.3C_AL_ZH
TM8172-33U4G25n	S2.TWN03.004	WW	WW	TM8172-33U4G25n W7PR32TWW1 MC XPP UMACFkk_3 2*2G/250/BT/6L2.8/5R/bgn_FP_1.3C_AL_ES62
TM8172-33U2G25n	LX.TWN03.010	PA	USA	TM8172-33U2G25n W7PR32TRUS1 MC XPP UMACFkk_3 1*2G/250/BT/6L2.2/5R/bgn_FP_1.3C_AL_FRB3
TM8172-33U4G16n	LX.TWN03.009	AAP	Australia/New Zealand	TM8172-33U4G16n W7PR32TRAU1 MC XPP UMACFkk_3 2*2G/160/6L2.2/5R/bgn_FP_1.3C_AL_ES61
TM8172-33U4G25n	S2.TWN03.003	WW	WW	TM8172-33U4G25n W7PR32TWW1 MC UMACFkk_3 2*2G/250/BT/6L2.8/5R/bgn_FP_1.3C_AL_ES62
TM8172-33U2G25n	LX.TWN03.006	PA	USA	TM8172-33U2G25n W7PR32TRUS1 MC UMACFkk_3 1*2G/250/BT/6L2.2/5R/bgn_FP_1.3C_AL_FRB3
TM8172-33U2G25n	LX.TWN03.007	AAP	Australia/New Zealand	TM8172-33U2G25n W7PR32TRAU1 MC XPP UMACFkk_3 1*2G/250/6L2.2/5R/bgn_FP_1.3C_AL_ES61
TM8172-33U2G25n	LX.TWN03.005	PA	USA	TM8172-33U2G25n W7PR32TRUS1 MC UMACFkk_3 1*2G/250/6L2.2/5R/bgn_FP_1.3C_AL_FRB3
TM8172-52U4G50n	S2.TWN03.002	WW	WW	TM8172-52U4G50n W7PR32TWW1 MC UMACFkk_3 2*2G/500_L/BT/6L2.8/5R/bgn_FP_1.3C_AL_ES62
TM8172-52U2G32n	S2.TWN03.001	WW	WW	TM8172-52U2G32n W7PR32TWW1 MC UMACFkk_3 1*2G/320/BT/6L2.2/5R/bgn_FP_1.3C_AL_ES62
TM8172-33U1G16nk	LX.TWM03.011		Eastern Europe	TM8172-33U1G16nk W7PR32TREU7 MC UMACKk_3 1*1G/160/3L2.2/5R/bgn_1.3C_AL_ENQ2

Model	Acer Part No	RO	Country	Description
TM8172-5432G16nkk	LX.TWM03.010	AAP	Japan	TM8172-5432G16nkk W7PR32TJP1 MC XPP UMACKk_3 1*2G/160/BT/6L2.8/5R/bgn_1.3C_AL_JA11_CC526
TM8172-5432G16nkk	LX.TWM03.009	AAP	Japan	TM8172-5432G16nkk W7PR32TJP1 MC XPP UMACKk_3 1*2G/160/6L2.8/5R/bgn_1.3C_AL_JA11_CC524
TM8172-5432G25nkk	LX.TWM03.008	AAP	Japan	TM8172-5432G25nkk W7PR32TJP1 MC XPP UMACKk_3 1*2G/250/BT/6L2.8/5R/bgn_1.3C_AL_JA11_CC525
TM8172-33U2G25nkk	LX.TWM03.007	AAP	Japan	TM8172-33U2G25nkk W7PR32TJP1 MC XPP UMACKk_3 1*2G/250/6L2.8/5R/bgn_1.3C_AL_JA11_CC323
TM8172-33U2G16nkk	LX.TWM03.006	AAP	Japan	TM8172-33U2G16nkk W7PR32TJP1 MC XPP UMACKk_3 1*2G/160/6L2.8/5R/bgn_1.3C_AL_JA11_CC324
TM8172-33U2G25nkk	LX.TWM03.005	AAP	Japan	TM8172-33U2G25nkk W7PR32TJP1 MC XPP UMACKk_3 1*2G/250/BT/6L2.8/5R/bgn_1.3C_AL_JA11_CC325
TM8172-33U2G16nkk	LX.TWM03.004	AAP	Japan	TM8172-33U2G16nkk W7PR32TJP1 MC XPP UMACKk_3 1*2G/160/BT/6L2.8/5R/bgn_1.3C_AL_JA11_CC326
TM8172-33U2G25nkk	LX.TWM03.003	AAP	Japan	TM8172-33U2G25nkk W7PR32TJP1 MC XPP UMACKk_3 1*2G/250/6L2.8/5R/bgn_1.3C_AL_JA11_CC523
TM8172-33U2G16n	LX.TWM03.002	EMEA	Germany	TM8172-33U2G16n W7PR32TRDE1 MC UMACKk_3 1*2G/160/BT/6L2.2/5R/bgn_1.3C_AL_DE62
TM8172-33U2G32n	LX.TWM0C.001	EMEA	Austria	TM8172-33U2G32n LINPUS MTAT1 UMACKk_3 1*2G/320/6L2.2/5R/bgn_1.3C_AL_FRH1
TM8172-33U2G25n	LX.TWM03.001	EMEA	Denmark	TM8172-33U2G25n W7PR32TRDK2 MC UMACKk_3 1*2G/250/6L2.2/5R/bgn_1.3C_AL_ENS2
TM8172-52U1G16n	S2.TWM03.001	WW	WW	TM8172-52U1G16n W7PR32TWW1 MC UMACKk_3 1*1G/160/3L2.2/5R/bgn_1.3C_AL_ES62
TM8172-52U4G64nk	LX.TWS03.010	EMEA	South Africa	TM8172-52U4G64nk EM W7PR32EMTRZA2 MC XPP UMAGCFkk_3 2*2G/640/BT/6L2.2/5R/bgn_FP_1.3C_F33-900_AL_ES61
TM8172-52U4G50nk	LX.TWS03.009	EMEA	South Africa	TM8172-52U4G50nk EM W7PR32EMTRZA2 MC XPP UMAGCFkk_3 2*2G/500_L/BT/6L2.2/5R/bgn_FP_1.3C_F33-900_AL_ES61

Model	Acer Part No	RO	Country	Description
TM8172-52U4G32nk	LX.TWS03.008	EMEA	South Africa	TM8172-52U4G32nk EM W7PR32EMTRZA2 MC XPP UMAGCFkk_3 2*2G/320/BT/6L2.2/5R/bgn_FP_1.3C_F33-900_AL_ES6
TM8172-5434G32nk	LX.TWS03.007	EMEA	South Africa	TM8172-5434G32nk EM W7PR32EMTRZA2 MC XPP UMAGCFkk_3 2*2G/320/BT/6L2.2/5R/bgn_FP_1.3C_F33-900_AL_ES61
TM8172-5434G50nk	LX.TWS03.006	EMEA	South Africa	TM8172-5434G50nk EM W7PR32EMTRZA2 MC XPP UMAGCFkk_3 2*2G/500_L/BT/6L2.2/5R/bgn_FP_1.3C_F33-900_AL_ES61
TM8172-33U4G50nk	LX.TWS03.005	EMEA	South Africa	TM8172-33U4G50nk EM W7PR32EMTRZA2 MC XPP UMAGCFkk_3 2*2G/500_L/BT/6L2.2/5R/bgn_FP_1.3C_F33-900_AL_ES61
TM8172-33U4G32nk	LX.TWS03.004	EMEA	South Africa	TM8172-33U4G32nk EM W7PR32EMTRZA2 MC XPP UMAGCFkk_3 2*2G/320/BT/6L2.2/5R/bgn_FP_1.3C_F33-900_AL_ES61
TM8172-33U2G32nk	LX.TWS03.003	EMEA	South Africa	TM8172-33U2G32nk EM W7PR32EMTRZA2 MC XPP UMAGCFkk_3 1*2G/320/BT/6L2.2/5R/bgn_FP_1.3C_F33-900_AL_ES61
TM8172-33U2G25nk	LX.TWS03.002	EMEA	South Africa	TM8172-33U2G25nk EM W7PR32EMTRZA2 MC XPP UMAGCFkk_3 1*2G/250/BT/6L2.2/5R/bgn_FP_1.3C_F33-900_AL_ES61
TM8172-33U2G32n	LX.TWS03.001	AAP	Australia /New Zealand	TM8172-33U2G32n W7PR32TRAU1 MC XPP UMAGCFkk_3 1*2G/320/BT/6L2.2/5R/bgn_FP_1.3C_F33-900_AL_ES61
TM8172-33U4G32n	S2.TWS03.003	WW	WW	TM8172-33U4G32n W7PR32TWW1 MC XPP UMAGCFkk_3 2*2G/320/BT/6L2.8/5R/bgn_FP_1.3C_F33-900_AL_ES62
TM8172-33U4G32n	S2.TWS03.002	WW	WW	TM8172-33U4G32n W7PR32TWW1 MC UMAGCFkk_3 2*2G/320/BT/6L2.8/5R/bgn_FP_1.3C_F33-900_AL_ES62
TM8172-52U1G16n	S2.TWS03.001	WW	WW	TM8172-52U1G16n W7PR32TWW1 MC UMAGCFkk_3 1*1G/160/3L2.2/5R/bgn_FP_1.3C_F33-900_AL_ES62
TM8172-52U1G16n	S2.TWR03.001	WW	WW	TM8172-52U1G16n W7PR32TWW1 MC UMAGCkk_3 1*1G/160/3L2.2/5R/bgn_1.3C_F33-900_AL_ES62

Model	Acer Part No	CPU	LCD	VGA Chip	VRAM 1	Memory 1	Memory 2
TM8172Z-U542G25nkk	LX.TX903.002	PMDU 5400B	NLED1 1.6WX GA	UMA	N	SO2GBIII10	N
TM8172Z-U542G16nkk	LX.TX903.001	PMDU 5400B	NLED1 1.6WX GA	UMA	N	SO2GBIII10	N
TM8172Z-U542G25nkk	LX.TX903.004	PMDU 5400B	NLED1 1.6WX GA	UMA	N	SO2GBIII10	N
TM8172Z-U542G25nkk	LX.TX903.003	PMDU 5400B	NLED1 1.6WX GA	UMA	N	SO2GBIII10	N
TM8172Z-U542G25n	S2.TX903.001	PMDU 5400B	NLED1 1.6WX GA	UMA	N	SO2GBIII10	N
TM8172Z-U542G16nkk	LX.TXB03.001	PMDU 5400B	NLED1 1.6WX GA	UMA	N	SO2GBIII10	N
TM8172Z-U542G25nkk	LX.TXB03.004	PMDU 5400B	NLED1 1.6WX GA	UMA	N	SO2GBIII10	N
TM8172Z-U542G25nkk	LX.TXB03.002	PMDU 5400B	NLED1 1.6WX GA	UMA	N	SO2GBIII10	N
TM8172Z-U542G16nkk	LX.TXB03.003	PMDU 5400B	NLED1 1.6WX GA	UMA	N	SO2GBIII10	N
TM8172Z-U542G25n	S2.TXB03.001	PMDU 5400B	NLED1 1.6WX GA	UMA	N	SO2GBIII10	N
TM8172Z-U542G25n	S2.TX803.003	PMDU 5400B	NLED1 1.6WX GA	UMA	N	SO2GBIII10	N
TM8172Z-U542G25n	S2.TX803.002	PMDU 5400B	NLED1 1.6WX GA	UMA	N	SO2GBIII10	N
TM8172Z-U542G25n	S2.TX803.001	PMDU 5400B	NLED1 1.6WX GA	UMA	N	SO2GBIII10	N
TM8172Z-U542G25n	S2.TXA03.001	PMDU 5400B	NLED1 1.6WX GA	UMA	N	SO2GBIII10	N
TM8172-33U2G25nkk	LX.TWN02.002	Ci3330 UMB	NLED1 1.6WX GA	UMA	N	SO2GBIII10	N
TM8172-52U2G25nkk	LX.TWN02.001	Ci5520 UMB	NLED1 1.6WX GA	UMA	N	SO2GBIII10	N

Model	Acer Part No	CPU	LCD	VGA Chip	VRAM 1	Memory 1	Memory 2
TM8172-52U2G25nkk	LX.TWN03.003	Ci5520 UMB	NLED1 1.6WX GA	UMA	N	SO2GBIII10	N
TM8172-33U2G32nkk	LX.TWN03.004	Ci3330 UMB	NLED1 1.6WX GA	UMA	N	SO2GBIII10	N
TM8172-52U2G25nkk	LX.TWN03.002	Ci5520 UMB	NLED1 1.6WX GA	UMA	N	SO2GBIII10	N
TM8172-52U2G25nkk	LX.TWN03.001	Ci5520 UMB	NLED1 1.6WX GA	UMA	N	SO2GBIII10	N
TM8172-33U2G25nk	LX.TWN03.032	Ci3330 UMB	NLED1 1.6WX GA	UMA	N	SO2GBIII10	N
TM8172-33U4G25nk	LX.TWN03.031	Ci3330 UMB	NLED1 1.6WX GA	UMA	N	SO2GBIII10	SO2GBIII10
TM8172-33U4G32nk	LX.TWN03.030	Ci3330 UMB	NLED1 1.6WX GA	UMA	N	SO2GBIII10	SO2GBIII10
TM8172-33U4G50nk	LX.TWN03.029	Ci3330 UMB	NLED1 1.6WX GA	UMA	N	SO2GBIII10	SO2GBIII10
TM8172-5434G50nk	LX.TWN03.028	Ci5430 UMB	NLED1 1.6WX GA	UMA	N	SO2GBIII10	SO2GBIII10
TM8172-5434G32nk	LX.TWN03.027	Ci5430 UMB	NLED1 1.6WX GA	UMA	N	SO2GBIII10	SO2GBIII10
TM8172-52U4G32nk	LX.TWN03.026	Ci5520 UMB	NLED1 1.6WX GA	UMA	N	SO2GBIII10	SO2GBIII10
TM8172-52U4G50nk	LX.TWN03.025	Ci5520 UMB	NLED1 1.6WX GA	UMA	N	SO2GBIII10	SO2GBIII10
TM8172-52U2G50nk	LX.TWN03.024	Ci5520 UMB	NLED1 1.6WX GA	UMA	N	SO2GBIII10	N
TM8172-52U2G32nk	LX.TWN03.023	Ci5520 UMB	NLED1 1.6WX GA	UMA	N	SO2GBIII10	N
TM8172-52U2G25nk	LX.TWN03.022	Ci5520 UMB	NLED1 1.6WX GA	UMA	N	SO2GBIII10	N
TM8172-33U2G32nk	LX.TWN03.021	Ci3330 UMB	NLED1 1.6WX GA	UMA	N	SO2GBIII10	N
TM8172-5432G16nkk	LX.TWN03.020	Ci5430 UMB	NLED1 1.6WX GA	UMA	N	SO2GBIII10	N

Model	Acer Part No	CPU	LCD	VGA Chip	VRAM 1	Memory 1	Memory 2
TM8172-33U2G16nkk	LX.TWN03 .019	Ci3330 UMB	NLED1 1.6WX GA	UMA	N	SO2GBIII10	N
TM8172-5432G25nkk	LX.TWN03 .018	Ci5430 UMB	NLED1 1.6WX GA	UMA	N	SO2GBIII10	N
TM8172-5432G16nkk	LX.TWN03 .017	Ci5430 UMB	NLED1 1.6WX GA	UMA	N	SO2GBIII10	N
TM8172-33U2G16nkk	LX.TWN03 .016	Ci3330 UMB	NLED1 1.6WX GA	UMA	N	SO2GBIII10	N
TM8172-33U2G16nkk	LX.TWN03 .015	Ci3330 UMB	NLED1 1.6WX GA	UMA	N	SO2GBIII10	N
TM8172-33U2G25nkk	LX.TWN03 .014	Ci3330 UMB	NLED1 1.6WX GA	UMA	N	SO2GBIII10	N
TM8172-33U3G32n	LX.TWN03 .008	Ci3330 UMB	NLED1 1.6WX GA	UMA	N	SO2GBIII10	SO1GBIII10
TM8172-33U2G32n	LX.TWN03 .013	Ci3330 UMB	NLED1 1.6WX GA	UMA	N	SO2GBIII10	N
TM8172-52U3G32n	LX.TWN03 .012	Ci5520 UMB	NLED1 1.6WX GA	UMA	N	SO2GBIII10	SO1GBIII10
TM8172-33U3G32n	LX.TWN03 .011	Ci3330 UMB	NLED1 1.6WX GA	UMA	N	SO2GBIII10	SO1GBIII10
TM8172-33U4G25n	S2.TWN03 .004	Ci3330 UMB	NLED1 1.6WX GA	UMA	N	SO2GBIII10	SO2GBIII10
TM8172-33U2G25n	LX.TWN03 .010	Ci3330 UMB	NLED1 1.6WX GA	UMA	N	SO2GBIII10	N
TM8172-33U4G16n	LX.TWN03 .009	Ci3330 UMB	NLED1 1.6WX GA	UMA	N	SO2GBIII10	SO2GBIII10
TM8172-33U4G25n	S2.TWN03 .003	Ci3330 UMB	NLED1 1.6WX GA	UMA	N	SO2GBIII10	SO2GBIII10
TM8172-33U2G25n	LX.TWN03 .006	Ci3330 UMB	NLED1 1.6WX GA	UMA	N	SO2GBIII10	N
TM8172-33U2G25n	LX.TWN03 .007	Ci3330 UMB	NLED1 1.6WX GA	UMA	N	SO2GBIII10	N
TM8172-33U2G25n	LX.TWN03 .005	Ci3330 UMB	NLED1 1.6WX GA	UMA	N	SO2GBIII10	N

Model	Acer Part No	CPU	LCD	VGA Chip	VRAM 1	Memory 1	Memory 2
TM8172-52U4G50n	S2.TWN03.002	Ci5520 UMB	NLED1 1.6WX GA	UMA	N	SO2GBIII10	SO2GBIII10
TM8172-52U2G32n	S2.TWN03.001	Ci5520 UMB	NLED1 1.6WX GA	UMA	N	SO2GBIII10	N
TM8172-33U1G16nk	LX.TWM0 3.011	Ci3330 UMB	NLED1 1.6WX GA	UMA	N	SO1GBIII10	N
TM8172-5432G16nkk	LX.TWM0 3.010	Ci5430 UMB	NLED1 1.6WX GA	UMA	N	SO2GBIII10	N
TM8172-5432G16nkk	LX.TWM0 3.009	Ci5430 UMB	NLED1 1.6WX GA	UMA	N	SO2GBIII10	N
TM8172-5432G25nkk	LX.TWM0 3.008	Ci5430 UMB	NLED1 1.6WX GA	UMA	N	SO2GBIII10	N
TM8172-33U2G25nkk	LX.TWM0 3.007	Ci3330 UMB	NLED1 1.6WX GA	UMA	N	SO2GBIII10	N
TM8172-33U2G16nkk	LX.TWM0 3.006	Ci3330 UMB	NLED1 1.6WX GA	UMA	N	SO2GBIII10	N
TM8172-33U2G25nkk	LX.TWM0 3.005	Ci3330 UMB	NLED1 1.6WX GA	UMA	N	SO2GBIII10	N
TM8172-33U2G16nkk	LX.TWM0 3.004	Ci3330 UMB	NLED1 1.6WX GA	UMA	N	SO2GBIII10	N
TM8172-33U2G25nkk	LX.TWM0 3.003	Ci3330 UMB	NLED1 1.6WX GA	UMA	N	SO2GBIII10	N
TM8172-33U2G16n	LX.TWM0 3.002	Ci3330 UMB	NLED1 1.6WX GA	UMA	N	SO2GBIII10	N
TM8172-33U2G32n	LX.TWM0 C.001	Ci3330 UMB	NLED1 1.6WX GA	UMA	N	SO2GBIII10	N
TM8172-33U2G25n	LX.TWM0 3.001	Ci3330 UMB	NLED1 1.6WX GA	UMA	N	SO2GBIII10	N
TM8172-52U1G16n	S2.TWM0 3.001	Ci5520 UMB	NLED1 1.6WX GA	UMA	N	SO1GBIII10	N
TM8172-52U4G64nk	LX.TWS03 .010	Ci5520 UMB	NLED1 1.6WX GA	UMA	N	SO2GBIII10	SO2GBIII10
TM8172-52U4G50nk	LX.TWS03 .009	Ci5520 UMB	NLED1 1.6WX GA	UMA	N	SO2GBIII10	SO2GBIII10

Model	Acer Part No	CPU	LCD	VGA Chip	VRAM 1	Memory 1	Memory 2
TM8172-52U4G32nk	LX.TWS03.008	Ci5520 UMB	NLED1 1.6WX GA	UMA	N	SO2GBIII10	SO2GBIII10
TM8172-5434G32nk	LX.TWS03.007	Ci5430 UMB	NLED1 1.6WX GA	UMA	N	SO2GBIII10	SO2GBIII10
TM8172-5434G50nk	LX.TWS03.006	Ci5430 UMB	NLED1 1.6WX GA	UMA	N	SO2GBIII10	SO2GBIII10
TM8172-33U4G50nk	LX.TWS03.005	Ci3330 UMB	NLED1 1.6WX GA	UMA	N	SO2GBIII10	SO2GBIII10
TM8172-33U4G32nk	LX.TWS03.004	Ci3330 UMB	NLED1 1.6WX GA	UMA	N	SO2GBIII10	SO2GBIII10
TM8172-33U2G32nk	LX.TWS03.003	Ci3330 UMB	NLED1 1.6WX GA	UMA	N	SO2GBIII10	N
TM8172-33U2G25nk	LX.TWS03.002	Ci3330 UMB	NLED1 1.6WX GA	UMA	N	SO2GBIII10	N
TM8172-33U2G32n	LX.TWS03.001	Ci3330 UMB	NLED1 1.6WX GA	UMA	N	SO2GBIII10	N
TM8172-33U4G32n	S2.TWS03.003	Ci3330 UMB	NLED1 1.6WX GA	UMA	N	SO2GBIII10	SO2GBIII10
TM8172-33U4G32n	S2.TWS03.002	Ci3330 UMB	NLED1 1.6WX GA	UMA	N	SO2GBIII10	SO2GBIII10
TM8172-52U1G16n	S2.TWS03.001	Ci5520 UMB	NLED1 1.6WX GA	UMA	N	SO1GBIII10	N
TM8172-52U1G16n	S2.TWR03.001	Ci5520 UMB	NLED1 1.6WX GA	UMA	N	SO1GBIII10	N

Model	Acer Part No	Memory 3	Memory 4	HDD 1(GB)	HDD 2(GB)	ODD	Media Processor
TM8172Z-U542G25nk	LX.TX903.002	N	N	N250GB5.4KS	N	N	N
TM8172Z-U542G16nk	LX.TX903.001	N	N	N160GB5.4KS	N	N	N
TM8172Z-U542G25nk	LX.TX903.004	N	N	N250GB5.4KS	N	N	N

Model	Acer Part No	Memory 3	Memory 4	HDD 1(GB)	HDD 2(GB)	ODD	Media Processor
TM8172Z-U542G25nk	LX.TX903.003	N	N	N250GB5.4KS	N	N	N
TM8172Z-U542G25n	S2.TX903.001	N	N	N250GB5.4KS	N	N	N
TM8172Z-U542G16nk	LX.TXB03.001	N	N	N160GB5.4KS	N	N	N
TM8172Z-U542G25nk	LX.TXB03.004	N	N	N250GB5.4KS	N	N	N
TM8172Z-U542G25nk	LX.TXB03.002	N	N	N250GB5.4KS	N	N	N
TM8172Z-U542G16nk	LX.TXB03.003	N	N	N160GB5.4KS	N	N	N
TM8172Z-U542G25n	S2.TXB03.001	N	N	N250GB5.4KS	N	N	N
TM8172Z-U542G25n	S2.TX803.003	N	N	N250GB5.4KS	N	N	N
TM8172Z-U542G25n	S2.TX803.002	N	N	N250GB5.4KS	N	N	N
TM8172Z-U542G25n	S2.TX803.001	N	N	N250GB5.4KS	N	N	N
TM8172Z-U542G25n	S2.TXA03.001	N	N	N250GB5.4KS	N	N	N
TM8172-33U2G25nk	LX.TWN02.002	N	N	N250GB5.4KS	N	N	N
TM8172-52U2G25nk	LX.TWN02.001	N	N	N250GB5.4KS	N	N	N
TM8172-52U2G25nk	LX.TWN03.003	N	N	N250GB5.4KS	N	N	N
TM8172-33U2G32nk	LX.TWN03.004	N	N	N320GB5.4KS	N	N	N
TM8172-52U2G25nk	LX.TWN03.002	N	N	N250GB5.4KS	N	N	N
TM8172-52U2G25nk	LX.TWN03.001	N	N	N250GB5.4KS	N	N	N
TM8172-33U2G25nk	LX.TWN03.032	N	N	N250GB5.4KS	N	N	N
TM8172-33U4G25nk	LX.TWN03.031	N	N	N250GB5.4KS	N	N	N
TM8172-33U4G32nk	LX.TWN03.030	N	N	N320GB5.4KS	N	N	N

Model	Acer Part No	Memory 3	Memory 4	HDD 1(GB)	HDD 2(GB)	ODD	Media Processor
TM8172-33U4G50nk	LX.TWN0 3.029	N	N	N500GB5 .4KS	N	N	N
TM8172-5434G50nk	LX.TWN0 3.028	N	N	N500GB5 .4KS	N	N	N
TM8172-5434G32nk	LX.TWN0 3.027	N	N	N320GB5 .4KS	N	N	N
TM8172-52U4G32nk	LX.TWN0 3.026	N	N	N320GB5 .4KS	N	N	N
TM8172-52U4G50nk	LX.TWN0 3.025	N	N	N500GB5 .4KS	N	N	N
TM8172-52U2G50nk	LX.TWN0 3.024	N	N	N500GB5 .4KS	N	N	N
TM8172-52U2G32nk	LX.TWN0 3.023	N	N	N320GB5 .4KS	N	N	N
TM8172-52U2G25nk	LX.TWN0 3.022	N	N	N250GB5 .4KS	N	N	N
TM8172-33U2G32nk	LX.TWN0 3.021	N	N	N320GB5 .4KS	N	N	N
TM8172-5432G16nkk	LX.TWN0 3.020	N	N	N160GB5 .4KS	N	N	N
TM8172-33U2G16nk k	LX.TWN0 3.019	N	N	N160GB5 .4KS	N	N	N
TM8172-5432G25nkk	LX.TWN0 3.018	N	N	N250GB5 .4KS	N	N	N
TM8172-5432G16nkk	LX.TWN0 3.017	N	N	N160GB5 .4KS	N	N	N
TM8172-33U2G16nk k	LX.TWN0 3.016	N	N	N160GB5 .4KS	N	N	N
TM8172-33U2G16nk k	LX.TWN0 3.015	N	N	N160GB5 .4KS	N	N	N
TM8172-33U2G25nk k	LX.TWN0 3.014	N	N	N250GB5 .4KS	N	N	N
TM8172-33U3G32n	LX.TWN0 3.008	N	N	N320GB5 .4KS	N	N	N
TM8172-33U2G32n	LX.TWN0 3.013	N	N	N320GB5 .4KS	N	N	N
TM8172-52U3G32n	LX.TWN0 3.012	N	N	N320GB5 .4KS	N	N	N
TM8172-33U3G32n	LX.TWN0 3.011	N	N	N320GB5 .4KS	N	N	N
TM8172-33U4G25n	S2.TWN0 3.004	N	N	N250GB5 .4KS	N	N	N
TM8172-33U2G25n	LX.TWN0 3.010	N	N	N250GB5 .4KS	N	N	N
TM8172-33U4G16n	LX.TWN0 3.009	N	N	N160GB5 .4KS	N	N	N

Model	Acer Part No	Memory 3	Memory 4	HDD 1(GB)	HDD 2(GB)	ODD	Media Processor
TM8172-33U4G25n	S2.TWN0 3.003	N	N	N250GB5.4KS	N	N	N
TM8172-33U2G25n	LX.TWN0 3.006	N	N	N250GB5.4KS	N	N	N
TM8172-33U2G25n	LX.TWN0 3.007	N	N	N250GB5.4KS	N	N	N
TM8172-33U2G25n	LX.TWN0 3.005	N	N	N250GB5.4KS	N	N	N
TM8172-52U4G50n	S2.TWN0 3.002	N	N	N500GB5.4KS	N	N	N
TM8172-52U2G32n	S2.TWN0 3.001	N	N	N320GB5.4KS	N	N	N
TM8172-33U1G16nk	LX.TWM0 3.011	N	N	N160GB5.4KS	N	N	N
TM8172-5432G16nkk	LX.TWM0 3.010	N	N	N160GB5.4KS	N	N	N
TM8172-5432G16nkk	LX.TWM0 3.009	N	N	N160GB5.4KS	N	N	N
TM8172-5432G25nkk	LX.TWM0 3.008	N	N	N250GB5.4KS	N	N	N
TM8172-33U2G25nk	LX.TWM0 3.007	N	N	N250GB5.4KS	N	N	N
TM8172-33U2G16nk	LX.TWM0 3.006	N	N	N160GB5.4KS	N	N	N
TM8172-33U2G25nk	LX.TWM0 3.005	N	N	N250GB5.4KS	N	N	N
TM8172-33U2G16nk	LX.TWM0 3.004	N	N	N160GB5.4KS	N	N	N
TM8172-33U2G25nk	LX.TWM0 3.003	N	N	N250GB5.4KS	N	N	N
TM8172-33U2G16n	LX.TWM0 3.002	N	N	N160GB5.4KS	N	N	N
TM8172-33U2G32n	LX.TWM0 C.001	N	N	N320GB5.4KS	N	N	N
TM8172-33U2G25n	LX.TWM0 3.001	N	N	N250GB5.4KS	N	N	N
TM8172-52U1G16n	S2.TWM0 3.001	N	N	N160GB5.4KS	N	N	N
TM8172-52U4G64nk	LX.TWS0 3.010	N	N	N640GB5.4KS	N	N	N
TM8172-52U4G50nk	LX.TWS0 3.009	N	N	N500GB5.4KS	N	N	N
TM8172-52U4G32nk	LX.TWS0 3.008	N	N	N320GB5.4KS	N	N	N

Model	Acer Part No	Memory 3	Memory 4	HDD 1(GB)	HDD 2(GB)	ODD	Media Processor
TM8172-5434G32nk	LX.TWS0 3.007	N	N	N320GB5.4KS	N	N	N
TM8172-5434G50nk	LX.TWS0 3.006	N	N	N500GB5.4KS	N	N	N
TM8172-33U4G50nk	LX.TWS0 3.005	N	N	N500GB5.4KS	N	N	N
TM8172-33U4G32nk	LX.TWS0 3.004	N	N	N320GB5.4KS	N	N	N
TM8172-33U2G32nk	LX.TWS0 3.003	N	N	N320GB5.4KS	N	N	N
TM8172-33U2G25nk	LX.TWS0 3.002	N	N	N250GB5.4KS	N	N	N
TM8172-33U2G32n	LX.TWS0 3.001	N	N	N320GB5.4KS	N	N	N
TM8172-33U4G32n	S2.TWS0 3.003	N	N	N320GB5.4KS	N	N	N
TM8172-33U4G32n	S2.TWS0 3.002	N	N	N320GB5.4KS	N	N	N
TM8172-52U1G16n	S2.TWS0 3.001	N	N	N160GB5.4KS	N	N	N
TM8172-52U1G16n	S2.TWR0 3.001	N	N	N160GB5.4KS	N	N	N

Model	Acer Part No	Extra SW1	Card Reader	Wireless LAN1	Bluetooth	VOIP Phone	Finger Print
TM8172Z-U542G25nk	LX.TX903 .002	McAfee	5 in 1-Build in	3rd WiFi 2x2 BGN	N	N	AES1660
TM8172Z-U542G16nk	LX.TX903 .001	McAfee	5 in 1-Build in	3rd WiFi 2x2 BGN	BT 3.0	N	AES1660
TM8172Z-U542G25nk	LX.TX903 .004	McAfee	5 in 1-Build in	3rd WiFi 2x2 BGN	N	N	AES1660
TM8172Z-U542G25nk	LX.TX903 .003	McAfee	5 in 1-Build in	3rd WiFi 2x2 BGN	BT 3.0	N	AES1660
TM8172Z-U542G25n	S2.TX903 .001	McAfee	5 in 1-Build in	3rd WiFi 2x2 BGN	N	N	AES1660
TM8172Z-U542G16nk	LX.TXB03 .001	McAfee	5 in 1-Build in	3rd WiFi 2x2 BGN	BT 3.0	N	N
TM8172Z-U542G25nk	LX.TXB03 .004	McAfee	5 in 1-Build in	3rd WiFi 2x2 BGN	N	N	N

Model	Acer Part No	Extra SW1	Card Reader	Wireless LAN1	Bluetooth	VOIP Phone	Finger Print
TM8172Z-U542G25nk	LX.TXB03.002	McAfee	5 in 1-Build in	3rd WiFi 2x2 BGN	BT 3.0	N	N
TM8172Z-U542G16nk	LX.TXB03.003	McAfee	5 in 1-Build in	3rd WiFi 2x2 BGN	N	N	N
TM8172Z-U542G25n	S2.TXB03.001	McAfee	5 in 1-Build in	3rd WiFi 2x2 BGN	N	N	N
TM8172Z-U542G25n	S2.TX803.003	McAfee	5 in 1-Build in	3rd WiFi 2x2 BGN	BT 3.0	N	AES1660
TM8172Z-U542G25n	S2.TX803.002	McAfee	5 in 1-Build in	3rd WiFi 2x2 BGN	BT 3.0	N	AES1660
TM8172Z-U542G25n	S2.TX803.001	McAfee	5 in 1-Build in	3rd WiFi 2x2 BGN	N	N	AES1660
TM8172Z-U542G25n	S2.TXA03.001	McAfee	5 in 1-Build in	3rd WiFi 2x2 BGN	N	N	N
TM8172-33U2G25nk	LX.TWN0 2.002	McAfee	5 in 1-Build in	3rd WiFi 2x2 BGN	BT 3.0	N	AES1660
TM8172-52U2G25nk	LX.TWN0 2.001	McAfee	5 in 1-Build in	3rd WiFi 2x2 BGN	BT 3.0	N	AES1660
TM8172-52U2G25nk	LX.TWN0 3.003	McAfee	5 in 1-Build in	3rd WiFi 2x2 BGN	BT 3.0	N	AES1660
TM8172-33U2G32nk	LX.TWN0 3.004	McAfee	5 in 1-Build in	3rd WiFi 2x2 BGN	BT 3.0	N	AES1660
TM8172-52U2G25nk	LX.TWN0 3.002	McAfee	5 in 1-Build in	3rd WiFi 2x2 BGN	N	N	AES1660
TM8172-52U2G25nk	LX.TWN0 3.001	McAfee	5 in 1-Build in	3rd WiFi 2x2 BGN	BT 3.0	N	AES1660
TM8172-33U2G25nk	LX.TWN0 3.032	McAfee	5 in 1-Build in	3rd WiFi 2x2 BGN	BT 3.0	N	AES1660
TM8172-33U4G25nk	LX.TWN0 3.031	McAfee	5 in 1-Build in	3rd WiFi 2x2 BGN	BT 3.0	N	AES1660
TM8172-33U4G32nk	LX.TWN0 3.030	McAfee	5 in 1-Build in	3rd WiFi 2x2 BGN	BT 3.0	N	AES1660
TM8172-33U4G50nk	LX.TWN0 3.029	McAfee	5 in 1-Build in	3rd WiFi 2x2 BGN	BT 3.0	N	AES1660
TM8172-5434G50nk	LX.TWN0 3.028	McAfee	5 in 1-Build in	3rd WiFi 2x2 BGN	BT 3.0	N	AES1660
TM8172-5434G32nk	LX.TWN0 3.027	McAfee	5 in 1-Build in	3rd WiFi 2x2 BGN	BT 3.0	N	AES1660

Model	Acer Part No	Extra SW1	Card Reader	Wireless LAN1	Bluetooth	VOIP Phone	Finger Print
TM8172-52U4G32nk	LX.TWN0 3.026	McAfee	5 in 1-Build in	3rd WiFi 2x2 BGN	BT 3.0	N	AES1660
TM8172-52U4G50nk	LX.TWN0 3.025	McAfee	5 in 1-Build in	3rd WiFi 2x2 BGN	BT 3.0	N	AES1660
TM8172-52U2G50nk	LX.TWN0 3.024	McAfee	5 in 1-Build in	3rd WiFi 2x2 BGN	BT 3.0	N	AES1660
TM8172-52U2G32nk	LX.TWN0 3.023	McAfee	5 in 1-Build in	3rd WiFi 2x2 BGN	BT 3.0	N	AES1660
TM8172-52U2G25nk	LX.TWN0 3.022	McAfee	5 in 1-Build in	3rd WiFi 2x2 BGN	BT 3.0	N	AES1660
TM8172-33U2G32nk	LX.TWN0 3.021	McAfee	5 in 1-Build in	3rd WiFi 2x2 BGN	BT 3.0	N	AES1660
TM8172-5432G16nkk	LX.TWN0 3.020	McAfee	5 in 1-Build in	3rd WiFi 2x2 BGN	N	N	AES1660
TM8172-33U2G16nk k	LX.TWN0 3.019	McAfee	5 in 1-Build in	3rd WiFi 2x2 BGN	N	N	AES1660
TM8172-5432G25nkk	LX.TWN0 3.018	McAfee	5 in 1-Build in	3rd WiFi 2x2 BGN	BT 3.0	N	AES1660
TM8172-5432G16nkk	LX.TWN0 3.017	McAfee	5 in 1-Build in	3rd WiFi 2x2 BGN	BT 3.0	N	AES1660
TM8172-33U2G16nk k	LX.TWN0 3.016	McAfee	5 in 1-Build in	3rd WiFi 2x2 BGN	BT 3.0	N	AES1660
TM8172-33U2G16nk k	LX.TWN0 3.015	McAfee	5 in 1-Build in	3rd WiFi 2x2 BGN	N	N	AES1660
TM8172-33U2G25nk k	LX.TWN0 3.014	McAfee	5 in 1-Build in	3rd WiFi 2x2 BGN	BT 3.0	N	AES1660
TM8172-33U3G32n	LX.TWN0 3.008	McAfee	5 in 1-Build in	3rd WiFi 2x2 BGN	BT 3.0	N	AES1660
TM8172-33U2G32n	LX.TWN0 3.013	McAfee	5 in 1-Build in	3rd WiFi 2x2 BGN	BT 3.0	N	AES1660
TM8172-52U3G32n	LX.TWN0 3.012	McAfee	5 in 1-Build in	3rd WiFi 2x2 BGN	BT 3.0	N	AES1660
TM8172-33U3G32n	LX.TWN0 3.011	McAfee	5 in 1-Build in	3rd WiFi 2x2 BGN	BT 3.0	N	AES1660
TM8172-33U4G25n	S2.TWN0 3.004	McAfee	5 in 1-Build in	3rd WiFi 2x2 BGN	BT 3.0	N	AES1660
TM8172-33U2G25n	LX.TWN0 3.010	McAfee	5 in 1-Build in	3rd WiFi 2x2 BGN	BT 3.0	N	AES1660
TM8172-33U4G16n	LX.TWN0 3.009	McAfee	5 in 1-Build in	3rd WiFi 2x2 BGN	N	N	AES1660
TM8172-33U4G25n	S2.TWN0 3.003	McAfee	5 in 1-Build in	3rd WiFi 2x2 BGN	BT 3.0	N	AES1660
TM8172-33U2G25n	LX.TWN0 3.006	McAfee	5 in 1-Build in	3rd WiFi 2x2 BGN	BT 3.0	N	AES1660

Model	Acer Part No	Extra SW1	Card Reader	Wireless LAN1	Bluetooth	VOIP Phone	Finger Print
TM8172-33U2G25n	LX.TWN0 3.007	McAfee	5 in 1-Build in	3rd WiFi 2x2 BGN	N	N	AES1660
TM8172-33U2G25n	LX.TWN0 3.005	McAfee	5 in 1-Build in	3rd WiFi 2x2 BGN	N	N	AES1660
TM8172-52U4G50n	S2.TWN0 3.002	McAfee	5 in 1-Build in	3rd WiFi 2x2 BGN	BT 2.1	N	AES1660
TM8172-52U2G32n	S2.TWN0 3.001	McAfee	5 in 1-Build in	3rd WiFi 2x2 BGN	BT 2.1	N	AES1660
TM8172-33U1G16nk	LX.TWM0 3.011	McAfee	5 in 1-Build in	3rd WiFi 2x2 BGN	N	N	N
TM8172-5432G16nkk	LX.TWM0 3.010	McAfee	5 in 1-Build in	3rd WiFi 2x2 BGN	BT 3.0	N	N
TM8172-5432G16nkk	LX.TWM0 3.009	McAfee	5 in 1-Build in	3rd WiFi 2x2 BGN	N	N	N
TM8172-5432G25nkk	LX.TWM0 3.008	McAfee	5 in 1-Build in	3rd WiFi 2x2 BGN	BT 3.0	N	N
TM8172-33U2G25nk	LX.TWM0 3.007	McAfee	5 in 1-Build in	3rd WiFi 2x2 BGN	N	N	N
TM8172-33U2G16nk	LX.TWM0 3.006	McAfee	5 in 1-Build in	3rd WiFi 2x2 BGN	N	N	N
TM8172-33U2G25nk	LX.TWM0 3.005	McAfee	5 in 1-Build in	3rd WiFi 2x2 BGN	BT 3.0	N	N
TM8172-33U2G16nk	LX.TWM0 3.004	McAfee	5 in 1-Build in	3rd WiFi 2x2 BGN	BT 3.0	N	N
TM8172-33U2G25nk	LX.TWM0 3.003	McAfee	5 in 1-Build in	3rd WiFi 2x2 BGN	N	N	N
TM8172-33U2G16n	LX.TWM0 3.002	McAfee	5 in 1-Build in	3rd WiFi 2x2 BGN	BT 3.0	N	N
TM8172-33U2G32n	LX.TWM0 C.001	McAfee	5 in 1-Build in	3rd WiFi 2x2 BGN	N	N	N
TM8172-33U2G25n	LX.TWM0 3.001	McAfee	5 in 1-Build in	3rd WiFi 2x2 BGN	N	N	N
TM8172-52U1G16n	S2.TWM0 3.001	McAfee	5 in 1-Build in	3rd WiFi 2x2 BGN	N	N	N
TM8172-52U4G64nk	LX.TWS0 3.010	McAfee	5 in 1-Build in	3rd WiFi 2x2 BGN	BT 3.0	N	AES1660
TM8172-52U4G50nk	LX.TWS0 3.009	McAfee	5 in 1-Build in	3rd WiFi 2x2 BGN	BT 3.0	N	AES1660
TM8172-52U4G32nk	LX.TWS0 3.008	McAfee	5 in 1-Build in	3rd WiFi 2x2 BGN	BT 3.0	N	AES1660
TM8172-5434G32nk	LX.TWS0 3.007	McAfee	5 in 1-Build in	3rd WiFi 2x2 BGN	BT 3.0	N	AES1660
TM8172-5434G50nk	LX.TWS0 3.006	McAfee	5 in 1-Build in	3rd WiFi 2x2 BGN	BT 3.0	N	AES1660

Model	Acer Part No	Extra SW1	Card Reader	Wireless LAN1	Bluetooth	VOIP Phone	Finger Print
TM8172-33U4G50nk	LX.TWS0 3.005	McAfee	5 in 1-Build in	3rd WiFi 2x2 BGN	BT 3.0	N	AES1660
TM8172-33U4G32nk	LX.TWS0 3.004	McAfee	5 in 1-Build in	3rd WiFi 2x2 BGN	BT 3.0	N	AES1660
TM8172-33U2G32nk	LX.TWS0 3.003	McAfee	5 in 1-Build in	3rd WiFi 2x2 BGN	BT 3.0	N	AES1660
TM8172-33U2G25nk	LX.TWS0 3.002	McAfee	5 in 1-Build in	3rd WiFi 2x2 BGN	BT 3.0	N	AES1660
TM8172-33U2G32n	LX.TWS0 3.001	McAfee	5 in 1-Build in	3rd WiFi 2x2 BGN	BT 3.0	N	AES1660
TM8172-33U4G32n	S2.TWS0 3.003	McAfee	5 in 1-Build in	3rd WiFi 2x2 BGN	BT 3.0	N	AES1660
TM8172-33U4G32n	S2.TWS0 3.002	McAfee	5 in 1-Build in	3rd WiFi 2x2 BGN	BT 3.0	N	AES1660
TM8172-52U1G16n	S2.TWS0 3.001	McAfee	5 in 1-Build in	3rd WiFi 2x2 BGN	N	N	AES1660
TM8172-52U1G16n	S2.TWR0 3.001	McAfee	5 in 1-Build in	3rd WiFi 2x2 BGN	N	N	N

Test Compatible Components

This computer's compatibility is tested and verified by Acer's internal testing department. All of its system functions are tested under Windows® 7 environment.

Refer to the following lists for components, adapter cards, and peripherals which have passed these tests.

Regarding configuration, combination and test procedures, please refer to the TravelMate 8172/8172Z

Compatibility Test Report released by the Acer Mobile System Testing Department.

Microsoft® Windows® 7 Environment Test

Vendor	Type	Description	PN
CPU			
Intel	Core i5-540UM	CPU Intel Core i5 540UM BGA 1.20G 18W	
Intel	Core i5-520UM	CPU Intel Core i5 520UM BGA 1.06G 18W	
Intel	Core i5-430UM	CPU Intel Core i5 430UM BGA 1.20G 18W	
Intel	Ci3330UMB	CPU Intel Core i3 330UM BGA 1.2G 18W K-0 no Turbo Boost	
Intel	CMU3400B	CPU Intel Celeron U3400 BGA 1.06G 18W K-0	
Intel	PMDU5400B	CPU Intel Pentium Dual-Core U5400 BGA 1.2G 18W K-0	
Chipset			
Intel	PCH	HM55 (4MB SPI)	
Main Chip			
Broadcom	LAN Controller	Broadcom BCM57760	
Conexant	Audio	Conexant CX20672-11Z	
Infineon	TPM	Infineon SLB9635TT1.2 TPM 1.2	
Realtek	Card Reader	RTS5128	
Panel			
AUO	11.6"/WXGA/ Glare	LED LCD AUO 11.6" WXGA Glare B116XW02 V0 8ms 500:1	
LG		LED LCD LPL 11.6" WXGA Glare LP116WH1-TLN1 LF 200nit 8ms 500:1	
CMO		LED LCD CMO 11.6" WXGA Glare N116B6-L02 C2 LF 200nit 10ms 500:1	
SAMSUNG		LED LCD SAMSUNG 11.6" WXGA Glare LTN116AT03-A01 LF 200nit 16ms 500:1	
AUO		11.6"/WXGA/ non-Glare	LED LCD AUO 11.6" WXGA non - Glare B116XW02 V1 8ms 500:1
SAMSUNG	LED LCD SAMSUNG 11.6" WXGA None Glare LTN116AT03-002 LF 200nit 16ms 300:1		
Memory			
ELPIDA	1GB/1066/ DDRIII	Memory ELPIDA SO-DIMM DDRIII 1066 1GB EBJ10UE8BDS0-AE-F LF 128*8 0.065um	
SAMSUNG		Memory SAMSUNG SO-DIMM DDRIII 1066 1GB M471B2873EH1-CF8 LF 64*16 0.055um	
HYNIX		Memory HYNIX SO-DIMM DDRIII 1066 1GB HMT112S6BFR6C-G7 N0 LF 64*16 0.055um	

Vendor	Type	Description	PN
ELPIDA	1GB/1333/ DDRIII	Memory ELPIDA SO-DIMM DDRIII 1333 1GB EBJ10UE8BDS0-DJ-F LF 128*8 0.065um	
HYNIX		Memory HYNIX SO-DIMM DDRIII 1333 1GB HMT112S6TFR8C-H9 LF 128*8 0.055um	
SAMSUNG		Memory SAMSUNG SO-DIMM DDRIII 1333 1GB M471B2873FHS-CH9 LF 128*8 46nm	
KINGSTON	2GB/1066/ DDRIII	Memory KINGSTON SO-DIMM DDRIII 1066 2GB ACR256X64D3S1066C7 LF 128*8 0.07um	
ELPIDA		Memory ELPIDA SO-DIMM DDRIII 1066 2GB EBJ21UE8BDS0-AE-F LF 128*8 0.065um	
A-DATA		Memory A-DATA SO-DIMM DDRIII 1066 2GB HY7YG1B1674ZM LF 128*8 0.065um	
HYNIX		Memory HYNIX SO-DIMM DDRIII 1066 2GB HMT125S6BFR8C-G7 N0 LF 128*8 0.055um	
NANYA		Memory NANYA SO-DIMM DDRIII 1333 2GB NT2GC64B8HC0NS-CG LF 128*8 0.065um	
KINGSTON	2GB/1333/ DDRIII	Memory KINGSTON SO-DIMM DDRIII 1333 2GB ACR256X64D3S1333C9 LF 128*8 0.065um	
HYNIX		Memory HYNIX SO-DIMM DDRIII 1333 2GB HMT125S6TFR8C-H9 LF 128*8 0.055um	
ELPIDA		Memory ELPIDA SO-DIMM DDRIII 1333 2GB EBJ21UE8BDS0-DJ-F LF 128*8 0.065um	
SAMSUNG		Memory SAMSUNG SO-DIMM DDRIII 1333 2GB M471B5673FH0-CH9 LF 128*8 46nm	
HDD			
SEAGATE	160GB/ 5400rpm	HDD SEAGATE 2.5" 5400rpm 160GB ST9160314AS Wyatt SATA LF F/ W:0001SDM1	
TOSHIBA DIGI		HDD TOSHIBA 2.5" 5400rpm 160GB MK1665GSX, Capricorn BS, 320G/P SATA 8MB LF F/W:GJ002J	
HGST		HDD HGST 2.5" 5400rpm 160GB HTS545016B9A300 Panther B SATA LF F/W:C60F Disk imbalance criteria = 0.014g-cm	
WD		HDD WD 2.5" 5400rpm 160GB WD1600BEVT-22A23T0 , WD, ML320S SATA 8MB LF F/W:01.01A01	
SEAGATE	250GB/ 5400rpm	HDD SEAGATE 2.5" 5400rpm 250GB ST9250315AS Wyatt SATA LF F/ W:0001SDM1	

Vendor	Type	Description	PN
TOSHIBA DIGI		HDD TOSHIBA 2.5" 5400rpm 250GB MK2565GSX, Capricorn BS, 320G/P SATA 8MB LF F/W:GJ002J	
HGST SG		HDD HGST 2.5" 5400rpm 250GB HTS545025B9A300 Panther B SATA LF F/W:C60F Disk imbalance criteria = 0.014g-cm	
WD		HDD WD 2.5" 5400rpm 250GB WD2500BEVT-22A23T0, WD, ML320S SATA 8MB LF F/W:01.01A01.	
SEAGATE	250GB/ 7200rpm	HDD SEAGATE 2.5" 7200rpm 250GB ST9250410AS Holiday SATA LF F/W:0002SDM1	
HGST		HDD HGST 2.5" 7200rpm 250GB HTS725025A9A364 SATA 8MB LF F/W:C70E	
SEAGATE	320GB/ 5400rpm	HDD SEAGATE 2.5" 5400rpm 320GB ST9320325AS Wyatt SATA LF F/W:0001SDM1	
TOSHIBA DIGI		HDD TOSHIBA 2.5" 5400rpm 320GB Capricorn BS ,MK3265GSX SATA 8MB LF F/W:GJ002J	
HGST SG		HDD HGST 2.5" 5400rpm 320GB HTS545032B9A300 Panther B SATA LF F/W:C60F Disk imbalance criteria = 0.014g-cm	
WD		HDD WD 2.5" 5400rpm 320GB WD3200BEVT-22A23T0,ML320S,WD SATA 8MB LF F/W:01.01A01	
SEAGATE	320GB/ 7200rpm	HDD SEAGATE 2.5" 7200rpm 320GB ST9320423AS Holiday SATA LF F/W:0002SDM1	
HGST		HDD HGST 2.5" 7200rpm 320GB HTS725032A9A364 SATA 8MB LF F/W:C70E	
SEAGATE	500GB/ 5400rpm	HDD SEAGATE 2.5" 5400rpm 500GB ST9500325AS Wyatt SATA LF F/W:0001SDM1	
TOSHIBA		HDD TOSHIBA 2.5" 5400rpm 500GB MK5065GSX,Capricorn BS, 320G/P SATA 8MB LF F/W:GJ002J	
HGST		HDD HGST 2.5" 5400rpm 500GB HTS545050B9A300 Panther B SATA LF F/W:C60F Disk imbalance criteria = 0.014g-cm	
WD		HDD WD 2.5" 5400rpm 500GB WD5000BEVT-22A0RT0, ML320M,WD SATA 8MB LF F/W:01.01A01	
SEAGATE	500GB/ 7200rpm	HDD SEAGATE 2.5" 7200rpm 500GB ST9500420AS Holiday SATA LF F/W:0002SDM1	

Vendor	Type	Description	PN
HGST		HDD HGST 2.5" 7200rpm 500GB HTS725050A9A364 SATA 8MB LF F/W: C70E	
TOSHIBA	640GB/ 5400rpm	HDD TOSHIBA 2.5" 5400rpm 640GB MK6465GSX,Capricorn BS,320G/P SATA 8MB LF F/W:GJ002J	
WD		HDD WD 2.5" 5400rpm 640GB WD6400BEVT-22A0RT0, ML320 SATA 8MB LF F/W:01.01A01	
Battery			
Sanyo	3CELL2.2	Battery SANYO UM-2009E Li-Ion 3S1P SANYO 3 cell 2200mAh Main COMMON ID : UM09E32	
PANASONIC		Battery PANASONIC UM-2009E Li-Ion 3S1P PANASONIC 3 cell 2200mAh Main COMMON ID: UM09E52	
SIMPO		Battery SIMPLO UM-2009E Li-Ion 3S1P PANASONIC 3 cell 2200mAh Main COMMON ID:UM09E72	
SANYO	6CELL2.2	Battery SANYO UM-2009E Li-Ion 3S2P SANYO 6 cell 4400mAh Main COMMON ID: UM09E31	
PANASONIC		Battery PANASONIC UM-2009E Li-Ion 3S2P PANASONIC 6 cell 4400mAh Main COMMON ID:UM09E51	
SIMPO		Battery SIMPLO UM-2009E Li-Ion 3S2P PANASONIC 6 cell 4400mAh Main COMMON ID:UM09E71	
SIMPO		Battery SIMPLO UM-2009E Li-Ion 3S2P SAMSUNG 6 cell 4400mAh Main COMMON ID:UM09E75	
Sanyo	6CELL2.8	Battery SANYO UM-2009E Li-Ion 3S2P SANYO 6 cell 5600mAh Main COMMON ID:UM09E36	
SIMPO		Battery SIMPLO UM-2009E Li-Ion 3S2P SAMSUNG 6 cell 5600mAh Main COMMON ID:UM09E70	
SIMPO		Battery SIMPLO UM-2009E Li-Ion 3S2P LGC 6 cell 5600mAh Main COMMON ID:UM09E78	
PANASONIC	6CELL2.9	Battery PANASONIC UM-2009E Li-Ion 3S2P PANASONIC 6 cell 5800mAh Main COMMON ID:UM09E56	
Keyboard NT1T_A10B			
Darfon	Standard for Trial Run	Keyboard ACER NT1T_A10B NT1T Internal 11 Standard Black NONE Y2010 Acer Legend Texture	
Darfon	Arabic	Battery PANASONIC UM-2009E Li-Ion 3S1P PANASONIC 3 cell 2200mAh Main COMMON ID: UM09E52	

Vendor	Type	Description	PN
Darfon	Belgium	Battery SIMPLO UM-2009E Li-Ion 3S1P PANASONIC 3 cell 2200mAh Main COMMON ID:UM09E72	
Darfon	Brazilian Portuguese	Battery SANYO UM-2009E Li-Ion 3S2P SANYO 6 cell 4400mAh Main COMMON ID: UM09E31	
Darfon	CZ/SK	Keyboard ACER NT1T_A10B NT1T Internal 11 Standard 85KS Black CZ/SK Texture	
Darfon	Chinese	Keyboard ACER NT1T_A10B NT1T Internal 11 Standard 84KS Black Chinese Texture	
Darfon	Danish	Keyboard ACER NT1T_A10B NT1T Internal 11 Standard 85KS Black Danish Texture	
Darfon	FR/Arabic	Keyboard ACER NT1T_A10B NT1T Internal 11 Standard 85KS Black FR/ Arabic Texture	
Darfon	French	Keyboard ACER NT1T_A10B NT1T Internal 11 Standard 85KS Black French Texture	
Darfon	German	Keyboard ACER NT1T_A10B NT1T Internal 11 Standard 85KS Black German Texture	
Darfon	Greek	Keyboard ACER NT1T_A10B NT1T Internal 11 Standard 84KS Black Greek Texture	
Darfon	Hungarian	Keyboard ACER NT1T_A10B NT1T Internal 11 Standard 85KS Black Hungarian Texture	
Darfon	Italian	Keyboard ACER NT1T_A10B NT1T Internal 11 Standard 85KS Black Italian Texture	
Darfon	Japanese	Keyboard ACER NT1T_A10B NT1T Internal 11 Standard 88KS Black Japanese Texture	
Darfon	Korean	Keyboard ACER NT1T_A10B NT1T Internal 11 Standard 84KS Black Korean Texture	
Darfon	Nordic	Keyboard ACER NT1T_A10B NT1T Internal 11 Standard 85KS Black Nordic Texture	
Darfon	Norwegian	Keyboard ACER NT1T_A10B NT1T Internal 11 Standard 85KS Black Norwegian Texture	
Darfon	Portuguese	Keyboard ACER NT1T_A10B NT1T Internal 11 Standard 85KS Black Portuguese Texture	
Darfon	Russian	Keyboard ACER NT1T_A10B NT1T Internal 11 Standard 84KS Black Russian Texture	

Vendor	Type	Description	PN
Darfon	SLO/CRO	Keyboard ACER NT1T_A10B NT1T Internal 11 Standard 85KS Black SLO/ CRO Texture	
Darfon	Spanish	Keyboard ACER NT1T_A10B NT1T Internal 11 Standard 85KS Black Spanish Texture	
Darfon	Sweden	Keyboard ACER NT1T_A10B NT1T Internal 11 Standard 85KS Black Sweden Texture	
Darfon	Swiss/G	Keyboard ACER NT1T_A10B NT1T Internal 11 Standard 85KS Black Swiss/ G Texture	
Darfon	Thailand	Keyboard ACER NT1T_A10B NT1T Internal 11 Standard 84KS Black Thailand Texture	
Darfon	Turkish	Keyboard ACER NT1T_A10B NT1T Internal 11 Standard 85KS Black Turkish Texture	
Darfon	UK	Keyboard ACER NT1T_A10B NT1T Internal 11 Standard 85KS Black UK Texture	
Darfon	US International	Keyboard ACER NT1T_A10B NT1T Internal 11 Standard 84KS Black US International Texture	
Darfon	US International w/ Hebrew	Keyboard ACER NT1T_A10B NT1T Internal 11 Standard 84KS Black US International w/ Hebrew Texture	
Darfon	US w/ Canadian French	Keyboard ACER NT1T_A10B NT1T Internal 11 Standard 85KS Black US w/ Canadian French Texture	
Adapter			
DELTA	40W	ADAPTOR,2 PIN,40W,19VDC,2.15A,100V~240V ADP-40THAA	
Leader		ADAPTOR,2 PIN,40W,19VDC,2.15A,100V~240V IU40-1190-011S	
Power Plug			
Leader	UL	UL	
Leader	EU	EU	
Leader	AUS	AUS	
Leader	UK	UK	
Leader	ARG	ARG	
Leader	CCC	CCC	
Leader	BRZ	BRZ	
Leader	SAF	SAF	
Leader	KOR	KOR	
Leader	AF	AF	
WLAN			

Vendor	Type	Description	PN
Foxconn	3rd WiFi 2x2 BGN	Foxconn Wireless LAN Atheros HB93 2x2 BGN (HM)	
Lite-on	3rd WiFi 2x2 BGN	Liteon Wireless LAN Atheros HB93 2x2 BGN (HM) WN6602AH	
Foxconn	3rd WiFi 2x2 BGN	Foxconn Wireless LAN Atheros HB97 2x2 BGN (HM)	
Lite-on	3rd WiFi 2x2 BGN	Liteon Wireless LAN Atheros HB97 2x2 BGN (HM) WN6603AH	
Foxconn	3rd WiFi 2x2 BG	Foxconn Wirelss LAN Atheros HB95BG (HM) T77H121.10	
Foxconn	3rd WiFi 2x2 BGN	Foxconn Wireless LAN Broadcomm 43225 2x2 BGN (HM) T77H103.00	
Foxconn	3rd WiFi 2x2 BGN	Foxconn Wirelss LAN Broadcom 4313 1x1 BGN (HM) T77H194.00	
3G Module			
Ericsson	Ericson	Ericsson F3307-900MHz	
Thermal Module			
	N/A	THERMAL MODULE,UMA	
Antenna			
Suyin	1.3M (3.8mm)	Suyin HF1315-S32B-OV01 R1.4	
Chicony		Chicony CN9157	
LitON		LiteON Liteon 1.3M LT9665AL (09P2SF119)	
Bluetooth			
FOXCONN	BRM 2046	Foxconn Bluetooth BRM 2046 BT2.1 (T60H928.33) f/w:861	
FOXCONN	BRM 2046	Foxconn Bluetooth BRM 2046 BT2.1 (T60H928.33) f/w:861(HSF)	
FOXCONN	BRM 2070	Foxconn Bluetooth BRM 2070 (T77H114.01)	
FOXCONN	ATH AR3011	Foxconn Bluetooth ATH AR3011 (T77H056.00)	
Fingerprint			
Authentec	AES1660	Authentec AES1660 (AES1660-C-SZ-TR-BB0A-AC.)	
EZ Dock			
Wistron/ Foxconn	N/A	EZ Dock	

Online Support Information

BIOS Setup Utility

This section describes online technical support services available to help you repair your Acer Systems.

If you are a distributor, dealer, ASP or TPM, please refer your technical queries to your local Acer branch office. Acer Branch Offices and Regional Business Units may access our website. However some information sources will require a user i.d. and password. These can be obtained directly from Acer CSD Taiwan.

Acer's Website offers you convenient and valuable support resources whenever you need them.

In the Technical Information section you can download information on all of Acer's Notebook, Desktop and Server models including:

Service guides for all models

- Bios updates
- Software utilities
- Spare parts lists
- TABs (Technical Announcement Bulletin)

For these purposes, we have included an Acrobat File to facilitate the problem-free downloading of our technical material.

Also contained on this website are:

- Detailed information on Acer's International Traveler's Warranty (ITW)
- Returned material authorization procedures
- An overview of all the support services we offer, accompanied by a list of telephone, fax and email contacts for all your technical queries.

We are always looking for ways to optimize and improve our services, so if you have any suggestions or comments, please do not hesitate to communicate these to us.

Free Manuals Download Website

<http://myh66.com>

<http://usermanuals.us>

<http://www.somanuals.com>

<http://www.4manuals.cc>

<http://www.manual-lib.com>

<http://www.404manual.com>

<http://www.luxmanual.com>

<http://aubethermostatmanual.com>

Golf course search by state

<http://golfingnear.com>

Email search by domain

<http://emailbydomain.com>

Auto manuals search

<http://auto.somanuals.com>

TV manuals search

<http://tv.somanuals.com>