

Acer Projector

X1130P/X1130PA/X1130PS/
X1230P/X1230PA/X1230PK/
X1230PS/X1237 Series
User's Guide

Copyright © 2009. Acer Incorporated.
All Rights Reserved.

Acer Projector X1130P/X1130PA/X1130PS/X1230P/X1230PA/X1230PK/X1230PS/X1237 Series
User's Guide
Original Issue: 7/2009

Changes may be made periodically to the information in this publication without obligation to notify any person of such revisions or changes. Such changes will be incorporated in new editions of this manual or supplementary documents and publications. This company makes no representations or warranties, either expressed or implied, with respect to the contents hereof and specifically disclaims the implied warranties of merchantability or fitness for a particular purpose.

Record the model number, serial number, purchase date and place of purchase information in the space provided below. The serial number and model number are recorded on the label affixed to your projector. All correspondence concerning your unit should include the serial number, model number and purchase information.

No part of this publication may be reproduced, stored in a retrieval system, or transmitted, in any form or by any means, electronically, mechanically, by photocopy, recording or otherwise, without the prior written permission of Acer Incorporated.

Acer Projector X1130P/X1130PA/X1130PS/X1230P/X1230PA/X1230PK/X1230PS/X1237 Series

Model number: _____

Serial number: _____

Date of purchase: _____

Place of purchase: _____

Acer and the Acer logo are registered trademarks of Acer Incorporated. Other companies' product names or trademarks are used herein for identification purposes only and belong to their respective companies.

"HDMI™, the HDMI logo and High-Definition Multimedia Interface are trademarks or registered trademarks of HDMI Licensing LLC."

Information for Your Safety and Comfort

Read these instructions carefully. Keep this document for future reference. Follow all warnings and instructions marked on the product.

Turning the product off before cleaning

Unplug this product from the wall outlet before cleaning. Do not use liquid cleaners or aerosol cleaners. Use a damp cloth for cleaning.

Caution for plug as disconnecting device

Observe the following guidelines when connecting and disconnecting power to the external power supply unit:

- Install the power supply unit before connecting the power cord to the AC power outlet.
- Unplug the power cord before removing the power supply unit from the projector.
- If the system has multiple sources of power, disconnect power from the system by unplugging all power cords from the power supplies.

Caution for Accessibility

Be sure that the power outlet you plug the power cord into is easily accessible and located as close to the equipment operator as possible. When you need to disconnect power to the equipment, be sure to unplug the power cord from the electrical outlet.



Warnings!

- Do not use this product near water.
- Do not place this product on an unstable cart, stand or table. If the product falls, it could be seriously damaged.
- Slots and openings are provided for ventilation to ensure reliable operation of the product and to protect it from overheating. These openings must not be blocked or covered. The openings should never be blocked by placing the product on a bed, sofa, rug or other similar surface.

This product should never be placed near or over a radiator or heat register, or in a built-in installation unless proper ventilation is provided.

- Never push objects of any kind into this product through cabinet slots as they may touch dangerous voltage points or short-out parts that could result in a fire or electric shock. Never spill liquid of any kind onto or into the product.

- To avoid damage of internal components and to prevent battery leakage, do not place the product on a vibrating surface.
- Never use it under sporting, exercising, or any vibrating environment which will probably cause unexpected short current or damage rotor devices, lamp.

Using electrical power

- This product should be operated from the type of power indicated on the marking label. If you are not sure of the type of power available, consult your dealer or local power company.
- Do not allow anything to rest on the power cord. Do not locate this product where people will walk on the cord.
- If an extension cord is used with this product, make sure that the total ampere rating of the equipment plugged into the extension cord does not exceed the extension cord ampere rating. Also, make sure that the total rating of all products plugged into the wall outlet does not exceed the fuse rating.
- Do not overload a power outlet, strip or receptacle by plugging in too many devices. The overall system load must not exceed 80% of the branch circuit rating. If power strips are used, the load should not exceed 80% of the power strip's input rating.
- This product's AC adapter is equipped with a three-wire grounded plug. The plug only fits in a grounded power outlet. Make sure the power outlet is properly grounded before inserting the AC adapter plug. Do not insert the plug into a non-grounded power outlet. Contact your electrician for details.



.....
Warning! The grounding pin is a safety feature. Using a power outlet that is not properly grounded may result in electric shock and/or injury.



.....
Note: The grounding pin also provides good protection from unexpected noise produced by other nearby electrical devices that may interfere with the performance of this product.

- Use the product only with the supplied power supply cord set. If you need to replace the power cord set, make sure that the new power cord meets the following requirements: detachable type, UL listed/CSA certified, VDE approved or its equivalent, 4.6 meters (15 feet) maximum length.

Product servicing

Do not attempt to service this product yourself, as opening or removing covers may expose you to dangerous voltage points or other risks. Refer all servicing to qualified service personnel.

Unplug this product from the wall outlet and refer servicing to qualified service personnel when:

- the power cord or plug is damaged, cut or frayed
- liquid was spilled into the product
- the product was exposed to rain or water
- the product has been dropped or the case has been damaged
- the product exhibits a distinct change in performance, indicating a need for service
- the product does not operate normally after following the operating instructions



.....

Note: Adjust only those controls that are covered by the operating instructions, since improper adjustment of other controls may result in damage and will often require extensive work by a qualified technician to restore the product to normal condition.



.....

Warning! For safety reasons, do not use non-compliant parts when adding or changing components. Consult your reseller for purchase options.

Your device and its enhancements may contain small parts. Keep them out of the reach of small children.

Additional safety information

- Do not look into the projector's lens when the lamp is on. The bright light may hurt your eyes.
- Turn on the projector first and then signal sources.
- Do not place the product in the following environments:
 - Space that is poorly ventilated or confined. At least 50cm clearance from walls and free flow of air around the projector are necessary.
 - Locations where temperatures may become excessively high, such as inside of a car with all windows rolled up.
 - Locations where excessive humidity, dust, or cigarette smoke may contaminate optical components, shorten the life span and darken the image.
 - Locations near fire alarms.
 - Locations with an ambient temperature above 40 °C/104 °F.
 - Locations where the altitudes are higher than 10000 feet.
- Unplug immediately if there is something wrong with your projector. Do not operate if smoke, strange noise or odor comes out of your projector. It

might cause fire or electric shock. In this case, unplug immediately and contact your dealer.

- Do not keep using this product to break or drop it. In this case contact your dealer for inspection.
- Do not face the projector lens to the sun. It can lead to fire.
- When switching the projector off, please ensure the projector completes its cooling cycle before disconnecting power.
- Do not turn off the main power abruptly or unplug the projector during operation. It can lead to lamp breakage, fire, electric shock or other trouble. The best way is to wait for the fan to stop before turning main power off.
- Do not touch the air outlet grille and bottom plate which become hot.
- Clean the air filter frequently. The temperature inside may rise and cause damage when the filter/ventilation slots are clogged with dirt or dust.
- Do not look into the air outlet grille when projector is operating. It may hurt your eyes.
- Always open the lens shutter or remove the lens cap when the projector is on.
- Do not block the projector lens with any object when the projector is under operation as this could cause the object to become heated and deformed or even cause a fire. To temporarily turn off the lamp, press HIDE on the remote control.
- The lamp becomes extremely hot during operation. Allow the projector to cool for approximately 45 minutes prior to removing the lamp assembly for replacement.
- Do not operate lamps beyond the rated lamp life. It could cause it to break on rare occasions.
- Never replace the lamp assembly or any electronic components unless the projector is unplugged.
- The product will detect the life of the lamp itself. Please be sure to change the lamp when warning messages display.
- When changing the lamp, please allow the projector to cool down, and follow all changing instructions.
- Reset the "Lamp Hour Reset" function from the Onscreen Display "Management" menu after replacing the lamp module.
- Do not attempt to disassemble this projector. There are dangerous high voltages inside which may hurt you. The only user serviceable part is the lamp which has its own removable cover. Refer servicing only to suitable qualified professional service personnel.
- Do not stand the projector on end vertically. It may cause the projector to fall over, causing injury or damage.
- This product is capable of displaying inverted images for ceiling mount installation. Only use acer ceiling mount kit for mounting the projector and ensure it is securely installed.

Caution for Listening

To protect your hearing, follow these instructions.

- Increase the volume gradually until you can hear clearly and comfortably.
- Do not increase the volume level after your ears have adjusted.
- Do not listen to music at high volumes for extended periods.
- Do not increase the volume to block out noisy surroundings.
- Decrease the volume if you can't hear people speaking near you.

Disposal instructions

Do not throw this electronic device into the trash when discarding. To minimize pollution and ensure utmost protection of the global environment, please recycle. For more information on the Waste from Electrical and Electronics Equipment (WEEE) regulations, visit <http://www.acer-group.com/public/Sustainability/sustainability01.htm>



Mercury advisory

For projectors or electronic products containing an LCD/CRT monitor or display:



"Lamp(s) contain Mercury,
Dispose Properly."

Lamp(s) inside this product contain mercury and must be recycled or disposed of according to local, state or federal laws. For more information, contact the Electronic Industries Alliance at www.eiae.org. For lamp-specific disposal information, check www.lamprecycle.org

First Thing First

Usage Notes

Do:

- Turn off the product before cleaning.
- Use a soft cloth moistened with mild detergent to clean the display housing.
- Disconnect the power plug from AC outlet if the product is not being used for a long period of time.

Don't:

- Block the slots and openings on the projector provided for ventilation.
- Use abrasive cleaners, waxes or solvents to clean the unit.
- Use under the following conditions:
 - In extremely hot, cold or humid environments.
 - In areas susceptible to excessive dust and dirt.
 - Near any appliance that generates a strong magnetic field.
 - Place in direct sunlight.

Precautions

Follow all warnings, precautions and maintenance as recommended in this user's guide to maximize the life of your unit.



Warning:

- Do not look into the projector's lens when the lamp is on. The bright light may hurt your eyes.
- To reduce the risk of fire or electric shock, do not expose this product to rain or moisture.
- Please do not open or disassemble the product as this may cause electric shock.
- When changing the lamp, please allow the projector to cool down, and follow all changing instructions.
- This product will detect the life of the lamp itself. Please be sure to change the lamp when it shows warning messages.
- Reset the "Lamp Hour Reset" function from the Onscreen Display "Management" menu after replacing the lamp module.
- When switching the projector off, please ensure the projector completes its cooling cycle before disconnecting power.
- Turn on the projector first and then the signal sources.
- Do not use lens cap when projector is in operation.
- When the lamp reaches the end of its life, it will burn out and may make a loud popping sound. If this happens, the projector will not turn back on until the lamp module has been replaced. To replace the lamp, follow the procedures listed under "Replacing the Lamp".

| | |
|--|------|
| Information for Your Safety and Comfort | iii |
| First Thing First | viii |
| Usage Notes | viii |
| Precautions | viii |
| Introduction | 1 |
| Product Features | 1 |
| Package Overview | 2 |
| Projector Overview | 3 |
| Projector Outlook | 3 |
| Control Panel | 4 |
| Remote Control Layout | 5 |
| Getting Started | 7 |
| Connecting the Projector | 7 |
| Turning the Projector On/Off | 8 |
| Turning On the Projector | 8 |
| Turning Off the Projector | 9 |
| Adjusting the Projected Image | 10 |
| Adjusting the Height of the Projected Image | 10 |
| How to Optimize Image Size and Distance | 11 |
| How to Get a Preferred Image Size by Adjusting Distance and Zoom | 13 |
| User Controls | 15 |
| Installation Menu | 15 |
| Acer Empowering Technology | 16 |
| Onscreen Display (OSD) Menus | 17 |
| Color | 18 |
| Image | 19 |
| Setting | 22 |
| Management | 25 |
| Audio | 26 |
| Timer | 26 |
| Language | 27 |
| Appendices | 28 |

Contents

| | |
|---------------------------------------|-----------|
| Troubleshooting | 28 |
| LED & Alarm Definition Listing | 32 |
| Replacing the Lamp | 33 |
| Ceiling Mount Installation | 34 |
| Specifications | 37 |
| Compatibility Modes | 39 |
| Regulations and safety notices | 42 |

Introduction

Product Features

This product is a single-chip DLP® projector, including the following outstanding features:

- DLP® technology
- X1130P/X1130PA/X1130PS: Native 800 x 600 SVGA resolution
X1230P/X1230PA/X1230PK/X1230PS/X1237: Native 1024 x 768 XGA resolution
4:3 / 16:9 aspect ratio supported
- Acer ColorBoost technology delivers vivid, life-like images
- High brightness and contrast ratio
- Versatile display modes (Bright, Standard, Video, Picture, Game, User) enable optimum performance in any situation
- NTSC/PAL/SECAM compatible and HDTV (720p, 1080i) supported
- Lower power consumption and economy (ECO) mode extends lamp life
- Acer EcoProjecton Technology delivers Intelligent power management approach and physical efficiency improvement
- Empowering Key reveals Acer Empowering Technology functions (Acer eView, eTimer, ePower Management) for easy adjustment of settings
- Advanced keystone correction delivers optimum presentations
- Multi-language Onscreen Display (OSD) menus
- Full-function remote control
- X1130P/X1130PA/X1230P/X1230PA/X1230PK/X1237: Manual focus projection lens zooms up to 1.1X
- 2X digital zoom and pan move function
- Microsoft® Windows® 2000, XP, Vista® OS compliant

Package Overview

This projector comes with all the items shown below. Check to make sure you have them all. Contact your dealer immediately if any thing is missing.

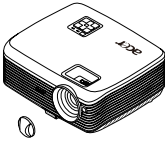

Projector with lens cap



Power cord



VGA cable



Composite video cable
(Optional)



Security card



User's guide (CD-ROM)

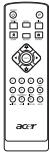

Remote control



Quick start guide



Battery x 2



Carrying case
(Optional)

Projector Overview

Projector Outlook

Front / upper side

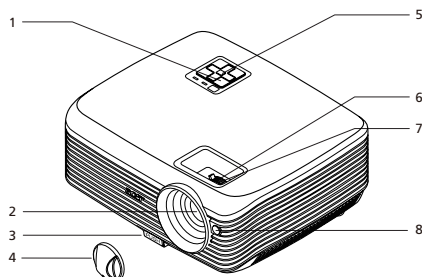

| # | Description | # | Description |
|---|-----------------------------------|---|---|
| 1 | Power key and Power indicator LED | 5 | Control panel |
| 2 | Projection lens | 6 | Zoom ring (for X1130P/X1130PA/X1230P/X1230PA/X1230PK/X1237) |
| 3 | Elevator button | 7 | Focus ring |
| 4 | Lens cap | 8 | Remote control receiver |

Rear side

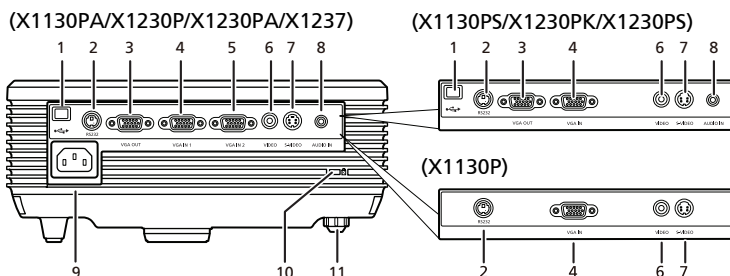

| # | Description | # | Description |
|---|--|----|---------------------------------|
| 1 | USB connector | 6 | Composite video input connector |
| 2 | RS232 connector | 7 | S-Video input connector |
| 3 | Monitor loop-through output connector | 8 | Audio input connector |
| 4 | PC analog signal/HDTV/component video input connector (VGA IN or VGA IN 1) | 9 | Power socket |
| 5 | PC analog signal/HDTV/component video input connector (VGA IN 2) | 10 | Kensington™ lock port |
| | | 11 | Tilt adjusting wheel |

Control Panel

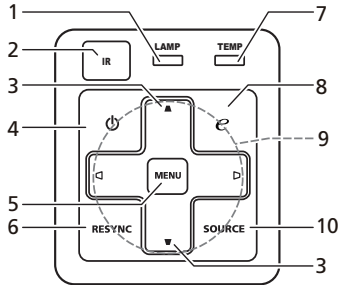

| # | Function | Description |
|----|-----------------------------------|---|
| 1 | LAMP | Lamp Indicator LED |
| 2 | IR | Remote control receiver |
| 3 | Keystone | Adjusts image distortion caused by tilting projection (± 40 degrees). |
| 4 | Power key and Power indicator LED | Refer to the "Turning the Projector On/Off" section. |
| 5 | MENU | <ul style="list-style-type: none"> • Launches the Onscreen Display (OSD) menu, returns to the previous step for the OSD menu operation or exits the OSD menu. • Confirms your selection of items. |
| 6 | RESYNC | Automatically synchronizes the projector to the input source. |
| 7 | TEMP | Temp Indicator LED |
| 8 | Empowering key | Enables unique Acer functions: eView, eTimer, ePower Management. |
| 9 | Four directional select keys | Selects items or makes adjustments to your selection. |
| 10 | SOURCE | Chooses RGB, component video, S-Video, composite video or HDTV source. |

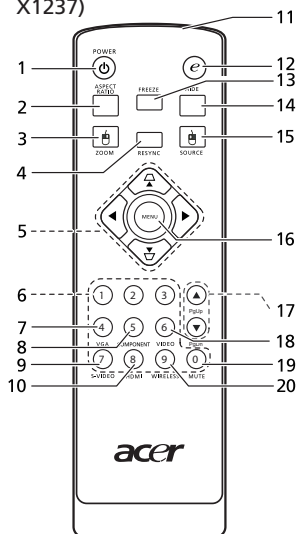

Remote Control Layout

(X1130PA/X1130PS/X1230P/
X1230PA/X1230PK/X1230PS/
X1237)

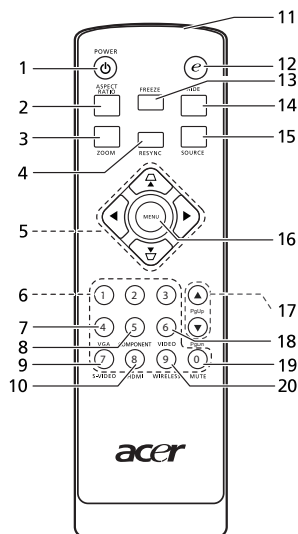

(X1130P)



| # | Function | Description |
|---|--|---|
| 1 | POWER | Refer to the "Turning the Projector On/Off" section. |
| 2 | ASPECT RATIO | To choose the desired aspect ratio (Auto/4:3/16:9). |
| 3 | ZOOM | Zooms the projector display in or out. When a USB cable is connected, it performs the same function as the left mouse button. (for X1130PA/X1130PS/X1230P/X1230PA/X1230PK/X1230PS/X1237) |
| 4 | RESYNC | Automatically synchronizes the projector to the input source. |
| 5 |  Keystone  Four directional select keys | Adjusts image distortion caused by tilting projection (± 40 degrees). Selects items or makes adjustments to your selection. |
| 6 | Keypad 0~9 | Press "0~9" to input a password in the "Setting > Security" OSD. |
| 7 | VGA | To change source to VGA. This connection supports analog RGB, YPbPr (480p/576p/720p/1080i/1080p), and YCbCr (480i/576i). |

| # | Function | Description |
|----|----------------------|--|
| 8 | COMPONENT | To change source to Component video. This connection supports YPbPr (480p/576p/720p/1080i/1080p) and YCbCr (480i/576i). |
| 9 | S-VIDEO | To change source to S-Video. |
| 10 | HDMI™ | To change source to HDMI™ (for the model with HDMI™ connector). |
| 11 | Infrared transmitter | Sends signals to the projector. |
| 12 | Empowering key | Enables unique Acer functions: eView, eTimer, ePower Management. |
| 13 | FREEZE | To pause the screen image. |
| 14 | HIDE | Press " HIDE " to hide screen image; press again to display the image. |
| 15 | SOURCE | Chooses RGB, component video, S-Video, composite video or HDTV source. When a USB cable is connected, it performs the same function as the right mouse button. (for X1130PA/X1130PS/X1230P/X1230PA/X1230PK/X1230PS/X1237) |
| 16 | MENU | <ul style="list-style-type: none"> • Launches the Onscreen Display (OSD) menu, returns to the previous step for the OSD menu operation or exits the OSD menu. • Confirms your selection of items. |
| 17 | PgUp/PgDn | For computer mode only. Use this button to select the next or previous page. This function is only available when connected to a computer via a USB cable. (for X1130PA/X1130PS/X1230P/X1230PA/X1230PK/X1230PS/X1237) |
| 18 | VIDEO | To change source to Composite video. |
| 19 | MUTE | To turn on/off the volume. |
| 20 | WIRELESS | Displays the image which is wirelessly transmitted from the PC to the projector via the "Acer eProjection Management" utility. (for wireless models) |

DX1130PA/X1130PS/X1230P/
X1230PA/X1230PK/X1230PS/X1237)



DX1130P)



Getting Started

Connecting the Projector

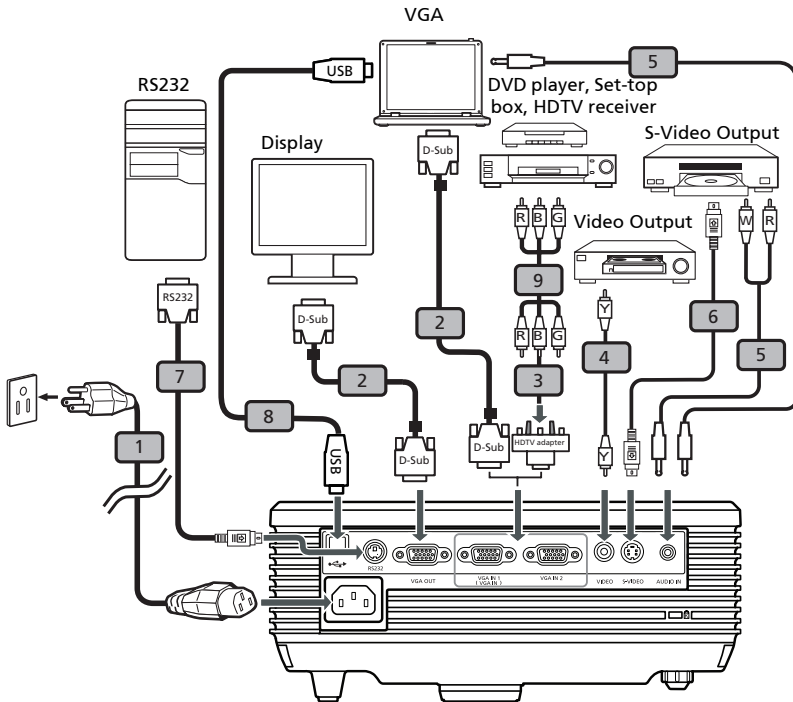

| # | Description | # | Description |
|---|-------------------------------------|---|-----------------------|
| 1 | Power cord | 6 | S-Video cable |
| 2 | VGA cable | 7 | RS232 cable |
| 3 | VGA to component video/HDTV adapter | 8 | USB cable |
| 4 | Composite video cable | 9 | 3 RCA component cable |
| 5 | Audio cable | | |



Note: To ensure the projector works well with your computer, please make sure the timing of the display mode is compatible with the projector.

Turning the Projector On/Off

Turning On the Projector

- 1 Remove the lens cap.
- 2 Ensure that the power cord and signal cable are securely connected. The Power LED will light red.
- 3 Turn on the projector by pressing  (POWER) on the control panel or remote control, and the Power indicator LED will turn blue.
- 4 Turn on your source (computer, notebook, video player, etc.). The projector will detect your source automatically.
 - If the screen displays "Lock" & "Source" icons, it means the projector is locked onto a specific source type and there is no such type of input signal detected.
 - If the screen displays "No Signal", please make sure the signal cables are securely connected.
 - If you connect to multiple sources at the same time, use "SOURCE" on the control panel or remote control, or the direct source key on the remote control to switch between inputs.

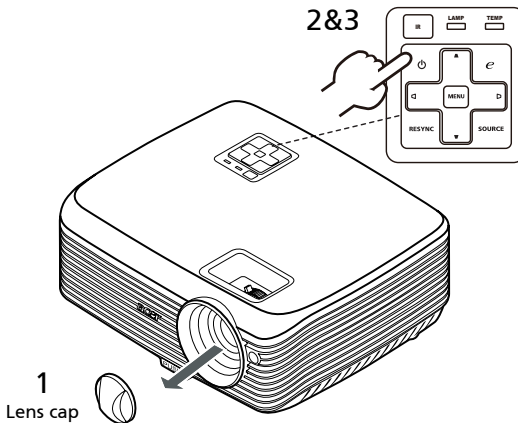

Turning Off the Projector

- 1 To turn the projector off, press the power button. This message appears:
"Please press the power button again to complete the shutdown process."
 Press the power button again.
- 2 The LED power indicator will turn RED and blink rapidly after the projector is turned off, and the fan(s) will continue to operate for about 2 minutes to ensure that the system cools properly.
- 3 As long as the power cord remains plugged in, you can press the power button to turn the projector immediately back on anytime during the 2-minute shutdown process.
- 4 Once the system has finished cooling, the LED power indicator will stop blinking and turn solid red to indicate standby mode.
- 5 It is now safe to unplug the power cord.



Warning indicators:

- **"Projector Overheated. Lamp will automatically turn off soon."**
 This onscreen message indicates that the projector has overheated. The lamp will automatically turn off, the projector will automatically shut down, and the LED temp indicator will turn solid red. Contact your local dealer or service center.
- **"Fan failed. Lamp will automatically turn off soon."**
 This onscreen message indicates that the fan has failed. The lamp will automatically turn off, the projector will automatically shut down, and the LED temp indicator will blink. Contact your local dealer or service center.



Note: Whenever the projector automatically shuts down and the LED lamp indicator turns solid red, contact your local reseller or service center.

Adjusting the Projected Image

Adjusting the Height of the Projected Image

The projector is equipped with an elevator foot for adjusting the image height.

To raise the image:

- 1 Press the elevator button.
- 2 Raise the image to the desired height angle, then release the button to lock the elevator foot into position.
- 3 Use Tilt adjusting wheel to fine-tune the display angle.

To lower the image:

- 1 Press the elevator button.
- 2 Lower the image to the desired height angle, then release the button to lock the elevator foot into position.
- 3 Use Tilt adjusting wheel to fine-tune the display angle.

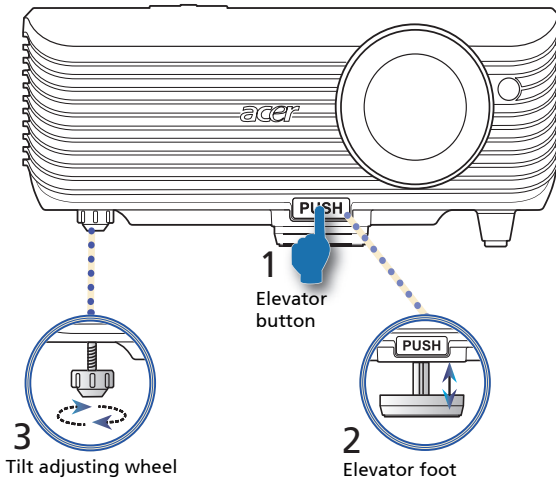

How to Optimize Image Size and Distance

Consult the table below to find the optimal image sizes achievable when the projector is positioned at a desired distance from the screen.

- X1130P/X1130PA/X1230P/X1230PA/X1230PK/X1237

If the projector is 3 m from the screen, good image quality is possible for image sizes between 72" and 79".



Note: Remind as below figure, the space of 132 cm height is required when the projector is located at 3 m distance.

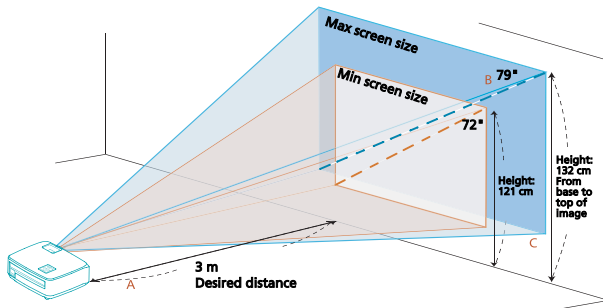

| Desired Distance (m) < A > | Minimum Screen Size (Min zoom) | | | Maximum Screen Size (Max zoom) | | |
|----------------------------|--------------------------------|-----------------|--------------------------------------|--------------------------------|-----------------|--------------------------------------|
| | Diagonal (inch) < B > | W (cm) x H (cm) | From base to top of image (cm) < C > | Diagonal (inch) < B > | W (cm) x H (cm) | From base to top of image (cm) < C > |
| 1.5 | 36 | 74 x 55 | 60 | 40 | 81 x 60 | 67 |
| 2 | 48 | 98 x 74 | 80 | 53 | 108 x 81 | 89 |
| 2.5 | 60 | 123 x 92 | 101 | 66 | 134 x 101 | 111 |
| 3 | 72 | 147 x 110 | 121 | 79 | 161 x 121 | 132 |
| 3.5 | 84 | 172 x 129 | 141 | 93 | 188 x 141 | 156 |
| 4 | 96 | 196 x 147 | 161 | 106 | 215 x 161 | 178 |
| 4.5 | 108 | 221 x 165 | 181 | 119 | 242 x 181 | 199 |
| 5 | 120 | 245 x 184 | 201 | 132 | 269 x 202 | 221 |
| 6 | 144 | 294 x 221 | 241 | 159 | 323 x 242 | 267 |
| 7 | 168 | 343 x 257 | 282 | 185 | 376 x 282 | 310 |
| 8 | 192 | 392 x 294 | 322 | 212 | 430 x 323 | 355 |
| 9 | 216 | 441 x 331 | 362 | 238 | 484 x 363 | 399 |
| 10 | 241 | 490 x 368 | 404 | 265 | 538 x 403 | 444 |
| 11 | 265 | 539 x 404 | 444 | 291 | 591 x 444 | 488 |
| 12 | 289 | 588 x 441 | 484 | 318 | 645 x 484 | 533 |

Zoom Ratio: 1.1 x

- X1130PS/X1230PS

If the projector is 3 m from the screen, good image quality is possible for image sizes around 164".



Note: Remind as below figure, the space of 275 cm height is required when located at 3 m distance.

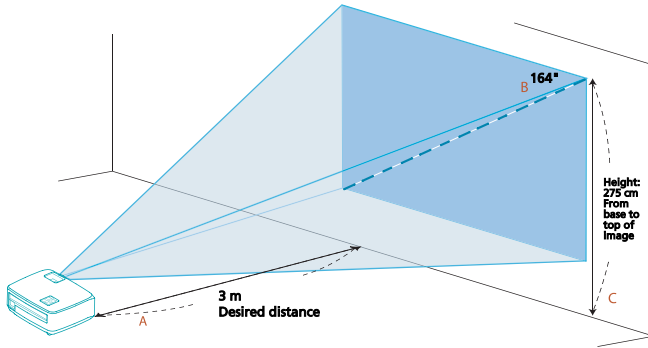

| Desired Distance (m) < A > | Minimum Screen Size (Min zoom) | | |
|----------------------------|--------------------------------|-----------------|--------------------------------------|
| | Diagonal (inch) < B > | W (cm) x H (cm) | From base to top of image (cm) < C > |
| 0.5 | 27 | 56 x 42 | 46 |
| 1 | 55 | 111 x 83 | 92 |
| 1.5 | 82 | 167 x 125 | 138 |
| 2 | 109 | 222 x 167 | 183 |
| 2.5 | 137 | 278 x 208 | 229 |
| 3 | 164 | 333 x 250 | 275 |
| 3.5 | 191 | 389 x 292 | 321 |
| 4 | 219 | 444 x 333 | 367 |
| 4.5 | 246 | 500 x 375 | 413 |
| 5 | 273 | 556 x 417 | 458 |
| 6 | 328 | 667 x 500 | 550 |

Zoom Ratio: 1.0 x

How to Get a Preferred Image Size by Adjusting Distance and Zoom

The table below shows how to achieve a desired image size by adjusting either the position or the zoom ring.

- X1130P/X1130PA/X1230P/X1230PA/X1230PK/X1237

To obtain an image size of 50" set the projector at a distance between 1.9 m and 2.1 m from the screen and adjust the zoom level accordingly.

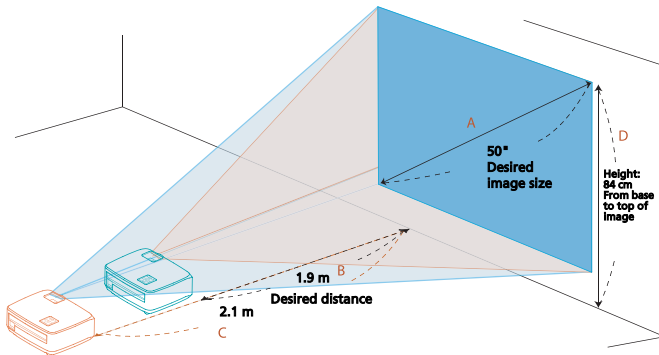

| Desired Image Size | | Distance (m) | | Top (cm) |
|--------------------|-----------------|-------------------|-------------------|------------------------------------|
| Diagonal < A > | W (cm) x H (cm) | Max zoom < B > | Min zoom < C > | From base to top of image < D > |
| 30 | 61 x 46 | | 1.2 | 50 |
| 40 | 81 x 61 | 1.5 | 1.7 | 67 |
| 50 | 102 x 76 | 1.9 | 2.1 | 84 |
| 60 | 122 x 91 | 2.3 | 2.5 | 101 |
| 70 | 142 x 107 | 2.6 | 2.9 | 117 |
| 80 | 163 x 122 | 3.0 | 3.3 | 134 |
| 90 | 183 x 137 | 3.4 | 3.7 | 151 |
| 100 | 203 x 152 | 3.8 | 4.2 | 168 |
| 120 | 244 x 183 | 4.5 | 5.0 | 201 |
| 150 | 305 x 229 | 5.7 | 6.2 | 251 |
| 180 | 366 x 274 | 6.8 | 7.5 | 302 |
| 200 | 406 x 305 | 7.6 | 8.3 | 335 |
| 250 | 508 x 381 | 9.4 | 10.4 | 419 |
| 300 | 610 x 457 | 11.3 | | 503 |

Zoom Ratio: 1.1 x

- X1130PS/X1230PS

To obtain an image size of 50" set the projector at a distance 0.9 m from the screen.

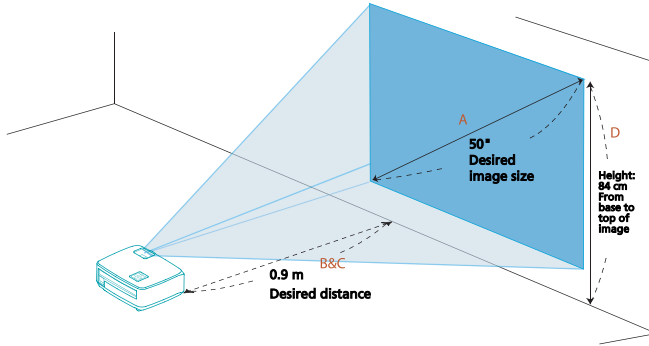

| Desired Image Size | | Distance (m) | | Top (cm) |
|--------------------------|-----------------|-------------------|-------------------|------------------------------------|
| Diagonal (inch) < A > | W (cm) x H (cm) | Max zoom < B > | Min zoom < C > | From base to top of image < D > |
| 30 | 61 x 46 | 0.5 | 0.5 | 50 |
| 40 | 81 x 61 | 0.7 | 0.7 | 67 |
| 50 | 102 x 76 | 0.9 | 0.9 | 84 |
| 60 | 122 x 91 | 1.1 | 1.1 | 101 |
| 70 | 142 x 107 | 1.3 | 1.3 | 117 |
| 80 | 163 x 122 | 1.5 | 1.5 | 134 |
| 90 | 183 x 137 | 1.6 | 1.6 | 151 |
| 100 | 203 x 152 | 1.8 | 1.8 | 168 |
| 120 | 244 x 183 | 2.2 | 2.2 | 201 |
| 150 | 305 x 229 | 2.7 | 2.7 | 251 |
| 180 | 366 x 274 | 3.3 | 3.3 | 302 |
| 200 | 406 x 305 | 3.7 | 3.7 | 335 |
| 250 | 508 x 381 | 4.6 | 4.6 | 419 |
| 300 | 610 x 457 | 5.5 | 5.5 | 503 |

Zoom Ratio: 1.0 x

User Controls

Installation Menu

The installation menu provides an onscreen display (OSD) for projector installation and maintenance. Use the OSD only when the message "No signal input" is displayed on the screen.

- 1 Turn on the projector by pressing  (POWER) on the control panel or remote control.
- 2 Press "MENU" on the control panel or remote control to launch the OSD for projector installation and maintenance.

(X1130P/X1130PA/X1230P/
X1230PA/X1237)

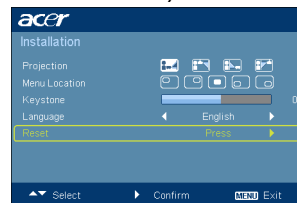
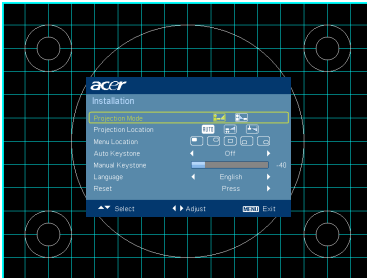

(X1130PS/X1230PK/X1230PS)

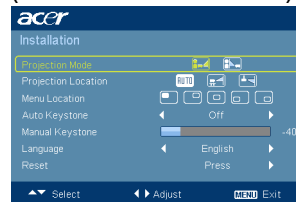



- 3 The background pattern acts as a guide to adjusting the calibration and alignment settings, such as screen size and distance, focus and more.
- 4 The Installation menu includes the following options:
 - Projection method
 - Menu location
 - Keystone settings
 - Language settings
 - Reset to factory default functions

Use the up and down arrow keys to select an option, the left and right arrow keys to adjust selected option settings, and the right arrow key to enter a submenu for feature setting. The new settings will be saved automatically upon exiting the menu.

- 5 Press "MENU" anytime to exit the menu and return to the Acer welcome screen.

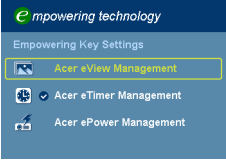
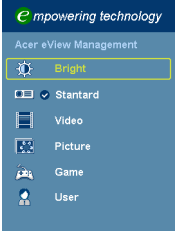

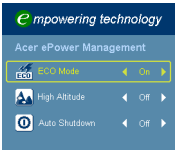



Acer Empowering Technology

| | |
|---|---|
| <p>Empowering Key</p>  | <p>Acer Empowering Key provides three Acer unique functions: "Acer eView Management", "Acer eTimer Management", and "Acer ePower Management". Press "e" for more than one second to launch the Onscreen Display main menu to modify its function.</p> |
| <p>Acer eView Management</p>  | <p>Press "e" to launch "Acer eView Management". "Acer eView Management" is for display mode selection. Please refer to the "Onscreen Display (OSD) Menus" section for more details.</p> |
| <p>Acer eTimer Management</p>  | <p>Press "e" to launch "Acer eTimer Management". "Acer eTimer Management" provides the reminding function for presentation time control. Please refer to the "Onscreen Display (OSD) Menus" section for more details.</p> |
| <p>Acer ePower Management</p>  | <p>Press "e" to launch "Acer ePower Management". "Acer ePower Management" provides you one shortcut to save the lamp and projector's life. Please refer to the "Onscreen Display (OSD) Menus" section for more details.</p> |

Onscreen Display (OSD) Menus

The projector has multilingual Onscreen Display (OSD) menus that allow you to make image adjustments and change a variety of settings.

Using the OSD menus

- To open the OSD menu, press "MENU" on the control panel or remote control.
- When the OSD is displayed, use   to select an item in the main menu. After selecting the desired main menu item, press  to enter a submenu for feature setting.
- Use   to select the desired item and adjust the settings by using  .
- Select the next item to be adjusted in the submenu and adjust as described above.
- Press "MENU" on the control panel or remote control, the screen will return to the main menu.
- To exit the OSD menu, press "MENU" on the control panel or remote control again. It will close and the projector will automatically save the new settings.

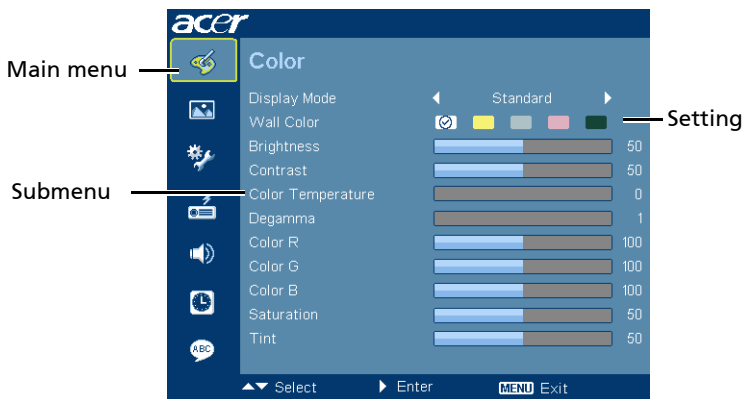

Color

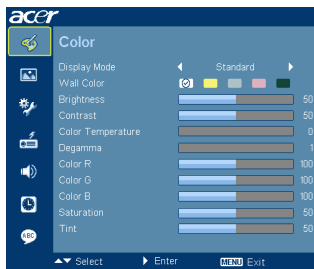

| | |
|--------------------------|--|
| Display Mode | <p>There are many factory presets optimized for various types of images.</p> <ul style="list-style-type: none"> • Bright: For brightness optimization. • Standard: For common environment. • Video: For playing video in a bright environment. • Picture: For graphic picture. • Game: For game content. • User: Memorize user's settings. |
| Wall Color | <p>Use this function to choose a proper color according to the wall. There are several choices, including white, light yellow, light blue, pink, dark green. It will compensate the color deviation due to the wall color to show the correct image tone.</p> |
| Brightness | <p>Adjusts the brightness of the image.</p> <ul style="list-style-type: none"> • Press ◀ to darken the image. • Press ▶ to lighten the image. |
| Contrast | <p>Controls the degree of difference between the lightest and darkest parts of the picture. Adjusting the contrast changes the amount of black and white in the image.</p> <ul style="list-style-type: none"> • Press ◀ to decrease the contrast. • Press ▶ to increase the contrast. |
| Color Temperature | <p>Adjusts the color temperature. At higher color temperatures, the screen looks colder; at lower color temperatures, the screen looks warmer.</p> |
| Degamma | <p>Effects the representation of dark scenery. With greater gamma value, dark scenery will look brighter.</p> |
| Color R | <p>Adjusts the red color.</p> |

| | |
|-------------------|---|
| Color G | Adjusts the green color. |
| Color B | Adjusts the blue color. |
| Saturation | <p>Adjusts a video image from black and white to fully saturated colors.</p> <ul style="list-style-type: none"> Press ◀ to decrease the amount of color in the image. Press ▶ to increase the amount of color in the image. |
| Tint | <p>Adjusts the color balance of red and green.</p> <ul style="list-style-type: none"> Press ◀ to increase the amount of green in the image. Press ▶ to increase the amount of red in the image. |



Note: "Saturation" and "Tint" functions are not supported under computer mode.

Image



(X1130P/X1130PA/X1230P/
X1230PA/X1237)



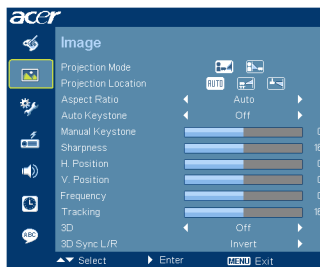









(X1130PS/X1230PK/X1230PS)

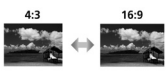

Projection
(for X1130P/
X1130PA/
X1230P/
X1230PA/
X1237)

-  Front-Desktop: The factory default setting.
-  Front-Ceiling: When you select this function, the projector inverts the image for ceiling-mounted projection.
-  Rear-Desktop: When you select this function, the projector reverses the image so that you can project behind a translucent screen.

| | |
|--|--|
| | <ul style="list-style-type: none">  Rear-Ceiling: When you select this function, the projector reverses and inverts the image at same time. You can project from behind a translucent screen with ceiling mounted projection. |
| Projection Mode (for X1130PS/ X1230PK/ X1230PS) | <ul style="list-style-type: none">  Front: The factory default setting.  Rear: Reverses the image so you can project from behind a translucent screen. |
| Projection Location (for X1130PS/ X1230PK/ X1230PS) | <ul style="list-style-type: none">  Auto: Automatically adjusts projection location of image.  Desktop  Ceiling: Turns the image upside down for ceiling-mounted projection. |
| Aspect Ratio  | <p>Use this function to choose your desired aspect ratio.</p> <ul style="list-style-type: none"> Auto: Keeps the image with original width-height ratio and maximizes the image to fit native horizontal or vertical pixels. 4:3: The image will be scaled to fit the screen and displayed using a 4:3 ratio. 16:9: The image will be scaled to fit the screen and displayed using a 16:9 ratio. |
| Keystone (for X1130P/ X1130PA/ X1230P/ X1230PA/ X1237) | <p>Adjusts image distortion caused by tilting projection (± 40 degrees).</p>  |
| Auto Keystone (for X1130PS/ X1230PK/ X1230PS) | <p>Automatically adjusts image distortion caused by tilting projection (± 40 degrees).</p> |
| Manual Keystone (for X1130PS/ X1230PK/ X1230PS) | <p>Manually adjusts image distortion caused by tilting projection (± 40 degrees).</p>  <p><Note> The Manual Keystone function is unavailable under Auto Keystone setting to "On".</p> |
| Sharpness | <p>Adjusts the sharpness of the image.</p> <ul style="list-style-type: none"> Press  to decrease the sharpness. Press  to increase the sharpness. |

| | |
|--|---|
| H. Position (Horizontal Position) | <ul style="list-style-type: none"> • Press ◀ to move the image left. • Press ▶ to move the image right. |
| V. Position (Vertical Position) | <ul style="list-style-type: none"> • Press ▼ to move the image down. • Press ▲ to move the image up. |
| Frequency | Changes the projector's refresh rate to match the frequency of your computer's graphics card. If you experience a vertical flickering bar in the projected image, use this function to correct it. |
| Tracking | Synchronizes the signal timing of the display with the graphics card. If you experience an unstable or flickering image, use this function to correct it. |
| 3D | <p>Selects "NVIDIA 3D Vision" or "DLP 3D" to enable the 3D function supported by NVIDIA or TI DLP 3D technology.</p> <ul style="list-style-type: none"> • NVIDIA 3D Vision (for X1130P) Select this item while using NVIDIA 3D glasses, IR emitter, NVIDIA graphics card and NVIDIA compliant 3D games or 3D movies with corresponding SW player. Please visit NVIDIA URL (http://www.nvidia.com/object/3D_Vision_Requirements.html) to check detailed system configuration. • DLP 3D Select this item while using DLP 3D glasses, quad buffer (NVIDIA/ATI...) graphics card and HQFS format file or DVD with corresponding SW player. • Off Turns off the 3D mode. |
| 3D Sync L/R | If you see a discrete or overlapping image while wearing DLP 3D glasses, you may need to execute "Invert" to get best match of left/right image sequence to get the correct image (for DLP 3D). |



Note: "H. Position", "V. Position", "Frequency" and "Tracking" functions are not supported under video mode.

Note: "Sharpness" function is not supported under computer mode.

Note:

The 3D function is supported by VGA source only. Please see the timing table for detailed 3D timings.

While using NVIDIA 3D Vision, please download and install the latest NVIDIA 3D Vision driver from NVIDIA web site for your graphics card to support this projector.

It needs correct settings on graphics card 3D application program for correct 3D display.

The SW players, such as Stereoscopic Player and DDD TriDef Media Player can support 3D format files. You can download these players on the web page below.

- NVIDIA Stereoscopic 3D Video Player: http://www.nvidia.com/object/3D_Drivers_Downloads.html

-Stereoscopic Player (Trial): http://www.3dtv.at/Downloads/Index_en.aspx

-DDD TriDef Media Player (Trial): <http://www.tridef.com/download/TriDef-3D-Experience-4.0.2.html>

Note: "3D Sync L/R" is only available when 3D is enabled.

Note: The following reminder appears on the screen when turning on 3D or after the projector is re-started with 3D enabled.

Notice : 3D display mode is enabled now.

1. Please make sure to input correct 3D signals and wear 3D glasses at the same time.
You may need to execute "Invert" function for "3D Sync L/R" option to get the correct image.
2. Please remember to turn off 3D if you don't want to see 3D images.
3. Display mode option will be disabled while 3D function is enabled.

Setting







(X1130PA/X1130PS/X1230P/
X1230PA/X1230PK/X1230PS/
X1237)









(X1130P)



| | |
|----------------------|--|
| Menu Location | Chooses the OSD menu location on the display screen. |
| Source Lock | When this function is turned off, the projector will search for other signals if the current input signal is lost. When this function is turned on, it will lock the current source channel before you press "SOURCE" on the control panel or remote control for next channel. |

| | |
|--|---|
| <p>Closed Caption</p> | <p>Selects a preferred closed captioning mode from CC1, CC2, CC3, CC4, (CC1 displays captions in the primary language in your area). Select "Off" to turn off the captioning feature. This function is only available when a composite video or S-Video input signal is selected and its system format is NTSC.</p> <p></p> <p>-----</p> <p>Set your screen aspect ratio to 4:3. The function is not available when the aspect ratio is "16:9" or 16:9 format detected under "Auto mode".</p> |
| <p>Security</p>  | <p>Security</p> <p>This projector provides a useful security function for the administrator to manage the projector.</p> <p>Press  to change the "Security" setting. If the security function is enabled, you must enter "Administrator Password" first before changing the security setting.</p> <p></p> <p>-----</p> <p>The factory default of "Administrator Password" is "1234".</p> <ul style="list-style-type: none"> • Select "On" to enable the security function. You have to enter password depending on the "Security Mode". Please refer to "User Password" section for details. • If "Off" is selected, you can switch on the projector without password. |
| | <p>Timeout (Min.)</p> <p>Once "Security" is set to "On", you can set timeout function.</p> <ul style="list-style-type: none"> • Press   to select timeout duration. • The range is from 10 to 990 minutes. • When time is up, the projector will request you to enter the password again. • The factory default setting of "Timeout (Min.)" is "Off". • Once the security function is enabled, the projector will request you to enter password when switching on the projector. Both "User Password" and "Administrator Password" can be accepted for this dialogue. |

| | |
|---|--|
|  | <p>User Password</p> <ul style="list-style-type: none"> • Press  to set up or change "User Password". • Use the numerical keys on the remote control to set the password and press "MENU" to confirm. • To delete the digits, Press . • Enter the password again when you see "Confirm Password" displayed. • The password should be 4–8 digits in length. • If you select "Request password only after plugging power cord", you are requested to input the password every time the power cord is plugged. • If you select "Always request password while projector turns on", you are requested to input the password every time the projector is turned on. |
|  | <p>Administrator Password</p> <p>You can enter "Administrator Password" when the "Enter Administrator Password" or "Enter Password" dialogue box displays.</p> <ul style="list-style-type: none"> • Press  to change "Administrator Password". • The factory default of "Administrator Password" is "1234". <p>If you forget your administrator password, do the following to retrieve the administrator password:</p> <ul style="list-style-type: none"> • Enter the unique 6-digit "Universal Password" which is printed on the Security Card that came with your projector. This unique password will be accepted by the projector no matter what the administrator password is. • If the Security Card is lost, please contact your local Acer service center. |
| <p>VGA OUT (Standby) (for X1130PA/ X1130PS/ X1230P/ X1230PA/ X1230PK/ X1230PS/X1237)</p> | <p>Selecting "On" enables the function. The projector can output a VGA signal when it is in standby mode and the VGA IN (or VGA IN 1) and VGA OUT sockets are correctly connected to the devices.</p> <div style="text-align: center;">  ----- </div> <p>Enabling this function slightly increases the standby power consumption.</p> |
| <p>Reset</p> | <p>Press  after choosing "Yes" to return the display parameters on all menus to the factory default settings.</p> |

Management



| | |
|--------------------------------|---|
| ECO Mode | Choose "On" to dim the projector lamp, which will also lower the power consumption, reduce noise, and extend the lamp life. Choose "Off" to return to the normal mode. |
| High Altitude | Choose "On" to turn on the High Altitude mode. When this function is turned on, the projector fans operate at full speed continuously to cool down the projector's temperature. |
| Auto Shutdown (Minutes) | The projector will automatically shut down while there is no signal input detected after the setting time. |
| Lamp Hour Elapse | Displays the lamp's elapsed operating time (in hours). |
| Lamp Reminding | Choose this function to show or hide warning message when the changing lamp message is displayed. The message will show up 30 hours before end of life. |
| Lamp Hour Reset | Press  after choosing "Yes" to turn the lamp hour counter to 0 hours. |

Audio

(X1130PA/X1130PS/X1230P/
X1230PA/X1230PK/X1230PS/
X1237)

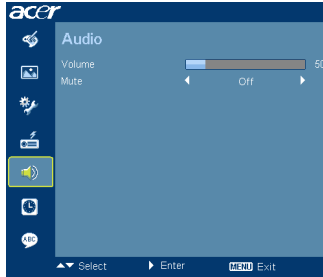

| | |
|---------------|--|
| Volume | <ul style="list-style-type: none"> • Press ◀ to decrease the volume. • Press ▶ to increase the volume. |
| Mute | <ul style="list-style-type: none"> • Choose "On" to turn mute on. • Choose "Off" to turn mute off. |

Timer

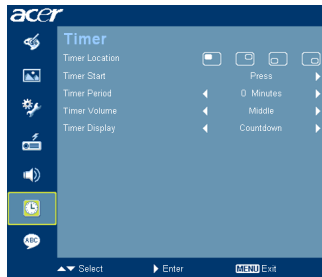

| | |
|-------------------------------|---|
| Timer Location | Sets the location of the timer on the screen. |
| Timer Start (or Stop) | Press ▶ to start or stop the timer. |
| Timer Period (Minutes) | Press ◀ ▶ to adjust the timer period. |

| | |
|----------------------|---|
| Timer Volume | Select this function to adjust the notification volume when the timer function is enabled and time is up. |
| Timer Display | Press ◀ ▶ to choose a timer display mode. |

Language



| | |
|-----------------|---|
| Language | <p>Sets a language for the OSD menu. Use ▲ ▼ to select your preferred language.</p> <ul style="list-style-type: none"> Press ▶ to confirm the selection. |
|-----------------|---|

Appendices

Troubleshooting

If you experience a problem with your Acer projector, refer to the following troubleshooting guide. If the problem persists, please contact your local reseller or service center.

Image Problems and Solutions

| # | Problem | Solution |
|---|--|---|
| 1 | No image appears onscreen | <ul style="list-style-type: none"> • Make sure all the cables are correctly connected as described in the "Getting Started" section. • Ensure none of the connector pins are bent or broken. • Check if the projection lamp has been securely installed. Please refer to the "Replacing the Lamp" section. • Make sure you have removed the lens cap and the projector is switched on. |
| 2 | Partial, scrolling or incorrectly displayed image (For PC (Windows 95/98/2000/XP)) | <ul style="list-style-type: none"> • Press "RESYNC" on the control panel or remote control. • For an incorrectly displayed image: <ul style="list-style-type: none"> • Open "My Computer > Control Panel," and then double-click the "Display" icon. • Select the "Settings" tab. • Verify that your display resolution setting is lower than or equal to UXGA (1600 x 1200). • Click the "Advanced Properties" button. <p>If the problem still appears, change the monitor display you are using and follow the steps below:</p> <ul style="list-style-type: none"> • Verify that the resolution setting is lower than or equal to UXGA (1600 x 1200). • Click the "Change" button under the "Monitor" tab. • Click "Show all devices > Standard monitor types" under the SP box, and choose the resolution mode you need under the "Models" box. • Verify that the resolution setting of the monitor display is lower than or equal to UXGA (1600 x 1200). |

| | | |
|---|---|--|
| 3 | Partial, scrolling or incorrectly displayed image (For notebooks) | <ul style="list-style-type: none"> • Press "RESYNC" on the control panel or remote control. • For an incorrectly displayed image: <ul style="list-style-type: none"> • Follow the steps for item 2 (above) to adjust the resolution of your computer. • Press the toggle output settings. Example: [Fn]+[F4], Compaq [Fn]+[F4], Dell [Fn]+[F8], Gateway [Fn]+[F4], IBM [Fn]+[F7], HP [Fn]+[F4], NEC [Fn]+[F3], Toshiba [Fn]+[F5] • If you experience difficulty changing resolutions or your monitor freezes, restart all equipment including the projector. |
| 4 | The screen of the notebook computer is not displaying your presentation | <ul style="list-style-type: none"> • If you are using a Microsoft® Windows® based notebook: Some notebook PCs may deactivate their own screens when a second display device is in use. Each has a different way to be reactivated. Refer to your computer's manual for detailed information. • If you are using an Apple® Mac® OS based notebook: In System Preferences, open Display and select Video Mirroring "On." |
| 5 | Image is unstable or flickering | <ul style="list-style-type: none"> • Use "Tracking" to correct it. Refer to the "Image" section for more information. • Change the display color setting on your computer. |
| 6 | Image has vertical flickering bar | <ul style="list-style-type: none"> • Use "Frequency" to make an adjustment. Refer to the "Image" section for more information. • Check and reconfigure the display mode of your graphics card to make it compatible with the projector. |
| 7 | Image is out of focus | <ul style="list-style-type: none"> • Make sure the lens cap is removed. • Adjusts the focus ring on the projector lens. • Make sure the projection screen is within the required distance of 3.9 to 37.2 feet (1.2 to 11.3 meters) from the X1130P/X1130PA/X1230P/X1230PA/X1230PK/X1237 projector, or 1.6 to 18.0 feet (0.5 to 5.5 meters) from the X1130PS/X1230PS projector. Refer to the "How to Get a Preferred Image Size by Adjusting Distance and Zoom" section for more information. |

| | | |
|----|---|--|
| 8 | Image is stretched when displaying a "widescreen" DVD title | <p>When you play a DVD encoded in anamorphic or 16:9 aspect ratio you may need to adjust the following settings:</p> <ul style="list-style-type: none"> • If you play a 4:3 format DVD title, please change the format to 4:3 with the projector OSD. • If the image is still stretched, you will also need to adjust the aspect ratio. Set up the display format to 16:9 (wide) aspect ratio on your DVD player. |
| 9 | Image is too small or too large | <ul style="list-style-type: none"> • Adjust the zoom lever on the top of the projector. • Move the projector closer to or further from the screen. • Press "MENU" on the control panel or remote control. Go to "Image > Aspect Ratio" and try different settings. |
| 10 | Image has slanted sides | <ul style="list-style-type: none"> • If possible, reposition the projector so that it is centered on the screen and below the bottom of the screen. • Press the Keystone correction keys on the control panel or remote control until the image becomes square. • Press "MENU" on the control panel or remote control to open the OSD menu. Go to "Image > Auto Keystone" or "Image > Manual Keystone" to make adjustments. |
| 11 | Image is reversed | <ul style="list-style-type: none"> • Select "Image > Projection Mode", "Image > Projection Location" on the OSD and adjust the projection direction. |

Problems with the Projector

| # | Condition | Solution |
|---|--|--|
| 1 | The projector stops responding to all controls | If possible, turn off the projector, then unplug the power cord and wait at least 30 seconds before reconnecting power. |
| 2 | Lamp burns out or makes a popping sound | When the lamp reaches the end of its useful life, it will burn out and may make a loud popping sound. If this happens, the projector will not turn on until the lamp module has been replaced. To replace the lamp, follow the procedures in the "Replacing the Lamp" section. |

OSD Messages

| # | Condition | Message Reminder |
|---|-----------|---|
| 1 | Message | <p data-bbox="394 277 736 300">Fan Fail - the system fan is not working.</p> <div data-bbox="394 304 934 373" style="background-color: #0000FF; color: white; padding: 5px; text-align: center;"> <p data-bbox="631 316 697 335">Fan Fail.</p> <p data-bbox="521 339 805 359">Lamp will automatically turn off soon.</p> </div> <p data-bbox="394 387 932 491">Projector Overheated - the projector has exceeded its recommended operating temperature and must be allowed to cool down before it is used. Please also check the dust filters if they are installed. If the dust filter is clogged with dust, please clean it.</p> <div data-bbox="394 501 934 569" style="background-color: #0000FF; color: white; padding: 5px; text-align: center;"> <p data-bbox="579 512 746 531">Projector Overheated.</p> <p data-bbox="521 536 805 555">Lamp will automatically turn off soon.</p> </div> <p data-bbox="394 576 901 619">Replace the lamp - the lamp is about to reach its maximum lifetime. Prepare to replace it soon.</p> <div data-bbox="394 628 934 697" style="background-color: #0000FF; color: white; padding: 5px; text-align: center;"> <p data-bbox="407 639 921 659">Lamp is approaching the end of its useful life in full power operation.</p> <p data-bbox="572 663 756 683">Replacement suggested!</p> </div> |

LED & Alarm Definition Listing

LED Messages

| Message | Power LED | | Lamp LED | Temp LED |
|------------------------------------|----------------|----------------|----------------|----------------|
| | Red | Blue | Red | Red |
| Standby (Power cord plugged in) | V | -- | -- | -- |
| Power on | -- | V | -- | -- |
| Lamp retry | -- | Quick flashing | -- | -- |
| Turning off (Cooling state) | Quick flashing | -- | -- | -- |
| Turning off (Cooling completed) | V | -- | -- | -- |
| Error (Thermal failure) | -- | V | -- | V |
| Error (Fan lock failure) | -- | V | -- | Quick flashing |
| Error (Lamp breakdown) | -- | V | V | -- |
| Error (Color wheel failure) | -- | V | Quick flashing | -- |

Replacing the Lamp

Use a screwdriver to remove the screw(s) from the cover, and then pull out the lamp.

The projector will detect the lamp life itself. It will show you a warning message **"Lamp is approaching the end of its useful life in full power operation. Replacement Suggested!"** When you see this message, change the lamp as soon as possible. Make sure the projector has been cooled down for at least 30 minutes before changing the lamp.



Warning: Lamp compartment is hot! Allow it to cool down before changing lamp!

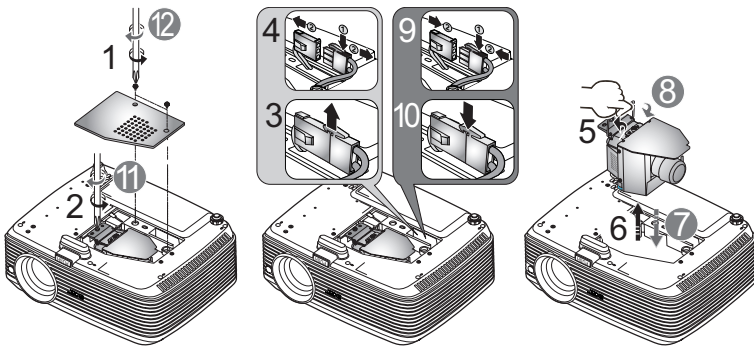

To remove the lamp:

- 1 Turn the projector off by pressing  (POWER).
- 2 Allow the projector at least 30 mins to cool down.
- 3 Disconnect the power cord.
- 4 Use a screwdriver to remove the screws from the cover. (Illustration #1)
- 5 Push up and remove the cover.
- 6 Remove the screw that secures the lamp module (Illustration #2).
- 7 Pull out the lamp connector from a slot in the lamp compartment (Illustration #3). Disconnect it from the projector (Illustration #4).
- 8 Lift the handle so that it stands up (Illustration #5). Pull out the lamp module by force (Illustration #6).

To replace the lamp module, use a new lamp and follow illustrations #7 - #12.



Warning: To reduce the risk of personal injury, do not drop the lamp module or touch the lamp bulb. The bulb may shatter and cause injury if it is dropped.

Ceiling Mount Installation

If you wish to install the projector using a ceiling mount, please refer to the steps below:

- 1 Drill four holes into a solid, structurally sound part of the ceiling, and secure the mount base.

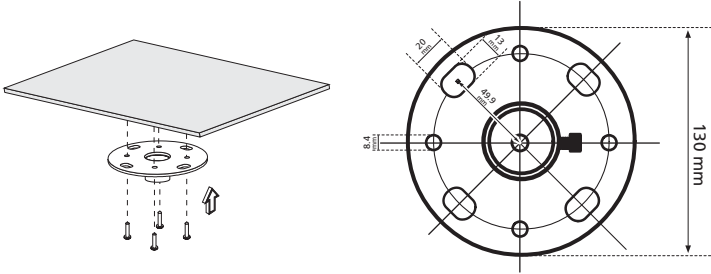

Note: Screws are not included. Please obtain the appropriate screws for your type of ceiling.

- 2 Secure the ceiling rod using the appropriate type of cylinder screws.

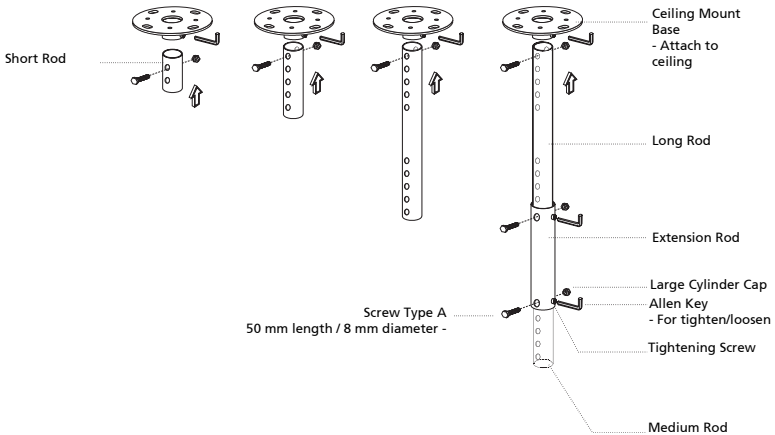

- 3 Use the appropriate number of screws for the projector size to attach the projector to the ceiling mount bracket.

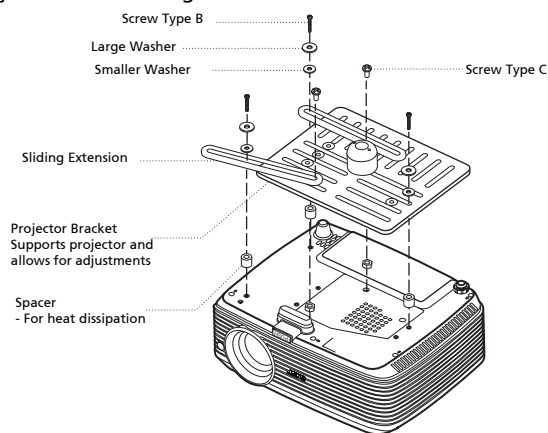

Note: It is recommended that you keep a reasonable space between the bracket and the projector to allow for proper heat distribution. Use two washers for extra support, if deemed necessary.

- 4 Attach the ceiling bracket to the ceiling rod.

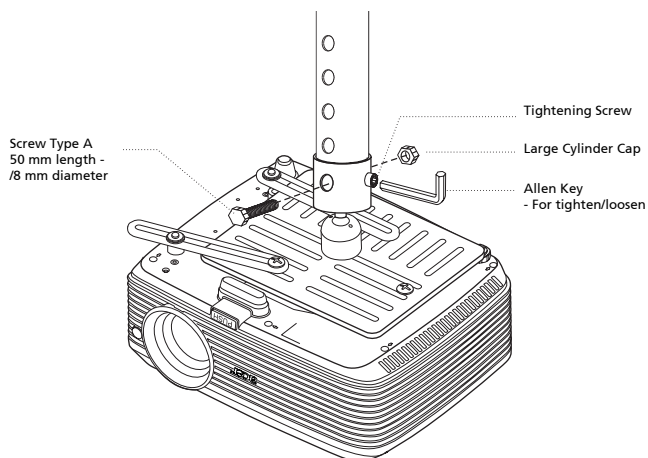

5 Adjust the angle and positioning as necessary.

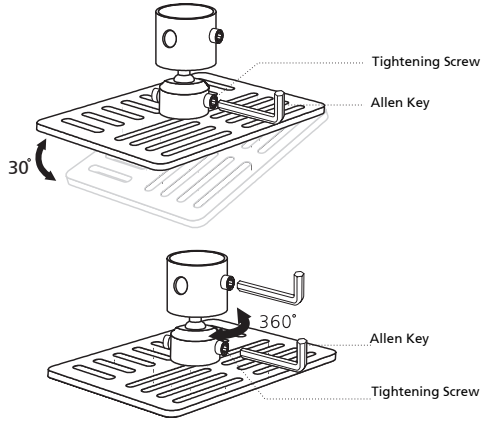

Note: The appropriate type of screw and washer for each model is listed in the table below. 3 mm diameter screws are enclosed in the screw pack.

| Models | Screw Type B | | Washer Type | |
|---|---------------|-------------|-------------|-------|
| | Diameter (mm) | Length (mm) | Large | Small |
| X1130P/X1130PA/ X1130PS/X1230P/ X1230PA/X1230PK/ X1230PS/X1237 | 3 | 25 | V | V |

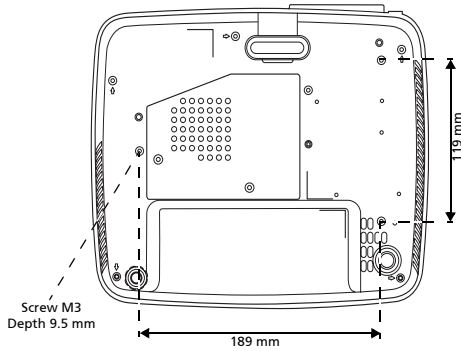

Specifications

The specifications below are subject to change without notice. For final specs, please refer to Acer's marketing documentation.

| | |
|-----------------------------------|--|
| Projection system | DLP™ |
| Resolution | <ul style="list-style-type: none"> X1130P/X1130PA/X1130PS: Native: SVGA (800 x 600) Maximum: UXGA (1600 x 1200) X1230P/X1230PA/X1230PK/X1230PS/X1237: Native: XGA (1024 x 768) Maximum: UXGA (1600 x 1200) |
| Computer compatibility | IBM PC and compatibles, Apple Macintosh, iMac and VESA standards: WXGA+ (1440 x 900), WXGA (1280 x 800, 1280 x 768), SXGA (1280 x 1024), SXGA+ (1400 x 1050), XGA (1024 x 768), SVGA (800 x 600), VGA (640 x 480), UXGA (1600 x 1200) |
| Video compatibility | NTSC (3.58/4.43), PAL (B/D/G/H/I/M/N), SECAM (B/D/G/K/K1/L), HDTV (720p, 1080i, 1080p), EDTV (480p, 576p), SDTV (480i, 576i) |
| Aspect ratio | 4:3 (native), 16:9 |
| Displayable colors | 1.07 billion colors |
| Projection lens | <ul style="list-style-type: none"> X1130P/X1130PA/X1230P/X1230PA/X1230PK/X1237: F = 2.56 - 2.8, f = 21.00 mm - 23.00 mm, 1:1.1 Manual Zoom and Manual Focus X1130PS/X1230PS: F = 2.6, f = 10.00 mm, Manual Focus |
| Projection screen size (diagonal) | <ul style="list-style-type: none"> X1130P/X1130PA/X1230P/X1230PA/X1230PK/X1237: 29" (73 cm) - 300" (762 cm) X1130PS/X1230PS: 27" (69 cm) - 300" (762 cm) |
| Projection distance | <ul style="list-style-type: none"> X1130P/X1130PA/X1230P/X1230PA/X1230PK/X1237: 3.9' (1.2 m) - 37.2' (11.3 m) X1130PS/X1230PS: 1.6' (0.5 m) - 18.0' (5.5 m) |
| Throw ratio | <ul style="list-style-type: none"> X1130P/X1130PA/X1230P/X1230PA/X1230PK/X1237: 53" @ 2 m (1.86 - 2.04 : 1) X1130PS/X1230PS: 109" @ 2 m (0.90 : 1) |
| Horizontal scan rate | 31 - 93 kHz |
| Vertical refresh scan rate | 48 - 86 Hz |
| Lamp type | Philips 185 W user-replaceable UHP |
| Keystone correction | <ul style="list-style-type: none"> X1130P/X1130PA/X1230P/X1230PA/X1237: +/-40 Degrees (Vertical), Manual X1130PS/X1230PK/X1230PS: +/-40 Degrees (Vertical), Manual & Auto |
| Digital zoom | 2 X |

| | |
|---------------------------|---|
| Audio | <ul style="list-style-type: none"> • X1130P: N/A • X1130PA/X1130PS/X1230P/X1230PA/X1230PK/X1230PS/X1237: 2 W x 1 |
| Weight | <ul style="list-style-type: none"> • X1130P/X1130PA/X1230P/X1230PA/X1230PK/X1237: Approximate 2.3 kg (5.07 lbs.) • X1130PS/X1230PS: Approximate 2.5 kg (5.51 lbs.) |
| Dimensions (W x D x H) | 264 x 225 x 95 mm (10.4" x 8.6" x 3.7") |
| Power supply | Universal AC input 100 - 240 V, input frequency 50/60 Hz |
| Power consumption | 280 W |
| Operating temperature | 0°C to 35°C / 32°F to 95°F |
| I/O connectors | <ul style="list-style-type: none"> • Power socket x 1 • RS232 x 1 • VGA input x 1 • Composite video x 1 • S-Video x 1 <p>Below items are for X1130PA/X1130PS/X1230P/X1230PA/X1230PK/X1230PS/X1237 only.</p> <ul style="list-style-type: none"> • 3.5 mm audio jack input x 1 • VGA output x 1 • USB x 1: for remote computer control <p>Below item are for X1130PA/X1230P/X1230PA/X1237 only.</p> <ul style="list-style-type: none"> • VGA input x 2 |
| Standard package contents | <ul style="list-style-type: none"> • AC power cord x 1 • VGA cable x 1 • Remote control x 1 • Battery x 2 (for the remote control) • User's guide (CD-ROM) x 1 • Quick start guide x 1 • Security card x 1 |
| Accessory (optional) | <ul style="list-style-type: none"> • Composite video cable x 1 • Carrying case x 1 |

* Design and specifications are subject to change without notice.

Compatibility Modes

1 VGA Analog - PC Signal

| Mode | Resolution | V.Frequency [Hz] | H.Frequency [KHz] |
|------------|-------------|------------------|-------------------|
| VGA_60 | 640 x 480 | 59.940 | 31.469 |
| VGA_72 | | 72.809 | 37.861 |
| VGA_75 | | 75.000 | 37.500 |
| VGA_85 | | 85.008 | 43.269 |
| VGA_70 | 720 x 400 | 70.087 | 31.469 |
| VGA_85 | | 85.039 | 37.927 |
| SVGA_56 | 800 x 600 | 56.250 | 35.156 |
| SVGA_60 | | 60.317 | 37.879 |
| SVGA_72 | | 72.188 | 48.077 |
| SVGA_75 | | 75.000 | 46.875 |
| SVGA_85 | | 85.061 | 53.674 |
| XGA_60 | 1024 x 768 | 60.004 | 48.363 |
| XGA_70 | | 70.069 | 56.476 |
| XGA_75 | | 75.029 | 60.023 |
| XGA_85 | | 84.997 | 68.667 |
| SXGA_70 | 1152 x 864 | 70.012 | 63.851 |
| SXGA_75 | | 75.000 | 67.500 |
| SXGA_85 | | 84.990 | 77.094 |
| SXGA_60 | 1280 x 1024 | 60.020 | 63.981 |
| SXGA_72 | | 72.000 | 76.970 |
| SXGA_75 | | 75.025 | 79.976 |
| SXGA_85 | | 84.024 | 91.146 |
| QuadVGA_60 | 1280 x 960 | 60.000 | 60.000 |
| QuadVGA_75 | | 75.000 | 75.000 |

| | | | |
|----------------|-----------------|---------|--------|
| SXGA+_60 | 1400 x 1050 | 59.978 | 65.317 |
| UXGA_60 | 1600 x 1200 | 60.000 | 75.000 |
| Mac G4 | 640 x 480@60Hz | 59.940 | 31.469 |
| MAC13 | 640 x 480@67Hz | 66.667 | 35.000 |
| Mac G4 | 800 x 600@60Hz | 60.317 | 37.879 |
| MAC16 | 832 x 624@75Hz | 74.546 | 49.722 |
| Mac G4 | 1024 x 768@60Hz | 60.004 | 48.363 |
| MAC19 | 1024 x 768@75Hz | 75.020 | 60.241 |
| MAC21 | 1152 x 870@75Hz | 75.061 | 68.681 |
| WXGA_60 | 1280 x 768 | 59.870 | 47.776 |
| WXGA_75 | | 74.893 | 60.289 |
| WXGA_85 | | 84.873 | 68.633 |
| WXGA_60 | 1280 x 720 | 60.000 | 45.000 |
| WXGA_60 | 1280 x 800 | 59.810 | 49.702 |
| WXGA+_60 | 1440 x 900 | 59.887 | 59.935 |
| 1680 x 1050_60 | 1680 x 1050 | 59.954 | 65.290 |
| 1920 x 1080_60 | 1920 x 1080 | 60.000 | 67.500 |
| 16:9 timing | 1366 x 768 | 59.790 | 47.712 |
| Acer AspireOne | 1024 x 600 | 60.000 | 37.500 |
| VGA_120 | 640 x 480 | 119.518 | 61.910 |
| SVGA_120 | 800 x 600 | 119.854 | 77.425 |
| XGA_120 | 1024 x 768 | 119.804 | 98.958 |

2 YPbPr Signal

| Modes | Resolution | V.Frequency [Hz] | H.Frequency [KHz] |
|-------|------------|------------------|-------------------|
| 480i | 720 x 480 | 59.94 | 15.73 |
| 480p | 720 x 480 | 59.94 | 31.47 |
| 576i | 720 x 576 | 50.00 | 15.63 |

| | | | |
|-------|-------------|-------|-------|
| 576p | 720 x 576 | 50.00 | 31.25 |
| 720p | 1280 x 720 | 60.00 | 45.00 |
| 720p | 1280 x 720 | 50.00 | 37.50 |
| 1080i | 1920 x 1080 | 60.00 | 33.75 |
| 1080i | 1920 x 1080 | 50.00 | 28.13 |
| 1080p | 1920 x 1080 | 60.00 | 67.5 |
| 1080p | 1920 x 1080 | 50.00 | 56.26 |

3 Video, S-Video Signal

| Modes | V.Frequency [Hz] | H.Frequency [KHz] | fsc (MHz) |
|----------|------------------|-------------------|--------------|
| NTSC | 15.73 | 60 | 3.58 |
| PAL | 15.63 | 50 | 4.43 |
| SECAM | 15.63 | 50 | 4.25 or 4.41 |
| PAL-M | 15.73 | 60 | 3.58 |
| PAL-N | 15.63 | 50 | 3.58 |
| PAL-60 | 15.73 | 60 | 4.43 |
| NTSC4.43 | 15.73 | 60 | 4.43 |

Regulations and safety notices

FCC notice

This device has been tested and found to comply with the limits for a Class B digital device pursuant to Part 15 of the FCC rules. These limits are designed to provide reasonable protection against harmful interference in a residential installation. This device generates, uses, and can radiate radio frequency energy and, if not installed and used in accordance with the instructions, may cause harmful interference to radio communications.

However, there is no guarantee that interference will not occur in a particular installation. If this device does cause harmful interference to radio or television reception, which can be determined by turning the device off and on, the user is encouraged to try to correct the interference by one or more of the following measures:

- Reorient or relocate the receiving antenna.
- Increase the separation between the device and receiver.
- Connect the device into an outlet on a circuit different from that to which the receiver is connected.
- Consult the dealer or an experienced radio/television technician for help.

Notice: Shielded cables

All connections to other computing devices must be made using shielded cables to maintain compliance with FCC regulations.

Notice: Peripheral devices

Only peripherals (input/output devices, terminals, printers, etc.) certified to comply with the Class B limits may be attached to this equipment. Operation with non-certified peripherals is likely to result in interference to radio and TV reception.

Caution

Changes or modifications not expressly approved by the manufacturer could void the user's authority, which is granted by the Federal Communications Commission, to operate this device.

Operation conditions

This device complies with Part 15 of the FCC Rules. Operation is subject to the following two conditions: (1) this device may not cause harmful interference, and (2) this device must accept any interference received, including interference that may cause undesired operation.

Notice: Canadian users

This Class B digital apparatus complies with Canadian ICES-003.

Remarque à l'intention des utilisateurs canadiens

Cet appareil numérique de la classe B est conforme à la norme NMB-003 du Canada.

Declaration of Conformity for EU countries

Acer hereby, declares that this projector series is in compliance with the essential requirements and other relevant provisions of Directive 1999/5/EC.

Compliant with Russian regulatory certification



ME61

Radio device regulatory notice



Note: The regulatory information below is for models with wireless LAN and/or Bluetooth only.

General

This product complies with the radio frequency and safety standards of any country or region in which it has been approved for wireless use. Depending on configurations, this product may or may not contain wireless radio devices (such as wireless LAN and/or Bluetooth modules). The below information is for products with such devices.

Canada — Low-power license-exempt radio communication devices (RSS-210)

- a Common information
Operation is subject to the following two conditions:
 1. This device may not cause interference, and
 2. This device must accept any interference, including interference that may cause undesired operation of the device.
- b Operation in 2.4 GHz band
To prevent radio interference to the licensed service, this device is intended to be operated indoors and installation outdoors is subject to licensing.

List of applicable countries

EU member states as of July 2009 are: Belgium, Denmark, Germany, Greece, Spain, France, Ireland, Italy, Luxembourg, the Netherlands, Austria, Portugal, Finland, Sweden, United Kingdom, Estonia, Latvia, Lithuania, Poland, Hungary, Czech Republic, Slovak Republic, Slovenia, Cyprus, Malta, Bulgaria, and Romania. Usage allowed in the countries of European Union, as well as Norway, Switzerland, Iceland and Liechtenstein. This device must be used in strict accordance with the regulations and constraints in the country of use. For further information, please contact a local office in the country of use.



Acer Incorporated
8F, 88, Sec. 1, Hsin Tai Wu Rd., Hsichih
Taipei Hsien 221, Taiwan



Declaration of Conformity

We,

Acer Incorporated
8F, 88, Sec. 1, Hsin Tai Wu Rd., Hsichih, Taipei Hsien 221, Taiwan
Contact Person: Mr. Easy Lai, e-mail: easy_lai@acer.com.tw

And,

Acer Europe SA
Via Cantonale, Centro Galleria 2 6928 Manno Switzerland

Hereby declare that:

| | |
|----------------------|--|
| Product: | Projector |
| Trade Name: | Acer |
| Model Number: | QSV0904/QSV0905/QSV0903/QNX0907/QNX0906/ QNX0901/QNX0902/QNX0908 |
| Machine Type: | X1130P/X1130PA/X1130PS/X1230P/X1230PA/ X1230PK/X1230PS/X1237 series |

Is compliant with the essential requirements and other relevant provisions of the following EC directives, and that all the necessary steps have been taken and are in force to assure that production units of the same product will continue comply with the requirements.

EMC Directive 2004/108/EC as attested by conformity with the following harmonized standards:

- EN55022, AS/NZS CISPR22, Class B
- EN55024
- EN61000-3-2 Class A
- EN61000-3-3

Low Voltage Directive 2006/95/EC as attested by conformity with the following harmonized standard:

- EN60950-1: 2001 + A11: 2004

RoHS Directive 2002/95/EC on the Restriction of the Use of certain Hazardous Substances in Electrical and Electronic Equipment

- The maximum concentration values of the restricted substances by weight in homogenous material are:

| | | | |
|---------------------|------|---|-------|
| Lead | 0.1% | Polybrominated Biphenyls (PBB's) | 0.1% |
| Mercury | 0.1% | Polybrominated Diphenyl Ethers (PBDE's) | 0.1% |
| Hexavalent Chromium | 0.1% | Cadmium | 0.01% |

Directive 2005/32/EC of the European Parliament and of the Council with regard to Eco-design RequireThe standards listed below are applied to the product if built with WLAN module or wireless keyboard and mouse.



R&TTE Directive 1999/5/EC as attested by conformity with the following harmonized standard:

- **Article 3.1(a) Health and Safety**
 - EN60950-1
 - EN62311
- **Article 3.1(b) EMC**
 - EN301 489-1
 - EN301 489-17
- **Article 3.2 Spectrum Usages**
 - EN300 328
 - EN301 893 (Applicable to 5GHz high performance RLAN).

Year to begin affixing CE marking 2009.

Easy Lai

Easy Lai /Manager
Regulation Center, Acer Inc.

Aug. 12, 2009 -
Date



Acer America Corporation
 333 West San Carlos St., San Jose
 CA 95110, U. S. A.
 Tel: 254-298-4000
 Fax: 254-298-4147
 www.acer.com



Federal Communications Commission Declaration of Conformity

This device complies with Part 15 of the FCC Rules. Operation is subject to the following two conditions: (1) this device may not cause harmful interference, and (2) this device must accept any interference received, including interference that may cause undesired operation.

The following local Manufacturer / Importer is responsible for this declaration:

| | |
|-------------------------------|--|
| Product: | DLP Projector |
| Model Number: | QSV0904/QSV0905/QSV0903/ QNX0907/QNX0906/QNX0901/ QNX0902/QNX0908 |
| Machine Type: | X1130P/X1130PA/X1130PS/ X1230P/X1230PA/X1230PK/ X1230PS/X1237 series |
| Name of Responsible Party: | Acer America Corporation |
| Address of Responsible Party: | 333 West San Carlos St. San Jose, CA 95110 U. S. A. |
| Contact Person: | Acer Representative |
| Phone No.: | 254-298-4000 |
| Fax No.: | 254-298-4147 |

Free Manuals Download Website

<http://myh66.com>

<http://usermanuals.us>

<http://www.somanuals.com>

<http://www.4manuals.cc>

<http://www.manual-lib.com>

<http://www.404manual.com>

<http://www.luxmanual.com>

<http://aubethermostatmanual.com>

Golf course search by state

<http://golfingnear.com>

Email search by domain

<http://emailbydomain.com>

Auto manuals search

<http://auto.somanuals.com>

TV manuals search

<http://tv.somanuals.com>