

PTAC WIRELESS KITS (DT01G, DS01E, DD01E) INSTALLATION INSTRUCTIONS

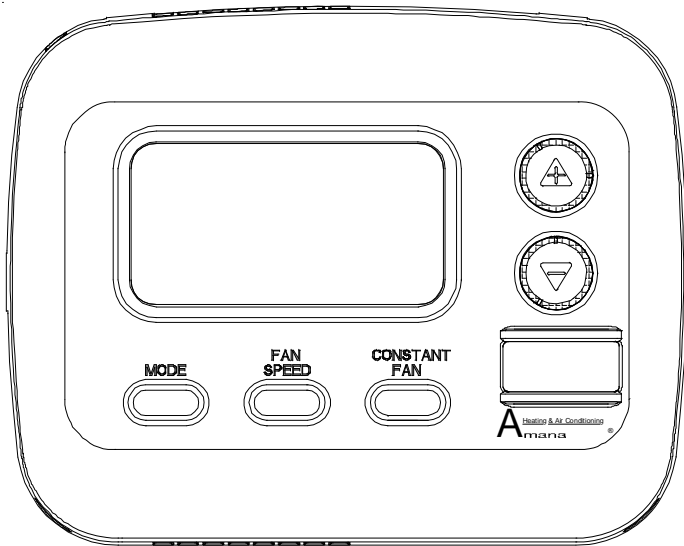

DS01E

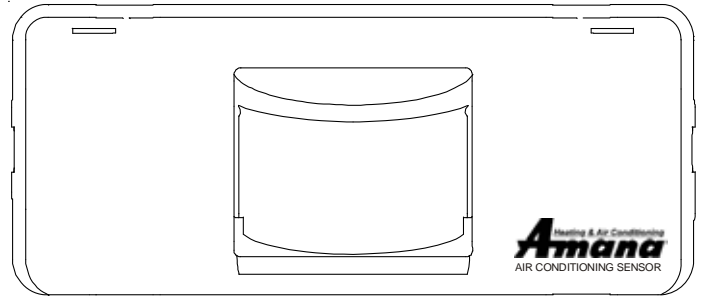

DD01E

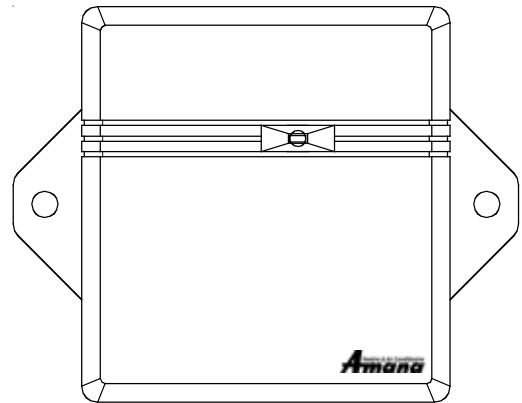

DT01G

The following installation instructions are for a typical installation.
Please contact your PTAC salesperson
for additional assistance and explanation prior to ordering materials or cutting openings.

ATTENTION INSTALLING PERSONNEL

As a professional installer you have an obligation to know the product better than the customer.
This includes all safety precautions and related items.

Prior to actual installation, thoroughly familiarize yourself with this Instruction Manual.
Pay special attention to all safety warnings. Often during installation or repair
it is possible to place yourself in a position which is more hazardous than when the unit is in operation.

Remember, it is **your** responsibility to install the product safely and to know it well enough
to be able to instruct a customer in its safe use.

Safety is a matter of common sense...a matter of thinking before acting.
Most dealers have a list of specific good safety practices...follow them.

The precautions listed in this Installation Manual are intended as supplemental to existing practices.
However, if there is a direct conflict between existing practices and the content of this manual,
the precautions listed here take precedence.

 is a registered trademark of Maytag Corporation or its related companies
and is used under license to Goodman Company, L.P., Houston, TX. All rights reserved.

Goodman Company, L.P.

5151 San Felipe, Suite 500 • Houston, TX 77056

www.amana-ptac.com • © 2009-2010 Goodman Company, L.P.

August 2010
IO-729A

Due to policy of continued product improvement, the right is reserved to change specifications and design without notice.



BEFORE BEGINNING INSTALLATION, PLEASE READ IMPORTANT NOTES BELOW:

- If devices are to be powered, field installed wiring will need to be run from thermostat location to unit location and from door sensor location to PTAC location and from wired magnet to sensor location.
- If wireless platform DP01G, DP01E or DL01E are being utilized, then room numbers **MUST BE CONFIGURED** in the control board prior to binding wireless devices.
- All units must have DT01G antenna for wireless devices to communicate properly.
Sequence of installation:
 - 1) Mount the peripherals
 - 2) Verify operation of the door sensor
 - 3) Program room numbers
 - 4) Bind peripherals
 - 5) Reattach peripherals to their mounted backplates
 - 6) Install optional security screws
- Installation and videos are available on our website at www.amana-ptac.com.
- Use only one DD01E Passive Infrared Motion Sensor (PIR) door switch combination device and/or one DS01E to one DigiSmart™ PTAC unit.

Antenna Installation For DT01G Kit

A DT01* antenna must be installed on the digital PTAC to allow operation of either the DS01* remote RF thermostat or a DD01* combination PIR motion sensor and door switch.

⚠ WARNING

HIGH VOLTAGE
DISCONNECT ALL POWER BEFORE SERVICING OR INSTALLING THIS KIT. MULTIPLE POWER SOURCES MAY BE PRESENT. FAILURE TO DO SO MAY CAUSE PROPERTY DAMAGE, PERSONAL INJURY OR DEATH. THE "OFF" SWITCH DOES NOT DISCONNECT ALL POWER TO THE UNIT.



Preparation

1. Disconnect power to the unit by unplugging the power cord at the wall outlet or subbase, or disconnect power at the fuse box or circuit breaker.
2. If the cabinet front is screwed to the chassis, remove the 1/4" screw (or screws). See following figure.

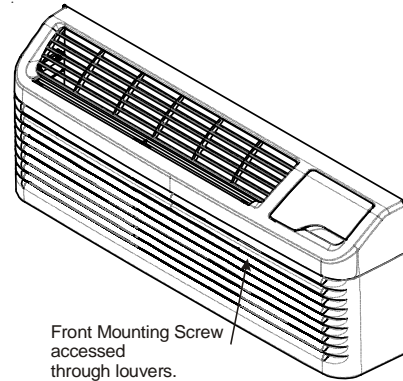

3. Remove cabinet front from chassis by tilting the bottom of the front forward, lifting slightly up and forward.
4. Mount the antenna as high up on the control panel as possible and as far to the right as possible in a location that will not interfere with the reinstallation of the PTAC polymer room front. Mark holes for screw location. Remove antenna housing and drill two 1/8" holes where marked. Some units may have the holes already pre-drilled in the correct location.

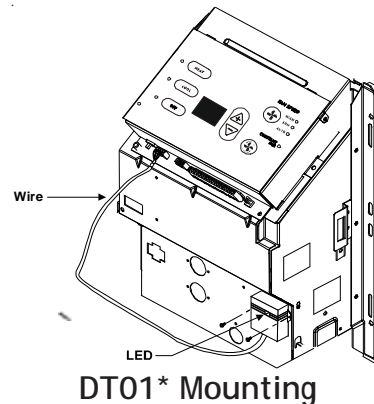

5. Remove antenna cable and route cable through opening in bottom of antenna housing.
6. Mount antenna housing with two screws as shown in figure. (NOTE: The Amana® brand logo should be in the lower right hand corner).
7. Plug wire harness from antenna into connector on the control board to the right of the master switch, being careful not to bend and/or break the wires when you connect the cable to the PTAC. Gently push the connector into place by pushing on the edge of the connector with your thumb nails. *Avoid pushing directly on the wires.*
8. Restore power to the PTAC unit.
9. Reinstall the polymer room cover.

NOTE: The LED must be oriented at the **top** of the antenna housing (the Amana® brand logo will be on the lower right) for proper unit operation.

Thermostat Installation for DS01E Kit

NOTE: A DT01* must be installed on the digital PTAC unit for the DS01* to be operable.

Skip these steps if not installing.

1. Select thermostat mounting location about five feet above the floor, on an inside wall, out of direct sunlight, away from sources of radiant heat (lamps, fireplaces, heating and air conditioning equipment, etc.), away from windows or door to the outside, and avoid areas with poor air circulation. If the PIR in the thermostat is to be used with a DD01* device as a 2nd motion sensor, point the thermostat towards the area where you are requiring additional motion sensing.

Ensure location is out of the path of foot traffic where a person might accidentally bump into the thermostats and damage the device.

2. Remove thermostat from mounting plate by pulling apart at the bottom of the thermostat about 1", and slide thermostat up to release from the top of the mounting plate.
3. Place thermostat mounting plate against the wall at desired location and mark placement of mounting holes. Make sure the UP arrow is pointing up on the mounting plate.
4. If mounting in drywall, tap plastic anchors into wall. For other surfaces, drill a 3/16" hole.
5. Screw mounting plate to the wall. **DO NOT SNAP THERMOSTAT INTO PLACE UNTIL AFTER BINDING PROCESS.** See *Binding Instructions on page 10.*
6. Install four (4) AA batteries (included) into the back of the thermostat. Terminals are marked "+" and "-" for polarity.

NOTE: Do not install thermostat on wall plate until all configuration settings and binding processes have been completed.

WIRED POWER OPTION

1. If the option for wired power is used, the two thermostat wires (20 gauge minimum field supplied) can be connected to the thermostat.
2. Route wires through the opening in the mounting plate.
3. Loosen set screws on wired terminal and insert wires into the opening. Tighten set screws. (See following figure for powered connection with 2 jumpers).
4. Connect wires at PTAC unit to terminal pins C and R. The wire harness kit PWHK01C is required for this connection.

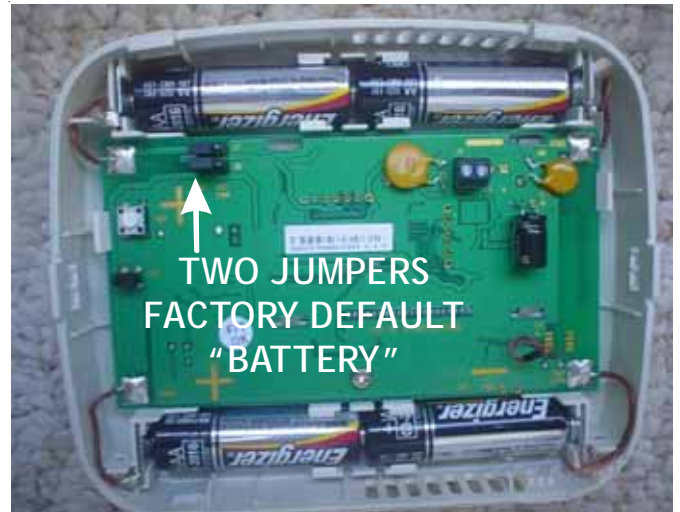

BATTERY CONNECTION

NOTE: For battery connection the 2 jumpers must be positioned as shown above, with jumpers on the center & left pins.

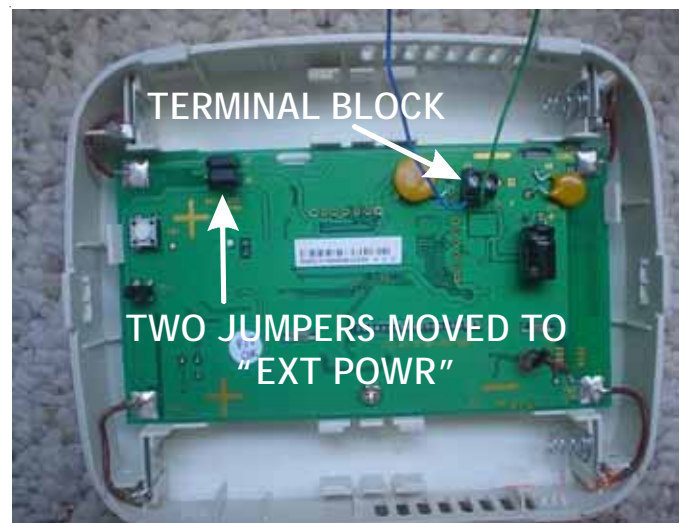

POWERED CONNECTION

NOTE: For powered connection, the 2 jumpers must be positioned as shown above, with jumpers on the center & right pins.

Mounting Sensor/Door Magnet Installation for DD01E Kit

DD01E must be mounted on the top door frame as close to the door as possible in the horizontal position.

A DT01E must be installed in the PTAC unit for the DD01E to be operable.

Skip these steps if not installing.

1. Remove motion sensor from mounting plate by pulling apart.
2. Mount the back plate on the door trim directly above the door using the enclosed screws. (Position so the UP arrow is pointing up.) Mount the DD01E as low as possible on the door frame to be as close to the moving part of the door as possible without interfering with the door opening or closing. Choose a location for mounting the back plate that will provide good coverage of the PIR for motion into the room. Make sure that the DD01E will not interfere with the normal opening and closing of the door.

DO NOT SNAP MOTION SENSOR IN PLACE UNTIL AFTER BINDING PROCESS.

See Binding Instructions, page 10.

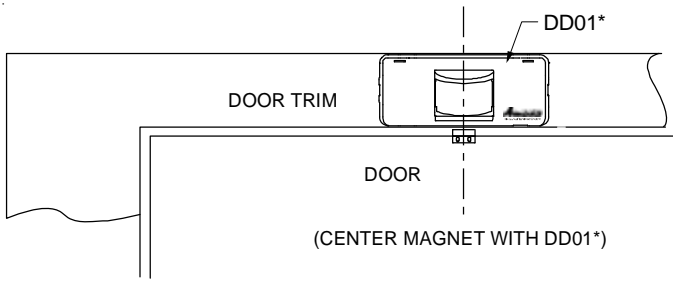

DD01E Mounting

3. Install two (2) AA batteries (included) into the back of the thermostat. Terminals are marked "+" and "-" for polarity. **Do NOT put batteries into the device until AFTER the magnet location is selected to test.**

WIRED MAGNET AND POWERED DOOR SENSOR OPTION

In cases where there is no top door frame, the sensor will need to be mounted on the wall next to the door. In these cases a wired magnet (a field supplied single pole single throw wired magnet) can be recessed or surface mounted and wired to the door sensor. The magnet will be a recessed style magnet with wired switch. The wires for the sensor (20 gauge field supplied) in the magnet will need to be run during construction. Two wires will be run from the door sensor location to the PTAC unit; the remaining two wires will be run from the magnet location to the sensor location. The door sensor has four (4) terminal locations for wired power and/or wired magnets. The two (2) terminals closest to the binding button are for wired magnet and the top two (2) terminals are for wired power.

Run the magnet wires through the opening in the center of the door sensor wall plate.

CONNECTING MAGNET

Using a pocket size straight blade screw driver push down on the terminal button to open the socket, insert wire into socket and release the terminal button. Insert one wire into each of the two (2) terminals. See image below for wire locations.

POWER CONNECTION

If using the wired powered option for the door sensor, using a pocket size straight blade screw driver, push down on the terminal button to open the socket. Insert wire into socket and release the terminal button. Insert one wire into each of the two (2) terminals. See following for wire locations. Connect the power wires from the door sensor to the PTAC on terminals C & R. The wire harness kit PWHK01C is required for this connection.

Viewed from the back with the power block in upper right corner.

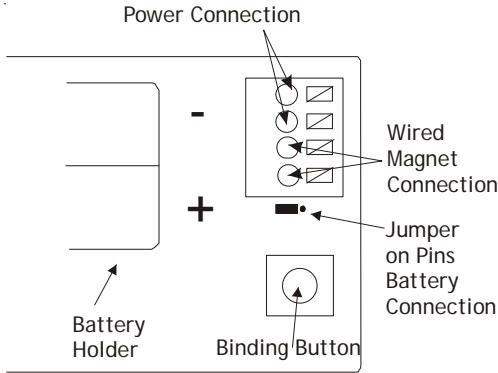
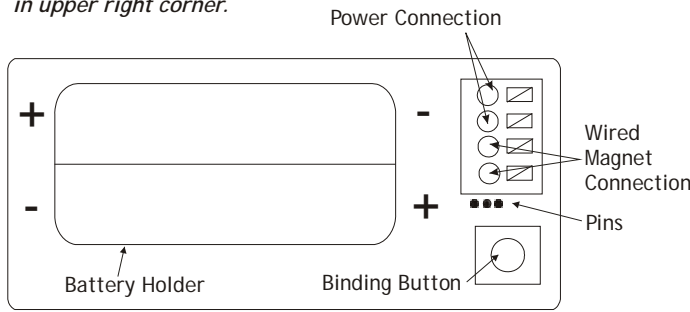

Note: For battery connection, the jumper must be placed as shown above

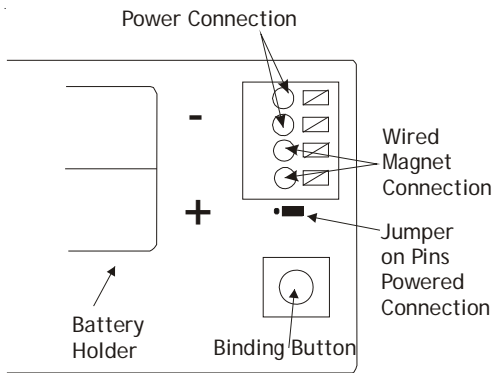

Note: For 24v powered connection, the jumper must be placed as shown above

Door Magnet Installation

NOTE: Magnet buckets are shipped from the factory with the magnets in position A. The position may change based on the door and door frame alignment on page 6.

Mount the door magnet holder on the front of the door where it will be as close as possible to the bottom of the motion sensor but no more than 1/8" from the bottom center of the motion sensor (DD01E) when the door is closed.

Select the correct slot in the magnet holder (there are three slots) to obtain 15/16" from back of sensor mounting plate to the center of the magnet. (If you can easily slide a business card between the magnet and the DD01E sensor, unit is properly placed vertically.) See image below for magnet and sensor alignment.

Screw in place with the 2 screws provided. Open and close the door to make sure that the magnet holder and motion sensor will not interfere with normal opening and closing of the door. See images on pages five and six.

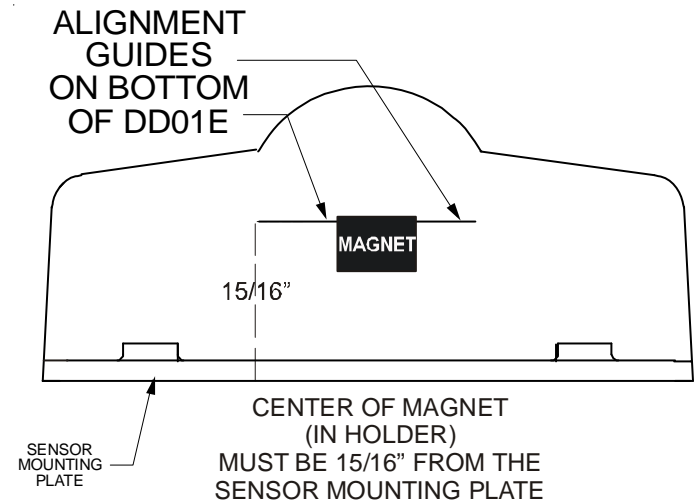

Do NOT install batteries until you are ready to test the magnet location with DD01E.

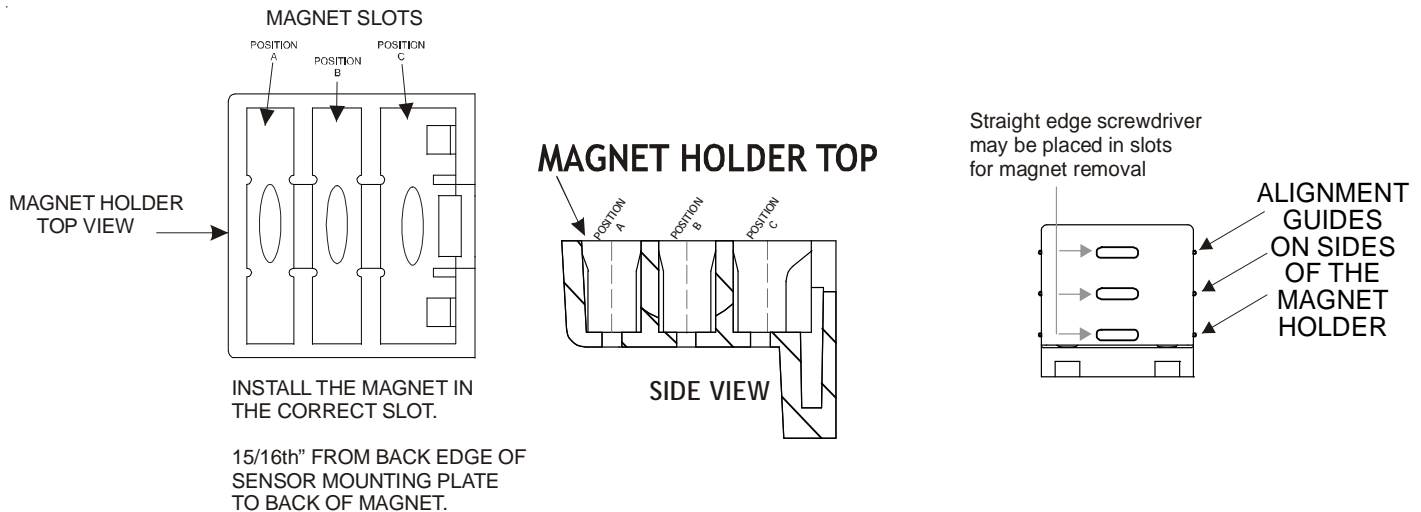
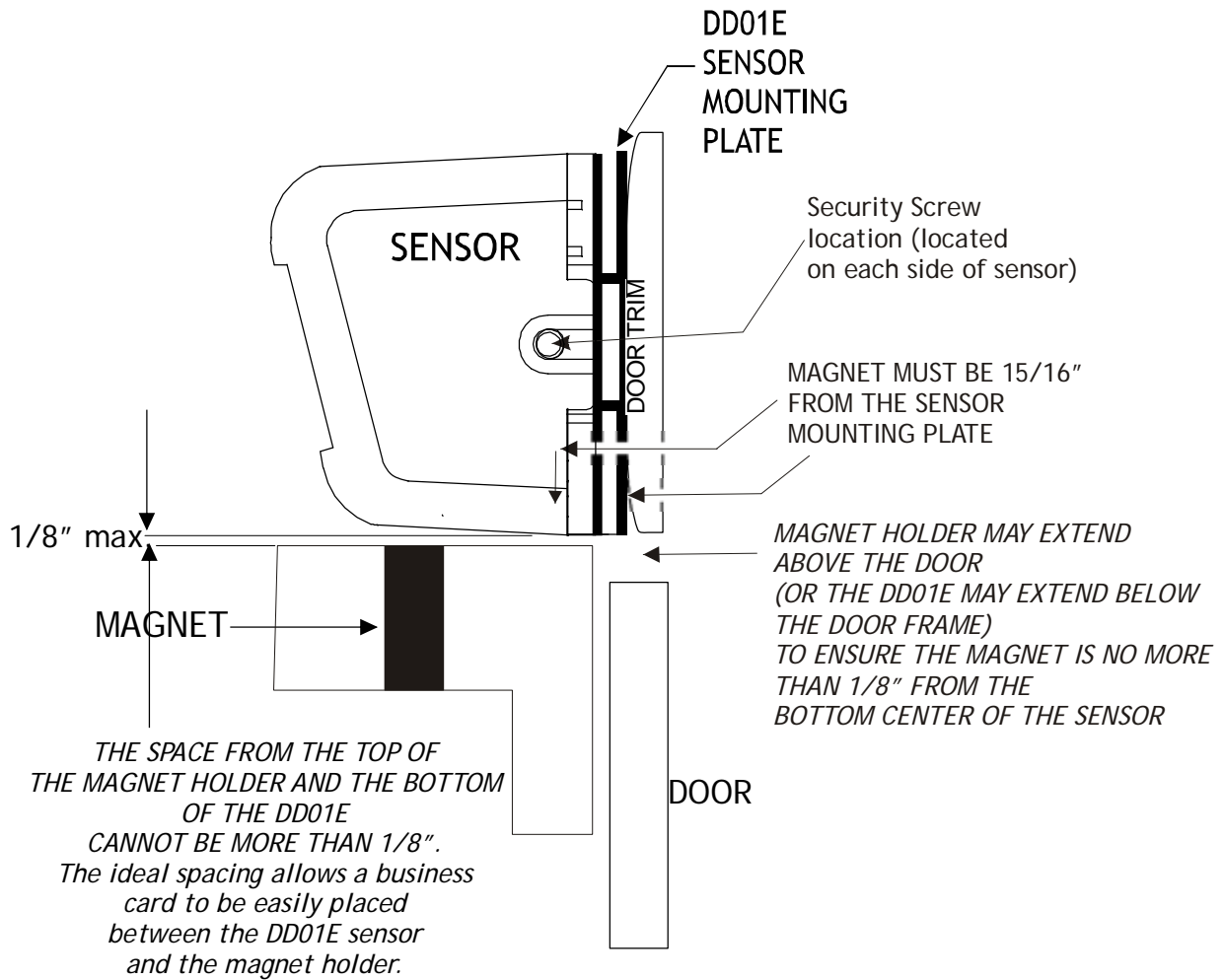

Select one of the three slots that places the magnet 15/16" from the sensor mounting plate on the door frame. See *following examples*. The door frame and door usually will not align. Place holder on the door and select the slot that places the magnet as close as possible to the 15/16" depth from the back of the DD01E mounting plate.

CONSTRUCTION STYLE 1

Place magnet in Position A in instances when the door and frame align.

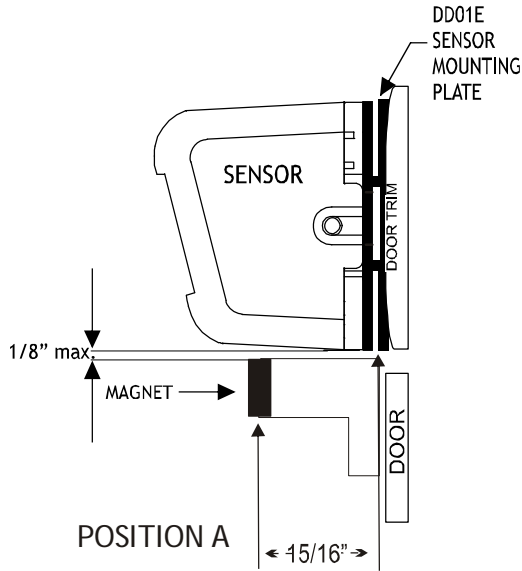

CONSTRUCTION STYLE 2

Place magnet in Position B in instances when the door extends into the room beyond the door frame.

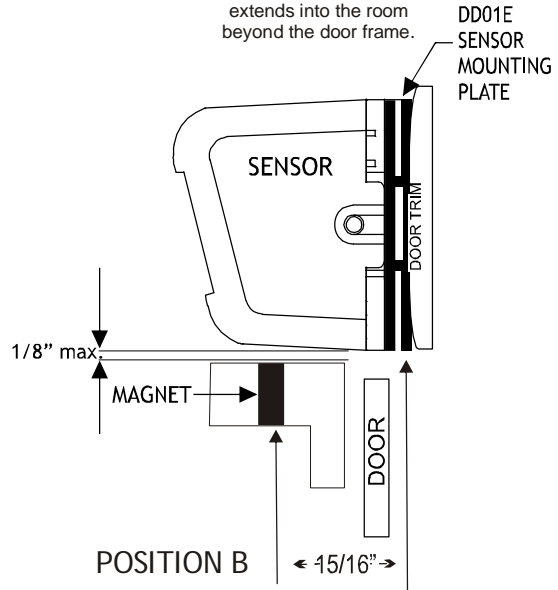

CONSTRUCTION STYLE 3

Place magnet in Position C in instances when the door extends into the room beyond the door frame.

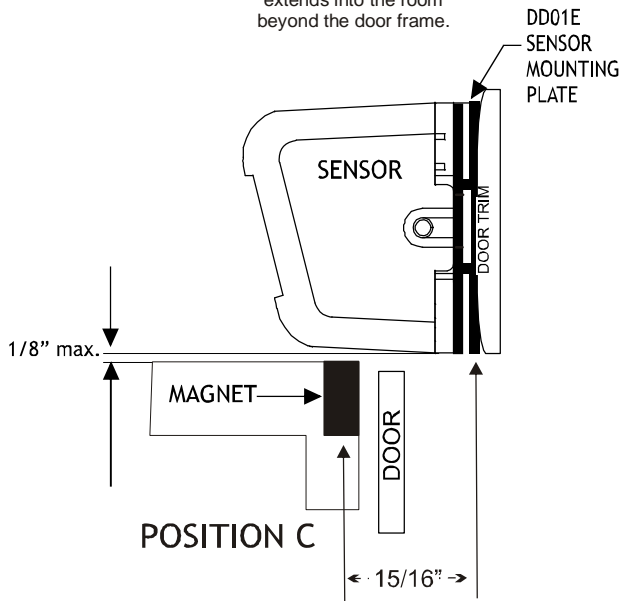

CONSTRUCTION STYLE 4

Place magnet in Position A in instances when the door frame extends into the room beyond the door.

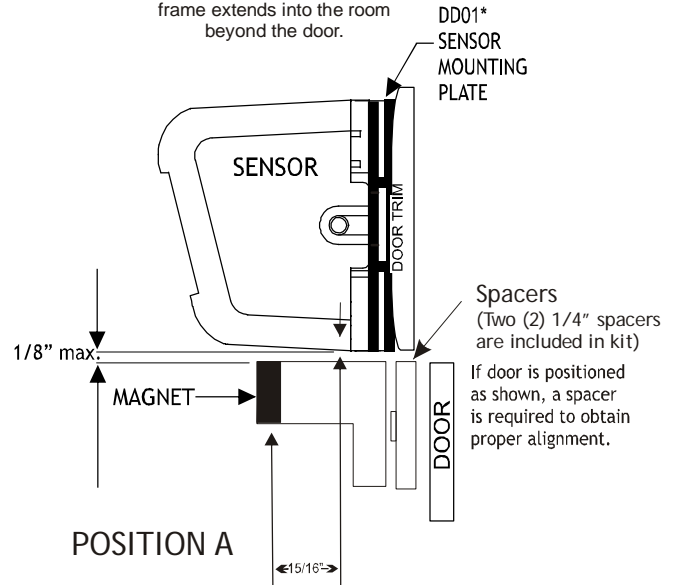

ABOVE SHOWS MAGNET $15/16''$ FROM THE SENSOR MOUNTING PLATE IN DIFFERENT SLOT POSITIONS

NOTE: Two (2) $1/4''$ spacers are provided in this kit for instances where the door is recessed behind the door trim.
See Construction style 4 above.

There is a line on the bottom of the DD01E to assist in aligning the magnet in the proper bucket location.

Above graphics are for example only. Always measure and place the magnet in the proper slot to obtain the $15/16''$ needed between the magnet and the sensor mounting plate on the door frame.

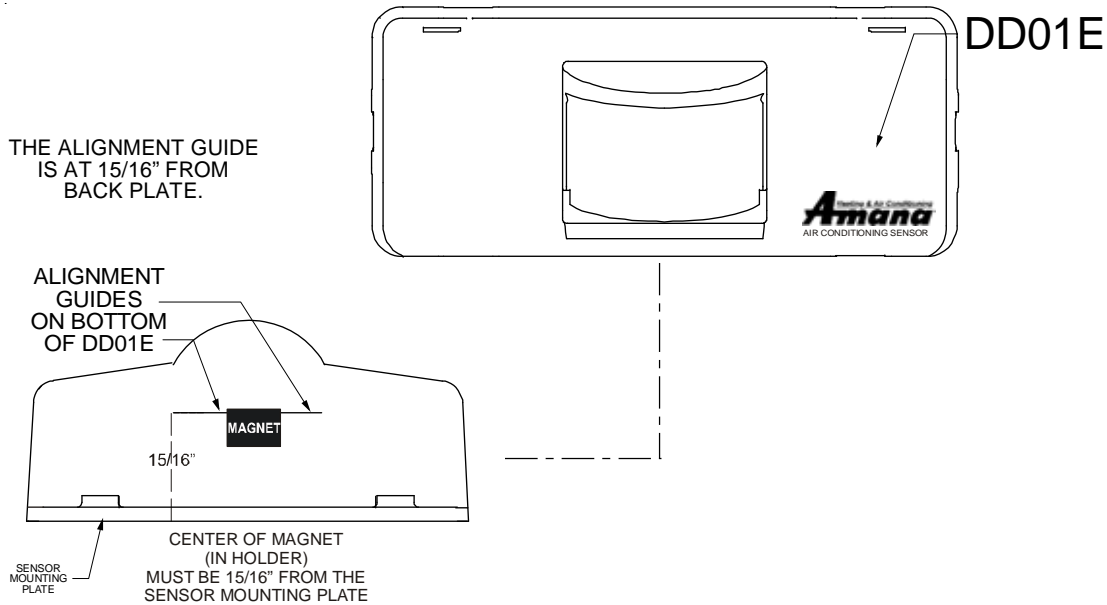

IMPORTANT NOTE: When properly installed, the center line mark on the bottom of the DD01E will line up with the center of the line of the magnet holder containing the magnet. Choose magnet position A, B, or C to align the magnet 15/16" from the back of the DD01E.

Door Sensor Operation Verification

NOTE: Do NOT attempt to bind a DD01E unless proper operation has been validated.

To verify that door sensor is installed properly:

1. Install batteries into DD01E and snap sensor onto wall plate.
2. Close the door. Green light in lens should illuminate. Open door and green light will turn off. **Repeat this step several times to ensure door sensor is operating correctly.**



Procedure must be accomplished within one minute. If not accomplished within one minute, remove batteries and repeat Steps 1 & 2.

Configuration Settings

The PTAC control will automatically self-configure to work with the wall thermostat (DS01E Kit) if installed and bound. The PTAC control will automatically self-configure to activate pre-configured energy management routine when the DD01E is installed and bound to the PTAC. Additionally, the setback times and setback temperatures can be changed using the configuration settings. If you are using DP01* Front Desk Platform, the PTAC control will need to be configured to identify its room number placement.

Standard and DS01E Configuration

To enter configuration feature mode:

Press and continue to hold the up and down  arrow keys and quickly press the OFF  key twice within a two (2) second time frame. You will see " - - " displayed. Once you are in the configuration program, you can use the HEAT button to move UP the various configuration settings or the COOL button to move DOWN the configuration settings. The + or - keys will move up or down the selectable codes that you can change for each configuration setting. Ensure that you are in the proper configuration setting before pressing the + or - key as you may accidentally change a setting that you did not intent to change.

The display will alternate between displaying the feature code [| and the option code 0 (factory default setting). Press the HEAT button one time to get into C1 mode and then the display will alternate between C1 and 0 - the factory default. If an RF DS01* has been bound to the unit the display will alternate between C1 and rE. The lower right dot on the display will flash.



DP01A, DP01E or DL01E



Entering Room Number *(Skip if not using DP01* Front Desk Platform)*



1. The PTAC control can be set for a 4-digit room number. To select the first two digits (floor), press the HEAT

 key until **C4** appears, then press the up  down arrows to select the first two digits.



2. To select the last two digits of the room number, press the HEAT  key until **C5** appears, then press the up



and down   arrows to select the last 2 digits of the room number.



For example for Room "201", press the HEAT  key until **C4** appears, then press the up  down arrows to select "02": **C4 = 02**.

Next to select the last two digits of the room number, press the HEAT  key until **C5** appears, then press the up and down   arrows to select "01": **C5 = 01**.

3. If a room contains more than one unit (a suite), a suffix must also be entered to identify which unit is in the main room and which unit(s) are in bedroom(s). Master unit ALWAYS MUST have a 01 suffix and slaves a suffix or 02, 03, etc. To select the room # suffix, while still in configuration mode, press the HEAT  key until **r5** appears.

Then press the up and down   arrows to select the room # suffix. Example: For the unit serving the main living

area in room 224, press the HEAT  key until **r5** appears, then press the up and down   arrow keys to select **00** (**r5 = 00** appears in the display). Since **00** is the factory default setting for configuration code **r5**, it may not be necessary to configure the suffix for the main room.

For the bedroom unit closest to the main room in room 224, press the up and down   arrow keys to select 01 **01** (**r5=01** appears in the display) Press the  key to exit configuration mode.

4. If a property identifies rooms by an alpha character (such as WINGS), a prefix must also be entered to identify room numbers (example: A-115). To select the room # prefix, while still in configuration mode, press the HEAT  key until **r4** appears.

Then press the up and down   arrows to select the room # prefix. Contact the manufacturer to have the prefix show as the correct letter on the platform.

Binding of RF Devices



IMPORTANT NOTE: If wireless platform DP01*, DP01E or DL01E are being utilized, then room numbers MUST BE CONFIGURED in the control board prior to binding wireless devices.

DO NOT ATTEMPT TO BIND MORE THAN ONE ROOM AT A TIME AT THE SAME PROPERTY!!!

RF TRANSMITS THROUGH WALLS.

The wireless devices (DS01E and or DD01E must be bound to the PTAC DT01E control for proper in-room communication. Ensure the unit is powered but in the OFF position.

NOTE: Both the DS01E and the DD01E must be bound to the PTAC unit during the same "learn" operation.

If you need to rebind one device - then you must rebind both devices during the same learn mode event.

All must be bound at one time.

1. Press and hold OFF button on the PTAC until appears.
2. Press and then immediately release the white tactile button on the back of the DS01* thermostat. should now be displayed on the PTAC LED display. If does not show on the display in 1-2 seconds, then press and release the white button a second time. Skip this step if there is no thermostat.

3. Press and then immediately release the white tactile button on the back of the DD01* motion sensor. or should now be displayed on the PTAC LED display.

If or does not show on the display in 1-2 seconds, then press and release the white button a second time. **NOTE:** If both a DD01* and a DS01* are being bound, then the display will show .

Skip if there is no motion sensor.

4. Press "OFF" on the PTAC touchpad to exit the binding sequence.
5. Slide top of the thermostat down onto the wall plate and then snap into place.
6. Provided optional security screws may be used in lower corners of the thermostat.

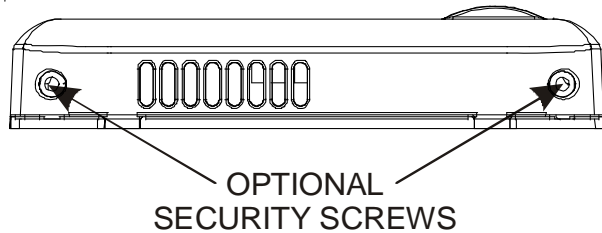

7. Snap motion sensor onto motion sensor mounting plate.
8. Provided optional security screws may be installed on right and left side of the sensor.
9. If you wish to change from the factory default settings, configure the device or devices that were bound. See the next section for configuration choices.

NOTE: If a wireless device is replaced or added, all devices (including those previously bound) will need to be bound/re-bound to the unit. See directions above.

CONFIGURATION SETTINGS CHART

Configuration Code	Description	Option Code	Description
C1	Interface	0*	Chassis Membrane*
		rE	Wireless Remote
		L5	Wired Thermostat
C2	Fan Operation	bP	Button present
		bA*	7-Button, reverts to Cyclic
		A	Always run fan (even in Off)
		bC	7-Button, reverts to Continuous
C3	Reverse Cycle Operation	C	Cooler Only
		H*	Heat Pump*
		0	Service No Operation "Eo"
C4	Room I.D. Digit 1 & 2	00* - 99	00* - 99
C5	Room I.D. Digit 3 & 4	00* - 99	00* - 99
C6	Wired Occupancy	0*	Off*
		1	On
		18	18 Hour Automatic Entry
C8	Temp. Limiting Cool	60* - 72	60* - 72
C9	Temp. Limiting Heat	68 - 90, 80*	68 - 90, 80*
Cd	English / Metric Temp	F*	Fahrenheit Scale*
		C	Celsius Scale
d6	Sensorless Un-Occ. Time	1 - 32, 18*	1 - 32, 18*
d7	1st Un-Occ. Set Back Temp.	1 - 16, 2*	1 - 16, 2*
d8	1st Un-Occ. Set Back Time	.1, .5*, 1 - 24	.1, .5, 1 - 24, .5*
d9	2nd Un-Occ. Set Back Temp.	1 - 16, 3*	1 - 16, 3*
dA	2nd Un-Occ. Set Back Time	.1, .5, 1* - 24	(d8) - 24, 1*
db	3rd Un-Occ. Set Back Temp.	1 - 16, 6*	1 - 16, 6*
dC	3rd Un-Occ. Set Back Time	.1, .5, 1 - 24, 3*	(dA) - 24, 3*
dF	Jace Group Code	00* - 99	00* - 99
r4	Room Prefix	00* - 99	00* - 99
r5	Room Suffix	00* - 99	00* - 99

See manufacturer for additional configuration options

Setback Temps - DD01E

The DD01* and the DigiSmart™ control can be programmed for 3 different times to activate temperature setbacks. The current factory default temperature setbacks in v2.5 * software release are: 2° from set point in 30 minutes, 3° in one (1) hour, and 6° in three (3) hours. For each time, you can select a setback temperature. The amount of setback is the amount of degrees the control will operate from guest's setting in degrees F. If a change to the factory default temperature settings is desired, use the following instructions.

NOTE: When first entering the configuration mode, if you see " - - " then you have version 2.5 or higher. You can verify the software version by starting with the unit in the OFF position, and while holding down the "+" and "-" buttons, double click the COOL button and then release and push the FAN button within one second. The unit display will scroll through all of the thermister temperatures and the last item displayed will be CS (current software) and you will see 25 for v2.5.

*Other software versions may have different factory setback defaults. Contact your PTAC representative to determine factory default settings.





WARNING



USE OF SETBACK TEMPERATURES

DO NOT USE MOTION SENSING SETBACK TEMPERATURES IN ROOMS WHERE INCAPACITATED PERSONS OR ANIMALS ARE UNABLE TO CHANGE THE CONTROL SETTING.



AN UNATTENDED AIR CONDITIONER WITH EXTREME SETBACKS MAY RESULT IN UNDESIRABLE OR UNHEALTHY TEMPERATURE IN THE CONDITIONED SPACE, CAUSING UNDER HEATING, UNDER COOLING OR DEATH OF PERSONS OR ANIMALS.

4. To select first unoccupied set back temperature, press the HEAT  key until  feature code comes up.

To scroll to a previously viewed feature codes, press the COOL  key.

Once you have scrolled to the  feature, press either the up or down arrow  to scroll to the desired first

unoccupied setback temperature. Cooling example: 72° (guest set point) + 2° (Setback temperature) = 74° (operational set point).

5. Press HEAT  key to scroll to  first unoccupied setback time. The first unoccupied setback time is the time between when the control determines that the room is not occupied and when the control sets the operating set point temperature back. The increments are in hours (.1 = 6 mins., .5 = 30 mins., 1 = 1 hour, etc.). Press ei-

ther the up or down arrow  to the desired first unoccupied setback time. c

6. To select second unoccupied setback temperature, press the HEAT  key until  comes up. Press either

the up or down arrow  to the desired second unoccupied setback temperature.



Cooling example: 72° (guest set point) + 4° (Setback temperature) = 76° (operational set point).

7. Press HEAT  key to scroll to  second unoccupied setback time. Press either the up or down arrow 

to the desired second unoccupied setback time. Example: Operating set point would be 76° instead of 72°, one hour (1.0 hour) after guest leaves room.

8. Press HEAT  key to scroll to  third unoccupied setback temperature. Press either the up or down arrow

 to the desired third unoccupied setback temperature.

9. Press HEAT  key to scroll to  third unoccupied setback time. Press either the up or down arrow  to the desired third unoccupied setback time.

10. To exit configuration mode:

Press the OFF  key. **NOTE:** Configuration feature mode will also automatically exit if no keys are pressed for a period of two (2) minutes.

The changes made in configuration mode are now in effect.

NOTE: Additional codes are present and may be accessed within this menu. Contact the manufacturer for additional information.

Suggested Wireless Thermostat Locations in Typical Room Layouts

Select thermostat mounting location about five feet above the floor, on an inside wall, out of direct sunlight, away from sources of radiant heat (lamps, fireplaces, heating and air conditioning equipment, etc.), away from windows or door to the outside, and avoid areas with poor air circulation. Ensure location is out of the path of foot traffic where a person might accidentally bump into the thermostats and damage the device.

NOTE: Due to the motion sensor inside the thermostat, do not point towards a window.

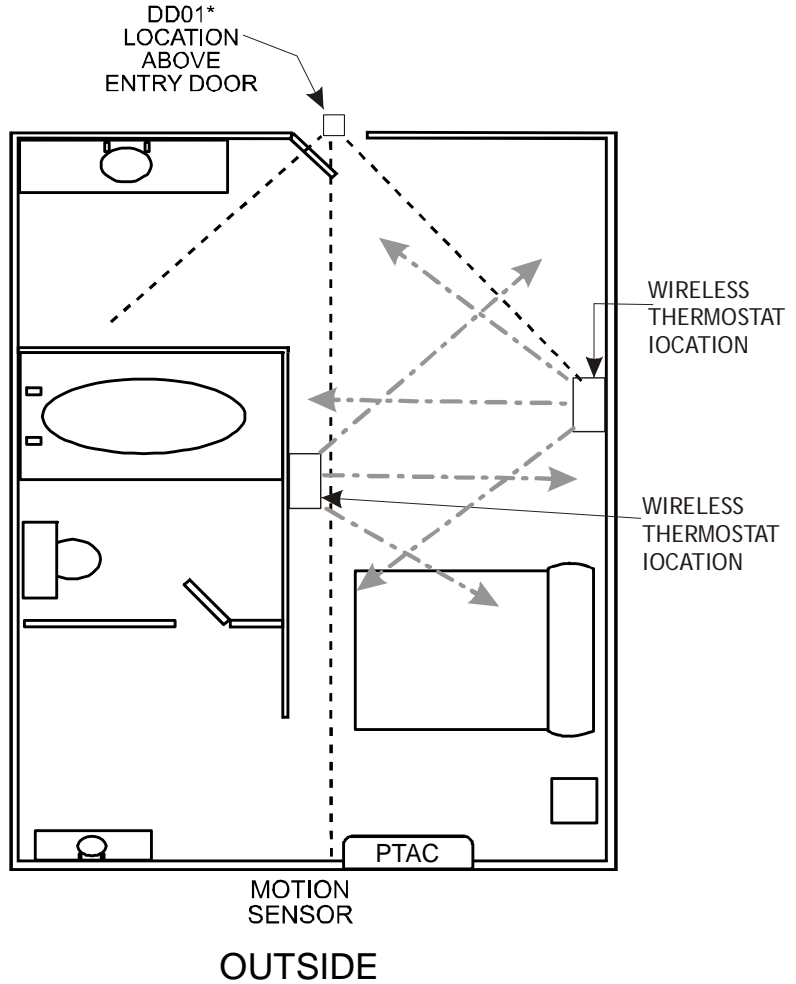
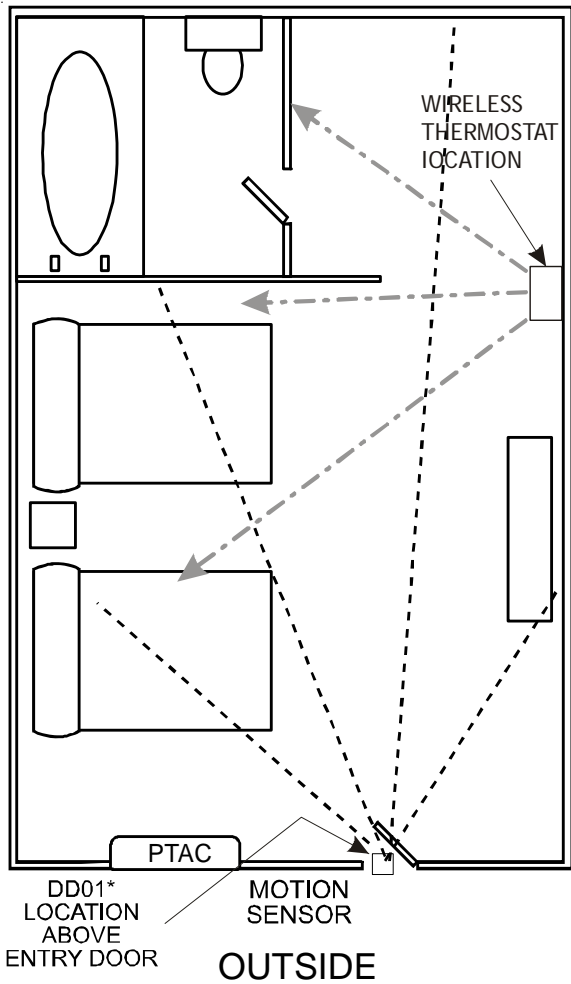

CAUTION

This equipment is authorized for use under the United States Federal Communication Commission Rules and Regulations, Code of Federal Regulations Chapter 47 part 15 and must be installed in accordance with the instructions provided in this document. Failure to install or operate this equipment as instructed in this document could void the user's authority to operate the equipment. This equipment contains no user serviceable parts. Any modification or repairs to the internal components or to the antenna configuration of the equipment without the express written consent of Everex Communications, Inc., could void the user's authority to operate the equipment.

NOTE: To comply with FCC RF exposure requirements in section 1.1307, a minimum separation distance of 20cm (8 inches) is required between the equipment and all persons.

NOTE: This equipment has been tested and found to comply with the limits for a Class B digital device, pursuant to Part 15 of the FCC Rules. These limits are designed to provide reasonable protection against harmful interference in a residential installation. This equipment generates, uses and can radiate radio frequency energy and, if not installed and used in accordance with the instructions, may cause harmful interference to radio communications. However, there is no guarantee that interference will occur in a particular installation. If this equipment does cause harmful interference to radio or television reception, which can be determined by turning the equipment off and on, the user is encouraged to try to correct the interference by one or more of the following measures:

- Reorient or relocate the receiving antenna.
- Increase the separation between the equipment and receiver.
- Connect the equipment into an outlet on a circuit different from that to which the receiver is connected.
- Consult the dealer or an experienced radio/TV technician for help.

THIS PAGE LEFT BLANK INTENTIONALLY



Amana Heating & Air Conditioning is a registered trademark of Maytag Corporation or its related companies and is used under license to Goodman Company, L.P., Houston, TX. All rights reserved.

Goodman Company, L.P.
5151 San Felipe, Suite 500 • Houston, TX 77056
www.amana-ptac.com • © 2009 - 2010 Goodman Company, L.P.
16

Free Manuals Download Website

<http://myh66.com>

<http://usermanuals.us>

<http://www.somanuals.com>

<http://www.4manuals.cc>

<http://www.manual-lib.com>

<http://www.404manual.com>

<http://www.luxmanual.com>

<http://aubethermostatmanual.com>

Golf course search by state

<http://golfingnear.com>

Email search by domain

<http://emailbydomain.com>

Auto manuals search

<http://auto.somanuals.com>

TV manuals search

<http://tv.somanuals.com>