



Start Here! Quick Setup Guide

Simple Steps to Get Your AeroGarden Up and Growing (No tools required)



AeroGarden™ 7

Welcome to the world of indoor gardening!

The AeroGarden 7 is one of the most advanced countertop gardens in the world, and it's easy to use. In fact, the AeroGarden 7 is ready to grow in less than five minutes with just five easy steps that anyone can do!

This handy *Quick Setup Guide* shows you how to get started and provides everything you need to know about the AeroGarden 7's operation, and also offers tending and harvesting tips for your new garden.

Keep This Guide!

IMPORTANT SAFETY INSTRUCTIONS

When using this AeroGarden electrical furnishing, basic precautions should always be followed, including the following:

Read all instructions before using this AeroGarden furnishing.

1. To reduce the risk of electric shock, the AeroGarden has a specific plug. Do not change the plug in any way.

DANGER – to reduce risk of electric shock:

2. Always unplug the AeroGarden from electrical outlet before cleaning or changing Grow Lights (light bulbs).

WARNING – to reduce risk of burns, fire, electric shock, or injury to persons:

3. Unplug AeroGarden from outlet before putting on or taking off parts.

4. Close supervision is necessary when an AeroGarden is used by or near children, invalids, or disabled persons.

5. Use AeroGarden only for its intended use as described in the instructions. Do not use attachments not recommended by manufacturer.

6. Never operate AeroGarden if it has a damaged cord or plug, if it is not working properly, if it has been dropped and damaged, or if it has been dropped in water. If any of these conditions occur/exist, contact www.AeroGardenSupport.com or your country's local distributor for instructions.

7. Keep cord away from heated surfaces.

8. Never operate furnishing with air openings blocked. Keep air openings free of lint, hair, and the like.

9. Never drop or insert any object into any electrical openings.

10. Do not use outdoors.

11. Do not operate where aerosol (spray) products are being used or where oxygen is being administered.

12. Do not touch moving parts or hot parts such as pumps, bulbs, reflective surfaces, and the like.

13. To disconnect, remove plug from outlet.

14. Do not place or submerge base, cord, plug, or lamp hood in water or other liquid to clean it.

15. Do not allow water to contact hot light bulbs.

16. Use only approved and supplied parts and accessories. Use only AeroGarden brand Grow Lights with this AeroGarden model. Use of any other kind of accessory is not recommended. Replacement parts can be ordered from www.AeroGarden.com

17. Do not use AeroGarden for other than intended purpose.

18. This product is intended for household and residential use only. This product is not approved for commercial applications.

19. If supply cord is damaged, it must be replaced by manufacturer, its service agent, or similarly qualified technician in order to avoid a hazard.

20. Electrical wiring must be in accordance with local regulations.

21. This appliance is not intended for use by persons (including children) with reduced physical, sensory or mental capabilities, or lack of experience and knowledge, unless they have been given supervision or instruction concerning use of appliance by a person responsible for their safety.

22. Children should be supervised to ensure they do not play with the appliance.

AeroGarden 7 Model #: 100610-BLK;
Electrical rating: 120V~60Hz, 1A

Date Code:

SAVE THESE INSTRUCTIONS

5 Easy Steps

To Get Your AeroGarden Ready to Plant

1 Insert Lamp Arm into Base

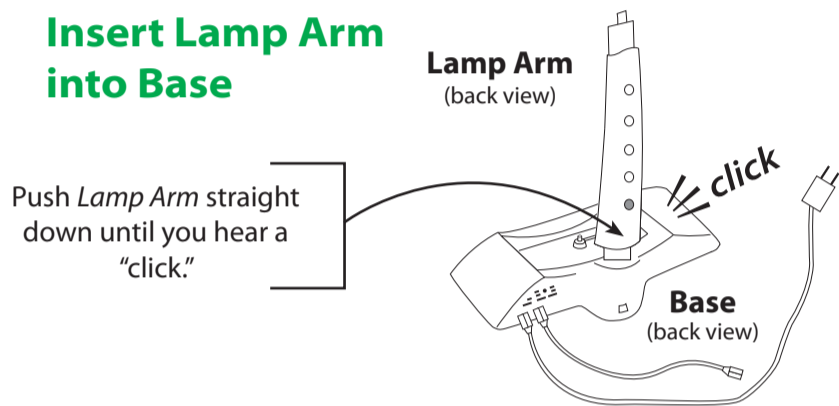

2 Install Grow Lights

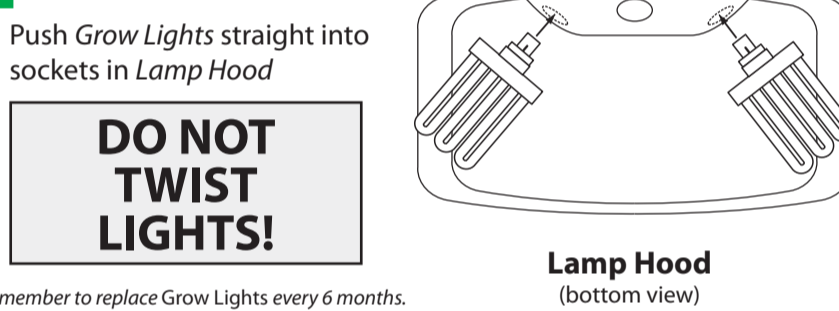

Remember to replace Grow Lights every 6 months.

3 Plug Lamp Cord into Lamp Hood

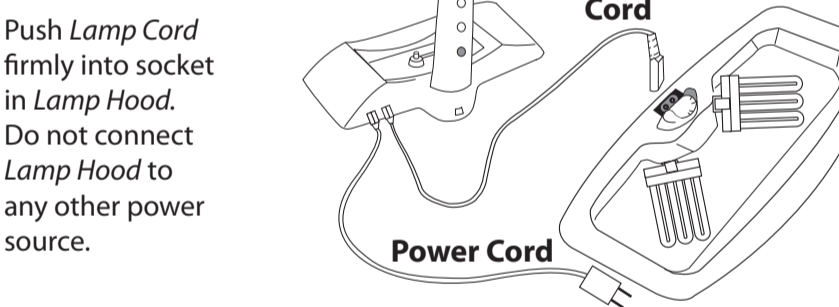

4 Place Lamp Hood on Lamp Arm

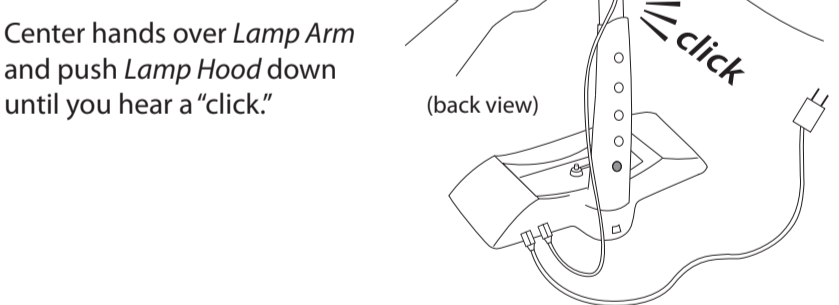

5 Set Bowl into Base

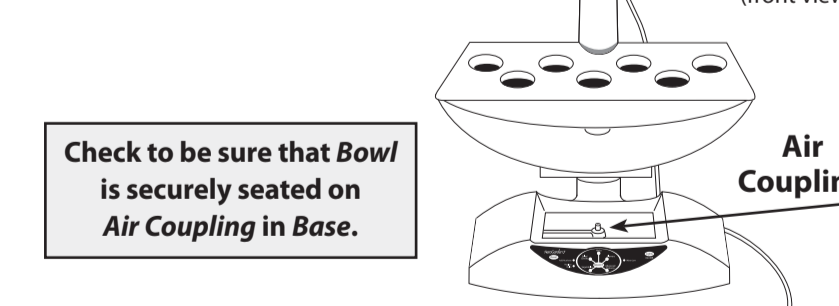

Check to be sure that Bowl is securely seated on Air Coupling in Base.

CONGRATULATIONS!
Your garden is ready to grow.
It really is that easy!

For more details on planting, growing and harvesting your AeroGarden... please turn the page

Included in Package



► Order replacement Grow Lights, extra Seed Kits and Accessories at AeroGarden.com

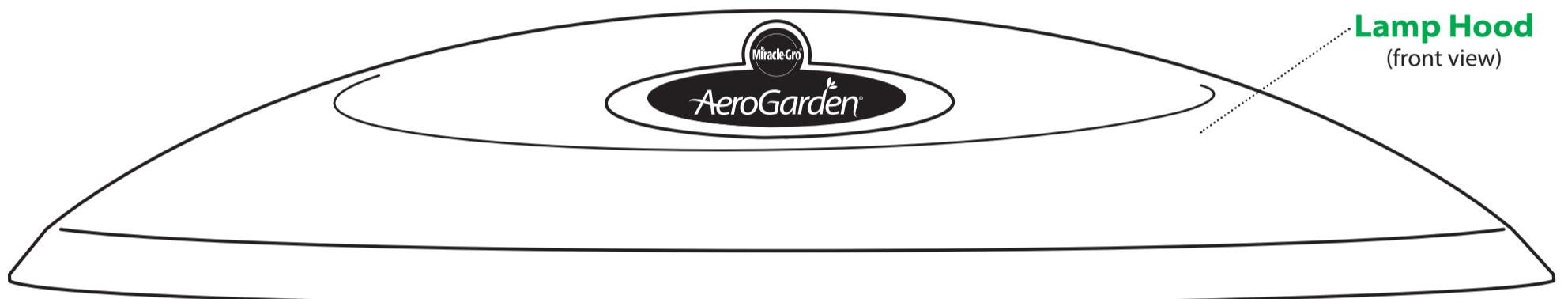

Place Your Garden...

- On a sturdy, water-tolerant surface (metal surfaces may cause noise due to vibration)
- Near a standard electrical outlet, per local regulations
- Under a space that allows 22" (56 cm) clearance for the full height of raised lamp
- Consider placement with easy access to unsoftened water
- In a 65-75°F (16-23°C) environment (optimal)
- Away from reach of children or pets
- Away from direct sources of heat (e.g., stove, furnace vents) or cold (e.g., window drafts, A/C vents)
- AeroGardens do not need additional light or a sunny window. In fact, too much direct sunlight can overheat your plants

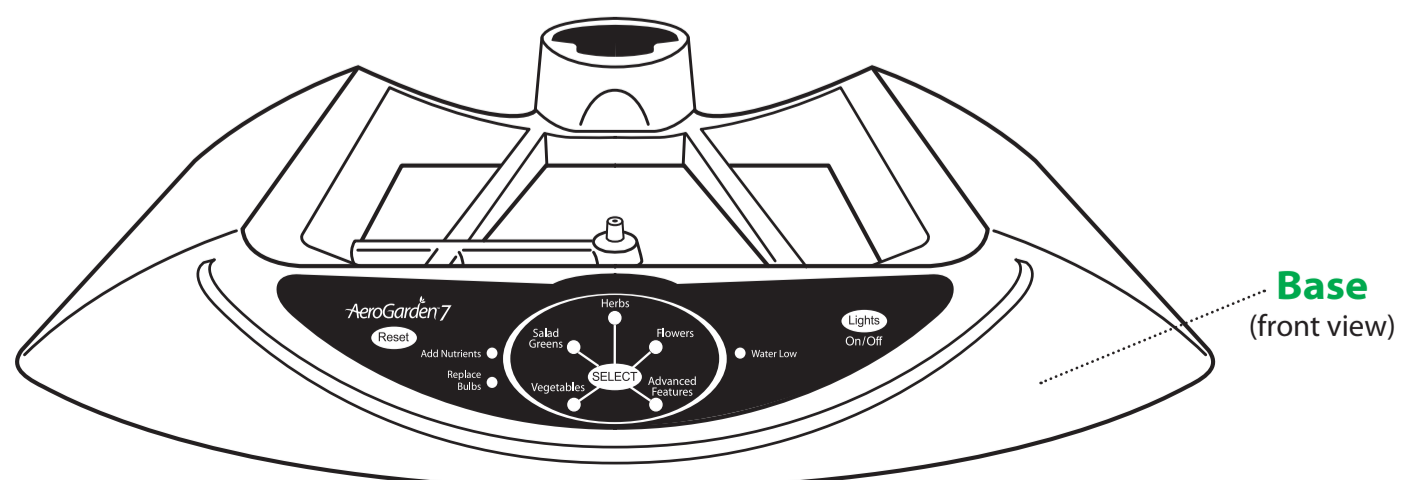
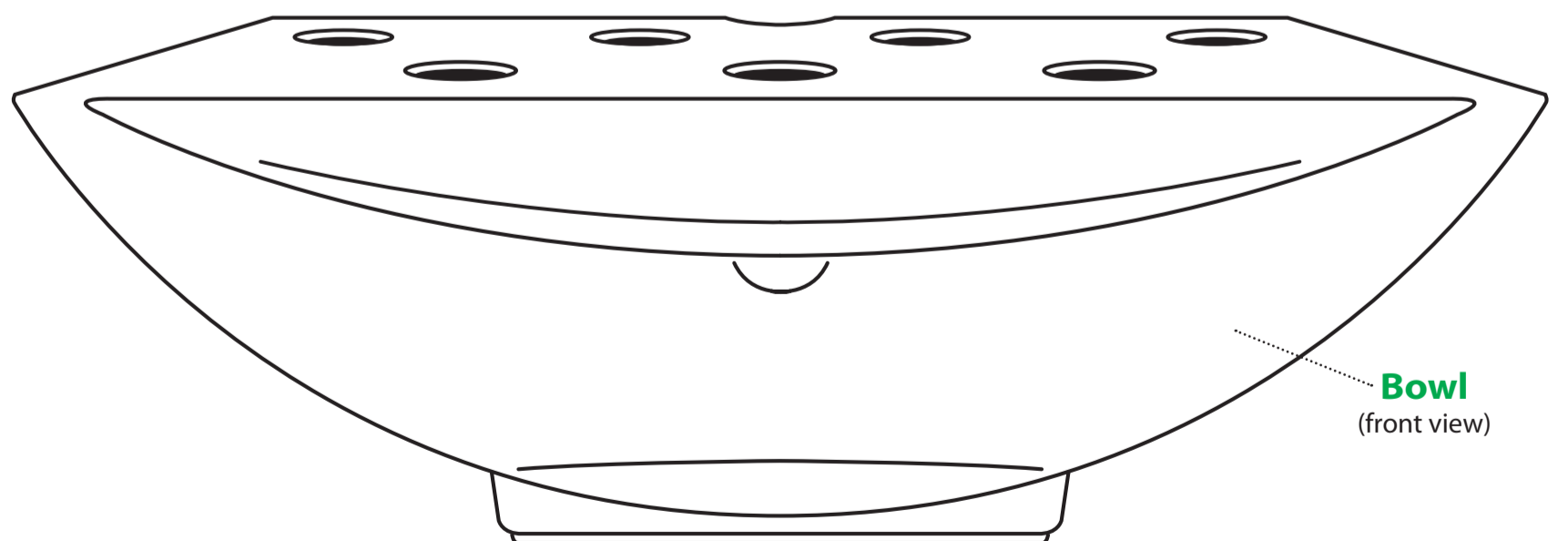

NEXT: Planting Your Garden

1. Add Water

- Use *room temperature* tap water or bottled distilled water. Do not use well water or softened water, as it contains levels of sodium usually harmful to plants.
- Add water to "Fill To Here" indicator.
- When additional water is needed, "Water Low" light on Control Panel will blink. Add water to raise level up to "Fill To Here" indicator.
- For most consistent growth, top off water frequently before the "Water Low" light blinks.

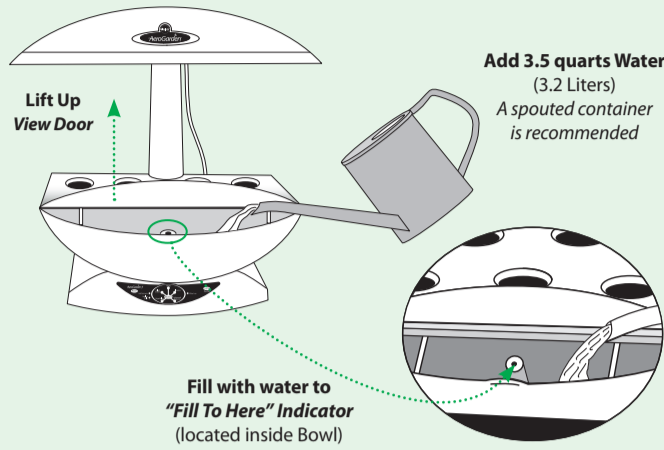

2. Add Grow Pods

- First, be sure to record the date your *Seed Kit* was planted on a calendar or in a notebook.
- Insert *Grow Pods* into openings in *Grow Deck Surface*.
- Grow Pod Labels* often identify plant height to assist with placement. Look for height noted on *Labels*.
- Plants grow best and look best if tall plants are in the back row, medium plants along the sides, and short plants are in front.
- Do not remove *Labels* from *Grow Pods*. The labels identify the plant type and plant height, show the germination time, and inhibit algae growth.
- Seed Kits for tomatoes and peppers often include both *Grow Pods* and *Plant Spacers*. *Plant Spacers* allow your tomato/pepper plants ample room to grow.

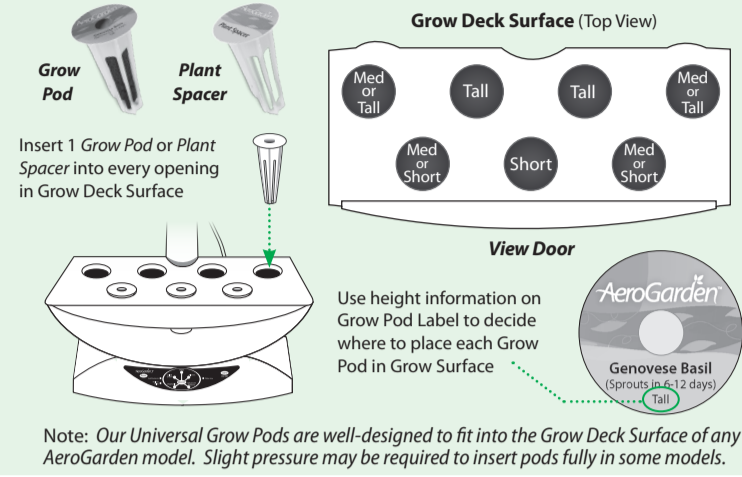

3. Add Bio-Domes

- Place a *Bio-Dome* onto each *Grow Pod*. Note: *Bio-Domes* cover *Grow Pods*, with no need to 'snap' into place.
- Leave the domes on the pods until plants have sprouted and their leaves nearly touch the domes.

Note: *Bio-Domes* are not needed over *Plant Spacers*.

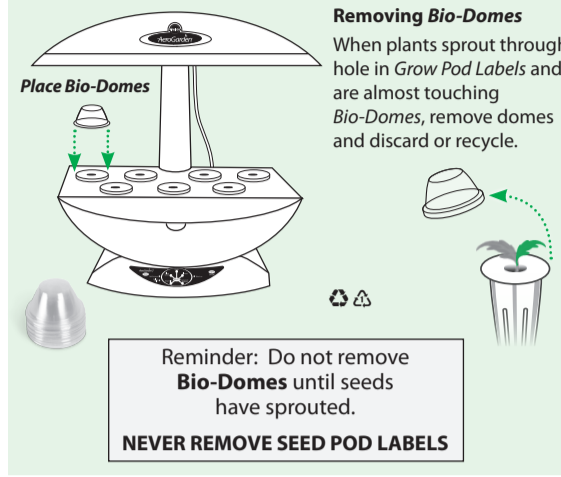

4. Add Nutrients

- Your Seed Kit comes with our new, improved *Liquid Nutrients*. Instructions for use are printed on the packaging as well as in the *Seed Kit Instructions* booklet. Read and follow the instructions carefully!
- Shake *Liquid Nutrients* well before feeding your AeroGarden or any other plants.
- Use only the recommended amount of *Liquid Nutrients*. Do not overfeed! "More" isn't better. Too much nutrient may be harmful to your plants.
- Add Nutrients directly into *Bowl* when first starting up your Garden, and when the 'Add Nutrient' reminder activates (every two weeks).

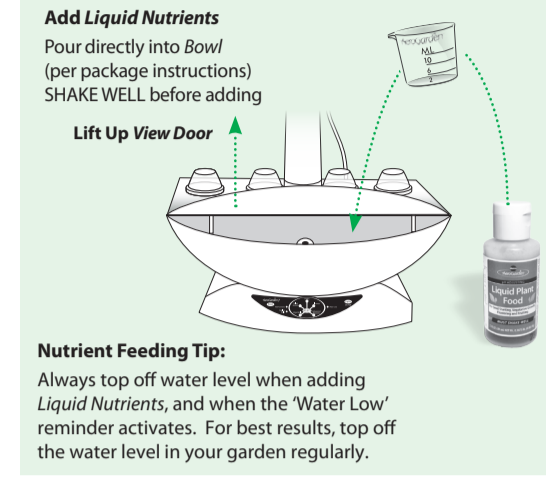

5. Plug Cord into Electrical Outlet

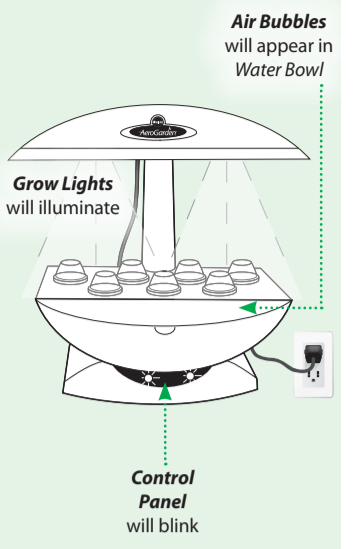

Congratulations!
You're on your way to a beautiful garden.

Control Panel Settings

SELECT Plant Type

Press the SELECT button until you reach the type of plants you are growing: Vegetables, Salad Greens, Herbs, or Flowers. Your AeroGarden 7 *Grow Lights* will automatically turn on and off at pre-programmed intervals according to the plant type selected. (see *light cycles chart* at right)

Advanced Features:

Sets lights to a 17-hour cycle. Advanced Features can also set the *Grow Lights* to a 24-hour cycle. To activate the 24-hour cycle, press and hold the 'Select' button until the green light next to Advanced Feature blinks (about 3 seconds), then release. The *Grow Lights* will now stay on continuously.

Add Nutrients

When "Add Nutrient" light blinks (every 2 weeks), add *Liquid Nutrients* into the *Bowl* and top up the water level to "Fill To Here." Press and release the "Reset" button to restart nutrient timer and turn off the blinking "Add Nutrient" light.

Replace Bulbs

When "Replace Bulbs" light blinks (after 6 months of use), it is time to replace both *Grow Lights*. You may want to turn off *Grow Lights* for a few minutes to allow them to cool. Once replaced, press and release "Reset" button to restart

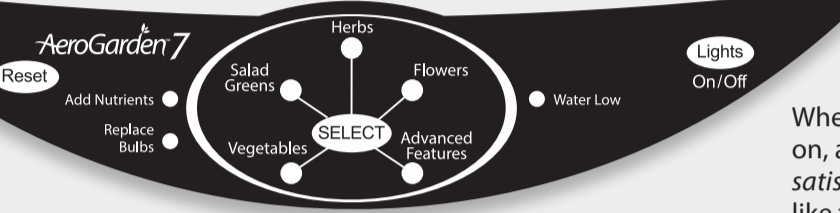

Grow Light timer and

turn off the blinking "Replace Bulbs" light. Additional *Grow Lights* can be ordered at aerogarden.com

Lights On/Off

Use to occasionally override built-in light timer. Once pushed, lights will stay on/off until the next time built-in light timer is set to go on/off. This will not affect the timing of your light cycle and occasional use of this feature will not harm your plants.

Note: In case of an electrical power outage, your AeroGarden has a backup memory system which stores timers for light, nutrients, grow light replacement, and plant selection settings. Once power is restored, your AeroGarden will revert to the On/Off Light cycle you have set.

Light Cycles (Aerator runs 24 Hours)	
Garden Selection	Lights ON...
Herb/Basil	17 hrs.
Salad Greens	16.5 hrs.
Peppers/Tomatoes	16 hrs.
Flowers	15.5
Advanced Features	17 hrs.
This setting can also activate a 24-hour cycle, see instructions at left	
	24 hrs.

How to Personalize Your Light Timer (optional)

When you plug in your AeroGarden for the first time the *Grow Lights* will come on, and they will continue to come on at this same time every day. If you are satisfied with the light timer, you do not need to make any changes. If you would like to change the time of day when the lights come on, follow these simple steps:

At the exact time of day when you want the lights to come ON:

- Turn *Grow Lights* ON (if they are not already on) using the "Lights On/Off" button. Lights must be ON in order to reset timer.
- With the lights ON, press and hold the "Lights" button. Watch for the light next to the plant type you selected to begin blinking. It will blink slowly for the first few seconds, then will begin blinking rapidly. Keep holding down on the "Lights" button until the rapid blinking begins, then release.
- After releasing the "Lights" button, the *Grow Lights* will go off, and about 10 seconds later they will come back on. The lights are now set to come ON at this time each day.

If you prefer to set the lights for the time of day when they will go OFF, follow these same instructions (at the exact time of day you want the lights to turn off), but instead release the "Lights" button when the plant selection light is in the initial slow blinking mode.

Note: You can reset your timer as often as you wish.



An Important Note About Lights

Your AeroGarden 7 has a built-in timer for *Grow Lights* that automatically provides your plants with "sunlight" (about 16 hours) and "night" (about 8 hours). As long as your plants get this amount of light, it does not matter what time the lights are off. Many people find it most convenient to have the lights go on in the morning and off at night, to match their own personal wake and sleep schedule.

Gardening Tips for Maximum Harvests

PLANTING

- Many AeroGarden pods are labeled for height. Gardens grow best and look their best when tall plants are planted in back and short plants in front. If plants are all the same size, like Salad Greens, they can be planted anywhere.
- Do not remove *Labels* from seed pods. The labels identify the plant type and plant height, show the germination time, and inhibit algae growth.
- Bio-Domes* help regulate moisture and temperature for optimal germination. Leave them on until plants are nearly touching the domes.
- Seed Kits for large plants like tomatoes and peppers often receive fewer than 7 pods to compensate for the large plant size. Place seed pods in each back/side opening and in the center front opening. Put plant spacers in the remaining openings.

GERMINATION

- Some seeds germinate in less than 24 hours. Some take 24 days or more. Most seed pod labels give an estimate of how long your seeds will take to germinate but many factors impact germination.
- As a rule of thumb, if you are comfortable, so are your plants. However, plants are impacted by temperature. Cold weather plants like Salad Greens germinate better in cooler temperatures. Heat lovers like tomatoes and peppers will germinate faster in warmer temperatures (above 70°F). But don't sweat it! While they may take a bit more time, your seeds will germinate.
- If you are growing your own seeds, plant 5-6 seeds per pod and check the seed packet for information regarding temperature and days to germination.

PRUNING

- Lower your plants, don't raise your lights! You will achieve more compact, beautiful growth and bigger harvests if you prune plants to keep the lights closer to all plants in your Garden.
- Fast growing plants (like basil) make gardeners want to raise the lights too soon. Resist! Pruning the plant just above a new leaf set (Diagram A) and leaving the lights down low will ensure that slow-growing and low-growing plants in your garden get all the light they need to flourish.
- Plants compete for light. Left unattended, more aggressive growers can actually block enough light to suppress growth of their slower growing neighbors, and eventually they can die off due to lack of light. Spreading leaves must be trimmed (Diagram B) to make sure that all plants get enough light to thrive and produce big yields.
- Finally, pruning = harvesting. Each time you prune you get to enjoy fresh-picked herbs in a salad, soup, on pizza or a sandwich. And, a full, bushy garden looks much better than one spindly, giant plant surrounded by straggly, light-starved neighbors. Pruning also releases a wonderful scent. So prune!
- Learn more about pruning at www.AeroGarden.com/Help.

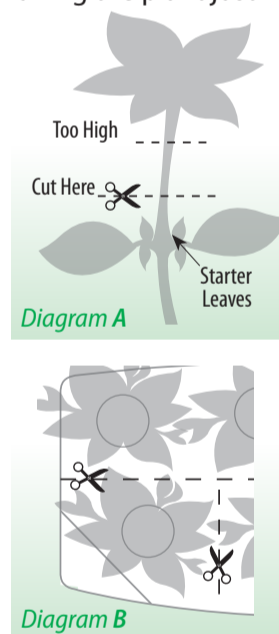

LIGHTS

- Plants love light! Always keep your grow lights as close to your plants as possible. Plants should be 1-2 inches below grow lights.
- Always check to see if you can prune plants instead of raising the lights. After pruning, lower your lights back down if necessary.

WATER

- While the AeroGarden control panel will remind you when water gets low, best results are achieved by topping off water regularly — add water up to "Fill To Here" before "Water Low" light blinks.
- Plants grown in the AeroGarden are designed to thrive with most municipal tap water. Improved results can be seen with distilled water or reverse osmosis water, but this is not needed in most cases.
- Do not use well water or softened water. Most well water contains a high amount of dissolved solids that upset the balance of our nutrients, and softened water adds sodium. This can result in plants suddenly browning, or just not growing well. Try bottled distilled water instead.

NUTRIENTS

- Typically, your plants will need nutrients every two weeks.
- Always shake nutrients well before adding.
- Follow instructions for feeding printed on the *Liquid Nutrient* packaging. Add nutrients directly into water bowl.
- "More" isn't better. Resist the temptation to add "just a little extra." Too much nutrient can hurt your plants.
- Nutrient requirements for tomatoes/peppers may change as plants grow. See nutrient packaging for details.

- For best results, try a "Rinse and Refill" once a month when it's time to add nutrients. Simply empty all water from the bowl, add fresh water and nutrients and press "Reset" to reset the Nutrient Timer. This balances the nutrients, delivering an instant 'pick up' to plants.

HARVESTING

- Many first-time growers are hesitant to harvest. Don't be! Most gardens will produce more, for a longer period, with frequent harvests. You almost can't begin to harvest (prune) early enough.
- Enjoy frequent, smaller harvests for the first month or two until plants mature and larger harvests are available.
- Harvest often to maintain a healthy AeroGarden, but never take more than 1/3 of each individual plant at a time.
- For Salad Greens, cut the top 2 inches off the entire garden, or harvest large leaves individually by cutting off at the base of the plant.

TOMATOES AND PEPPERS

- Because most people don't have bees in their home, you will need to start pollinating your tomato and pepper plants once they begin to flower (approximately 4 - 6 weeks after planting). To pollinate, use one or more of the following methods:
- Place an open hand gently inside plant branches and move your hand back and forth to shake the plant and spread the pollen.
 - Place a fan near your plants and the moving air will pollinate your plants.
 - Touch the main stem of the plants with an electric toothbrush and allow the vibration to spread the pollen.

U.S. CAUTION – You are cautioned that any changes or modifications not expressly approved in this manual could void your authority to operate this equipment.

To reduce the risk of electric shock, this furnishing has a polarized plug (one blade is wider than the other). This plug will fit in a polarized outlet only one way. If the plug does not fit fully in the outlet, reverse the plug. If it still does not fit, contact a qualified electrician to install the proper outlet. Do not change the plug in any way.

CAUTION: TO PREVENT ELECTRIC SHOCK, MATCH WIDE BLADE OF PLUG TO WIDE SLOT, FULLY INSERT.

Disconnect power before servicing or replacing lamp.
Use only AeroGarden
Grow Light #100340

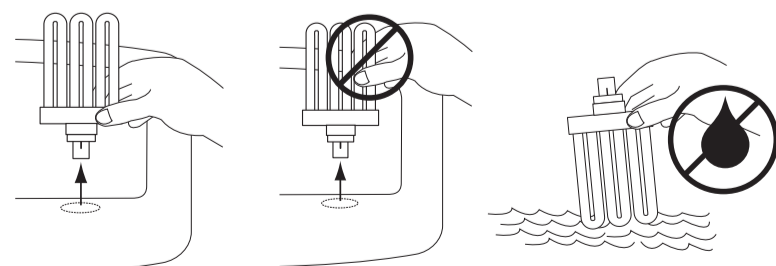

DO NOT SUBMERGE HOUSEHOLD USE ONLY

Do not immerse cord in water or other liquid, and unplug cord from outlet when not in use. Any servicing is to be performed by an authorized service representative. Use original packing for storage when the furnishing is not in use.

LIMITED WARRANTY

What Is Covered – This warranty covers any defects in materials or workmanship, with the exceptions stated below.

How Long Coverage Lasts – This warranty runs for one (1) year on this AeroGarden and six (6) months on the *Grow Lights(s)*, from the date of original purchase, for the original purchaser/user.

What is Not Covered – The warranty shall not apply to problems arising from: normal wear; failure to adhere to enclosed operating instructions; serial numbered products if the serial number has been removed or defaced; products subject to negligence, accident, improper use, maintenance or storage; products damaged by circumstances beyond AeroGarden International Inc.'s control; loss or damage to removable parts; or products modified (including, but not limited to, modifications through the use of unauthorized parts or attachments) or repaired by anyone other than AeroGarden International, Inc., or its designee. This warranty excludes all incidental or consequential damages.

What AeroGarden Will Do – AeroGarden International, Inc., at its option, will repair any defects in materials or workmanship or will replace these products with ones of similar features and price. AeroGarden International, Inc.'s sole obligation and your exclusive remedy under this warranty shall be limited to such repair or replacement.

To Return This Product – If you have questions or concerns regarding your AeroGarden, please contact Customer Service at 1-800-476-9669. Please do not return any product without contacting AeroGarden for return authorization. Unauthorized returns, as well as C.O.D. shipments, will be refused. For more information regarding returns, please see the Customer Care section at www.AeroGarden.com.

Due to continuing improvements, actual product may differ slightly from the product described herein. Some states do not allow the exclusion or limitation of incidental or consequential damages, so the above limitation or exclusion may not apply to you. This warranty gives you specific legal rights, and you may have other legal rights that vary from state to state.

If you have any questions please feel free to contact our customer service representatives at 1-800-476-9669.



AeroGarden International, Inc., P.O. Box 18450, Boulder, CO 80308

NEED SUPPLIES, ACCESSORIES OR INFORMATION? Call: 1-800-476-9669 or Visit Our Website: www.AeroGarden.com

Free Manuals Download Website

<http://myh66.com>

<http://usermanuals.us>

<http://www.somanuals.com>

<http://www.4manuals.cc>

<http://www.manual-lib.com>

<http://www.404manual.com>

<http://www.luxmanual.com>

<http://aubethermostatmanual.com>

Golf course search by state

<http://golfingnear.com>

Email search by domain

<http://emailbydomain.com>

Auto manuals search

<http://auto.somanuals.com>

TV manuals search

<http://tv.somanuals.com>