



24" Gas Ranges

Safety Instructions 2-7, 22, 23, 24

Operating Instructions
Oven 10-16
Surface Burners 8, 9

Care and Cleaning
Broiler Compartment 19
Broiler Pan and Grid 20
Burners 18
Control Panel and Knobs 18
Grates 17
Lift-Up Cooktop 17
Lift-Off Oven Door 20
Metal Parts 18
Oven Interior 21
Painted Surfaces 21
Removable Oven Bottom 19
Shelves 18
Thermostat Adjustment 14

Installation Instructions. 22-33
LP 33

Troubleshooting Tips 34

Consumer Support
Consumer Support . . . Back Cover
Warranty 35

Owner's Manual and Installation Instructions

JGAS02

Write the model and serial numbers here:

Model # _____

Serial # _____

You can find them on a label under the cooktop. See the Lift-Up Cooktop section in this manual for instructions on how to lift the cooktop.



IMPORTANT SAFETY INFORMATION. READ ALL INSTRUCTIONS BEFORE USING.

⚠ **WARNING!**

For your safety, the information in this manual must be followed to minimize the risk of fire or explosion, electric shock, or to prevent property damage, personal injury, or loss of life.





⚠ **WARNING!**

ANTI-TIP DEVICE

- ALL RANGES CAN TIP
- INJURY TO PERSONS COULD RESULT
- INSTALL ANTI-TIP DEVICES PACKED WITH RANGE
- SEE INSTALLATION INSTRUCTIONS

WARNING: If the information in this manual is not followed exactly, a fire or explosion may result causing property damage, personal injury or death.

— Do not store or use gasoline or other flammable vapors and liquids in the vicinity of this or any other appliance.

— **WHAT TO DO IF YOU SMELL GAS**

- Do not try to light any appliance.
- Do not touch any electrical switch; do not use any phone in your building.
- Immediately call your gas supplier from a neighbor's phone. Follow the gas supplier's instructions.
- If you cannot reach your gas supplier, call the fire department.

— Installation and service must be performed by a qualified installer, service agency or the gas supplier.



ANTI-TIP DEVICE

All ranges can tip and injury could result.

To prevent accidental tipping of the range, attach it to the wall by installing the Anti-Tip device supplied.

If the Anti-Tip device supplied with the range does not fit this application, use the universal Anti-Tip device WB2X7909.

To check if the device is installed and engaged properly, carefully tip the range forward. The Anti-Tip device should engage and prevent the range from tipping over.

If you pull the range out from the wall for any reason, make sure the device is properly engaged when you push the range back against the wall. If it is not, there is a possible risk of the range tipping over and causing injury if you or a child stand, sit or lean on an open door.

Please refer to the Anti-Tip device information in this manual. Failure to take this precaution could result in tipping of the range and injury.

⚠ WARNING!



IMPORTANT SAFETY NOTICE

The California Safe Drinking Water and Toxic Enforcement Act requires the Governor of California to publish a list of substances known to the state to cause birth defects or other reproductive harm, and requires businesses to warn customers of potential exposure to such substances.

Gas appliances can cause minor exposure to four of these substances, namely benzene, carbon monoxide, formaldehyde and soot, caused primarily by the incomplete combustion of natural gas or LP fuels. Properly adjusted burners, indicated by a bluish rather than a yellow flame, will minimize incomplete combustion. Exposure to these substances can be minimized by venting with an open window or using a ventilation fan or hood.



SAFETY PRECAUTIONS

Have the installer show you the location of the range gas shut-off valve and how to shut it off if necessary.

- Have your range installed and properly grounded by a qualified installer, in accordance with the Installation Instructions. Any adjustment and service should be performed only by qualified gas range installers or service technicians.
- Do not attempt to repair or replace any part of your range unless it is specifically recommended in this manual. All other service should be referred to a qualified technician.
- Plug your range into a 120-volt grounded outlet only. Do not remove the round grounding prong from the plug. If in doubt about the grounding of the home electrical system, it is your personal responsibility and obligation to have an ungrounded outlet replaced with a properly grounded, three-prong outlet in accordance with the National Electrical Code. Do not use an extension cord with this appliance.

⚠ WARNING: *NEVER* use this appliance as a space heater to heat or warm the room. Doing so may result in carbon monoxide poisoning and overheating of the oven.

IMPORTANT SAFETY INFORMATION. READ ALL INSTRUCTIONS BEFORE USING.

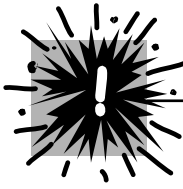

SAFETY PRECAUTIONS

- Locate the range out of kitchen traffic path and out of drafty locations to prevent pilot outage (on standing pilot models) and poor air circulation.
- Be sure all packaging materials are removed from the range before operating it to prevent fire or smoke damage should the packaging material ignite.
- Be sure your range is correctly adjusted by a qualified service technician or installer for the type of gas (natural or LP) that is to be used. Your range can be converted for use with either type of gas. See the *Installation of the range* section.

WARNING: These adjustments must be made by a qualified service technician in accordance with the manufacturer's instructions and all codes and requirements of the authority having jurisdiction. Failure to follow these instructions could result in serious injury or property damage. The qualified agency performing this work assumes responsibility for the conversion.

- Be careful when you clean the cooktop because the area over the pilot (on standing pilot models) will be hot.
- After prolonged use of a range, high floor temperatures may result and many floor coverings will not withstand this kind of use. Never install the range over vinyl tile or linoleum that cannot withstand such type of use. Never install it directly over interior kitchen carpeting.
- Do not leave children alone or unattended where a range is hot or in operation. They could be seriously burned.
- Do not allow anyone to climb, stand or hang on the oven door, broiler door or cooktop. They could damage the range and even tip it over, causing severe personal injury.

- **CAUTION:** Items of interest to children should not be stored in cabinets above a range or on the backsplash of a range—children climbing on the range to reach items could be seriously injured.

- Clean only parts listed in this Owner's Manual.
 - Never wear loose fitting or hanging garments while using the appliance. Be careful when reaching for items stored in cabinets over the range. Flammable material could be ignited if brought in contact with flame or hot oven surfaces and may cause severe burns.
 - Do not store flammable materials in an oven, a range broiler or near a cooktop.
 - Do not store or use combustible materials, gasoline or other flammable vapors and liquids in the vicinity of this or any other appliance.
 - Do not let cooking grease or other flammable materials accumulate in or near the range.
 - Do not use water on grease fires. Never pick up a flaming pan. Turn the controls off. Smother a flaming pan on a surface burner by covering the pan completely with a well-fitting lid, cookie sheet or flat tray. Use a multi-purpose dry chemical or foam-type fire extinguisher.
- Flaming grease outside a pan can be put out by covering it with baking soda or, if available, by using a multi-purpose dry chemical or foam-type fire extinguisher.
- Flame in the oven can be smothered completely by closing the oven door and turning the control to off or by using a multi-purpose dry chemical or foam-type fire extinguisher.
- Let the burner grates and other surfaces cool before touching them or leaving them where children can reach them.
 - Never block the vents (air openings) of the range. They provide the air inlet and outlet that are necessary for the range to operate properly with correct combustion. Air openings are located at the rear of the cooktop, at the top and bottom of the oven door, and at the bottom of the range under the broiler door.
 - Large scratches or impacts to glass doors can lead to broken or shattered glass.



COOK MEAT AND POULTRY THOROUGHLY...

Cook meat and poultry thoroughly—meat to at least an INTERNAL temperature of 160°F and poultry to at least an INTERNAL temperature of 180°F. Cooking to these temperatures usually protects against foodborne illness.



OVEN

Stand away from the range when opening the door of a hot oven. The hot air and steam that escape can cause burns to hands, face and eyes.

- Do not use the oven for a storage area. Items stored in the oven can ignite.
 - Keep the oven free from grease buildup.
 - Place the oven shelves in the desired position while the oven is cool.
 - Pulling out the shelf to the stop-lock is a convenience in lifting heavy foods. It is also a precaution against burns from touching hot surfaces of the door or oven walls.
 - Do not heat unopened food containers. Pressure could build up and the container could burst, causing an injury.
- ▲ WARNING: NEVER** cover any slots, holes or passages in the oven bottom or cover an entire rack with materials such as aluminum foil. Doing so blocks air flow through the oven and may cause carbon monoxide poisoning. Aluminum foil linings may also trap heat, causing a fire hazard.
- When using cooking or roasting bags in the oven, follow the manufacturer's directions.
 - Do not use your oven to dry newspapers. If overheated, they can catch fire.
 - Use only glass cookware that is recommended for use in gas ovens.
 - Always remove the broiler pan from range as soon as you finish broiling. Grease left in the pan can catch fire if oven is used without removing the grease from the broiler pan.
 - When broiling, if meat is too close to the flame, the fat may ignite. Trim excess fat to prevent excessive flare-ups.
 - Make sure the broiler pan is in place correctly to reduce the possibility of grease fires.
 - If you should have a grease fire in the broiler pan, turn off the oven control, and keep the broiler door and oven door closed to contain fire until it burns out.
 - For safety and proper cooking performance, always bake and broil with the oven and broiler doors closed.
 - Never leave jars of fat drippings on or near your range.

IMPORTANT SAFETY INFORMATION. READ ALL INSTRUCTIONS BEFORE USING.

⚠ WARNING!



SURFACE BURNERS

Use proper pan size—avoid pans that are unstable or easily tipped. Select cookware having flat bottoms large enough to cover burner grates. To avoid spillovers, make sure cookware is large enough to contain the food properly. This will both save cleaning time and prevent hazardous accumulations of food, since heavy spattering or spillovers left on range can ignite. Use pans with handles that can be easily grasped and remain cool.

- Always use the **LITE** position (on electric ignition models) or the **HI** position (on standing pilot models) when igniting the top burners and make sure the burners have ignited.

- Never leave the surface burners unattended at high flame settings. Boilovers cause smoking and greasy spillovers that may catch on fire.

- Adjust the top burner flame size so it does not extend beyond the edge of the cookware. Excessive flame is hazardous.

- Use only dry pot holders—moist or damp pot holders on hot surfaces may result in burns from steam. Do not let pot holders come near open flames when lifting cookware. Do not use a towel or other bulky cloth in place of a pot holder.

- When using glass cookware, make sure it is designed for top-of-range cooking.

- To minimize the possibility of burns, ignition of flammable materials and spillage, turn cookware handles toward the side or back of the range without extending over adjacent burners.

- Carefully watch foods being fried at a high flame setting.

- Always heat fat slowly, and watch as it heats.

- Do not leave any items on the cooktop. The hot air from the vent may ignite flammable items and will increase pressure in closed containers, which may cause them to burst.

- If a combination of oils or fats will be used in frying, stir together before heating or as fats melt slowly.

- Use a deep fat thermometer whenever possible to prevent overheating fat beyond the smoking point.

- Use the least possible amount of fat for effective shallow or deep-fat frying. Filling the pan too full of fat can cause spillovers when food is added.

- Do not flame foods on the cooktop. If you do flame foods under the hood, turn the fan on.

- Do not use a wok on the cooking surface if the wok has a round metal ring that is placed over the burner grate to support the wok. This ring acts as a heat trap, which may damage the burner grate and burner head. Also, it may cause the burner to work improperly. This may cause a carbon monoxide level above that allowed by current standards, resulting in a health hazard.

- Foods for frying should be as dry as possible. Frost on frozen foods or moisture on fresh foods can cause hot fat to bubble up and over the sides of the pan.

- Never try to move a pan of hot fat, especially a deep fat fryer. Wait until the fat is cool.

- Do not leave plastic items on the cooktop—they may melt if left too close to the vent.

- Keep all plastics away from the surface burners.

- To avoid the possibility of a burn, always be certain that the controls for all burners are at the **OFF** position and all grates are cool before attempting to remove them.

- If range is located near a window, do not hang long curtains that could blow over the surface burners and create a fire hazard.

- Always turn the surface burner controls off before removing cookware.



SURFACE BURNERS (cont.)

- When a pilot goes out (on standing pilot models), you will detect a faint odor of gas as your signal to relight the pilot. When relighting the pilot, make sure burner controls are in the off position, and follow instructions in this book to relight.
- If you smell gas, and you have already made sure pilots are lit (on standing pilot models), turn off the gas to the range and call a qualified service technician. Never use an open flame to locate a leak.
- Do not place or store items that can melt or catch fire on the grates, even when the cooktop is not being used.
- Keep range clean and free of accumulations of grease or spillovers, which may ignite.



FLOORING UNDER THE RANGE

Do not locate the range where it may be subject to strong drafts. Any openings in the floor or wall behind the range should be sealed. Make sure the openings around the base of the range that supply fresh air for combustion and ventilation are not obstructed by carpeting or woodwork.

Your range, like many other household items, is heavy and can settle into soft floor coverings such as cushioned vinyl or carpeting. Use care when moving the range on this type of flooring. It is recommended that the following simple and inexpensive instructions be followed to protect your floor.

The range should be installed on a sheet of plywood (or similar material). When the floor covering ends at the front of the range, the area that the range will rest on should be built up with plywood to the same level or higher than the floor covering.

This will allow the range to be moved for cleaning or servicing. Also, make sure your floor covering will withstand 180°F. (See the *Installation Safety Instructions* section).

Make sure the wall coverings around your range can withstand the heat generated (up to 200°F) by the range. (See the *Installation Safety Instructions* section).



LEVELING THE RANGE

Leveling legs are located on each corner of the base of the range. Your range must be level in order to produce proper cooking and baking results. After it is in its final location, place a level horizontally on any oven shelf

and check the levelness front to back and side to side. Level the range by adjusting the leveling legs or by placing shims under the corners as needed.



**READ AND FOLLOW THIS SAFETY INFORMATION CAREFULLY.
SAVE THESE INSTRUCTIONS**

Using the gas surface burners.

Throughout this manual, features and appearance may vary from your model.

Surface Lighting Instructions for Electric Ignition Models

The surface burners on some models are lit by electric ignition, eliminating the need for standing pilot lights with constantly burning flames.

In case of a power failure, you can light the surface burners on your range with a match. Hold a lit match to the burner, then turn the knob to the **LITE** position. **Use extreme caution when lighting burners this way.**

Surface burners in use when an electrical power failure occurs will continue to operate normally.

The electrode of the spark igniter is exposed. When one burner is turned to **LITE**, all the burners spark. Do not attempt to disassemble or clean around any burner while another burner is on. An electric shock may result, which could cause you to knock over hot cookware.

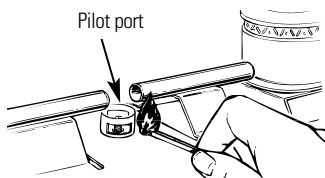

Surface Lighting Instructions for Standing Pilot Models

The surface burners on these ranges have standing pilots that must be lit initially.

To light them:

- 1 Be sure surface burner control knobs are in the **OFF** position.
- 2 Lift the cooktop up and prop it open with the prop rod provided (see the *Care and cleaning of the range* section).
- 3 Locate the 2 pilot ports and light each of them with a match.
- 4 To avoid pilot outage, slowly lower the cooktop after lighting the pilots.

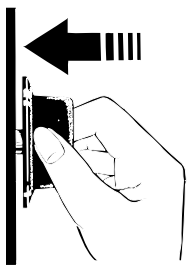

Surface Burner Controls

The knobs that turn the surface burners on and off are located on the control panel on the front of the range. The two surface knobs on the left control the left front and left rear burners. The two surface knobs on the right control the right front and right rear burners.

To Use a Surface Burner

- 1 Push the control knob in and turn it to **LITE** (**HI** on pilot models). On electric ignition models, you will hear a little **clicking** noise—the sound of the electric spark igniting the burner.
- 2 After the burner ignites, turn the knob to adjust the flame size.

After Lighting a Burner

- Check to be sure the burner you turned on is the one you want to use.
- Do not operate a burner for an extended period of time without cookware on the grate. The finish on the grate may chip without cookware to absorb the heat.
- Be sure the burners and grates are cool before you place your hand, a pot holder, cleaning cloths or other materials on them.

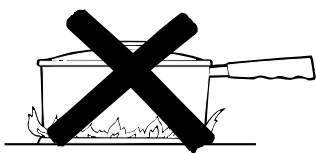

Never let the flame extend up the sides of the cookware.

How to Select Flame Size

Watch the flame, not the knob, as you reduce heat. The flame size on a gas burner should match the cookware you are using.

For safe handling of cookware, never let the flame extend up the sides of the cookware.

Any flame larger than the bottom of the cookware is wasted and only serves to heat the handle.

Top of Range Cookware

Aluminum: Medium-weight cookware is recommended because it heats quickly and evenly. Most foods brown evenly in an aluminum skillet. Use saucepans with tight-fitting lids when cooking with minimum amounts of water.

Cast-iron: If heated slowly, most skillets will give satisfactory results.

Enamelware: Under some conditions, the enamel of some cookware may melt. Follow cookware manufacturer's recommendations for cooking methods.

Glass: There are 2 types of glass cookware—those for oven use only and those for top-of-range cooking (saucepans, coffee and teapots). Glass conducts heat very slowly.

Heatproof Glass Ceramic: Can be used for either surface or oven cooking. It conducts heat very slowly and cools very slowly. Check cookware manufacturer's directions to be sure it can be used on gas ranges.

Stainless Steel: This metal alone has poor heating properties and is usually combined with copper, aluminum or other metals for improved heat distribution. Combination metal skillets usually work satisfactorily if they are used with medium heat as the manufacturer recommends.

Using the oven.

Throughout this manual, features and appearance may vary from your model.

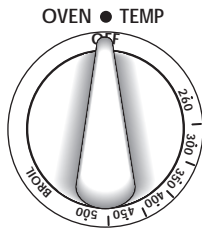

Oven Control

Your oven is controlled by an **OVEN TEMP** knob. It can take up to 90 seconds before the flame comes on.

After the oven reaches the selected temperature, the oven burner maintains the selected temperature.

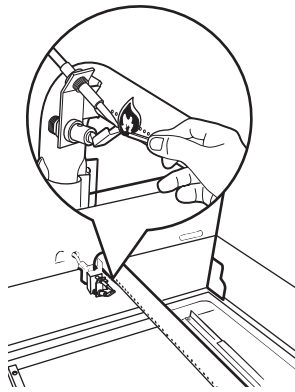

Oven Lighting Instructions for Standing Pilot Models

The standing oven pilot must be lit initially.

To light the oven pilot:

- 1 Be sure the **OVEN TEMP** knob is in the **OFF** position.
- 2 Open the oven door and remove the oven bottom. See the *Removable Oven Bottom* section in *Care and Cleaning*.
- 3 Find the oven pilot port at the back of the oven.
- 4 To light the oven pilot, push in and hold the **OVEN TEMP** knob while lighting the pilot with a long match or match in a match holder. Once the oven pilot is lit, continue holding the **OVEN TEMP** knob in for one minute before releasing.

Power Outage—Standing Pilot Models

An electrical power failure will not affect the standing oven pilot.

Power Outage—Electric Ignition Models

CAUTION: Do not make any attempt to operate the electric ignition oven during an electric power failure. The oven or broiler cannot be lit during a power failure. Gas will not flow unless the glow bar is hot.

If the oven is in use when a power failure occurs, the oven burner shuts off and cannot be re-lit until power is restored. This is because the flow of gas is automatically stopped and will not resume when power is restored until the glow bar has reached operating temperature.

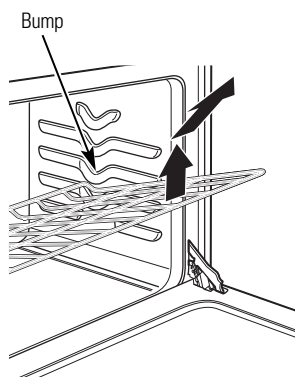

Oven Shelves

The shelves are designed with stop-locks so when placed correctly on the shelf supports, they will stop before coming completely out of the oven and will not tilt when you are removing food from them or placing food on them.

When placing cookware on a shelf, pull the shelf out to the bump on the shelf support. Place the cookware on the shelf, then slide the shelf back into the oven. This will eliminate reaching into the hot oven.

To remove the shelves from the oven, pull them toward you, tilt front end upward and pull them out.

To replace, place shelf on shelf support with stop-locks (curved extension of shelf) facing up and toward back of oven. Tilt up front and push shelf toward back of oven until it goes past the bump on the shelf support. Then lower front of shelf and push it all the way back.

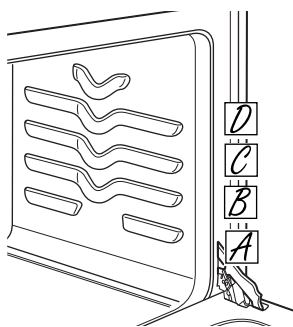

The oven has 4 shelf positions.

Oven Shelf Positions

The oven has four shelf supports—**A** (bottom), **B**, **C** and **D** (top).

Shelf positions for cooking are suggested in the *Using your oven for baking* and *Using your oven for roasting* sections.

Oven Vents

- The oven is vented through duct openings at the front of the backsplash.
- Do not block the opening when cooking in the oven—it is important that the flow of hot air from the oven and fresh air to the oven burner be uninterrupted.
- The vent openings and nearby surfaces may become hot during baking and broiling. Do not touch them.
- Do not leave plastic items on the cooktop—they may melt if left too close to the vent.
- Handles of pots and pans on the cooktop may become hot if left too close to the vent.
- Metal items will become very hot if they are left on the cooktop and could cause burns.
- Do not leave any items on the cooktop. The hot air from the vent may ignite flammable items and will increase pressure in closed containers, which may cause them to burst.

The type of margarine will affect baking performance!

Most recipes for baking have been developed using high fat products such as butter or margarine (80% fat). If you decrease the fat, the recipe may not give the same results as with a higher fat product.

Recipe failure can result if cakes, pies, pastries, cookies or candies are made with low fat spreads. The lower the fat content of a spread product, the more noticeable these differences become.

Federal standards require products labeled “margarine” to contain at least 80% fat by weight. Low fat spreads, on the other hand, contain less fat and more water. The high moisture content of these spreads affects the texture and flavor of baked goods. For best results with your old favorite recipes, use margarine, butter or stick spreads containing at least 70% vegetable oil.

Using the oven for baking.

To avoid possible burns, place the shelves in the desired position before you turn the oven on.

How to Set the Oven For Baking

- 1 Close the oven door. Then turn the **OVEN TEMP** knob to the desired temperature.

- 2 Check the food for doneness at the minimum time on the recipe. Cook longer if necessary. Turn the **OVEN TEMP** knob to **OFF** and remove the food.

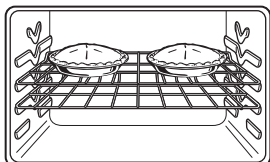

Place most foods in the middle of the oven.

Oven Shelves

Arrange the oven shelf or shelves in the desired locations while the oven is cool. The correct shelf position depends on the kind of food and the browning desired.

As a general rule, place most foods in the middle of the oven, on either the shelf position **B** or **C**. See the chart for suggested shelf positions.

Type of Food	Shelf Position
Angel food cake	A
Biscuits, muffins or cupcakes	B or C
Cookies	C or D
Brownies	B or C
Layer cakes	B or C
Bundt or pound cakes	B
Pies or pie shells	B or C
Frozen pies (on cookie sheet)	B or C
Casseroles	B or C

To preheat, set the oven at the correct temperature—selecting a higher temperature does not shorten the preheat time.

Preheating

Preheat the oven for 10 minutes if the recipe calls for it. Preheat means bringing the oven up to the specified temperature before putting the food in the oven.

Preheating is necessary for good results when baking cakes, cookies, pastry and breads. For most casseroles and roasts, preheating is not necessary.

Baking Pans

Use the proper baking pan. The type of finish on the pan determines the amount of browning that will occur.

- Glass baking dishes also absorb heat. When baking in glass baking dishes, lower the temperature by 25°F and use the recommended cooking time in the recipe. This is not necessary when baking pies or casseroles.

- Dark, rough or dull pans absorb heat resulting in a browner, crisper crust. Use this type for pies.

- Shiny, bright and smooth pans reflect heat, resulting in a lighter, more delicate browning. Cakes and cookies require this type of pan.

Pan Placement

For even cooking and proper browning, there must be enough room for air circulation in the oven. Baking results will be better if baking pans are centered as much as possible rather than being placed to the front or to the back of the oven.

Pans should not touch each other or the walls of the oven. Allow 1 to 1½ inch space between pans as well as from the back of the oven, the door and the sides.

If you need to use two shelves, stagger the pans so one is not directly above the other.

Cookies

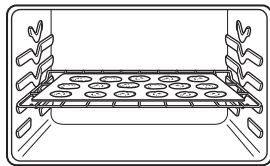

For best results, use only one cookie sheet in the oven at a time.

Flat cookie sheets (without sides) produce better-looking cookies. Cookies baked in a jelly roll pan (short sides all around) may have darker edges and pale or light browning may occur.

Do not use a cookie sheet so large that it touches the walls or the door of the oven. Never entirely cover a shelf with a large cookie sheet.

Pies

For best results, bake pies in dark, rough or dull pans to produce a browner, crisper crust.

Frozen pies in foil pans should be placed on an aluminum cookie sheet for baking since the shiny foil pan reflects heat away from the pie crust; the cookie sheet helps retain it.

Cakes

When baking cakes, warped or bent pans will cause uneven baking results and poorly shaped products.

A cake baked in a pan larger than the recipe recommends will usually be crisper, thinner and drier than it should be.

If baked in a pan smaller than recommended, it may be undercooked and batter may overflow.

Check the recipe to make sure the pan size used is the one recommended.

Don't Peek

Set the timer for the estimated cooking time and do not open the door to look at your food. Most recipes provide minimum and maximum baking times such as "bake 30–40 minutes."

DO NOT open the door to check until the minimum time. Opening the oven door frequently during cooking allows heat to escape and makes baking times longer. Your baking results may also be affected.

Using the oven for roasting.

Roasting is cooking by dry heat. Tender meat or poultry can be roasted uncovered in your oven. Roasting temperatures, which should be low and steady, keep spattering to a minimum.

Roasting is really a baking procedure used for meats. Roasting is easy; just follow these directions:

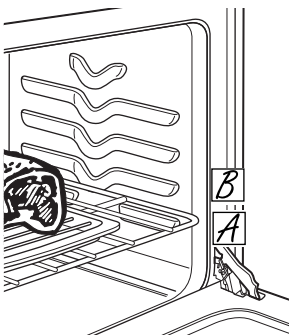

Place the shelf in the A or B position.

How to Set the Oven For Roasting

- 1 Place the shelf in the **A** or **B** position. No preheating is necessary.
- 2 Check the weight of the meat. Place it fat side up (or for poultry, breast-side-up) on a roasting rack in a shallow pan. The melting fat will baste the meat. Select a pan as close to the size of the meat as possible. Line the pan with aluminum foil when using the pan for marinating, cooking with fruits, cooking heavily cured meats or basting food during cooking.
- 3 Turn the **OVEN TEMP** knob to the desired setting.
- 4 After roasting is complete, turn the **OVEN TEMP** knob to **OFF** and then remove the food from the oven.

Adjust the oven thermostat—Easy to do yourself!

You may find that your new oven cooks differently than the one it replaced. Use your new oven for a few weeks to become more familiar with it. If you still think your new oven is too hot or too cold, you can adjust the thermostat yourself.

Do not use thermometers, such as those found in grocery stores, to check the temperature setting of your oven. These thermometers may vary 20–40°F.

NOTE: This adjustment will not affect the broiling temperatures. The adjustment will be retained after a power failure.

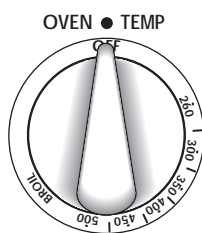

Front of OVEN TEMP knob
(knob appearance may vary)

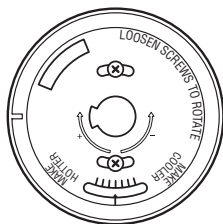

Back of OVEN TEMP knob

To Adjust the Thermostat with this Type of Knob

- 1 **Pull the OVEN TEMP knob off the range and look at the back side.**
To make an adjustment, loosen (approximately one turn), but do not completely remove, the two screws on the back of the knob.
 - 2 With the back of the knob facing you, hold the outer edge of the knob with one hand and turn the front of the knob with the other hand.
To increase the oven temperature, move the top screw toward the right. You'll hear a click for each notch you move the knob.
To decrease the oven temperature, move the top screw toward the left.
- Each click will change the oven temperature approximately 10°F. (Range is plus or minus 60°F from the arrow.) We suggest that you make the adjustment one click from the original setting and check oven performance before making any additional adjustments.
- 3 **After the adjustment is made,** retighten screws so they are snug, but be careful not to overtighten.
 - 4 Replace the knob, matching the flat area of the knob to the shaft, and check performance.

Using the oven for broiling.

ge.com

Broiling is cooking food by direct heat from above the food. Most fish and tender cuts of meat can be broiled. Follow these steps to keep spattering and smoking to a minimum.

Your range has a compartment below the oven for broiling. A specially designed broiler pan allows dripping fat to drain away from the food.

Both the oven door and broiler compartment drawer should be closed during broiling.

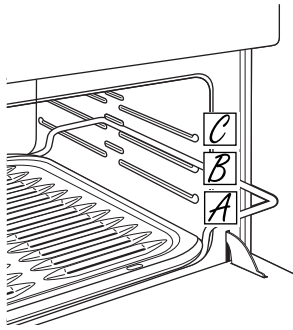

How to Set Your Oven for Broiling

- 1 You can change the distance of the food from the heat source by positioning the broiler rack in the broiler compartment:
 - A (bottom of broiler compartment).
 - B (center of broiler compartment).
 - C (top of broiler compartment).Most broiling should be done in position **A**.
- 2 Preheat the broiler for best results.
- 3 If the meat has fat or gristle around the edge, cut vertical slashes through it about 2 inches apart, but don't cut into the meat. We recommend that you trim the fat to prevent excessive smoking, leaving a layer about 1/8 inch thick.
- 4 Close the oven door and broiler compartment drawer.
- 5 Turn the **OVEN TEMP** knob to **BROIL**.
- 6 Turn most foods once during cooking. Time foods for about one-half the total cooking time, turn food, then continue to cook to preferred doneness.
- 7 Turn the **OVEN TEMP** knob to **OFF**. Remove the broiler pan from the broiler rack and serve the food immediately. Leave the pan outside the range to cool.

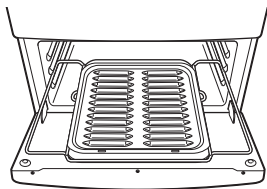

Broiler Compartment

The broiler pan is held in place in the broiler rack.

To remove the broiler pan:

- 1 Gently pull forward on the drop down broiler door.
- 2 Pull the broiler rack with pan forward until the rack stops. Grasp the broiler pan and remove it from the broiler rack.

To replace the broiler pan:

- 1 Slide the broiler pan onto the rack and push both the broiler pan and the rack all the way into the broiler compartment.
- 2 Close the broiler door.

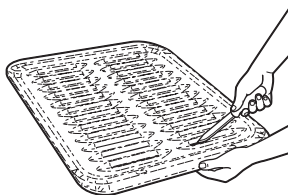

Use of Aluminum Foil

Never cover the oven bottom with aluminum foil.

You can use aluminum foil to line your broiler pan and broiler grid. However, you must mold the foil tightly to the pan and cut slits in the foil to open all slots in the grid.

Aluminum foil may also be used to catch a spillover. To do so, place a small sheet of foil on a lower shelf several inches below the food.

Never entirely cover a shelf with aluminum foil. This will disturb the heat circulation and result in poor baking.

Safety Instructions

Operating Instructions

Care and Cleaning

Installation Instructions

Troubleshooting Tips

Consumer Support

Using the oven for broiling.

Broiling Guide

- The oven door and broiler compartment drawer must be closed during broiling.
- Always use the broiler pan that comes with your range.
- If desired, marinate meats or chicken before broiling. Or, brush with barbecue sauce the last 5 to 10 minutes.
- When arranging food on pan, do not let fatty edges hang over the sides. The fat drippings will soil the broiler compartment.
- Use tongs to turn the meat. Pierced meat loses juices.

Food	Amount or Thickness	Shelf Position	Time In Minutes		Comments
			First Side	Second Side	
Bacon	1/2 lb. (about 8 thin slices)	B	3½ min.	3 min.	Arrange in single layer
Ground Beef	1 lb. (4 patties) 1/2 to 3/4" thick	B	11–12 min.	6–7 min.	Space evenly.
Beef Steaks Medium	1 to 1½ lbs.	B or C	12 min.	5–6 min.	Steaks less than 1" thick cook through before browning. Pan frying is recommended.
Chicken	1 whole 2 to 2½ lbs., split lengthwise	A	30–35 min.	25–30 min.	Reduce time about 5 to 10 minutes per side for cut-up chicken. Brush each side with melted butter. Broil skin-side-down first.
Fish	1 lb. fillets 1/4 to 1/2" thick	B	5 min.	5 min.	Handle and turn very carefully. Brush with lemon butter before and during cooking, if desired. Preheat broiler to increase browning.

Care and cleaning of the range.

ge.com

Be sure electrical power is off and all surfaces are cool before cleaning any part of the range.

Proper care and cleaning are important so your range will give you efficient and satisfactory service. Follow these directions carefully in caring for your range to assure safe and proper maintenance.

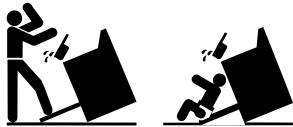

If your range is removed for cleaning, servicing or any reason, be sure the anti-tip device is re-engaged properly when the range is replaced. Failure to take this precaution could result in tipping of the range and cause injury.

How to Remove the Range for Cleaning and Servicing

Follow these steps to remove the range for servicing or cleaning hard to reach surfaces.

- 1 Shut off the gas supply to the range.
- 2 Disconnect the electrical supply to the range.
- 3 Disconnect the gas supply tubing to the range.
- 4 Slide the range forward to free the range foot from the Anti-Tip bracket. See the Installation Instructions for the location of the bracket.

- 5 Reverse these steps to re-install the range. If the gas line has been disconnected, check for gas leaks after re-connection. See the Installation Instructions for the gas lead test method.

NOTE: A trained technician should make the gas installation, disconnection and re-connection of the gas supply to the appliance.

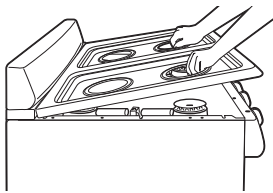

Lift-Up Cooktop

Clean the area under the cooktop often. Built-up soil, especially grease, may catch on fire.

To make cleaning easier, the cooktop may be lifted up and propped open.

Be sure all burners are turned off before raising the cooktop. Then remove the grates.

Grasp the two front burner wells and lift the cooktop up and prop it open with the prop rod provided. Be careful of the pilots when the cooktop is up.

After cleaning underneath the cooktop with hot, soapy water and a clean cloth, hold the cooktop up, return the prop rod to its storage position and lower the cooktop until it snaps into position. Be careful not to pinch your fingers.

Burner Grates

Grates should be washed regularly and after spillovers. Wash them in hot, soapy water and rinse with clean water.

After cleaning, dry thoroughly by putting them in a warm oven for a few minutes. Don't put the grates back on the range while they are wet. When replacing the grates, be sure they're positioned securely over the burners.

To get rid of burned-on food, place the grates in a covered container (or plastic bag) with 1/4 cup ammonia to loosen the soil. Then scrub with a soap-filled scouring pad if necessary.

Although they're durable, the grates will gradually lose their shine, regardless of the best care you can give them. This is due to their continual exposure to high temperatures.

Do not operate a burner for an extended period of time without cookware on the grate. The finish on the grate may chip without cookware to absorb the heat.

Safety Instructions

Operating Instructions

Care and Cleaning

Installation Instructions

Troubleshooting Tips

Consumer Support

Care and cleaning of the range.

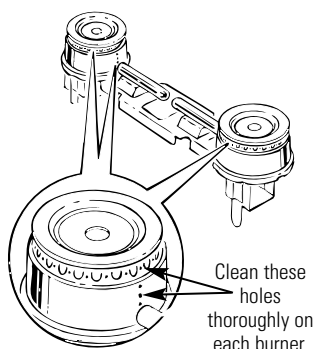

Burners

The holes in the surface burners of your range must be kept clean at all times for proper ignition and an even, unhampered flame.

You should clean the surface burners routinely, especially after bad spills, which could clog these holes. Wipe off the surface burners. If heavy spillover occurs, remove the surface burners from the range. The burners lift out for cleaning. Lift up the cooktop and then lift out the surface burners.

NOTE: A screw holds each of the burners in place to keep them from wobbling around during shipment. Remove and discard the shipping screw.

To remove burned-on food, soak the surface burner in a solution of mild liquid detergent and hot water. Soak the surface burner for 20 to 30 minutes. For more stubborn stains, use a cleanser like Soft Scrub® brand or Bon Ami® brand. Rinse well to remove any traces of the cleanser that might clog the surface burner openings. Do not use steel wool because it will clog the surface burner openings and scratch the surface burners. If the holes become clogged, clean them with a small pin or sewing needle.

Before putting the surface burner back, shake out excess water and then dry it thoroughly by setting it in a warm oven for 30 minutes. Then place it back in the range, making sure it is properly seated and level.

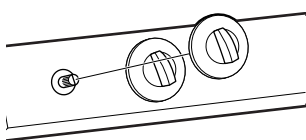

Control Panel and Knobs

It's a good idea to wipe the control panel after each use of the oven. Clean with mild soap and water or vinegar and water, rinse with clean water and polish dry with a soft cloth.

Do not use abrasive cleansers, strong liquid cleaners, plastic scouring pads or oven cleaners on the control panel—they will damage the finish. A 50/50 solution of vinegar and hot water works well.

The control knobs may be removed for easier cleaning.

To remove the knob, pull it straight off the stem. Wash the knobs in soap and water or a vinegar and hot water solution but do not soak.

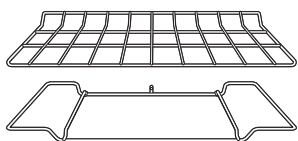

Oven Shelves and Broiler Rack

The shelves and broiler rack can be cleaned by hand using soap and water or with an abrasive cleaner. After cleaning, rinse the shelves and broiler rack with clean water and dry.

To remove heavy, burned-on soil, you may use scouring pads. After scrubbing, wash with soapy water, rinse and dry.

Metal Parts

Do not use steel wool, abrasives, ammonia or commercial oven cleaners.

To safely clean surfaces: wash, rinse and then dry with a soft cloth.

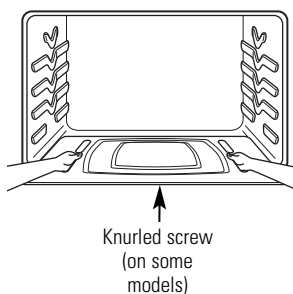

Removable Oven Bottom

First remove the shelves from the oven. The oven bottom lifts from the front.

To remove:

- 1 On models so equipped, remove the knurled screw in the front of the oven bottom.
- 2 Grasp each side of the oven bottom and push it back.
- 3 Lift the front up and pull it out of the oven.

To replace:

- 1 Grasp each side of the oven bottom and guide its rear tabs into the slots in the back of the oven.
- 2 Lower the oven bottom and pull it forward until it is secure under the front oven floor edge.
- 3 On models so equipped, replace the knurled screw in the front of the oven bottom.

NOTE: If the oven bottom is replaced incorrectly, it may warp and cause undesirable baking results.

Cleaning the Oven Bottom

The oven bottom has a porcelain enamel finish.

To make cleaning easier, protect the oven bottom from excessive spillovers by placing a cookie sheet on the shelf below the shelf you are cooking on. This is particularly important when baking a fruit pie or other foods with high acid content. Hot fruit fillings or foods that are acidic in content, such as tomatoes or sauerkraut, and sauces with vinegar or lemon juice, may cause pitting and damage to the porcelain enamel surface and should be wiped up immediately.

To protect the oven bottom surface, place a piece of aluminum foil slightly larger than the baking dish on the shelf below to catch any boilovers. It should not completely cover the shelf as this would cause uneven heat in the oven. Aluminum foil should not be placed on the oven bottom.

If a spillover does occur on the oven bottom, allow the oven to cool first. You can clean the bottom with soap and water, a mild abrasive cleanser, soap-filled scouring pads or an oven cleaner following package directions.

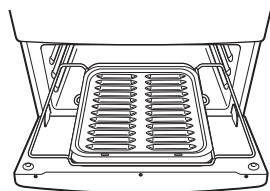

Broiler Compartment

The broiler pan is held in place in the broiler rack.

To remove the broiler pan:

- 1 Gently pull forward on the drop down broiler door.
- 2 Pull the broiler rack with pan forward until the rack stops. Grasp the broiler pan and remove it from the broiler rack.

To replace the broiler pan:

- 1 Slide the broiler pan onto the rack and push both the broiler pan and the rack all the way into the broiler compartment.
- 2 Close the broiler door.

If a spillover occurs in the broiler compartment, allow the compartment to cool first. You can clean the compartment with soap and water, a mild abrasive cleanser, soap-filled scouring pads or an oven cleaner following package directions.

Care and cleaning of the range.

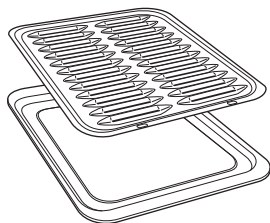

Broiler Pan and Grid

After broiling, remove the broiler pan from the oven. Remove the grid from the pan. Carefully pour out grease from the pan into a proper container. Wash and rinse the broiler pan and grid in hot water with a soap-filled or plastic scouring pad.

If food has burned on, sprinkle the grid with detergent while hot and cover with wet paper towels or a dishcloth. Soaking the pan will remove burned on foods.

Do not store a soiled broiler pan and grid anywhere in the range.

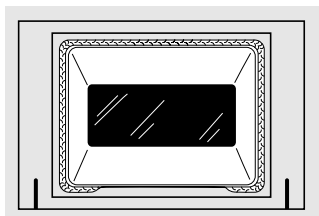
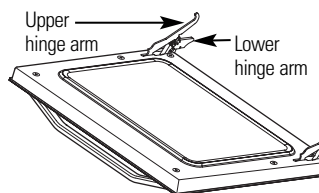
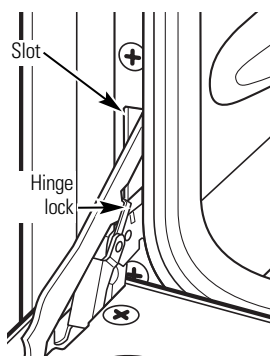

The gasket is designed with a gap at the bottom to allow for proper air circulation.

Do not rub or clean the door gasket—it has an extremely low resistance to abrasion.

If you notice the gasket becoming worn, frayed or damaged in any way or if it has become displaced on the door, you should have it replaced.

Lift-Off Oven Door

The oven door is removable, but it is heavy. You may need help removing and replacing the door.

To remove the door:

- 1 Open the door to the full open position.
- 2 Pull the hinge locks up over the hinge hooks on both sides. You may need to use a flat-blade screwdriver to lift hinge locks up.
- 3 Grasp the door firmly on each side, lift slightly and pull it straight out and away from the oven.

To replace the door:

- 1 Firmly grasp both sides of the door at the top.
- 2 Insert and seat the upper and lower hinge arms into the oven slots.
- 3 Push the hinge locks down from the hinge hooks.
- 4 Close the oven door and make sure it is working properly. If it is not working properly, remove and replace it following the above steps.

DO NOT ATTEMPT TO CLOSE THE DOOR UNTIL THIS STEP IS COMPLETE. THE HINGE OR DOOR COULD BE DAMAGED.

TO CLEAN THE DOOR:

Inside of door:

- Soap and water will normally do the job. Heavy spattering or spillovers may require cleaning with a mild abrasive cleaner. Soapy, wet metal pads may also be used. Do not allow food spills with a high sugar or acid content (such as milk, tomatoes, sauerkraut, fruit juices or pie filling) to remain on the surface. They may cause a dull spot even after cleaning.
- If necessary, you may use an oven cleaner. Follow package directions.

Outside of door:

- Use soap and water to thoroughly clean the top, sides and front of the oven. Rinse well.
- Spillage of marinades, fruit juices, tomato sauces and basting materials containing acids may cause discoloration and should be wiped up immediately. When surface is cool, clean and rinse.
- Do not use oven cleaners, cleansing powders or harsh abrasives on the outside of the door.



Porcelain Oven Interior

With proper care, the porcelain enamel finish on the inside of the oven will stay new-looking for years.

Let the range cool before cleaning.

We recommend that you wear rubber gloves when cleaning the range.

Soap and water will normally do the job.

Heavy spattering or spillovers may require cleaning with a mild abrasive cleaner. Soapy, wet metal pads may also be used. Do not allow food spills with a high sugar or acid content (such as tomatoes, sauerkraut, fruit juices or pie filling) to remain on the surface. They may cause a dull spot even after cleaning.

Household ammonia may make the cleaning job easier. Place 1/2 cup in a shallow glass or pottery container in a cold oven overnight. The ammonia fumes will help loosen the burned-on grease and food.

If necessary, you may use an oven cleaner. Follow package directions.

Cautions about using spray-on oven cleaners:

- Do not spray on the electrical controls and switches because it could cause a short circuit and result in sparking or fire.
- Do not allow a film from the cleaner to build up on the temperature sensor—it could cause the oven to heat improperly. (The sensor is located at the top of the oven.) Carefully wipe the sensor clean after each oven cleaning, being careful not to move the sensor as a change in its position could affect how the oven bakes.
- Do not spray any oven cleaner on the outside of the oven door, handles or any exterior surface of the oven, wood or painted surfaces. The cleaner can damage these surfaces.

Painted Surfaces

Painted surfaces include the sides, control panel and door. Clean these with soap and water or a vinegar and water solution.

Do not use commercial oven cleaners, cleansing powders, steel wool or harsh abrasives on any painted surface.

Stainless Steel Surfaces (on some models)

Do not use a steel wool pad; it will scratch the surface.

To clean the stainless steel surface, use warm sudsy water or a stainless steel cleaner or polish. Always wipe the surface in the direction of the grain. Follow the cleaner instructions for cleaning the stainless steel surface.

To inquire about purchasing stainless steel appliance cleaner or polish, or to find the location of a dealer nearest you, please call our toll-free number:

National Parts Center **800.626.2002**
ge.com

Installation Instructions

Range

If you have questions, call 800.GE.CARES or visit our Website at: ge.com

IN THE COMMONWEALTH OF MASSACHUSETTS

- This product must be installed by a licensed plumber or gas fitter.
- When using ball-type gas shut-off valves, they shall be the T-handle type.
- A flexible gas connector, when used, must not exceed 3 feet.

BEFORE YOU BEGIN

Read these instructions completely and carefully.

Installation of this range must conform with local codes, or in the absence of local codes, with the National Fuel Gas Code, ANSI Z223.1/NFPA.54, latest edition. In Canada, installation must conform with the current Natural Gas Installation Code, CAN/CGA-B149.1 or the current Propane Installation Code, CAN/CGA-B149.2, and with local codes where applicable. This range has been design-certified by CSA International according to ANSI Z21.1, latest edition and Canadian Gas Association according to CAN/CGA-1.1 latest edition.

As with any appliance using gas and generating heat, there are certain safety precautions you should follow. You will find these precautions in the *Important Safety Information* section in the front of this manual. Read them carefully.

- **IMPORTANT** — Save these instructions for local inspector's use.
- **IMPORTANT** — Observe all governing codes and ordinances.
- **Note to Installer** – Be sure to leave these instructions with the Consumer.
- **Note to Consumer** – Keep these instructions for future reference.
- **Note** – This appliance must be properly grounded.
- **Service** – The electrical diagram is in an envelope attached to the back of the range.
- **Skill Level** – Installation of this appliance requires basic mechanical skills.
- Proper installation is the responsibility of the installer.
- Product failure due to improper installation is not covered under the Warranty.

Installation Instructions

FOR YOUR SAFETY

Do not store or use combustible materials, gasoline or other flammable vapors and liquids in the vicinity of this or any other appliance. If you smell gas:

- 1 Open windows.
- 2 Don't touch electrical switches.
- 3 Extinguish any open flame.
- 4 Immediately call your gas supplier.

TOOLS YOU WILL NEED



Phillips screwdriver



Flat-blade screwdriver
3/16" or smaller

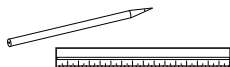

Pencil and ruler



Level



Pliers



Open-end or
adjustable wrench

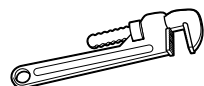

Pipe wrenches (2)
(one for backup)



Drill, awl or nail



5/16" Nut driver

MATERIALS YOU MAY NEED

- Gas line shut-off valve
- Pipe joint sealant or UL-approved pipe thread tape with Teflon* that resists action of natural and LP gases
- Flexible metal appliance connector (1/2" I.D.)
A 5-foot length is recommended for ease of installation but other lengths are acceptable. Never use an old connector when installing a new range.
- Flare union adapter for connection to gas supply line (3/4" or 1/2" NPT x 1/2" I.D.).
- Flare union adapter for connection to pressure regulator on range (1/2" NPT x 1/2" I.D.)
- Liquid leak detector or soapy water.
- Lag bolt or 1/2" O.D. sleeve anchor (for concrete floors only).
- Long matches and/or match holder (for models equipped with standing pilots).

*Teflon: Registered trademark of DuPont

PART INCLUDED

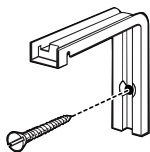

Anti-tip bracket kit

Installation Instructions

⚠ WARNING! **INSTALLATION SAFETY INSTRUCTIONS**

Read these instructions completely and carefully.

Improper installation, adjustment, alteration, service or maintenance can cause injury or property damage. Refer to this manual. For assistance or additional information, consult a qualified installer, service agency, manufacturer (dealer) or the gas supplier.

Never reuse old flexible connectors. The use of old flexible connectors can cause gas leaks and personal injury. Always use **NEW** flexible connectors when installing a gas appliance.

IMPORTANT — Remove all packing material and literature from oven before connecting gas and electrical supply to range.

CAUTION — Do not attempt to operate the oven of this range during a power failure (Electric Ignition models only).

- Have your range installed by a qualified installer.
- Your range must be electrically grounded in accordance with local codes or, in the absence of local codes, in accordance with the National Electrical Code (ANSI/NFPA 70, latest edition). In Canada, electrical grounding must be in accordance with the current CSA C22.1 Canadian Electrical Code Part 1 and/or local codes. See *Electrical Connections* in this section.
- Before installing your range on linoleum or any other synthetic floor covering, make sure the floor covering can withstand 180°F without shrinking, warping or discoloring. Do not install the range over carpeting unless a sheet of 1/4" thick plywood or similar insulator is placed between the range and carpeting.
- Make sure the wall coverings around the range can withstand heat generated by the range up to 200°F.

- Avoid placing cabinets above the range. To reduce the hazard caused by reaching over the open flames of operating burners, install a ventilation hood over the range that projects forward at least 5" beyond the front of the cabinets.
- The ventilating hood must be constructed of sheet metal not less than 0.0122" thick. Install above the cooktop with a clearance of not less than 1/4" between the hood and the underside of the combustible material or metal cabinet. The hood must be at least as wide as the appliance and centered over the appliance. Clearance between the cooking surface and the ventilation hood surface **MUST NEVER BE LESS THAN 24 INCHES.**

EXCEPTION: Installation of a listed microwave oven or cooking appliance over the cooktop shall conform to the installation instructions packed with that appliance.

- If cabinets are placed above the range, allow a minimum clearance of 30" between the cooking surface and the bottom of unprotected cabinets.
- If a 30" clearance between cooking surface and overhead combustible material or metal cabinets cannot be maintained, protect the underside of the cabinets above the cooktop with not less than 1/4" insulating millboard covered with sheet metal not less than 0.0122" thick. Clearance between the cooking surface and protected cabinets **MUST NEVER BE LESS THAN 24 INCHES.**
- The vertical distance from the plane of the cooking surface to the bottom of adjacent overhead cabinets extending closer than 1" to the plane of the range sides must not be less than 18". (See the *Dimensions and Clearances* illustration in this section.)
- **CAUTION** — Items of interest to children should not be stored in cabinets above a range or on the backsplash of a range—children climbing on the range to reach items could be seriously injured.

Installation Instructions

DIMENSIONS AND CLEARANCES

Provide adequate clearances between the range and adjacent combustible surfaces. These dimensions must be met for safe use of your range.

The range may be placed with 0" clearance below cooktop and at the back wall.

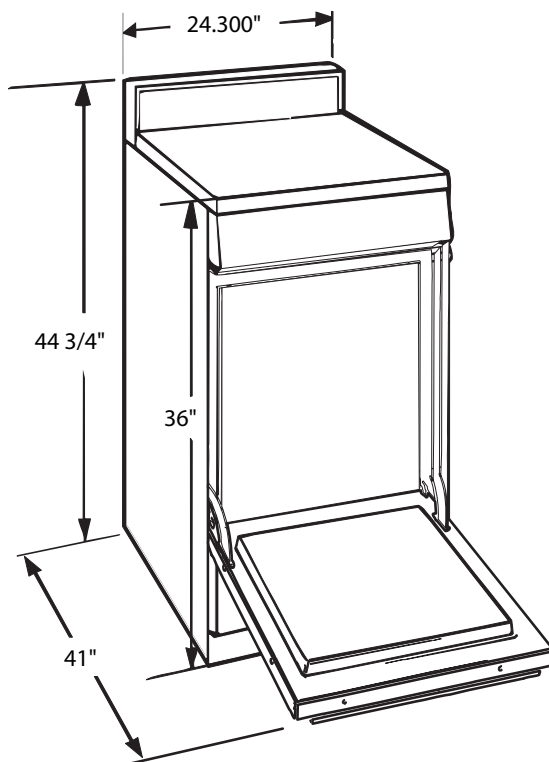
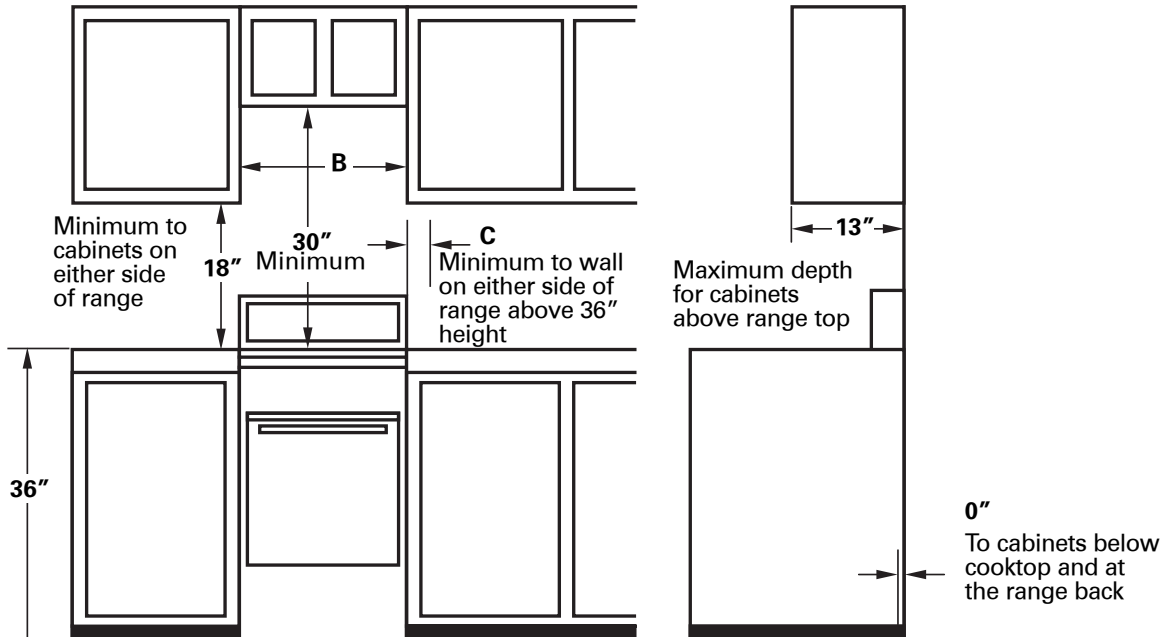

Installation Instructions

⚠ WARNING! **ANTI-TIP DEVICE**



All ranges can tip and injury could result.



To prevent accidental tipping of the range, install the Anti-Tip device packed with this range. (See *Install the Anti-Tip Device* in this section.)

To check if the device is installed and engaged properly, carefully tip the range forward. The Anti-Tip device should engage and prevent the range from tipping over.

If you pull the range out from the wall for any reason, make sure the Anti-Tip device is engaged when you push the range back against the wall.

- For your safety, never use your range for warming or heating the room. Your oven and cooktop are not designed to heat your kitchen. Top burners should not be operated without cookware on the grate. Such abuse could result in fire and damage to your range and will void your warranty.
- Do not store or use combustible materials, gasoline or other flammable vapors and liquids in the vicinity of this or any other appliance. Explosions or fires could result.
- Do not use oven for a storage area. Items stored in the oven can ignite.
- Do not let cooking grease or other flammable materials accumulate in or near the range.

LOCATION

Do not locate the range where it may be subject to strong drafts. Any openings in the floor or wall behind the range should be sealed. Make sure the openings around the base of the range that supply fresh air for combustion and ventilation are not obstructed by carpeting or woodwork.

Your range, like many other household items, is heavy and can settle into soft floor coverings such as cushioned vinyl or carpeting. Use care when moving the range on this type of flooring. It is recommended that the following simple and inexpensive instructions be followed to protect your floor.

The range should be installed on a sheet of plywood (or similar material). When the floor covering ends at the front of the range, the area that the range will rest on should be built up with plywood to the same level or higher than the floor covering.

This will allow the range to be moved for cleaning or servicing. Also, make sure your floor covering will withstand 180°F. (See the *Installation Safety Instructions* section.)

Make sure the wall coverings around your range can withstand the heat generated (up to 200°F) by the range. (See the *Installation Safety Instructions* section.)

MODEL AND SERIAL NUMBER LOCATION

You can find them on a label under the cooktop. See the *Lift-Up Cooktop* section in this manual or instructions on how to lift the cooktop.

IMPORTANT!

Remove all tape and packaging. Make sure the burners are properly seated and level.

Lift up the cooktop and remove any packing material under it.

Take the accessory pack out of the oven and/or drawer.

Check to be sure that no range parts have come loose during shipping.

Installation Instructions

1 PROVIDE ADEQUATE GAS SUPPLY

Your range is designed to operate at a pressure of 4" of water column on natural gas or, if designed for LP gas (propane or butane), 10" of water column.

Make sure you are supplying your range with the type of gas for which it is designed.

This range is convertible for use on natural or propane gas. If you decide to use this range on LP gas, conversion must be made by a qualified LP installer before attempting to operate the range on that gas.

For proper operation, the pressure of natural gas supplied to the regulator must be between 4" and 13" of water column.

For LP gas, the pressure supplied must be between 10" and 13" of water column.

When checking for proper operation of the regulator, the inlet pressure must be at least 1" greater than the operating (manifold) pressure as given above.

The pressure regulator located at the inlet of the range manifold must remain in the supply line regardless of whether natural or LP gas is being used.

A flexible metal appliance connector used to connect the range to the gas supply line should have an I.D. of 1/2" and be 5 feet in length for ease of installation. In Canada, flexible connectors must be single wall metal connectors no longer than 6 feet in length.

2 CONNECT THE RANGE TO GAS

Shut off the main gas supply valve before disconnecting the old range and leave it off until the new hookup has been completed. Don't forget to relight the pilot on other gas appliances when you turn the gas back on.

Because hard piping restricts movement of the range, the use of a CSA International-certified flexible metal appliance connector is recommended unless local codes require a hard-piped connection.

Never use an old connector when installing a new range. If the hard piping method is used, you must carefully align the pipe; the range cannot be moved after the connection is made.

To prevent gas leaks, put pipe joint compound on, or wrap pipe thread tape with Teflon* around, all male (external) pipe threads.

- A** Install a manual gas line shut-off valve in the gas line in an easily accessed location outside of the range. Make sure everyone operating the range knows where and how to shut off the gas supply to the range.
- B** Install male 1/2" flare union adapter to the 1/2" NPT internal thread at inlet of regulator. Use a backup wrench on the regulator fitting to avoid damage.
- C** Install male 1/2" or 3/4" flare union adapter to the NPT internal thread of the manual shut-off valve, taking care to back-up the shut-off valve to keep it from turning.
- D** Connect flexible metal appliance connector to the adapter on the range. Position range to permit connection at the shut-off valve.
- E** When all connections have been made, make sure all range controls are in the off position and turn on the main gas supply valve. Use a liquid leak detector at all joints and connections to check for leaks in the system.

WARNING — DO NOT USE A FLAME TO CHECK FOR GAS LEAKS.

When using test pressures greater than 1/2 psig to pressure test the gas supply system of the residence, disconnect the range and individual shut-off valve from the gas supply piping. When using test pressures of 1/2 psig or less to test the gas supply system, simply isolate the range from the gas supply system by closing the individual shut-off valve.

*Teflon: Registered trademark of DuPont

Installation Instructions

RECOMMENDED GAS AND ELECTRIC SUPPLY LOCATION

NOTE: Recommended gas hook-up locations behind range. Gas fittings and shut-off cock should NOT protrude more than 2" from the wall to allow the range to fit against the wall.

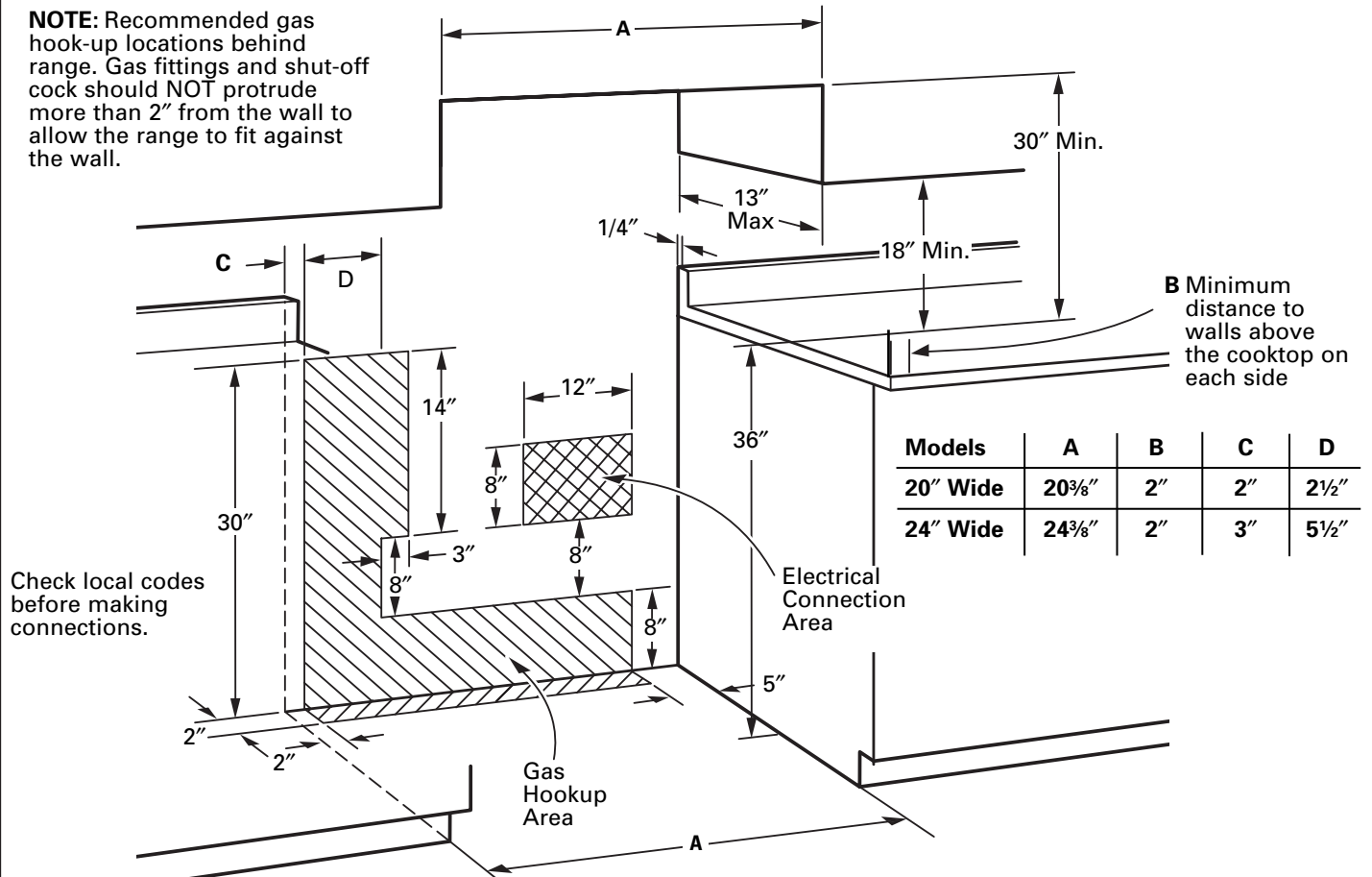

FLEXIBLE CONNECTOR HOOKUP (Example)

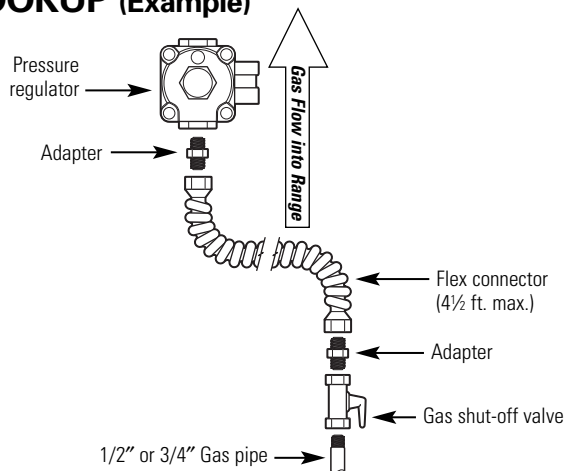

Installer: Inform the consumer of the location of the gas shut-off valve.

RIGID PIPE HOOKUP (Example)

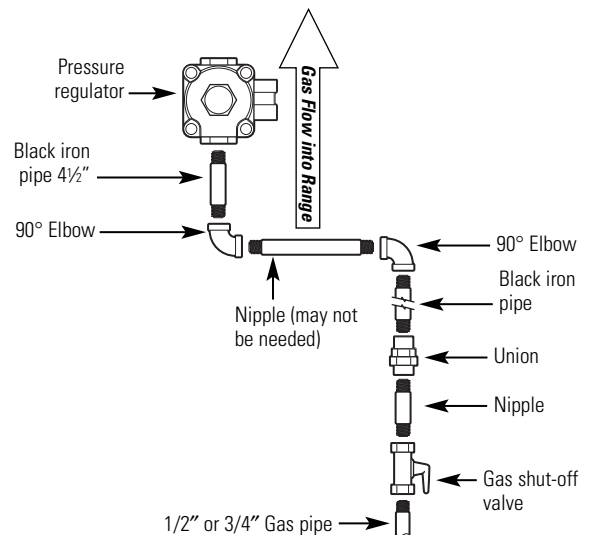

Installer: Inform the consumer of the location of the gas shut-off valve.

Installation Instructions

3 ELECTRICAL CONNECTIONS (on electric ignition models)

Electrical Requirements

120-volt, 60 Hertz, properly grounded dedicated circuit protected by a 15-amp or 20-amp circuit breaker or time delay fuse.

Extension Cord Cautions

Because of potential safety hazards associated with certain conditions, we strongly recommend against the use of an extension cord. However, if you still elect to use an extension cord, it is absolutely necessary that it be a UL-listed, 3-wire grounding-type appliance extension cord and that the current carrying rating of the cord in amperes be equivalent to, or greater than, the branch circuit rating.

Grounding

IMPORTANT—(Please read carefully) FOR PERSONAL SAFETY, THIS APPLIANCE MUST BE PROPERLY GROUNDED.

Preferred Method

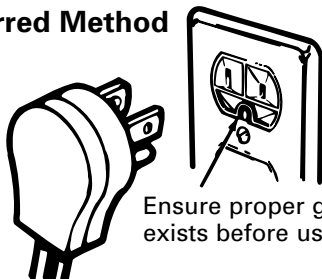

Ensure proper ground exists before use

The power cord of this appliance is equipped with a 3-prong (grounding) plug which mates with a standard 3-prong grounding wall receptacle to minimize the possibility of electric shock hazard from this appliance.

The customer should have the wall receptacle and circuit checked by a qualified electrician to make sure the receptacle is properly grounded.

Where a standard 2-prong wall receptacle is encountered, it is the personal responsibility and obligation of the customer to have it replaced with a properly grounded 3-prong wall receptacle.

DO NOT, UNDER ANY CIRCUMSTANCES, CUT OR REMOVE THE THIRD (GROUND) PRONG FROM THE POWER CORD.

4 SEAL THE OPENINGS

Seal any openings in the wall behind the range and in the floor under the range when hookups are completed.

5 LIGHT THE PILOTS

(For models equipped with standing pilots. If the range is an electric ignition model, the burners are ignited by electric ignition which eliminates the need for standing pilot lights.)

The range should be installed in its permanent position before any pilots are lit or adjusted.

CAUTION — Make sure the surface burner control knobs are in the **OFF** position before attempting to light the pilots.

A Light the Surface Burner Pilots

1. Lift the cooktop up and prop it open with the prop rod provided (see the *Care and cleaning of the range* section).
2. Locate the 2 pilot ports and light each of them with a match.

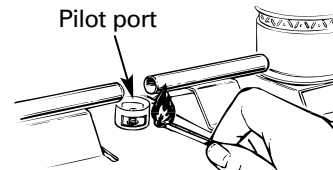

3. To avoid pilot outage, use caution when closing cooktop after lighting pilots.

NOTE: Do not leave standing pilot lit in a newly constructed or remodeled home or apartment that will be unoccupied for more than a month.

Each pilot flame was adjusted at the factory to be approximately 5/16" tall. A tinge of yellow appearing at the upper tip is normal. If you find pilot adjustment is necessary, follow instructions in Step B.

Installation Instructions

5 LIGHT THE PILOTS (cont.)

B Adjust the Surface Burner Pilots if Necessary

1. Raise the cooktop.
2. Use a small flat-bladed screwdriver to turn the adjusting screw (accessed through a hole in the front right side of the burner box).

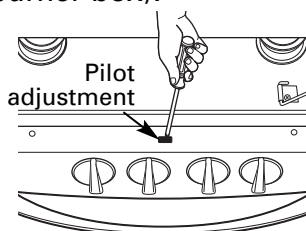

CAUTION — Make sure the surface burner control knobs are in the **OFF** position before attempting to adjust the pilots.

3. Observe lit burners. Compare the flames to pictures in the *Before you call for service* section. If any flame is unsatisfactory, call for service.
4. To avoid pilot outage, slowly lower the cooktop after lighting the pilots.

6 IF THE RANGE HAS ELECTRIC IGNITION

There are separate ignition devices for the left and right hand surface burners. Both of these ignitors are **ON** when any knob is turned to the **LITE** setting. The ignitors will **spark** as long as any of the top burner knobs are at the **LITE** setting.

In the event of an electrical power failure, the top burners can still be used. To light a burner, hold a lit kitchen match adjacent to the top burner to be used and turn valve knob to **LITE**. **USE EXTREME CAUTION.**

7 LIGHT THE OVEN PILOT (on standing pilot models)

- A Be sure the **OVEN TEMP** knob is in the **OFF** position.
- B Open the oven door and remove the oven bottom. See the *Removable Oven Bottom* section in *Care and Cleaning*.
- C Find the oven pilot port at the back of the oven.
- D To light the oven pilot, push in and hold the **OVEN TEMP** knob while lighting the pilot with a long match or match in a match holder. Once the oven pilot is lit, continue holding the **OVEN TEMP** knob in for one minute before releasing.

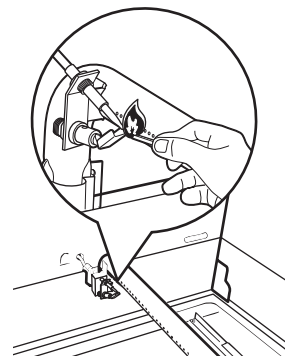

8 ADJUST THE OVEN BURNER AIR SHUTTER IF NECESSARY

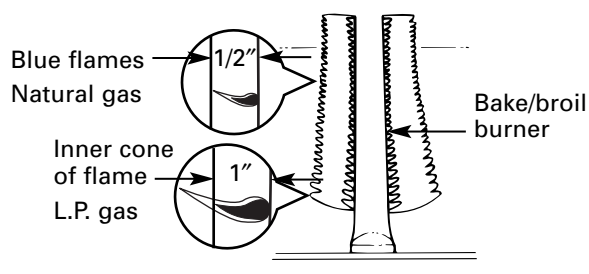

For Natural Gas:

The oven burner flame should be a clean, blue flame with distinct inner cones approximately 1/2 inch long. A soft, lazy flame with indistinct cones means too much gas or not enough air. A noisy lifting flame means too much air.

Installation Instructions

8 ADJUST THE OVEN BURNER AIR SHUTTER IF NECESSARY (CONT.)

For LP Gas:

The flame should have approximately 1-inch blue cones. After 30 seconds of burner operation, check for flames lifting off the burner ports. If lifting is observed, gradually reduce the air shutter opening until flames are stabilized. Some yellow tipping may be normal for LP gas.

If Adjustment is Necessary:

- A** Loosen the lock screw located at the top of the air shutter, then rotate the air shutter to the correct setting and retighten screw.

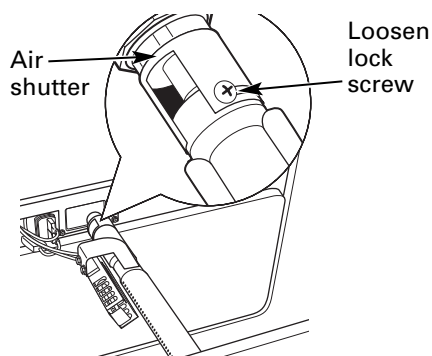

- B** Oven burner flame can be checked as follows (without burner baffle in place):
- To correct a yellow flame—Increase size of air shutter opening.
 - To correct a lifting, but distinct, blue flame—Decrease size of air shutter opening.
- C** The air shutter should be set approximately 2/3 open for natural gas, and approximately full open for LP gas.
- D** The oven burner air shutter adjustment is the same on ranges with a gas pilot or electric ignition.

9 QUALITY OF FLAMES

The combustion quality of burner flames needs to be determined visually.



- (A) Yellow flames:**
Further adjustment required

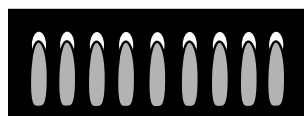

- (B) Yellow tips on outer cones:**
Normal for LP gas



- (C) Soft blue flames:**
Normal for natural gas

If burner flames look like (A), further adjustment is required. Normal burner flames should look like (B) or (C), depending on the type of gas you use.

With LP gas, some yellow tipping on outer cones is normal

10 REPLACE OVEN PARTS

After all adjustments are made, replace the oven bottom, shelves and oven door.

Installation Instructions

11 LEVEL THE RANGE

For proper cooking and baking, the range must be leveled. Leveling legs are located on each corner at the base of the range.

- A** Install the oven shelves (see use and care section for instructions). Put a spirit level or a glass measuring cup partially filled with water on one of the oven shelves.

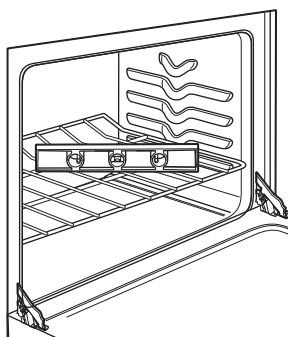

- B** Turn the legs counterclockwise to raise the range and counterclockwise to lower the range. Adjust the leveling legs until the range is level.

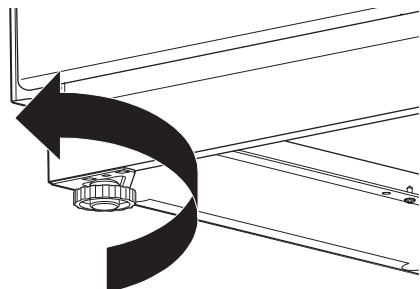

- C** After the range is level, slide the range away from the wall so that the Anti-Tip device can be installed.

12 INSTALL THE ANTI-TIP DEVICE

WARNING —

- Range must be secured with an approved Anti-Tip device.
- Unless properly installed, the range could be tipped by you or a child standing, sitting or leaning on an open door.
- After installing the Anti-Tip device, verify that it is in place by carefully attempting to tilt the range forward.
- This range has been designed to meet all recognized industry tip standards for all normal conditions.
- The use of this device does not preclude tipping of the range when not properly installed.
- If the Anti-Tip device supplied with the range does not fit this application, use the universal Anti-Tip device WB2X7909.

- A** Mark the wall where the **RIGHT EDGE** of the range is to be located. Be sure to allow for the countertop overhang if you intend to install the range next to cabinets.

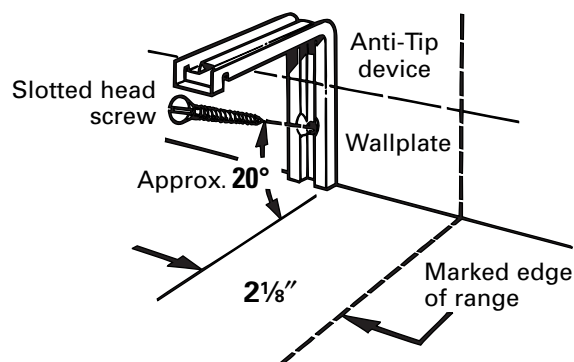

- B** Locate the outside edge of the device 2 1/8" toward the center of the range from the marked edge of the range.
- C** Using the device as a template, mark the position of the hole for the screw.

Installation Instructions

12 INSTALL THE ANTI-TIP DEVICE (cont.)

- D** For wood construction, drill a pilot hole at an angle of 20° from the horizontal. A nail or awl may be used if a drill is not available.

Mount the Anti-Tip device with the screw provided.

For cement or concrete construction, you will need a 1/4" x 1 1/2" lag bolt and a 1/2" O.D. sleeve anchor, which are not provided. Drill the recommended size hole for the hardware.

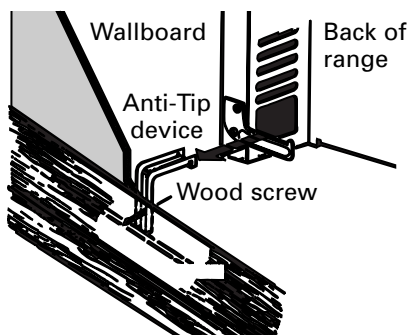

Install the sleeve anchor into the drilled hole and then install the lag bolt through the device. The bolts must be properly tightened as recommended for the hardware.

- E** Slide the range against the wall, and check for proper installation by grasping the front edge of the cooktop and carefully attempting to tilt the range forward.

WHEN ALL HOOKUPS ARE COMPLETED

Make sure all controls are left in the OFF position. Make sure the flow of combustion and ventilation air to the range is unobstructed.

Mobile Home Installation:

Be sure the installation of this range in a manufactured or mobile home conforms with the Manufactured Home Construction and Safety Title 24 CFR, Part 3280 [formerly the Federal Standard for Mobile Home Construction and Safety Title 24, H.U.D. (Part 280)] or when such standards are not applicable, the Standard for Manufactured Home Installations 1984 (Manufactured Home Sites Communities and Set-Ups), ANSI A225.1-latest edition, or with local codes. In Canada, mobile home installation must be in accordance with the current CAN/CSA Z240/MH Mobile Home Installation Code.

Model and Serial Number Location:

The serial plate for your range is located under the cooktop. See the Lift-Up Cooktop section in this manual for instructions on how to lift the cooktop. See the *Lift-Up Cooktop* section in this manual for instructions on how to lift the cooktop. In addition to the model and serial numbers, it tells you the ratings of the burners and type of fuel and pressure for which the range was adjusted when it left the factory.

When ordering parts, always include the model number and serial number to ensure proper replacement parts. Parts may be obtained through General Electric/Hotpoint Factory Service Centers or General Electric/Hotpoint authorized Customer Care® servicers.



CONVERT TO LP GAS (or convert back to natural gas from LP)

This range leaves the factory set for use with natural gas. If you want to convert to LP gas, the conversion must be performed by a qualified LP gas installer.

The conversion instructions and LP orifices can be found attached to the back of the range.

Keep these instructions and the orifices in case you want to convert back to natural gas.

Before you call for service...

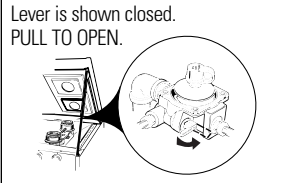
	Problem	Possible Causes	What To Do
Safety Instructions	Oven temperature too hot or too cold	Oven thermostat needs adjustment.	<ul style="list-style-type: none"> See the <i>Adjust the oven thermostat—Do it yourself!</i> section.
	Top burners do not light or do not burn evenly	The pilots are not lit. (on standing pilot models)	<ul style="list-style-type: none"> On models with standing pilots, lift the cooktop and hold a lit match next to the pilot opening between the front and rear burners.
Plug on range is not completely inserted in the electrical outlet.		<ul style="list-style-type: none"> On models with electric ignition, make sure electrical plug is plugged into a live, properly grounded outlet. 	
Burner holes on the side or around the top of the burner may be clogged.		<ul style="list-style-type: none"> Remove the burners and clean them with a safety pin or paper clip. Make sure you do not enlarge the holes. 	
Burners may not be fitted correctly onto mounting brackets.		<ul style="list-style-type: none"> Remove the burners and reinstall them properly. 	
Operating Instructions	Burners have yellow or yellow-tipped flames	The combustion quality of burner flames needs to be determined visually.	<ul style="list-style-type: none"> Use the illustrations below to determine if your burner flames are normal. If burner flames look like A, further adjustment is required. Normal burner flames should look like B or C, depending on the type of gas you use. With LP gas, some yellow tipping on outer cones is normal.
			<div style="display: flex; justify-content: space-around; align-items: flex-end;"> <div style="text-align: center;">  <p>A—Yellow flames Further adjustment required</p> </div> <div style="text-align: center;">  <p>B—Yellow tips Normal for LP gas</p> </div> <div style="text-align: center;">  <p>C—Soft blue flames Normal for natural gas</p> </div> </div>
Care and Cleaning	Burner flames very large or yellow	LP gas is improperly connected.	<ul style="list-style-type: none"> Check all steps in the <i>Installation of the range</i> section.
	Oven will not work	The thermostat capillary bulb must be clean and unobstructed.	<ul style="list-style-type: none"> Make sure the thermostat capillary bulb (located in the upper portion of the oven) is in the correct position, not touching oven sides and not coated with anything.
The oven vent is blocked.		<ul style="list-style-type: none"> The oven vent, on the back of the range, must be unobstructed. 	
Oven control improperly set.		<ul style="list-style-type: none"> See the <i>Using the oven</i> sections. 	
Incorrect cookware or cookware of improper size being used.		<ul style="list-style-type: none"> See the <i>Using the oven for baking or roasting</i> section. 	
Oven bottom not securely seated in position.		<ul style="list-style-type: none"> See the <i>Care and cleaning of the range</i> section. 	
Installation Instructions	Strong odor	Pilot light is not lit (on standing pilot models)	<ul style="list-style-type: none"> See the <i>Oven Lighting Instructions for Standing Pilot Models</i> section.
		Improper air/gas ratio in the oven.	<ul style="list-style-type: none"> Adjust oven burner air shutter. See the <i>Installation of the range</i> section.
Troubleshooting Tips	Surface burners light but oven does not	This is temporary.	<ul style="list-style-type: none"> An odor from the insulation around the oven liner is normal for the first few times the oven is used.
		The oven gas shut-off valve may have accidentally been moved during cleaning or moving.	<ul style="list-style-type: none"> To check the oven gas shut-off valve on standard twin burner models, raise cooktop and look for gas shut-off lever at the extreme left rear corner. (Standing pilot models do not have a gas shut-off valve on the regulator.)
Consumer Support	<div style="border: 1px solid black; padding: 5px; width: fit-content;"> <p>Lever is shown closed. PULL TO OPEN.</p>  </div>		

Gas Range Warranty.



All warranty service provided by our Factory Service Centers, or an authorized Customer Care® technician. To schedule service, on-line, 24 hours a day, visit us at ge.com, or call 800.GE.CARES (800.432.2737). Please have serial number and model number available when calling for service.

Staple your receipt here.
Proof of the original purchase date is needed to obtain service under the warranty.

For The Period Of: We Will Replace:

One Year

From the date of the original purchase

Any part of the range which fails due to a defect in materials or workmanship. During this **limited one-year warranty**, we will also provide, **free of charge**, all labor and in-home service to replace the defective part.

What is Not Covered:

- Service trips to your home to teach you how to use the product.
- Improper installation, delivery or maintenance.
- Failure of the product if it is abused, misused, or used for other than the intended purpose or used commercially.
- Damage caused after delivery.
- Replacement of house fuses or resetting of circuit breakers.
- Damage to the product caused by accident, fire, floods or acts of God.
- Incidental or consequential damage caused by possible defects with this appliance.
- Product not accessible to provide required service.

EXCLUSION OF IMPLIED WARRANTIES—Your sole and exclusive remedy is product repair as provided in this Limited Warranty. Any implied warranties, including the implied warranties of merchantability or fitness for a particular purpose, are limited to one year or the shortest period allowed by law.

This warranty is extended to the original purchaser and any succeeding owner for products purchased for home use within the USA. If the product is located in an area where service by a GE Authorized Servicer is not available, you may be responsible for a trip charge or you may be required to bring the product to an Authorized GE Service location for service. In Alaska, the warranty excludes the cost of shipping or service calls to your home.

Some states do not allow the exclusion or limitation of incidental or consequential damages. This warranty gives you specific legal rights, and you may also have other rights which vary from state to state. To know what your legal rights are, consult your local or state consumer affairs office or your state's Attorney General.

Warrantor: General Electric Company, Louisville, KY 40225

Safety Instructions

Operating Instructions

Care and Cleaning

Installation Instructions

Troubleshooting Tips

Consumer Support

Consumer Support.



GE Appliances Website

ge.com

Have a question or need assistance with your appliance? Try the GE Appliances Website 24 hours a day, any day of the year! For greater convenience and faster service, you can now download Owner's Manuals, order parts or even schedule service on-line.

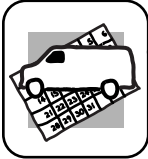

Schedule Service

ge.com

Expert GE repair service is only one step away from your door. Get on-line and schedule your service at your convenience 24 hours any day of the year! Or call 800.GE.CARES (800.432.2737) during normal business hours.

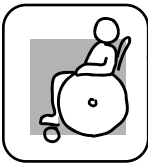

Real Life Design Studio

ge.com

GE supports the Universal Design concept—products, services and environments that can be used by people of all ages, sizes and capabilities. We recognize the need to design for a wide range of physical and mental abilities and impairments. For details of GE's Universal Design applications, including kitchen design ideas for people with disabilities, check out our Website today. For the hearing impaired, please call 800.TDD.GEAC (800.833.4322).



Extended Warranties

ge.com

Purchase a GE extended warranty and learn about special discounts that are available while your warranty is still in effect. You can purchase it on-line anytime, or call 800.626.2224 during normal business hours. GE Consumer Home Services will still be there after your warranty expires.

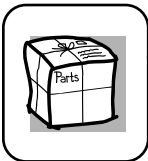

Parts and Accessories

ge.com

Individuals qualified to service their own appliances can have parts or accessories sent directly to their homes (VISA, MasterCard and Discover cards are accepted). Order on-line today, 24 hours every day or by phone at 800.626.2002 during normal business hours.

Instructions contained in this manual cover procedures to be performed by any user. Other servicing generally should be referred to qualified service personnel. Caution must be exercised, since improper servicing may cause unsafe operation.



Contact Us

ge.com

If you are not satisfied with the service you receive from GE, contact us on our Website with all the details including your phone number, or write to: General Manager, Customer Relations
GE Appliances, Appliance Park
Louisville, KY 40225



Register Your Appliance

ge.com

Register your new appliance on-line—at your convenience! Timely product registration will allow for enhanced communication and prompt service under the terms of your warranty, should the need arise. You may also mail in the pre-printed registration card included in the packing material.

Free Manuals Download Website

<http://myh66.com>

<http://usermanuals.us>

<http://www.somanuals.com>

<http://www.4manuals.cc>

<http://www.manual-lib.com>

<http://www.404manual.com>

<http://www.luxmanual.com>

<http://aubethermostatmanual.com>

Golf course search by state

<http://golfingnear.com>

Email search by domain

<http://emailbydomain.com>

Auto manuals search

<http://auto.somanuals.com>

TV manuals search

<http://tv.somanuals.com>