



Use and Care & Installation Guide

XL44™ Self-Cleaning Gas Range



Safety instructions	2-5
Anti-Tip Device	2,3, 31,39



Operating Instructions, Tips

Aluminum Foil	5, 15, 17-19
Clock and Timer	11
Features	6, 7
Oven	12-23
Baking	14, 15
Broiling, Broiling Guide	19, 20
Control Settings.....	b..... 12
Door Latch.....	1 4, 17, 19,22,23
Light; Bulb Replacement	12,28
Preheating	14
Roasting, Roasting Guide	17, 18
Self-Cleaning instructions	2 1-23
Shelves	13-15, 17,22,23,27
Surface Cooking	8-1 0
Control Settings.....	9
Cooktop Comparison	8
Electric Ignition.....	8



Care and Cleaning

Broiler Pan and Rack	27
Burner Assembly	24
Door Removal.....	27
Cooktop	26
Lift-up Cooktop.....	29
Oven Bottom	26
Oven Vents	29
Storage Drawer	28



Problem Solver.....45, 46

Thermostat Adjustment—	
Do It Yourself	16
More questions ?...call	
GE Answer Center™	80-626.2000



Preparation.....30-44

Air Adjustment.....	38
Flame Size.....	9, 37,38,44
Flooring Under the Range	32
Installation instructions	30-3 9
Leveling.....	39
LP Conversion.....	40-44



Consumer Services47

Appliance Registration.....	2
Important Phone Numbers	47
Model and Serial Number Location	2
Warranty	48

Models: JGBP24 JGBP30
JGBP25 JGBP32
JGBP29 JGBP33

GE Appliances



HELP US HELP YOU...

Read this guide carefully.

It is intended to help you operate and maintain your new range properly.

Keep it handy for answers to your questions.

If you don't understand something or need more help, write (include your phone number):

Consumer Affairs
GE Appliances
Appliance Park
Louisville, KY 40225

Write down the model and serial numbers.

Depending on your range, you'll find the model and serial numbers on a label on the front of the range, behind the kick panel, storage drawer or broiler drawer.

These numbers are also on the Consumer Product Ownership Registration Card that came with your range. Before sending in this card, please write these numbers here:

Model Number _____ Serial Number _____

Use these numbers in any correspondence or service calls concerning your range.

If you received a damaged range...

Immediately contact the dealer (or builder) that sold you the range.

Save time and money. Before you request service...

Check the Problem Solver in the back of this guide. It lists causes of minor operating problems that you can correct yourself.

WARNING: If the information in this guide is not followed exactly, a fire or explosion may result causing property damage, personal injury or death.

- **Do not store or use gasoline or other flammable vapors and liquids in the vicinity of this or any other appliance.**
- **WHAT TO DO IF YOU SMELL GAS**
 - **Do not try to light any appliance.**
 - **Do not touch any electrical switch; do not use any phone in your building.**
 - **Immediately call your gas supplier from a neighbor's phone. Follow the gas supplier's instructions.**
 - **If you cannot reach your gas supplier, call the fire department.**
- **Installation and service must be performed by a qualified installer, service agency or the gas supplier.**

IF YOU NEED SERVICE

To obtain service, see the Consumer Services page in the back of this guide.

To obtain replacement parts, contact *GE/Hotpoint* Service Centers.

We're proud of our service and want you to be pleased. If for some reason you are not happy with the service you receive, here are three steps to follow for further help.

FIRST, contact the people who serviced your appliance. Explain why you are not pleased. In most cases, this will solve the problem.

NEXT, if you are still not pleased, write all the details—including your phone number—to:

Manager, Consumer Relations
GE Appliances
Appliance Park
Louisville, KY 40225

FINALLY, if your problem is still not resolved, write:
Major Appliance Consumer Action Panel
20 North Wacker Drive
Chicago, IL 60606

	A WARNING
	<ul style="list-style-type: none"> • ALL RANGES CAN TIP • INJURY TO PERSONS COULD RESULT • INSTALL ANTI-TIP DEVICES PACKED WITH RANGE • SEE INSTALLATION INSTRUCTIONS



IMPORTANT SAFETY INSTRUCTIONS

Read all instructions before using this appliance.



IMPORTANT SAFETY NOTICE

* **The California Safe Drinking Water and Toxic Enforcement Act** requires the Governor of California to publish a list of substances known to the state to cause cancer, birth defects or other reproductive harm, and requires businesses to warn customers of potential exposure to such substances.

Gas appliances can cause minor exposure to four of these substances, namely benzene, carbon monoxide, formaldehyde and soot, caused primarily by the incomplete combustion of natural gas or LP fuels. Properly adjusted burners, indicated by a bluish rather than a yellow flame, will minimize incomplete combustion. Exposure to these substances can be minimized by venting with an open window or using a ventilation fan or hood.

• **Fluorescent light bulbs and safety valves on standing pilot ranges contain mercury.** If your model has these features, they must be recycled according to local, state and federal codes.

When You Get Your Range

- **Have the installer show you the location of the range gas cut-off valve and how to shut it off if necessary.**
- **Have your range installed and properly grounded by a qualified installer**, in accordance with the Installation Instructions. Any adjustment and service should be performed only by qualified gas range installers or service technicians.
- **Do not attempt to repair or replace any part of your range unless it is specifically recommended in this guide.** All other servicing should be referred to a qualified technician.
- **Plug your range into a 120-volt grounded outlet only.** Do not remove the round grounding prong from the plug. If in doubt about the grounding of the home electrical system, it is your personal responsibility and obligation to have an ungrounded outlet replaced with a properly grounded, three-prong outlet in accordance with the National Electrical Code. In Canada, the appliance must be electrically grounded in accordance with the Canadian Electrical Code. Do not use an extension cord with this appliance.
- **Locate the range out of kitchen traffic path and out of drafty locations to prevent pilot outage (on standing pilot models) and poor air circulation.**

• **Be sure all packing materials are removed from the range** before operating it to prevent fire or smoke damage should the packing material ignite.

• **Be sure your range is correctly adjusted by a qualified service technician or installer for the type of gas (natural or LP) that is to be used.** Your range can be converted for use with either type of gas. See the Installation Instructions.

WARNING: These adjustments must be made by a qualified service technician in accordance with the manufacturer's instructions and all codes and requirements of the authority having jurisdiction. Failure to follow these instructions could result in serious injury or property damage. The qualified agency performing this work assumes responsibility for the conversion.

• **After prolonged use of a range, high floor temperatures may result and many floor coverings will not withstand this kind of use.** Never install the range over vinyl tile or linoleum that cannot withstand such type of use. Never install it directly over interior kitchen carpeting.

Using Your Range

▲ WARNING—All ranges can tip and injury could result. To prevent accidental tipping of the range, attach it to the wall and floor by installing the Anti-Tip device supplied.



To check if the device is installed and engaged properly, carefully tip the range forward. The Anti-Tip device should engage and prevent the range from tipping over.



If you pull the range out from the wall for any reason, make sure the device is properly engaged when you push the range back against the wall. If it is not, there is a possible risk of the range tipping over and causing injury if you or a child stand, sit or lean on an open door.

Please refer to the Anti-Tip device information in this guide. Failure to take this precaution could result in tipping of the range and injury.

- **Do not leave children alone or unattended where a range is hot or in operation.** They could be seriously burned.
- **For your safety, never use your appliance for warming or heating the room.**

(continued next page)



IMPORTANT SAFETY INSTRUCTIONS

(continued)

- **CAUTION: ITEMS OF INTEREST TO CHILDREN SHOULD NOT BE STORED IN CABINETS ABOVE A RANGE OR ON THE BACKSPASH OF A RANGE—CHILDREN CLIMBING ON THE RANGE TO REACH ITEMS COULD BE SERIOUSLY INJURED.**
- **Do not allow anyone to climb, stand or hang on the door, broiler drawer or cooktop.** They could damage the range and even tip it over, causing severe personal injury.
- **Let the burner grates and other surfaces cool before touching them or leaving them where children can reach them.**
- **Never wear loose fitting or hanging garments while using the appliance.** Be careful when reaching for items stored in cabinets over the cooktop. Flammable material could be ignited if brought in contact with flame or hot oven surfaces and may cause severe burns.
- **Do not use water on grease fires. Never pick up a flaming pan.** Turn the controls off. Smother a flaming pan on a surface unit by covering the pan completely with a well-fitting lid, cookie sheet or flat tray. Use a multi-purpose dry chemical or foam-type fire extinguisher.
Flaming grease outside a pan can be put out by covering it with baking soda or, if available, by using a multi-purpose dry chemical or foam-type fire extinguisher.
Flame in the oven can be smothered completely by closing the oven door and turning the oven off or by using a multi-purpose dry chemical or foam-type fire extinguisher.
- **Do not store flammable materials in an oven, a range broiler or storage drawer or near a cooktop.**
- **DO NOT STORE OR USE COMBUSTIBLE MATERIALS, GASOLINE OR OTHER FLAMMABLE VAPORS AND LIQUIDS IN THE VICINITY OF THIS OR ANY OTHER APPLIANCE.**
- **Do not let cooking grease or other flammable materials accumulate in or near the range.**
- **When cooking pork,** follow the directions exactly and always cook the meat to an internal temperature of at least 170°F. This assures that, in the remote possibility that trichina may be present in the meat, it will be killed and the meat will be safe to eat.
- **Always use the LITE position (on electric ignition models) or the HI position (on standing pilot models) when igniting the top burners and make sure the burners have ignited,**
- **Never leave the surface burners unattended at high flame settings.** Boilovers cause smoking and greasy spillovers that may catch on fire.
- **Adjust the top burner flame size so it does not extend beyond the edge of the cookware.** Excessive flame is hazardous,
- **Use only dry pot holders—**moist or damp pot holders on hot surfaces may result in burns from steam.
- **Do not let pot holders come near open flames when lifting cookware.** Do not use a towel or other bulky cloth in place of a pot holder.
- **To minimize the possibility of burns,** ignition of flammable materials and spillage, turn cookware handles toward the side or back of the range without extending over adjacent burners.
- **Always turn the surface burners to off before removing cookware.**
- **Carefully watch foods being fried at a high flame setting.**
- **Never block the vents (air openings) of the range.** They provide the air inlet and outlet that are necessary for the range to operate properly with correct combustion. Air openings are located at the rear of the cooktop, at the top and bottom of the oven door, and at the bottom of the range under the storage drawer or kick panel.
- **Do not use a wok on models with sealed burners if the wok has a round metal ring that is placed over the burner grate to support the wok.** This ring acts as a heat trap, which may damage the burner grate and burner head. Also, it may cause the burner to work improperly. This may cause a carbon monoxide level above that allowed by current standards, resulting in a health hazard.
- **Foods for frying should be as dry as possible.** Frost on frozen foods or moisture on fresh foods can cause hot fat to bubble up and over the sides of the pan.
- **Use the least possible amount of fat for effective shallow or deep-fat frying.** Filling the pan too full of fat can cause spillovers when food is added,
- **Use a deep fat thermometer** whenever possible to prevent overheating fat beyond the smoking point.
- **Never try to move a pan of hot fat,** especially a deep fat fryer. Wait until the fat is cool.
- **When using glass cookware,** make sure it is designed for top-of-range cooking.

Surface Cooking

- **Always heat fat slowly, and watch as it heats.**



- **If a combination of oils or fats will be used in frying**, stir together before heating or as fats melt slowly.
- **Use proper pan size**—Avoid pans that are unstable or easily tipped. Select cookware having flat bottoms large enough to properly contain food and avoid boilovers and spillovers and large enough to cover burner grate. This will both save cleaning time and prevent hazardous accumulations of food, since heavy spattering or spillovers left on range can ignite. Use pans with handles that can be easily grasped and remain cool.
- **Keep all plastics away from the top burners.**

- **Do not leave plastic items on the cooktop**—they may melt if left too close to the vent.



- **Do not leave any items on the cooktop.**
The hot air from the vent may ignite flammable items and will increase pressure in closed containers, which may cause them to burst.
- **To avoid the possibility of a burn, always be certain that the controls for all burners are at the off position and all grates are cool before attempting to remove them.**
- **When flaming foods are under the hood, turn the fan off. The fan, if operating, may spread the flames.**
- **If range is located near a window**, do not hang long curtains that could blow over the top burners and create a fire hazard.
- **When a pilot goes out** (on standing pilot models), you will detect a faint odor of gas as your signal to relight the pilot. When relighting the pilot, make sure burner controls are in the off position, and follow instructions in this book to relight.
- **If you smell gas**, and you have already made sure pilots are lit (on standing pilot models), turn off the gas to the range and call a qualified service technician. Never use an open flame to locate a leak.

Baking, Broiling and Roasting

- **Do not use the oven for a storage area.** Items stored in the oven can ignite.
- **Place the oven shelves in the desired position while the oven is cool.**
- **Stand away from the range when opening the door of a hot oven.** The hot air and steam that escapes can cause burns to hands, face and eyes.

- **Keep the oven free from grease buildup.**
- **Pulling out the shelf to the shelf-stop is a convenience in lifting heavy foods, It is also a precaution against burns from touching hot surfaces of the door or oven walls. The lowest position “R” is not designed to slide.**
- **Do not heat unopened food containers. Pressure could build up and the container could burst, causing an injury.**
- **Do not use aluminum foil anywhere in the oven except as described in this guide.** Misuse could result in a fire hazard or damage to the range.
- **When using cooking or roasting bags in the oven, follow the manufacturer’s directions.**
- **Use only glass cookware that is recommended for use in gas ovens.**
- **Always remove the broiler pan from range as soon as you finish broiling.** Grease left in the pan can catch fire if oven is used without removing the grease from the broiler pan.
- **When broiling, if meat is too close to the flame, the fat may ignite.** Trim excess fat to prevent excessive flare-ups.
- **Make sure the broiler pan is in place correctly** to reduce the possibility of grease fires.
- **If you should have a grease fire in the broiler pan, turn off oven control, and keep broiler drawer and oven door closed to contain fire until it burns out.**

Self-Cleaning Oven

- **Clean only parts listed in this Use and Care Guide.**
- **Do not clean door gasket.** The door gasket is essential for a good seal. Care should be taken not to rub, damage or move the gasket.
- **Do not use oven cleaners.** No commercial oven cleaner or oven liner protective coating of any kind should be used in or around any part of the oven. Residue from oven cleaners will damage the inside of the oven when the self-clean cycle is used.
- **Before self-cleaning the oven, remove broiler pan and rack and other cookware.**
- **Be sure to wipe up excess spillage before starting the self-cleaning operation.**
- **If the self-cleaning mode malfunctions, turn the oven off and disconnect the power supply.** Have it serviced by a qualified technician.

**SAVE THESE
INSTRUCTIONS**



FEATURES OF YOUR RANGE

Features and appearance vary.

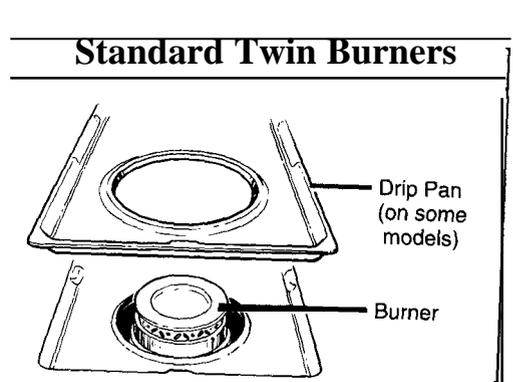
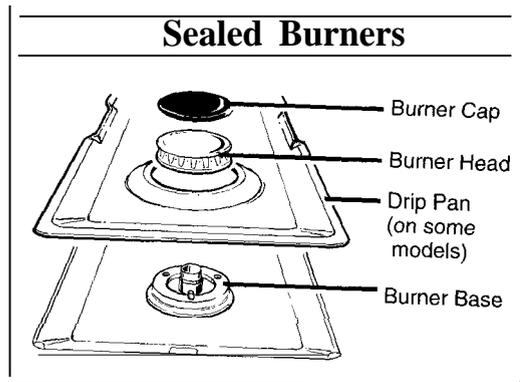
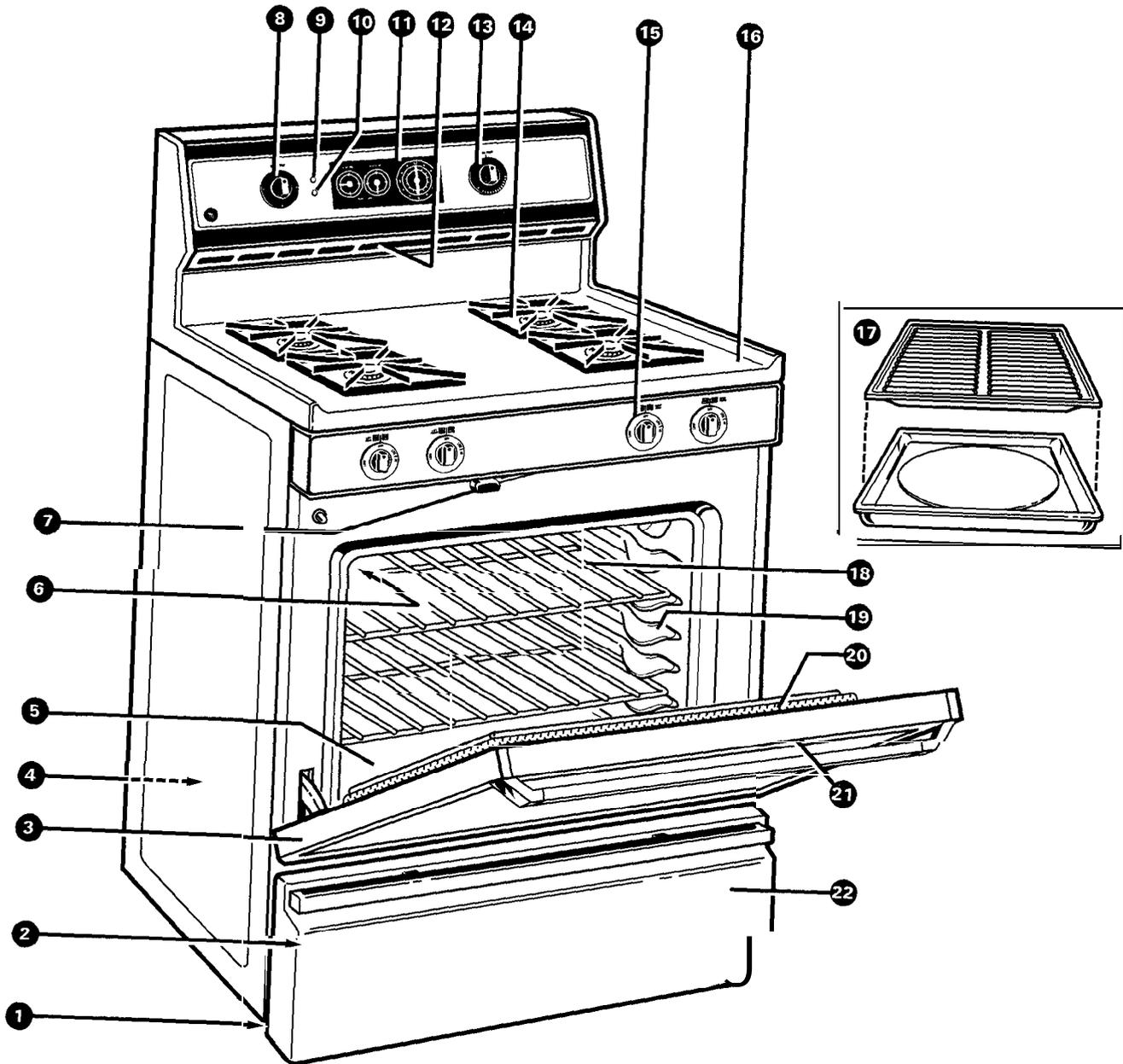

Your range is equipped with one of the two types of surface burners shown above.



Feature Index (Not all models have all features. Appearance of features varies.)	See page
1 Air Intake (under storage drawer)	4,29
2 Model and Serial Numbers (on front frame of range, behind storage drawer or kick panel)	–
3 Lift-Off Oven Door	19,20,27
4 Anti-Tip Device (Lower right rear corner on range back. See the Installation Instructions.)	2,3,31,39
5 Oven Bottom	26
6 Oven Interior Light	12,21,28
7 Oven Door Latch (use for Self-Cleaning cycle only)	14, 17, 19,22,23
8 OVEN SET Knob	11, 12, 14, 17, 19,22,28
9 Oven “On” Indicator Light	12
10 Oven Cleaning Indicator Light	22
11 Automatic Oven Timer, Clock and Minute Timer	11, 14,22,23
12 Oven Vent	4,5, 13,29
13 OVEN TEMP Knob	11, 12, 14, 16, 17, 19,22,23,28
14 Grates, Drip Pans (on some models) and Surface Burners	4,5, 8–10, 21,24,26
15 Surface Burner Control Knobs	8-10,24,25,28
16 Cooktop	4,13,23,26,29
17 Broiler Pan and Rack (Do not clean in the self-cleaning oven.)	5, 17, 19,20, 21,27
18 Oven Shelves (easily removed or repositioned on shelf supports)	5, 12-15, 17, 19, 21–23, 27
19 Oven Shelf Supports	5, 13, 14, 17, 19,22,23,27
20 Oven Door Gasket	5,21,27
21 Air Vent in Oven Door (top of oven door)	4,13,29
22 Storage Drawer or Kick Panel (depending on model)	4,28,29



HOW DOES THIS COOKTOP COMPARE TO YOUR OLD ONE?

Your new cooktop has gas burners. If you are used to cooking with induction or other electric surface units, you will notice some differences when you use gas burners.

The best types of cookware to use > plus heat-up and cool-down times, depend upon the type of burner or surface unit you have.

The following chart will help you to understand the differences between gas burner cooktops and any other type of cooktop you may have used in the past.

Type of Cooktop	Description	How it Works
Gas Burners 	Regular or sealed gas burners use either LP gas or natural gas .	Flames heat the pans directly. Pan flatness is not critical to cooking results, but pans should be well balanced. Gas burners heat the pan right away and change heat settings right away. When you turn the control off, cooking stops right away.
Radiant (Glass Ceramic) Cooktop 	Electric coils under a glass-ceramic cooktop.	Heat travels to the glass surface and then to the cookware, so pans must be flat on the bottom for good cooking results. The glass cooktop stays hot enough to continue cooking after it is turned off. Remove the pan from the surface unit if you want cooking to stop.
Induction 	High frequency induction coils under a glass surface.	Pans must be made of ferrous metals (metal that attracts a magnet). Heat is produced by a magnetic circuit between the coil and the pan. Heats up right away and changes heat settings right away, like a gas cooktop. After turning the control off, the glass cooktop is hot from the heat of the pan, but cooking stops right away.
Electric Coil 	Flattened metal tubing containing electric resistance wire suspended over a drip pan.	Heats by direct contact with the pan and by heating the air under the pan. For best cooking results, use good quality pans. Electric coils are more forgiving of warped pans than radiant or solid disks. Heats up quickly but does not change heat settings as quickly as gas or induction. Electric coils stay hot enough to continue cooking for a short time after they are turned off.
Solid Disk 	Solid cast iron disk sealed to the cooktop surface.	Heats by direct contact with the pan, so pans must be flat on the bottom for good cooking results. Heats up and cools down more slowly than electric coils. The disk stays hot enough to continue cooking after it is turned off. Remove the pan from the solid disk if you want the cooking to stop.

SURFACE COOKING

Lighting Instructions

Your surface burners are lighted by electric ignition, eliminating the need for standing pilot lights with constantly burning flames.

In case of a power failure, you can light the surface burners on your range with a match. Hold a lighted match to the burner, then turn the knob to the LITE position. Use extreme caution when lighting burners this way.

Surface burners in use when an electrical power failure occurs will continue to operate normally.

The electrode of the spark igniter is exposed. When one burner is turned to LITE, all the burners spark. Do not attempt to disassemble or clean around any burner while another burner is on. An electric shock may result, which could cause you to knock over hot cookware.

Surface Burner Controls

The knobs that turn the surface burners *on and off* are located on the control panel in front of the burners.

The two knobs on the left control the left front and left rear burners. The two knobs on the right control the right front and right rear burners.

On ranges with sealed burners:

- The smaller burner (right rear position) will give the best simmer results. It offers precise cooking performance for delicate foods, such as sauces Or foods which need to cook over low heat for a long time. It can be turned down to a very low simmer setting.
- The right front burner is higher powered than the others and will bring liquids to a boil quicker (natural gas installations only).

Before Lighting a Burner

- If drip pans are supplied with your range, they should be used at all times.
- Make sure all grates on the range are in place before using any burner.

To Light a Surface Burner

Push the control knob in and turn it to **LITE**. You will hear a little “clicking” noise—the sound of the electric spark igniting the burner.

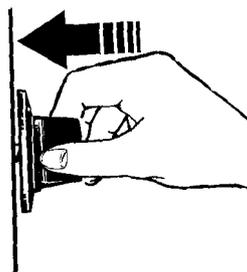

After Lighting a Burner

- After the burner ignites, turn the knob to adjust the flame size.
- Check to be sure the burner you turned on is the one you want to use.
- Do not operate a burner for an extended period of time without cookware on the grate. The finish on the grate may chip without cookware to absorb the heat.
- Be sure the burners and grates are cool before you place your hand, a pot holder, cleaning cloths or other materials on them.

How to Select Flame Size

Watch the flame, not the knob, as you reduce heat.

The flame size on a gas burner should match the cookware you are using.

FOR SAFE HANDLING OF COOKWARE NEVER LET THE FLAME EXTEND UP THE SIDES OF THE COOKWARE.

Any flame larger than the bottom of the cookware is wasted and only serves to heat the handle.

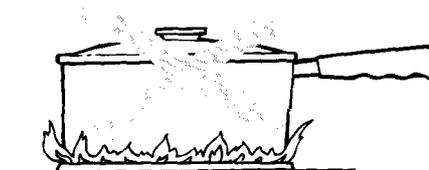

(continued next page)



SURFACE COOKING

(continued)

Top-of-Range Cookware

Aluminum: Medium-weight cookware is recommended because it heats quickly and evenly. Most foods brown evenly in an aluminum skillet. Use saucepans with tight-fitting lids when cooking with minimum amounts of water.

Cast-Iron: If heated slowly, most skillets will give satisfactory results.

Enamelware: Under some conditions, the enamel of some cookware may melt. Follow cookware manufacturer's recommendations for cooking methods.

Glass: There are two types of glass cookware—those for oven use only and those for top-of-range cooking (saucepans, coffee and teapots). Glass conducts heat very slowly.

Heatproof Glass Ceramic: Can be used for either surface or oven cooking. It conducts heat very slowly and cools very slowly. Check cookware manufacturer's directions to be sure it can be used on gas ranges.

Stainless Steel: This metal alone has poor heating properties and is usually combined with copper, aluminum or other metals for improved heat distribution. Combination metal skillets usually work satisfactorily if they are used with medium heat as the manufacturer recommends.

Stove Top Grills (on models with sealed burners)

Do not use stove top grills on your sealed gas burners. If you use the stove top grill on the sealed gas burner it will cause incomplete combustion and can result in exposure to carbon monoxide levels above allowable current standards. This can be hazardous to your health.

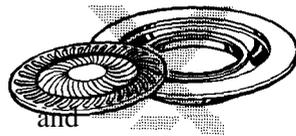

Wok Cooking (on models with sealed burners)

We recommend that you use only a flat-bottomed wok. They are available at your local retail store.



Do not use woks **that support rings.** Use of these types of woks, with or without the ring in place, can be dangerous. Placing the ring over the burner grate may cause the burner to work improperly resulting in carbon monoxide levels above allowable current standards. This could be dangerous to your health. Do not try to use such woks without the ring. You could be seriously burned if the wok tipped over.

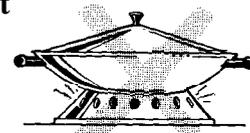

CLOCK AND TIMERS



Clock and Minute Timer

To set the clock, push the knob in and turn the clock hands to the correct time. Then let the knob out and continue turning to OFF.

The **Minute Timer** has been combined with the range clock. Use it to time cooking operations. You'll recognize it as the pointer that is different in color from the clock hands.

Minutes are marked up to 60 on the center ring of the clock.

To set the **Minute Timer**, turn the knob to the left, *without pushing in*, until the pointer reaches the number of minutes you want to time.

At the end of the set time, a buzzer sounds to tell you time is up. Turn the knob, *without pushing in*, until the pointer reaches OFF and the buzzer stops.

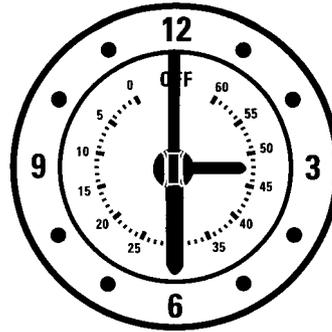

Automatic Oven Timer

This Timer will automatically start and stop your oven for you. Here's what you do:

1. Make sure both your range clock and the DELAY START dial show the correct time of day. When either the DELAY START dial or STOP TIME dial is pushed in and turned, it will "pop" into place when the time shown on the range clock is reached.
2. Set the DELAY START dial. Push in and turn the DELAY START dial to the time you want the oven to turn itself on. (If you want it to start cooking immediately, do not set a DELAY START time.)
3. Set the STOP TIME dial. Push in and turn the STOP TIME dial to the time you want the oven to turn itself off.

NOTE: There must be at least a half-hour difference between the DELAY START and STOP TIME dials, and times can be set only up to 11 hours and 45 minutes in advance.

4. Set the OVEN SET knob to TIME BAKE.
5. Set the OVEN TEMP knob to the desired cooking temperature.

The oven will turn itself on immediately unless you have set the DELAY START dial for a later starting time. It will operate at the temperature you selected and turn itself off at the Stop Time you selected.

Turn the OVEN TEMP knob to OFF and then remove the food from the oven.

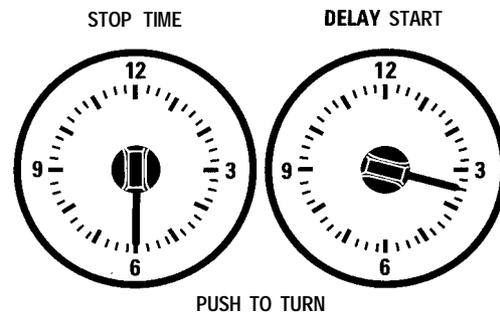



USING YOUR OVEN

Before Using Your Oven

Be sure you understand how to set the controls properly. Practice removing and replacing the shelves while the oven is cool. Read the information and tips on the following pages. Keep this guide handy where you can refer to it, especially during the first weeks of using your new range.

Electric Ignition

The oven burner and broil burner are lighted by electric ignition.

To light either burner, turn the OVEN SET knob to the desired oven operation and the OVEN TEMP knob to the desired temperature. The burner should ignite within 30-90 seconds.

After the oven reaches the selected temperature, the oven burner cycles—off completely, then on with a full flame—to keep the oven temperature controlled.

Power Outage

CAUTION: Do not make any attempt to operate the electric ignition oven during an electrical power failure.

The oven or broiler cannot be lit during a power failure. Gas will not flow unless the glow bar is hot.

If the oven is in use when a power failure occurs, the oven burner shuts off and cannot be re-lit until power is restored.

Oven Light

The oven light comes on automatically when the door is opened. Some models have a switch on the lower control panel that allows you to turn the light on or off when the door is closed.

Oven Indicator Light

The oven indicator light glows until the oven reaches your selected temperature, then goes off and on with the oven burner(s) during cooking.

Oven Moisture

As your oven heats up, the temperature change of the air in the oven may cause water droplets to form on the door glass. These droplets are harmless and will evaporate as the oven continues to heat up.

OVEN SET Control

The OVEN SET control has settings for BAKE, BROIL, TIME BAKE and CLEAN. When you turn the knob to the desired setting, the proper burner is activated for that operation.

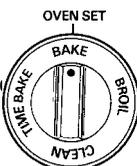

BAKE—Use this setting for all normal oven operations—for example, for cooking roasts or casseroles. Only the bottom oven burner operates during baking.

TIME BAKE—Use this setting to turn the oven on and off at specified times when you want cooking to start and stop. See Automatic Oven Timer section.

BROIL—Use this setting for broiling. Only the top (broil) burner will operate.

CLEAN—Use this setting for the self-cleaning function only.

OVEN TEMP Control

The OVEN TEMP control maintains the temperature you set for normal oven operation as well as for broiling. Push in and turn to set temperatures or to set into CLEAN position.

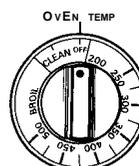

OFF—Shuts off power to the oven controls. Oven will not operate. The OVEN TEMP knob should be turned to OFF whenever the oven is not in use.

For normal oven operation, push in and turn the knob to the desired temperature. It will normally take 30-90 seconds before the flame comes on.

After the oven reaches the selected temperature, the oven burner cycles—off completely, then on with a full flame—to keep the oven temperature controlled.



Oven Vents

The oven is vented through duct openings at the rear of the cooktop. See the Features section. Do not block these openings when cooking in the oven—it is important that the flow of hot air from the oven and fresh air to the oven burners be uninterrupted.

• **The vent openings and nearby surfaces may become hot. Do not touch them.**



Vent appearance and location vary

• **Do not leave plastic items on the cooktop—they may melt if left too close to the vent.**

- **Handles of pots and pans on the cooktop may become hot if left too close to the vent.**
- **Metal items will become very hot if they are left on the cooktop and could cause burns.**
- **Do not leave any items on the cooktop.** The hot air from the vent may ignite flammable items and will increase pressure in closed containers, which may cause them to burst.

Oven Shelves

The shelves are designed with stop-locks so when placed correctly on the shelf supports, they will stop before coming completely out of the oven and will not tilt when you are removing food from them or placing food on them.

When placing cookware on a shelf, pull the shelf out to the bump on the shelf support. Place the cookware on the shelf, then slide the shelf back into the oven. This will eliminate reaching into the hot oven.

To remove a shelf from the oven, pull it toward you, tilt the front end upward and pull the shelf out.

To replace, place the shelf on the shelf support with the stop-locks (curved extension of the shelf) facing up and toward the rear of the oven. Tilt up the front and push the shelf toward the back of the oven until it goes past the bump on the shelf support. Then lower the front of the shelf and push it all the way back.

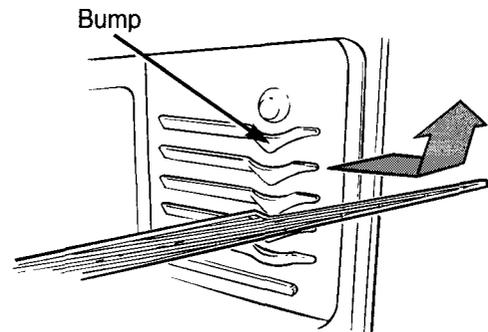

Shelf Positions

The oven has five shelf supports for baking, roasting and broiling identified in this illustration as A (bottom), B, C, D and E (top). It also has a special low shelf position (R) for roasting extra large items, such as a large turkey—the shelf is not designed to slide out at this position. Shelf positions for cooking are suggested in the Baking, Roasting and Broiling sections.

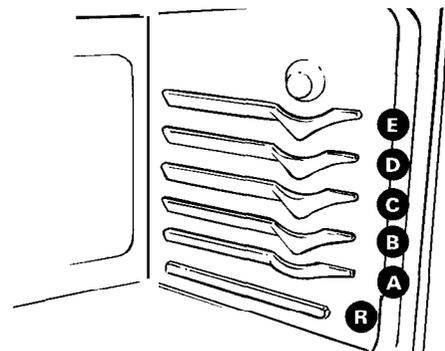



BAKING

Do not lock the oven door with the latch during baking. The latch is used for self-cleaning only.

Your oven temperature is controlled very accurately using an oven control system. It is recommended that you operate the oven for a number of weeks to become familiar with your new oven's performance.

If you think an adjustment is necessary, see the Adjust the Oven Thermostat section. It gives easy *Do It Yourself* instructions on how to adjust the thermostat.

How to Set Your Range for Baking

To avoid possible burns, place the shelves in the correct position before you turn the oven on.

1. Close the oven door. Turn the OVEN SET knob to BAKE or TIME BAKE and then turn the OVEN TEMP knob to the desired temperature.

See the Automatic Oven Timer section for Timed Baking.

2. Check the food for doneness at the minimum time on the recipe. Cook longer if necessary.
3. Turn the OVEN TEMP knob to OFF and then remove the food.

Oven Shelves

Arrange the oven shelf or shelves in the desired locations while the oven is cool. The correct shelf position depends on the kind of food and the browning desired.

As a general rule, place most foods in the middle of the oven, on either shelf position B or C. See the chart for suggested shelf positions.

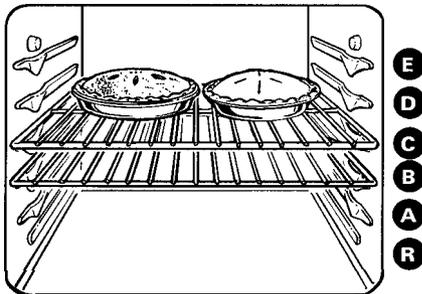

Type of Food	Shelf Position
Angel food cake	A
Biscuits or muffins	B or C
Cookies or cupcakes	B or C
Brownies	B or C
Layer cakes	B or C
Bundt or pound cakes	A or B
Pies or pie shells	B or C
Frozen pies	A (on cookie sheet)
Casseroles	B or C
Roasting	B or R

Preheating

Preheat the oven if the recipe calls for it. Preheat means bringing the oven up to the specified temperature before putting the food in the oven. To preheat, set the oven at the correct temperature—selecting a higher temperature does not shorten preheat time.

Preheating is necessary for good results when baking cakes, cookies, pastry and breads. For most casseroles and roasts, preheating is not necessary. For ovens without a preheat indicator light or tone, preheat 10 minutes. After the oven is preheated place the food in the oven as quickly as possible to prevent heat from escaping.

Pan Placement

For even cooking and proper browning, there must be enough room for air circulation in the oven. Baking results will be better if baking pans are centered as much as possible rather than being placed to the front or to the back of the oven.

Pans should not touch each other or the walls of the oven. Allow 1- to 1½-inch space between pans as well as from the back of the oven, the door and the sides. If you need to use two shelves, stagger the pans so one is not directly above the other.



Baking Guides

When using prepared baking mixes, follow package recipe or instructions for best baking results.

Cookies

When baking cookies, flat cookie sheets (without sides) produce better-looking cookies. Cookies baked in a jelly roll pan (short sides all around) may have darker edges and pale or light browning may occur.

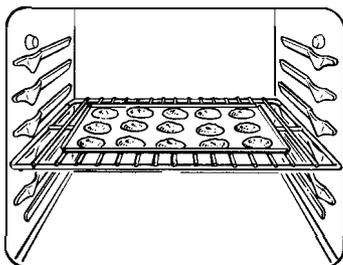

Do not use a cookie sheet so large that it touches the walls or the door of the oven.

For best results, use only one cookie sheet in the oven at a time.

Aluminum Foil

Never entirely cover a shelf with aluminum foil. This will disturb the heat circulation and result in poor baking. A smaller sheet of foil may be used to catch a spillover by placing it on a lower shelf several inches below the food.

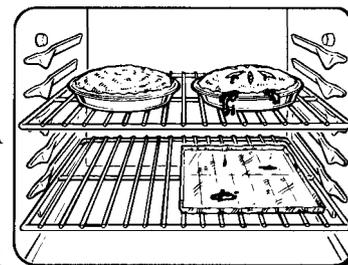

Pies

For best results, bake pies in dark, rough or dull pans to produce a browner, crisper crust. Frozen pies in foil pans should be placed on an aluminum cookie sheet for baking since the shiny foil pan reflects heat away from the pie crust; the cookie sheet helps retain it.

Cakes

When baking cakes, warped or bent pans will cause uneven baking results and poorly shaped products. A cake baked in a pan larger than the recipe recommends will usually be crisper, thinner and drier than it should be. If baked in a pan smaller than recommended, it may be undercooked and batter may overflow. Check the recipe to make sure the pan size used is the one recommended.

Baking Pans

Use the proper baking pan. The type of finish on the pan determines the amount of browning that will occur.

- Dark, rough or dull pans absorb heat resulting in a browner, crisper crust. Use this type for pies.
- Shiny, bright and smooth pans reflect heat, resulting in a lighter, more delicate browning. Cakes and cookies require this type of pan.
- Glass baking dishes also absorb heat. When baking in glass baking dishes, the temperature may need to be reduced by 25°F.

Don't Peek

Set the timer for the estimated cooking time and do not open the door to look at your food. Most recipes provide minimum and maximum baking times such as "bake 30-40 minutes."

DO NOT open the door to check until the minimum time. Opening the oven door frequently during cooking allows heat to escape and makes baking times longer. Your baking results may also be affected.



ADJUST **THE OVEN THERMOSTAT— DO IT YOURSELF!**

You may feel that your new oven cooks differently than the one it replaced. We recommend that you use your new oven for a few weeks to become more familiar with it, following the times given in your recipes as a guide.

If you think your new oven is too hot or too cold, you can adjust the thermostat yourself. If you think it is too hot, adjust the thermostat to make it cooler. If you think it is too cool, adjust the thermostat to make it hotter.

We do not recommend the use of inexpensive thermometers, such as those found in grocery stores, to check the temperature setting of your new oven. These thermometers may vary 20–40 degrees.

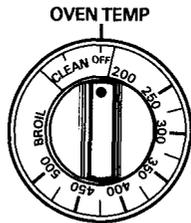

Front of the OVEN TEMP knob

To Adjust the Thermostat:

Back of the OVEN TEMP knob.

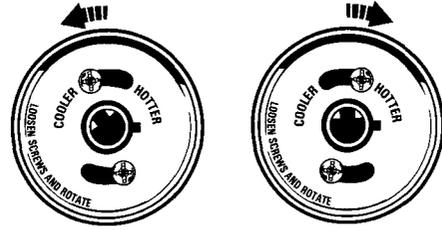

(appearance may vary)

Pull the OVEN TEMP knob off the range and look at the back side.

To make adjustment, loosen (approximately one turn), but do not completely remove, the two screws on the back of the knob. With the back of the knob facing you, hold the outer edge of the knob with one hand and turn the front of the knob with the other hand.

To raise the oven temperature, move the top screw toward the right. You'll hear a click for each notch you move the knob. **To lower the temperature**, move the top screw toward the left. Each click will change the oven temperature approximately 10°F. (Range is plus or minus 60°F from the arrow.)

We suggest that you make the adjustment one click from the original setting and check oven performance before making any additional adjustments.

After the adjustment is made, retighten the screws so they are snug, but be careful not to overtighten. Re-install the knob on the range and check performance.

ROASTING



Do not lock the oven door with the latch during roasting. The latch is used for self-cleaning only.

Roasting is cooking by dry heat. Tender meat or poultry can be roasted uncovered in your oven. Roasting temperatures, which should be low and steady, keep spattering to a minimum.

The oven has a special low shelf (R) position just above the oven bottom. Use it when extra cooking space is needed, for example, when roasting a large turkey. The shelf is not designed to slide out at this position.

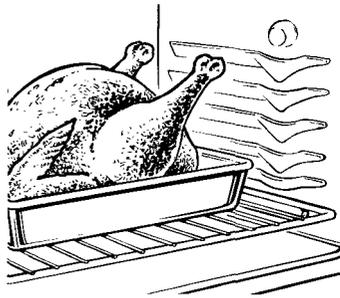

Roasting is really a baking procedure used for meats. Therefore the oven controls are set for Baking or Timed Baking. (You may hear a slight clicking sound indicating the oven is working properly.) Timed Baking will turn the oven on and off automatically.

Most meats continue to cook slightly while standing after being removed from the oven. Recommended standing time for roasts is 10 to 20 minutes. This allows roasts to firm up and makes them easier to carve. The internal temperature will rise about 5° to 10°F. If you wish to compensate for the temperature rise, remove the roast from the oven when its internal temperature is 5° to 10°F. less than the temperature shown in the Roasting Guide.

Remember that food will continue to cook in the hot oven and therefore should be removed when the desired internal temperature has been reached.

1. Position the oven at shelf (B) position for small size roast (3 to 5 lbs.) and at (R) position for larger roasts.

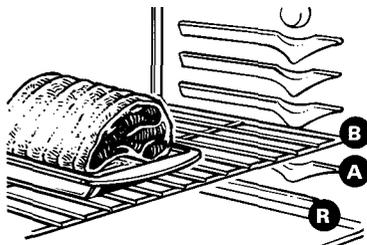

3. Turn the OVEN SET knob to BAKE and the OVEN TEMP knob to the desired temperature. See the Roasting Guide for temperatures and approximate cooking times.
4. When roasting is finished, turn the OVEN TEMP knob to OFF and then remove the food from the oven.

2. Check the weight of the roast. Place the meat fat-side-up or the poultry breast-side-up on the roasting rack in a shallow pan. The melting fat will baste the meat. Select a pan as close to the size of meat as possible. (The broiler pan with rack is a good pan for this.)

Dual Shelf Cooking

This allows more than one food to be cooked at the same time. For example: While roasting a 20-lb. turkey on shelf position R, a second shelf (if so equipped) may be added on position D so that scalloped potatoes can be cooked at the same time. Calculate the total cooking time to enable both dishes to complete cooking at the same time. Allow 15-20 minutes of additional cooking time for the potatoes.

Use of Aluminum Foil

You can use aluminum foil to line the broiler pan. This makes clean-up easier when using the pan for marinating, cooking with fruits, cooking heavily cured meats or basting food during cooking. Press the foil tightly around the inside of the pan.



(continued next page)



ROASTING

(continued)

Questions and Answers

Q. Is it necessary to check for doneness with a meat thermometer?

A. Checking the finished internal temperature at the completion of cooking time is recommended. Temperatures are shown in Roasting Guide. For roasts over 8 lbs., check with thermometer at half-hour intervals after half the time has passed.

Q. Why is my roast crumbling when I try to carve it?

A. Roasts are easier to slice if allowed to cool 10 to 20 minutes after removing from oven. Be sure to cut across the grain of the meat.

Q. Do I need to preheat my oven each time I cook a roast or poultry?

A. It is not necessary to preheat your oven.

Q. When buying a roast, are there any special tips that would help me cook it more evenly?

A. Yes. Buy a roast as even in thickness as possible, or buy rolled roasts.

Q. Can I seal the sides of my foil "tent" when roasting a turkey?

A. Sealing the foil will steam the meat. Leaving it unsealed allows the air to circulate and brown the meat.

ROASTING GUIDE

Frozen Roasts

Frozen roasts of beef, pork, lamb, etc., can be started without thawing, but allow 15 to 25 minutes per pound additional time (15 minutes per pound for roasts under 5 pounds, more time for larger roasts.)

Make sure poultry is thawed before roasting. Unthawed poultry often does not cook evenly. Some commercial frozen poultry can be cooked successfully without thawing. Follow directions given on package label.

Type	Oven Temperature	Doneness	Approximate Roasting Time in Minutes per Pound		Internal temperature °F.
Meat			3 to 5 lbs.	6 to 8 lbs.	
Tender cuts; rib, high quality sirloin tip, rump or top round*	325°	Rare: Medium: Well Done:	24-35 35-39 39-45	18-25 25-31 31-33	140°-150°† 150°-1600 170°-1850
Lamb leg or bone-in shoulder*	325°	Rare: Medium: Well Done:	21-25 25-30 30-35	20-23 24-28 28-33	140°-150°† 150°-1600 170°-1850
Veal shoulder, leg or loin*	325°	Well Done:	35-45	30-40	170°-1800
Pork loin, rib or shoulder*	325°	Well Done:	35-45	30-40	170°-1800
Ham, precooked	325°	To Warm:	18-23 minutes per pound (any weight.)		115°-1250
Poultry			3 to 5 lbs.	Over 5 lbs.	
Chicken or Duck	325°	Well Done:	35-40	30-35	185°-1900
Chicken pieces	350°	Well Done:	35-40		185°-1900
Turkey	325°	Well Done:	10 to 15 lbs. 16-22	Over 15 lbs 12-19	In thigh: 185°-1900

*For boneless rolled roasts over 6 inches thick, add 5 to 10 minutes per pound to times given above,

†The U.S. Department of Agriculture says "Rare beef is popular, but you should know that cooking it to only 140°F means some food poisoning organisms may survive." (Source: Safe Food Book. Your Kitchen Guide. USDA Rev. June 1985.)

BROILING



Do not lock the oven door with the latch during broiling. The latch is used for self-cleaning only.

Broiling is cooking food by direct heat from above the food. Most fish and tender cuts of meat can be broiled. Follow these directions to keep spattering and smoking to a minimum.

The oven door should be closed during broiling.

Turn the food only once during cooking. Time the foods for the first side according to the Broiling Guide.

Turn the food, then use the times given for the second side as a guide to the preferred doneness.

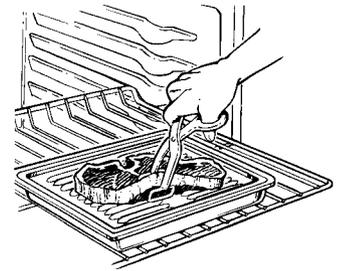

1. If the meat has fat or gristle around the edge, cut vertical slashes through both about 2" apart. If desired, the fat may be trimmed, leaving a layer about 1/8" thick.
2. Place the meat on the broiler rack in the broiler pan which comes with the range. Always use the rack so fat drips into the broiler pan; otherwise the juices may become hot enough to catch fire.
3. Position the shelf on the recommended shelf position as suggested in Broiling Guide.
4. Close the oven door but do not latch it. **If the door latch is moved to the right during a broil operation the door may lock** and you may not be able to open it until the oven cools.
5. Turn the OVEN SET knob and the OVEN TEMP knob to BROIL.
6. When broiling is finished, turn OVEN TEMP knob to OFF. Remove the broiler pan from the range and serve food immediately. Leave the pan outside the range to cool.

Use of Aluminum Foil

You can use aluminum foil to line your broiler pan and broiler rack. However, you must mold the foil tightly to the rack and cut slits in it just like the rack.

Without the slits, the foil will prevent fat and meat juices from draining to the broiler pan. The juices could become hot enough to catch on fire. If you do not cut the slits, you are frying, not broiling.

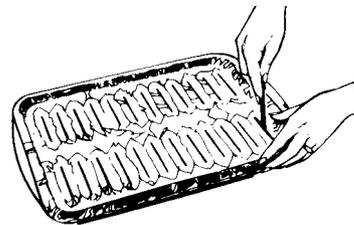

Questions and Answers

Q. When broiling, is it necessary to always use a rack in the pan?

A. Yes. Using the rack suspends the meat over the pan. As the meat cooks, the juices fall into the pan, thus keeping meat drier. Juices are protected by the rack and stay cooler, thus preventing excessive spatter and smoking.

Q. Should I salt the meat before broiling?

A. No. Salt draws out the juices and allows them to evaporate. Always salt after cooking. Turn the meat with tongs; piercing the meat with a fork also allows juices to escape. When broiling poultry or fish, brush each side often with butter.

Q. Why are my meats not turning out as brown as they should?

A. Check to see if you are using the recommended shelf position. Broil for the longest period of time indicated in the Broiling Guide. Turn the food only once during broiling.

(continued next page)



BROILING GUIDE

The oven door must be closed during broiling.

- Always use the broiler pan and rack that comes with your range. It is designed to minimize smoking and spattering by trapping juices in the shielded lower part of the pan.
- For steaks and chops, slash the fat evenly around the outside edges of the meat. To slash, cut crosswise through the outer fat surface just to the edge of the meat. Use tongs to turn the meat over to prevent piercing the meat and losing the juices.

- If desired, marinate meats or chicken before broiling. Or brush with barbecue sauce last 5 to 10 minutes only.
- When arranging food on the pan, do not let fatty edges hang over the sides because dripping fat could soil the oven.
- The broiler compartment does not need to be preheated. However, for very thin foods, or to increase browning, preheat if desired.
- Frozen steaks can be broiled by positioning the shelf at next lowest shelf position and increasing cooking time given in this guide 1 ½ times per side.

Food	Quantity and/or Thickness	Shelf Position	1st Side Minutes	2nd Side Minutes	Comments
Bacon	1/2 lb. (about 8 thin slices)	c	3½	3	Arrange in single layer.
Ground Beef	1 lb. (4 patties) 1/2 to 3/4 inch thick	C	10-11	4-5	Space evenly. Up to 8 patties take about same time.
Beef Steaks	1 inch thick (1 to 1½ lbs.)	B	9	7	Steaks less than 1 inch thick cook through before browning. Pan frying is recommended.
Rare		B	12	5-6	
Medium		B	13	8-9	
Well Done	1 inch thick (2 to 2½ lbs.)	B	10	6-7	Slash fat.
Rare		B	12-15	10-12	
Medium		B	25	16-18	
Well Done					
Chicken	1 whole (2 to 2½ lbs.), split lengthwise	B	30-35	25-30	Reduce times about 5 to 10 minutes per side for cut-up chicken. Brush each side with melted butter. Broil skin-side-down first.
Bakery Products	2 to 4 slices 1 pkg. (2) 2, split	C	2-3	1/2-1	Space evenly. Place English muffins cut-side-up and brush with butter if desired.
Bread (Toast) or Toaster Pastries		C	3-5		
English Muffins					
Lobster Tails	2 to 4 (6 to 8 oz. each)	C	13-16	Do not turn over.	Cut through back of shell and spread open. Brush with melted butter before broiling and after half of time.
Fish	1-lb. fillets 1/4 to 1/2 inch thick	B	5	5	Handle and turn very carefully. Brush with lemon butter before broiling and during broiling if desired. Preheat broiler to increase browning.
Ham Slices Precooked	1 inch thick	C	8	8	Increase time 5 to 10 minutes per side for 1 ½ inch thick or home cured.
Pork Chops Well Done	2 (1/2 inch thick) 2 (1 inch thick), about 1 lb.	B	10	4-5	Slash fat.
		B	13	9-12	
Lamb Chops	2 (1 inch thick), about 10 to 12 oz. 2 (1½ inch thick), about 1 lb.	B	8	4-7	Slash fat.
Medium		B	10	10	
Well Done		B	10	4-6	
Medium		B	17	12-14	
Well Done					
Wieners similar precooked sausages, bratwurs	1-lb. pkg. (10)	C	6	1-2	If desired, split sausages in half lengthwise; cut into 5-to 6-inch pieces.

OPERATING THE SELF-CLEANING OVEN

Normal Cleaning Time: 3 hours



Before a Clean Cycle

We recommend venting with an open window or using a ventilation fan or hood during the first self-clean cycle.

1. Remove the broiler pan, broiler rack, all cookware and any aluminum foil from the oven—they cannot withstand the high cleaning temperatures.

NOTE: The oven shelves may be cleaned in the self-cleaning oven. However, they will darken, lose their luster and become hard to slide.

2. Wipe up heavy soil on the oven bottom. If you use soap, rinse thoroughly before self-cleaning to prevent staining.

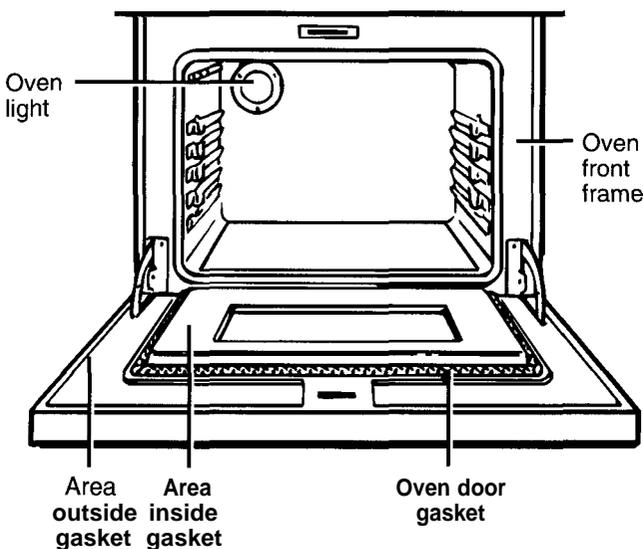

3. Clean spatters or spills on the oven front frame, and the oven door outside the gasket with a dampened cloth. The oven front frame and the oven door outside the gasket do not get cleaned by the self-clean cycle. On these areas use detergent and hot water or a soap-filled steel wool pad. Rinse well with a vinegar and water solution. This will help prevent a brown residue from forming when the oven is heated. Buff these areas with a dry cloth. Do not clean the gasket.

Clean the top, sides and outside front of the oven door with soap and water. Do not use abrasives or oven cleaners.

Make sure the oven light bulb cover is in place.

Do not rub or clean the door **gasket**—the fiberglass material of the gasket has an extremely low resistance to abrasion. An intact and well-fitting oven door gasket is essential for energy-efficient oven operation and good baking results. If you notice the gasket becoming worn, frayed or damaged in any way or if it has become displaced on the door, you should have it replaced.

4. Close the door and make sure the oven light is off. If the oven light is not turned off, the life of the bulb will be shortened or it may burn out immediately.

CAUTION: The grates and drip pans (on some models) should never be cleaned in the self-cleaning oven.

Do not use commercial oven cleaners or oven protectors in or near the self-cleaning oven. A combination of any of these products plus the high clean cycle temperatures may damage the porcelain finish of the oven.

(continued next page)



OPERATING THE SELF-CLEANING OVEN

(continued)

How to Set the Oven for Cleaning

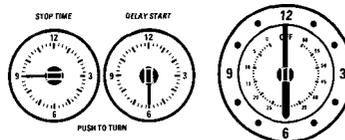
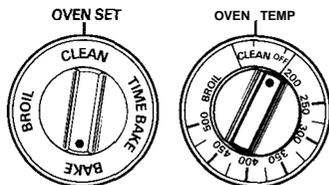

1. Turn the OVEN SET knob to CLEAN. Push in and turn the OVEN TEMP knob to CLEAN. The controls will snap into the final position when the CLEAN location is reached.
2. Slide the latch handle to the right as far as it will go.
Never force the door latch handle. Forcing the handle may damage the door lock mechanism.
3. Set the automatic oven timers.

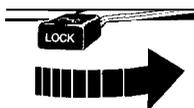

Make sure the range clock is set to the correct time of day. Clear the DELAY START and STOP TIME dials of any previous timed cooking or cleaning function by: one at a time, push the DELAY START and STOP TIME dials in and turn the dials. Using a light touch, continue turning the dial until it "pops" out. Both dials should now be in the out position.

Decide on the cleaning hours necessary.

Light to Moderate Soil—2-3 hours (thin spills and light spatters).

Heavy Soil—4 hours (heavy, greasy spills and spatters).

Add these hours to the present time of day, then push in and turn the STOP TIME dial clockwise to this later stop time.

The oven door gets hot during self-cleaning. **DO NOT TOUCH.**

The CLEANING light will glow, indicating the controls have been set correctly and the clean cycle has begun. If a delayed start has been selected, the CLEANING light will not glow until the start time has been reached and the clean cycle begins. The door will lock approximately 20 minutes after the clean cycle has begun.

4. When the clean cycle is complete, you will be able to slide the door latch handle to the left as far as it will go and open the door.

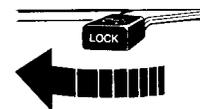

Never force the door latch handle. If you cannot slide the latch easily to unlock the door, allow additional time for cooling.

Turn the OVEN TEMP knob to OFF.

After a Clean Cycle

After a clean cycle, you may notice some white ash in the oven. Just wipe it up with a damp cloth.

If white spots remain, remove them with a soap-filled steel wool pad. Be sure to rinse thoroughly with a vinegar and water mixture. These deposits are usually a salt residue that cannot be removed by the clean cycle.

If the oven is not clean after one cycle, the cycle may be repeated.

If the shelves have become hard to slide, wipe the shelf supports with cooking oil.

NOTE: You cannot set the oven for cooking until the oven is cool enough for the door to be unlatched.



How to Delay Start of Cleaning

If you wish to start and stop cleaning at a later time than shown on the clock, push in and turn the DELAY START dial to the time you wish to start. Add the hours needed for cleaning to this “start” time, then push in and turn the STOP TIME dial to this later stop time. The oven will automatically turn on and off at the set times.

To Stop a Clean Cycle (all models)

Turn the OVEN TEMP knob to the OFF position. This will stop the cleaning cycle but you will not be able to open the door until the oven cools below the locking temperature.

Questions and Answers

Q. Why won't my oven clean immediately even though I set all the time and clean dials correctly?

A. Check to be sure your DELAY START dial is set to the same time as the range clock. Also check to be sure the latch handle is moved to the right.

Q. If my range clock is not set to the correct time of day, can I still self-clean my oven?

A. No. Your Automatic Oven Timer uses the range clock to help start and stop your self-cleaning cycle.

Q. Can I use commercial oven cleaners on any part of my self-cleaning oven?

A. No cleaners or coatings should be used around any part of this oven. If you do use them and do not thoroughly rinse the oven with water, wiping it absolutely clean afterward, the residue can scar the oven surface and damage metal parts the next time the oven is automatically cleaned.

Q. Can I clean the woven gasket around the oven door?

A. No, this gasket is essential for a good oven seal, and care must be taken not to rub, damage or move this gasket.

Q. What should I do if excessive smoking occurs during cleaning?

A. This is caused by excessive soil, and you should turn the OVEN TEMP knob to OFF. Open the windows to rid the room of smoke. Allow the oven to cool for at least one hour before opening the door. Wipe up the excess soil and reset the clean cycle.

Q. Is the “crackling” or “popping” sound I hear during cleaning normal?

A. Yes. This is the metal heating and cooling during both the cooking and cleaning functions.

Q. Should there be any odor during the cleaning?

A. Yes, there will be a slight odor during the first few cleanings. Failure to wipe out excessive soil might also cause an odor when cleaning.

Q. What causes the hair-like lines on the enamel surface of my oven?

A. This is a normal condition resulting from heating and cooling during cleaning. They do not affect how your oven performs.

Q. Why do I have ash left in my oven after cleaning?

A. Some types of soil will leave a deposit, which is ash. It can be removed with a damp sponge or cloth.

Q. My oven shelves do not slide easily. What is the matter?

A. After many cleanings, the oven shelves will lose their luster and become hard to slide. To make the shelves slide more easily, wipe the shelf supports with cooking oil.

Q. My oven shelves have become gray after the self-cleaning cycle. Is this normal?

A. Yes. After the self-cleaning cycle, the shelves will have lost some luster and discolor to a deep gray.

Q. Can I cook food on the cooktop while the oven is self-cleaning?

A. Yes. While the oven is self-cleaning, you can use the cooktop just as you normally do. However, be careful when standing in front of the range—oven becomes very hot while self-cleaning.



CARE AND CLEANING

Proper care and cleaning are important so your range will give you efficient and satisfactory service. Follow these directions carefully in caring for it to help assure safe and proper maintenance.

BE SURE ELECTRICAL POWER IS DISCONNECTED BEFORE CLEANING ANY PART OF YOUR RANGE.

CAUTION: DO NOT OPERATE THE BURNER WITHOUT ALL BURNER PARTS AND DRIP PANS (IF SO EQUIPPED) IN PLACE.

Sealed Burner Assemblies (on some models)

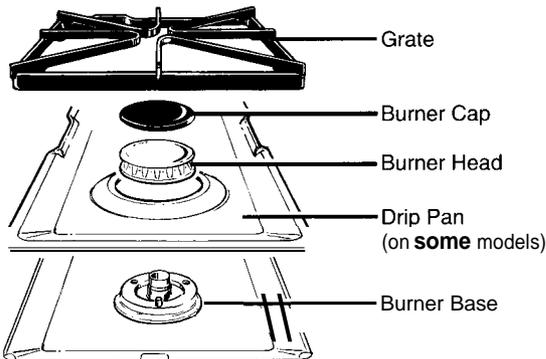

The electrode of the spark igniter is exposed. When one burner is turned to LITE, all the burners spark. Do not attempt to disassemble or clean around any burner while another burner is on. An electric shock may result, which could cause you to knock over hot cookware.

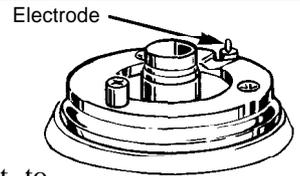

Turn all controls OFF before removing burner parts and drip pans (if so equipped).

The burner grates, caps, burner heads and drip pans (if so equipped) can be lifted off, making them easy to clean.

Burner Caps (on sealed burners only)

Lift off when cool. Wash burner caps in hot, soapy water and rinse with clean water. If desired, soak up to **30** minutes and scour with a plastic scouring pad to remove burned-on food particles. Dry them in a warm oven or with a cloth—don't reassemble them wet.



Burner Base (on sealed burners only)

The burner base (the part of the burner fastened to the cooktop) be cleaned with a soft brush and a mild cleanser. Clean all food residues from around spark electrode. Do not use steel wool; small bits of steel wool will short out the electrode. Rinse well.

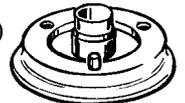



Burner Heads (on sealed burners only)

The holes in the burners of your range, and the spark electrodes, must be kept clean at all times for proper ignition and an even, unhampered flame.

You should clean the burner heads routinely, especially after bad spillovers, which could clog these holes. Wipe off the burner heads. If heavy spillover occurs, remove the burner heads from the range.

Remove the burner grate and burner cap. Then lift the burner head straight up.

To get rid of burned-on food, soak the burner head upside-down in a solution of mild liquid detergent and hot water. Soak the burner head for 20 to 30 minutes. If the food doesn't rinse off completely, scrub it with soap and water and a soft brush or plastic scouring pad.

For more stubborn stains, use a cleanser like Soft Scrub® brand or Bon Ami® brand. Rinse well to remove any traces of the cleanser that might clog the burner openings. Do not use steel wool because it will clog the burner openings and scratch the burners. If the holes become clogged, clean them with a sewing needle or twist tie.

Before putting the burner head back, shake out excess water and dry it thoroughly by setting it in a warm oven for 30 minutes. Then place it back in the range, making sure the pin in the burner base goes in the hole in the burner head, and that the burner heads are properly seated and level.

CAUTION: DO NOT OPERATE THE BURNER WITHOUT ALL BURNER PARTS AND DRIP PANS (IF SO EQUIPPED) IN PLACE.

Standard Twin Burners (on some models)

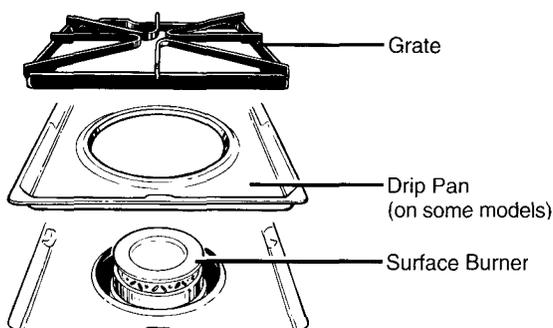

On models with standard twin burners, the cooktop lifts up for easy access.

Turn all controls OFF before removing burner parts and drip pans (if so equipped).

The burner grates, caps, burner heads and drip pans (if so equipped) can be lifted off, making them easy to clean.

The holes in the surface burners of your range must be kept clean at all times for proper ignition and an even, unhampered flame.

You should clean the surface burners routinely, especially after bad spillovers, which could clog these holes. Wipe off surface burners. If heavy spillover occurs, remove the surface burners from the range. Burners lift out for cleaning. Lift up the cooktop and then lift out the surface burners.

To remove burned-on food, soak the surface burner in a solution of mild liquid detergent and hot water. Soak the surface burner for 20 to 30 minutes. For more stubborn stains, use a cleanser like Soft Scrub® brand or Bon Ami® brand. Rinse well to remove any traces of the cleanser that might clog the surface burner openings. Do not use steel wool because it will clog the surface burner openings and scratch the surface burners. If the holes become clogged, clean them with a sewing needle or twist tie.

Before putting the surface burner back, shake out excess water and then dry it thoroughly by setting it in a warm oven for 30 minutes. Then place it back in the range, making sure it is properly seated and level.

Drip Pans (on some models)

Remove the grates and lift out the drip pans.

Drip pans can be cleaned in dishwasher or by hand,

To get rid of burned-on food, place them in a covered container (or plastic bag) with 1/4 cup ammonia to loosen the soil. Then scrub with a soap-filled scouring pad if necessary.

CAUTION:
Do not clean the drip pans in the self-cleaning oven.

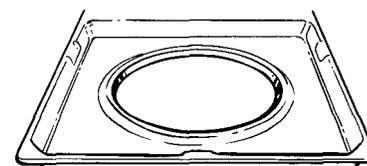

(continued next page)



CARE AND CLEANING

(continued)

Burner Grates

Lift out when cool. Grates should be washed regularly and, of course, after spillovers. Wash them in hot, soapy water and rinse with clean water. After cleaning, dry them thoroughly by putting them in a warm oven for a few minutes. Don't put the grates back on the range while they are wet. When replacing the grates, be sure they're positioned securely over the burners.

To prevent rusting on cast iron grates, apply a light coating of cooking oil on the bottom of the grates.

To get rid of burned-on food, place the grates in a covered container (or plastic bag) with 1/4 cup ammonia to loosen the soil. Then scrub with a soap-filled scouring pad if necessary.

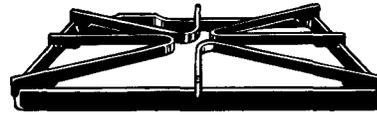

Although they're durable, the grates will gradually lose their shine, regardless of the best care you can give them. This is due to their continual exposure to high temperatures.

Do not operate a burner for an extended period of time without cookware on the grate. The finish on the grate may chip without cookware to absorb the heat.

CAUTION: Do not clean the grates in the self-cleaning oven.

Cooktop Surface

To avoid damaging the porcelain enamel surface of the cooktop and to prevent it from becoming dull, clean up spills right away. Foods with a lot of acid (tomatoes, sauerkraut, fruit juices, etc.) or foods with high sugar content could cause a dull spot if allowed to set.

When the surface has cooled, wash and rinse. For other spills such as fat smatterings, etc., wash with soap and water once the surface has cooled. Then rinse and polish with a dry cloth.

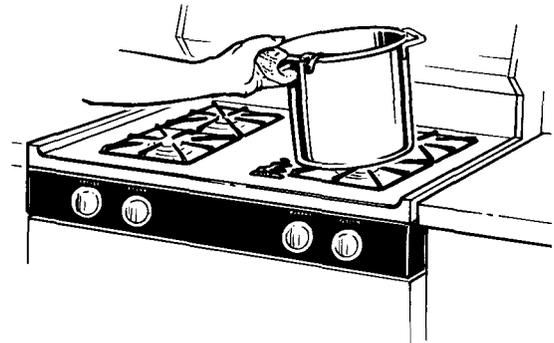

Do not store flammable materials in an oven or near the cooktop. Do not store or use combustible materials, gasoline or other flammable vapors and liquids in the vicinity of this or any other appliance.

Oven Bottom

The oven bottom has a porcelain enamel finish.

To make cleaning easier, protect the oven bottom from excessive spillovers by placing a cookie sheet on the shelf below the shelf you are cooking on. You can use aluminum foil if you do not cover the whole shelf. This is particularly important when baking a fruit pie or other foods with a high acid content. Hot fruit fillings or other foods that are highly acidic (such as milk, tomatoes or sauerkraut, and sauces with vinegar or lemon juice) may cause pitting and damage to the porcelain enamel surface and should be wiped up immediately.

To clean up spillovers, use soap and water, an abrasive cleaner or scouring pad. Rinse well to remove any soap before self-cleaning.

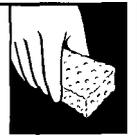

Lift-Off Oven Door

The oven door is removable, but it is heavy. You may need help removing and replacing the door.

To remove the door, open it a few inches to the special stop position that will hold the door open. Grasp firmly on each side and lift the door straight up and off the hinges.

NOTE: Be careful not to place hands between the hinge and the oven door frame as the hinge could snap back and pinch fingers.



To replace the door, make sure the hinges are in the special stop position. Position the slots in the bottom of the door squarely over the hinges. Then lower the door slowly and evenly over both hinges at the same time. If the hinges snap back against the oven frame, pull them back out.

TO CLEAN THE DOOR:

(Do not immerse the door in water.)

Inside of the door:

- Because the area inside the gasket is cleaned during the self clean cycle, you do not need to clean this by hand. Any soap left on the liner causes additional stains when the oven is heated.
- The area outside the gasket can be cleaned with a scouring pad.

- **Do not rub or clean the door gasket**—the fiberglass material of the gasket has an extremely low resistance to abrasion. An intact and well-fitting oven door gasket is essential for energy-efficient oven operation and good baking results. If you notice the gasket becoming worn, frayed or damaged in any way or if it has become displaced on the door, you should have it replaced.

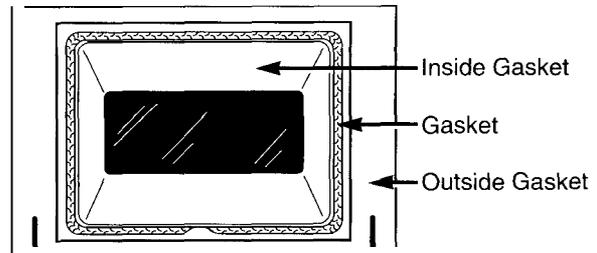

Outside of the door:

- Use soap and water to thoroughly clean the top, sides and front of the oven door. Rinse well. You may also use a glass cleaner to clean the glass on the outside of the door.
- Spillage of marinades, fruit juices, tomato sauces and basting materials containing acids may cause discoloration and should be wiped up immediately. When the surface is cool, clean and rinse.
- **Do not use oven cleaners, cleansing powders or harsh abrasives on the outside of the door.**

Broiler Pan and Rack

After broiling, remove the broiler pan from the oven. Remove the rack from the pan. Carefully pour out grease from the pan into a proper container. Wash and rinse the broiler pan and rack in hot water with a soap-filled or plastic scouring pad.

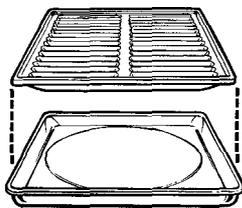

If food has burned on, sprinkle the rack with detergent while hot and cover with wet paper towels or a dishcloth. Soaking the pan will remove burned on foods.

Both the broiler pan and rack can also be cleaned in the dishwasher.

Do not store a soiled broiler pan and rack anywhere in the range.

Do not clean the broiler pan or rack in the self-cleaning oven.

Oven Shelves

Clean the shelves with an abrasive cleanser or steel wool. After cleaning, rinse the shelves with clean water and dry with a clean cloth.



NOTE: The oven shelves may be cleaned in the self-cleaning oven. However, they will darken, lose their luster and become hard to slide. Wipe the shelf supports with cooking oil after self-cleaning to make shelves slide more easily.

(continued next page)



CARE AND CLEANING

(continued)

Oven Light Replacement (on some models)

CAUTION: Before replacing your oven light bulb, disconnect the electrical power to the range at the main fuse or circuit breaker panel. Be sure to let the light cover and bulb cool completely.

The oven light bulb is covered with a removable glass cover that is held in place with a bail-shaped wire. Remove the oven door, if desired, to reach cover easily.

To remove:

1. Hold a hand under the cover so it doesn't fall when released. With fingers of the same hand, firmly push back the wire cover holder. Lift off the cover.

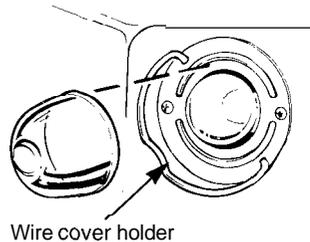

DO NOT REMOVE ANY SCREWS TO REMOVE COVER.

2. Do not touch hot bulb with a wet cloth. Replace bulb with a 40-watt household appliance bulb.

To replace cover:

1. Place it into the groove of the light receptacle. Pull the wire forward to the center of the cover until it snaps into place. When in place, the wire holds the cover firmly. Be certain the wire is in the depression in the center of the cover.
2. Connect electrical power to the range.

Control Panel and Knobs

It's a good idea to wipe the control panel after each use of the oven. Clean with mild soap and water or vinegar and water, rinse with clean water and polish dry with a soft cloth.

Do not use abrasive cleansers, strong liquid cleaners, plastic scouring pads or oven cleaners on the control panel—they will damage the finish. A 50/50 solution of vinegar and hot water works well.

The control knobs may be removed for easier cleaning.

To remove a knob, pull it straight off the stem. If knob is difficult to remove, place a towel or dishcloth between the knob and control panel and pull gently. Wash the knobs in soap and water or a vinegar and hot water solution but do not soak.

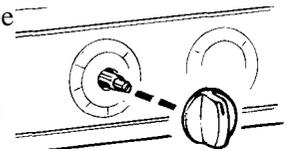

Metal parts can be cleaned with soap and water. Do not use steel wool, abrasives, ammonia, acids or commercial oven cleaners. Dry with a soft cloth.

Removable Storage Drawer (on some models)

The storage drawer is a good place to store cookware and bakeware. Do not store plastics and flammable material in the drawer.

Do not overload the storage drawer. If the drawer is too heavy, it may slip off the track when opened.

The storage drawer may be removed for cleaning under the range. Clean the storage drawer with a damp cloth or sponge. Never use harsh abrasives or scouring pads.

To remove storage drawer:

1. Pull drawer straight out until it stops.
2. Tilt the front of the drawer up and free of the range.

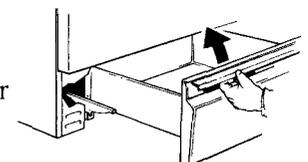

To replace storage drawer:

1. Set the stops on the back of the drawer over the stops in the range.
2. Slide drawer evenly and straight back, so that the rails in the range are engaged.



Oven Air Vents

Never block the vents (air openings) of the range. They provide the air inlet and outlet that are necessary for the range to operate properly with correct combustion. Air openings are located at the rear of the cooktop, at the top and bottom of the oven door, and at the bottom of the range, under the kick panel, storage drawer or broiler drawer (depending on the model).

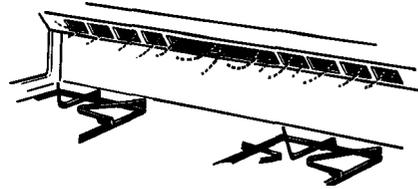

Vent appearance and location vary

Lift-up Cooktop (on models with standard twin burners)

Clean the area under the cooktop often. Built-up soil, especially grease, may catch on fire.

To make cleaning easier, the cooktop may be lifted up.

To raise the cooktop:

1. Be sure the burners are turned off.
2. Remove the grates.
3. Grasp the two front burner wells and lift up.

Some models have dual support rods that will hold the cooktop up while you clean underneath it.

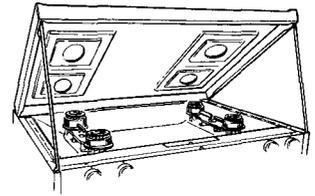

After cleaning under the cooktop with hot, soapy water and a clean cloth, lower the cooktop. Be careful not to pinch your fingers.

Removable Kick Panel (on some models)

The kick panel may be removed for cleaning under the range.

To remove, lift up the bottom of the panel slightly to disengage the panel from the tabs at base of the range. Pull the bottom of the panel forward until the spring clips are released at the top of the panel.

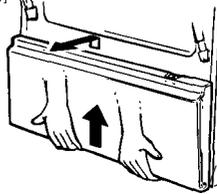

To replace, insert the two slots at the bottom of the panel onto the two tabs at the base of the range and push the top of the panel forward to engage the spring clips.

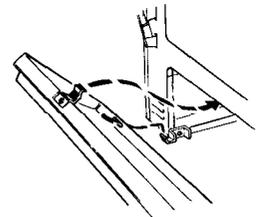

Removable Broiler Drawer (on some models)

To remove:

1. When the broiler is cool, remove the rack and pan.
2. Pull the broiler drawer out until it stops, then push it back in about one inch.
3. Grasp the handle, lift and pull the broiler drawer out. Clean the broiler drawer with hot soapy water.

To replace:

Hold the broiler drawer in the raised position as you slide it partway into the range. Then lower the drawer and push it completely closed.

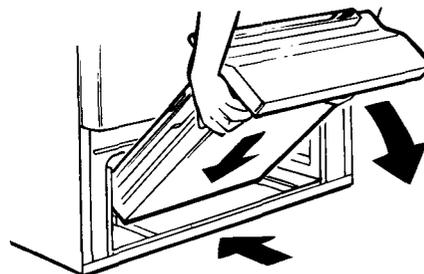



INSTALLATION INSTRUCTIONS

FOR YOUR SAFETY

If you smell gas:

1. Open windows.
2. Don't touch electrical switches.
3. Extinguish any open flame.
4. Immediately call your gas supplier.

FOR YOUR SAFETY

Do not store or use combustible materials, gasoline or other flammable vapors and liquids in the vicinity of this or any other appliance.

BEFORE YOU BEGIN

Read these instructions completely and carefully.

IMPORTANT: Save these instructions for the local electrical inspector's use.

INSTALLER: Leave these instructions with the appliance after installation is completed.

CONSUMER: Keep this Use and Care Guide and the Initiation Instructions for future use.

This appliance must be properly grounded.

WARNING

Improper installation, adjustment, alteration, service or maintenance can cause injury or property damage. Refer to this guide. For assistance or additional information, consult a qualified installer, service agency, manufacturer (dealer) or the gas supplier.

CAUTION

Do not attempt to operate the oven of this range during a power failure (Electric Ignition models only).

IMPORTANT

Remove all packing material and literature from oven before connecting gas and electrical supply to range.

DIMENSIONS AND CLEARANCES

Provide adequate clearances between the range and adjacent combustible surfaces.

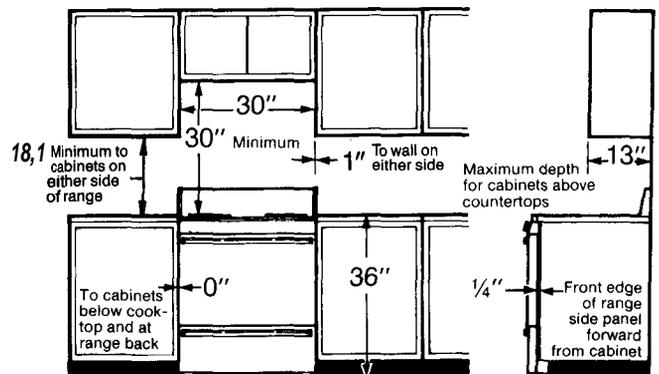
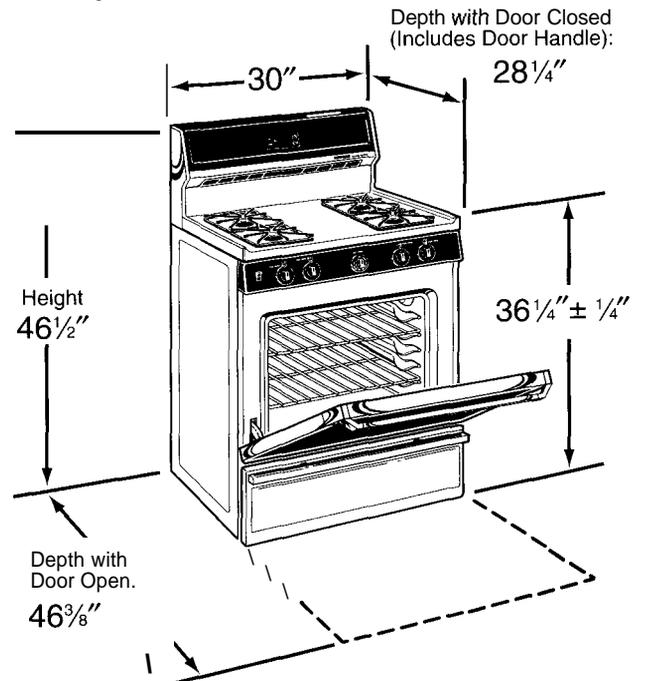



IMPORTANT SAFETY INSTRUCTIONS

Installation of this range must conform with local codes, or in the absence of local codes, with the National Fuel Gas Code, ANSI 2223.1, latest edition. In Canada, initiation must conform with the current Natural Gas Instigation Code, CAN/CGA-B149.1 or the current Propane Initiation Code, CAN/CGA-B149.2, and with local codes where applicable.

This range has been design-certified by the American Gas Association according to ANSI 221.1, latest edition and Canadian Gas Association according to CAN/CGA-1.1 latest edition. As with any appliance using gas and generating heat, there are certain safety precautions you should follow. You will find these precautions in the Important Safety Instructions in the front of this guide. Read them carefully.

- Have your range installed by a qualified installer or service technician.
- Your range must be electrically grounded in accordance with local codes or, in the absence of local codes, in accordance with the National Electrical Code (ANSI/NFPA 70, latest edition). In Canada, electrical grounding must be in accordance with the current CSA C22.1 Canadian Electrical Code Part 1 and/or local codes. See Electrical Connections in this section.
- Before installing your range on linoleum or any other synthetic floor covering, make sure the floor covering can withstand 180°F. without shrinking, warping or discoloring. Do not install the range over carpeting unless a sheet of 1/4" thick plywood or similar insulator is placed between the range and carpeting.

• Make sure the wall coverings around the range can withstand heat generated by the range up to 200°F.

• Avoid placing cabinets above the range. To reduce the hazard caused by reaching over the open flames of operating burners, install a ventilation hood over the range that projects forward at least 5" beyond the front of the cabinets.

• The ventilating hood must be constructed of sheet metal not less than 0.0122" thick. Install above the cooktop with a clearance of not less than 1/4" between the hood and the underside of the combustible material or metal cabinet. The hood must be at least as wide as the appliance and centered over the appliance. Clearance between the cooking surface and the ventilation hood surface **MUST NEVER BE LESS THAN 24 INCHES.**

EXCEPTION: Installation of a listed microwave oven or cooking appliance over the cooktop shall conform to the installation instructions packed with that appliance.

- If cabinets are placed above the range, allow a minimum clearance of 30" between the cooking surface and the bottom of unprotected cabinets.
- If a 30" clearance between cooking surface and overhead combustible material or metal cabinets cannot be maintained, protect the underside of the cabinets above the cooktop with not less than 1/4" insulating millboard covered with sheet metal not less than 0.0122" thick.
- Clearance between the cooking surface and protected cabinets **MUST NEVER BE LESS THAN 24 INCHES.** The vertical distance from the plane of the cooking surface to the bottom of adjacent overhead cabinets extending closer than 1" to the plane of the range sides must not be less than 18". (See Dimensions and Clearances illustration in this section.)
- **CAUTION:** Items of interest to children should not be stored in cabinets above a range or on the backsplash of a range—children climbing on the range to reach items could be seriously injured.



WARNING

All ranges can tip and injury could result. To prevent accidental tipping of the range, attach an approved Anti-Tip device to the wall. (See Installing the Anti-Tip Device in this section.) To check if the device is installed and engaged properly, carefully tip the range forward. The

Anti-Tip device should engage and prevent the range from tipping over.

If you pull the range out from the wall for any reason, make sure the Anti-Tip device is engaged when you push the range back against the wall.

• For your safety, never use your range for warming or heating the room. Your oven and cooktop are not designed to heat your kitchen. Top burners should not be operated without cookware on the grate. Such abuse could result in fire and damage to your range and will void your warranty.

• Do not store or use combustible materials, gasoline or other flammable vapors and liquids in the vicinity of this or any other appliance. Explosions or fires could result.

• Do not use oven for a storage area. Items stored in the oven can ignite.

• Do not let cooking grease or other flammable materials accumulate in or near the range.

(continued next page)



INSTALLATION INSTRUCTIONS

(continued)

GENERAL

• See Dimensions and Clearances in this section for all rough-in and spacing dimensions. These dimensions must be met for safe use of your range. The location of the electrical outlet and pipe opening (see Gas Pipe and Electric Outlet Locations) may be adjusted to meet specific requirements.

• The range may be placed with 0" clearance (flush) at the back wall and sidewalls of the range.

LOCATION

Do not locate the range where it may be subject to strong drafts. Any openings in the floor or wall behind the range should be sealed. Make sure the openings around the base of the range that supply fresh air for combustion and ventilation are not obstructed by carpeting or woodwork.

PROTECT YOUR FLOOR

Your range, like many other household items, is heavy and can settle into soft floor coverings such as cushioned vinyl or carpeting. Use care when moving the range on this type of flooring. It is recommended that the following simple and inexpensive instructions be followed to protect your floor.

The range should be installed on a sheet of plywood (or similar material). *When the floor covering ends at the front of the range*, the area that the range will rest on should be built up with plywood to the same level or higher than the floor covering. This will allow the range to be moved for cleaning or servicing.

MODEL AND SERIAL NUMBER LOCATION

Depending on your range, you'll find the model and serial numbers on a label on the front frame of the range, behind the storage drawer, kick panel or broiler drawer.

TOOLS YOU WILL NEED

- Phillips and flat-blade screwdrivers
- Pencil and ruler
- Two pipe wrenches (one for backup)
- 1% open-end or adjustable wrench
- Nut drivers or wrenches: 3/16" and 1/4"

ADDITIONAL MATERIALS YOU MAY NEED

- Gas line shut-off valve
- Pipe joint sealant or UL-approved pipe thread tape with Teflon* that resists action of natural and LP gases
- Flexible metal appliance connector (1/2" I. D.) A 5-foot length is recommended for ease of installation but other lengths are acceptable. Never use an old connector when installing a new range.
- Flare union adapter for connection to gas supply line (3/4" or 1/2" NPT x 1/2" I. D.)
- Flare union adapter for connection to pressure regulator on range (1/2" NPT x 1/2" I. D.)

*Teflon: Registered trademark of DuPont

PREPARATION

- Remove all tape and packaging. Lift up the cooktop (on models with standard twin burners) and remove any packing material under it. Make sure the standard twin burners are properly seated and level.
- Remove plastic film that covers some chrome parts (around oven door, side trim).
- Take the accessory pack out of the oven.
- Check to be sure that no range parts have come loose during shipping.

PROVIDE ADEQUATE GAS SUPPLY

Your range is designed to operate at a pressure of 4" of water column on natural gas or, if designed for LP gas (propane or butane), 10" of water column. Make sure you are supplying your range with the type of gas for which it is designed. This range is convertible for use on natural or propane gas, if you decide to use this range on a different type of gas, conversion adjustments must be made by a service technician or other qualified person before attempting to operate the range on that gas.

For proper operation, the pressure of natural gas supplied to the regulator must be between 4" and 13" of water column. For LP gas, the pressure supplied must be between 10" and 13" of water column. When checking for proper operation of the regulator, the inlet pressure must be at least 1" greater than the operating (manifold) pressure as given above. The pressure regulator located at the inlet of the range manifold must remain in the supply line regardless of whether natural or LP gas is being used. A flexible metal appliance connector used to connect the range to the gas supply line should have an I.D. of 1/2" and be 5 feet in length for ease of installation. In Canada, flexible connectors must be single wall metal connectors no longer than 6 feet in length.

Connect THE RANGE TO GAS

Shut off the main gas supply valve before disconnecting the old range and leave it off until new hook-up has been completed. Don't forget to relight the pilot on other gas appliances when you turn the gas back on.

Because hard piping restricts movement of the range, the use of an A. G.A.-certified flexible metal appliance connector is recommended unless local codes require a hard-piped connection. Never use an old connector when installing a new range. If the hard piping method is used, you must carefully align the pipe; the range cannot be moved after the connection is made.

To prevent gas leaks, put pipe joint compound on, or wrap pipe thread tape with Teflon* around, all male (external) pipe threads.

*Teflon: Registered trademark of DuPont

Gas Pipe and Electric Outlet Locations for Models Equipped with Sealed Burners

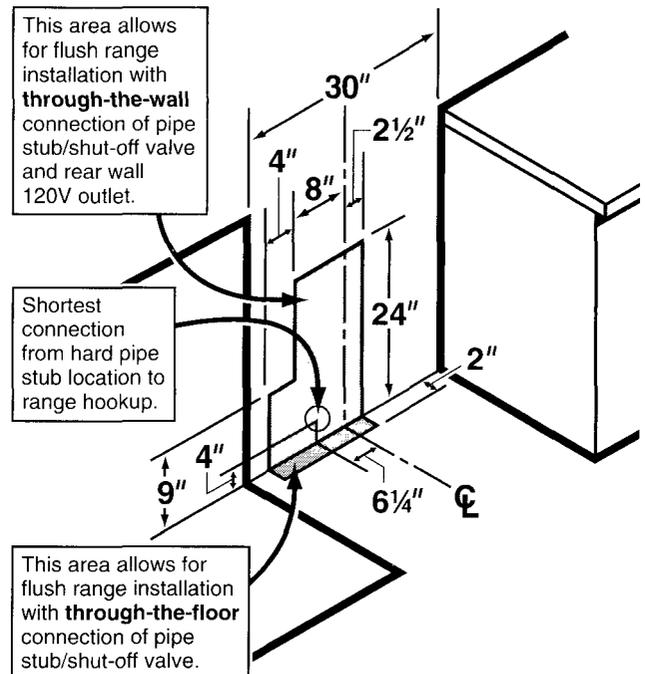

Gas Pipe and Electric Outlet Locations for Models Equipped with Standard Twin Burners

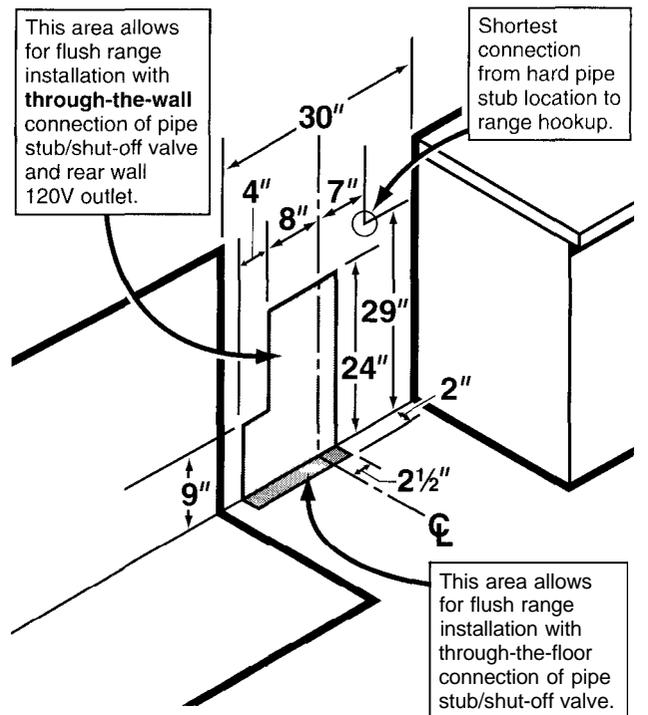

(continued next page)



INSTALLATION INSTRUCTIONS

(continued)

CONNECT THE RANGE TO GAS (continued)

Flexible Connector Hookup for Models Equipped with Sealed Burners

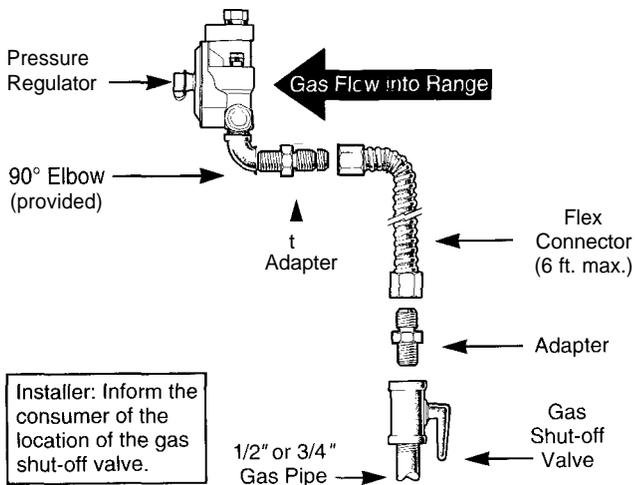

Installer: Inform the consumer of the location of the gas shut-off valve.

Flexible Connector and Rigid Pipe Hookups for Models Equipped with Standard Twin Burners

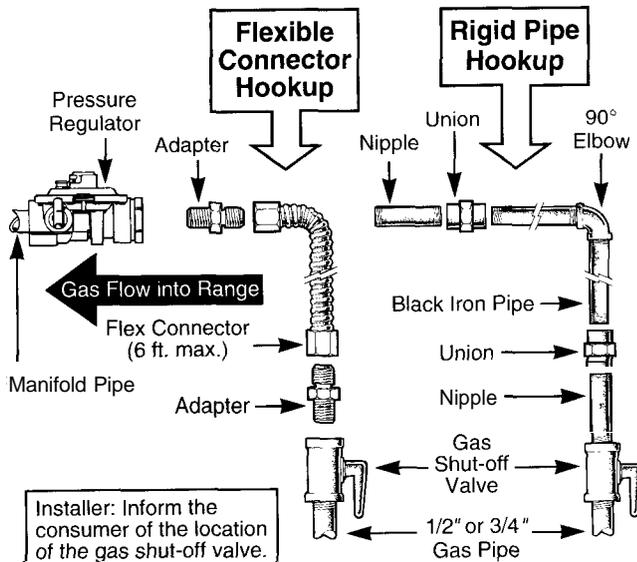

Rigid Pipe Hookup for Models Equipped with Sealed Burners

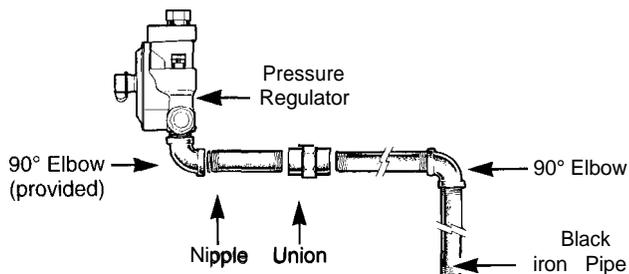

*cc-l:



CONNECT THE RANGE TO GAS (continued)

1. Install a manual gas line shut-off valve in the gas line in an easily accessed location outside of the range. Make sure everyone operating the range knows where and how to shut off the gas supply to the range.

2. Install male 1/2" flare union adapter to the 1/2" NPT internal thread elbow at inlet of regulator. **On models equipped with standard twin burners**, install the male pipe thread end of the 1/2" flare union adapter to the 1/2" NPT internal thread at inlet of pressure regulator. Use a backup wrench on the regulator fitting to avoid damage.

When installing the range from the front, remove the 90° elbow for easier installation.

3. Install male 1/2" or 3/4" flare union adapter to the NPT internal thread of the manual shut-off valve, taking care to back-up the shut-off valve to keep it from turning.

4. Connect flexible metal appliance connector to the adapter on the range. Position range to permit connection at the shut-off valve.

5. When all connections have been made, make sure all range controls are in the off position and turn on the main gas supply valve. Use a liquid leak detector at all joints and connections to check for leaks in the system.

CAUTION: DO NOT USE A FLAME TO CHECK FOR GAS LEAKS.

When using test pressures greater than 1/2 psig to pressure test the gas supply system of the residence, disconnect the range and individual shut-off valve from the gas supply piping. When using test pressures of 1/2 psig or less to test the gas supply system, simply isolate the range from the gas supply system by closing the individual shut-off valve.

ELECTRICAL CONNECTIONS (on some models)

Electrical Requirements

120-volt, 60 Hertz, properly grounded branch circuit protected by a 15-amp or 20-amp circuit breaker or time delay fuse.

Extension Cord Cautions

Because of potential safety hazards associated with certain conditions, we strongly recommend against the use of an extension cord. However, if you still elect to use an extension cord, it is absolutely necessary that it be a UL-listed, 3-wire grounding-type appliance extension cord and that the current carrying rating of the cord in amperes be equivalent to, or greater than, the branch circuit rating.

Grounding

IMPORTANT—(Please read carefully)

FOR PERSONAL SAFETY, THIS APPLIANCE MUST BE PROPERLY GROUNDED.

The power cord of this appliance is equipped with a three-prong (grounding) plug which mates with a standard three-prong grounding

PREFERRED METHOD

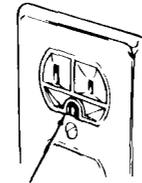

Ensure proper ground exists before use

wall receptacle to minimize the possibility of electric shock hazard from this appliance. The customer should have the wall receptacle and circuit checked by a

qualified electrician to make sure the receptacle is properly grounded.

Where a standard two-prong wall receptacle is encountered, it is the personal responsibility and obligation of the customer to have it replaced with a properly grounded three-prong wall receptacle.

DO NOT, UNDER ANY CIRCUMSTANCES, CUT OR REMOVE THE THIRD (GROUND) PRONG FROM THE POWER CORD.

(continued next page)



INSTALLATION INSTRUCTIONS

(continued)

ELECTRICAL CONNECTIONS (continued)

Usage Satiations where Appliance Power Cord will be Disconnected **Infrequently**.

An adapter maybe used only on a 15-amp circuit. Do not use an adapter on a 20-amp circuit. Where local codes permit, a **TEMPORARY CONNECTION** maybe made to a properly grounded two-prong wall receptacle by the use of a UL-listed adapter, available at most hardware stores. The larger slot in the adapter must be aligned with the larger slot in the wall receptacle to provide proper polarity in the connection of the power cord.

TEMPORARY METHOD

(Adapter plugs not permitted in Canada)

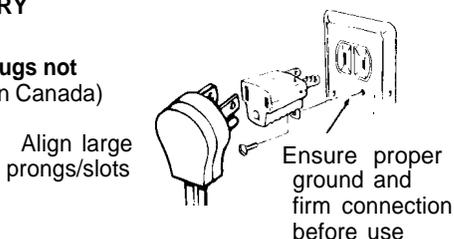

CAUTION: Attaching the adapter ground terminal to the wall receptacle cover screw does not ground the appliance unless the cover screw is metal, and not insulated, and the wall receptacle is grounded through the house wiring. The customer should have the circuit checked by a qualified electrician to make sure the receptacle is properly grounded.

When disconnecting the power cord from the adapter, always hold the adapter with one hand. If this is not done, the adapter ground terminal is very likely to break with repeated use. Should this happen, **DO NOT USE** the appliance until a proper ground has again been established,

Usage Satiation. where Appliance Power Cord will be Disconnected **Frequently**.

Do not use an adapter plug in these situations because disconnecting of the power cord places undue strain on the adapter and leads to eventual failure of the adapter ground terminal. The customer should have the two-prong wall receptacle replaced with a three-prong (grounding) receptacle by a qualified electrician before using the appliance.

The installation of appliances designed for mobile home installation must conform with the Manufactured Home Construction and Safety Standard, Title 24 CFR, Part 3280 (formerly the Federal Standard for Mobile Home Construction and Safety, Title 24, HUD, Part 280) or, when such standard is not applicable, the Standard for Manufactured Home Installations, latest edition (Manufactured Home Sites, Communities and Set-Ups), ANSI A225.1, latest edition, or with local codes. In Canada, mobile home installation must be in accordance with the current CAN/CSA Z240/MH Mobile Home Installation Code.

Electric Disconnect

1. Locate disconnect plug on the range back.
2. Pinch sides of connector and pull out of range back.

You will have this disconnect plug.

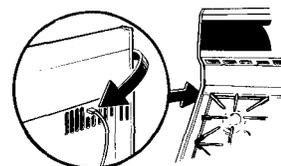



SEAL THE OPENINGS

Seal any openings in the wall behind the range and in the floor under the range when hookups are completed.

5 CHECK IGNITION OF SURFACE BURNERS

Surface Burner Ignition

Operation of all cooktop and oven burners should be checked after the range and gas supply lines have been carefully checked for leaks.

Electric Ignition Models

Select a top burner knob and simultaneously push in and turn to LITE position. You will hear a snapping sound indicating proper operation of the spark module. Once the air has been purged from the supply lines, burners should light within 4 seconds. After burner lights, rotate knob out of the LITE position. Try each burner in succession until all burners have been checked.

Quality of Flames

The combustion quality of burner flames needs to be determined visually.

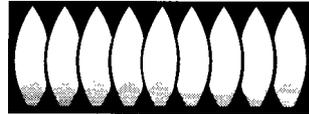

(A) Yellow flames—
Call for service

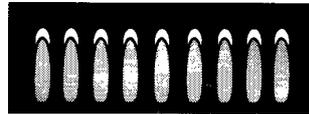

(B) Yellow tips on outer cones—
Normal for LP gas



(C) Soft blue flames—
Normal for natural gas

If burner flames look like (A), call for service. Normal burner flames should look like (B) or (C), depending on the type of gas you use. With LP gas, some yellow tipping on outer cones is normal.

6 CHECK IGNITION OF OVEN BURNER

Your oven is designed to operate quietly and automatically. To operate the oven, turn the OVEN SET knob to BAKE and the OVEN TEMP knob to a setting above 300° F. After 30-90 seconds, the oven burner will ignite and burn until the set temperature is reached. The oven burner will continue to cycle on and off as necessary to maintain the oven at the temperature indicated by the OVEN TEMP knob.

To check ignition of the broil burner, turn the OVEN SET knob to BROIL and the OVEN TEMP knob to BROIL. After 30-90 seconds, the broil burner will ignite.

Electric ignition models require electrical power to operate. In case of a power outage, the oven burners on these models cannot be lit manually with a match. Gas will not flow unless the glow bar is hot.

If the oven is in use when a power outage occurs, the burner will shut off and cannot be re-lit until power is restored.

(continued next page)

INSTALLATION INSTRUCTIONS

(continued)

ADJUST BROIL AND OVEN BURNER AIR ADJUSTMENT SHUTTERS IF NECESSARY

Air adjustment shutters for the top and bottom burners regulate the flow of air to the flames.

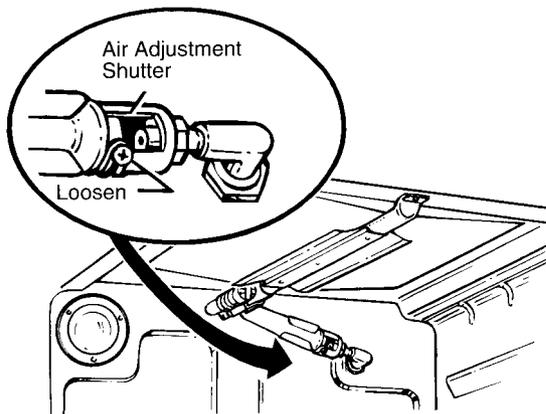

The air adjustment shutter for the top (broil) burner is in the center of the rear wall of the oven.

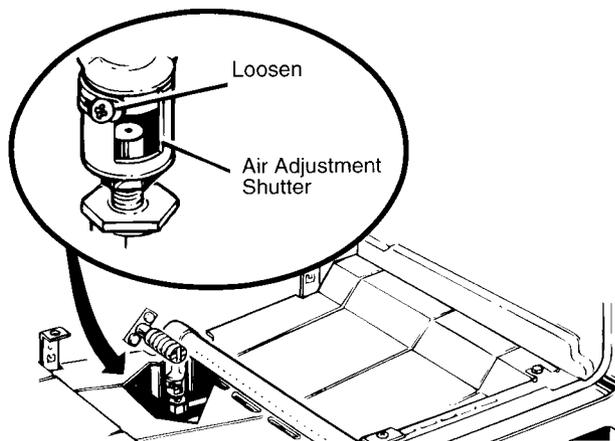

The shutter for the bottom (oven) burner is near the back wall behind the storage drawer or the kick panel (depending on the model). Remove the drawer or panel. See the Care and Cleaning section in this guide.

To adjust the flow of air to either burner, loosen the Phillips head screw and rotate the shutter toward open or closed position as needed.

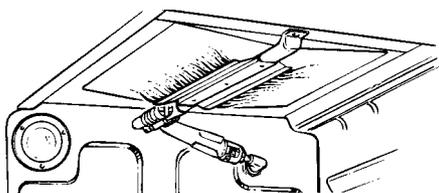

The flames for the top (broil) burner should be steady with approximately 1" blue cones and should not extend out over the edges of the burner baffle.

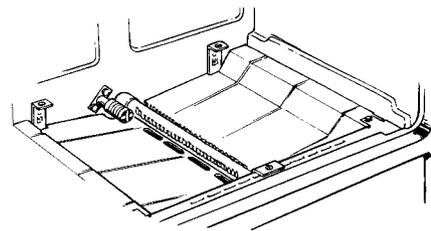

To determine if the bottom burner flames are burning properly, remove the oven bottom and the burner baffle [on some models (see below)]. Flames should have approximately 1" blue cones and, if range is supplied with natural gas, should burn with no yellow tipping. (With most LP gas, small yellow tips at the end of outer cones are normal.) Flames should not lift off burner ports. If lifting is observed, gradually reduce air shutter opening until flames are stabilized. With the baffle in place, the flames should burn steady and should not extend past the edges of the burner baffle.

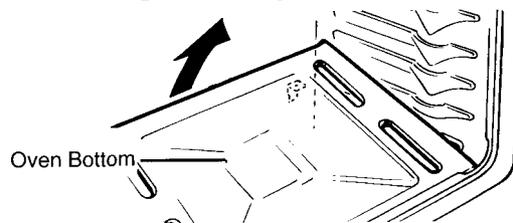

To remove the oven bottom:

1. Remove the knurled screws holding down rear of the oven bottom.
2. Grasp the oven bottom at finger slots on each side.
3. Lift the rear of the oven bottom enough to clear the lip of the range frame, then pull out.

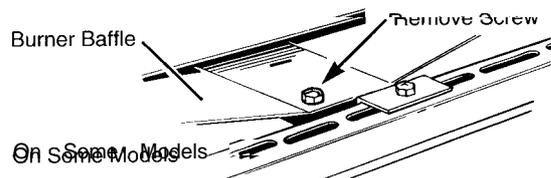

To remove the burner baffle (on some models):

1. Use a nut driver to remove the 1/4" hex-head screw shown in the illustration above. Do not remove any other screws.
2. Pull baffle straight out until it is free from the slot that holds it at rear of oven.

8 LEVELING THE RANGE

1. Remove the storage drawer, broiler drawer or kick panel.
2. Use a 3/16" open-end or socket wrench to back out both rear leveling legs approximately two turns.
3. Use a 1" open-end or adjustable wrench to back out the front leveling legs two turns.
4. Install the oven shelves in the oven and position the range where it will be installed.
5. Check for levelness by placing a spirit level or a cup, partially filled with water, on one of the oven racks. If using a spirit level, take two readings—with the level placed diagonally first in one direction and then the other.
6. Adjust the leveling legs until the range is level.
7. After the range is level, slide the range away from the wall so that the Anti-Tip device can be installed.

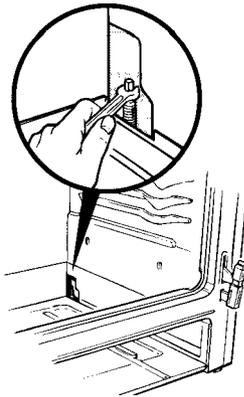

INSTALLING THE ANTI-TIP DEVICE

WARNING:

- Range must be secured with an approved Anti-Tip device.
- Unless properly installed, the range could be tipped by you or a child standing, sitting or leaning on an open door.
- After installing the Anti-Tip device, verify that it is in place by carefully attempting to tilt the range forward.
- This range has been designed to meet all recognized industry tip standards for all normal conditions.
- The use of this device does not preclude tipping of the range when not properly installed.
- If the Anti-Tip device supplied with the range does not fit this application, use the universal Anti-Tip device WB02X7909.

1. Mark the wall where the RIGHT EDGE of the range is to be located. Be sure to allow for the countertop overhang if you intend to install the range next to cabinets.

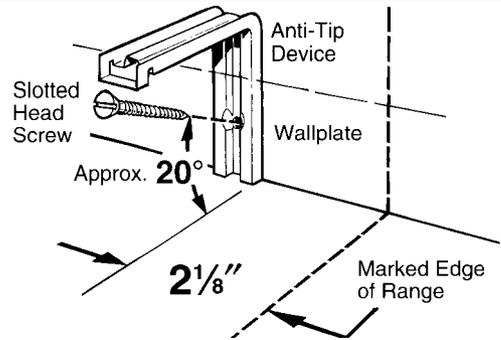

2. Locate the outside edge of the device 2" toward the center of the range from the marked edge of the range.
3. Using the device as a template, mark the position of the hole for the screw.

4. For wood construction, drill a pilot hole at an angle of 20 degrees from the horizontal. A nail or awl may be used if a drill is not available.

Mount the Anti-Tip device with the screw provided.

For cement or concrete construction, you will need a 1/4" x 1 1/2" lag bolt and a 1/2" O.D. sleeve anchor, which are not provided. Drill the recommended size hole for the hardware.

Install the sleeve anchor into the drilled hole and then install the lag bolt through the device. The bolts must be properly tightened as recommended for the hardware.

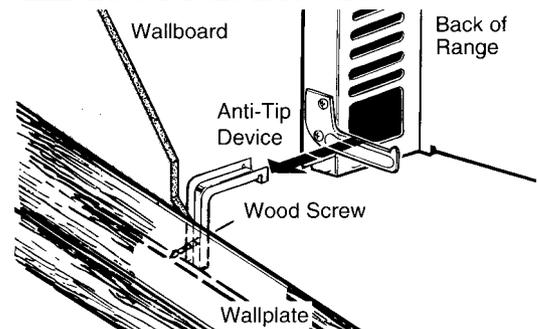

5. Slide the range against the wall, and check for proper installation by grasping the front edges of the rear surface unit openings and carefully attempting to tilt the range forward.

WHEN ALL HOOKUPS ARE COMPLETED:

MAKE SURE ALL CONTROLS ARE LEFT IN THE OFF POSITION.

MAKE SURE THE FLOW OF COMBUSTION AND VENTILATION AIR TO THE RANGE IS UNOBSTRUCTED.



CONVERTING TO LP GAS

or Converting Back to Natural Gas from LP

HOW TO CONVERT THE RANGE FOR USE WITH LP GAS OR NATURAL GAS

This range leaves the factory set for use with natural gas. If you convert to LP gas, keep these instructions and orifices in case you want to convert back to natural gas.

TOOLS REQUIRED:

- T-10 Torxdriver (for sealed burners)
- 1/2" and 3/4" open-end wrench
- Flat blade screwdriver (small)
- Nut drivers or wrenches: 7mm, 5/16" or a small adjustable (depending on the size of the spuds)

PREPARE RANGE FOR CONVERSION

- (1) Turn off gas supply at the wall.
- (2) Turn off the electrical power to the range.

If range has not yet been connected to gas supply, or if flexible connection was made, range maybe pulled out from the wall to make conversion easier.

CONVERT THE PRESSURE REGULATOR

WARNING: Do not remove the pressure regulator from the range.

1. For models equipped with sealed burners, remove the storage drawer, broiler drawer or kick panel and locate the pressure regulator at rear of the range.

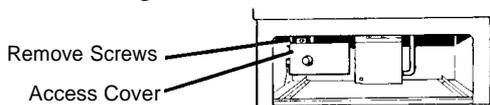

On some models, you may have to remove an access cover also.

For models equipped with standard twin burners, remove the cooktop and locate the pressure regulator at right rear of range.

2. Follow the directions in **A** or **B** that match your regulator type.

Standard Twin Burner Models (models with lift-up cooktop)

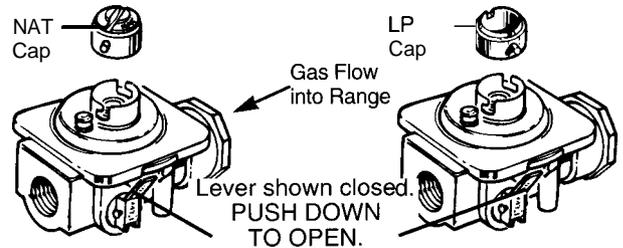

If it is this regulator:

1. Use a coin to remove the cap from the pressure regulator.
2. Turn the cap over and hook it into the slots. The type of gas to be used should now be visible on the top of the cap.

Sealed Burner Models (models without lift-up cooktop)

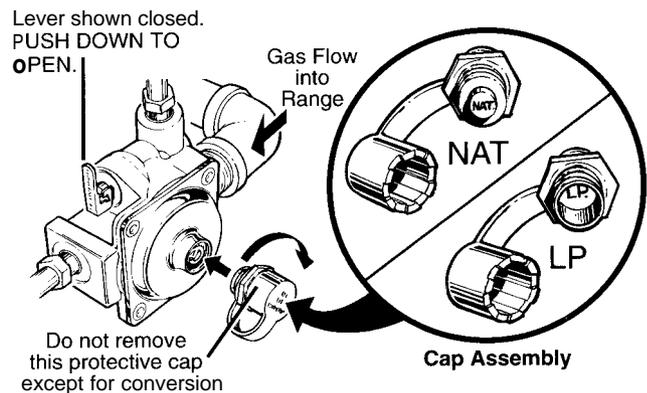

If it is this regulator:

1. Unscrew the plastic-protected hex-nut cap from the regulator.
2. Carefully pry the protective plastic cap off the threaded metal cap. Gently pull the plastic washer off the threads on the other side of the metal cap.
3. Push the plastic cap onto the end of the metal cap displaying the type of gas you are converting to. Press the attached plastic washer onto the threads on the other side of the metal cap.
4. Screw the hex-nut cap back into the regulator. Do not overtighten.



3 CONVERTING SURFACE BURNERS ON MODELS EQUIPPED WITH SEALED BURNERS
(See Step 4 if range is equipped with standard twin burners.)

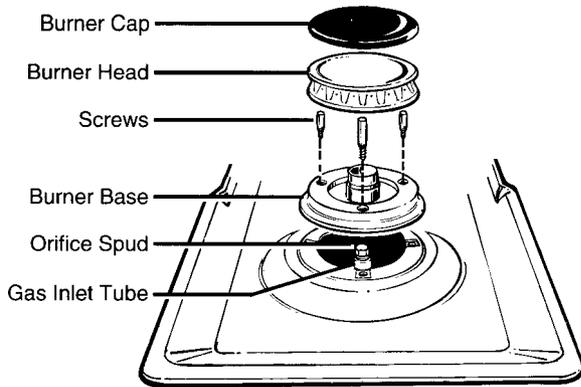

1. Remove grates, burner caps and burner heads.
2. Using a torxdriver, remove the burner bases by unscrewing the 3 small screws in each base. **Lift** the burner straight out.

DO NOT disconnect the wires from the burner bases unless the cooktop needs to be raised.

3. Remove the brass orifice spud under each burner base by unscrewing spud from fitting with a 7 mm or a small adjustable wrench (depending on the size of your spuds). Apply a 3/4" wrench to the hex on the gas inlet tube as a back-up when removing spud to prevent the aluminum **from** twisting.

4. Install orifice spuds according to one of the following diagrams (see  or ) , for LP gas or natural gas, depending on which you are converting to.

 **Orifice Spuds for Converting to LP Gas:**

LP orifice spuds are in a small plastic bag packed with this Use and Care Guide. LP orifice spuds have a 2-digit number and the letter "L" on one side. Each orifice spud will also have 1 or 2 grooves on one side, denoting the location on the range where it is to be installed as shown below.

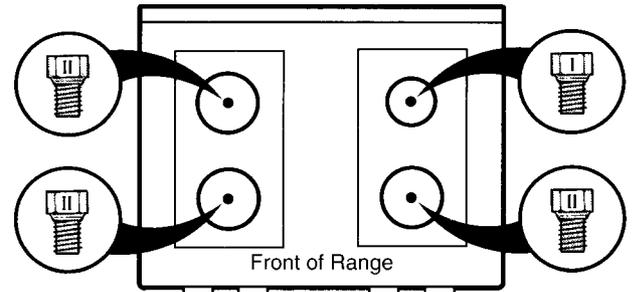

 **Orifice Spuds for Converting to Natural Gas:**

Natural gas orifice spuds have a 3-digit number on one side. Each orifice spud will also have 1, 2 or 3 grooves on one side, with the letter "N" underneath denoting the location on the range where it is to be installed as shown below.

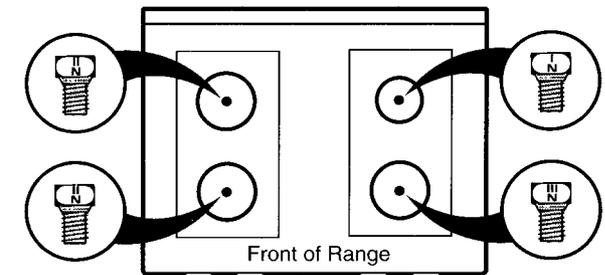

(continued next page)



CONVERTING TO LP GAS

(continued)

HOW TO CONVERT THE RANGE FOR USE WITH LP GAS OR NATURAL GAS (continued)

5. To prevent leakage, make sure the orifice spuds are securely screwed into the gas inlet tubes. Use a small wrench to hold the inlet tube hex to prevent it from twisting.

6. Put old orifice spuds back in the bag to save for possible future conversion.

NOTE: If an orifice spud is accidentally dropped, the cooktop can be raised by

the 2 front clips with a large flat blade screwdriver.

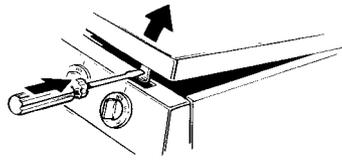

DO NOT attempt to raise the cooktop without removing all 4 burner bases.

If wires were disconnected to remove the cooktop, feed wires through the burner holes in the cooktop. Attach to each burner electrode terminal carefully, making sure not to bend the terminal. Then lower cooktop until it snaps over the clips.

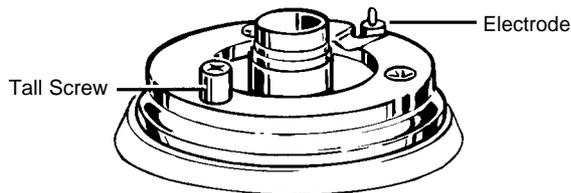

7. Carefully insert burner bases straight down with the tube over the orifice spud. Replace the screws, **making sure the tall screw is opposite the burner electrode in each burner base.**

CONVERTING SURFACE BURNERSON

MODELS EQUIPPED WITH STANDARD TWIN BURNERS (See Step 3 if range is equipped with sealed burners.)

1. Lift cooktop.

2. Lift burner assemblies straight up and set aside to gain access to surface burner spuds.

3. With a 5/16" or a small adjustable wrench, remove each of the four

spuds on the surface burner gas inlet tubes and replace them with the correct gas spuds mounted in a holder at the right rear of the range, above the regulator. Natural gas spuds are brass and LP gas spuds are red or silver. (Mount the spuds that you removed from the inlet tubes back in the holder.) To prevent leakage, make sure spuds are securely screwed into gas inlet tubes.

4. Replace the burner assemblies.

5. Keep all spuds with your range so you have them if you move or get a different gas hook-up.

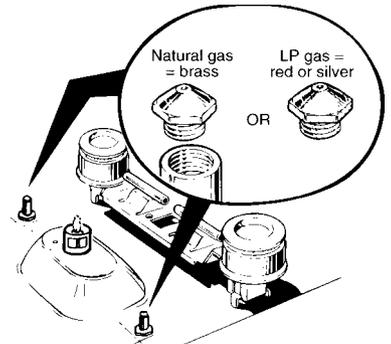

Top Burner	Orifice Drill Size	Color
Natural Gas	#54 (.0550 Dia.)	Brass
LP (Propane)	#66 (.0330 Dia.)	Red or Silver



CONVERT THE OVEN BURNER ORIFICES

Oven Burner

1. Remove oven door, storage drawer or broiler drawer, oven bottom and burner baffle (on some models). The lower burner orifice spud is located behind the storage drawer, broiler drawer or kick panel. (On some models, a metal shield must be removed to access the orifice.)

2. To convert to **LP** gas, use a 1/2" wrench to turn the lower burner orifice spud clockwise. Tighten the spud only until it is snug. To prevent damage, do not overtighten the spud.

To convert to **natural** gas, loosen the spud about 2 turns.

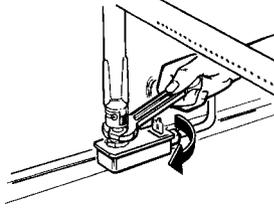

Broil Burner (on some models)

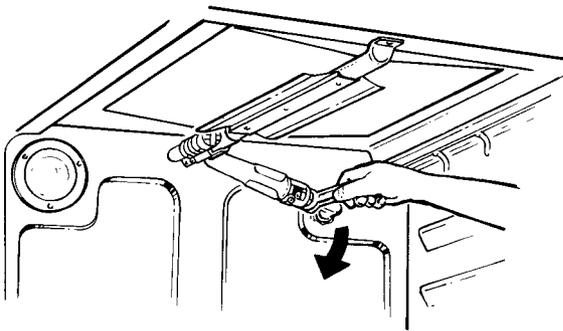

To convert to **LP** gas, use a 1/2" wrench to turn the upper burner orifice spud clockwise. Tighten spud only until it is snug with the base. To prevent damage, do not overtighten spud.

To convert to **natural** gas, loosen the spud about 2 turns.

CONVERT AIR ADJUSTMENT SHUTTER

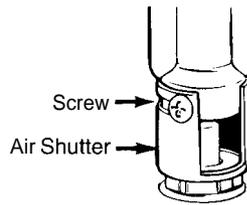

For **LP** gas, loosen the Phillips head screw and rotate the shutter to the full open position. With baffle in place, flames should have approximately 1-inch blue cones and should not extend beyond

the edges of the burner baffle. After 30 seconds of burner operation, check for flames lifting off burner ports. If lifting is observed, gradually reduce air shutter opening until flames are stabilized.

For **natural** gas, the shutter should be open 1/2" or about 3/4 of the way open.

CHECK FOR LEAKS

When all connections have been made, make sure all range controls are in the off position and turn on the main gas supply valve. Use a liquid leak detector at all joints and connections to check for leaks in the system.

CAUTION: DO NOT USE A FLAME TO CHECK FOR GAS LEAKS.

When using test pressures greater than 1/2 psig to pressure test the gas supply system of the residence, disconnect the range and individual shut-off valve from the gas supply piping. When using test pressures of 1/2 psig or less to test the gas supply system, simply isolate the range from the gas supply system by closing the individual shut-off valve.

(continued next page)



CONVERTING TO LP GAS

(continued)

HOW TO CONVERT THE RANGE FOR USE WITH LP GAS OR NATURAL GAS (continued)

□ CONVERT TOP BURNER VALVES

1. Turn all of the top burners to LOW.
2. Remove all four knobs.
3. With a small flat blade screwdriver, turn the valve set screws clockwise to decrease the flame size, counterclockwise to increase the flame size. Adjust until the flame is about the same height as the top of the burner.
4. Replace the knobs.
5. Check for flame outage by opening and closing the oven door several times. If the flame goes out, increase the flame size.

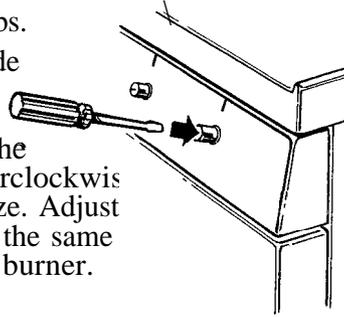

□ CHECK QUALITY OF FLAMES

The combustion quality of burner flames needs to be determined visually.



(A) Yellow flames—
Call for service

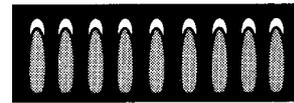

(B) Yellow tips on outer cones—
Normal for LP gas

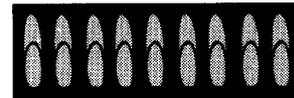

(C) Soft blue flames—
Normal for natural gas

If burner flames look like (A), call for service. Normal burner flames should look like (B) or (C), depending on the type of gas you use.

With LP gas, some yellow tipping on outer cones is normal.

QUESTIONS? USE THIS PROBLEM SOLVER

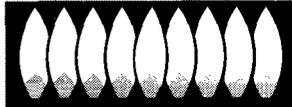
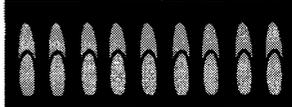
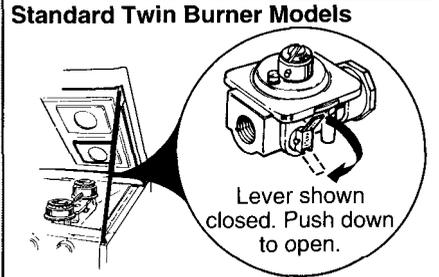
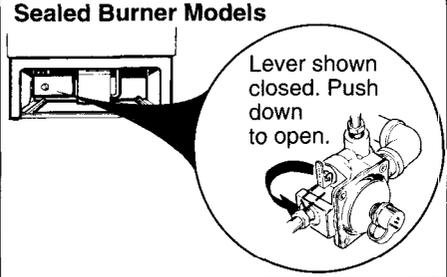

PROBLEM	POSSIBLE CAUSE
OVEN WILL NOT WORK	<ul style="list-style-type: none"> • Plug on range is not completely inserted in the electrical outlet. • The circuit breaker in your house has been tripped, or a fuse has been blown. • Oven controls not properly set. • Door left in locked position after cleaning.
TOP BURNERS DO NOT LIGHT OR DO NOT BURN EVENLY	<ul style="list-style-type: none"> • Make sure electrical plug is plugged into a live power outlet. • Burner holes on the side or around the top of burner may be clogged. Remove burners (on models with standard twin burners) or burner heads (on models with sealed burners) or burner caps on spill-proof models, and clean them with a sewing needle or twist tie. Make sure you do not enlarge the holes. On spill-proof models, check electrode area for burned-on food or grease.
BURNERS HAVE YELLOW OR YELLOW-TIPPED FLAMES	<div style="display: flex; justify-content: space-around; align-items: center;"> <div style="text-align: center;">  <p>(A) Yellow flames— Call for service</p> </div> <div style="text-align: center;">  <p>(B) Yellow tips on outer cones—Normal for LP gas</p> </div> <div style="text-align: center;">  <p>(C) Soft blue flames—Normal for natural gas</p> </div> </div> <ul style="list-style-type: none"> • If burner flames look like (A), call for service. Normal burner flames should look like (B) or (C), depending on the type of gas you use. • With LP gas, some yellow tipping on outer cones is normal.
BURNER FLAMES VERY LARGE OR YELLOW	<ul style="list-style-type: none"> • If range is connected to LP gas, check all steps in the Installation Instructions.
SURFACE BURNERS LIGHT BUT OVEN DOES NOT	<ul style="list-style-type: none"> • The oven gas shut off valve may have accidentally been moved during cleaning or moving. <p>To check the oven gas shut off valve on standard twin burner models, raise the cooktop and look for the gas shut off lever at the extreme right rear corner.</p> <p>To check the oven gas shut off valve on sealed burner models, remove the storage drawer, broiler drawer or kick panel and look for the gas shut off lever at the back of the range. On some models you may have to remove an access cover also.</p> <div style="display: flex; justify-content: space-around; margin-top: 10px;"> <div style="border: 1px solid black; padding: 5px; width: 45%;"> <p style="text-align: center; font-weight: bold;">Standard Twin Burner Models</p>  </div> <div style="border: 1px solid black; padding: 5px; width: 45%;"> <p style="text-align: center; font-weight: bold;">Sealed Burner Models</p>  </div> </div>

(continued next page)



THE PROBLEM SOLVER

(continued)

PROBLEM	POSSIBLE CAUSE
FOOD DOES NOT BROIL PROPERLY	<ul style="list-style-type: none">* Oven controls not properly set. See the Broiling section.• Oven door and/or broiler drawer not closed.• Improper shelf position being used. See the Broiling section.• Food is being cooked on a hot pan.• Cookware is not suited for broiling.• Aluminum foil used on the broiler pan rack has not been fitted properly and slit as recommended.• Oven bottom not securely seated in position.
FOOD DOES NOT ROAST OR BAKE PROPERLY	<ul style="list-style-type: none">• Oven controls not properly set. See the Baking or Roasting section.• Shelf position is not correct.• Incorrect cookware or cookware of improper size is being used.• Oven thermostat needs adjustment. See the Adjust the Oven Thermostat—<i>Do It Yourself</i> section.• Clock not set correctly.• Aluminum foil used improperly in the oven.• Oven bottom not securely seated in position.
CLOCK DOES NOT WORK	<ul style="list-style-type: none">• Range electrical plug must be securely seated in a live power outlet. Check for blown fuse or tripped circuit breaker,
OVEN LIGHT DOES NOT COME ON	<ul style="list-style-type: none">• Bulb may be loose or burned out.• Electrical plug must be plugged into a live power outlet.
STRONG ODOR	<ul style="list-style-type: none">• Improper air/gas ratio in oven. Adjust oven burner air shutter.• An odor from the insulation around the oven liner is normal for the first few times oven is used. This is temporary.
OVEN WILL NOT SELF-CLEAN	<ul style="list-style-type: none">• Oven temperature is too high to set self-clean operation. Allow the range to cool to room temperature and reset the controls.• Door latch handle not moved all the way to the right.
OVEN DOOR WILL NOT UNLOCK	<ul style="list-style-type: none">• Oven must cool below locking temperature. Do not lock the door with door latch except when using self-clean feature or the oven may lock.
OVEN NOT CLEAN AFTER CLEAN CYCLE	<ul style="list-style-type: none">• Oven controls not set properly. Review Operating the Self-Cleaning Oven section.• Heavily soiled oven requires 3½ to 4 hours of cleaning time.• Heavy spillovers should be cleaned up before starting clean cycle.
OVEN TEMPERATURE TOO HOT OR TOO COLD	<ul style="list-style-type: none">• The OVEN TEMP knob needs adjustment. See the Adjust the Oven Thermostat-<i>Do It Yourself</i> section.
OVEN DOOR ACCIDENTALLY LOCKED WHILE BAKING	<ul style="list-style-type: none">• Turn the OVEN TEMP knob to OFF. Allow the oven to cool and then unlatch the door.

If you need more help.. call, toll free:
GE Answer Center®
800.626.2000
consumer information service

We'll Be There

With the purchase of your new GE appliance, receive the assurance that if you ever need information or assistance from GE, we'll be there. All you have to do is call—toll-free!

In-Home Repair Service ***800-GE-CARES (800-432-2737)***

A GE consumer service professional will provide expert repair service, scheduled at a time that's convenient for you. Many GE Consumer Service company-operated locations offer you service today or tomorrow, or at your convenience (7:00 a.m. to 7:00 p.m. weekdays, 9:00 a.m. to 2:00 p.m. Saturdays). Our factory-trained technicians know your appliance inside and out—so most repairs can be handled in just one visit.

GE Answer Center® ***800.626.2000***

Whatever your question about any GE major appliance, GE Answer Center® information service is available to help. Your call—and your question—will be answered promptly and courteously. And you can call any time. GE Answer Center® service is open 24 hours a day, 7 days a week.

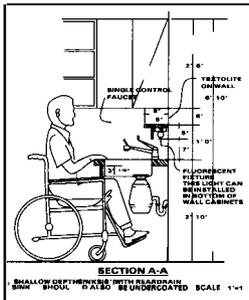

For Customer With Special Needs... ***800.626.2000***

Upon request, GE will provide Braille controls for a variety of GE appliances, and a brochure to assist in planning a barrier-free kitchen for persons with limited mobility. To obtain these items, free of charge, call 800.626.2000.

Consumers with impaired hearing or speech who have access to a TDD or a conventional teletypewriter may call 800-TDD-GEAC (800-833-4322) to request information or service.

Service Contracts ***800-626-2224***

You can have the secure feeling that GE Consumer Service will still be there after your warranty expires. Purchase a GE contract while your warranty is still in effect and you'll receive a substantial discount. With a multiple-year contract, you're assured of future service at today's prices.

Parts and Accessories ***800-626-2002***

Individuals qualified to service their own appliances can have needed parts or accessories sent directly to their home. The GE parts system provides access to over 47,000 parts... and all GE Genuine Renewal Parts are fully warranted. VISA, MasterCard and Discover cards are accepted.

User maintenance instructions contained in this booklet cover procedures intended to be performed by any user. Other servicing generally should be referred to qualified service personnel. Caution must be exercised, since improper servicing may cause unsafe operation.

YOUR GE GAS RANGE WARRANTY

Staple sales slip or cancelled check here. Proof of original purchase date is needed to obtain service under warranty.

WHAT IS COVERED

FULL ONE-YEAR WARRANTY

For one year from date of original purchase, we will provide, **free of charge**, parts and service labor in your home to repair or replace **any part of the range** that fails because of a manufacturing defect.

This warranty is extended to the original purchaser and any succeeding owner for products purchased for ordinary home use in the 48 mainland states, Hawaii and Washington, D.C. In Alaska the warranty is the same except that it is LIMITED because you must pay to ship the product to the service shop or for the service technician's travel costs to your home.

All warranty service will be provided by our Factory Service Centers or by our authorized Customer Care® servicers during normal working hours.

Should your appliance need service, during the warranty period or beyond, call 800-GE-CARES (800-432-2737). In Canada consult your telephone directory for the Cameo Service Center.

WHAT IS NOT COVERED

- Service trips to your home to teach you how to use the product.

Read your Use and Care material.

If you then have any questions about operating the product, please contact your dealer or our Consumer Affairs office at the address below, or call, toll free: GE Answer Center®
800.626.2000
consumer information service

- Improper installation.

If you have an installation problem, contact your dealer or installer. You are responsible for providing

adequate electrical, gas, exhausting and other connecting facilities as described in the Installation Instructions provided with the product.

- Replacement of house fuses or resetting of circuit breakers.
- Failure of the product if it is used for other than its intended purpose or used commercially.
- Damage to product caused by accident, fire, floods or acts of God.

WARRANTOR IS NOT RESPONSIBLE FOR CONSEQUENTIAL DAMAGES.

Some states do not allow the exclusion or limitation of incidental or consequential damages, so the above limitation or exclusion may not apply to you. This warranty gives you specific legal rights, and you may also have other rights which vary from state to state. To know what your legal rights are in your state, consult your local or state consumer affairs office or your state's Attorney General.

Warrantor: General Electric Company

**If further help is needed concerning this warranty, write:
Manager—Consumer Affairs, GE Appliances, Louisville, KY 40225**

This book is printed on recycled paper.

Part No. 164 D2764P053

Pub No. 49-8543

7-94 CG

JGBP24

JGBP25

JGBP29

JGBP30

JGBP32

JGBP33

Printed in Louisville, KY

Free Manuals Download Website

<http://myh66.com>

<http://usermanuals.us>

<http://www.somanuals.com>

<http://www.4manuals.cc>

<http://www.manual-lib.com>

<http://www.404manual.com>

<http://www.luxmanual.com>

<http://aubethermostatmanual.com>

Golf course search by state

<http://golfingnear.com>

Email search by domain

<http://emailbydomain.com>

Auto manuals search

<http://auto.somanuals.com>

TV manuals search

<http://tv.somanuals.com>