

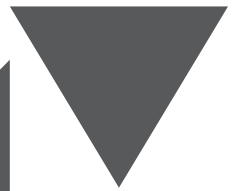

# GRAM

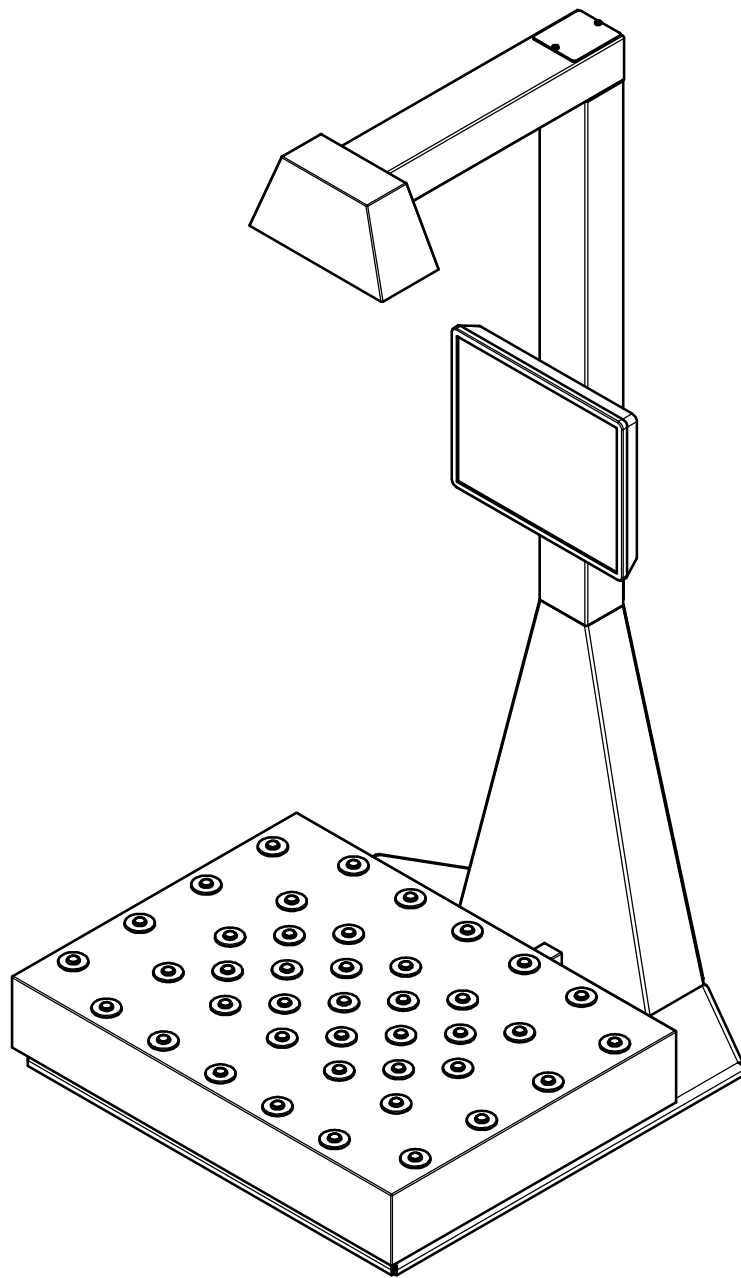

## QUBIC ONE



EN



### USER'S MANUAL



## Start-up

With the equipment correctly installed, having followed the assembly instructions included with this equipment, place it on the optional work table or other equivalent, sufficiently robust so that the equipment has sufficient rigidity and can work with the necessary stability.

Plug in the connection cable to the 220V mains.

At the rear left of the display screen is the start switch. Switch on to initialize the equipment.

The computer will initialize, starting with the Windows base software, followed by the launch of the Qubic application. The process, which can last a few minutes, should not be interfered with.

The screen with the application will appear.

## Description of the measurement screen

The following screen appears:





The upper right part shows the platform, where the package or box to be checked should be placed.

The left area shows the longitudinal values of the package, total volume and weight of the package.

The QR code shows the information of these values, so that they can be easily exported to other equipment that is equipped with a 2D scanner and adjusted to a minimum distance of 1 m, so as not to interfere with the reading of the equipment's 3D and infrared camera.

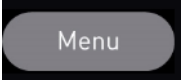
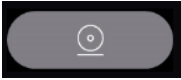
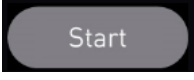
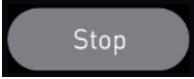
The lower right will display a keyboard with the following keys when you touch that area of the screen:

- . Opens the Settings Configuration Menu, which is protected with a password. It can only be used for equipment maintenance by personnel duly authorized by Gram Group.
- . Open the data screen. For this, the length of the package label codes should have been properly configured. It is an option that must be ordered from the factory to be available.
- . Pressing it starts the application.
- . Pressing to stop the application.
- . Zero the scale.
- . End the application.

## Basic use

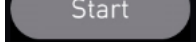
With the equipment running (if not, press the key , place the package to be calculated on the platform, so that it is centered and the green square is always within the upper part of its upper face.

It is important that the green rectangle is always inside, to avoid erroneous readings.

The reading of the equipment should not be interfered with by other objects, arms or hands. The reading area must be completely free.



The scanner of the equipment will immediately detect the edges and height of the package, and will show in its left area its dimensions in mm, volume in m<sup>3</sup> and weight in kg.

All this data is also shown in the QR code, to facilitate its export to another computer by a 2D scanner, with the following data format:

LXXXWXXXHXXXmmVXXXWtXXXkg, where X is the average data, whose length varies depending on the reading of the equipment. L indicates length, W indicates width, H indicates height, V indicates volume, and Wt indicates weight.

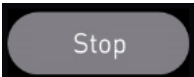
Remove the package and place the next one. The equipment displays its dimensions and weight in a few seconds, for a fast and efficient reading flow.

The equipment should only be stopped by means of the key  to prevent you from displaying readings when it is not running.

To turn off the equipment, press the key , and then the Windows desktop screen will appear. Press near the bottom of the screen to display the icon , press it, the icon  will appear over the previous one. Press it and select Shut down. The equipment will shut down properly.

To restart it, press the start switch indicated in the Start-up section of this manual.

### **Use with database**

The equipment allows adding information on the carrier and the tracking of the package by means of a scanner, but for this the system must be configured by the Gram Group technicians. It is an option with cost.

This data is stored in a csv file.

## Cone of maximum dimensions of measurements

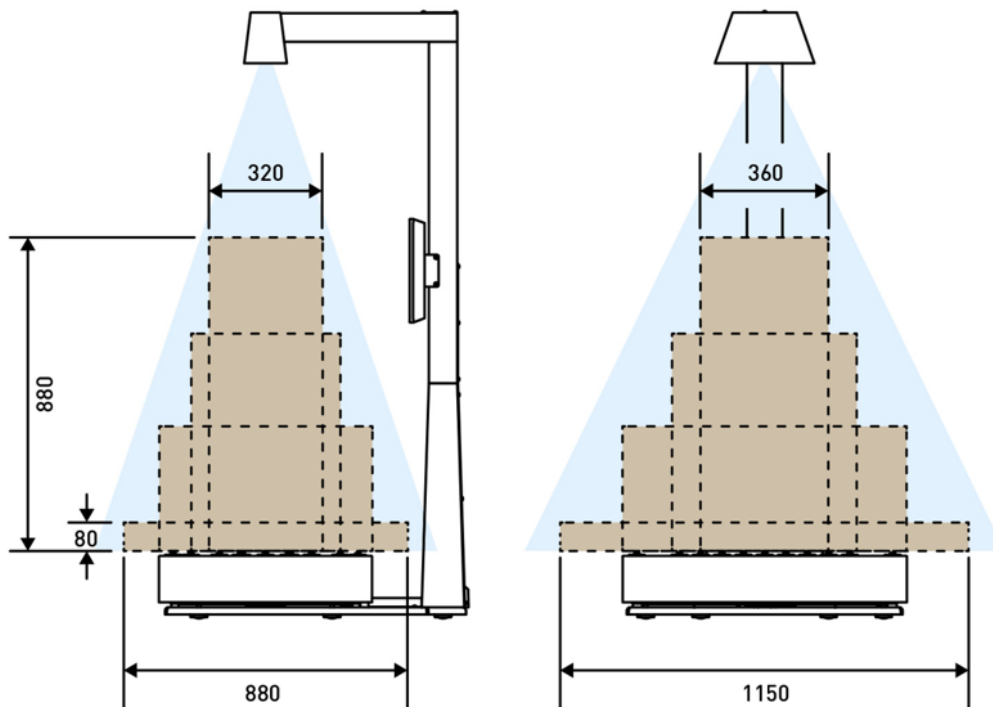

Large (mm)	Wide (mm)	High (mm)
1150	800	80 (min)
800	600	350
520	420	610
360	320	880 (max)

# Equipment dimensions

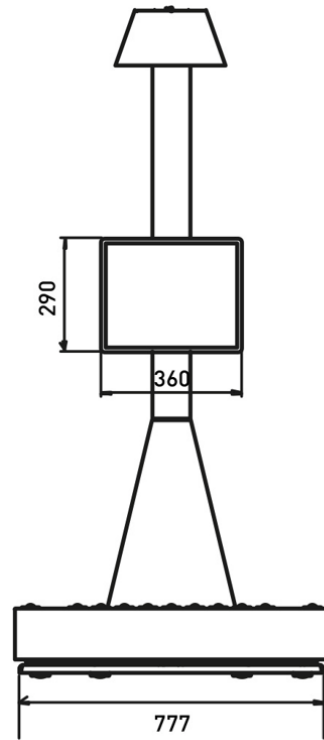
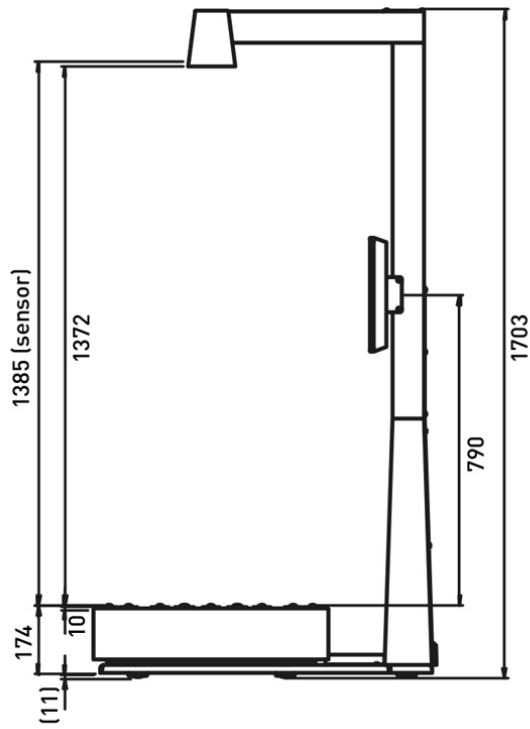
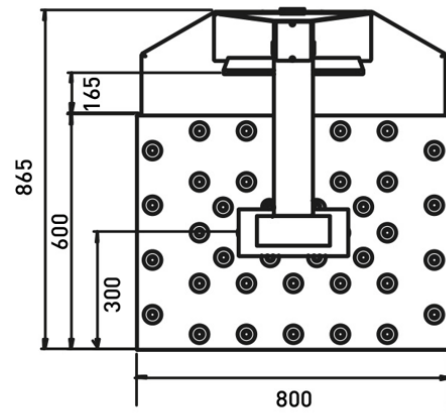

01/02112021



**Gram Precision S.L.**

Travesía Industrial, 11 · 08907 Hospitalet de Llobregat · Barcelona (Spain)

Tel. +34 902 208 000 · +34 93 300 33 32

Fax +34 93 300 66 98

[comercial@gram.es](mailto:comercial@gram.es)

[www.gram-group.com](http://www.gram-group.com)



## Free Manuals Download Website

<http://myh66.com>

<http://usermanuals.us>

<http://www.somanuals.com>

<http://www.4manuals.cc>

<http://www.manual-lib.com>

<http://www.404manual.com>

<http://www.luxmanual.com>

<http://aubethermostatmanual.com>

Golf course search by state

<http://golfingnear.com>

Email search by domain

<http://emailbydomain.com>

Auto manuals search

<http://auto.somanuals.com>

TV manuals search

<http://tv.somanuals.com>