



neo

DUCTLESS INVERTER AIR CONDITIONER

INSTALLATION MANUAL

Models:

NEO09AC115V1A

NEO12AC115V1A

NEO09AC230V1A

NEO12AC230V1A

NEO18AC230V1A

NEO24AC230V1A

NEO30AC230V1A

NEO36AC230V1A



Thank you for choosing a Gree Neo Ductless AIR CONDITIONER for your customer.

Please read this installation manual carefully before installing and starting up the Neo System. Take a moment to fill out the product and installation form on the back cover. Retain both the manual and installation record for future reference.

Contents

• <i>Safety Precautions</i>	2
• <i>System Requirements</i>	4
• <i>Suggested Tools</i>	5
• <i>Site Instructions</i>	6
• <i>Dimensions</i>	7
• <i>Indoor Unit</i>	9
• <i>Outdoor Unit</i>	12
• <i>Refrigerant Piping</i>	13
• <i>Power and Wiring</i>	16
• <i>Vacuum Testing</i>	19
• <i>Start-up</i>	21
• <i>Troubleshooting</i>	22



SAFETY PRECAUTIONS

Please read the following before installation.

Recognize safety information.  This is the safety-alert symbol. When you see this symbol on the unit and in instructions or manuals, be alert to the potential for personal injury. Understand these signal words: **DANGER**, **WARNING**, and **CAUTION**. These words are used with the safety-alert symbol.

DANGER identifies the most serious hazards which will result in severe personal injury or death.

WARNING signifies hazards which could result in personal injury or death.

CAUTION is used to identify unsafe practices which may result in minor personal injury or product and property damage.

NOTE is used to highlight suggestions which will result in enhanced installation, reliability, or operation.

NOTE: Your actual air conditioner system and related devices may differ from the images shown in this manual.

This appliance is not intended for use by children without responsible adult supervision. Proper care should be taken to ensure safety.



WARNING

Heat pumps, air conditioners & heating equipment should be installed, started up, and serviced only by qualified installers and service technicians. Air conditioning, heat pumps and refrigeration systems are hazardous due to high voltage electrical components, high refrigerant pressures, and moving parts.

SAFETY PRECAUTIONS



CAUTION

- *The unit should be installed and serviced only by trained, qualified installers and service mechanics. Untrained personnel can perform basic maintenance functions such as cleaning coils. All other operations should be performed by trained service personnel.*
- *Owner should be cautioned that children should not play with the appliance.*



WARNING

ELECTRICAL SHOCK HAZARD

Failure to follow this warning could result in personal injury or death.

- *Before installing, servicing or modifying the system, the main electrical disconnect switch must be in the OFF position. There may be more than one disconnect switch. Lock out and tag all switches with a warning label.*

General Safety Precautions

- *A dedicated power supply circuit should be used in accordance with local electrical safety regulations and National Electrical Codes (NEC).*
- *Ensure that the entire system is reliably grounded.*
- *Use proper size circuit breaker to protect equipment against short circuit and overload conditions.*
- *Observe all local codes and regulations.*

INSTALLATION SITE INSTRUCTIONS

Proper installation site is vital for correct and reliable operation of the system.

Avoid the following installation locations:

- *Strong heat sources, vapors, flammable gas or volatile liquids.*
- *High-frequency electro-magnetic waves, generated by radio equipment, welders or medical equipment.*

SYSTEM REQUIREMENTS

Piping Requirements

PIPE SIZE in (mm)

Unit Size (BtuH)	Voltage	Liquid Line	Suction/Gas Line
9,000	115v - 1ph 60hz	1/4 (6)	3/8 (9.5)
12,000	115v - 1ph 60hz	1/4 (6)	3/8 (9.5)
9,000	208/230v - 1ph 60hz	1/4 (6)	3/8 (9.5)
12,000	208/230v - 1ph 60hz	1/4 (6)	3/8 (9.5)
18,000	208/230v - 1ph 60hz	1/4 (6)	1/2 (12)
24,000	208/230v - 1ph 60hz	1/4 (6)	5/8 (16)
30,000	208/230v - 1ph 60hz	1/4 (6)	5/8 (16)
36,000	208/230v - 1ph 60hz	1/4 (6)	5/8 (16)

REFRIGERANT LINE LENGTHS ft (m)

Unit Size (BtuH)	Voltage	Min Line Length	Max Line Length	Max Elevation (ID over OD)
9,000	115v - 1ph 60hz	10 (3)	50 (15)	33 (10)
12,000	115v - 1ph 60hz	10 (3)	50 (15)	33 (10)
9,000	208/230v - 1ph 60hz	10 (3)	50 (15)	33 (10)
12,000	208/230v - 1ph 60hz	10 (3)	66 (20)	33 (10)
18,000	208/230v - 1ph 60hz	10 (3)	82 (25)	33 (10)
24,000	208/230v - 1ph 60hz	10 (3)	82 (25)	33 (10)
30,000	208/230v - 1ph 60hz	10 (3)	100 (30)	33 (10)
36,000	208/230v - 1ph 60hz	10 (3)	100 (30)	33 (10)

Notes: Insulate both refrigerant lines, separately.

REFRIGERANT CHARGE

Unit Size (BtuH)	Voltage	Refrigerant Type	Factory System Charge oz (kg)*	Additional Charge oz/ft (g/m)
9,000	115v - 1ph 60hz	R410A	42.9 (1.2)	0.2 (20)
12,000	115v - 1ph 60hz	R410A	46.4 (1.3)	0.2 (20)
9,000	208/230v - 1ph 60hz	R410A	46.4 (1.3)	0.2 (20)
12,000	208/230v - 1ph 60hz	R410A	46.4 (1.3)	0.2 (20)
18,000	208/230v - 1ph 60hz	R410A	49.4 (1.4)	0.2 (20)
24,000	208/230v - 1ph 60hz	R410A	56.5 (1.6)	0.5 (50)
30,000	208/230v - 1ph 60hz	R410A	84.7 (2.4)	0.5 (50)
36,000	208/230v - 1ph 60hz	R410A	91.7 (2.6)	0.5 (50)

*Precharge amount for up to 25-ft of refrigerant pipe.

ELECTRICAL REQUIREMENTS

Unit Size (BtuH)	Voltage	Min Circuit Amps (MCA)	Max Overcurrent Protection (MOP)	Main Power Wire Size (AWG)**
9,000	115v - 1ph 60hz	22	35	10
12,000	115v - 1ph 60hz	23	40	10
9,000	208/230v - 1ph 60hz	10	15	14
12,000	208/230v - 1ph 60hz	10	15	14
18,000	208/230v - 1ph 60hz	13	20	12
24,000	208/230v - 1ph 60hz	16	25	10
30,000	208/230v - 1ph 60hz	20	30	10
36,000	208/230v - 1ph 60hz	24	40	10

**Main power wire from electrical panel to outdoor unit.

- Notes:
- 1) System must be on a single dedicated circuit.
 - 2) Main power is supplied to the outdoor unit.
 - 3) Use table above to size over current protection.
 - 4) Follow all local building codes and NEC (National Electrical Code) regulations.

Interconnecting Cable: Recommended cable - 14/4 AWG stranded bare copper conductors THHN 600V unshielded wire
 Note: Use shield cable if installation is in close proximity of RF and EMI transmitting devices.

Condensate Drain Size: 5/8-in OD 7/16-in ID

Note: Insulate condensate drain hose to prevent sweating and possible water damage.



SUGGESTED TOOLS



- *Standard Wrench*
- *Adjustable/Crescent Wrench*
- *Torque Wrench*
- *Hex Keys or Allen Wrenches*
- *Drill & Drill Bits*
- *Hole Saw*
- *Pipe Cutter*
- *Screw drivers (Phillips & Flat blade)*
- *Manifold and Gauges*
- *Level*
- *R410A Flaring Tool*
- *Clamp on Amp Meter*
- *Vacuum Pump*
- *Safety Glasses*
- *Work Gloves*
- *Refrigerant Scale*
- *Micron Gauge*



INSTALLATION SITE INSTRUCTIONS

Step 1

Installation Site of Indoor Unit

Select a site that allows for the following:

- Ensure the installation complies with the installation minimum dimensions and meets the minimum and maximum connecting piping length and maximum change in elevation.
- Air inlet and outlet will be clear of obstructions, ensuring proper airflow throughout the room.
- Condensate can be easily and safely drained.
- All connections can be easily made to outdoor unit.
- Indoor unit is out of reach of children.
- A wall strong enough to withstand the full weight and vibration of the unit.
- Filter can be easily accessed for cleaning.
- Leave enough free space to allow access for routine maintenance.
- Install at least 10 ft. (3 m) away from the antenna of TV set or radio. Operation of the air conditioner may interfere with radio or TV reception in areas where reception is weak. An amplifier may be required for the affected device.
- Do not install in a laundry room or by a swimming pool.
- Determine if condensate pump is required to properly drain condensate water from the indoor unit.

Installation Site of Outdoor Unit

Select a site that allows for the following:

- Outdoor location meets all minimum installation distances defined in the Installation Dimensions section.
- Sound from outdoor unit will not annoy neighbors.
- All connections can be easily made to indoor unit.
- Air inlet and outlet will be clear of obstructions to ensure proper airflow.
- Wall or roof is strong enough to withstand the full weight and vibration of the outdoor unit (for wall or roof installation only).
- Outdoor unit is out of reach of children and does not obstruct walkways.
- Outdoor unit is not exposed to direct sunlight or strong wind.
- Maintenance and repairs can be easily performed on the outdoor unit.
- Ensure the installation complies with the minimum and maximum connecting piping length and maximum change in elevation criteria.

INSTALLATION DIMENSIONS

Indoor unit

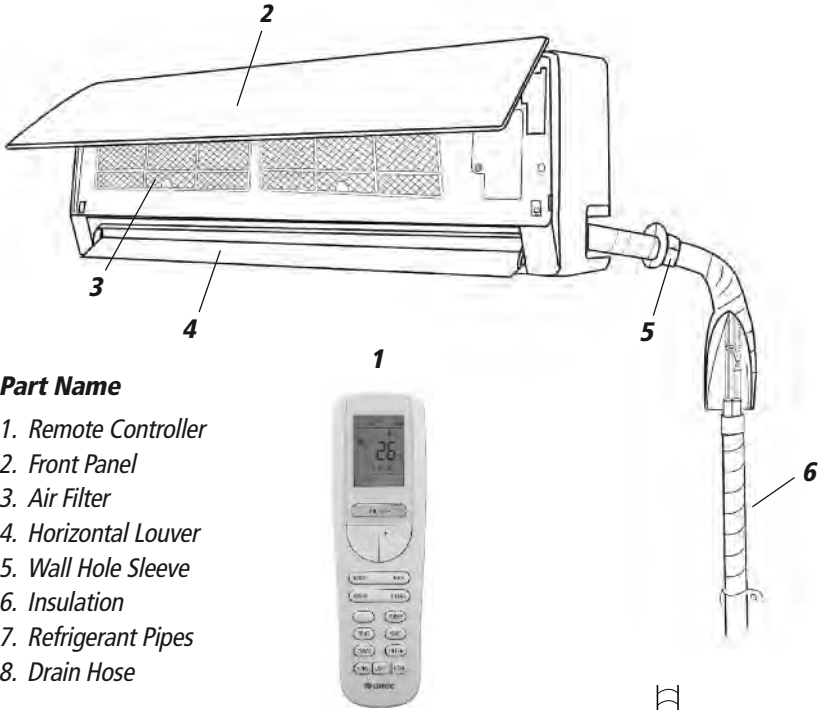

Part Name

1. Remote Controller
2. Front Panel
3. Air Filter
4. Horizontal Louver
5. Wall Hole Sleeve
6. Insulation
7. Refrigerant Pipes
8. Drain Hose

Outdoor unit

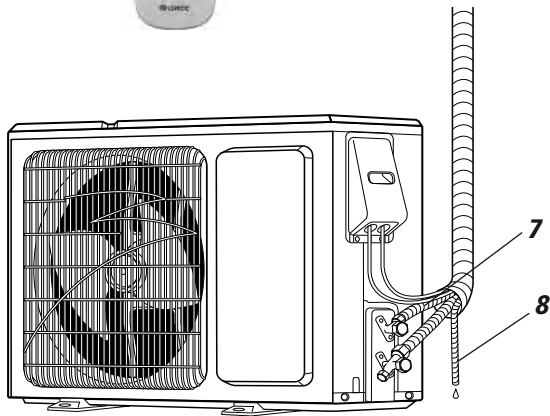

INSTALLATION DIMENSIONS

Minimum indoor clearances

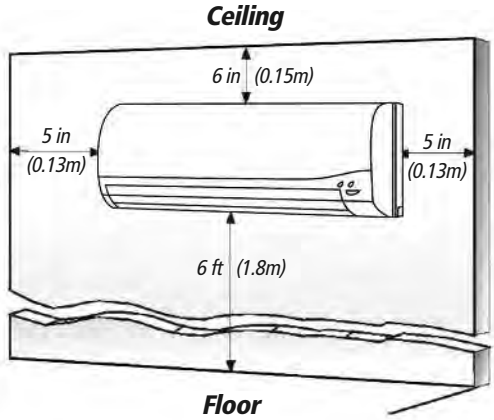

Minimum outdoor clearances

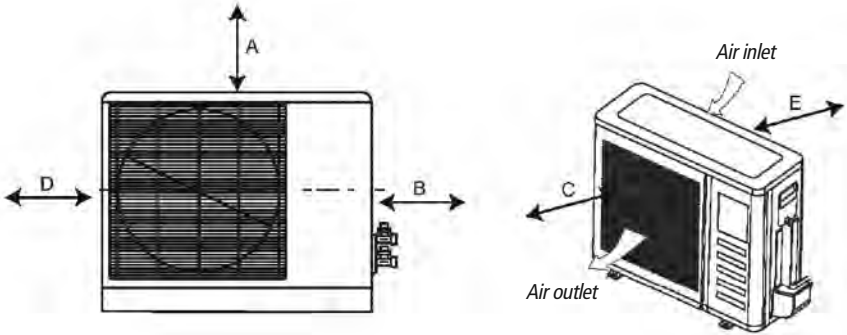

Outdoor Unit	Minimum Distances in (mm)
A	20 (500)
B	20 (500)
C	24 (610)
D	12 (305)
E	12 (305)

INSTALLATION OF INDOOR UNIT

Step 2

Installation of Mounting Bracket

1. Attach the mounting bracket to the indoor unit.
2. Find the horizontal center of the indoor unit.
3. Mark the center of the indoor unit on mounting bracket for future reference.

NOTE: The center of the mounting bracket is not the center of the indoor unit.

4. Remove the mounting brackets from the indoor unit and position the mounting bracket on the wall in desired location. Use centering mark on mounting bracket for centering the indoor unit on the wall.
5. Mounting bracket must be installed horizontally and level right to left.

NOTE: Condensate drain pan has built-in pitch for proper drainage.

6. Secure mounting bracket to wall with a minimum of five screws, evenly spaced to properly support indoor unit weight.

NOTE: It is recommended to install screw anchors for sheet rock, concrete block, brick and such type of walls.

INSTALLATION OF INDOOR UNIT

Mounting Bracket Diagrams and Dimensions

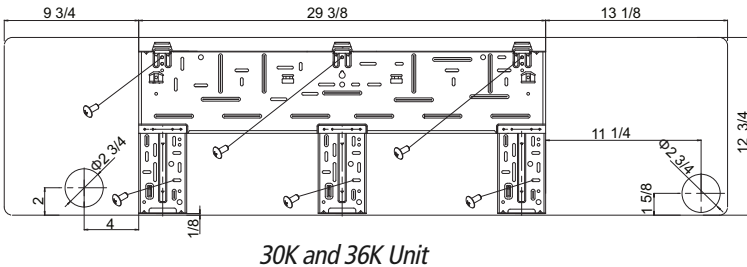
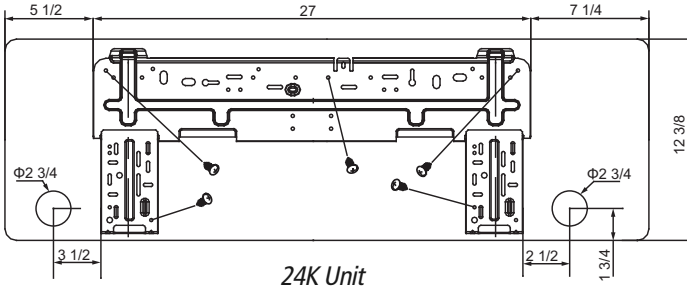
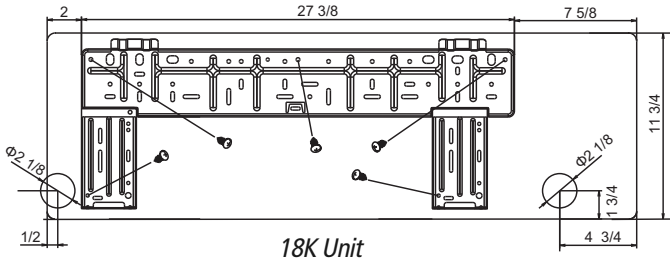
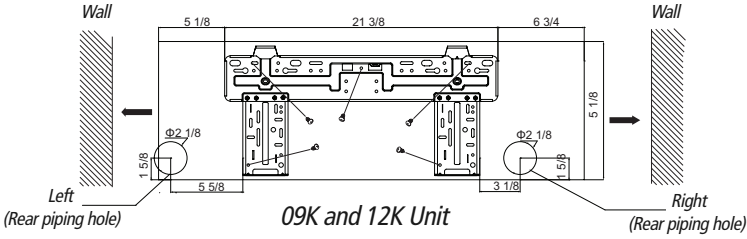

INSTALLATION OF INDOOR UNIT

Step 3

Drill Hole in Wall for Interconnecting Piping, Drain & Wiring

If indoor unit refrigerant piping is going to exit from the rear:

1. It is recommended that the refrigerant pipe flare connectors extend through the wall to the outside. In some situations field-fabricated piping extensions will be required to extend the indoor unit refrigerant flare connections to the outside of the wall.
2. Use mounting bracket diagrams and dimensions to find and mark the proper location for the wall hole.

If refrigerant piping is going through the right or left side of front panel:

1. Use a small saw blade to carefully cut a U-shaped hole in the side of the front panel. The hole must be large enough for refrigerant pipes, condensate hose and wires.
2. Determine and mark proper location for wall hole.
3. Use table below to determine recommended wall hole size for your unit size.

Table of Wall Hole Size per Unit Size

Unit Size (BtuH)	Wall Hole Size (Diameter)	
	in	mm
9,000	2 1/4	55
12,000	2 1/4	55
18,000	2 3/4	66
24,000	2 3/4	66
30,000	2 3/4	66
36,000	2 3/4	66

4. Cut the wall hole with a 5° to 10° downward slant to the outdoors.
5. Insert a wall hole sleeve into hole to prevent damage to refrigerant pipes, insulation, condensate drain hose and wiring.
6. Seal around wall hole sleeve with caulk or foam to weatherproof.

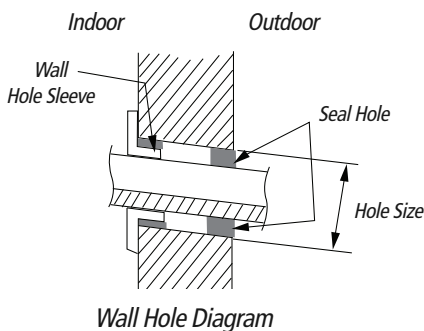

OUTDOOR UNIT PREPARATION

Step 4

Install Ground Pad or Wall Hangers

1. Determine proper location for outdoor unit.
2. Follow all instructions provided by manufacturer for installing wall hangers or ground pad.
3. Verify the wall hangers or ground pad can safely support the weight of the outdoor unit.
4. Verify the wall hangers or ground pad is level and meets all outdoor dimensional clearances.

Install Outdoor Unit Risers

If the outdoor unit requires added elevation above the ground, installing riser legs will provide a sturdy and stable solution. Follow all instructions provided by manufacturer for installing riser legs to outdoor unit.

NOTE: Riser legs will also help absorb vibrations and noise while facilitating proper drainage.



WARNING

Florida Wind Load Requirements state that outdoor unit must be anchored to concrete pad using four 3/8-in diameter Power Wedge Bolt Plus (or equivalent) with 1-in diameter fender washers. Anchor bolts must be embedded into 3,000 PSI minimum concrete at a distance of 4 1/2-in from any concrete edge. The concrete thickness must exceed 1.5 times the anchor depth.

Install Condensate Drain for Outdoor Unit

The condenser water can be routed to a safe location through the drain hose.

1. Locate drain hole on bottom of outdoor unit.
2. Install the outdoor drain fitting into hole on the bottom of outdoor unit as shown.
3. Connect the drain hose to drain fitting.
4. Route drain hose to safe location for proper drainage of excess condensate water.

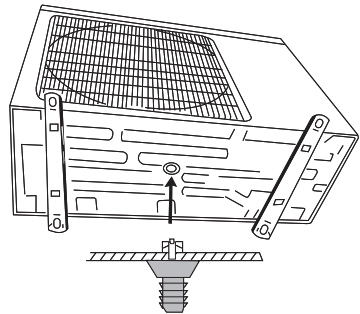

Drain Fitting Installation

INSTALLATION OF REFRIGERANT PIPING

Step 5

Piping Connections to Outdoor Unit



CAUTION

Use refrigeration grade tubing ONLY. No other type of tubing may be used. Use of other types of tubing will void manufacturer's warranty. Make sure there is enough piping to cover the required length between the outdoor and indoor unit.

Piping Preparation

- Do not open service valves or remove protective caps from tubing ends until all connections are made.
- Keep tubing free of dirt, sand, moisture and contaminants.
- Use a flexible condensate drain hose to fit over the factory 5/8-inch (16mm) drainage hose.
- Insulate each refrigerant pipe and condensate hose with minimum 3/8" (10 mm) wall thermal pipe insulation.

NOTE: Insulate condensate hose to prevent sweating which may cause water stains or wall damage.

- Bind refrigerant pipes, condensate hose and interconnecting wire together with cable ties at 12 inch intervals.

NOTE: A condensate pump accessory (sold separately) is recommended for the indoor unit when adequate line pitch cannot be provided for drainage.

Piping and Drain Hose Connections to Indoor Unit

NOTE: For maximum serviceability, it is recommended to have refrigerant pipe flare connections and the drain connection on the outside.

1. Feed refrigerant pipes, drain hose and interconnecting wires assembly through wall hole from outdoor to the indoor space.
2. Set the indoor unit on mounting bracket. Allow the indoor unit to hinge on the top of the mounting bracket. Do not lock down bottom of unit to mounting bracket.
3. Adjust the length of the interconnecting wires so that it can easily reach the indoor unit electrical control box. Route and fit the interconnecting wires into back side of indoor unit.

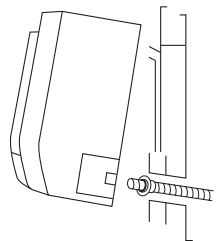

INSTALLATION OF REFRIGERANT PIPING

4. Open front cover of indoor unit and remove field wiring terminal block cover. Route the interconnecting wires to terminal block in control box.

5. Allow interconnecting wires to hang free. Wire connections will be handled later in these instructions.

6. Adjust the length of condensate drain hose to easily meet the drain pipe of the indoor unit. Make connection and secure with a hose clamp. Insulate the drainage hose and connection to prevent sweating.

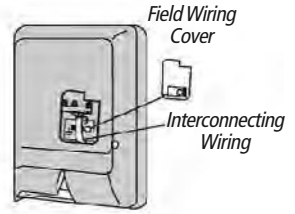

NOTE: Prevent condensate drain hose from sagging or kinking for proper drainage.

7. Adjust the length and carefully bend refrigerant pipes to meet indoor unit refrigerant pipe connections with proper tools to avoid kinks.

8. Apply a small amount of refrigerant oil to the flare connection on the refrigerant pipes.

9. Properly align piping and tighten flare nut using a standard wrench and a torque wrench as shown in figure to the right:

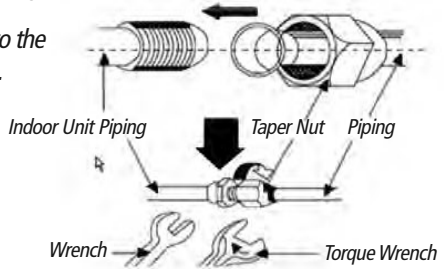

10. Carefully tighten flare nuts to correct torque level referring to the following Torque Table:

Torque Table

Pipe Diameter inch (mm)	Nut Size inch (mm)	Tightening Torque	
		ft-lbs	N-m
1/4 (6.35)	1/4 (17)	10 to 13	14 to 18
3/8 (9.5)	3/8 (22)	25 to 30	34 to 42
1/2 (12.7)	1/2 (25)	36 to 45	49 to 61
5/8 (15.9)	5/8 (29)	50 to 60	68 to 82

NOTE: Over tightening may damage flare connections and cause leaks.

11. Apply insulation to refrigerant pipe joints to prevent sweating.

12. Gently and securely lock down bottom of indoor unit to wall mounting bracket.



INSTALLATION OF REFRIGERANT PIPING

Step 6

Piping Connections to Outdoor Unit

1. Remove service valve cover (if provided) to access the service valves and refrigerant ports.
2. Carefully bend and adjust length of refrigerant pipes to meet outdoor unit service valves connections with proper tools to avoid kinks.

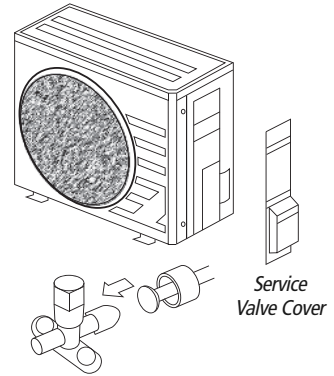

NOTE: Use proper techniques to cut and re-flare refrigerant pipes, if required. An R410A Flaring Tool is required for re-flaring refrigerant pipes.

3. Apply a small amount of refrigerant oil to the flare connection on the refrigerant pipe.
4. Properly align piping and tighten flare nut using a standard wrench and a torque wrench as shown in the indoor piping section.
5. Carefully tighten flare nuts to correct torque level referring to the following Torque Table:

Torque Table

Pipe Diameter inch (mm)	Nut Size inch (mm)	Tightening Torque	
		ft-lbs	N-m
1/4 (6.35)	1/4 (17)	10 to 13	14 to 18
3/8 (9.5)	3/8 (22)	25 to 30	34 to 42
1/2 (12.7)	1/2 (25)	36 to 45	49 to 61
5/8 (15.9)	5/8 (29)	50 to 60	68 to 82

NOTE: Over tightening may damage flare connections and cause leaks.

INSTALLATION OF POWER AND WIRING

Step 7

Indoor Unit Interconnecting Wire Connections



WARNING

Disconnect all electrical power to unit including disconnects, fuses and circuit breakers.

1. Open front cover of indoor unit and remove field wiring terminal block cover.
2. Pull interconnecting wires up from back of indoor unit and position in close to the terminal block on indoor unit.

NOTE: The indoor unit is powered from the outdoor unit, depending on local code, a disconnect switch may need to be installed to a power supply circuit.

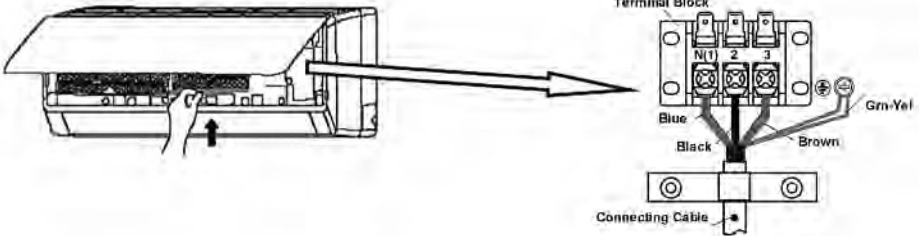

3. Connect wiring to indoor unit per connection diagram.

NOTE: Record wire colors and terminal references for uses with Outdoor Unit wire connections.

4. Replace field wiring cover and close front cover of indoor unit.

INSTALLATION OF POWER AND WIRING

Step 8

Outdoor Unit Wire Connections



WARNING

Disconnect all electrical power to unit including disconnects, fuses and circuit breakers.

1. Remove the service panel on right side of the outdoor unit.
2. Insert interconnecting wires and main power wires through the wire holes on conduit mounting bracket.
3. Secure main power conduit (and interconnecting wire conduit, if required) with locking nuts to conduit mounting bracket.
4. Open wire clamp/strain relief and adjust wire lengths or proper connections to the outdoor unit terminal block.

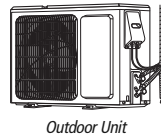
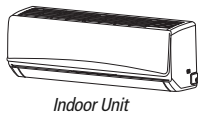
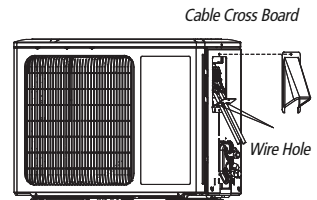

**Wiring Diagram
9K and 12K BtuH
(115V Models)**

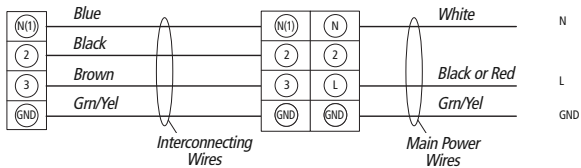

**Wiring Diagram
9K and 12K BtuH
(230V Models)**

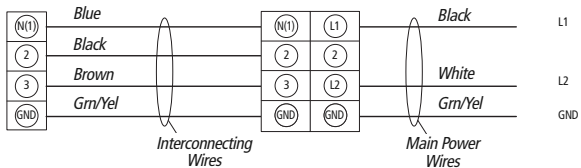

**Wiring Diagram
18K to 36K BtuH**

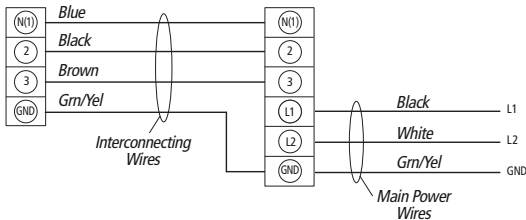

INSTALLATION OF POWER AND WIRING

5. Following the same wire colors and terminal references from the indoor unit, tightly connect interconnecting wires to the outdoor unit terminal block per wiring diagram above.

NOTE: Crossing interconnecting wires will cause system malfunction and possible damage.

6. Tightly connect main power wires to outdoor unit terminal block per wiring diagram above.
7. Secure all wires inside wire clamp/strain relief. Verify wires are secure, not loose and no external force on wires affects the connections at the terminals.
8. Replace service panel on right side of the outdoor unit.
9. Connect main power wires and conduit to unit disconnect switch box per manufacturer's instructions, National Electrical Code (NEC) and local electrical codes.

CAUTION

- Electrical Disconnecting means must be provided and shall be located within sight and readily accessible from the unit.
- Failure to follow this caution may result in equipment damage or improper operation.
- All wires running from the indoor to outdoor unit must comply with National Electrical Code (NEC) and local codes.
- No wire should be allowed to touch refrigerant tubing, compressor or any moving parts.
- All wires must be connected firmly to terminal block to avoid unit malfunction, overheating and possible fire hazard.

Local codes may require a disconnect switch within sight of the indoor unit. Use a DFS Disconnect Switch Accessory Kit (Part No: DFS-SWITCH-A) to break wires going to the N(1), 2, 3, terminals on the indoor unit, as shown in the wiring diagram below:

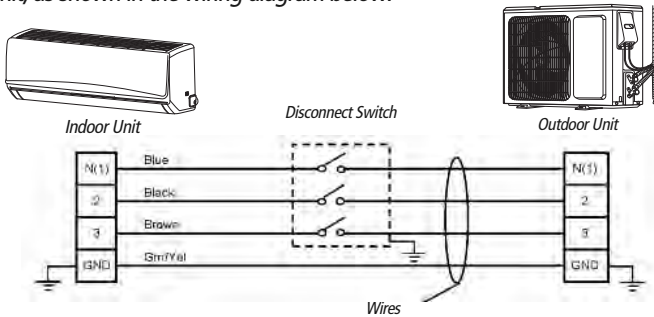

CAUTION

Never break or interrupt the ground wire with a switch or disconnect device.

VACUUM TESTING

Step 9

Leaking Test

1. Connect the charging hose of the manifold valve to charge the end of the low-pressure valve.
2. Add dry nitrogen to a pressure of 200 lbs. Tightly close both high- and low-pressure valves.
3. Leak-test flare fittings with soap bubbles. If no leak is detected, release nitrogen.

Step 10

System Vacuum and Charge



CAUTION

UNIT DAMAGE HAZARD

Never use the system compressor as a vacuum pump. It may result in equipment damage or improper system operation.

Refrigerant pipes and indoor coil should be evacuated using the recommended deep vacuum method of 500 microns. The alternate triple evacuation method may be used if the procedure outlined below is followed.

NOTE: Always break a vacuum with dry nitrogen.

Using Vacuum Pump

1. Completely tighten flare nuts A, B, C, D, connect manifold gage charge hose to a charge port of the low side service valve.
2. Connect charge hose to vacuum pump.
3. Fully open the low side of manifold gage. See figure at right.
4. Start vacuum pump.

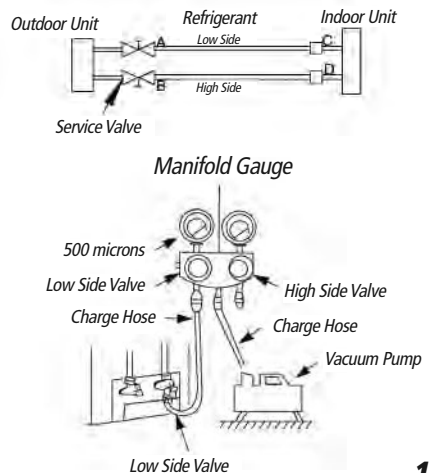

VACUUM TESTING

5. Evacuate using either deep vacuum or triple evacuation method.
6. After evacuation is complete, fully close the low side of manifold gage and stop operation of vacuum pump.
7. The factory charge contained in the outdoor unit is good for up to 25 ft. (8 m) of line length.

NOTE: For refrigerant lines longer than 25 ft (8 m), add add'l refrigerant per foot of extra piping up to the maximum allowable length. See System Requirement section on page 4 for more info

8. Disconnect charge hose from charge connection of the low side service valve.
9. Fully open service valves B and A.
10. Securely tighten caps of service valves.

Deep Vacuum Method

The deep vacuum method requires a vacuum pump capable of pulling a vacuum of 500 microns and a vacuum gage capable of accurately measuring this vacuum depth. The deep vacuum method is the most positive way of assuring a system is free of air and liquid water.

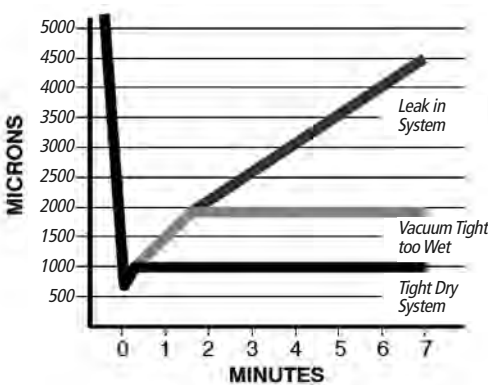

Deep Vacuum Graph

START-UP

Step 11

Installing Photocatalytic Filter (optional)

1. Lift front panel and remove air filter. (Fig. a).
2. Attach photocatalytic filter onto air filter. (Fig. b).
3. Install air filter as shown; close panel. (Fig. c).

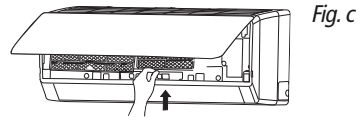
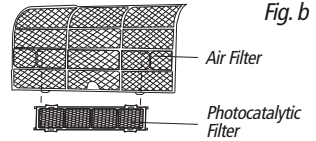
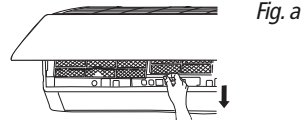

Step 12

Start-up and Checkout

Test Operation

Perform test operation after completing gas leak and electrical safety check.

1. Turn on electrical disconnect to outdoor unit.
2. Push the "ON/OFF" button on Remote Control to begin testing.

NOTE: A protection feature prevents the system from being activated for approx. 3 minutes.

3. Push MODE button, select COOLING, FAN mode to confirm all functions.

System Checks

1. Conceal refrigerant pipes where possible.
2. Make sure drain hose slopes downward along entire length.
3. Ensure all refrigerant pipes and connections are properly insulated.
4. Fasten pipes to outside wall, when possible.
5. Seal and weatherproof wall hole which the interconnecting wires and refrigerant pipes pass through.

Indoor Unit

1. Do all Remote Control buttons function properly?
2. Do the display panel lights work properly?
3. Does the swing louver function properly?
4. Does the drain work?

Outdoor Unit

Push the mode button to COOL and adjust the room setting to 61°F deg. Wait up to 3 minutes from compressor time guard. Does compressor and outdoor fan turn on in cooling mode?

START-UP AND TROUBLESHOOTING

Explain Following Items To Customer With The Aid Of The Owner's Manual:

1. How to turn system on and off; selecting COOLING and other operating modes; setting a desired temperature; setting the timer to automatically start and stop system operation; and all other features of the Remote Control and display panel.
2. How to remove and clean the air filter.
3. How to set air with the swing louvers.
4. Explain care and maintenance.
5. Present the Owner's Manual and installation instructions to customer.

Troubleshooting

This unit has onboard diagnostics. Error codes will appear on the LED display on the front panel of the indoor unit in place of the temperature display. The table below explains the error codes for both units.

DIAGNOSTIC CODES

Equipment Fault	Error Codes	Possible Causes
Indoor Configuration Jumper	C5	Missing Configuration Jumper on Indoor Control Board
Indoor/Outdoor Mismatch	LP	Indoor and Outdoor Units Do Not Match (Model or Capacity)
High Current Protection	E5	Power Supply is not Stable and Voltage Range is too Large
Communication Error	E6	Mis-wired or Communication Failure
Indoor Air Temp. Thermistor	F1	Bad Connection, or Indoor Air Sensor Failure
Indoor Coil Temp. Thermistor	F2	Bad Connection, or Indoor Coil Sensor Failure
Outdoor Air Temp. Thermistor	F3	Bad Connection, or Outdoor Ambient Sensor Failure
Outdoor Coil Temp. Thermistor	F4	Bad Connection, or Outdoor Coil Sensor Failure
Compressor Discharge Temp. Thermistor	F5	Bad Connection, or Discharge Sensor Failure
Compressor Overload Protection	H3	Low Refrigerant Charge, Blocked Capillary, or Compressor Motor Failure
IPM Module Protection	H5	IPM Module Temperature Too High, High Ambient, Low Voltage, or Bad Connections
Indoor Fan Malfunction	H6	Indoor Fan Stopped or Running too Slow
Compressor Synchronism	H7	High Pressure, Low Voltage, or Bad Connections
High Pressure Protection	E1	Too much refrigerant or High Ambient conditions or low airflow.



GREE ELECTRIC APPLIANCES, INC.

www.greecomfort.com

PRODUCT & INSTALLATION RECORD

For your convenience, please record the model and serial numbers of your new equipment in the spaces provided. This information, along with the installation data and dealer contact information, will be helpful should your system require maintenance or service.

UNIT INFORMATION

Model No. _____

Serial No. _____

INSTALLATION INFORMATION

Date Installed: _____

DEALERSHIP/INSTALLER INFORMATION

Company Name: _____

Address: _____

Phone Number: _____

Technician Name: _____



Free Manuals Download Website

<http://myh66.com>

<http://usermanuals.us>

<http://www.somanuals.com>

<http://www.4manuals.cc>

<http://www.manual-lib.com>

<http://www.404manual.com>

<http://www.luxmanual.com>

<http://aubethermostatmanual.com>

Golf course search by state

<http://golfingnear.com>

Email search by domain

<http://emailbydomain.com>

Auto manuals search

<http://auto.somanuals.com>

TV manuals search

<http://tv.somanuals.com>