

# WIRELESS KEYPAD

## AXWK INSTRUCTIONS

### BEFORE YOU BEGIN

- 1) Keypad housing must be removed and two (2) C batteries (not included) need to be installed before programming. Installing the batteries requires you to unscrew the bottom two screws and to insert the batteries.
- 2) **You must create a Master PIN** for your Ghost Controls keypad before any other programming functions can be performed. The keypad will store only one master pin and can store an additional 19 access pins. The master pin must be used to enable additional features.

The keypad will remain in programming mode for up to 1 minute between button presses to allow adequate time to go through each step. If you enter an invalid sequence, the keypad will immediately drop out of programming mode and you will have to start back at Step 1 of the programming sequence.

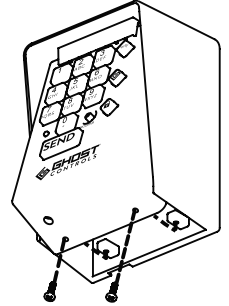

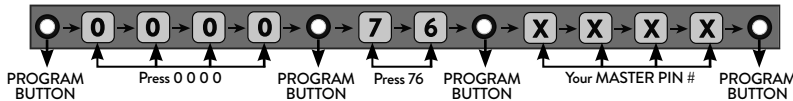

### STEP 1. PROGRAMMING YOUR MASTER PIN

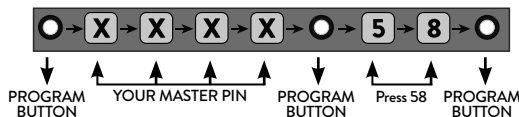

- 1) Press and release the Program Button
- 2) Enter 0000
- 3) Press and release the Program Button
- 4) Enter 76
- 5) Press and release the Program Button
- 6) Enter your 4 digit master pin (cannot use 0000)
- 7) Press and release the Program Button

### STEP 2. TEACHING YOUR REMOTE TO THE KEYPAD



- 1) Press and release the Program Button
- 2) Enter your 4 digit master pin
- 3) Press and release the Program Button
- 4) Enter 58
- 5) Press and release the Program Button
- 6) Press the bottom edge of the remote transmitter against the keypad below the send button as shown (needs to touch keypad)
- 7) **PRESS & HOLD THE  BUTTON ON THE REMOTE** until you hear 3 beeps, and then 2 beeps from the keypad

### STEP 3. MOUNT KEYPAD

Keypad can be mounted no further then 60' and has to be within site from the gate.

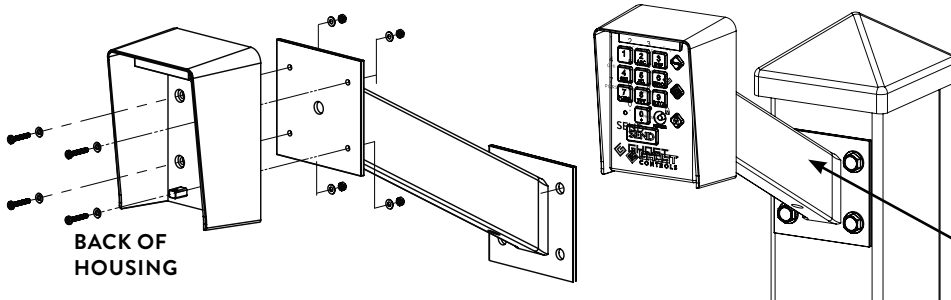

**OUTDOOR MOUNTING PEDESTAL (AXGN)**  
Accessory for mounting keypad to post

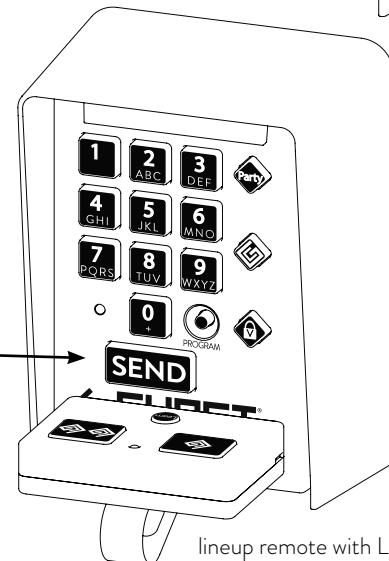
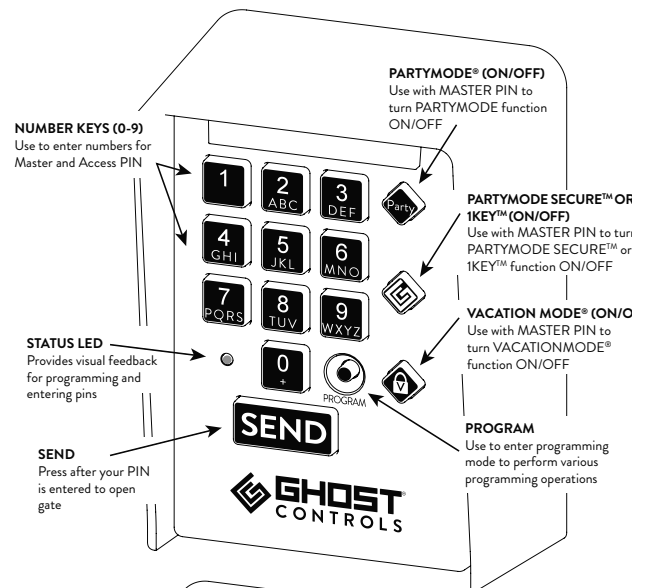

lineup remote with LEARN button facing keypad. Then touch remote to keypad as shown under the send button and press and hold the  to learn the remotes code

## PROGRAMMING ADDITIONAL GATE ACCESS PINS

### ADDING A GATE ACCESS PIN: USING YOUR NEW MASTER PIN (XXXX):



Press program button, master pin, program button, 2 2, program button, 4 digit access pin, program button | SUCCESS = hearing 3 beeps, pause, 2 beeps

### ADDING A TEMPORARY PIN (THIS TIME BASED PIN WILL NOT WORK AFTER “DD” DAYS):



Press program button, master pin, program button, 2 3, program button, 4 digit temporary pin, program button, dd = number of days of access to property, program button | SUCCESS = hearing 3 beeps, pause, 2 beeps

### ADDING A “USE” BASED TEMPORARY PIN (THIS USE BASED PIN WILL NOT WORK AFTER “UU” USES):



Press program button, master pin, program button, 2 8, program button, 4 digit temporary pin, program button, uu = number of uses for access and program button | SUCCESS = hearing 3 beeps, pause, 2 beeps

### DELETE AN ACCESS PIN (YOU CAN NO LONGER USE THIS PIN TO OPERATE GATE):



Press program button, master pin, program button, 3 2, program button, 4 digit access pin to delete, program button | SUCCESS = hearing 3 beeps, pause, 2 beeps

### REPLACE MASTER PIN (DO NOT GIVE OUT YOUR MASTER PIN TO ALLOW ACCESS):

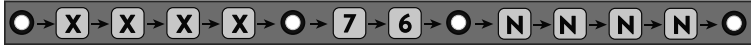

Press program button, master pin, program button, 7 6, program button, 4 digit new master pin and program button | SUCCESS = hearing 3 beeps, pause, 2 beeps

## ACTIVATE/DEACTIVATE SPECIAL FEATURES (CAN ONLY USE WITH MASTER PIN)

**PARTYMODE®** (keeps gate open to allow access to property for a set time) when you want to enable PartyMode® keep gate in open position and suspend gate's auto-close feature (if enabled), the gate opener will beep twice if there is an attempt to close the gate. This is to indicate that PartyMode® is enabled, therefore gate cannot be closed. Follow steps:



Press **PARTY** button, master pin and send | ACTIVATE SUCCESS = hearing 2 beeps from gate alarm | DEACTIVATE SUCCESS = hearing 3 beeps from gate alarm

**PARTYMODE SECURE® AND 1KEY®** (use any number button and send button to operate gate to allow access) when you want to enable PartyMode Secure® or 1key®, any number button and the send button will operate the gate without the need to enter an access pin. The button's green led will stay on when any button is pressed to indicate the keypad is in 1key® or PartyMode Secure®. Follow steps:



Press **1KEY** button, master pin and send | ACTIVATE SUCCESS = **1KEY** stays lit for 30 sec. | DEACTIVATE SUCCESS = **1KEY** light goes out

**VACATIONMODE®** (keeps gate closed no access to property) when you want to enable VacationMode® to keep gate in closed position (gate has to be closed to set). Gate will beep twice if there is an attempt to open the gate. This is to indicate that VacationMode® is enabled and the gate can not be opened. Follow steps:



Press **VACATION** button, master pin and send | ACTIVATE SUCCESS = hearing 2 beeps from gate alarm DEACTIVATE SUCCESS = hearing 3 beeps from gate alarm

## RESTORING YOUR KEYPAD BACK TO FACTORY DEFAULT

- 1) Remove one of the “C” batteries from the back of the keypad for 15 seconds
- 2) Reinstall the “C” battery and immediately press and release the program button 3 times
- 3) If successful, keypad will beep 3 long beeps followed by 2 short beeps
- 4) If unsuccessful, repeat the above steps

### WARNING

Changes or modifications to this unit not expressly approved by the party responsible for compliance could void the user's authority to operate the equipment.

**NOTE:** This equipment has been tested and found to comply with the limits for a Class B digital device, pursuant to Part 15 of the FCC Rules. These limits are designed to provide reasonable protection against harmful interference in a residential installation. This equipment generates, uses and can radiate radio frequency energy and, if not installed and used in accordance with the instructions, may cause harmful interference to radio communications. However, there is no guarantee that interference will not occur in a particular installation.



**WARNING:** This product can expose you to chemicals including lead, which is known to the State of California to cause cancer. For more information, go to [www.P65Warnings.ca.gov](http://www.P65Warnings.ca.gov)



[www.GhostControls.com](http://www.GhostControls.com)

AXWKIM Made in China, Rev. 2018-08  
©2018 GHOST CONTROLS

## Free Manuals Download Website

<http://myh66.com>

<http://usermanuals.us>

<http://www.somanuals.com>

<http://www.4manuals.cc>

<http://www.manual-lib.com>

<http://www.404manual.com>

<http://www.luxmanual.com>

<http://aubethermostatmanual.com>

Golf course search by state

<http://golfingnear.com>

Email search by domain

<http://emailbydomain.com>

Auto manuals search

<http://auto.somanuals.com>

TV manuals search

<http://tv.somanuals.com>