



User Manual

Refrigerator-Freezer

A3FE737C*J

A3FE837C*J

C3FE835C*J

C3FE737C*J

C3FE837C*J

C3FE935C*J

*= Colour code:
M, W, S or R

GB

Haier

Thank you for purchasing a Haier Product.

Please read these instructions carefully before using this appliance. The instructions contain important information which will help you get the best out of the appliance and ensure safe and proper installation, use and maintenance.

Keep this manual in a convenient place so you can always refer to it for the safe and proper use of the appliance.

If you sell the appliance, give it away, or leave it behind when you move house, make sure you also pass this manual so that the new owner can become familiar with the appliance and safety warnings.



Legend

Warning – Important Safety information



General information and tips



Environmental information

Disposal



Help protect the environment and human health. Put the packaging in applicable containers to recycle it. Help to recycle waste of electrical and electronic appliances. Do not dispose appliances marked with this symbol with the household waste. Return the product to your local recycling facility or contact your municipal office.



WARNING!

Risk of injury or suffocation!

Refrigerants and gases must be disposed of professionally. Ensure that the tubing of the refrigerant circuit is not damaged before being properly disposed of. Disconnect the appliance from the mains supply. Cut off the mains cable and dispose of it. Remove the trays and drawers as well as the door catch and seals, to prevent children and pets to get closed in the appliance.

1- Safety information.....	4
2- Intended use	8
3- Product description	9
4- Control panel.....	11
5- Use.....	12
6- Energy saving tips	19
7- Equipment	20
8- Care and Cleaning.....	24
9- Troubleshooting.....	27
10- Installation.....	30
11- Technical Data.....	34
12- Customer Service	36

Before switching on the appliance for the first time read the following safety hints!:



WARNING!

Before first use

- ▶ Make sure there is no transport damage.
- ▶ Remove all packaging and keep out of children's reach.
- ▶ Wait at least two hours before installing the appliance in order to ensure the refrigerant circuit is fully efficient.
- ▶ Handle the appliance always with at least two persons because it is heavy.

Installation

- ▶ The appliance should be placed in a well-ventilated place. Ensure a space of at least 20 cm above and 10 cm around the appliance.
- ▶ Never place the appliance in a damp area or location where it might be splashed with water. Clean and dry water splashes and stains with a soft clean cloth.
- ▶ Do not install the appliance in direct sunlight or in the near of heat sources (e.g. stoves, heaters).
- ▶ Install and level the appliance in an area suitable for its size and use.
- ▶ Keep ventilation openings in the appliance or in the in-built structure clear of obstruction.
- ▶ Make sure that the electrical information on the rating plate agrees with the power supply. If it does not, contact an electrician.
- ▶ The appliance is operated by a 220-240 VAC/50 Hz power supply. Abnormal voltage fluctuation may cause the appliance to fail to start, or damage to the temperature control or compressor, or there may be an abnormal noise when operating. In such case, an automatic regulator shall be mounted.
- ▶ Use a separate earthed socket for the power supply which is easy accessible. The appliance must be earthed.
- ▶ **Only for UK:** The appliance's power cable is fitted with 3-cord (grounding) plug that fits a standard 3-cord (grounded) socket. Never cut off or dismount the third pin (grounding). After the appliance is installed, the plug should be accessible.
- ▶ Do not use multi-plug adapters and extension cables.
- ▶ Ensure that the power cable is not trapped by the refrigerator. Do not step on the power cable.
- ▶ Do not damage the refrigerant circuit.

**WARNING!****Daily use**

- ▶ This appliance can be used by children aged from 8 years and above and persons with reduced physical, sensory or mental capabilities or lack of experience and knowledge if they have been given supervision or instruction concerning use of the appliance in a safe way and understand the hazards involved.
- ▶ Keep away children under 3 years of age from the appliance unless they are constantly supervised.
- ▶ Children shall not play with the appliance.
- ▶ If cool gas or other inflammable gas is leaking in the vicinity of the appliance, turn off the valve of the leaking gas, open the doors and windows and do not unplug a plug in the power cable of the refrigerator or any other appliance.
- ▶ Notice that the appliance is set for operation at a specific ambient range between 10 and 43°C. The appliance may not work properly if it is left for a long period at a temperature above or below the indicated range.
- ▶ Do not place unstable articles (heavy objects, containers filled with water) on top of the refrigerator, to avoid personal injury caused by falling or electric shock caused by contact with water.
- ▶ Do not pull on the door shelves. The door may be pulled slant, the bottle rack, may be pulled away, or the appliance may topple.
- ▶ Open and close the doors only with the handles. The gap between the doors and between the doors and the cabinet is very narrow. Do not extend your hands in these areas to avoid pinching your fingers. Open or close the refrigerator doors only when there are no children standing within the range of door movement.
- ▶ Do not store or use inflammable, explosive or corrosive materials in the appliance or in the vicinity.
- ▶ Do not store medicines, bacteria or chemical agents in the appliance. This appliance is a household appliance. It is not recommended to store materials that require strict temperatures.
- ▶ Never store liquids in bottles or cans (besides high percentage spirits) especially carbonated beverages in the freezer, as these will burst during freezing.
- ▶ Check the condition of food if a warming in the freezer has taken place.



WARNING!

Daily use

- ▶ Do not set unnecessarily low temperature in the refrigerator compartment. Minus temperatures may occur at high settings. Attention: Bottles can burst.
- ▶ Do not touch frozen goods with wet hands (wear gloves). Especially do not eat ice lollies immediately after removal from the freezer compartment. There is the risk to freeze or the formation of frost blisters. FIRST aid: keep immediately under running cold water. Do not pull away!
- ▶ Do not touch the inside surface of the freezer storage compartment when in operation, especially with wet hands, as your hands may freeze onto the surface.
- ▶ Unplug the appliance in the event of a power interruption or before cleaning. Allow at least 5 minutes before restarting the appliance, as frequent starting may damage the compressor.
- ▶ Do not use electrical devices inside the food storage compartments of the appliance, unless they are of the type recommended by the manufacturer.

Maintenance / cleaning

- ▶ Make sure children are supervised if they carry out cleaning and maintenance.
- ▶ Disconnect the appliance from the electrical supply before undertaking any routine maintenance. Allow at least 5 minutes before restarting the appliance, as frequent starting may damage the compressor.
- ▶ Hold the plug, not the cable, when unplugging the appliance.
- ▶ Do not scrape off frost and ice with sharp objects. Do not use sprays, electric heaters like heater, hair dryer, steam cleaners or other sources of heat in order to avoid damage to the plastic parts.
- ▶ Do not use mechanical devices or other means to accelerate the defrosting process, other than those recommended by the manufacturer.
- ▶ If the supply cord is damaged, it must be replaced by the manufacturer, its service agent or similarly qualified persons in order to avoid a hazard.

**WARNING!****Maintenance / cleaning**

- ▶ Do not try to repair, disassemble or modify the appliance by yourself. In case of repair please contact our customer service.
- ▶ Eliminate the dust on the back of the unit at least once in the year to avoid hazard by fire, as well as increased energy consumption.
- ▶ Do not spray or flush the appliance during cleaning.
- ▶ Do not use water spray or steam to clean the appliance.
- ▶ Do not clean the cold glass shelves with hot water. Sudden temperature change may cause the glass to break.

Refrigerant gas information**WARNING!**

The appliance contains the flammable refrigerant ISOBUTANE (R600a). Make sure the refrigerant circuit is not damaged during transportation or installation. Leaking refrigerant may cause eye injuries or ignite. If a damage has occurred, keep away open fire sources, thoroughly ventilate the room, do **not** plug or unplug the power cords of the appliance or any other appliance. Inform the customer service.

In case of eyes get into contact with the refrigerant, rinse immediately it under running water and call immediately the eye specialist.

**WARNING!**

- ▶ Taking care to avoid causing a fire by igniting flammable material.
- ▶ **WARNING:** When positioning the appliance, ensure the supply cord is not trapped or damaged.
- ▶ **WARNING:** Do not locate multiple portable socket-outlets or portable power supplies at the rear of the appliance.

2.1 Intended use

This appliance is intended for cooling and freezing food. It has been designed exclusively for use in dry-interior house-holds. It is not intended for commercial or industrial use.

Changes or modifications to the device are not allowed. Unintended use may cause hazards and loss of warranty claims.

2.2 Accessories

Check the accessories and literature in accordance with this list (Fig.:2.2):



1) Model with one door: A3FE737C*J, A3FE837*J

2) Models with two doors: C3FE737C*J, C3FE835C*J, C3FE837C*J, C3FE935C*J

3) One piece for model with one door, two pieces for model with two doors

*= Colour code



Notice: Differences

Due to technical changes and different models, some of the illustrations in this manual may differ from your model.

Pictures of appliances (Fig. 3.1-3.2)

A: Refrigerator compartment

- 1 Dynamic ABT
- 2 Air duct and sensor (behind panel)
- 3 Refrigerator LED lamp
- 4 Glass shelves
- 5 Rating plate
- 6 O.K. -temperature indicator (optional)
- 7 MyZone box cover
- 8 Air duct (behind drawer)
- 9 MyZone box
- 10 Moist Zone box cover
- 11 Moist Zone box
- 12 Door rack

B: Freezer compartment

- 13 Fan shield
- 14 Upper Freeze Box
- 15 Middle Freeze Box
- 16 Lower Freeze Box
- 17 Adjustable feet
- 18 Fresher Pad

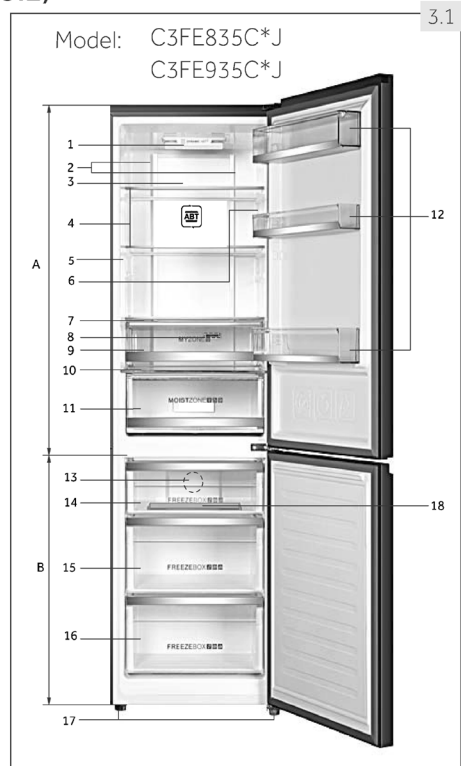

*= Colour code

3- Product description

GB

3.2

Model C3FE737C*J

C3FE837C*J

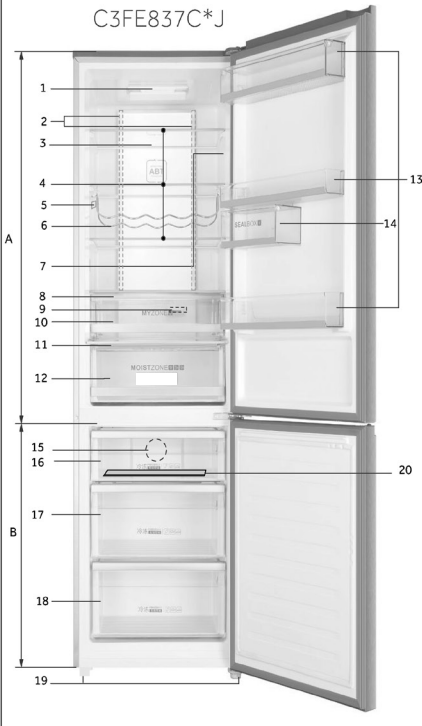

Model A3FE737C*J

A3FE837C*J

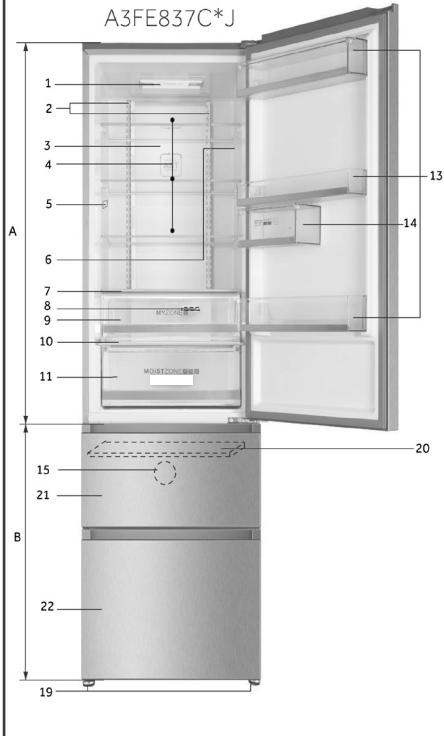

A: Refrigerator compartment

- 1 Dynamic ABT
- 2 Air duct and sensor (behind panel)
- 3 Refrigerator LED lamp
- 4 Glass shelves
- 5 Rating plate
- 6 Bottle rack
- 7 O.K.-temperature indicator (optional)
- 8 MyZone box cover
- 9 Air duct (behind drawer)
- 10 MyZone box
- 11 Moist Zone box cover
- 12 Moist Zone box
- 13 Door rack
- 14 Sealed box

B: Freezer compartment

- 15 Fan shield
- 16 Upper Freeze Box
- 17 Middle Freeze Box
- 18 Lower Freeze Box
- 19 Adjustable feet
- 20 Fresher Pad
- 21 Upper freezer storage drawer with prefreezing rack
- 22 Lower freezer storage drawer with prefreezing rack

* = Colour code

Control panel (Fig. 4)

Keys:

- A Fridge temperature setting
- B MyZone setting
- C Freezer temperature setting
- D Fuzzy mode and Holiday function on/off
- E Super-Cool function on/off
- F Super-Freeze function on/off
- G Panel lock/unlock

Indicators:

- a Temperature fridge compartment
- b My Zone function
- c Temperature freezer compartment
- d1 Fuzzy mode
- d2 Holiday function
- e Super-Cool function
- f Super-Freeze function
- g Panel lock

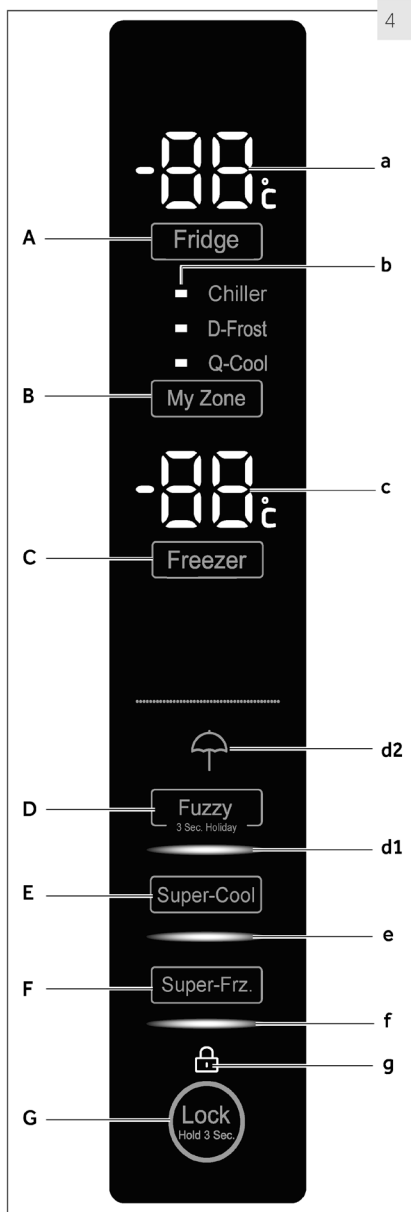

5.1 Before first use

- ▶ Remove all packaging materials, keep them out of children`s reach and dispose them in an environmentally friendly manner.
- ▶ Clean the inside and outside of the appliance as well as the interior and accessories with water and a mild detergent and dry it well with soft cloth.
- ▶ After the appliance has been levelled and cleaned, wait for at least 2 hours before connecting it to the power supply. See Section INSTALLATION.
- ▶ Precool the compartments at high settings before loading with food. The functions Super-Freeze and Super-Cool help to cool down the compartments quickly.
- ▶ The refrigerator temperature and freezer temperature are automatically set to 5° C and -18° C respectively. These are the recommended settings. If desired, you can change these temperatures manually. Please see ADJUST THE TEMPERATURE.

5.2 Sensor keys

The buttons on the control panel are sensor keys, which already respond when lightly touched with the finger.

5.3 Switch on /off the appliance

The appliance is in operation as soon as it is connected to the power supply.

When the appliance is powered on for the first time, temperature indicators "a" and "b1" show the presetting values (refer to NOTICE).



Notice: Presettings

- ▶ The appliance is preset to the recommended temperature of 5°C (refrigerator) and - 18°C (freezer). Under normal ambient condition you need not to set a temperature.
- ▶ The presetting function for the My Zone compartment is Chiller.
- ▶ When the appliance is switched on after disconnection from the main power supply, it may take up to 12 hours for the correct temperatures to be reached.

Empty the appliance before switching off. To switch off the appliance, pull the power cord out off the power socket.

5.4 Standby-mode

The display screen turns off automatically 30 seconds after pressing a key. The display will be automatically locked. It lights up automatically by touching any key or opening the door .

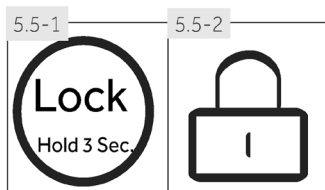

5.5 Lock/unlock panel



Notice: Panel lock

The control panel is automatically blocked against activation if 30 seconds no key is touched. For any settings the control panel must be unlocked.

- ▶ Touch key "G" for 3 seconds to block all panel elements against activation (Fig. 5.5-1).
- ▶ The related indicator "g" is now displayed (Fig. 5.5-2).
- ▶ For unlocking touch again the key.

5.6 Door opening alarm

When the refrigerator door is opened for more than 3 minutes, the door opening alarm will sound (Fig. 5.6). The alarm can be silenced by closing the door. If the door is left open for more than 7 minutes, the light inside the refrigerator and control panel illumination will automatically switch off.

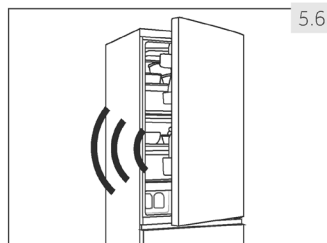

5.7 Select the working mode

One of the following options can be selected:

5.7.1 Fuzzy mode

If you do not have any special requirements, we recommend that you use fuzzy mode :

In the Fuzzy mode, the appliance can automatically adjust the temperature setting according to the ambient temperature and temperature change in the appliance. This function is totally hand free.

1. Unlock the panel by touching key "G" if it is locked (Fig. 5.5-1).
2. Touch key "D" (Fuzzy) (Fig. 5.7.1-1).
3. Indicator "d1" illuminates and the function is activated (Fig. 5.7.1-2).

By repeating the above steps or selecting an other function this function can be switched off again.

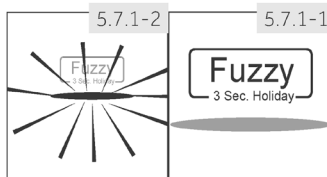

5.7.2 Manual adjusting mode

If you want to manually adjust the temperature of the appliance in order to store a particular food, you can set the temperature via a temperature adjusting key:



Notice: Conflict with other functions

The temperature cannot be adjusted, if any other function (Super-Cool, Super-Freeze, Holiday or Fuzzy) is activated or the display is locked. The corresponding indicator will flash accompanying with a buzzer.

5.7.2.1 Adjust the temperature for fridge

1. Unlock the panel by touching key "G" if it is locked (Fig. 5.5-1).
2. Touch key "A" (Fridge) to select the fridge compartment. The actual temperature in the fridge compartment is displayed (Fig. 5.7.2-1).
3. Touch sequentially key "A" (Fridge) until the desired value of temperature is flashing (Fig. 5.7.2-2). A signal will sound at each key touch. The temperature increases in sequences of 1°C from a minimum of 2°C to a maximum of 8°C. The optimum temperature in the fridge is 5 °C. Colder temperatures mean unnecessary energy consumption.

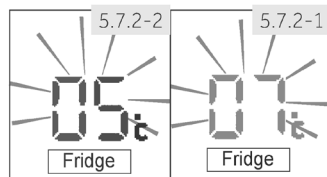

4. Touch any key except „A“ (Fridge) to confirm, or the setting confirms automatically after 5 seconds. Displayed temperature stops flashing.

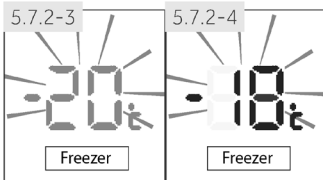

5.7.2.2 Adjust the temperature for freezer

1. Unlock the panel by touching key "G" if it is locked (Fig. 5.5-1).
2. Touch key "B" (Freezer) to select the freezer compartment. The actual temperature in the freezer compartment is displayed (Fig. 5.7.2-3).
3. Touch sequentially key "B" (Freezer) until the desired value of temperature is flashing (Fig. 5.7.2-4). A signal will sound at each key press. The temperature increases in sequences of 1°C from -16°C to -24°C. The optimum temperature in the freezer is -18°C. Colder temperatures mean unnecessary energy consumption.
4. Touch any key except „B“ (Freezer) to confirm, or the setting confirms automatically after 5 seconds. Displayed temperature stops flashing.



Notice: Influences on temperatures

The indoor temperatures are influenced by the following factors:

- ▶ Ambient temperature
- ▶ Frequency of door opening
- ▶ Amount of stored foods
- ▶ Installation of the appliance

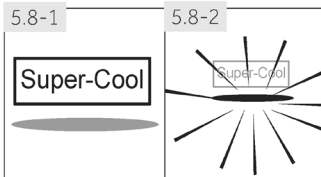

5.8 Super-Cool function

Switch on the Super-Cool function if larger quantity of food should be stored (for example after the purchase). The Super-Cool function accelerates the cooling of fresh food and protects the goods already stored from undesirable warming. The factory setting temperature is 0 to +1°C.

1. Unlock the panel by touching key "G" if it is locked (Fig. 5.5-1).
2. Touch key "E" (Super-Cool) (Fig. 5.8.-1).
3. Indicator "e" illuminates and the function is activated (Fig. 5.8.-2).

By repeating the above steps or selecting another function this function can be switched off again.



Notice: Automatically switch off

This function will be automatically disabled after 3 hours.

5.9 Super-Freeze function

Fresh food should be frozen as quickly as possible to the core. This preserved the best nutritional value, appearance and taste. The Super-Freeze function accelerates the freezing of fresh food and protects the goods already stored from undesirable warming. If you need to freeze a large amount of food once, it is recommended to set the Super-Freeze function on ahead for 24h before the usage of frozen room. The factory setting temperature is -24°C .

1. Unlock the panel by touching key "G" if it is locked (Fig. 5.5-1).
2. Touch key "F" (Super-Freeze) (Fig. 5.9.-1).
3. Indicator "F" illuminates and the function is activated (Fig. 5.9.-2).

By repeating the above steps or selecting an other function this function can be switched off again.

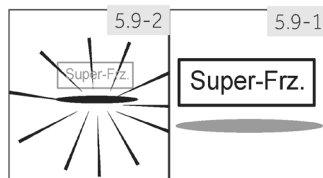

Notice: Automatically switch off

The Super-Freeze function will automatically switch off after 56 hours. The appliance is then operated at the previously set temperature.

5.10 Holiday function

This function sets the fridge temperature permanently to 17°C .

This allows to keep the door of the empty fridge closed without causing an odour or mold - during a long absence (e.g. during holiday). The freezer compartment is free for your setting.

1. Unlock the panel by touching key "G" if it is locked (Fig. 5.5-1).
2. Touch key "D" (Fuzzy) for 3 seconds Fig. 5.10). Indicator "d2" illuminates and the function is activated.

By repeating the above steps or selecting an other function this function can be switched off again.



WARNING!

During the Holiday function no goods must be stored in the refrigerator compartment. The temperature of $+17^{\circ}\text{C}$ is too high for storing food.

5.11 MyZone box

The fridge compartment is equipped with a MyZone box. In accordance with the food's storage demands, the most suitable temperature can be selected to get the optimal nutritional value of the foods. Following modes are available:

5.11.1 Chiller

This function sets the temperature in the MyZone box to 0 °C. Suitable to store of fresh food such as meat or instant products. Most foods stay fresh at 0 °C, but not frozen.

Notice: Chiller

- ▶ Due to different water contents of meat, some meat with more moisture will be frozen at temperatures lower than 0 °C. So "immediately cut" meat should be stored in My-Zone box, with temperatures min. 0°C.
- ▶ Cold-sensitive fruits like pineapple, avocado, bananas, grapefruits and vegetables such as potatoes, aubergines, beans, cucumbers, zucchini and tomatoes and cheese should not be stored in the My Zone box .
- ▶ When you chose "Chiller" set the temperature of the refrigerating compartment in the middle level (5°C), in order to preserve your food in the optimal storage environment.

5.11.2 D-Frost (Defrost)

This function allows to defrost frozen food without liquid residues on the food after defrosting. It will leave the food partly frozen, convenient for cutting and cooking.

The temperature in MyZone compartment is set to + 1 °C.

Notice: D-Frost

Defrosting time may vary according to size and thickness of the food. Following values can be used for defrosting: 500 g: 7 h; 1000 g: 8 h, 1500 g: 10 h.

5.11.3 Q-Cool (Quick-Cool)

This function allows to quick cool canned beverages in a short time. Please take out any bottles before activating this function, they might become frozen.

The temperature in MyZone compartment is set to -1 °C.

Notice: MyZone box

- ▶ One of the three functions of the My Zone compartment must always be activated
- ▶ To reduce the refrigerator compartment temperature use the Q-Cool function. To increase it, use the D-Frost-function.

5.11.4

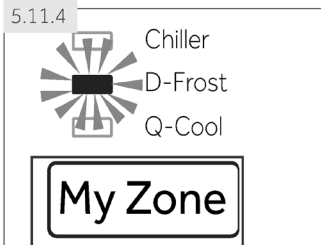

5.11.4 Select function for MyZone box

1. Unlock the panel by touching key "G" if it is locked (Fig. 5.5-1)
2. Touch sequentially "B" (MyZone) until the desired function "b" is flashing (Fig. 5.11.4).
3. After a few seconds indicator "b" will shine permanently and the setting is confirmed.

5.12 Tips on storing fresh food

5.12.1 Storing into the refrigerator compartment

- ▶ Keep your fridge temperature below 5°C.
- ▶ Hot food must be cooled to room temperature before storing in the appliance.
- ▶ Foods stored in the refrigerator should be washed and dried before storing
- ▶ Food to be stored should be properly sealed to avoid odour or taste alterations.
- ▶ Do not store excessive quantities of food. Leave spaces between foods to allow cold air flowing around them, for a better and more homogeneous cooling.
- ▶ Foods eaten daily should be stored at the front of the shelf.
- ▶ Leave a gap between foods and the inner walls, allowing air flowing. In special way don't store foods against the rear wall: foods could freeze against rear wall. Avoid direct contact of food (especially oily or acidic food) with the inner liner, as oil/acid can erode the inner liner. Clean away oily/acid dirt whenever it is found.
- ▶ Frozen food can be gently defrosted in the refrigerator compartment or with D-Frost function in the MyZone box. This saves energy.
- ▶ The ageing process of fruit and vegetables such as courgettes, melons, papaya, banana, pineapple, etc. can be accelerated in the refrigerator. Therefore, it is not advisable to store them in the refrigerator. However, the ripening of strongly green fruits can be promoted for a certain period. Onions, garlic, ginger and other root vegetables should also be stored at room temperature.
- ▶ Unpleasant odours inside the fridge are a sign that something has spilled and cleaning is required. See CARE AND CLEANING.
- ▶ Different foods should be placed in different areas according to their properties (Fig.: 5.12.1).

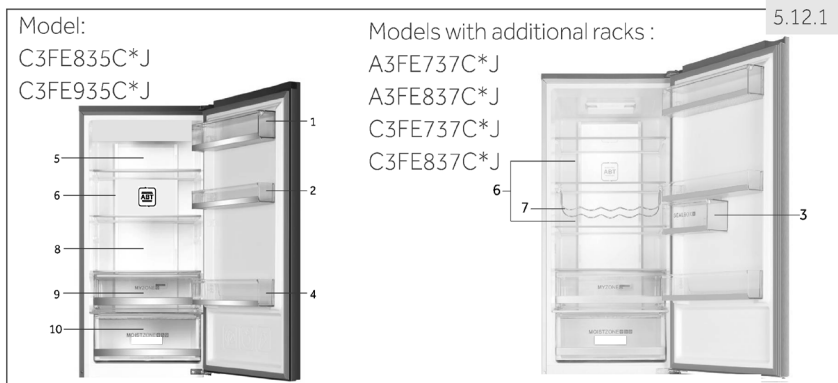

- | | |
|--|--|
| 1 Butter, cheese, eggs, spices, etc. | 7 Wine, champagne, etc. |
| 2 Eggs, canned food, spices, etc. | 8 Cooked meat, sausages, etc. |
| 3 Jam, cheese, tomato sauce, etc. | 9 MyZone box: canned beverages (Q-Cool), raw fresh food (Chiller), all frozen food which should be defrost (D-Frost) |
| 4 Drinks and bottled foods. | 10 Moist Zone box: Fruit, vegetables, salad, etc. |
| 5 Pickled foods, canned food, etc. | |
| 6 Meat products, snack foods, pasta, milk, tofu, dairy, etc. | |

5.12.2 Storage into the freezer compartment

- ▶ Keep the freezer temperature at -18°C.
- ▶ 24 hours before freezing switch on the Super-Freeze function; -for small quantities of food 4-6 hours are sufficient.
- ▶ Hot food must be cooled to room temperature before storing in the freezer compartment.
- ▶ Food cut into small portions will freeze faster and be easier to defrost and cook. The recommended weight for each portion is less than 2.5 kg
- ▶ It is better to pack food before putting it into the freezer. The outside of the packaging must be dry to avoid bags sticking together. Packaging materials should be odour-free, airtight, non-poisonous and nontoxic.
- ▶ In order to avoid expiration of storage periods, please note the freezing date, time limit and name of the food on the packaging according to the storage periods of different foods.
- ▶ **WARNING!:** Acid, alkali and salt etc. could erode the internal surface of the freezer. Do not place the food having these substances (e.g. sea fish) directly on the internal surface. Salt water in the freezer should be cleaned up immediately.
- ▶ Do not exceed the food storage times recommended by the manufacturers. Only take the required amount of food out of the freezer.
- ▶ Consume defrosted food quickly. Defrosted food cannot be re-frozen unless it is first cooked, otherwise it may be less edible.
- ▶ Do not load excessive quantities of fresh food in the freezer compartment. Refer to the freezing capacity of the freezer – See TECHNICAL DATA or data at the type plate.
- ▶ Food can be stored in the freezer at a temperature of at least -18°C for 2 to 12 months, depending on its properties (e.g., meat: 3-12 months, vegetables: 6-12 months)
- ▶ When freezing fresh food, avoid bringing it in contact with already frozen food. Risk of thawing!

When storing commercially frozen foods, please follow these guidelines:

- ▶ Always follow manufacturers' guidelines for the length of time you should store food for. Do not exceed these guidelines!
- ▶ Try to keep the length of time between purchase and storage as short as possible to preserve food quality.
- ▶ Buy frozen foods, which have been stored at a temperature of -18°C or below.
- ▶ Avoid buying food which has ice or frost on the packaging – This indicates that the products might have been partially defrosted and refrozen at some point – temperature rises affect the quality of food.



Energy saving tips

- ▶ Make sure the appliance is properly ventilated (see INSTALLATION).
- ▶ Do not install the appliance in direct sunlight or in the near of heat sources (e.g. stoves, heaters).
- ▶ Avoid unnecessarily low temperature in the appliance. The energy consumption increases the lower the temperature in the appliance is set.
- ▶ Functions like SUPER-FREEZE consume more energy.
- ▶ Allow warm food to cool down before placing it in the appliance.
- ▶ Open the appliance door as little and as briefly as possible.
- ▶ Do not overfill the appliance to avoid obstructing the air flow.
- ▶ Avoid air within the food packaging.
- ▶ Keep door seals clean so that the door always closes correctly.
- ▶ Defreeze frozen food in the fridge storage compartment or use the D-Frost function in the MyZone box.



Notice: Differences depending on model

Due to different models, your product may not have all of the following features. Please refer to chapter PRODUCT DESCRIPTION.

7.1

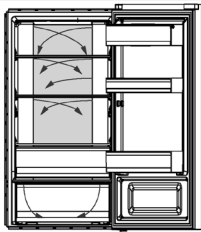

7.1 Multi-air-flow

The refrigerator is equipped with a multi-air-flow system, with which cool air flows are located on every shelf level (Fig. 7.1). This helps to maintain a uniform temperature to ensure that your food is kept fresher for longer.

7.2

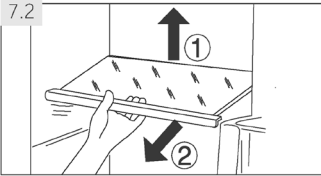

7.2 Adjustable shelves

The height of the shelves can be adjusted to fit your storage needs.

1. To relocate a shelf, remove it first by uplifting its hind edge (1) and pulling it out (2) (Fig. 7.2).
2. To reinstall it, put it on the lugs on both sides and push it to the most rearward position until the rear of the shelf is fixed inside the slots in the sides



Notice: Shelves

Ensure that all ends of a shelf are level.

7.3-1



7.3 Foldable bottle rack

For normal use:

1. Pull down the brackets of the bottle rack (Fig. 7.3-1).
2. Fit the bottles into the rack (Fig. 7.3-2).

When not in use, the bottle rack can be folded back in order to save space..

7.3-2

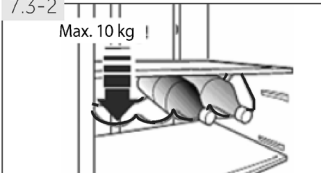

WARNING!

Make sure the total weight of the bottles does not exceed 10 kg.

7.4 Removable door racks

The door racks can be removed for cleaning:

Place hands on each side of the rack, lift it upwards (1) and pull it out (2) (Fig. 7.4).

In order to insert the door rack, the above steps are carried out in reverse order.

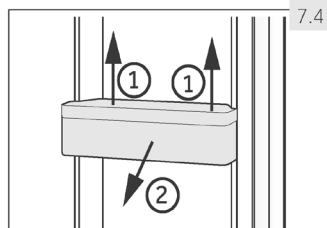

7.5 Sealed box

It is used for storage small parts like jam, cheese, tomato paste, etc.

The seal box (Fig. 7.5) shouldn't be opened more than 120°, as doing so might damage the seal box

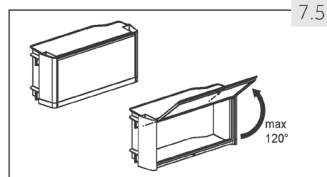

WARNING!

Do not store things that need precision storage temperature such as medicine and food therapy articles, to prevent them deteriorating

7.6 My Zone box

For use and setting of the My Zone compartment (Fig. 7.6) please check section USE (MyZone box).

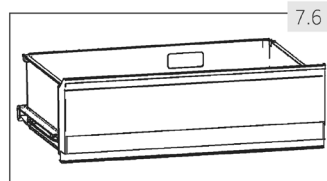

7.7 Moist Zone box

In this compartment (Fig. 7.7) the humidity level is around 90%. It is controlled automatically by the system and is suitable to store fruits, vegetables, salads etc.

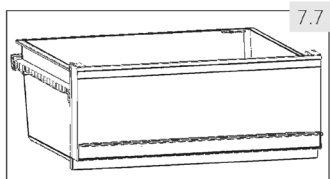

7.8 OK-temperature indicator

The OK-temperature (Fig. 7.8) indicator can be used to determine temperatures below +4°C. Gradually reduce the temperature if the sign does not indicate "OK".

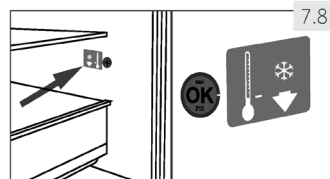

Notice:OK-sticker

When the appliance is switched on, it may take up to 12 hours for the correct temperatures to be reached.

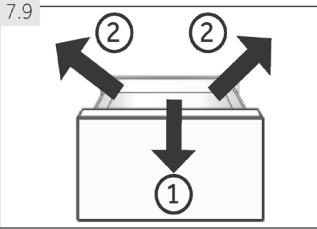

7.9 Removable freezer drawer

To remove the drawer out, pull out to the maximum extent (1), lift and remove (2) (Fig. 7.9).

In order to insert the drawer, the above steps are carried out in reverse order.

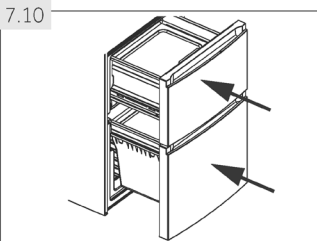

7.10 3D-freezer drawer

The freezer drawers (Fig. 7.10) can be extended straightly and completely. They are mounted on easy-roll telescopic runners, so that you can store and remove the freezing good comfortable. Because of the automatic door closing mechanism the handling is easy and you save energy.



WARNING!

Do not overload the drawers: Max. load of each drawer: 35 kg!.

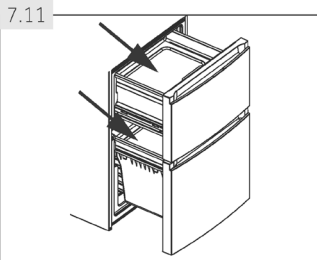

7.11 Pre-freezing rack

Each freezer drawer is equipped with a pre-freezing rack (Fig. 7.11). Fresh frozen food can be separated from already frozen, so that a smooth freezing process can take place and freezing food will not defrosted. After rearrangement of frozen food these compartments can be used for easy storage of small parts such as herbals, ice cream or for the ice cube tray.



7.12 Fresher Pad

The Fresher Pad (Fig. 7.12) can be used for:

1. Quick freezing

By using the Fresher Pad in the freezer compartment, food put on this pad will be frozen three times faster than in ordinary freezer. The zone of maximum ice crystal formation will be minimized; the quality of food will be saved:

- ▶ Put the Fresher Pad in the upper freezer drawer in the respective hole and place the food on the side printed with "Fresher Pad".

2. Quick thawing

By using the Fresher Pad outside the appliance food will be thawed five times faster than without pad because:

- ▶ allow the Fresher Pad to cool down at ambient temperature and put it on a flat surface outside the appliance. Place the food on the side printed with "Fresher Pad".



Notice: Fresher Pad

- ▶ Do not touch the aluminium part of the Fresher Pad when using it in the freezer compartment. Your hands may freeze onto the surface. Wear gloves.
- ▶ Please keep the fresher pad dry when you put it into the freezer.

7.13 Ice cube tray

1. Fill the ice cube tray 3/4 full of water, be careful not to exceed the water level line (A) (Fig. 7.13-1). Close the tray with the cover and put it into one of the freezer storage drawer.
2. Twist the ice cube tray slightly or hold it under flowing water to loosen the ice cubes (Fig. 7.13-2).

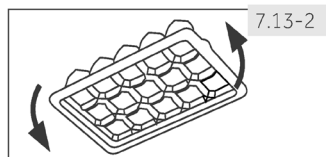
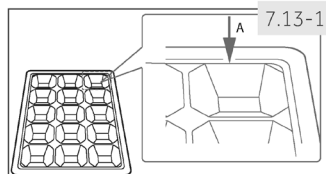

7.14 The Light

The LED interior light comes on when the door is opened. The performance of the lights is not affected by any of the appliances other settings.

7.15 Special features

Some models are equipped with following additional special features (see section PRODUCT DESCRIPTION):

7.15.1 Dynamic ABT

This feature sterilizes the refrigerator compartment; the compartment will be cleaned and deodorized.

7.15.2 Fan shield

The fan shield behind the back wall of the freezer compartment reduces effectively the temperature fluctuations in the freezer and prevents ice formation. This is conducive to food preservation and saves energy.



WARNING!

Disconnect the appliance from the power supply before cleaning.

8.1 General

Clean the appliance when only little or no food is stored.

The appliance should be cleaned every four weeks for good maintenance and to prevent bad stored food odours.



WARNING!

- ▶ Do not clean the appliance with hard brushes, wire brushes, detergent powder, petrol, amyl acetate, acetone and similar organic solutions, acid or alkaline solutions. Please clean with special refrigerator detergent to avoid damage.
- ▶ Do not spray or flush the appliance during cleaning.
- ▶ Do not use water spray or steam to clean the appliance.
- ▶ Do not clean the cold glass shelves with hot water. Sudden temperature change may cause the glass to break .
- ▶ Do not touch the inside surface of the freezer storage compartment, especially with wet hands, as your hands may freeze onto the surface.
- ▶ In case of heating check the condition of frozen goods.

8.1

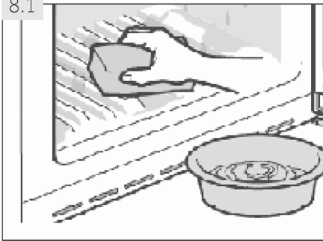

- ▶ Always keep the door gasket clean.
- ▶ Clean the inside and housing of the appliance with a sponge dampened in warm water and neutral detergent (Fig. 8.1).
- ▶ Rinse and dry with soft cloth.
- ▶ Clean the accessories only with warm water and neutral detergent.
- ▶ Do not clean any of the parts of the appliance in a dishwasher.
- ▶ Allow at least 5 minutes before restarting the appliance as frequent starting may damage the compressor.

8.2 Defrosting

The defrosting of the refrigerator and the freezer compartment are done automatically; no manual operation is needed.

8.3 Replacing the LED-lamps



WARNING!

Do not replace the LED lamp yourself, it must only be replaced by either the manufacturer or the authorised service agent.

The lamp adopts LED as its light source, featuring low energy consumption and long service life. If there is any abnormality, please contact the customer service. See CUSTOMER SERVICE.

Parameters of the lamp:

Voltage in V	12
Max Power in W	10
Amount of light in lumen	400
LED Spec	white-2835
Usage temperature	-20°C to +55°C

8.4 Removable auxiliary door gaskets

There are six auxiliary door gaskets on the upper and lower freezer drawer.

1. Locate the five indicated door gaskets on the upper and lower freezer drawer (Fig. 8.4-1.).
2. Make sure the bent slices of the gaskets point inwards when attaching (Fig. 8.4-2.).
3. Locate the **lower** gasket of the upper drawer as indicated (Fig. 8.4-3.).
4. Make sure the bent slice of this gasket points downwards when attaching (Fig. 8.4-4.).

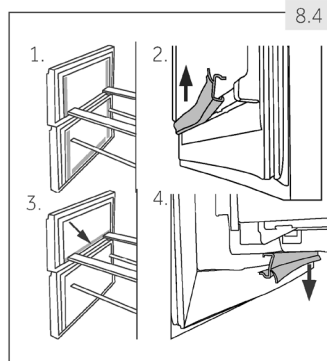

You get these gaskets as well as the revolving door / drawer gaskets via the customer service (see warranty card).

8.5 Non-use for a longer period

If the appliance is not used for an extended period of time:

- ▶ Take out the food.
- ▶ Unplug the power cord.
- ▶ Clean the appliance as described above.
- ▶ Keep the door and freezer drawers/door open to prevent the creation of bad odours inside.



Notice: Switch off

Turn the appliance off only if strictly necessary.

8.6 Moving the appliance

1. Remove all food and unplug the appliance.
2. Secure shelves and other moveable parts in the fridge and the freezer with adhesive tape.
3. Do not tilt the refrigerator more than 45° to avoid damaging the refrigerating system.



WARNING!

- ▶ Do not lift the appliance by its handles.
- ▶ Never place the appliance horizontally on the ground.

Many occurring problems could be solved by yourself without specific expertise. In case of a problem please check all shown possibilities and follow below instructions before you contact an after sales service. See CUSTOMER SERVICE.



WARNING!

- ▶ Before maintenance, deactivate the appliance and disconnect the mains plug from the mains socket.
- ▶ Electrical equipment should be serviced only by qualified electrical experts, because improper repairs can cause considerable consequential damages.
- ▶ A damaged supply should only be replaced by the manufacturer, its service agent or similarly qualified persons in order to avoid a hazard.

9.1 Troubleshooting table

Problem	Possible Cause	Possible Solution
The compressor does not work.	<ul style="list-style-type: none"> • Mains plug is not connected in the mains socket. • The appliance is in the defrosting cycle. 	<ul style="list-style-type: none"> • Connect the mains plug. • This is normal for an automatic defrosting.
The appliance runs frequently or runs for a too long period of time.	<ul style="list-style-type: none"> • The indoor or outdoor temperature is too high. • The appliance has been off power for a period of time. • A door/drawer of the appliance is not tightly closed. • The door/drawer has been opened too frequently or for too long. • The temperature setting for the freezer compartment is too low. • The door/drawer gasket is dirty, worn, cracked or mismatched. • The required air circulation is not guaranteed. 	<ul style="list-style-type: none"> • In this case, it is normal for the appliance to run longer. • Normally, it takes 8 to 12 hours for the appliance to cool down completely. • Close the door/drawer and ensure the appliance is located on a level ground and there is no food or container jarring the door. • Do not open the door/drawer too frequently. • Set the temperature higher until a satisfactory refrigerator temperature is obtained. It takes 24 hours for the refrigerator temperature to become stable. • Clean the door/drawer gasket or replace them by the customer service. • Ensure adequate ventilation.
The inside of the refrigerator is dirty and/or smells.	<ul style="list-style-type: none"> • The inside of the refrigerator needs cleaning. • Food of strong odour is stored in the refrigerator. 	<ul style="list-style-type: none"> • Clean the inside of the refrigerator. • Wrap the food thoroughly.

9- Troubleshooting

GB

Problem	Possible Cause	Possible Solution
It is not cold enough inside the appliance.	<ul style="list-style-type: none"> The temperature is set too high. Too warm goods has been stored. Too much food has been stored at one time. The goods are too close to each other. A door/drawer of the appliance is not tightly closed. The door/drawer has been opened too frequently or for too long. 	<ul style="list-style-type: none"> Reset the temperature. Always cool down goods before storing them. Always store small quantities of food. Leave a gap between several foods allowing air flowing. Close the door/drawer. Do not open the door/drawer too frequently.
It is too cold inside the appliance.	<ul style="list-style-type: none"> The temperature is set too low. The Power-Freezer function is activated or is running too long. 	<ul style="list-style-type: none"> Reset the temperature. Switch off the Power-Freezer function.
Moisture formation on the inside of the refrigerator compartment.	<ul style="list-style-type: none"> The climate is too warm and too damp. A door/drawer of the appliance is not tightly closed. The door/drawer has been opened too frequently or for too long. Food containers or liquids are left open. 	<ul style="list-style-type: none"> Increase the temperature. Close the door/drawer. Do not open the door/drawer too frequently. Let hot foods cool to room temperature and cover foods and liquids.
Moisture accumulates on the refrigerators outside surface or between the doors/door and drawer.	<ul style="list-style-type: none"> The climate is too warm and too damp. The door/drawer is not closed tightly. The cold air in the appliance and the warm air outside it condensates. 	<ul style="list-style-type: none"> This is normal in damp climate and will change when the humidity decreases. Ensure that the door/drawer is tightly shut.
Strong ice and frost in the freezer compartment.	<ul style="list-style-type: none"> The goods were not adequately packaged. A door/drawer of the appliance is not tightly closed. The door/drawer has been opened too frequently or for too long. The door/drawer gasket is dirty, worn, cracked or mismatched. Something on the inside prevents the door/drawer to close properly. 	<ul style="list-style-type: none"> Always pack the goods well. Close the door/drawer. Do not open the door/drawer too frequently. Clean the door/drawer gasket or replace them by new ones. Reposition the shelves, door racks, or internal containers to allow the door/drawer to close.
The appliance makes abnormal sounds.	<ul style="list-style-type: none"> The appliance is not located on level ground. The appliance touches some object around it. 	<ul style="list-style-type: none"> Adjust the feet to level the appliance. Remove objects around the appliance.

Problem	Possible Cause	Possible Solution
A slight sound is to be heard similar to that of flowing water.	<ul style="list-style-type: none"> This is normal. 	<ul style="list-style-type: none"> -
You will hear an alarm beep.	<ul style="list-style-type: none"> The fridge storage compartment door is open. 	<ul style="list-style-type: none"> Close the door or silence the alarm manually.
You will hear a faint hum.	<ul style="list-style-type: none"> The anti-condensation system is working. 	<ul style="list-style-type: none"> This prevents condensation and is normal.
The interior lighting or cooling system does not work.	<ul style="list-style-type: none"> Mains plug is not connected in the mains socket. The power supply is not intact. The LED-lamp is out of order. 	<ul style="list-style-type: none"> Connect the mains plug. Check the electrical supply to the room. Call the local electricity company! Please call the service for changing the lamp.
The sides of the cabinet and door strip get warm.	<ul style="list-style-type: none"> This is normal. 	<ul style="list-style-type: none"> -

9.2 Power interruption

In the event of a power cut, food should remain safely cold for about 13/14 hours (see section TECHNICAL DATA). Follow these tips during a prolonged power interruption, especially in summer:

- ▶ Open the door/drawer as few times as possible.
- ▶ Do not put additional food into the appliance during a power interruption.
- ▶ If prior notice of a power interruption is given and the interruption duration is longer than 13/14 hours, make some ice and put it in a container in the top of the refrigerator compartment.
- ▶ An inspection of the goods is required immediately after the interruption.
- ▶ As temperature in the refrigerator will rise during a power interruption or other failure, the storage period and edible quality of food will be reduced. Any food that defrosts should be either consumed, or cooked and refrozen (where suitable) soon afterwards in order to prevent health risks.



Notice: Memory function during power interruption

After restoration of power the appliance continues with the settings that were set before the power failure.

10.1 Unpacking



WARNING!

- ▶ The appliance is heavy. Always handle with at least two persons.
- ▶ Keep all packaging materials out of children's reach and dispose them in an environmentally friendly manner.
- ▶ Take the appliance out of the packaging.
- ▶ Remove all packaging materials.

10.2 Environmental conditions

The room temperature should always be between 10° C and 43° C, since it can influence the temperature inside the appliance and its energy consumption. Do not install the appliance near other heat-emitting appliances (ovens, refrigerators) without isolation.

10.3 Door reversibility

Before the appliance is permanently installed, check the correct position of the door hinge. If necessary see section the DOOR REVERSIBILITY.

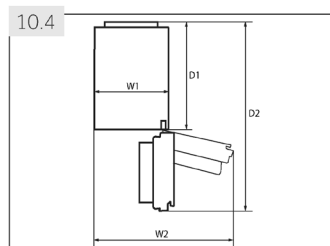

10.4 Space requirement

Required space when door is opened (Fig. 10.4):

Model	Appliance width in mm		Appliance depth in mm	
	W1	W2	D1	D2
A3FE-737C*J C3FE-737C*J	595	925	580	1200
C3FE-835C*J A3FE-837C*J C3FE-837C*J C3FE-935C*J	595	925	600	1220

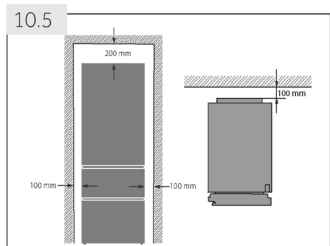

10.5 Ventilaton cross-section

To achieve sufficient ventilation of the appliance for safety reasons, the information of the required ventilation cross sections must be observed (Fig. 10.5).

10.6 Aligning the appliance

The appliance should be placed on a flat and solid surface.

1. Tilt the appliance slightly backwards (Fig. 10.6).
2. Set the feet to the desired level.
3. The stability can be checked by alternately bumping on the diagonals. The slightly swaying should be the same in both directions. Otherwise the frame can warp; possible leaking door seals are the result. A low tendency to the rear facilitates the closing of the door.

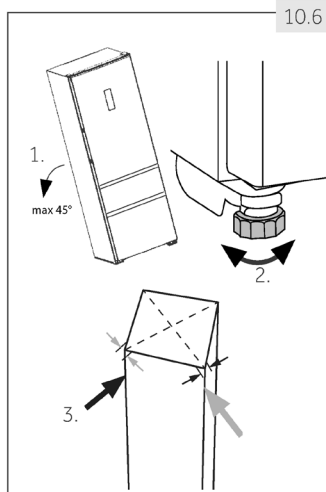

10.7 Waiting time

To the maintenance-free lubrication oil is located in the capsule of the compressor. This oil can get through the closed pipe system during slanting transport. Before connecting the appliance to the power supply you have to wait 2 hours (Fig. 10.7) so that the oil runs back into the capsule.

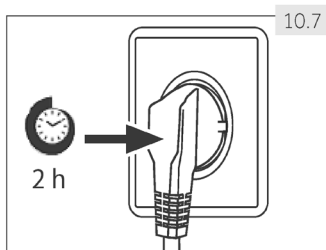

10.8 Electrical connection

Before each connection check if:

- ▶ power supply, socket and fusing are appropriate to the rating plate.
- ▶ the power socket is earthed and no multi-plug or extension.
- ▶ the power plug and socket are strictly according.

Connect the plug to a properly installed household socket.



WARNING!

To avoid risks a damaged power cord must be replaced by the customer service (see warranty card).

10.9 Door Reversibility

Before connecting the appliance to the power supply you should check, whether the door swing must be changed from right (as delivered) to left, if this is required by the installation location and the usability.



WARNING!

- ▶ The appliance is heavy. You need two persons to carry out the door reversibility.
- ▶ Before any operation, first unplug the appliance from the mains .
- ▶ Do not tilt the appliance more than 45 ° to prevent damage of the cooling system.

Assembly steps (Fig. 10.9):

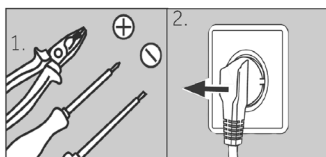

1. Provide necessary tool.
2. Unplug the appliance.

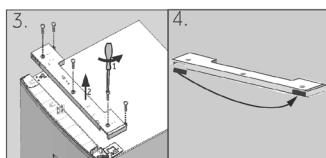

3. Remove the five screws which fix the front panel (1) and remove the panel (2).
4. Remove the small cover of the front panel from left to right side.

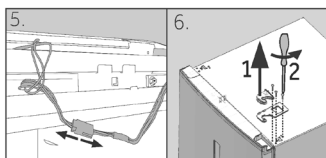

5. Unplug the connection cable
6. Remove the upper hinge cover (1) and unscrew the upper hinge (three screws) on right side (2).

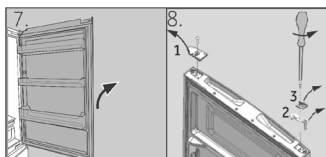

7. Lift the loose refrigerator door carefully off the lower hinge.
8. Turn the door upside down, unscrew the cover (1) and the door stop (2) with fixing part (3).

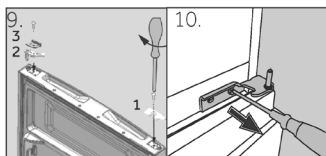

9. Take out new cover (1) and door stop (2) with fixing part (3) from the accessory bag and screw them to opposite side.
10. Remove the lower hinge of the upper door.

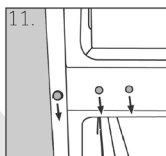

11. Change the positions of the blanking plugs and the screw on the side.

Next steps (a-h) are only necessary for models with two doors:

- a Remove lower door
- b This step needs two persons: one who holds the appliance in place and one who carries out the assembly steps!
Tilt the appliance slightly backwards and remove the lower hinge with the feet (1). Change also position of the other feet (2).
- c Unscrew the two grub screws (1), remove the lower hinge, rotates through 180° (2) and
- d refix the lower hinge with the 2 grub screws
- e Screw the lower hinge to the left side of the appliance.
- f Follow steps 8 and 9.
- g Lift the lower door carefully on to the lower hinge so that the pivot fits into the hinge barrel.

Be sure the pivot fits into the hinge barrel of lower door.

- h Take out the new hinge from the accessory bag and screw it to the left side of the appliance.

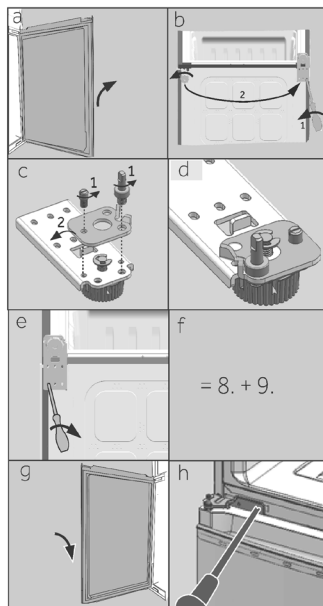

12. Take out the new lower hinge of upper door from the accessory bag and screw it to the left side of the appliance.
13. Lift the upper door carefully on to the lower hinge so that the pivot fits into the hinge barrel.

Be sure the pivot fits into the hinge barrel of lower door.

14. Take out the upper hinge from the accessory bag. Put the connection cable through the upper hinge and fix the upper hinge with the three screws on left side of appliance.
15. Put the hinge cover (delivered in the accessory bag) over the hinge.
16. Plug in the connection cable and fit it into the opening.
17. Replace front panel and fix it with the five screws.

18. Take out the cover from the accessory bag and fix it to the right side of upper door.

After the change of the door check that the door seals are located properly on the housing and all screws are tightened well.

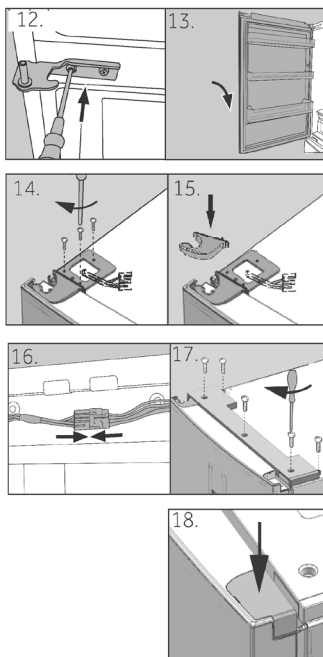

11.1 Product fiche according to regulation EU No. 1060/2010

Trade mark	Haier					
Model identifier	A3FE		C3FE			
	737C*J	837C*J	737C*J	835C*J	837C*J	935C*J
Category of the model	Refrigerator-freezer					
Energy efficiency class	A++	A+++	A++	A+++	A+++	A+++
Annual energy consumption (kWh/year) ¹⁾	273	182	282	183	188	165
Storage volume cooling (L)	257	257	257	231	257	231
Storage volume freezing (L) ****	97	97	108	108	108	108
Star rating	✘ ***					
Temperature of other compartments > 14°C	Non applicable					
Frostfree system	Yes					
Power cut safe (h)	13	14	13	14	14	14
Freezing capacity (kg/24h)	12					
Climate class This appliance is intended to be used at an ambient temperature between 10 °C and 43°C.	SN/N/ST/T					
Airborne acoustical noise emissions (db(A) re 1pW)	40	39	40	39	39	39
Construction type	Freestanding					

*= Colour code

¹⁾based on standard test results for 24 hours. Actual energy consumption will depend on how the appliance is used and where it is located.

11.2 Additional technical data

Model identifier	A3FE		C3FE			
	737C*J	837C*J	737C*J	835C*J	837C*J	935C*J
Voltage / Frequency	220-240V ~/ 50Hz					
Input current (A)	1.3	1.3	1.3	1.6	1.6	1.6
Main fuse (A)	10.0	10.0	10.0	10.0	10.0	10.0
Coolant	R600a					
Total volume (L)	395	395	400	375	400	375
Net volume (L)	354	354	365	339	365	339
Dimensions (in mm)						
Depth	657	677	657	677		
Width	595					
Height	2005			1905	2005	1905

11.3 Standards and directives

This product meets the requirements of all applicable EC directives with the corresponding harmonised standards, which provide for CE marking.

12- Customer Service

GB

We recommend our Haier Customer Service and the use of original spare parts.
If you have a problem with your appliance, please first check section TROUBLESHOOTING.

If you cannot find a solution there, please contact

- ▶ your local dealer or
- ▶ the Service & Support area at www.haier.com where you can find telephone numbers and FAQs and where you can activate the service claim.

To contact our Service, ensure that you have the following data available.
The information can be found on the rating plate.

Model _____ Serial No. _____

Also check the Warranty Card supplied with the product in case of warranty.

For general business enquiries please find below our addresses in Europe:

European Haier addresses			
Country*	Postal address	Country*	Postal address
Italy	Haier Europe Trading SRL Via De Cristoforis, 12 21100 Verese ITALY	France	Haier France SAS 3-5 rue des Gravieres 92200 Neuilly sur Seine FRANCE
Spain Portugal	Haier Iberia SL Pg. Garcia Faria, 49-51 08019 Barcelona SPAIN	Belgium-FR Belgium-NL Netherlands Luxembourg	Haier Benelux SA Anderlecht Route de Lennik 451 BELGIUM
Germany Austria	Haier Deutschland GmbH Hewlett-Packard-Str. 4 D-61352 Bad Homburg GERMANY	Poland Czechia Hungary Greece Romania Russia	Haier Poland Sp. zo.o. Al. Jerozolimskie 181B 02-222 Warszawa POLAND
United Kingdom	Haier Appliances UK Co.Ltd. One Crown Square Church Street East Woking, Surrey, GU21 6HR UK		

*For more information please refer to www.haier.com

A3FE-C3FE-737-835-837-935 CMJ_GB-V02_042017

Haier

Free Manuals Download Website

<http://myh66.com>

<http://usermanuals.us>

<http://www.somanuals.com>

<http://www.4manuals.cc>

<http://www.manual-lib.com>

<http://www.404manual.com>

<http://www.luxmanual.com>

<http://aubethermostatmanual.com>

Golf course search by state

<http://golfingnear.com>

Email search by domain

<http://emailbydomain.com>

Auto manuals search

<http://auto.somanuals.com>

TV manuals search

<http://tv.somanuals.com>