

Haier

OPERATION MANUAL SPLIT TYPE ROOM AIR CONDITIONER

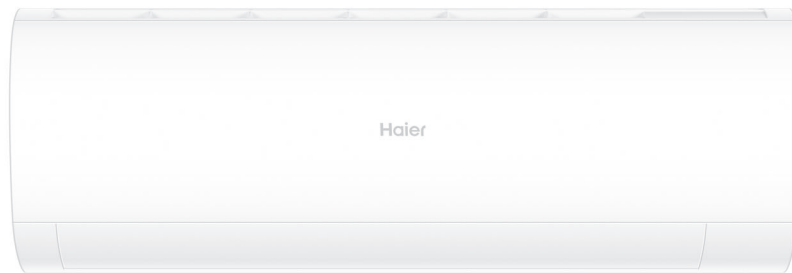

Italiano Español

AS09PBDHRA	AS26PBDHRA
AS12PBDHRA	AS35PBDHRA
AS18PDDHRA	AS53PDDHRA
AS24PDDHRA	AS71PDDHRA

- Please read this operation manual before using the air conditioner.
Keep this operation manual for future reference
This appliance is filled with R32.

0011518287



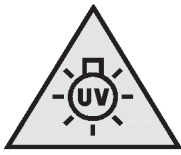

This appliance contains a UV-C lamp.

WARNING:

- Read the maintenance instructions before opening the appliance.
- Eye or skin irritation may result from exposure from top air inlet and inner part. During air filter taking and putting for maintenance, please make sure that the power is cut off before approaching the product.
- UV-C barriers bearing the ultraviolet radiation hazard symbol should not be removed.
- Appliances that are obviously damaged must not be operated.
- Do not operate UV-C lamps outside of the appliance.
- The appliance must be disconnected from the power supply before replacing or cleaning or other maintenance of the UV-C lamp.
- The type of UV-C lamp is 0011012908A.
- Front panels bearing the ultraviolet radiation hazard symbol which have UV-C radiation are provided with a switch to interrupt the power to the UV-C lamps for your safety. Do not over-ride switch by magnet and other similar material.
- Before opening front panels bearing the ultraviolet radiation hazard symbol for the conducting user maintenance, it is recommended to disconnect the power.
- If the UV-C lamp is damaged, it must be replaced by the manufacturer, its service agent or similarly qualified persons in order to avoid a hazard.
- Unintended use of the appliance or damage to the housing may result in the escape of dangerous UV-C radiation. UV-C radiation may, even in small doses, cause harm to the eyes and skin.

Parts and Functions

Indoor Unit

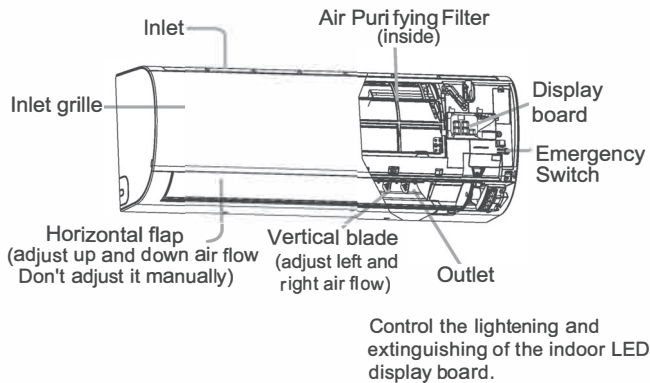

Display board

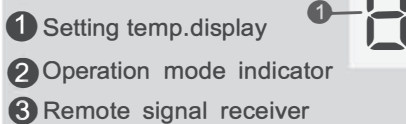

Actual inlet grille may vary from the one shown in the manual according to the product purchased

Outdoor Unit

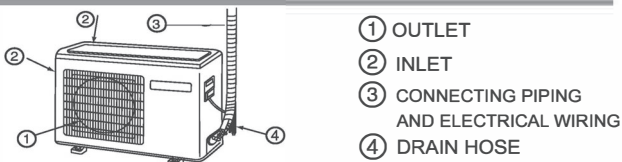

WiFi Setup

If your Air Conditioner (AC) has a Connected Appliance Information label located under the front cover as shown below, your AC is WiFi Connect Enabled. A WiFi communication card is built into the product allowing it to communicate with your smart phone for remote monitoring, control and notifications. Please visit www.haier.com.au/smart or www.haier.co.nz/smart to learn more about connected appliance features, and to learn what connected appliance apps will work with your smart phone.

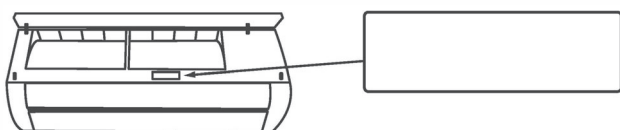

Remote controller

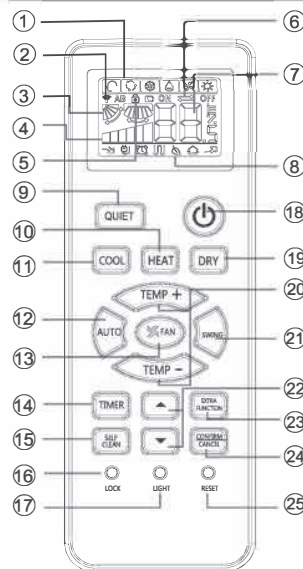

8. Additional functions display

Operation mode	QUIET	SLEEP	HEALTH	TURBO
Remote controller				

- QUIET button
- HEAT button
- COOL button
- AUTO button
- FAN SPEED button
- TIMER button
- SELF CLEAN button
- LOCK button
Used to lock buttons and LCD display
- LIGHT button
Control the lightening and extinguishing of the indoor LED display board.
- POWER ON/OFF button
- DRY button
- TEMP button
- SWING button
- HOUR button
- EXTRA FUNCTION button
Function: Sleeping → HEALTH (UV-C lamp starts working) → Healthy airflow position 1 → Healthy airflow position 2 → Power → Air sending → A-B yard → Left/Right Swing (This function is unavailable on some models.)
- CANCEUCON FIRM button
Function: Setting and cancel to the timer and other additional functions.
- RESET button
When the remote controller appears abnormal, use a sharp pointed article to press this button to reset the remote.

1. Mode display

Operation mode	AUTO	COOL	DRY	FAN	HEAT
Remote controller					

- Signal sending display
- SWING display
- FAN SPEED display



- LOCK display
- TIMER OFF display
- TIMER ON display
- TEMP display

NOTE:
Cooling only unit do not have displays and functions related with heating
If the unit which you purchased has healthy function, follow it. If not, please ignore.

Loading of the battery

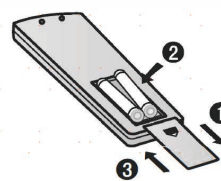

- Remove the battery cover;
- Load the batteries as illustrated. 2 R-03 batteries, resetting key (cylinder); Be sure that the loading is in line with the "+" / "-" ;
- Load the battery, then put on the cover again.

Note:

- The distance between the signal transmission head and the receiver hole should be within 7m without any obstacle as well.
- When electronic-started type fluorescent lamp or change-over type fluorescent lamp or wireless telephone is installed in the room, the receiver is apt to be disturbed in receiving the signals, so the distance to the indoor unit should be shorter.
- Full display or unclear display during operation indicates the batteries have been used up. Please change batteries.
- If the remote controller can't run normally during operation, please remove the batteries and reload several minutes later.

Operation

Unit start / stop

Remote controller

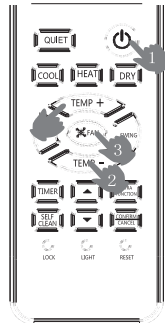

1. Unit start

Press ON/OFF on the remote controller, unit starts.

2. Select temp.setting

Press TEMP+ / TEMP- button

TEMP+ Every time the button is pressed, temp.setting increase 1°C,if kept depressed, it will increase rapidly

TEMP- Every time the button is pressed, temp.setting decrease 1°C,if kept depressed, it will decrease rapidly

Select a desired temperature.

3. Fan speed selection

Press FAN button. For each press, fan speed changes as follows:

Remote controller:



Air conditioner is running under displayed fan speed. When FAN is set to AUTO, the air conditioner automatically adjusts the fan speed according to room temperature.

Operation Mode	Display Board	Remote Controller	Note
AUTO			Under the mode of auto operation, air conditioner will automatically select Cool or Heat operation according to room temperature. When FAN is set to AUTO, the air conditioner automatically adjusts the fan speed according to room temperature.
COOL			Cooling only unit do not have displays and functions related with heating
DRY			In DRY mode, when room temperature becomes lower than temp.setting+2°C,unit will run intermittently at LOW speed regardless of FAN setting.
HEAT			In HEAT mode,warm air will blow out after a short periodof the time due to cold-draft prevention function.
FAN	nothing		In FAN operation mode, the unit will not operate in COOL or HEAT mode but only in FAN mode ,AUTO is not available in FAN mode.And temp.setting is disabled. When FAN is set to AUTO, the air conditioner automatically adjusts the fan speed according to room temperature. In FAN mode,SLEEP operation is not available.

Air Flow Direction Adjustment

1.Vertical flap

Pos.1

Pos.2

Pos.3

Pos.4 (Autoswing)

Pos.5

Remote controller

COOL/DRY/AUTO(Initial state):

HEAT(Initial state):



(no)

2.Press button. changes as follows: Pos.4

Press button again ,vertical flap will stop over present position,the swing function will be cancelled.

3.Press button to choose the Pos.2 and Pos.3.

Cautions:

- When adjusting the flap by hand,turn off the unit.
- When humidity is high,condensate water might occur at air outlet if all vertical louvers are adjusted to left or right.
- It is advisable not to keep horizontal flap at downward position for a long time in COOL or DRY mode , otherwise, condensate water might occur.

Note:

When restart after remote turning off, the remote controller will automatically return to the previous set swing position.

DRED Operation

(This function is unavailable on some models.)

Haier Peaksmart enabled air-conditioners have a Demand Response Mode display on the indoor unit.

The display could be labelled d1, d2, d3 (wording may differ model to model).

These modes are described in more detail below:

Mode	Display	Description	What to do
DRM3	d3	Your air-conditioner will continue to cool or heat during the peak demand event. The energy consumed by your air-conditioner is capped to 75%.	No action is required.
DRM2	d2	Your air-conditioner will continue to cool or heat during the peak demand event. The energy consumed by your air-conditioner is capped to 50%.	No action is required.
DRM1	d1	Your air-conditioner is still turned on and the fan will continue to operate. Your compressor is turned off and cool/hot air will no longer be generated	DRM1 mode is only activated during emergency demand management situations. This mode will automatically reset the device within 2 hours .If your air-con is in this mode for longer than 2 hours please contact Energex on 13 12 53.

Operation

Timer On/Off On-Off Operation

1. After unit starts, select your desired operation mode.
2. Press TIMER button to change TIMER mode. Every time the button is pressed, display changes as follows:

Remote controller:



Then select your desired TIMER mode (TIMER ON or TIMER OFF or TIMER ON-OFF). " ON "or " OFF "will flash.

3. Press ▼ / ▲ button to set time.

▲ Press the button for each time, setting time in the first 12 hours increased by 0.5 hour every time, after 12 hours, increased by 1 hour every time.

▼ Press the button for each time, setting time in the first 12 hours decreased by 0.5 hour every time, after 12 hours, decreased by 1 hour every time. It can be adjusted within 24 hours.

4. Confirm timer setting

After adjust the time, press button and confirm the time ON or OFF button will not flash any more.

5. Cancel timer setting

Press the button by times until the time display eliminated.

Hints:

After replacing batteries or a power failure happens, time setting should be reset.

According to the Time setting sequence of TIMER ON or TIMER OFF, either Start-Stop or Stop-Start can be achieved.

Self Clean Operation

◆ Functional description: the purpose of this function is to clean the evaporator and condenser.

◆ Entry and exit: Press self clean button to enter this function, then it will display "CL" on the panel of the indoor unit and also on the remote controller. After running 20-30 minutes, this function will exit automatically when the " Pi " sound is heard twice, then the unit returns to original state. Under operation process of self clean, pressing the button repeatedly has no effect and the function will not exit, but pressing the power off button and other mode button can make it exit.

POWER/SOFT Operation

(This function is unavailable on some models.)

- (1) POWER Operation

When you need rapid heating or cooling, you can use this function.

Press button to enter additional options, when cycle display to , will flash , and then press , enter to power function. When cancel the function, please enter additional options again and to cancel power function.

- (2) QUIET Operation

You can use this function when silence is needed for rest or reading.

Press QUIET button, the remote controller will show , and then achieve to the quiet function. Press again this QUIET button , the quiet function will be cancelled.

Note :

During POWER operation, in rapid COOL mode , the room will show inhomogeneous temperature distribution. Long period QUIET operation will cause effect of not too cool or not too warm.

Emergency operation and test operation

Emergency Operation:

- Use this operation only when the remote controller is defective or lost.
- When the emergency operation switch is pressed, the " Pi " sound is heard once, which means the start of this operation.
- In this operation, the system automatically selects the operation modes, cooling or fan or heat, according to the room temperature.



Room temperature	Operation mode	Designated temperature	Timer mode	Air flow
ABOVE 23°C	COOLING	26°C	NO	AUTOMATIC
BELOW 23°C	HEAT	23°C	NO	AUTOMATIC

(Cooling only unit) Room temperature	Operation mode	Designated temperature	Timer mode	Air flow
BELOW 23°C	FAN	26°C	NO	AUTOMATIC

- It is not possible to operate in dry mode.

Test operation:

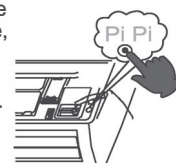

Test operation switch is the same as emergency switch.

- Use this switch in the test operation when the room temperature is below 16 °C , do not use it in the normal operation.
- Continue to press the test operation switch for more than 5 seconds. After you hear the "Pi" sound twice, release your finger from the switch: the cooling operation starts with the air flow speed "Hi".
- After 30 minutes, test operation ends automatically.



Operation

Comfortable SLEEP

Press **EXTRA FUNCTION** button to enter additional options, when cycle display to  ,  will flash. And then press **CONFIRM/CANCEL** enter to sleep function.



Operation Mode

1. In COOL, DRY mode

1 hour after SLEEP mode starts, temp will become 1°C higher than temp setting. After another 1 hour, temp rises by 1°C further. The unit will run for further 6 hours then stops. Temp is higher than temp setting so that room temperature won't be too low for your sleep.

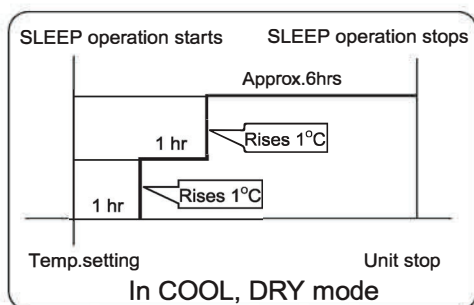

2. In HEAT mode

1 hour after SLEEP mode starts, temp will become 2°C lower than temp setting. After another 1 hour, temp decrease by 2°C further. After more another 3 hours, temp rises by 1°C further. The unit will run for further 3 hours then stops. Temp is lower than temp setting so that room temperature won't be too high for your sleep.

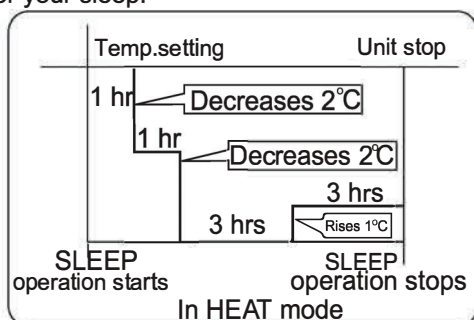

3. In AUTO mode

The unit operates in corresponding sleep mode corresponding sleep mode adapted to the automatically selected operation mode.

4. In FAN mode

It has no SLEEP function.

5. When comfortable sleeping function is set to 8 hours the comfortable sleeping time can not be adjusted. When TIMER function is set, the comfortable sleeping function can't be set up. After the sleeping function is set up, if user resets TIMER function, the sleeping function will be cancelled; the machine will be in the state of timing-on, if the two modes are set up at the same time, either of their operation time is ended first, the unit will stop automatically, and the other mode will be cancelled.

Note

When TIMER function is set, the sleeping function can't be set up. After the sleeping function is set up, if user resets TIMER function, the sleeping function will be cancelled; the machine will be in the state of timing-on.

Power Failure Resume Function

If the unit is started for the first time, the compressor will not start running unless 3 minutes have elapsed. When the power resumes after power failure, the unit will run automatically, and 3 minutes later the compressor starts running.

Healthy airflow Operation

1. Press  to starting

Setting the comfort work conditions.

2. The setting of healthy airflow function

Press **EXTRA FUNCTION** button to enter additional options, Press this button continuously, the louvers location will cycle between in the following three locations, to choose the swing location what you needed, and then press **CONFIRM/CANCEL** button to confirm.



3. The cancel of the healthy airflow function

Press **EXTRA FUNCTION** button to enter additional options, Press this button continuously, the louvers location will cycle between in the following three locations again, and then press **CONFIRM/CANCEL** button to cancel.

Notice: Do not direct the flap by hand. Otherwise, the grille will run incorrectly. If the grille is not run correctly, stop for a minute and then start, adjusting by remote controller.

Note:

1. After setting the healthy airflow function, the position grill is fixed.





2. In cooling, it is better to select the  mode.

3. In cooling and dry, using the air conditioner for a long time under the high air humidity, condensate water may occur at the grille.

Operation

■ HEALTH Operation

(This function is unavailable on some models.)

Press  button to enter additional options, when cycle display to ,  will flash, and then press , enter to HEALTH function. When cancel the function, please enter additional options again and to cancel HEALTH function.



UV sterilization function: it uses the c-band with the most effective sterilization effect in ultraviolet radiation to remove harmful micro-organisms such as bacteria in the air, which has remarkable effects to make the air healthy.

Attention:

1. It is recommended to turn on the UV sterilization function for 1-2 hours in one day, longer time will affect the life of the UV lamp.
2. Do not look directly at the UV lamp or touch it with your hand when the sterilizing function is on. Please turn off the sterilizing function before opening the panel.
3. Tinged blue light may appear near the air conditioning inlet when the sterilizing function is on.
4. Only when the internal fan starts and health function turned on, the UV lamp will be lighted.

Maintenance

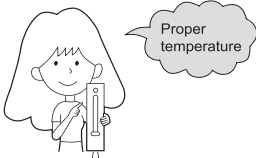
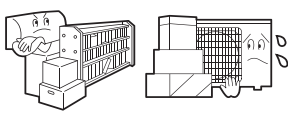
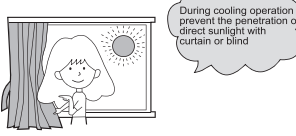
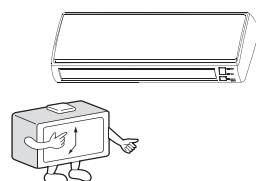
For Smart Use of The Air Conditioner

<p>Setting of proper room temperature</p> 	<p>Do not block the air inlet or outlet</p> 
<p>Close doors and windows during operation</p> 	<p>Use the timer effectively</p> 
<p>If the unit is not to be used for a long time, turn off the power supply main switch.</p> 	<p>Use the louvers effectively</p> 

Remote Controller



Do not use water, wipe the controller with a dry cloth. Do not use glass cleaner or chemical cloth.

Indoor Body



Wipe the air conditioner by using a soft and dry cloth. For serious stains, use a neutral detergent diluted with water. Wring the water out of the cloth before wiping, then wipe off the detergent completely.

Do not use the following for cleaning



Gasoline, benzene, thinner or cleanser may damage the coating of the unit.



Hot water over 40°C (104°F) may cause discoloring or deformation.

Air Filter cleaning

- 1 Open the inlet grille by pulling it upward.
- 2 Remove the filter. Push up the filter's center tab slightly until it is released from the stopper, and remove the filter downward.
- 3 Clean the filter. Use a vacuum cleaner to remove dust, or wash the filter with water. After washing, dry the filter completely in the shade.
- 4 Attach the filter. Attach the filter correctly so that the "FRONT" indication is facing to the front. Make sure that the filter is completely fixed behind the stopper. If the right and left filters are not attached correctly, that may cause defects.
- 5 Close the inlet grille.

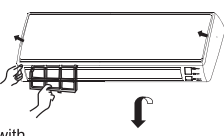
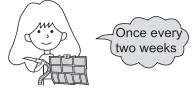
Replacement of Air Purifying Filter

(NOTE: Air purifying filter is optional part)

1. Open the Inlet Grille
Prop up the inlet grille by using a small device named grille-support which located in the right side of the indoor unit.
2. Detach the standard air filter
Slide the knob slightly upward to release the filter, then withdraw it.
3. Attach Air Purifying Filter
Put air purifying filter appliances into the right and left filter frames.

Detach old Air Purifying Filter

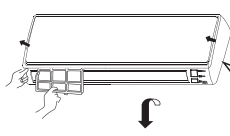

4. Attach the standard air filter
(Necessary installation)
5. Close the Inlet Grille
Close the Grille surely

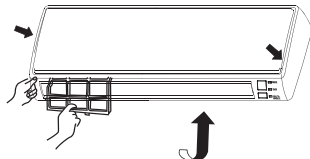

ATTENTION:
The white side of the photocatalyst air purifying filter face outside, and the black side face the unit.
The green side of the bacteria-killing medium air purifying filter face outside, and the white side face the unit.

NOTE:

- The photocatalyst air purifying filter will be solarized in fixed time. In normal family, it will be solarized every 6 months.
- The bacteria-killing medium air purifying filter will be used for a long time, no need for replacement. But in the period of using them, you should remove the dust frequently by using vacuum cleaner or flapping them lightly, otherwise, its performance will be affected.
- Please keep the bacteria-killing medium air purifying filter in the cool and dry conditions avoid long time directly sunshine when you stop using it, or its ability of sterilization will be reduced.

Cautions

⚠ WARNING

Please call Sales/Service Shop for the Installation.
Do not attempt to install the air conditioner by yourself because improper works may cause electric shock, fire, water leakage.

⚠ WARNING

When abnormality such as burnt-smell found, immediately stop the operation button and contact sales shop.

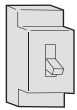

OFF



!
STRICT
ENFORCEMENT

Use an exclusive power source with a circuit breaker

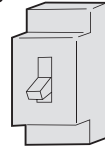

Check proper installation of the drainage securely



STRICT
ENFORCEMENT

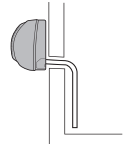

Connect power supply cord to the outlet completely



STRICT
ENFORCEMENT

Use the proper voltage

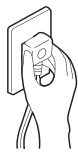

STRICT
ENFORCEMENT

1. Do not use power supply cord extended or connected in halfway
2. Do not install in the place where there is any possibility of inflammable gas leakage around the unit.
3. Do not get the unit exposed to vapor or oil steam.



PROHIBITION

Do not use power supply cord in a bundle.

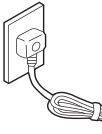

PROHIBITION

Take care not to damage the power supply cord.



PROHIBITION

Do not insert objects into the air inlet or outlet.

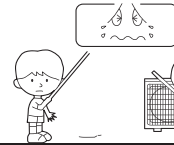

PROHIBITION

Do not start or stop the operation by disconnecting the power supply cord and so on.



PROHIBITION

Do not channel the air flow directly at people, especially at infants or the aged.



PROHIBITION

Do not try to repair or reconstruct by yourself.

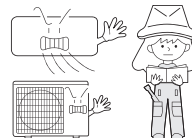

Connect the earth cable.

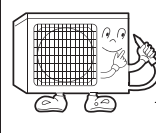

earthing

⚠ CAUTION

Do not use for the purpose of storage of food, art work, precise equipment, breeding, or cultivation.

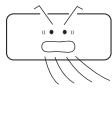

PROHIBITION

Take fresh air occasionally especially when gas appliance is running at the same time.

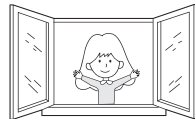

STRICT
ENFORCEMENT

Do not operate the switch with wet hand.

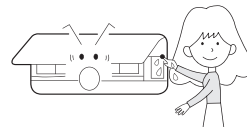

PROHIBITION

Do not install the unit near a fireplace or other heating apparatus.

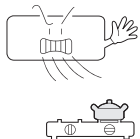

PROHIBITION

Check good condition of the installation stand

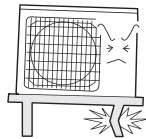

PROHIBITION

Do not pour water onto the unit for cleaning

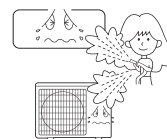

PROHIBITION

Do not place animals or plants in the direct path of the air flow

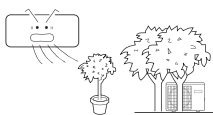

PROHIBITION

Do not place any objects on or climb on the unit.

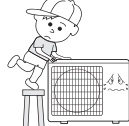

PROHIBITION

Do not place flower vase or water containers on the top of the unit.





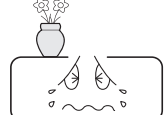

PROHIBITION



Trouble shooting

Before asking for service, check the following first.

	Phenomenon	Cause or check points
Normal Performance inspection	The system does not restart immediately. 	<ul style="list-style-type: none"> When unit is stopped, it won't restart immediately until 3 minutes have elapsed to protect the system. When the electric plug is pulled out and reinserted, the protection circuit will work for 3 minutes to protect the air conditioner.
	Noise is heard 	<ul style="list-style-type: none"> During unit operation or at stop, a swishing or gurgling noise may be heard. At first 2-3 minutes after unit start, this noise is more noticeable. (This noise is generated by refrigerant flowing in the system.) During unit operation, a cracking noise may be heard. This noise is generated by the casing expanding or shrinking because of temperature changes. Should there be a big noise from air flow in unit operation, air filter may be too dirty.
	Smells are generated.	<ul style="list-style-type: none"> This is because the system circulates smells from the interior air such as the smell of furniture, paint, cigarettes.
	Mist or steam are blown out. 	<ul style="list-style-type: none"> During COOL or DRY operation, indoor unit may blow out mist. This is due to the sudden cooling of indoor air.
	In dry mode, fan speed can't be changed.	<ul style="list-style-type: none"> In DRY mode, when room temperature becomes lower than temp. setting+2 °C, unit will run intermittently at LOW speed regardless of FAN setting.
	Multiple check	
Poor cooling 		<ul style="list-style-type: none"> Is the air filter dirty? Normally it should be cleaned every 15 days. Are there any obstacles before inlet and outlet? Is temperature set correctly? Are there some doors or windows left open? Is there any direct sunlight through the window during the cooling operation?(Use curtain) Are there too much heat sources or too many people in the room during cooling operation?

Cautions

- Do not obstruct or cover the ventilation grille of the air conditioner. Do not put fingers or any other things into the inlet/outlet and swing louver.
- This appliance is not intended for use by persons (including children) with reduced physical, sensory or mental capabilities or lack of experience and knowledge, unless they have been given supervision or instruction concerning use of appliance by person responsible for their safety. Children should be supervised to ensure that they do not play with the appliance.

Specifications

- The refrigerating circuit is leak-proof.

The machine is adaptive in following situation

1. Applicable ambient temperature range:

Cooling	Indoor	Maximum:D.B/W.B 32°C/23°C Minimum:D.B/W.B 21°C/15°C
	Outdoor	Maximum:D.B/W.B 46°C/26°C Minimum: D.B -10°C
Heating	Indoor	Maximum:D.B 27°C Minimum: D.B 15°C
	Outdoor	Maximum:D.B/W.B 24°C/18°C Minimum:D.B -10°C
	Outdoor (INVERTER)	Maximum:D.B/W.B 24°C/18°C Minimum:D.B -15°C

- If the power supply cord is damaged, it must be replaced by the manufacturer or its service agent or a similar qualified person.
- If the fuse of indoor unit on PC board is broken, please change it with the type of T. 3.15A/ 250V. If the fuse of outdoor unit is broken, change it with the type of T.25A/250V
- The wiring method should be in line with the local wiring standard.
- After installation, the power plug should be easily reached.
- The waste battery should be disposed properly.
- The appliance is not intended for use by young children or infirm persons without supervision.
- Young children should be supervised to ensure that they do not play with the appliance.
- Please employ the proper power plug, which fit into the power supply cord.
- The power plug and connecting cable must have acquired the local attestation.
- In order to protect the units, please turn off the A/C first, and at least 30 seconds later, cutting off the power.

Free Manuals Download Website

<http://myh66.com>

<http://usermanuals.us>

<http://www.somanuals.com>

<http://www.4manuals.cc>

<http://www.manual-lib.com>

<http://www.404manual.com>

<http://www.luxmanual.com>

<http://aubethermostatmanual.com>

Golf course search by state

<http://golfingnear.com>

Email search by domain

<http://emailbydomain.com>

Auto manuals search

<http://auto.somanuals.com>

TV manuals search

<http://tv.somanuals.com>