

## ***Clothes Dryer*** **OWNER'S MANUAL**

*Model: HDY-M60*  
*HDY-M40*

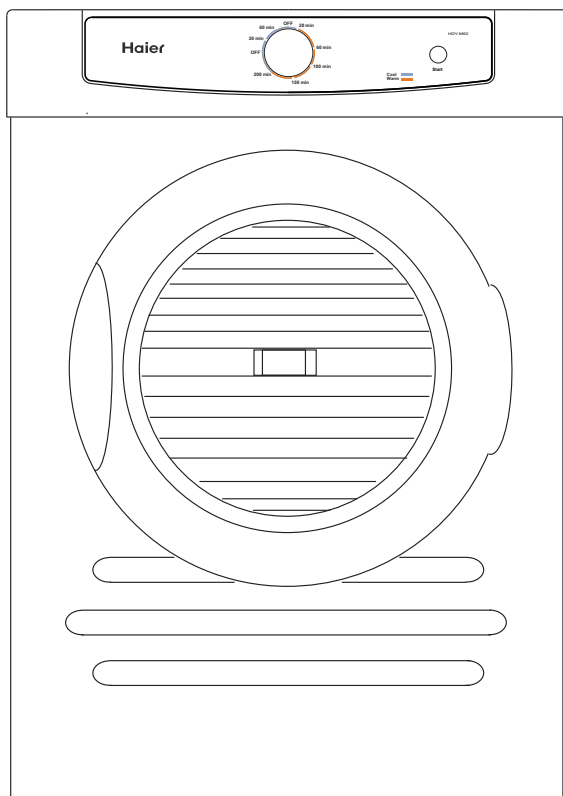

*Please read this manual carefully before operating your dryer.  
Retain this for future reference.  
Record the model and serial number of the tumble dryer.  
Please have this information ready for any service related enquiries.*

<b>TABLE OF CONTENTS</b>	<b>PAGE</b>
<b><u>IMPORTANT SAFETY INSTRUCTIONS</u></b> .....	<b>1</b>
<b><u>OPERATING INSTRUCTIONS</u></b>	
<b>IDENTIFICATION OF PARTS</b> .....	<b>3</b>
<b>OPERATING INSTRUCTIONS</b> .....	<b>4</b>
<b>CONTROL PANEL</b> .....	<b>6</b>
<b><u>CLEANING AND CARE GUIDE</u></b>	
<b>CLEANING AND MAINTAINANCE</b> .....	<b>7</b>
<b><u>INSTALLATION</u></b>	
<b>UNPACKING YOUR DRYER</b> .....	<b>8</b>
<b>WALL MOUNTING INSTRUCTIONS</b> .....	<b>9</b>
<b>RACK FITTING INSTRUCTION</b> .....	<b>12</b>
<b><u>TROUBLESHOOTING AND SPECIFICATIONS</u></b>	
<b>TROUBLESHOOTING</b> .....	<b>14</b>
<b>WIRING CIRCUIT</b> .....	<b>14</b>
<b>SPECIFICATIONS</b> .....	<b>14</b>

*Date Purchased:* \_\_\_\_\_

*Store Purchased from:* \_\_\_\_\_

*Serial No.:* \_\_\_\_\_

# IMPORTANT: SAFETY INSTRUCTIONS

**Warning-To reduce the risk of fire, electric shock, or personal injuries, the following basic precautions should be followed:**

- 1 *Read all instructions before using this dryer.*
- 2 *The interior of the dryer should be cleaned periodically by qualified service personnel. An excessive amount of lint build up in the interior of the dryer could result in inefficient drying and pose a possible fire hazard.*
- 3 *The appliance must not be installed behind a lockable door, a sliding door or a door with a hinge on the opposite side to that of the tumble dryer in such a way that a full opening of the tumble dryer is restricted.*
- 4 *Attention - rear panel can be hot.*
- 5 *The tumble dryer should not be used if industrial chemicals have been used to clean the dryer.*
- 6 *The dryer must only be used for its intended purpose.*
- 7 *Clean lint screen before or after each load.*
- 8 *This appliance is not intended for use by people (including children) with reduced physical, sensory or mental capabilities, or lack of experience and knowledge, unless they have been given supervision or instruction concerning use of the appliance by a person responsible for their safety. Young children should be supervised to ensure that they do not play with the appliance.*
- 9 *Do not operate the dryer if any parts are missing or broken.*
- 10 *To avoid fire hazard or electrical shock do not use an adaptor plug or extension cord or remove grounding prong from electrical power cord. Failure to follow this warning can cause serious injury, fire or death.*
- 11 *To avoid fire hazard or electrical shock do not reach into the drum while the drum is moving. Wait until the dryer has stopped completely before reaching into the drum.*
- 12 *Do not attempt to modify or repair the controls.*
- 13 *The final part of a tumble dryer cycle occurs without heat (cool down cycle) to cool items to a temperature that ensures that they will not be damaged. Never stop a tumble dryer before the end of the drying cycle unless all items are quickly removed and spread out so that the heat is dissipated.*
- 14 *Do not dry items that have been previously cleaned in, washed in, soaked in, or spotted with substances such as cooking oil, acetone, alcohol, petrol, kerosene, spot removers, turpentine, waxes and wax removers, etc. Do not store or use these items on or in the vicinity of the dryer. Do not place items exposed to cooking oils in your dryer. Items contaminated with cooking oils may contribute to a chemical reaction that could cause a load to catch fire. Oil-affected items can ignite spontaneously, especially when exposed to heat sources such as in a tumble dryer. The items become warm, causing an oxidation reaction in the oil. Oxidation creates heat. If the heat cannot escape, the items can become hot enough to catch fire. Piling, stacking or storing oil-affected items can prevent heat from escaping and create a fire hazard. If it is unavoidable that fabrics that contain vegetable or cooking oil or have been contaminated by hair care products be placed in a tumble dryer they should first be washed in hot water with extra detergent - this will reduce, but not eliminate, the hazard.*

- 15 *Do not dry unwashed items in the tumble dryer.*
- 16 *Fabric softeners, or similar products, should be used as specified by the fabric softener instructions.*
- 17 *To prevent fire, do not use heat to dry items containing plastic, foam rubber or similarly textured rubber-like materials, or items containing feathers or down. Items such as foam rubber (latex foam), shower caps, waterproof textiles, rubber backed articles and clothes or pillows fitted with foam rubber pads should not be dried in the tumble dryer.*
- 18 *This dryer must be properly installed in accordance with the installation instructions before it is used.*
- 19 *Do not install or store this dryer where it will be exposed to water and /or the weather. Keep surrounding areas free from the accumulation of lint, dust and dirt.*
- 20 *To prevent shock hazard and assure stability during operation, the dryer must be installed and electrically grounded by a qualified service person in accordance with local codes.*
- 21 *Do not sit on top of the dryer.*
- 22 *If the power cord is damaged, it must be replaced by the manufacturer, its service agent or similarly qualified persons in order to avoid a hazard.*
- 23 *Always disconnect dryer from electrical supply before attempting any service. Disconnect power cord by grasping the plug, not the cord.*
- 24 *Do not repair or replace any part of the dryer or attempt any servicing unless specifically recommended in the user-maintenance instructions.*
- 25 *Before the dryer is removed from service or discarded, remove the dryer door to prevent accidental entrapment.*
- 26 *Remove all objects from pockets such as lighters and matches.*



*Caution, risk of fire - this is a safety symbol. Failure to follow the warnings outlined in these user instructions can cause a fire hazard.*

## IDENTIFICATION OF PARTS

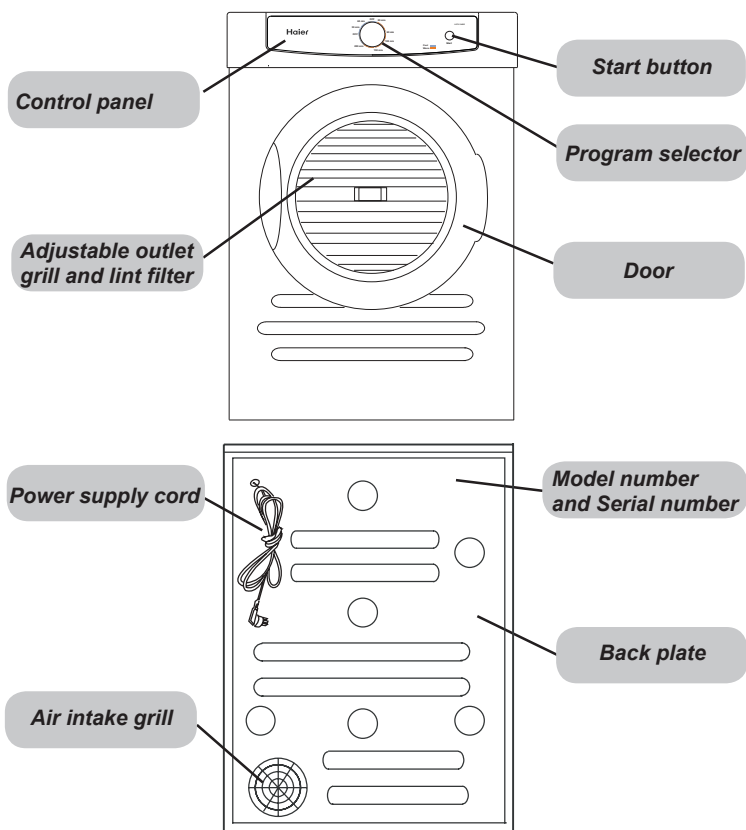

### **Warning**

Read all instructions before using this dryer.  
This dryer has been designed for domestic use only.  
**SAVE THESE INSTRUCTIONS.**

*This diagram may be slightly different from the layout of the dryer you have just purchased due to technical improvements.*

# OPERATING INSTRUCTIONS

## Attention:

1. Before operation, clean off any dust and dirt inside the drum of the dryer with a damp towel.
2. Clean off any debris on the lint filter and in the duct to increase the drying efficiency.

## Turning on power

Before turning on the power of the dryer check whether the supply voltage is in accordance with the value indicated on the name plate.

## Preparation of laundry load

- The dryer can only dry laundry which has been spun dry. Do not put in laundry which is still dripping wet or has excess water.
- Make sure all pockets are empty before placing laundry in the dryer. Remove all lighters and matches.
- Pull up zippers, mend loosened fasteners and tie up ribbons to prevent the laundry from being entangled. If necessary, put small items in a laundry bag.
- To achieve a better drying result ensure the clothes are separated before loading into the dryer.

## Load to dry

Model	Laundry type	Cotton fabric	Synthetic fabric
HDY-M60	Maximum load	6 kg	3 kg
HDY-M40	Maximum load	4 kg	2 kg

## Warning:

1. Avoid drying wool, silk and other delicate fabrics, they maybe damaged.
2. Do not exceed the recommended load limit. This could damage the dryer as well as the laundry.

## Reference weight of fabrics for drying

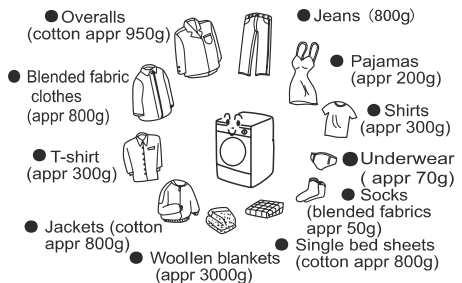
- Overalls (cotton appr 950g)
  - Blended fabric clothes (appr 800g)
  - T-shirt (appr 300g)
  - Jackets (cotton appr 800g)
  - Woollen blankets (appr 3000g)
  - Jeans (800g)
  - Pajamas (appr 200g)
  - Shirts (appr 300g)
  - Underwear (appr 70g)
  - Socks (blended fabrics appr 50g)
  - Single bed sheets (cotton appr 800g)
- 

# OPERATING INSTRUCTIONS





## 1. Power up

Insert the power plug into an appropriate power outlet that is properly installed and grounded. Operating power supply: 220-240V~50Hz.

## 2. Laundry loading

Open the door and load the laundry into the drum of the dryer. For a more energy efficient and better drying result, make sure the load has been spun dried. Loosen the load when placing in the dryer.

**Note:** Check labels on clothing before placing them in the dryer. Some articles are not suitable for machine dry. High temperature may damage the fabric.

	May be tumble dry .
	Do not tumble dry .
	Normal dry .
	Air dry, only .

## 3. Setting drying time

Turn the timer knob to set an optimal drying time according to the fabric type and quantity. You can choose cool cycle or warm cycle according to your needs and then press the "Start" button to start the dryer.

**Note:** 1. Before you set the drying time, ensure your hands are dry.  
2. Please close the door and press the "Start" button to restart the machine after adding laundry during the cycle.

## 4. Program completion

### Warm air cycle:

Before the drying time comes to end, the dryer will add cold air to cool the clothes. After the timer stops, the knob will point to OFF.

Open the door to remove the laundry.

### Cool air cycle:

Throughout the cycle, the heater does not activate. The laundry is dried by cool air.

**Note:** 1. To avoid timer interruption, please do not turn the timer knob to the grey area of the program cycle.  
2. Clothes should go through the cooling down/airing phase of the cycle. If for any reason the dryer is stopped before the cycle has finished, dry clothes should be removed immediately and not left in the dryer. Clothes should be spread out to cool and not left bunched eg. in a clothes basket. Before you open the door, please switch off the power supply.

## 5. Cleaning the filter

Please clean the filter after each load.

## CONTROL PANEL

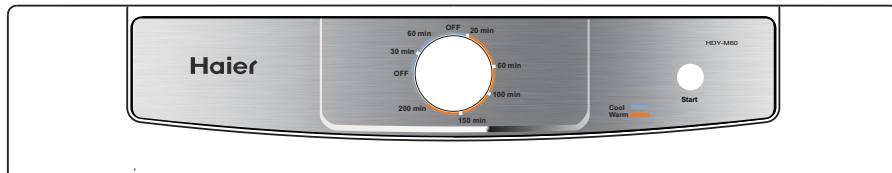

*It is not recommended to turn the timer indicator to the grey area of the program cycle.*

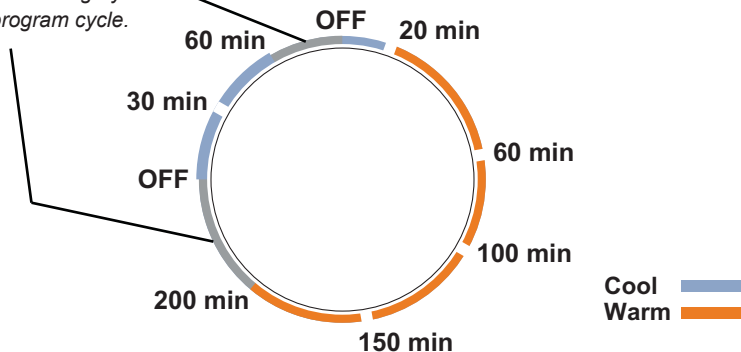

*Dryer timer: The timer will let you set the time for up to 200 minutes to dry your clothes depending on the load of the clothes.*

*This dryer has two program types. The light blue colour is the cool air cycle and the orange is the warm air cycle. During the cool air cycle the heater does not come on and the clothes are dried by cool air. During the warm air cycle the heater activates and the clothes are dried by warm air. In the last 20 minutes of the warm cycle, the heater stops and the laundry is cooled down.*

*There is an indicator on the timer knob. Turn the timer knob till the indicator points to the time selected. Push the "Start" button. The dryer starts the cycle and counts down, moving anti-clockwise, until the timer points to the "OFF" position.*



# CLEANING AND MAINTAINANCE

**WARNING! Unplug the power cord prior to any cleaning**

*Cleaning the surface*  
*Wipe off any dust or dirt.*

**NOTE:** *Do not use excessive water, a damp cloth is fine.*  
*Do not use solvent.*  
*Do not use spray cleaners when cleaning the interior.*  
*Do not use harsh or abrasive cleaners.*



*Cleaning the filter screen*  
*To ensure good ventilation effect during drying, the filter screen must be cleaned before or after each use.*

**1. Remove the filter**  
*Gently push together the clip on the filter screen and then pull out towards yourself.*

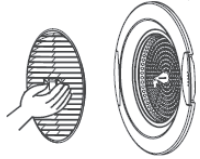

**2. Cleaning the filter**  
*Remove the lint with a soft brush or vacuum cleaner. Be careful not to damage the filters. Remove any remaining lint from the lint screen on the door.*

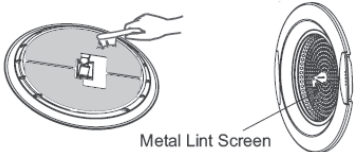

**3. Re-installing the filter**  
*After cleaning filters, put the screen back in place.*  
**Note:** *Never operate your dryer without the lint filter.*

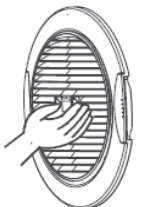

## UNPACKING YOUR DRYER

### Dimensions

	a(mm)	b(mm)	c(mm)	weight(kg)
HDY-M60	830	600	560	30
HDY-M40	830	600	445	27

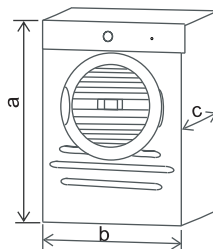

Remove the transport packaging (fig.1) and remove the dryer rack from the top packaging (fig.2). Remove the tape on the front (fig.3 and fig.4), the wall mounting kit attached to the drum with tape on the inside and the panel film, before starting the dryer.

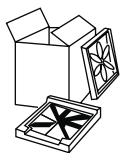

fig.1

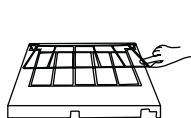

fig.2

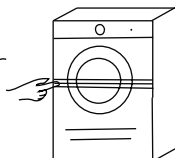

fig.3

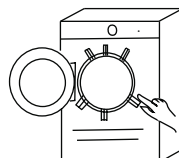

fig.4

### Packing accessories

Check list of the accessories and materials provided with the machine:

	Owner's manual	Wall mounting kit	Panel film	Screw	Dryer rack
Quantity (HDY-M60)	1	1	1	6	1
Quantity (HDY-M40)	1	1	1	6	None

To ensure the dryer operates normally, attention must be paid to the following:

1. The rear of the dryer must not have any restriction to the intake of fresh air.
2. Check the dryer for any damage. If any damage is found do not operate and contact your supplier or Authorised Service Centre.
3. The dryer must be kept away from flammable substances.
4. The surrounding environment must be dry and ventilated.
5. For best results, the ambient temperature should be between 10°C and 35°C.

## WALL MOUNTING INSTRUCTIONS

The dryer can be mounted on the wall in the inverted position only by following these instructions.

Invert the dryer so that the control panel is at the bottom (see figure 3) this allows easier access to the controls.

1. Determine the location of the dryer on the wall and mark the bracket position.

A minimum 50 mm is needed between the top of the dryer and the ceiling for ease of installation;

If mounting above a washing machine, allow sufficient room to open the lid of the washer.

Tools required:

For plaster/ Wooden wall	Drill&3mm Bit	1
	Philips head screwdriver	1

Wall mounting kit includes

Description	Plastic Spacers	2
	Wall hanging brackets	2
	Hanging hook	2
	Wood screws, 12gx50mm	4
	Screws for hanging hooks and plastic spacers.	6

2. Fix the wall hanging brackets to the wall securely (eg. into the stud).

If the studs are too far apart, fit a timber slat to the studs then mount the brackets onto the slat. The distance between each is 553 mm as per diagram.

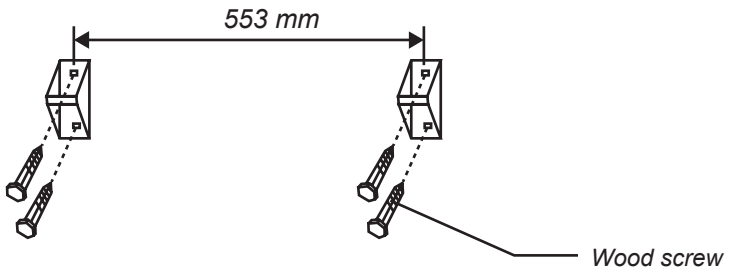

# WALL MOUNTING INSTRUCTIONS

3. Install the hooks to the dryer, in the inverted position, remove the 2 screws and 2 plastic plugs as indicated in Fig.1 .

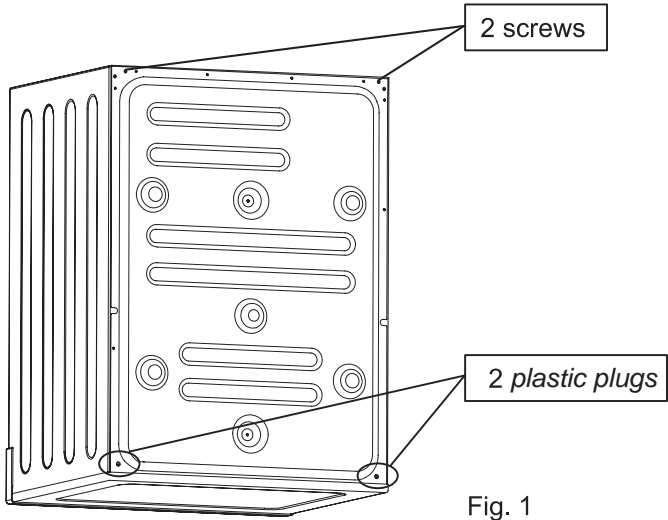

4. Align the hooks as shown in Fig.2 and refit screws tightly. Install the spacers provided as Fig.2.

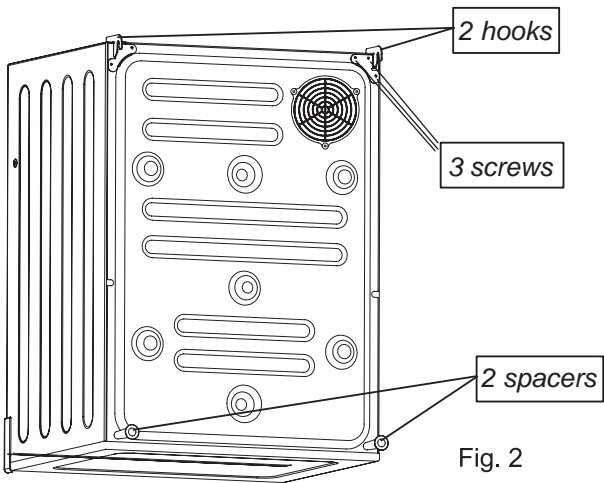

# WALL MOUNTING INSTRUCTIONS

5. With assistance, mount dryer on wall brackets. See Fig. 3

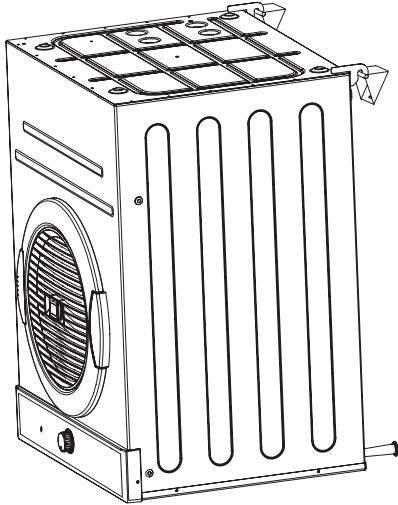

Fig. 3

6. A second control panel with inverted symbols is supplied. Peel the release paper from the back of inverted film then place new control panel film on the surface so that the writing is the correct way around.



**Caution:**

Plug must be accessible after installation.

# DRYING RACK FITTING INSTRUCTION

## DRYER FREE STANDING-UPRIGHT

For ease of access, the rack is to be mounted near the dryer top. Firstly hold the rack horizontally with the two end projections pointing upwards and away from yourself. Position the rack near the top of the dryer and place the end of the right rack projection into the right cabinet mounting hole (Fig. 1).

Then gently pull on the left rack projection until it fits around the cabinet and springs into the left cabinet mounting hole.

The rack will now lie horizontally, supported by the cabinet. Rotate the door outlet grills that the air exhausts upwards and through the rack.

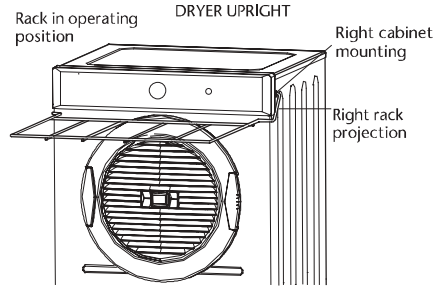

FIG. 1.

## RACK STORAGE - DRYER UPRIGHT

When the drying rack is not needed, simply pivot the rack upwards until it lies flat on the top of your dryer.

## WALL MOUNTED - DRYER INVERTED

In this situation, the rack is to be mounted near the dryer door part way along the cabinet. Firstly hold the rack horizontally with the two end projections pointing upwards and away from yourself.

Position the rack in front of the dryer and place the end of the right rack projection into the right cabinet mounting hole ( Fig.2).

Then gently pull on the left rack projection until it fits around the cabinet and springs into the left cabinet mounting hole.

The rack will now lie horizontally, supported by the cabinet.

Rotate the door outlet grill so that the air exhaust blows upwards and through the rack.

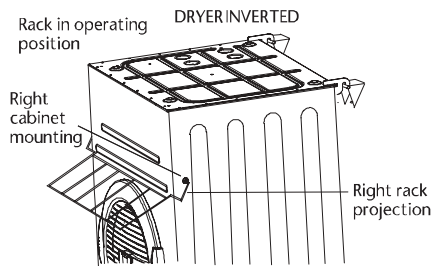

FIG. 2.

# RACK FITTING INSTRUCTION

## RACK STORAGE - DRYER INVERTED.

To hold the dryer rack out of the way when not in use, it will be necessary to attach the retaining clip to the base of your dryer.

To do this, firstly remove the screw located 4 cm from the right corner of the inverted dryer ( Fig.3).

Then position the retaining clip over the hole so that the prong on the clip is near the cabinet corner and faces outwards (Fig.4). Tighten clip using the same screw. Repeat this on the left side.

Fit dryer rack to its cabinet mountings. Tilt rack upwards and align retaining clip until rack frame "snaps" into the prongs of the retaining clips (Fig. 4).

## LOADING DRYER RACK

To make use of the drying rack, firstly rotate the outlet grill so that the louvers point towards the rack.

Place items to be dried at the centre of the rack for best airflow.

Shoes should be placed upside down.

A large woollen article e.g. a cardigan, should be placed over the whole rack, and to ensure more even drying will need rearranging from time to time.

### Caution:

1. The maximum weight placed on the dryer rack should not exceed 1 kg.
2. Make sure the clothes are suitable for the dryer.
3. As the exhaust air temperature rises at the end of a normal drying cycle, it is important that you regularly check items on the rack to make sure they are not overheated.

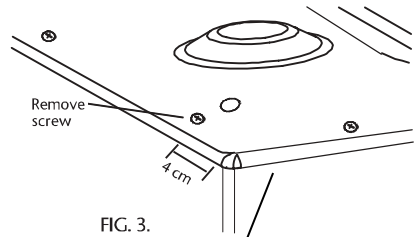

FIG. 3.

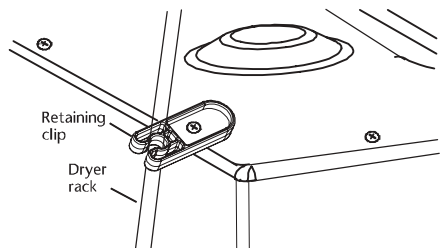
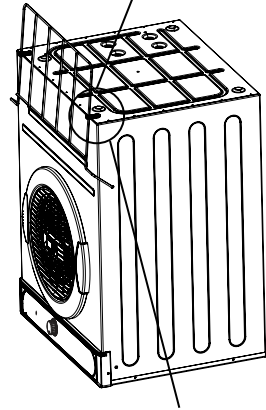

FIG. 4.

## TROUBLESHOOTING

The following must be confirmed before calling for service:

Problem	Possible Cause
The dryer does not start	<ul style="list-style-type: none"> <li>-Is the dryer plugged in?</li> <li>-Is the power on?</li> <li>-Is the door closed properly?</li> <li>-Has a drying program been set?</li> <li>-Has the Start button been pressed?</li> </ul>
The drying result is not good	<ul style="list-style-type: none"> <li>-Was the correct drying program set?</li> <li>-Is the filter screen clean?</li> <li>-Did the amount of the loaded laundry exceed the rated load?</li> <li>-Was the loaded laundry spun dry before being loaded into the dryer?</li> <li>-Did the laundry become twisted during drying?</li> </ul>

## WIRING CIRCUIT

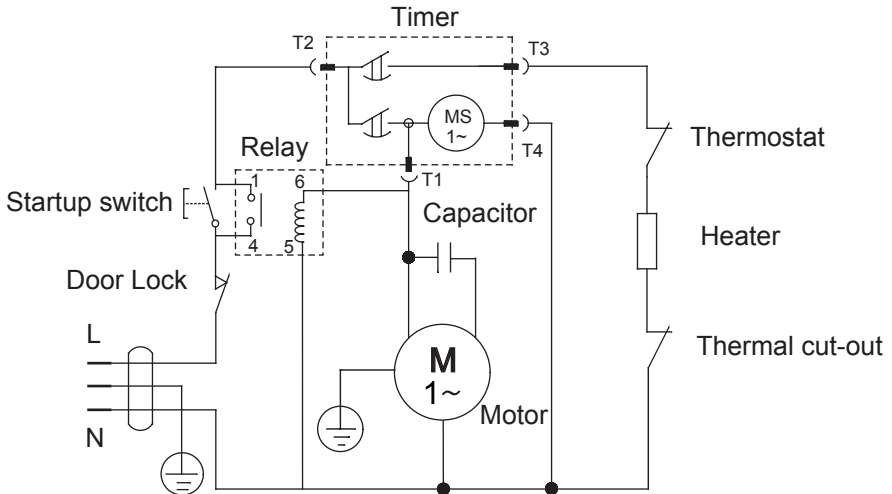

## SPECIFICATIONS

ITEM	TYPE	HDY-M60	HDY-M40
Power supply		(220-240)V~/50Hz	(220-240)V~/50Hz
Maximum operating current (A)		10	10
Rated load (kg)		6	4
Maximum power (W)		2100	2100
Dimensions (HxDxW) mm		830 x 560 x 600	830 x 445 x 600
Weight (kg)		30	27
Waterproof degree		IPX 4	IPX 4



## Free Manuals Download Website

<http://myh66.com>

<http://usermanuals.us>

<http://www.somanuals.com>

<http://www.4manuals.cc>

<http://www.manual-lib.com>

<http://www.404manual.com>

<http://www.luxmanual.com>

<http://aubethermostatmanual.com>

Golf course search by state

<http://golfingnear.com>

Email search by domain

<http://emailbydomain.com>

Auto manuals search

<http://auto.somanuals.com>

TV manuals search

<http://tv.somanuals.com>