

Haier[®]

HL19KN1/HL22KN1



LCD TV

USER MANUAL

Please read this manual carefully
before using this TV set and keep it
for future reference.

WARNING AND CAUTION



The lightning flash with arrowhead symbol, within an equilateral triangle is intended to alert the user to the presence of uninsulated dangerous voltage within the product's enclosure that may be of sufficient magnitude to constitute a risk of electric shock.



The exclamation point within an equilateral triangle is intended to alert the user to the presence of important operating and maintenance (servicing) instructions in the literature accompanying the appliance.

WARNING: TO PREVENT FIRE OR SHOCK HAZARD, DO NOT EXPOSE THIS APPLIANCE TO RAIN OR MOISTURE.

CAUTION: TO PREVENT ELECTRIC SHOCK DO NOT USE THIS POLARIZED PLUG WITH AN EXTENSION CORD, RECEPTACLE OR OTHER OUTLET UNLESS THE BLADES CAN BE FULLY INSERTED TO PREVENT BLADE EXPOSURE.

CAUTION: These servicing instructions are for use by qualified service personnel only. To reduce the risk of electric shock, do not perform any servicing other than that contained in the operating instructions unless you are qualified to do so.

IMPORTANT SAFETY INSTRUCTIONS

Important Safety Instructions

- 1) Read these instructions.
- 2) Keep these instructions.
- 3) Heed all warnings.
- 4) Follow all instructions.
- 5) Do not use this apparatus near water.
- 6) Clean only with dry cloth.
- 7) Do not block any ventilation openings. Install in accordance with the manufacturer's instructions.
- 8) Do not install near any heat sources such as radiators, heat registers, stoves, or other apparatus (including amplifiers) that produce heat.
- 9) Do not defeat the safety purpose of the plug.
- 10) Protect the power cord from being walked on or pinched particularly at plugs, convenience receptacles, and the point where they exit from the apparatus.
- 11) Only use attachments/accessories specified by the manufacturer.
- 12) Use only with the cart, stand, tripod, bracket, or table specified by the manufacturer, or sold with the apparatus. When a cart is used, use caution when moving the cart/apparatus combination to avoid injury from tip-over.



- 13) Unplug this apparatus during lightning storms or when unused for long periods of time.
- 14) Refer all servicing to qualified service personnel. Servicing is required when the apparatus has been damaged in any way, such as power-supply cord or plug is damaged, liquid has been spilled or objects have fallen into the apparatus, the apparatus has been exposed to rain or moisture, does not operate normally, or has been dropped.
- 15) The apparatus shall not be exposed to dripping or splashing and that no objects filled with liquids, such as vases, shall be placed on the apparatus.
- 16) The mains plug or appliance inlet is used as the disconnect device, remain it readily operable during the apparatus normal use.

CONTENT

Front Panel Controls.....	2
Connection Options.....	3
Remote Control Key Functions.....	4
Remote Control.....	5
Installing Batteries.....	5
Connection Instructions.....	6
External equipment Connections.....	6
Antenna Connection.....	6
PC Setup.....	7
VCR Setup.....	8
Cable TV Setup.....	9
External AV Source Setup.....	9
Basic Operating Instructions.....	10
Turn on the LCD-TV.....	10
Audio Control.....	10
Mute.....	10
Select the TV Channel You Want.....	10
P.MODE Mode.....	10
S.MODE Mode.....	11
Sleep.....	11
H.LOCK.....	11
Menu Operations.....	12
Picture Menu Options.....	12
Picture Menu Options Continued.....	13
Sound Menu Options.....	14
Function Menu Options.....	15
Function Menu Options Continued.....	16
Tuner Menu Options.....	17
Timer Menu Options.....	18
Adjust Menu Options.....	19
Troubleshooting Guide.....	20
Specifications.....	21

Safety Notice Items

Incorrect usage may cause fire or electric shock. To prevent this, please do as required when you are installing, using and cleaning this machine. To ensure your safety and extend the life-span of LCD-TV, please read the following items carefully before using:

- Please read and understand all the instructions before operation;
- Please keep this manual for later use;
- Please comply strictly with the warning instructions on the machine and in this book;
- Please comply with the instructions provided;
- Please do not use additional devices that are not recommended by manufacturer:
- Before operation, please make sure that the operating voltage of your unit is correct;
- Do not place the unit on unstable, dusty and humid places;
- Never put the unit in direct sunlight or near heat sources;
- Allow enough space for proper ventilation;
- Please keep water away from the LCD-TV . If water comes in contact with the LCD-TV, disconnect the power cord from the power source, then wipe the set with a dry soft cloth;
- Do not remove the back cover. If service is needed, please contact an Authorized service technician.

Front Panel Controls

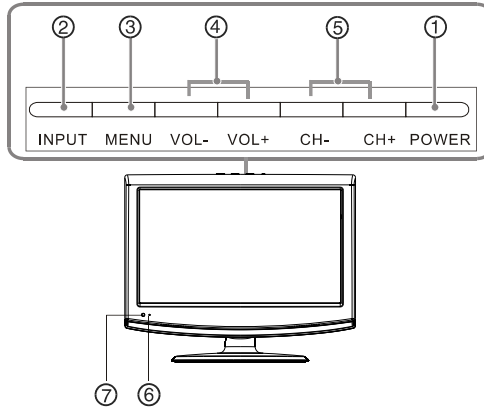

Control Panel Function

1. Power supply switch
2. **INPUT** Select the input signals: TV/AV/S-VIDEO/PC/COMPONENT/HDMI
3. **MENU** Press to select the main menu
4. **VOL-** Volume down / Left orientation to adjust the item in the OSD
VOL+ Volume up / Right orientation to adjust the item / Press to enter
5. **CH-** TV channel down / to select the item in the menu
CH+ TV channel up / to select the item in the menu
6. Power indicator
Illuminates red in standby mode, illuminates green when the display is turned on
7. Remote Sensor Receiving remote control sends the infrared remote signal.

Connection Options

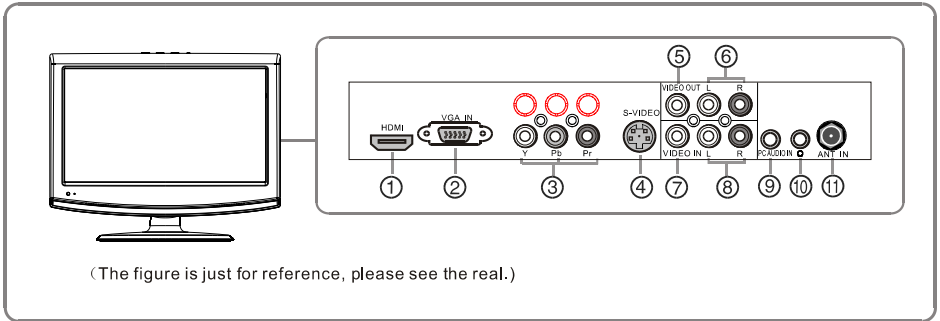

1. **HDMI** Connect to HDMI output of other equipment.
2. **VGA** Connect to the VGA 15PIN analog output connector of a PC graphics card to use set as a PC display.
3. **Component Input** Connect a component video device to these jacks.
4. **S-VIDEO** Connect S-Video out from an S-Video device to the jacks.
5. **VIDEO Out** Connect video input from an external device to this jack.
6. **AUDIO Out** Connect audio input from an external device to these jacks.
7. **Video in** Connect video output from an external device to this jack.
8. **Audio in** Connect audio output from an external device to these jacks.
9. **PC audio in** Connect the audio output from the pc to the PC audio input port.
10. **Headphone**
11. **ANT IN(Antenna Input)** Connect cable or antenna signals to the TV, either directly or through your cable box.

Remote Control Key Functions

When using the remote control, aim it towards the remote sensor on the TV.

Buttons on the remote control

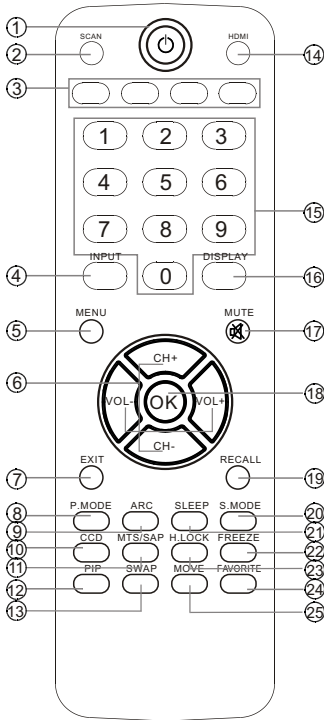

- 1.Power
- 2.SCAN
- 3.Not available
4. Input selection
- 5.MENU
- 6.Volume/Channel Selection
- 7.Exit On Screen Display
- 8.Adjust Picture Mode
- 9.Select the aspect ratio
- 10.Close caption
- 11.Select Mono/SAP/Stereo
- 12.Not available
- 13.Not available
- 14.HDMI mode
- 15.Program Number
- 16.Program Information
- 17.Mute
- 18.Confirm button
- 19.Return to previous channel in TV mode
- 20.Adjust sound mode
- 21.Sleep button
- 22.Not available
- 23.Hotel Lock
- 24.Not available
- 25.Not available

Remote Control

Installing Batteries

Insert two size AAA batteries matching the +/- polarities of the battery to the +/- marks inside the battery compartment.

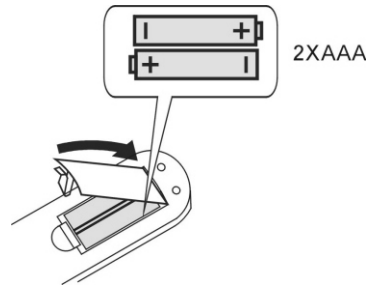

Precautions

Make sure that there is no obstacle between the remote controller and television set.

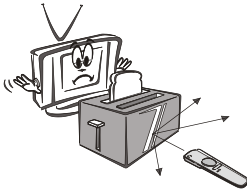

As strong light may interfere with the signals, change your position to operate the remote control if the television cannot be turned on or off as expected.

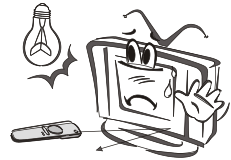

Keep the remote control away from heat sources or humid areas to ensure effective performance of the remote.

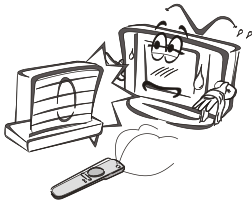

Make sure that two AAA depending up the model alkaline batteries are loaded. The batteries must be of the same type, must be inserted properly, and must not be rechargeable.

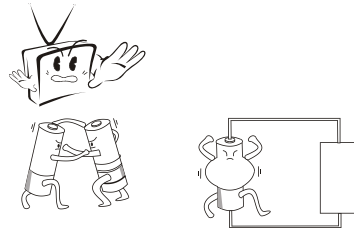

Connection Instructions

External Equipment Connections

Antenna Connection

- Antenna or Cable Service with a Cable Box Connections
- For optimum picture quality, adjust antenna direction if needed.

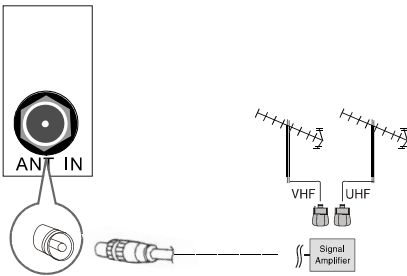
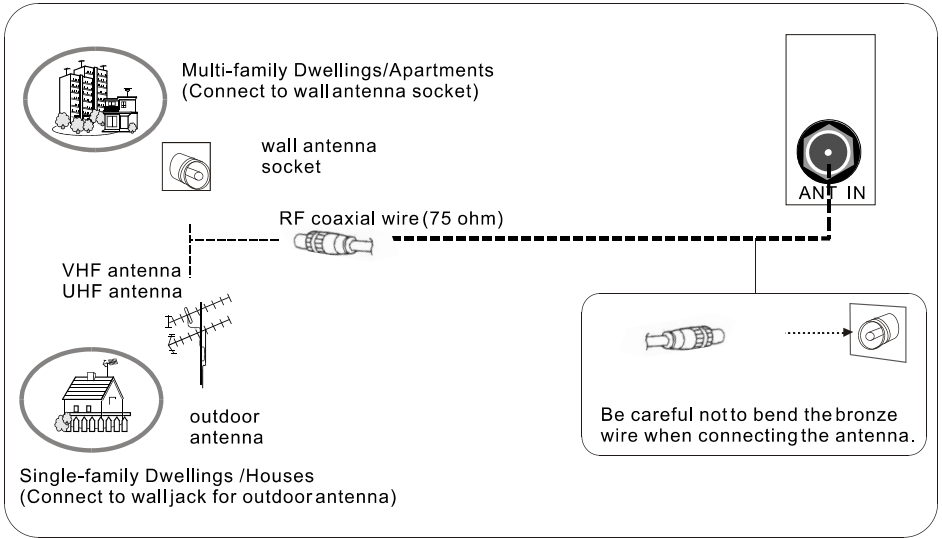

- To improve picture quality in a poor signal area, purchase and install a signal amplifier.
- If the antenna needs to be split for two TV' s, install a "2-Way Signal Splitter" in the connections.
- If the antenna is not installed properly, contact your dealer for assistance.

Note:All cables shown are just for example.

Connection Instructions

PC Setup

You can use your LCD-TV as a monitor for your personal computer using a VGA cable (not supplied).

Connection and use steps:

1. Read the userguide supplied with your computer and ensure that it has a VGA connector;
2. Make sure that the power of the LCD -TV and the PC are off;
3. Connect a D type 15-pin VGA interface cable (not supplied) to the VGA video interface connector on the PC. Then connect the other end to the PC video interface connector on the back of the LCD-TV. Tighten the screws on the VGA connectors once they are firmly connected;
4. Turn on the power of the LCD-TV first , and then turn on the power of the PC;
5. Press **INPUT** button to set the video input mode of the LCD-TV to PC;
6. Check the image on your TV. There may be noise associated with the resolution, vertical pattern, contrast or brightness in PC mode. If noise is present, change the PC mode to another resolution, change the refresh rate to another rate or adjust the brightness and contrast on the menu until the picture is clear. If the refresh rate of the PC graphic card can not be changed, change the PC graphic card or consult the manufacturer of the PC graphic card.

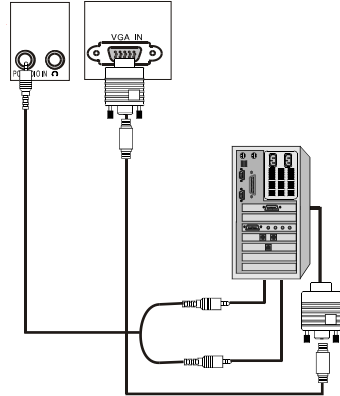

Resolution

Mode	Resolution	Line frequency (Khz)	Frame frequency (Hz)
VGA	640*480	31.5KHz	60Hz
SVGA	800*600	37.9KHz	60Hz
XGA	1024*768	48.4KHz	60Hz

Note: All above listed are subject to VESACriteria.

YPbPr Input

How to connect

Connect the DVD video outputs (Y, PB, PR) to the COMPONENT (Y, Pb, Pr) IN jacks on the TV and connect the DVD audio outputs to the AUDIO IN jacks on the TV, as shown in the figure.

NOTE: If your DVD player does not have component video output, use S-Video.

How to use

1. Turn on the DVD player, insert a DVD.
2. Use **INPUT** button on the remote control to select.

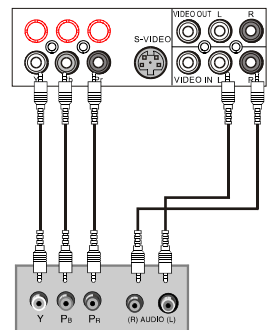

Connection Instructions

VCR Setup

To avoid picture noise (interference), leave an adequate distance between the VCR and TV.

Connection and use steps:

1. Read the user guide supplied with your AV devices and ensure that it has S-Video connectors;
2. Make sure that the power of the LCD-TV and the AV device are off;

Connection Option 1

Set VCR output switch to 3 or 4 and then tune TV to the same channel number.

Connection Option 2

1. Connect the audio and Svideo cables from the VCR's output jacks to the TV input jacks, as shown in the figure.
2. Insert a video tape into the VCR and press PLAY on the VCR. (Refer to the VCR owner's manual.)
3. Turn on the power of the LCD-TV first ; and then turn on the power of the AV device;
4. Press **INPUT** button to set the video input mode of the LCD-TV to S-VIDEO mode .

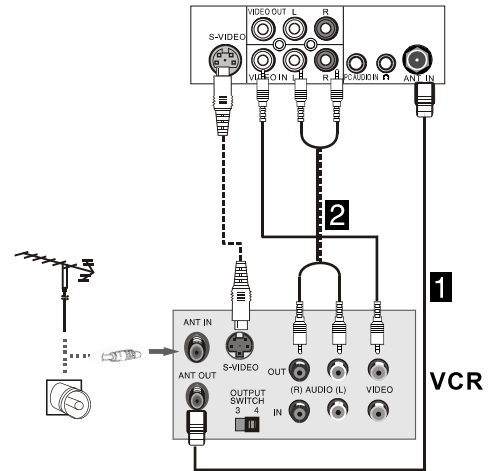

Connection Instructions

Cable TV Setup

After subscribing to a cable TV service from a local provider you can watch cable TV programming. The TV cannot display TV programming unless a TV tuner device or cable TV converter box is connected to the TV.

For further information regarding cable TV service, contact your local cable TV service provider(s).

Connection Option 1

1. Select 3 or 4 with channel switch on cable box.
2. Tune the TV channel to the same selected output channel on cable box.
3. Select channels at the cable box or with the cable box remote control.

Connection Option 2

1. Connect the audio and video cables from the Cable Box's output jacks to the TV input jacks, as shown in the figure. When connecting the TV to a Cable Box, match the jack colors (Video = yellow, Audio Left = white, and Audio Right = red).
2. Select the input source by using the **INPUT** button on the remote control.
3. Select your desired channel with the remote control for cable box.

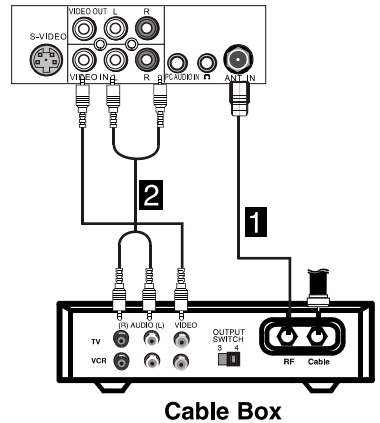

External AV Source Setup

How to connect

Connect the audio and video cables from the external equipment's output jacks to the TV input jacks, as shown in the figure.

When connecting the TV to external equipment, match the jack colors (Video = yellow, Audio Left = white, and Audio Right = red).

How to use

1. Select the input source by using the **INPUT** button on the remote control.
2. Operate the corresponding external equipment. Refer to external equipment operating guide.

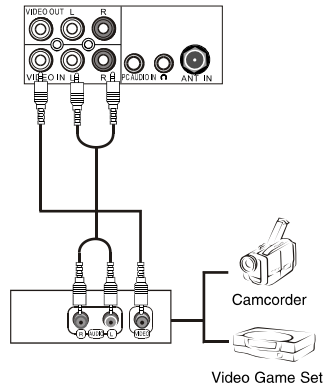

Basic Operating Instructions

Turn on the LCD-TV

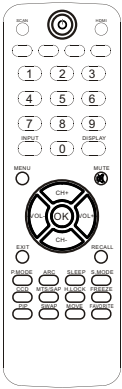

When the **POWER** button on the remote control is pressed and the LCD-TV is turned on, the indicator light on the front of the LCD-TV changes from red to green. When the LCD-TV is turned off using the **POWER** button, the LCD-TV will go into standby mode and the indicator light turns red.

Note:

The display of the input mode will disappear in about 8 seconds.

You can also turn on the TV from standby mode by pressing **CH+/-**.

Switch Among Different Inputs: TV/AV/S-VIDEO/COMPONENT/PC/HDMI. Each time you press **INPUT** button, and then press **CH+/-** to select: TV/AV/S-VIDEO/COMPONENT/PC/HDMI, press **VOL+** to confirm.

Audio Control

1. Press **VOL+** button to increase the volume. A number will appear on screen indicating the volume level.
2. Press **VOL-** button to decrease the volume. A number will appear on screen indicating the volume level.

Mute

1. Press **MUTE** button to mute the sound temporarily. A mute icon appears on the screen.
2. Press **MUTE** button again or **VOL+** to restore the sound. The mute icon disappears.

Select the TV Channel You Want

You can use the number keys on the remote control to directly select TV channels. And you can press the keys on the remote control or on the panel to make a selection.

P.MODE Mode

Press **P.MODE** button on the remote control for menu display. For desired mode as follows: Standard → Soft → Bright → User.

Basic Operating Instructions

S.MODE Mode

Press **S.MODE** button on the remote control for menu display . For desired mode as follows: Standard→ Theater→Music→User.

Sleep

Press **SLEEP** button to set the time : SLEEP Off-SLEEP 5Min-SLEEP 10Min-SLEEP 15Min-SLEEP 30Min-SLEEP 45Min-SLEEP 60Min-SLEEP 90Min-SLEEP 120Min-SLEEP 180Min-SLEEP 240Min.

This feature allows you to turn off the television after a pre-selected number of minutes.

H. LOCK

Press **H.LOCK** to enter it and input the password correctly, the **H.LOCK** menu will appear on the screen (The initial password is 0000).

Change password: The password can be changed. Press **CH+/-** to select Change password and **VOL+/OK** to enter. The screen will display New PW:----, then enter the new password and the screen display Confirm PW:----, if the same password is input correctly twice, the old password will be changed.

Tuner Lock: The tuner can be locked. Press **CH+/-** to select.

Preset Source: Preset the source.

Preset CH.: Preset the channel.

Source Lock: The source can be locked. Press **CH+/-** to select.

Child Lock: Press **CH+/-** to select it . Press **VOL+/-** to set on or off mode. If lock on mode is set, child lock is inactivated automatically. In such case, buttons on the television is useless and only buttons on remote control can be used, if buttons on the television are pressed, the screen will display Child Lock.

The child lock mode can be resumed by entering lock set menu, set child lock on.

Unlocked: Press to turn to the unlocked mode.

Menu Operations

In this manual, the OSD (On Screen Display) may be different from your TV s because it is just an example to illustrate the TV operation.
Press INPUT to select the input source, and the menu for each source is different.

1. Press MENU button to display the main menu, and VOL +/- to select the main menu.
2. Press CH +/- to scroll through the parameters.
3. Press VOL +/- buttons to make changes to the parameters.
4. Press EXIT button to exit the menu.

Picture Menu Options

Picture quality can be adjusted for any input separately .

The picture quality on the screen can be adjusted as follows:

1. Press **MENU** button and **VOL +/-** until the following menu appears on the screen.

PC/COMPONENT MENU

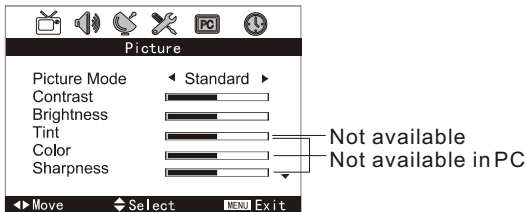

TV/AV/S-VIDEO MENU

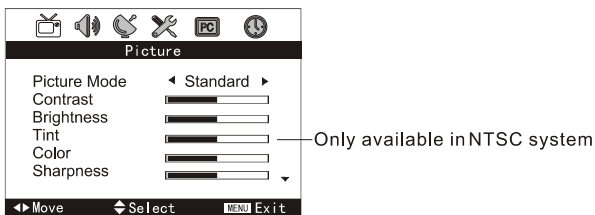

Note: Symbols on top of the menu in this manual may be different from the actual set.

Menu Operations

Picture Menu Options continued

2. Press **CH+/-** button to enter the picture menu and to go up and down to select the desired option .
3. Press **VOL+/-** button to increase and decrease the level to adjust the selected option to your preference .
4. Repeat step 2 and step 3 until desired picture quality has been achieved .

Function:

Picture Mode: Press **VOL+/-** to select: Standard→ Soft→Bright→User.

Contrast : Adjust the contrast of the picture . The contrast becomes higher as the number increase.

Brightness : Adjust the brightness of the picture. By increasing the level, it will add more light to dark parts of the picture and by decreasing the level ,it will add more dark to light parts of the picture.

Tint: Adjust the picture tone.

Color : Press **VOL+/-** to adjust the color.

Sharpness : Adjust the amount of the detail enhancement , the image sharpness rises as the number increases (By increasing the level, it will show cleaner and clearer images and by decreasing the level, it will make picture smoother).

Color Temp. : Press to select the color temperature from Standard/Warm/Cool.

Reset : Reset all settings to factory mode.

Menu Operations

Sound Menu Options

Sound can be adjusted for any input as follows:

1. Press **MENU** and **VOL+/-** button until the following menu appears on the screen.

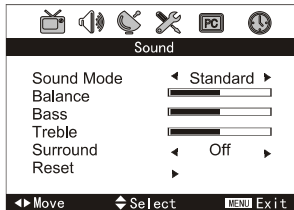

You can adjust sound options to the levels you prefer.

2. Press **CH+/-** button to enter the audio menu and to go up and down to select the desired option .
3. Press **VOL+/-** button to increase and decrease the level to adjust the selected option to your preference .
4. Repeat step 2 and step 3 until desired sound quality has been achieved ..

Function :

Sound Mode: Press **VOL+/-** to select: Standard/Theater/Music/User.

Balance : Adjust the balance of the audio output from left to right . When indication value of balance increases toward +50 , sound of the left speaker becomes weaker . When indication value of balance decreases toward -50 , sound of the right speaker become weaker. Can only be adjust under User mode.

Bass : Adjust the bass of the sound . Can only be adjust under User mode.

Treble: Adjust the treble of the sound . Can only be adjust under User mode.

Surround: To turn the simulated surround sound on or off.

Reset : Reset all settings to factory mode.

Menu Operations

Function Menu Options

Menu Language Selection:

The menus can be shown on the screen in the selected language. First select your language.

1. Press MENU button and VOL+/- until the following menu appears on the screen.

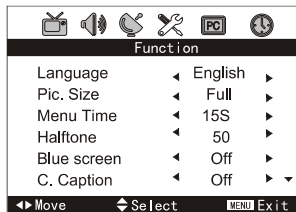

2. Press CH+/- button to enter the function menu and to go up and down to select the desired option .

3. Press VOL+/- button to adjust the selected option to your preference .

Functions:

Language: This item displays the language of the OSD.

Pic. Size: To select the display mode :4:3/Full/Zoom.

Menu Time: To select 5S/10S/15S.

Halftone: To select the menu transparency.

Blue screen : Press VOL+/- to select On or Off. To set On, screen will be in blue screen after 3 seconds if there is no signal.

C. Caption: Press VOL+/- buttons to select the Closed Caption options. Closed Captioning helps the hearing impaired with the broadcast program, as well as helping children learn how to read. A built in decoder displays the audio portion of a program as text on the screen when this option is selected.

Off: When Off is displayed on TV, it means CC Mode is turned off.

CC1: When CC1 is displayed on TV means CC Mode is turned on.

CC2 to CC4: For other modes of video related broadcast information.

TT1: For program guide and other information displayed by broadcasters.

(This blocks a large portion of the picture on your screen).

TT2 to TT4 :For other modes of information displayed by broadcasters.

(This blocks a large portion of the picture on your screen).

Menu Operations

Function Menu Options Continued

IMPORTANT: Closed captioning availability entirely depends on broadcasters supplying the signal. Therefore, closed captioning might not always be available and language availability will differ by broadcast.

Note: *Select CC1 for full translation of the primary language such as English in your area. Select CC2 for secondary language translation such as French or any other language that may be broadcast in your area.*

DNR: Digital Noise Reduction. Reduces the appearance of digitizing errors caused by compression. Press VOL+/- to select On or Off.

Menu Operations

Tuner Menu Options

1. Press MENU and VOL+/- button until the following menu appears on the screen.

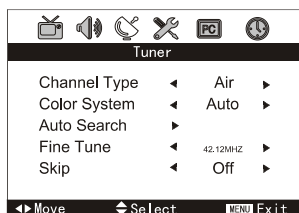

Note: This menu is only appears in TV mode .

2. Press CH+/- button to enter the turning menu and to go up and down to select the desired option .
3. Press VOL+/- button to adjust the selected option to your preference .

Functions:

Channel Type: Press VOL+/- to select Air or cable.

Color System: Press VOL+/- to select Auto/NTSC/PAL N/PAL M.

Auto Search: Auto search and save the channel . Press the VOL+ button to start automatic search function operation. All channels now available will be automatically preset in order . After the search has finished, the first program number will display on the screen. This search automatically adds only the active channels in your area to the TV's memory. It deletes any channels on which there is no broadcast or a poor signal.

Note: The Auto Search function will scan the channels on the selected Air input. If the TV is connected to cable, please select Cable under ' Air ' sub menu.

Fine Tune : If the image and / or sound received is not very good , you can press CH+/- to select Fine Tune in the menu . Then , press VOL+/- button to adjust and improve the image quality. Do not use this feature unless reception is poor.

Skip : If you want skip a channel , press VOL+/- to select On , and this channel will be skipped next time when you press CH+/- . You can press the digit buttons to select the channel . If you want to restore the channel , select Off.

Menu Operations

Timer Menu Options

1. Press MENU and VOL+/- button until the following menu appears on the screen.

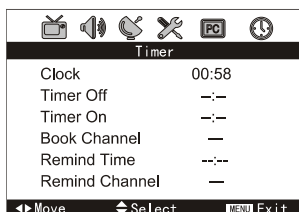

2. Press CH+/- button to enter the turning menu and to go up and down to select the desired option .
3. Press VOL+/- button to adjust the selected option to your preference.

Functions:

Clock: Set the Correct time.

Time Off: Set the time that the TV goes off automatically.

Time On: Set the time that the TV comes on automatically.

Book Channel: Set the channel that the TV comes on automatically.

Remind Time: Set the time that you want to remind.

Remind Channel: Set the channel that you want to remind.

Menu Operations

Adjust Menu Options

1. Press MENU and VOL+/- button until the following menu appears on the screen.

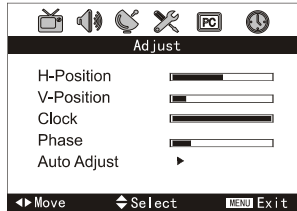

Note: This menu is only appears in PC mode .

2. Press CH+/- button to enter the adjust menu and to go up and down to select the desired option .
3. Press VOL+/- button to increase and decrease the level to adjust the selected option to your preference .

Functions:

H-Position: Picture horizontal position adjust.

V-Position: Picture vertical position adjust.

Clock : Adjust the TFT-LCD to match the PC input source.

Phase : Removes any horizontal distortion and clears or sharpness the displayed characters.

Auto Adjust : Is opted for adjustment of picture location frequency and phase parameters.

Troubleshooting Guide

To assist in location possible faults use help guide below.

Troubleshooting

No picture, no sound	Verify if the television is properly plugged in. Verify if the television is properly supplied with power. Verify that electricity is available.
Blank screen	Verify if correct signals are input. Press INPUT button to change signal input to TV input. Restart the television if power supply is interrupted.
No sound	Press MUTE button and verify if Mute mode is on. Switch to another channel and verify if the same problem happens. Press VOL+ button to see if the problem can be solved.
Poor sound	Verify if sound system is functional. Refer to chapter on adjusting.
No picture in some channel	Verify if correct channel is selected. Adjust the antenna. Make adjustments by FINE TUNE
No color for some channel program (black and white)	Verify if the same problem exists in other channels. Check picture and sound systems. Refer to relative instructions in the Manual for color adjust.
Spots with some or all pictures	Verify if the antenna is correctly connected. Verify if the antenna is in good condition. Make fine adjustment of channel.
Abnormal functioning	Disconnect the television from power supply and, 10 seconds later, reconnect to the power supply. If the problem still exists, contact an authorized service depot for technical assistance.

Note:

- 1.If the fault can not be repaired using the above guide consult with your local authorized service center.
- 2.The TV set must only be repaired by a qualified registered service person. Never attempt to remove the back cover as the TV set has dangerous voltages levels inside that may be fatal or cause fire.

Specifications

Specifications of the television that you have just purchased may vary from the information in this table due to technical innovations.

Model	19"	22"
Picture, sound system	PALM, PAL N, NTSC M	
Audio output	≥2.5W+2.5W	
External jack	COMPONENT input, PC input, S-VIDEO input, Audio input, Video input, Antenna input, HDMI input, A/V out, PC Audio in, Headphone	
Power requirements	~110-220V 50/60Hz	
Power consumption	≤50W	≤60W
Temperature	Working:5°C~35°C Storage:-15°C~45°C	
Humidity	Working:20%~80% Storage: 5%~90%	
Accessories	Remote control Batteries Owner's manual	

NOTE

Design and specifications are subject to change without notice.
Dimensions quoted in this manual are approximate.

Haier®

Free Manuals Download Website

<http://myh66.com>

<http://usermanuals.us>

<http://www.somanuals.com>

<http://www.4manuals.cc>

<http://www.manual-lib.com>

<http://www.404manual.com>

<http://www.luxmanual.com>

<http://aubethermostatmanual.com>

Golf course search by state

<http://golfingnear.com>

Email search by domain

<http://emailbydomain.com>

Auto manuals search

<http://auto.somanuals.com>

TV manuals search

<http://tv.somanuals.com>