

Haier

- HWO60B7EX2

USER INSTRUCTIONS

OVENS

EN 02

SAFETY AND WARNINGS

Your oven has been carefully designed to operate safely during normal cooking procedures. Please keep the following safety instructions in mind when you are using it:

⚠ WARNING!



Electrical Shock Hazard

Turn the oven off at the wall before replacing the oven lamp or before carrying out any work or maintenance on it. Failure to follow this advice may result in electrical shock or death.

⚠ WARNING!

Fire Hazard

Do not place aluminium foil, dishes, trays, water or ice on the oven floor during cooking, as doing so will irreversibly damage the enamel; lining the oven with aluminium foil or single use protection available from stores may even cause fire.



Never use your appliance for warming or heating the room.

Persons could be burned or injured or a fire could start.

Storage in or on appliance: flammable materials should not be stored in an oven or near its surface.

Failure to follow this advice may result in overheating, burning, and injury.

⚠ WARNING!

Hot Surface Hazard

Accessible parts may become hot when in use. To avoid burns and scalds, be careful not to touch any hot part and keep children away. Use oven mitts or other protection when handling hot surfaces such as oven shelves or dishes.

Use care when opening the oven door. Let hot air or steam escape before removing or replacing food.

Do not touch heating elements or interior surfaces of the oven. Heating elements may be hot even though they are dark in colour.



Interior surfaces of an oven become hot enough to cause burns.

During and after use, do not touch, or let clothing or other flammable materials contact heating elements or interior surfaces of the oven until they have had sufficient time to cool.

Other surfaces of the appliance may become hot enough to cause burns - among these surfaces are the oven vent, the surface near the oven vent, and the oven door.

Failure to follow this advice could result in burns and scalds.

⚠ WARNING!

Cut Hazard



Take care during installation of the oven - some edges are sharp.

Failure to use caution could result in injury or cuts.

IMPORTANT SAFETY INSTRUCTIONS

To reduce the risk of fire, electrical shock, injury to persons or damage when using the oven, follow the important safety instructions listed below:

- Read all the instructions before using the oven. Use the oven only for its intended purpose as described in these instructions.
- Proper installation: be sure your appliance is properly installed and earthed by a qualified technician.

- Isolating switch: make sure this oven is connected to a circuit which incorporates an isolating switch providing omnipolar disconnection from the power supply the device must have contact separation compliant to the requirements for overvoltage category III, must bear the maximum connected load and in must be in line with current legislation. The switch must be incorporated in the fixed wiring in accordance to the wiring rules.

The yellow-green earth cable should not be interrupted by the device and must be easily accessible when the appliance is installed.

- Household appliances are not intended to be played with by children.
- Do not leave children alone.

Children should not be left alone or unattended in the area where the appliance is in use. They should

SAFETY AND WARNINGS

never be allowed to sit or stand on any part of the appliance.

- Children of less than 8 years old must be kept away from the appliance unless continuously supervised. This appliance can be used by children aged from 8 years and above, and persons with reduced physical, sensory or mental capabilities or lack of experience and knowledge, if they have been given supervision or instruction concerning the use of the appliance in a safe way and they understand the hazards involved.

Cleaning and user maintenance shall not be done by children without supervision.

- Do not place heavy objects on the oven door.
- Wear proper apparel. Do not wear loose fitting or hanging garments when using the appliance. They could ignite or melt if they touch an element or hot surface and you could be burned.
- User servicing: do not repair or replace any part of the appliance unless specifically recommended in the manual. All other servicing should be referred to a qualified technician.
- Do not use water on grease fires. Smother the fire or flame or use a dry chemical or foam type extinguisher.
- Use only dry oven mitts or potholders.

Moist or damp potholders on hot surfaces could

SAFETY AND WARNINGS

result in burns from steam. Do not let potholders touch hot areas or heating elements. Do not use a towel or a bulky cloth for a potholder. It could catch fire.

- Do not heat unopened food containers. They can build up pressure that may cause the container to burst and result in injury.
- Safe food handling: leave food in the oven for as short a time as possible before and after cooking. This is to avoid contamination by organisms which may cause food poisoning. Take particular care during warm weather.
- Always keep oven vents unobstructed.
- Do not operate your appliance by means of an external timer or separate remote-control system.
- Caution: Hot air can blow from the vent at the top of the oven as part of the oven's cooling system.
- Placement of oven shelves: always position shelves in the desired location while the oven is cool (before preheating). If a shelf must be removed while the oven is hot, do not let the oven mitts or potholder contact hot heating elements in the oven or the base of the oven.
- When you place the shelf inside, make sure that the stop is directed upwards and in the back of the cavity. The shelf must be inserted completely into the cavity.

SAFETY AND WARNINGS

- Do not clean the oven seal or use any oven-cleaning products on it. It is essential for a good seal, which ensures that the oven operates efficiently. Care should be taken not to rub, damage or move it.
- Do not use oven cleaners, harsh/abrasive cleaning agents, waxes, or polishes. No commercial oven cleaner, oven liner, or protective coating of any kind should be used in or around any part of the oven. Do not use harsh/abrasive cleaners, scourers or sharp metal scrapers to clean the oven door glass since they scratch the surface, which may result in the glass shattering.
- Clean only the parts listed in this manual.
- Do not use a steam cleaner to clean any part of the oven.
- Do not store things children might want above the oven. Children could be burned or injured while climbing on the oven to retrieve items.
- Do not install or operate the appliance if it is damaged or not working properly. If you receive a damaged product, contact your dealer or installer immediately.
- Use only bakeware approved for oven use. Follow the bakeware manufacturer's instructions.
- No additional operation/setting is required in order to operate the appliance at the rated

frequencies.

- If the power cable is damaged, it should be substituted with a cable or special bundle available from the manufacturer or by contacting the customer service department. The type of power cable must be H05V2V2-F. This operation should be carried out by a suitably qualified professional. The earth conductor (yellow-green) must be approximately 10 mm longer than the other conductors. For any repairs, refer only to the Customer Care Department and request the use of original spare parts. Failure to comply with the above can compromise the safety of the appliance and invalidate the guarantee.
- The oven must be switched off before removing the removable parts. After cleaning, reassemble them according the instructions.
- **WARNING:** Never remove the oven door seal.
- When inserting the grid tray pay attention that the anti-slide edge is positioned rearwards and upwards
- The appliance must not be installed behind a decorative door in order to avoid overheating.
- Before using the appliance, it must be installed following installation instruction at the end of this manual.

General Instructions	12	1.1 Safety indications 1.2 Electrical safety 1.3 Recommendations 1.4 Installation 1.5 Waste management 1.6 Conformity declaration
----------------------	----	--

Product Description	14	2.1 Overview 2.2 Accessories 2.3 First use
---------------------	----	--

Use of the Oven	15	3.1 Display description 3.2 Cooking modes
-----------------	----	--

Oven Cleaning and Maintenance	18	4.1 General notes on cleaning 4.2 Self-cleaning oven with catalytic panels 4.3 Maintenance <ul style="list-style-type: none">• Instruction for removal and cleaning of the side racks• Removal and cleaning of the door glass• Changing the bulb
-------------------------------	----	--

Troubleshooting	21	5.1 F.A.Q.
-----------------	----	------------

Installation	22	6.1 Equipped with fixing brackets
--------------	----	-----------------------------------

1. General Instructions

We thank you for choosing one of our products. For the best results with your oven, you should read this manual carefully and retain it for future reference. Before installing the oven, take note of the serial number so that you can give it to customer service staff if any repairs are required. Having removed the oven from its packaging, check that it has not been damaged during transportation. If you have doubts, do not use the oven and refer to a qualified technician for advice. Keep all of the packaging material (plastic bags, polystyrene, nails) out of the reach of children. When the oven is switched on for the first time, strong smelling smoke can develop, which is caused by the glue on the insulation panels surrounding the oven heating for the first time. This is absolutely normal and, if it occurs, you should wait for the smoke to dissipate before putting food in the oven. The manufacturer accepts no responsibility in cases where the instructions contained in this document are not observed.



NOTE: the oven functions, properties and accessories cited in this manual will vary, depending on the model you have purchased.

1.1 Safety Indications

Only use the oven for its intended purpose, that is only for the cooking of foods; any other use, for example as a heat source, is considered improper and therefore dangerous. The manufacturer cannot be held responsible for any damage resulting from improper, incorrect or unreasonable usage.

The use of any electrical appliance implies the observance of some fundamental rules:

- do not pull on the power cable to disconnect the plug from the socket;
- do not touch the appliance with wet or damp hands or feet;
- in general the use of adaptors, multiple sockets and extension cables is not recommended;
- in case of malfunction and/or poor operation, switch off the appliance and do not tamper with it.

1.2 Electrical Safety

ENSURE THAT AN ELECTRICIAN OR QUALIFIED TECHNICIAN MAKES THE ELECTRICAL CONNECTIONS.

The power supply to which the oven is connected must conform with the laws in force in the country of installation. The manufacturer accepts no responsibility for any damage caused by the failure to observe these instructions. The oven must be connected to an electrical supply with an earthed wall outlet or a disconnecter with multiple poles, depending on the laws in force in the country of installation. The electrical supply should be protected with suitable fuses and the cables used must have a transverse section that can ensure correct supply to the oven.

CONNECTION

The Appliance should only be connected via a suitable cable, to an electrical supply with 220-240V AC power between phases or between the phase and neutral.

Before the oven is connected to the electrical supply, it is important to check:

- Oven Max output on the rating plate.
- Correctly rated circuit breaker/fuse.

The grounding wire connected to the ovens earth terminal must be connected to the earth terminal of the power supply.

WARNING

Before connecting the oven to the power supply, ask a qualified electrician to check the continuity of the power supply's earth terminal. The manufacturer accepts no responsibility for any accidents or other problems caused by failure to connect the oven to the earth terminal or by an earth connection that has defective continuity.

NOTE: as the oven could require maintenance work, it is advisable to keep another wall socket available so that the oven can be connected to this if it is removed from the space in which it is installed. The power cable must only be substituted by technical service staff or by technicians with equivalent qualifications.

1.3 Recommendations

After each use of the oven, a minimum of cleaning will help keep the oven perfectly clean.

Do not line the oven walls with aluminium foil or single-use protection available from stores. Aluminium foil or any other protection, in direct contact with the hot enamel, risks melting and deteriorating the enamel of the insides. In order to prevent excessive dirtying of your oven and the resulting strong smokey smells, we recommend not using the oven at very high temperature. It is better to extend the cooking time and lower the temperature a little. In addition to the accessories supplied with the oven, we advise you only use dishes and baking moulds resistant to very high temperatures.

1.4 Installation

The manufacturers have no obligation to carry this out. If the assistance of the manufacturer is required to rectify faults arising from incorrect installation, this assistance is not covered by the guarantee. The installation instructions for professionally qualified personnel must be followed. Incorrect installation may cause harm or injury to people, animals or belongings. The manufacturer cannot be held responsible for such harm or injury.

The oven can be located high in a column or under a worktop. Before fixing, you must ensure good ventilation in the oven space to allow proper circulation of the fresh air required for cooling and protecting the internal parts. Make the openings specified on last page according to the type of fitting.

1.5 Waste management and environmental protection



This appliance is labelled in accordance with European Directive 2012/19/EU regarding electric and electronic appliances (WEEE). The WEEE contain both polluting substances (that can have a negative effect on the environment) and base elements (that can be reused). It is important that the WEEE undergo specific treatments to correctly remove and dispose of the pollutants and recover all the materials. Individuals can play an important role in ensuring that the WEEE do not become an environmental problem; it is essential to follow a few basic rules:

- the WEEE should not be treated as domestic waste;
- the WEEE should be taken to dedicated collection areas managed by the town council or a registered company.

In many countries, domestic collections may be available for large WEEEs. When you buy a new appliance, the old one can be returned to the vendor who must accept it free of charge as a one-off, as long as the appliance is of an equivalent type and has the same functions as the purchased appliance.

SAVING AND RESPECTING THE ENVIRONMENT

Where possible, avoid pre-heating the oven and always try to fill it. Open the oven door as infrequently as possible, because heat from the cavity disperses every time it is opened. For a significant energy saving, switch off the oven between 5 and 10 minutes before the planned end of the cooking time, and use the residual heat that the oven continues to generate. Keep the seals clean and in order, to avoid any heat dispersal outside of the cavity. If you have an electric contract with an hourly tariff, the "delayed cooking" programme makes energy saving more simple, moving the cooking process to start at the reduced tariff time slot.

1.6 Declaration of compliance

By placing the **CE** mark on the appliance, we are confirming compliance to all relevant European safety, health and environmental requirements which are applicable in legislation for this product.

2. Product Description

2.1 Overview



1. Control panel
2. Shelf positions (side racks if included)
3. Wire shelves
4. Roasting dish
5. Fan (if present)
6. Oven door

2.2 Accessories

Roasting dish

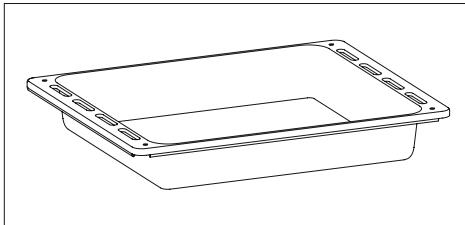

For roasting and grilling. Can be placed on a lower shelf to collect any food drips.

Wire shelf

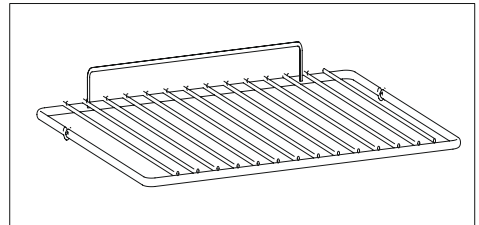

Holds baking trays and plates.

Side racks

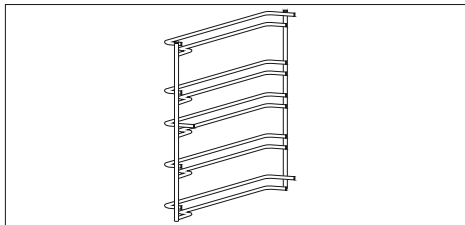

Located on both sides of the oven cavity, holds metal grills and drip pans.

2.3 First Use

PRELIMINARY CLEANING

Clean the oven before using for the first time. Wipe over external surfaces with a damp soft cloth. Wash all accessories and wipe inside the oven with a solution of hot water and washing up liquid. Set the empty oven to the maximum temperature and leave on for about 1 hour, this will remove any lingering smells of newness.

3. Use of the Oven

3.1 Display description

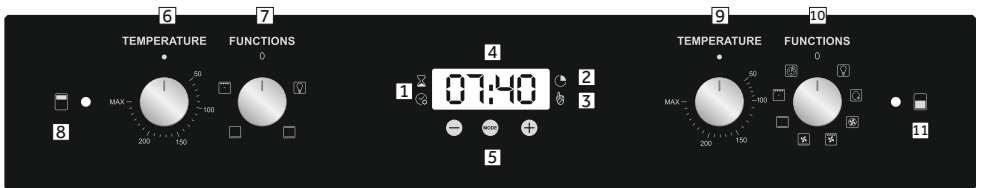



1. Timer
2. Cooking time
3. Child lock
4. Timer display
5. LCD display adjustment controls
6. Thermostat knob (upper cavity)
7. Function selector knob (upper cavity)
8. Upper cavity signal lamp
9. Thermostat knob (lower cavity)
10. Function selector knob (lower cavity)
11. Lower cavity signal lamp

WARNING!









The first operation to carry out after the oven has been installed or following the interruption of power supply (this is recognizable by the display pulsating and showing 12:00) is setting the correct time. This is achieved as follows.

- Push the central button 4 times
- Set time with "-" "+" buttons.
- Release all buttons.

ATTENTION: The oven will only operate providing the clock is set.

FUNCTION	HOW TO USE	HOW TO DEACTIVATE	WHAT IT DOES	WHY IT IS NEEDED
	<ul style="list-style-type: none"> •Child Lock function is activated by touching Set (+) for a minimum of 5 seconds. From this moment on all other functions are locked, LED of child lock turn on, the display will flash STOP and present time every 3 seconds and led of Child Lock turn on . 	<ul style="list-style-type: none"> •Child Lock function is deactivated by touching touchpad Set (+) again for a minimum of 5 seconds. From this moment LED of child lock turn off and all functions are selectable again. 		
MINUTE MINDER 	<ul style="list-style-type: none"> •Push the central button 1 times •Press the buttons "- " "+" to set the required time •Release all the buttons 	<ul style="list-style-type: none"> •When the set time as elapsed an audible alarm is activated (this alarm will stop on its own, however it can be stopped immediately by pressing the button) SELECT. 	<ul style="list-style-type: none"> •Sounds an alarm at the end of the set time. •During the process, the display shows the remaining time. 	<ul style="list-style-type: none"> •Allows to use the oven as alarm clock (could be activated either with operating the oven or with out operating the oven)
COOKING TIME 	<ul style="list-style-type: none"> • Push the central button 2 times • Press the buttons "- " "+" to set the length of cooking required •Release all buttons • Set the cooking function with the oven function selector 	<ul style="list-style-type: none"> •Push any button to stop the signal. Push the central button to return to the clock function. 	<ul style="list-style-type: none"> • It allows to preset the cooking time required for the recipe chosen. • To check how long is left to run press the SELECT button 2 Times. • To alter/change the preset time press SELECT and "- " "+" buttons. 	<ul style="list-style-type: none"> •When the time is elapsed the oven will switch off automatically. Should you wish to stop cooking earlier either turn the function selector to 0, or set time to 0:00 (SELECT and "- " "+" buttons)

3.2 Cooking Modes

Function Dial	T °C default	T °C range	Function <i>(Depends on the oven model)</i>
			LAMP: Turns on the oven light.
			DEFROST PLUS: When the dial is set to this position, fan circulates air at room temperature around the frozen food so that it defrosts without the protein content of the food being changed or altered.
	180	50 - MAX	FAN FORCED: We recommend you use this method for most applications including poultry, pastries, fish and vegetables. Heat penetrates into the food more evenly and both the cooking and preheating times are reduced. You can cook different foods at the same time one or more positions. This cooking method provides even heat distribution. Allow about ten minutes extra when cooking foods at the same time.
	200	50 - MAX	FAN GRILL : use the turbo-grill with the door closed. The top heating element is used with the fan circulating the air inside the oven. Preheating is necessary for red meats but not for white meats. Ideal for cooking thick food items, whole pieces such as roast pork, poultry, etc. Place the food to be grilled directly on the shelf centrally, at the middle level. Slide the roasting tray under the shelf to collect the juices. Make sure that the food is not too close to the grill. Turn the food over halfway through cooking.
	210	50 - MAX	PASTRY PLUS: The bottom heating element is used with the fan circulating the air inside the oven. This method is ideal for fruit flans, tarts, quiches and pastries. It prevents food from drying and encourages rising in cakes, bread dough and other bottom-cooked food. Place the shelf in the bottom position.
	220	50 - MAX	BAKE: Both top and bottom heating elements are used. Preheat the oven for about ten minutes. This method is ideal for all traditional roasting and baking. For searing red meats, roast beef, leg of lamb, game, bread, foil wrapped food, flaky pastry. Place the food and its dish on a shelf in mid position.
	230	50 - MAX	GRILL: use the grill with the door closed. The top heating element is used alone and you can adjust the temperature. Five minutes preheating is required to get the elements red-hot. Success is guaranteed for grills, kebabs and gratin dishes. White meats should be put at a distance from the grill; the cooking time is longer, but the meat will the meat will cook without drying out. Place food on the wire shelf with the roasting dish underneath to catch any drips or directly on to the roasting dish tray.
	210	50 - MAX	TRADITIONAL BAKE: Using the lower element. Ideal for cooking all pastry based dishes. Use this for flans, quiches, tarts, pate and any cooking that needs more heat from below.
	220	50 - MAX	PIZZA PLUS: With this function hot air circulated in the oven to ensure perfect result for dishes such as pizza.

4. Oven cleaning and maintenance

4.1 General notes on cleaning

The lifecycle of the appliance can be extended through regular cleaning. Wait for the oven to cool before carrying out manual cleaning operations. Never use abrasive detergents, steel wool or sharp objects for cleaning, so as to not irreparably damage the enamelled parts. Use only water, soap or bleach-based detergents (ammonia).

GLASS PARTS

It is advisable to clean the glass window with absorbent kitchen towel after every use of the oven. To remove more obstinate stains, you can use a detergent-soaked sponge, well wrung out, and then rinse with water.

OVEN WINDOW SEAL

If dirty, the seal can be cleaned with a slightly damp sponge.

ACCESSORIES

Clean accessories with a wet, soapy sponge before rinsing and drying them: avoid using abrasive detergents.

ROASTING DISH

After using the grill, remove the pan from the oven. Pour the hot fat into a container and wash the pan in hot water, using a sponge and washing-up liquid.

If greasy residues remain, immerse the pan in water and detergent. Alternatively, you can wash the pan in the dishwasher or use a commercial oven detergent. Never put a dirty pan back into the oven.

4.2 Self-cleaning oven with catalytic panels

Special self-cleaning panels covered in a micro-porous coating.

The fat that is splattered onto the sides of the oven during roasting is eliminated by the microporous coating which breaks the fat down by catalysis and transforms it into gas.

Excessive splattering may nevertheless block the pores and therefore hinder self-cleaning. The self-cleaning capacity may be restored by switching on the empty oven to maximum for about 10-20 minutes.

Do not use abrasive products, metal cleaning wads, sharp objects, rough cloths, or chemical products and detergents that may permanently damage the catalytic lining.

It is a good idea to use deep roasting trays to roast fatty foods such as joints of meat etc. and to put a tray underneath the grill to catch surplus fat. If the walls of the oven are so thickly coated in grease that the catalytic lining is no longer effective remove surplus grease with a soft cloth or sponge soaked in hot water.

The lining must be porous for self-cleaning to be effective.

N.B.: All catalytic linings currently on the market have a working life of about 300 hours. They should therefore be replaced after about 300 hours.

OVEN LIGHTING

Disconnect the power supply from the oven before cleaning or replacing the lamp.

The bulb and its cover are made of material resistant to high temperatures.

4.3 Maintenance

INSTRUCTION FOR REMOVAL AND CLEANING OF THE SIDE RACKS

1. Remove the wire racks by pulling them in the direction of the arrows (see below)
2. To clean the wire racks either put them in the dishwasher or use a wet sponge, ensuring that they are dried afterwards.
3. After the cleaning process install the wire racks in reverse order.

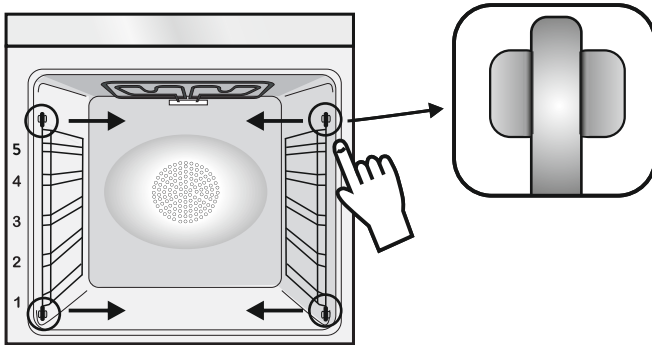

REMOVAL AND CLEANING OF THE DOOR GLASS

1. Open the oven door.

2.3.4. Lock the hinges, remove the screws and remove the upper metal cover by pulling it upwards.

5.6. Remove the glass, carefully extracting it from the oven door (NB: in pyrolytic ovens, also remove the second and third glass (if present)).

7. At the end of cleaning or substitution, reassemble the parts in reverse order.

On all glass, the indication "Pyro" must be legible and positioned on the left side of the door, close to the left-hand lateral hinge. In this way, the printed label of the first glass will be inside the door.

1.



2.

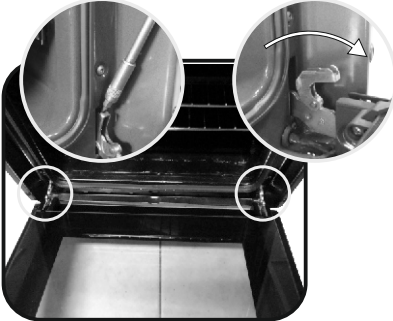

3.

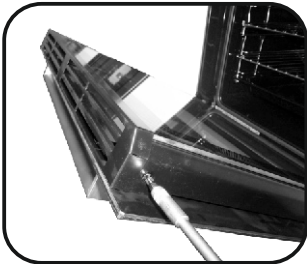

4.

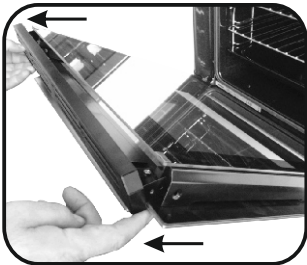

5.

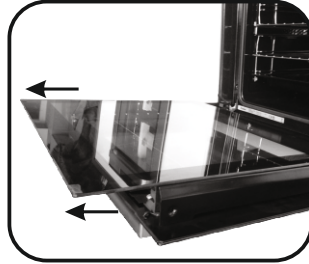

6.

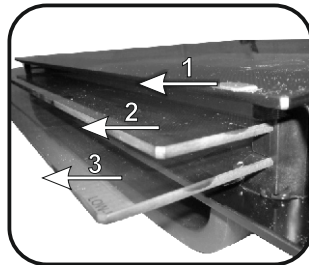

7.

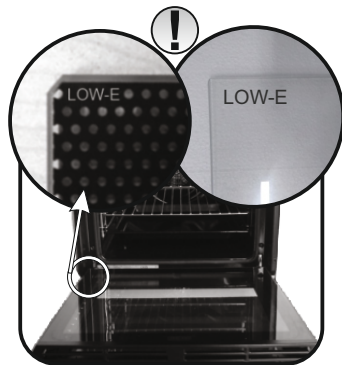

CHANGING THE BULB

1. Disconnect the oven from the mains supply.
2. Undo the glass cover, unscrew the bulb and replace it with a new bulb of the same type.
3. Once the defective bulb is replaced, replace the glass cover.

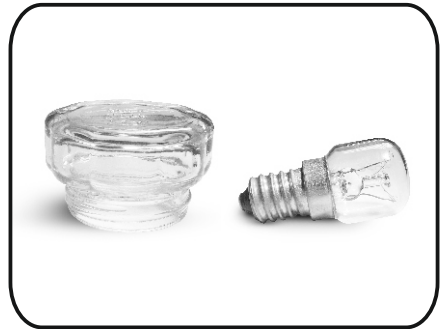

5. Troubleshooting

5.1 FAQ

PROBLEM	POSSIBLE CAUSE	SOLUTION
The oven does not heat up	The clock is not set	Set the clock
The oven does not heat up	The child lock is on	Deactivate the child lock
The oven does not heat up	A cooking function and temperature has not been set	Ensure that the necessary settings are correct

6. Installation

OVEN FITTED UNDER WORKTOP

- VENTILATION REQUIREMENTS MUST BE AS SPECIFIED BY THE DRAWING BELOW

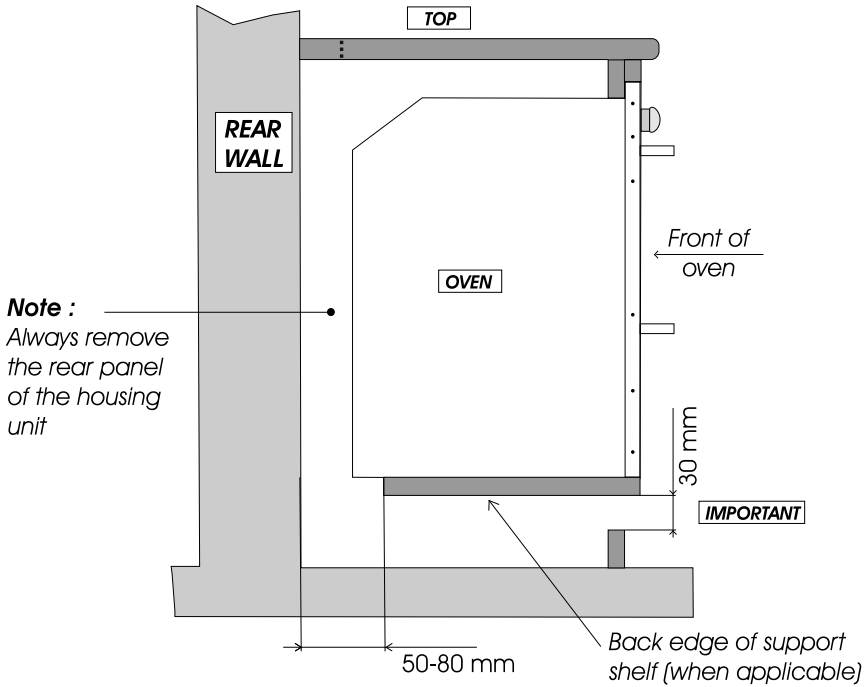

OVEN FITTED BETWEEN CABINETS

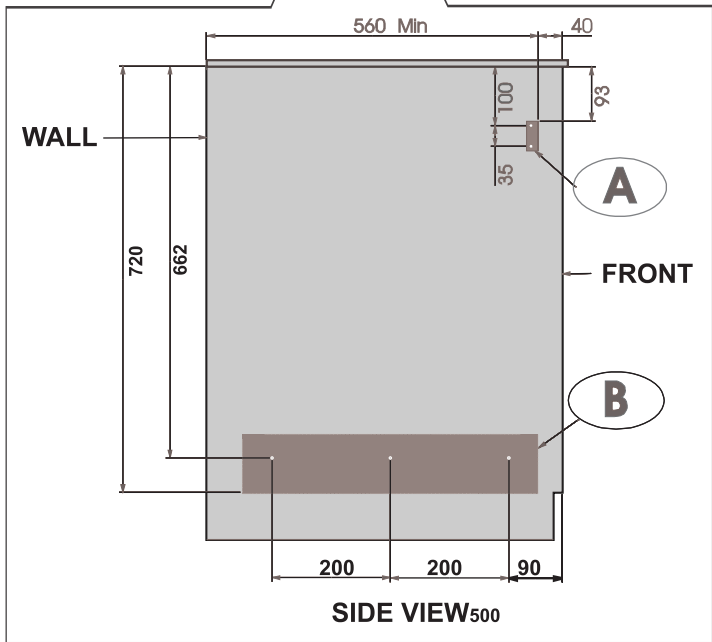
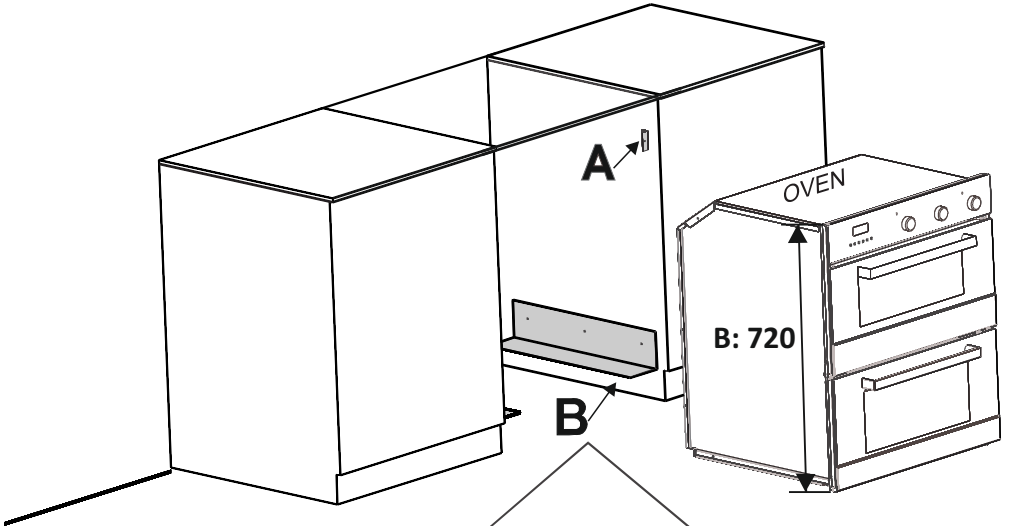

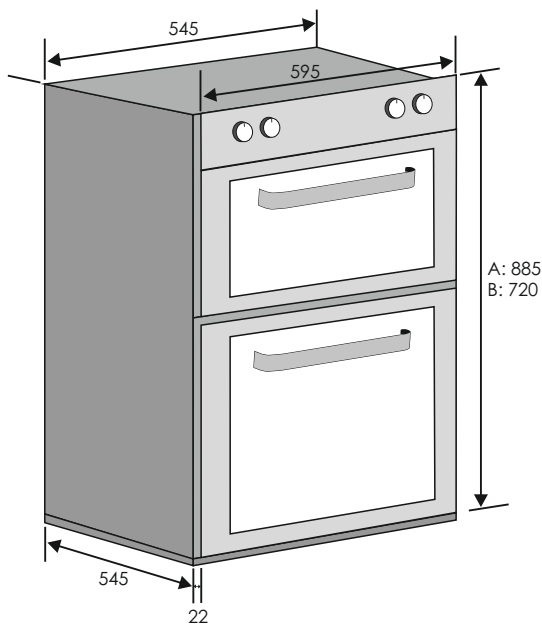
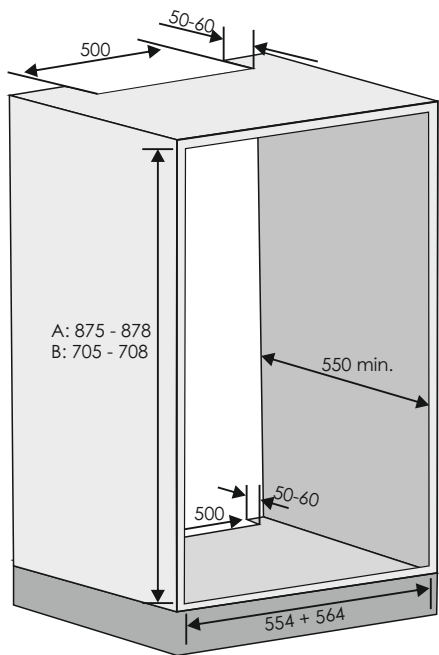

Free Manuals Download Website

<http://myh66.com>

<http://usermanuals.us>

<http://www.somanuals.com>

<http://www.4manuals.cc>

<http://www.manual-lib.com>

<http://www.404manual.com>

<http://www.luxmanual.com>

<http://aubethermostatmanual.com>

Golf course search by state

<http://golfingnear.com>

Email search by domain

<http://emailbydomain.com>

Auto manuals search

<http://auto.somanuals.com>

TV manuals search

<http://tv.somanuals.com>