



**DS-9500 Series NVR**  
**Quick Operation Guide**  
**Version 1.3.1**

## Verify Contents

Verify that the package contents are correct by checking the items against the packing list.

**Note:** Please contact your dealer for damaged or missing items.

## NVR Pre-Installation

The DS-9500 Series NVR is highly advanced surveillance equipment that should be installed with care. Please take into consideration the following precautionary steps before installation of the NVR.

1. Keep all liquids away from the NVR.
2. Install the NVR in a well-ventilated and dust-free area.
3. Ensure environmental conditions meet factory specifications.
4. Install a manufacturer recommended HDD.

## NVR Installation

During the installation of the NVR:

1. Use brackets for rack mounting.
2. Ensure there is ample room for audio and video cables.
3. When installing cables, ensure that the bend radius of the cables are no less than five times than its diameter.
4. Connect both the alarm and RS-485 cable.
5. Allow at least 2cm (~0.75in) of space between racks mounted devices.
6. Ensure the NVR is grounded.
7. Environmental temperature should be within the range of -10 °C ~ 55 °C, 14°F ~ 131°F.
8. Environmental humidity should be within the range of 10% ~ 90%.

## Hard Disk Installation

Before installing a hard disk drive (HDD), please make sure the power is disconnected from the NVR. A factory recommended HDD should be used for this installation.

**Tools Required:** Screwdriver.

1. Use the screws to install HDD to its mounting bracket.
2. Press the latches on both sides of the front panel of NVR chassis to open it.



3. Insert the HDD bracket to the chassis along the slot until it has fully seated into position.

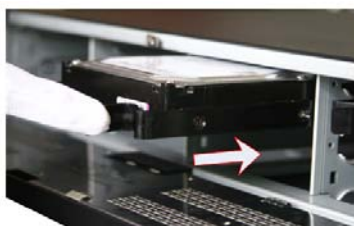

4. Close the front panel of the NVR chassis.

# Front Panel

## DS-9508NI-S/R Front Panel



No.	Name	Description	
1	Status LED Indicators	Power	Turning red indicates power supply but without system running, turning blue indicates power supply and system running.
		Alarm	Alarm indicator turns red when a sensor alarm is detected.
		TX/RX	TX/RX indicator blinks blue when network connection is functioning properly.
		HDD	HDD indicator blinks red when data is being read from or written to HDD.
		Ready	Ready indicator turns blue when NVR is functioning properly.
		Backup	Backup indicator blinks blue when data is being backup.
2	USB Ports	Universal Serial Bus (USB) ports for additional devices such as USB mouse and USB Hard Disk Drive (HDD).	
3	Power Button	Powers NVR on/off.	
4	Backup Button	Backup video files.	
5	Channel Status Indicators	Blue indicates recording, red indicates network connection, purple indicates recording & network connection.	

## DS-9516NI-S/R Front Panel:



No.	Name	Description	
1	Status LED Indicators	Power	Turning red indicates power supply but without system running, turning blue indicates power supply and system running.
		Alarm	Alarm indicator turns red when a sensor alarm is detected.
		TX/RX	TX/RX indicator blinks blue when network connection is functioning properly.
		HDD	HDD indicator blinks red when data is being read from or written to HDD.
		Ready	Ready indicator turns blue when NVR is functioning properly.
		Backup	Backup indicator blinks blue when data is being backup.
2	Backup Button	Backup video files.	
3	USB Ports	Universal Serial Bus (USB) ports for additional devices such as USB mouse and USB Hard Disk Drive (HDD).	
4	Power Button	Powers NVR on/off.	
5	Channel Status Indicators	Blue indicates recording, red indicates network connection, purple indicates recording & network connection.	

## Rear Panel

### DS-9508NI-S/R Rear Panel:

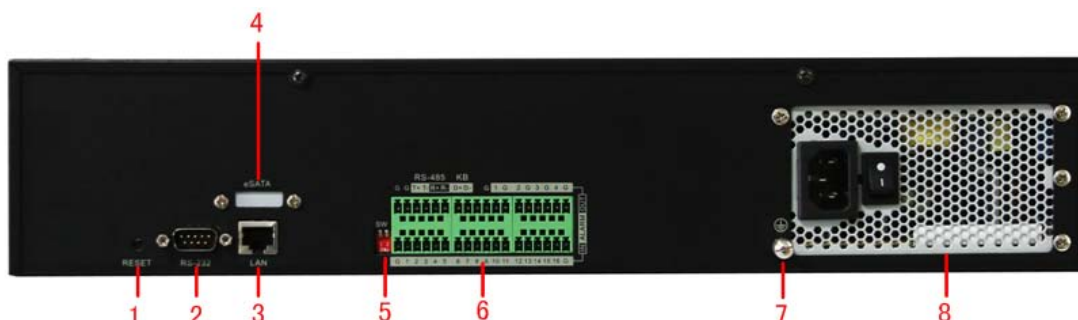

No.	Item	Description
1	RESET	Press and hold it for 10 seconds to reset all parameters to factory defaults.
2	RS-232	Connect to RS-232 devices.
3	LAN	10/100/1000Mbps Self-adaptive UTP Ethernet interface.
4	eSATA (optional)	Backup/extended storage interface, connect to external SATA disk, CD-RW, disk array, etc.
5	RS-485 Matching Resistor Switch (SW)	Connection of 120-ohm terminator for RS-485 bus. ON=connected; OFF=disconnected.
6	RS-485	Connect to RS-485 devices, e.g., P/T receiver, etc. Use the T+ and T- terminals of RS-485 interface to connect to the R+ and R- terminals of the receiver.
	ALARM IN	16 relay alarm inputs
	ALARM OUT	4 relay alarm outputs
7	GND	Grounding
8	POWER	220VAC power supply

## DS-9516NI-S/R Rear Panel:

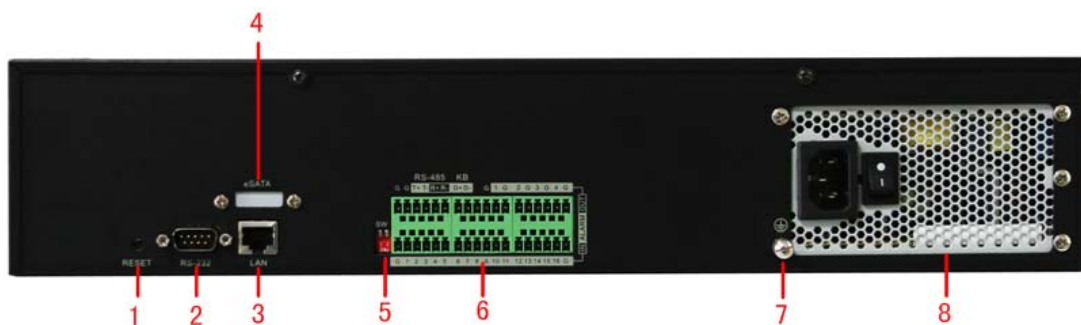

No.	Item	Description
1	RESET	Press and hold it for 10 seconds to reset all parameters to factory defaults
2	RS-232	Connect to RS-232 devices
3	LAN	10/100/1000Mbps Self-adaptive UTP Ethernet interface.
4	eSATA (optional)	Backup/extended storage interface, connect to external SATA disk, CD-RW, disk array, etc.
5	RS-485 Matching Resistor Switch (SW)	Connection of 120-ohm terminator for RS-485 bus. ON=connected; OFF=disconnected.
6	RS-485	Connect to RS-485 devices, e.g., P/T receiver, etc. Use the T+ and T- terminals of RS-485 interface to connect to the R+ and R- terminals of the receiver.
	ALARM IN	16 relay alarm inputs
	ALARM OUT	4 relay alarm outputs
7	GND	Grounding
8	POWER	220VAC power supply

**Note:** Currently the RS-485 interface of DS-9500 NVR is reserved for future use.

## Connections

### Connecting to Alarm Input/Output Device

The alarm input/output interface of the NVR is shown below:

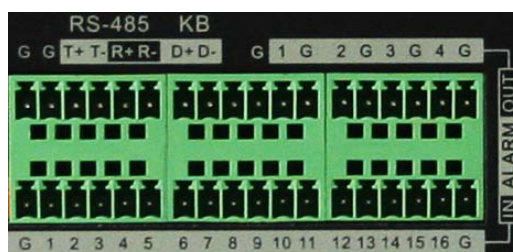

The alarm input is an open/close relay. If the input is not an open/closed relay, follow the connection diagram below:

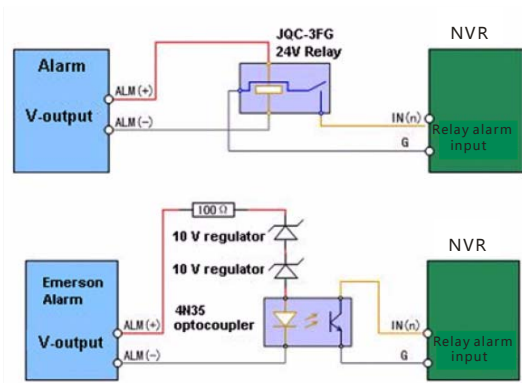

To connect to an AC/DC load, use the following diagram:

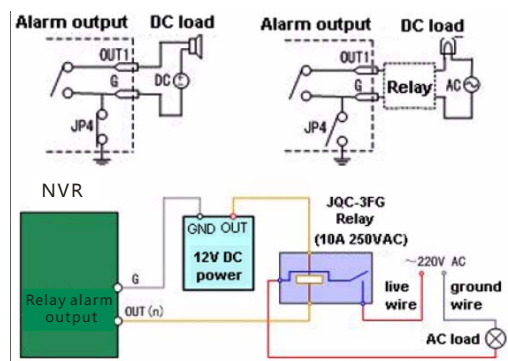

For DC load, JP4 can be used within the limit of 12V/1A safely. If the interface is connected to an AC load, JP4 should be left open. Use an external relay for safety (as shown in the figure above).

**Note:** An external relay is needed to prevent electric shock when connecting to an AC load.

**Alarm Connections:**

The device provides the green mating plugs for alarm input and alarm output connectors. Operate the following steps:

1. Remove the green mating plug from the ALARM IN or ALARM OUT connector.
2. Use the screwdriver to loosen the screw in the plug and then place the wire to the top of screw and finally tighten the screw to secure the wires.
3. Insert the plug to its mating slot.

# Specifications

## DS-9500NI-S:

Model		DS-9508NI-S	DS-9516NI-S
Video/Audio input	IP video input	8-ch 4CIF/4-ch 720P/2-ch UXGA Real Time, or 4-ch UXGA/2-ch 5 Megapixel not Real Time	16-ch 4CIF/8-ch 720P/4-ch UXGA Real Time, or 8-ch UXGA/4-ch 5 Megapixel not Real Time
Hard disk	Type	8 SATA interfaces	
	Capacity	Each interface supports up to 2TB capacity	
External interface	Network interface	1,RJ-45, 10/100/1000 Mbps adaptive Ethernet interface	
	Serial interface	1 RS-232 interface (for parameters configuration, maintenance , transparent channel); 1 RS-485 interface (for PTZ control); 1 RS-485 keyboard interface (for special keyboard control)	
	USB interface	2, USB 2.0	
	Alarm in	16	
	Alarm out	4	
Others	Power supply	100 ~ 240VAC, 6.3A, 50 ~ 60Hz	
	Consumption	≤ 20 W (without hard disk or DVD-R/W)	
	Working temperature	-10°C ~ +55°C	
	Working humidity	10% ~ 90%	
	Chassis	19'' standard 2U chassis	
	Dimensions (W × D × H)	450 × 450 × 95 mm	
Weight	≤ 8 kg ( without hard disk or DVD-R/W )		

## DS-9500NI-R:

Model		DS-9508NI-R	DS-9516NI-R
Video/Audio input	IP video input	8-ch 4CIF/4-ch 720P/2-ch UXGA Real Time, or 4-ch UXGA/2-ch 5 Megapixel not Real Time	16-ch 4CIF/8-ch 720P/4-ch UXGA Real Time, or 8-ch UXGA/4-ch 5 Megapixel not Real Time
Hard disk	Type	8 SATA interfaces	
	Capacity	Each interface supports up to 2TB capacity	
Disk array	Array type	RAID 0, RAID 1, RAID 5, RAID 10	
	Number of array	8	
	Number of virtual disk	8	
External interface	Network interface	1,RJ-45, 10/100/1000 Mbps adaptive Ethernet interface	
	Serial interface	1 RS-232 interface (for parameters configuration, maintenance , transparent channel); 1 RS-485 interface (for PTZ control); 1 RS-485 keyboard interface (for special keyboard control)	
	USB interface	2, USB 2.0	
	Alarm in	16	
	Alarm out	4	
Others	Power supply	100 ~ 240 VAC, 6.3 A, 50 ~ 60 Hz	
	Consumption	≤ 20 W (without hard disk or DVD-R/W)	
	Working temperature	-10℃ ~ +55℃	
	Working humidity	10% ~ 90%	
	Chassis	19'' standard 2U chassis	
	Dimensions (W × D × H)	450 × 450 × 95 mm	
Weight	≤ 8 kg ( without hard disk or DVD-R/W )		



## HDD Storage Calculation Chart

The following chart shows an estimation of storage space used based on recording at one channel for an hour at a fixed bit rate.

Bit Rate	Storage Used
96K	42M
128K	56M
160K	70M
192K	84M
224K	98M
256K	112M
320K	140M
384K	168M
448K	196M
512K	225M
640K	281M
768K	337M
896K	393M
1024K	450M
1280K	562M
1536K	675M
1792K	787M
2048K	900M

**Note:** Please note that supplied values for storage space used is just for reference. Storage space used is estimated by formulas and may have some deviation from actual value.

## Basic Operation

### Starting and Shutting Down Your NVR

#### Startup

Apply power to the unit and the POWER LED indicator on the front panel will light in green, which indicates the unit is powered on.

**Note:** DS-9500 series NVR do not provide local output, when the POWER and LINK LED indicators light normally, it indicates the unit has been successfully started and connected to network.

#### Shutdown

Unplug the power cord to shut down the unit. It is not recommended to directly shut down the unit when it is in recording.

**Note:** It is recommended that an Uninterruptible Power Supply (UPS) be used so as to ensure the unit to work with high stability and security.

### Access to DS-9500 by Client Software

Click “Start”→”All Programs”→”iVMS-4000(v2.0)” to start the client software. After successful login, user can enter the following main interface of the client software.

If the SADP software has been installed on PC, user can use it to automatically search and add the online devices within the same local area network. Click **Online Devices** button on the Add Device interface, and the system will automatically search the online devices.

The screenshot shows a dialog box titled "Add Device". It is divided into two columns of input fields. The left column includes: "Device Name" (empty), "Device IP" (empty), "Username" (admin), "Channel No." (4), "DNS Address" (empty), and "Serial Number" (empty with a plus sign). The right column includes: "Register Mode" (Normal IP dropdown), "Port" (8000), "Password" (\*\*\*\*\*), "Multicast" (empty), and "Belongs to area" (Monitor area). At the bottom, there are three buttons: "Online Device" (highlighted with a red box), "OK", and "Cancel".

The devices found will be listed on the panel with detail information.

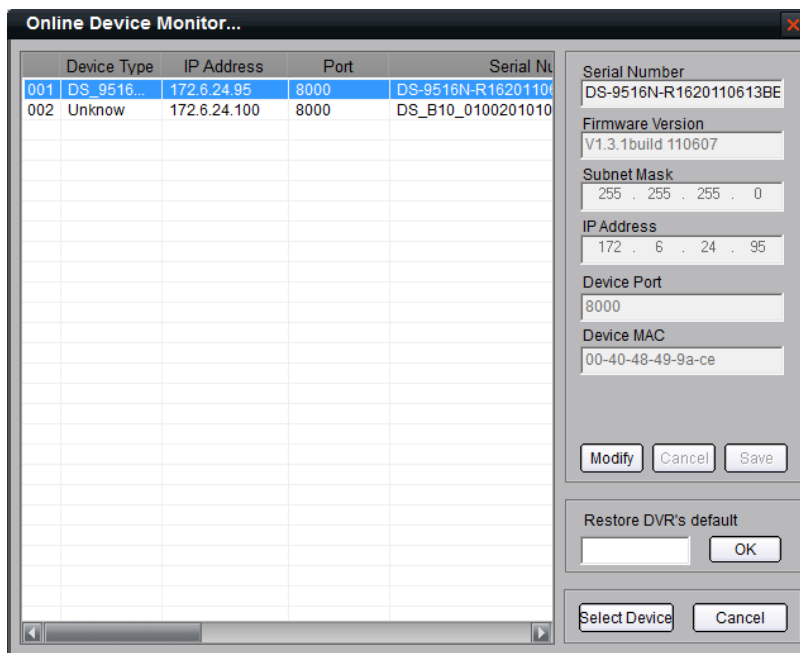

Select a device from the list and then click the **Select Device** button to add the device.

User can also click the **Modify** button to modify the subnet mask, IP address and device port of the device, and then input the user name and password for login, and finally click **Save** to complete the modification.

**Note:** If it is required to modify the default gateway, enter the Setup→Remote Settings→Network Parameters→Network Settings to change the settings.

**Note:** For detailed instructions, please refer to the *User Manual of iVMS 4000 V2.0*.

## Access to DS-9500 by IE Browser

### Login and Exit

Open IE browser, input the IP address of DS-9500 (e.g.,172.9.1.76) and then click *Enter*. The system will remind you to install the ActiveX control. Click and install the ActiveX control.

The system then will display the login interface as shown in the following figure:

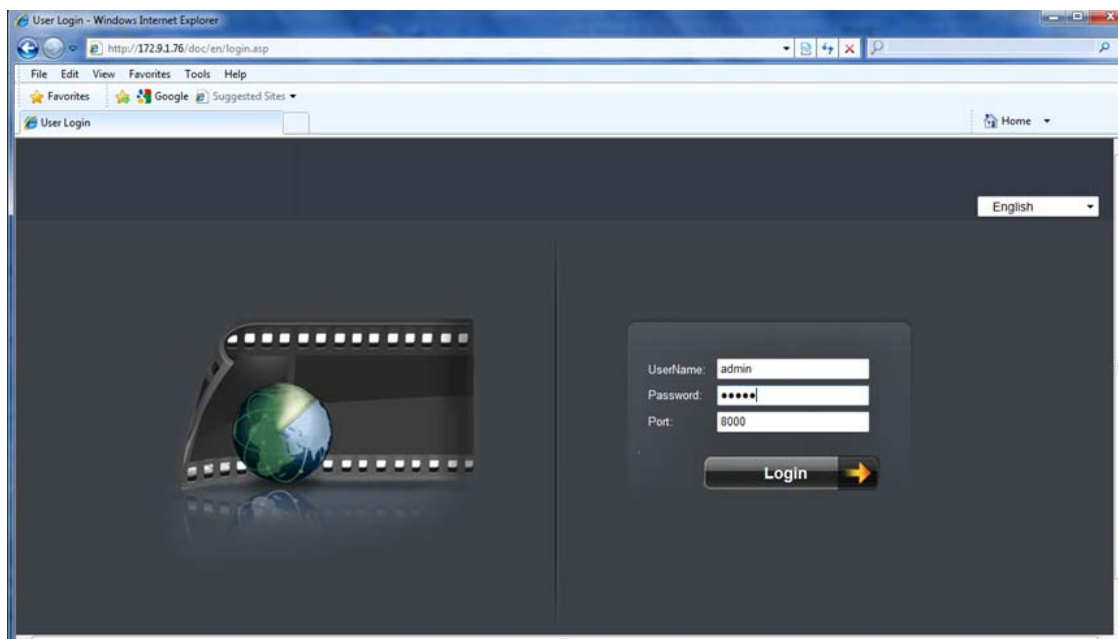

On the top right corner, language is selectable between Chinese and English.

Input the correct user name, password and port, click **Login** to enter preview interface, or it will pop up an error box. The default user name is *admin*, password is *12345*, and port is *8000*.

After login, the following interface will appear:

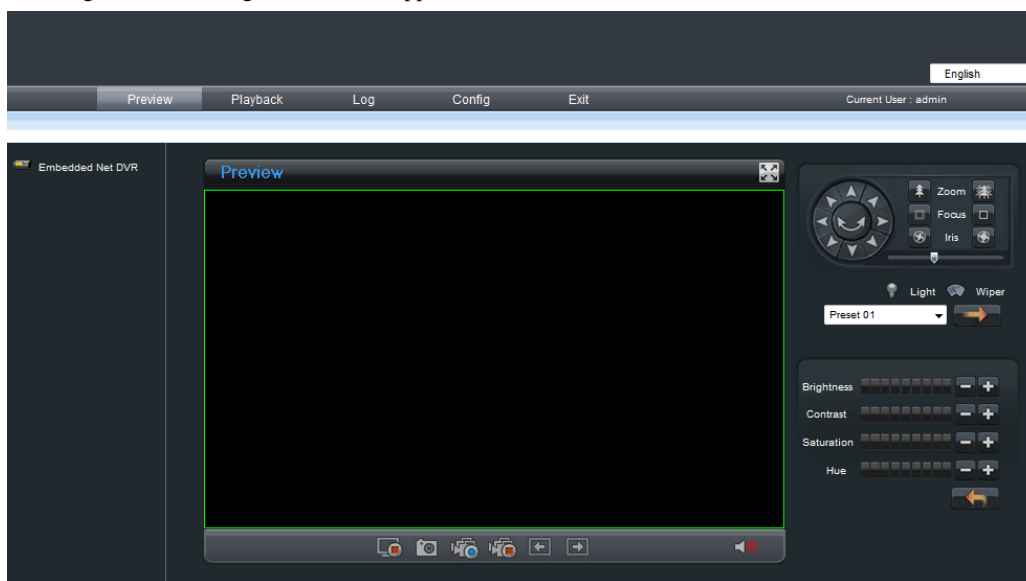

User can click **Exit** to log off and return to the login interface.

## Add Device

Click **Config**→**Remote Config** to enter IP camera configuration menu.

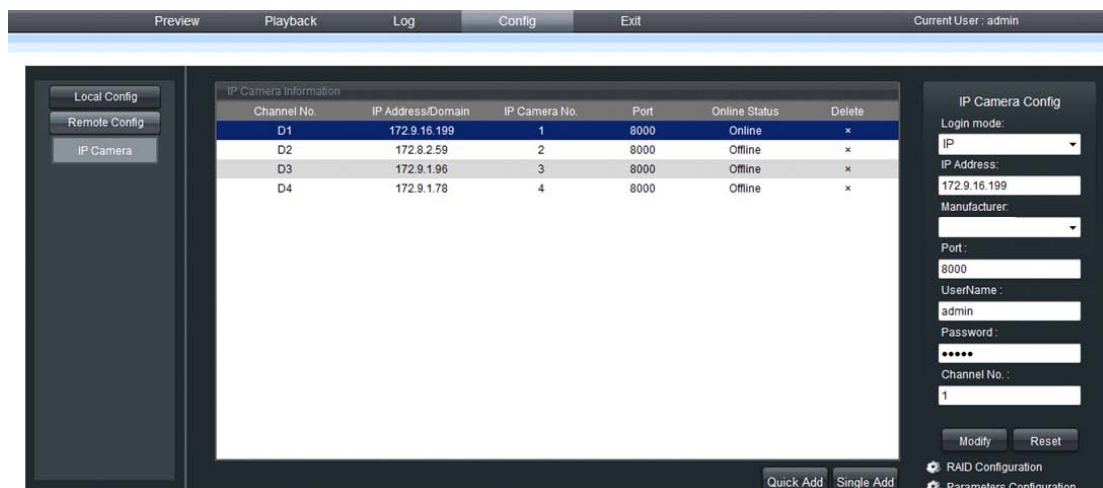

Refer to the following table for the number of IP cameras which can be added at different resolution:

Model Name	IP camera connections
DS-9508NI-S/R	Up to 8-ch 4CIF or 4-ch 720P or 2-ch UXGA IP cameras
DS-9516NI-S/R	Up to 16-ch 4CIF or 8-ch 720P or 4-ch UXGA IP cameras

### Quick Adding of IP Camera

This function enables you to add an IP camera quickly. When there are supported IP cameras in the same network segment of a LAN with NVR, you may add it with default user name, password and port number.

**Note:** Before applying **Quick Add** function, please make sure that IP camera is compatible with NVR and the default user name, password, port number are not changed.

Select a Channel No., and then click **Single Add** and the online IP cameras will be listed as figure shown below:

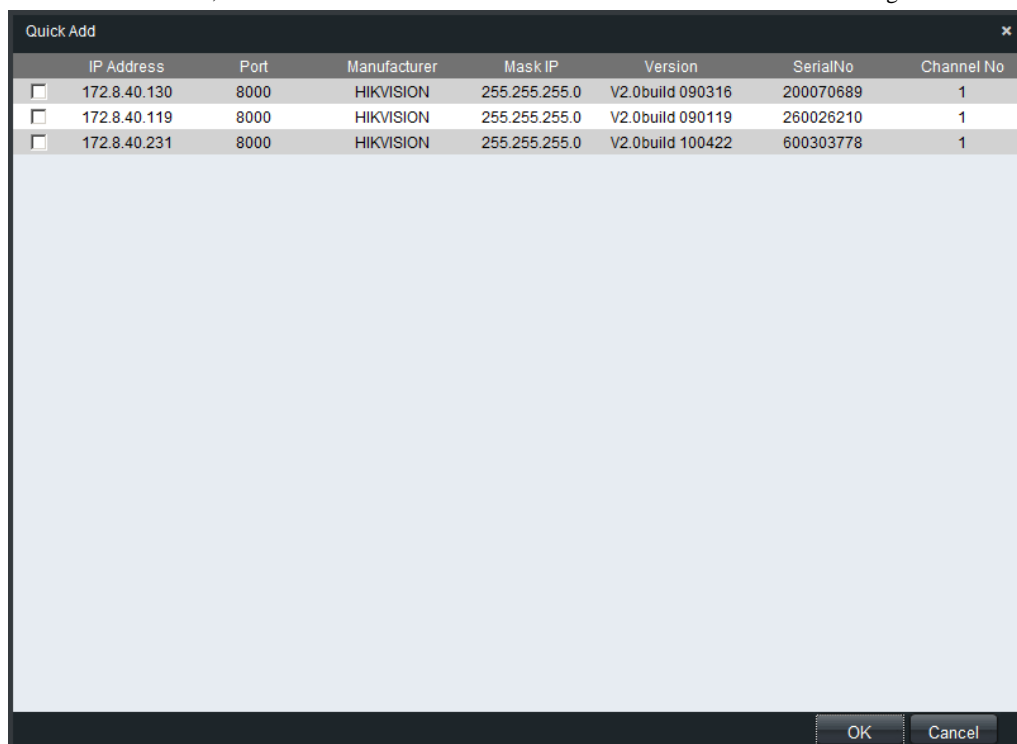

Select the IP camera from the list to be added and then click **OK** to finish the adding.

### Single Adding of IP Camera

This function enables you to add a single IP camera quickly. When there are supported IP cameras in the same network segment of a LAN with NVR, you may add it in one button with default user name, password and port number.

**Note:** Before applying **Single Add** function, please make sure that IP camera is compatible with NVR and the default user name, password, port number are not changed.

First, select a Channel No., and then click **Single Add** and the online IP cameras will be listed as figure shown below:

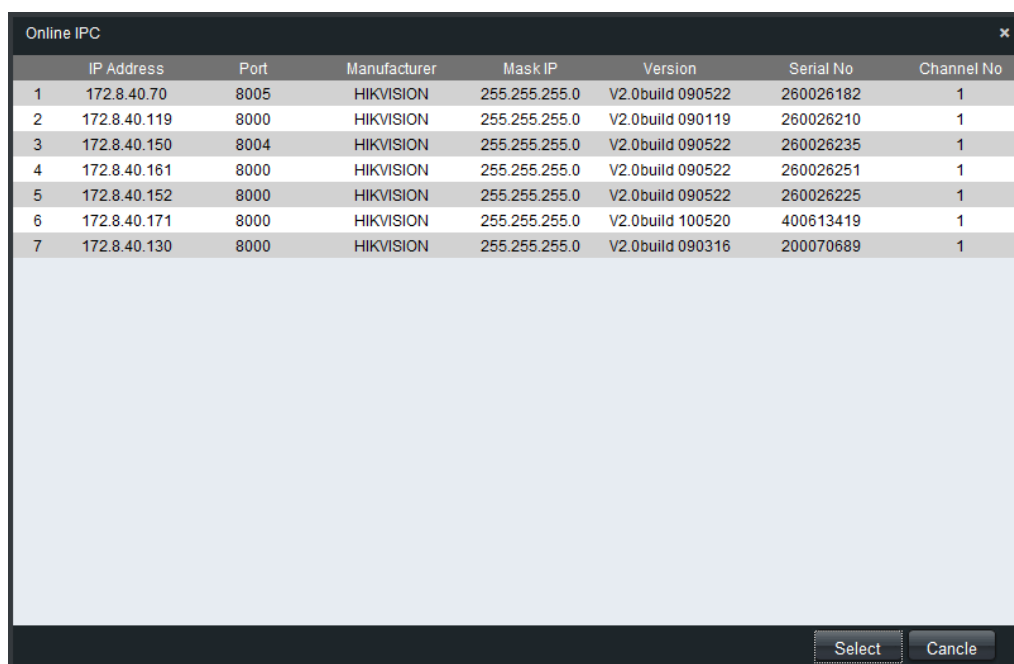

	IP Address	Port	Manufacturer	Mask IP	Version	Serial No	Channel No
1	172.8.40.70	8005	HIKVISION	255.255.255.0	V2.0build 090522	260026182	1
2	172.8.40.119	8000	HIKVISION	255.255.255.0	V2.0build 090119	260026210	1
3	172.8.40.150	8004	HIKVISION	255.255.255.0	V2.0build 090522	260026235	1
4	172.8.40.161	8000	HIKVISION	255.255.255.0	V2.0build 090522	260026251	1
5	172.8.40.152	8000	HIKVISION	255.255.255.0	V2.0build 090522	260026225	1
6	172.8.40.171	8000	HIKVISION	255.255.255.0	V2.0build 100520	400613419	1
7	172.8.40.130	8000	HIKVISION	255.255.255.0	V2.0build 090316	200070689	1

Select one IP camera from the list and click **Select** to finish the adding.

Then you can change IP address, sub mask or user name, password in the menu on the right, and click **Modify** to confirm.

### Manual Adding of IP Camera

First select a Channel No. to enable IP camera Config menu shown on the right.

Input the IP address, port, user name and password, click **Modify** to finish adding an IP camera that will be listed in the IP Camera Information area.

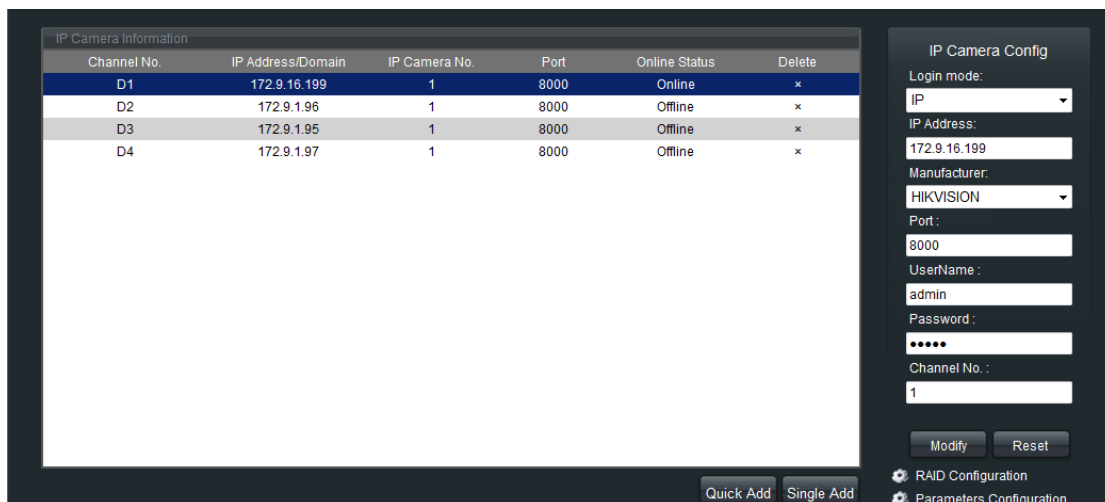

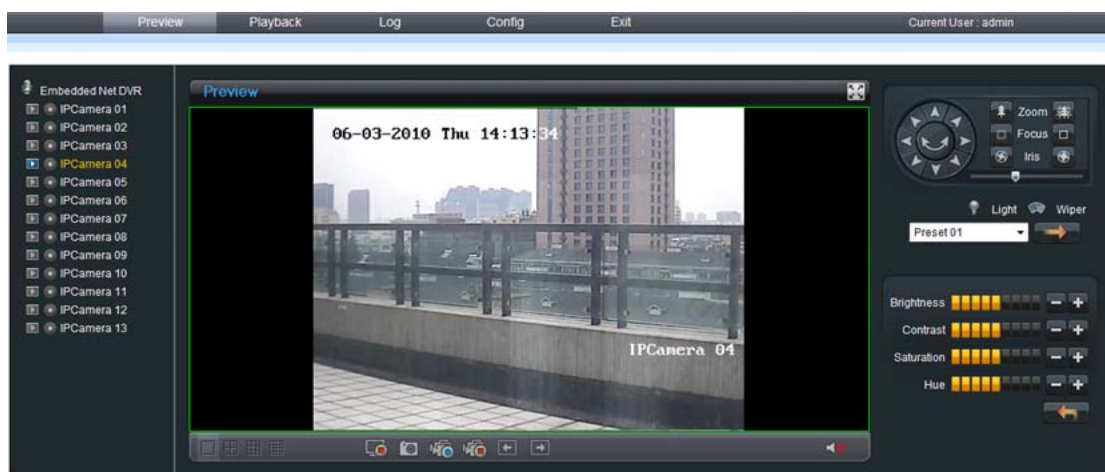

## Preview

After login, the preview interface will display:





When live preview, the windows division can be selected by click the button on play control area. It can support 1 and 4 windows division. The change between different windows division modes will not stop the current preview; and the window still can be operated.

### Preview by channel:

After having selected window division mode, click one window, and click  on channel list to preview the current channel. If preview successful, the icon will become .



**Preview by device:**

Click the device node on the list, then multiple channels will start to be displayed synchronously on the selected window divisions. When the 1-window division mode is selected, click  to switch to the next window, or click  to the previous window for preview.

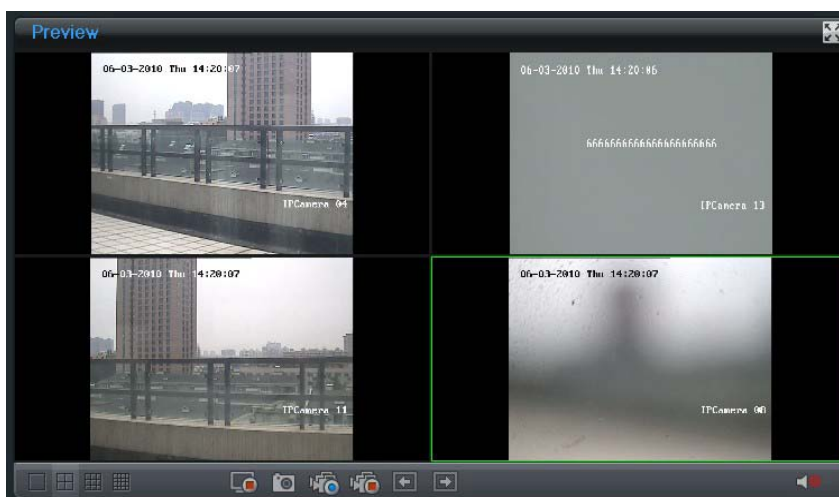

**Recording**

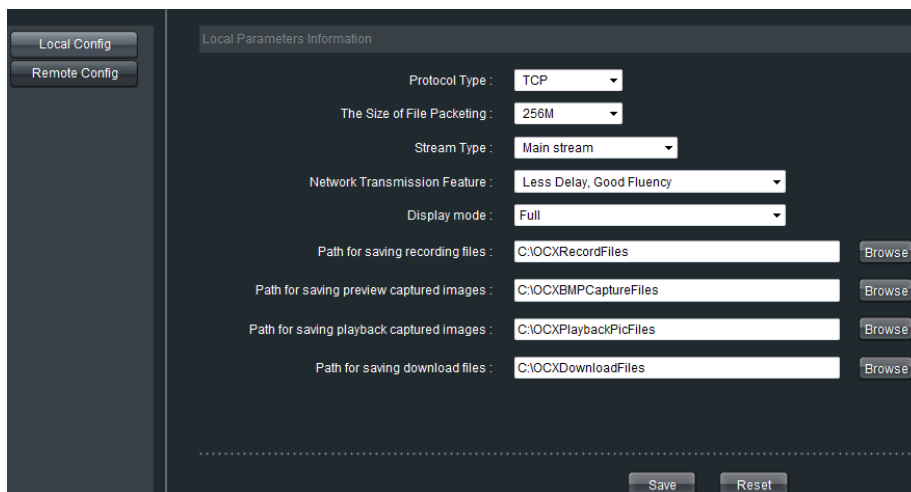

**Start/Stop Recording**

Click **Config**→**Local Config** to enter local configuration menu where user can change the directory of saving recording file and the size of file packing.







**Note:** If the free space in the defined disk is less than 500M, the web server will stop recording automatically.

Click  button on playlist to start recording of this channel, and if the icon is not , it will prompt “Recording failed”.

Click  icon again to stop recording, and the saving file folder will pop up automatically.

When multiple channels are under previewing, user may click  to start all channel recording, or click  to stop all channel recording.



**Note:** Stop previewing will also stop recording of the current channel.

### Schedule Recording Settings

Click **Config**→**Remote Config**→**Parameters Configuration** to enter the remote settings interface of the NVR.

**Step1:** Click **Schedule Record** to enter the schedule record settings interface. Enable Schedule Recording.

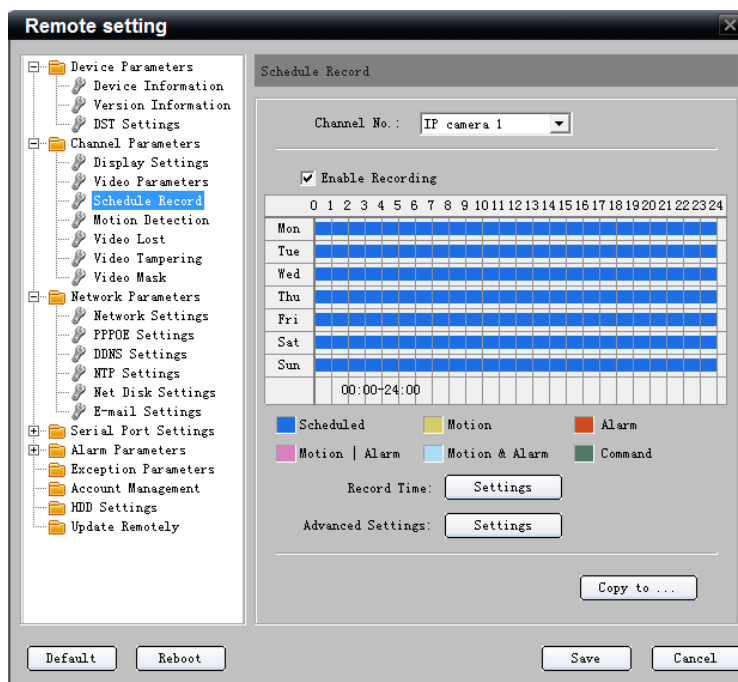

**Step 2:** Set recording time and type.

Click **Settings** button of **Record Time** to enter record time settings interface.





Select one day in a week, and select **All Day Recording** if necessary. You may also set period recording by disabling **All Day Recording**; there are 8 time periods in one day. Then you can select schedule recording from the drop-down menu beside the periods. Then you may also select copy the settings to whole week or to one day.

**Note:** Please make sure each time period is not overlapped with each other.

## Playback

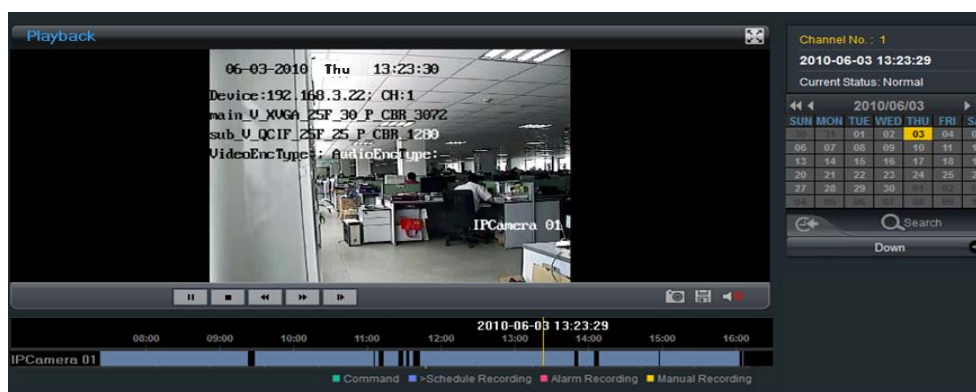
Click **Playback** button to enter the playback interface. Select the channel for playback and search the record files by date from the right column. If corresponding record file is found, the time bar will be displayed at the window bottom. Click **Play** to start playing the selected record file. The selected record files can be downloaded by clicking the **Down** button. Refer to the following figure:



During the playback of record files, user may click the  button to enter the full screen mode. The  button can be used for capturing pictures and the  button is video clipping. User can also click the  button to open/close audio during playback.

## Free Manuals Download Website

<http://myh66.com>

<http://usermanuals.us>

<http://www.somanuals.com>

<http://www.4manuals.cc>

<http://www.manual-lib.com>

<http://www.404manual.com>

<http://www.luxmanual.com>

<http://aubethermostatmanual.com>

Golf course search by state

<http://golfingnear.com>

Email search by domain

<http://emailbydomain.com>

Auto manuals search

<http://auto.somanuals.com>

TV manuals search

<http://tv.somanuals.com>