

28LD5000TA 28" LCD TV

USER'S MANUAL

Thank you very much for purchasing the HITACHI LCD Monitor. Before using your monitor, please carefully read the "SAFETY INSTRUCTIONS" and this "USER'S MANUAL" so you will know how to operate the monitor properly. Keep this manual in a safe place. You will find it useful in the future.

Notes on Installation Work:

This product is marketed assuming that it is installed by qualified personnel with enough skill and competence. Always have an installation specialist or your dealer install and set up the product. HITACHI cannot assume liabilities for damage caused by mistake in installation or mounting, misuse, modification or a natural disaster.

Note for Dealers:

After installation, be sure to deliver this manual to the customer and explain to the customer how to handle the product.

Important

Please read this User's Manual thoroughly, especially the Safety Instructions on Page 4 to 7. Mis-use may cause damage to your LCD monitor, which could shorten its lifespan, or cause injury to yourself. Should you encounter any difficulty in the set-up or operation of your monitor, firstly refer to the Troubleshooting guide at the rear of this manual.

In the unlikely event of a problem occurring with your LCD monitor, switch off at the mains sockets, pull out the plugs, and contact your dealer immediately.

CAUTION

Under no circumstances remove the rear cover of your LCD monitor. Never guess or take any chances with electrical equipment of any kind - it is better to be safe than sorry!

Software Notice

It is prohibited for the end user of this product to copy, reverse engineer or reverse compile the software included therein, save to the extent permitted by law.

LCD Monitor

After the LCD monitor has been on for any length of time, you will notice that the screen becomes warm. Please note that this is normal. Sometimes the screen might have some tiny bright or dark spots. Please note that this is normal.

CAUTION

To prevent scratches or damages to the LCD screen, do not knock or rub the surface with sharp or hard objects. Clean the screen with a soft cloth moistened with warm water and dry with a soft cloth. A mild soap may be used if the screen is extremely dirty. Do not use harsh or abrasive cleaners!

CAUTION

Use a soft cloth to clean the cabinet and control panel of the monitor. When excessively soiled dilute a neutral detergent in water, wet and wring out the soft cloth and afterward wipe with a dry soft cloth. Never use acid/alkaline detergent, alcoholic detergent, abrasive cleaner, powder soap, OA cleaner, car wax, glass cleaner, etc. especially because they would cause discoloration, scratches or cracks.

FEATURES

High-definition LCD display panel

The 28-inch TFT LCD panel with a resolution of 1280(H) X 768(V) pixels, creates a high-definition, proper screen (aspect ratio:15:9) and low-profile flat display. Free from electromagnetic interferences from geomagnetic sources and ambient power lines, the panel produces high-quality display images free from colour misconvergence and display distortion.

High Performance Digital Processor

A wide range of personal computer signals can be handled, from 640 x 400, 640 x 480 VGA to 1600 x 1200 UXGA.

Easy-to-use remote control and on screen display system

The remote control included eases the work of setting display controls. Further, the on-screen display system, displays the status of signal reception and display control settings in an easy-to-view fashion.

Power saving system

The International ENERGY STAR® power saver feature saves power consumption automatically when input signals are not available. When connected to a VESA DPMS-compliant PC, the monitor cuts its power consumption while it is idle.

TruBass

TruBass, SRS and (O) symbol are trademarks of SRS Labs, Inc. TruBass tech  incorporated under license from SRS Labs, Inc.

About the Video Unit

The following functions can be obtained by the video unit.

- (1) A composite/S terminal and two component terminals have been added. A composite video output terminal is also provided as a monitoring output.
- (2) A wide range of devices other than personal computers can also be connected.
- (3) A component input is possible to switch to RGB signals from the Menu screen.
- (4) A SCART terminal is also provided for the signal of the European standard. It operates as composite/S/RGB input terminal, or video output terminal.

CONTENTS

FEATURES	2	Automatic Store	22
SAFETY INSTRUCTIONS	4	Signal Check	23
COMPONENT NAMES	8	Power Save Mode.....	23
Main Unit.....	8	NOTES	24
Remote control	9	TROUBLESHOOTING	25
Loading Batteries	9	Symptoms That Seemingly Appear to be Failures	25
Handling the Remote Control	9	Actions to Correct Abnormal Displays	27
INSTALLATION INSTRUCTIONS	11	Video Unit Function	28
Installation.....	11	Tuner Unit Function	38
Anti-tumble measures.....	11	PRODUCT SPECIFICATIONS	49
Connecting to a PC	12	Signal Input.....	50
Speaker Cable connection	13	Recommended Signal List	51
Power Cord Connection	13		
OPERATING INSTRUCTIONS	14		
Turning Power On and Off	14		
Input Switching	15		
Volume Adjustment.....	15		
Audio Mute	15		
Size Switching	16		
Input Signal Screen Display	16		
Using the Menu Screen	17		
PICTURE MENU	18		
AUDIO MENU	19		
TIMER MENU	19		
FUNCTION MENU	20		
SETUP MENU	21		
LANGUAGE MENU.....	22		
OTHER FEATURES	22		

ENGLISH

Notes about This Manual

- The information in this manual is subject to change without notice.
- While meticulous care has been taken in the preparation of this manual, you are requested to notify your dealer or us should you have any comments, views or questions about our product.
- Fully understand the prerequisites to using the product, such as hardware and software specifications and constraints, in using the product. We are not held liable for damages caused by improper handling of the product.
- Reproduction of this manual in whole or in part without our prior written permission is prohibited.
- The product names mentioned in this manual may be trademarks or registered trademarks of their respective owners.

SAFETY INSTRUCTIONS

This LCD monitor has been designed and manufactured to meet international safety standards, but like any electrical equipment, care must be taken if you are to obtain the best results and safety is to be assured. Before using this product, please read and understand the Safety Instructions thoroughly to ensure correct usage, and follow all the instructions.

About the Symbols

Various symbols are used in this manual, the user's manual and on the product itself to ensure correct usage, to prevent danger to the user and others, and to prevent property damage. The meanings of these symbols are described below. It is important that you read these descriptions thoroughly and fully understand the contents.



WARNING

This symbol indicates information that, if ignored, could possibly result in personal injury or even death due to incorrect handling.



CAUTION

This symbol indicates information that, if ignored, could result possibly in personal injury or physical damage due to incorrect handling.

Typical Symbols



This symbol indicates an additional warning (including cautions). An illustration is provided to clarify the contents.



This symbol indicates a prohibited action. The contents will be clearly indicated in an illustration or nearby (the symbol to the left indicates that disassembly is prohibited).



This symbol indicates a compulsory action. The contents will be clearly indicated in an illustration or nearby (the symbol to the left indicates that the power plug should be disconnected from the power outlet).



WARNING

Never use the monitor if a problem should occur.

Abnormal operations such as smoke, strange odor, no image, no sound, excessive sound, damaged casing, elements, cables, penetration of liquids or foreign matter, etc. can cause a fire or electrical shock.

In such case, immediately turn off the power switch and then disconnect the power plug from the power outlet. After making sure that the smoke or odor has stopped, contact your dealer. Never attempt to make repairs yourself because this could be dangerous.



Disconnect the plug from the power outlet.

Do not insert liquids or foreign objects.

Penetration of liquids or foreign objects could result in fire or electrical shock. Use special caution in households where children are present.

If liquids or foreign objects should enter the projector, immediately turn off the power switch, disconnect the power plug from the power outlet and contact your dealer.

- Do not place the monitor in a bathroom.
- Do not expose the monitor to rain or moisture.
- Do not place flower vases, pots, cups, cosmetics, liquids such as water, etc on or around the monitor.
- Do not place metals, combustibles, etc on or around the monitor.



Do not disassemble.

Never disassemble or modify the monitor.

The monitor contains high voltage components. Modification could result in fire or electrical shock.

- Never remove any fixed cover.

Do not give the monitor any shock or impact.

If the monitor should be shocked and/or broken, it could result in an injury, and continued use could result in fire or electrical shock.

If the glass panel is broken or damaged, immediately turn off the power switch, disconnect the power plug from the power outlet and contact your dealer.



Do not place the monitor on an unstable surface.

If the monitor should be dropped and/or broken, it could result in an injury, and continued use could result in fire or electrical shock.

- Do not place the monitor on an unstable, slant or vibrant surface such as a wobbly or inclined stand.

Do not obstruct the ventilation of the monitor.

If the ventilation is obstructed during the operation of the monitor or just after switching off the power, it could result in damage and shorten the lifespan of your monitor due to overheating. Make sure there is ample ventilation.

- Keep a space of 100mm (10cm) or more between the sides, rear and top of the monitor and other objects such as walls.
- Do not place anything around ventilation openings of the monitor.
- Never block ventilation openings.
- Do not put the LCD screen side up.
- Do not cover the monitor with a tablecloth, etc.
- Do not place the monitor on a carpet or bedding, or near a curtain.



Use only the correct power outlet.

Incorrect power supply could result in fire or electrical shock. Use only the correct power outlet depending on the indication on the monitor and the safety standard.

- The enclosed power cord must be used depending on the power outlet to be used.



⚠ WARNING**Be cautious of the power cord connection.**

Incorrect connection of the power cord could result in fire or electrical shock.

- Do not touch the power cord with a wet hand.
- Check that the connecting portion of the power cord is clean (with no dust), before using. Use a soft and dry cloth to clean the power plug.
- Insert the power plug into a power outlet firmly. Avoid using a loose, unsound outlet or contact failure.
- Do not cut off the fitted power plug, the removal of which could lead to impaired performance. If you wish to extend the lead, obtain an appropriate extension lead or consult your dealer.
- Should you require replacing the fuse in the molded plug with a new fuse, then please replace with new one of the same value, type and approval as the original. Ensure the fuse cover is returned to its original position.

**Be sure to keep safety ground connection.**

Connect the ground terminal of AC Inlet of this monitor with the ground terminal provided at the power outlet using the enclosed power cord. If the provided plug does not fit your outlet, consult an electrician for replacement of the obsolete outlet.



Surely connect
the ground wire.

Be careful in handling the power cord and external connection cables.

If you keep using a damaged the power cord or cables, it can cause a fire or electrical shock. Do not apply too much heat, pressure or tension to the power cord and cables.

- If the power cord or cables are damaged (exposed or broken core wires, etc.), contact your dealer.
- Do not place the monitor or heavy objects on the power cord and cables. Also, do not place a spread, cover, etc. over them because this could result in the inadvertent placing of heavy objects on the concealed power cord or cables.
- Do not pull the power cord and cables. When connecting and disconnecting the power cord or cables, do it with your hand holding the plug or connector.
- Do not place the cord near the heater.
- Do not touch the power plug just after disconnecting it from the power outlet to prevent electric shock.
- Do not touch the power plug when lightening is close to you.
- Avoid coiling the power cord and bending it sharply.
- Protect the power cord from being walked on, pinched particularly at plugs, conveniences receptacles, and the point where they exit from the apparatus.
- Do not modify the power cord.

**Be careful in handling the battery of the remote control.**

Incorrect handling of the battery could result in fire or personal injury. The battery may explode if not handled properly.

- Keep the battery away from children and pets. If swallowed consult a physician immediately for emergency treatment.
- Do not allow the battery to be exposed to fire or water.
- Avoid fire or high-temperature environment.
- Do not hold the battery with metallic tweezers.
- Keep the battery in a dark, cool and dry place.
- Do not short circuit the battery.
- Do not recharge, disassemble or solder the battery.
- Do not physically impact the battery.
- Use only the battery specified in the manual of this monitor.
- Make sure the plus and minus terminals are correctly aligned when loading the battery.
- If you observe a leakage of the battery, wipe out the liquid and then replace the battery. If the liquid adheres your body or clothes, rinse well with water.
- Obey the local laws on disposing the battery.

**• FOR THE CUSTOMERS IN THE U.K.**

THIS PRODUCT IS SUPPLIED WITH A TWO PIN MAINS PLUG FOR USE IN MAINLAND EUROPE. FOR THE U.K. PLEASE REFER TO THE NOTES ON THIS PAGE.

IMPORTANT FOR UNITED KINGDOM**WORDING FOR CLASS I EQUIPMENT INSTRUCTION BOOKS AND LABELS**

The mains lead on this equipment is supplied with a molded plug incorporating a fuse, the value of which is indicated on the pin face of the plug. Should the fuse need to be replaced, an ASTA or BSI approved BS 1362 fuse must be used of the same rating. If the fuse cover is detachable never use the plug with the cover omitted. If a replacement fuse cover is required, ensure it is of the same colour as that visible on the pin face of the plug. Fuse covers are available from your dealer.

DO NOT cut off the mains plug from this equipment. If the plug fitted is not suitable for the power points in your home or the cable is too short to reach a power point, then obtain an appropriate safety approved extension lead or consult your dealer.

Should it be necessary to change the mains plugs, this must be carried out by a competent person, preferably a qualified electrician.

If there is no alternative to cutting off the mains plug, ensure that you dispose of it immediately, having first removed the fuse, to avoid a possible shock hazard by inadvertent connection to the mains supply.

WARNING: THIS EQUIPMENT MUST BE EARTHED**IMPORTANT**

The wires in the mains lead are coloured in accordance with the following code :

Green and Yellow = Earth, Blue = Neutral, Brown = Live.

As these colours may not correspond with the coloured markings identifying the terminals in your plug, proceed as follows:

The wire which is coloured GREEN and YELLOW must be connected to the terminal in the plug which is marked with the letter E or by the earth symbol Ⓧ or coloured GREEN or GREEN and YELLOW.

The wire coloured BLUE must be connected to the terminal marked with the letter N or coloured BLUE or BLACK. The wire coloured BROWN must be connected to the terminal marked with the letter L or coloured BROWN or RED.

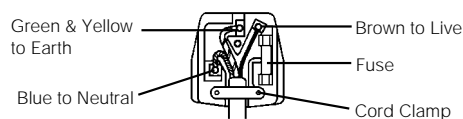

SAFETY INSTRUCTIONS(continued)

CAUTION

Be careful in moving the monitor.

Neglect could result in an injury or damage.

- Do not move the monitor during use. Before moving, disconnect the power plug and all external connections.
- You are advised to move the monitor with two persons.
- Avoid any impact or shock to the monitor; particularly take care of glass screen.



Do not put anything on top of the monitor.

Placing anything on the monitor could result in loss of balance or falling, and cause an injury or damage. Use special caution in households where children are present.



Avoid a humid or dusty place.

Placing the monitor in a smoke, a highly humid, dusty place, oily soot or corrosive gas could result in fire or electrical shock.

- Do not place near the kitchen, a humidifier or other place where there is oil, smoke or humidity.



Avoid a high temperature environment.

The heat could have adverse influence on the monitor and other parts, and could result in transformation, melting or fire.

- Do not place the monitor, the remote control and other parts in direct sunlight or near a hot object such as heater, etc.
- Do not put the monitor in a place where the temperature is widely changing.



Remove the power cord for complete separation.

- For safety purposes, disconnect the power cord if the monitor is not to be used for prolonged periods of time.
- Before cleaning, turn off and unplug the monitor. Neglect could result in fire or electrical shock.



Disconnect the plug from the power outlet.

PRECAUTIONS

• Installation environment

Do not obstruct a ventilation hole.

Do not put the monitor on carpet or blanket, or near a curtain which has a possibility of obstructing a ventilation hole of the monitor.

Do not put the monitor in the following places.

- Hot places such as near heater, place exposed to the direct rays of the sun.
- A place where the temperature is widely changing.
- Places with soot, dust or high humidity.
- Poor air ventilation place.
- Place near fire.
- A wet place such as bathroom, or shower room.
- Place where you can trip over it.
- Always vibrating or strongly vibrating places.
- Distorted or unstable places.

• How to view the monitor

If you use the monitor in too dark a room, your eyes may become tired.

Please use it in a reasonably bright room.

Avoid direct rays of the sun to the screen in order to prevent eye fatigue.

Your eyes will get fatigued after viewing the monitor for long period of time.

Relax your eyes by viewing away from the monitor from time to time.

Please watch the monitor in downward direction.

• How to clean the LCD panel of the monitor

Before cleaning the monitor, turn off the monitor and disconnect the power plug from the power outlet.

To prevent scratching or damaging the LCD screen face, do not knock or rub the surface with sharp or hard objects. Clean the screen with a soft cloth moistened with warm water and dry with a soft cloth. If it is not enough, then use a cloth with mild detergent. Do not use harsh or abrasive cleaners.

• How to clean the cabinet of the monitor

Use a soft cloth to clean the cabinet and control panel of the monitor. When excessively soiled dilute a neutral detergent in water, wet and wring out the soft cloth and afterward wipe with a dry soft cloth.

Never use acid/alkaline detergent, alcoholic detergent, abrasive cleaner, powder soap, OA cleaner, car wax, glass cleaner, etc. especially because they would cause discoloration, scratches or cracks.

- **Prevention of an obstacle to Radio receivers**

This monitor has been designed pursuant to the international EMI standards. This is to prevent a problem to Radio receivers.

- Keep the monitor away from Radio.
- Adjust Radio antennas in order for the monitor not to receive interference.
- The antenna cable of Radio should be kept away from the monitor.
- Use a coaxial cable for antenna.

You can check if this monitor influences Radio receivers by turning off all other equipment other than the monitor.

If you find a problem receiving Radio when using the monitor, check the instructions mentioned above.

- **Precautions for the cable connection**

- Do ensure that all connections, (including the power plug, extension leads and interconnections between the pieces of equipment), are properly made and in accordance with the manufacturers instructions. Switch off and withdraw the power plug before making or changing connections.
- Confirm the connector is fixed tightly when the signal cable is connected.
Also confirm the screws on the connector are tightened.
- Plug the power cord of the monitor into a different socket from that for other equipment, such as Radio etc..
- Use a plug with ground terminal and make sure that it connects to the ground.

- **Precaution during transportation**

Please pay attention when you transport this monitor because it is heavy.

Furthermore, use the original carton box and its packaging materials when the monitor is transported.

Failure to transport the monitor in any carton except the original carton may result in damage to the monitor.

Save the original carton box and all packing material.

Do not physically impact the remote control.

A physical impact could cause damage or malfunction of the remote control.

- Take care not to drop the remote control.
- Do not place heavy objects on the remote control.

Avoid strong rays.

Any strong rays (such as direct sun rays or room lighting) onto the remote control sensors could invalidate the remote control.

Avoid radio interference.

Any interfering radiation could cause distorted images or noises.

- Avoid radio generator such as a mobile telephone, transceiver, etc. around the monitor.

Set the sound volume at a suitable level.

It is better to keep the volume level low and close the windows at night to protect the neighborhood environment.

- **Precautions for the installation**

- Do not use makeshift stands and NEVER fix legs with wood screws - to ensure complete safety, always fit the manufacturers approved stand or legs with the fixings provided according to the instructions.
- Use only with the cart, stand, tripod, bracket, or table specified by the manufacturer, or sold with the apparatus. When a cart is used, use caution when moving the cart/apparatus combination to avoid injury from tip-over.
- This product is designed to comply with the recommended safety standards for tilt and stability. Do not apply excessive pulling force to the front, or top, of the cabinet that could cause the product to overturn resulting in product damage and/or personal injury.
- Follow instructions for wall, shelf or ceiling mounting as recommended by the manufacturer.
- Only use the attachments/accessories specified by the manufacturer.
- Consult your dealer if you are in any doubt about installation, operation or safety of your equipment.

- **Other precautions**

- Do not leave equipment switched on when it is unattended unless it is specifically stated that it is designed for unattended operation or has a stand-by mode. Switch off using the switch on the equipment and show your family how to do this. Make special arrangements for infirm or handicapped people.
- Disposal of this product may require specific instructions pertaining to your resident region.
- Never guess or take any chances with electrical equipment of any kind - it is better to be safe than sorry!

COMPONENT NAMES

Main Unit

Front

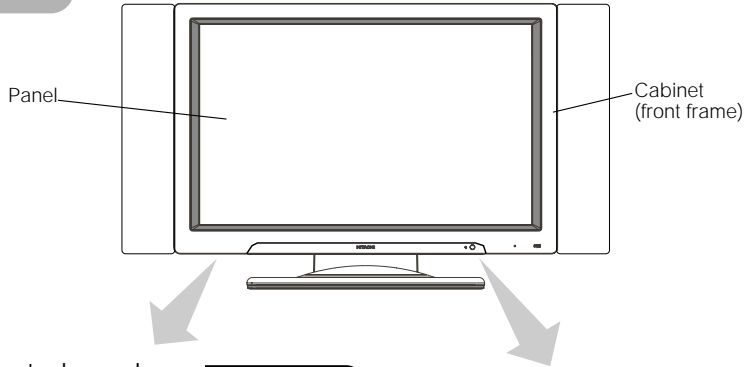

Control panel

- These buttons are located on the top.

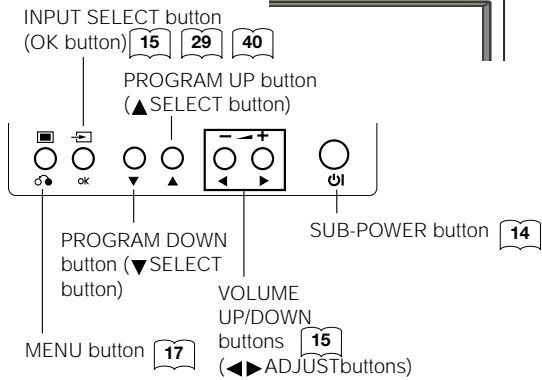

- () indicates the function while the MENU is displayed on the screen.

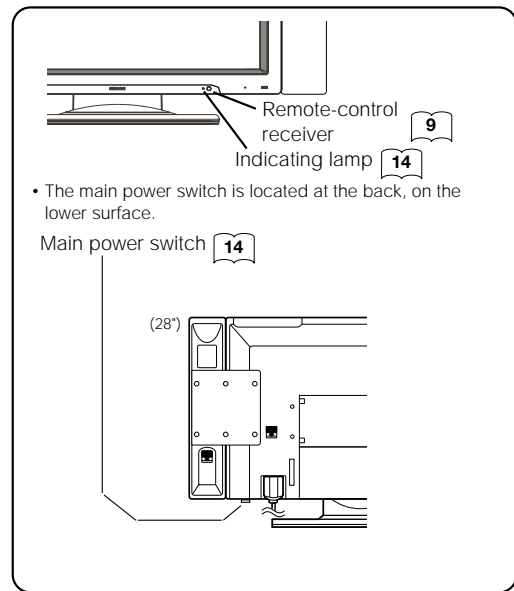

- The main power switch is located at the back, on the lower surface.

Caution when moving the main unit

- As this product is heavy, whenever it is moved, two people are required to transport it safely.
- Whenever the unit is moved it should be gripped on the top of the panel and the unit should then be held at the base on both sides for stability as shown.

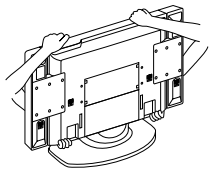

Rear

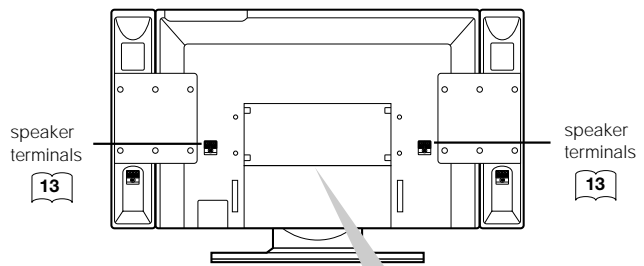

External device connection terminals

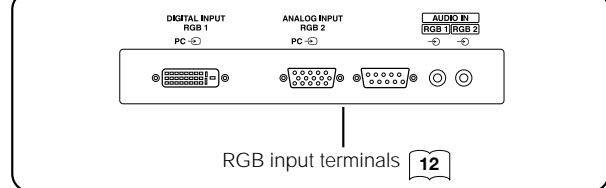

COMPONENT NAMES

Remote control

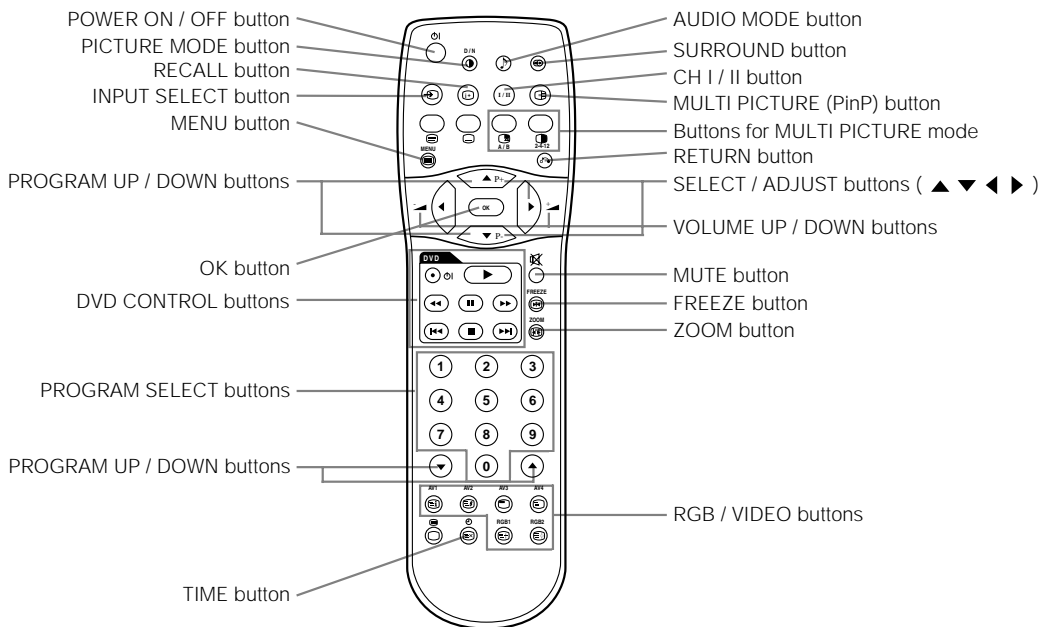

Loading Batteries

- 1. Open the battery cover.**
- Slide back and remove the battery cover in the direction of the arrow.



- 2. Load batteries.**
- Load two Size AA batteries included observing the correct polarities.



- 3. Close the battery cover.**
- Replace the battery cover in the direction of the arrow and snap it back into place.



CAUTION

- Do not use new and old batteries together. The batteries could explode or leak, resulting in fires, physical injury, or stains.
- When loading batteries, observe their correct polarities as marked on the product. If loaded in the wrong direction, the batteries could explode or leak, resulting in fires, physical injury, or stains.

Handling the Remote Control

Use the remote control within about 5 m from front of the unit's remote-control sensor and within 30 degrees on both sides.

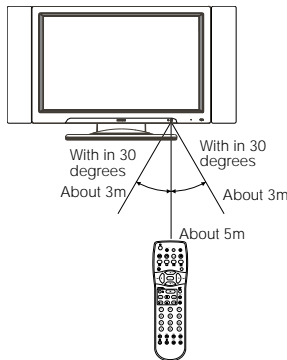

ATTENTION

- Do not drop or impact the remote control.
- Do not splash the remote control with water or put it on a wet object to avoid possible failures.
- Before leaving the remote control out of use for an extended period of time, remove the batteries from it.
- If the remote control begins to lack responsiveness, replace the batteries.
- Strong light such as direct sunlight impinging on the photoreceptor of the remote control can cause operational failure. Position this unit to avoid direct contact with such light.

COMPONENT NAMES (continued)

Remote control (continued)

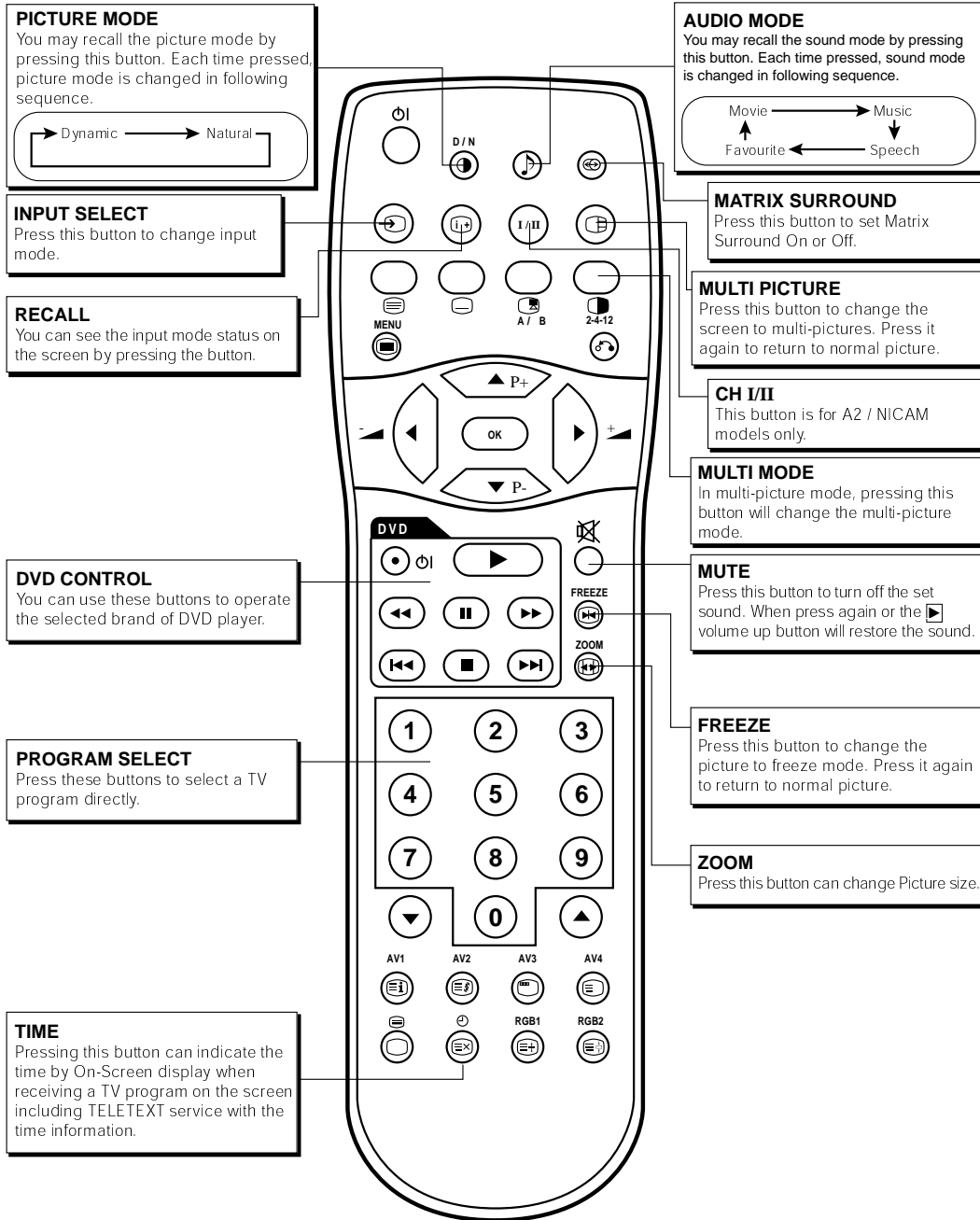

INSTALLATION INSTRUCTIONS

Installation

ENGLISH

⚠ WARNING

Use one of the special mount units to install this product. A mount of insufficient strength or inadequate design can cause overturning or dropping and result in fire, electrical shock or injury. Please note that our company assumes absolutely no responsibility for personal injuries or property damage caused by use of other mount units or improper installation.

⚠ CAUTION

- Installation of the wall mount unit and ceiling mount unit can be dangerous, so do not attempt this work yourself. Ask your dealer to provide the name of a qualified installer.
- In order to prevent an internal temperature increase, maintain a space of 10cm (4 inches) or more between the sides and other objects such as walls, etc., so that the ventilation holes are not blocked. (※)

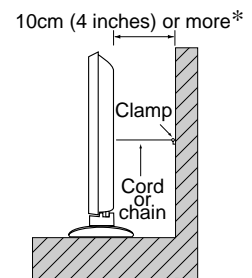

Anti-tumble measures

⚠ CAUTION

Have this unit mounted in a stable place. Take measures to prevent it from tumbling down to avoid possible physical injury.

Securing to a wall or pillar

Using a commercially available cord, chain and clamp, secure the set to a firm wall or pillar.

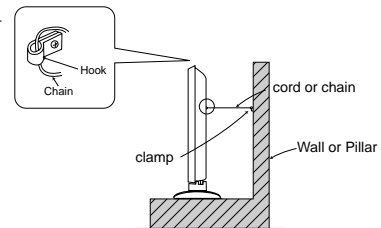

Securing desktop

- 1) Using wood screws (two), fasten the set to the clamping screw holes on the rear of the stand as shown.
- 2) Using commercially available wood screws, secure the set firmly in position.

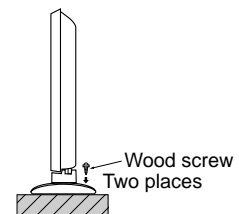

Read SAFETY INSTRUCTIONS (4) to (7) carefully to ensure maximum safety before proceeding to these steps:

- Choose an appropriate site and install the product on a level table where the stand is secure.
 - Install the monitor to have ready access to a power socket available.
- Make sure that the power switch of this device is turned off.

Connecting to a PC

(1) Make sure that the display signal of the personal computer to be used is compatible with the specifications of this device.

- See "Product Specifications" concerning the specifications of this device. 51 ~ 52

(2) Make sure that the power switch of the personal computer is turned off.

(3) Connect the signal input terminal (RGB 1 or RGB 2) on the rear panel of this device to the display signal output terminal of the personal computer.

- Use a cable that fits the input terminal of this device and the output terminal of the personal computer.
- Depending on the type of personal computer being connected, the use of an optional conversion adapter or the adapter provided with the personal computer may be necessary in some cases. For details, refer to the instruction manual of the personal computer or ask the personal computer manufacturer or your local retail dealer.

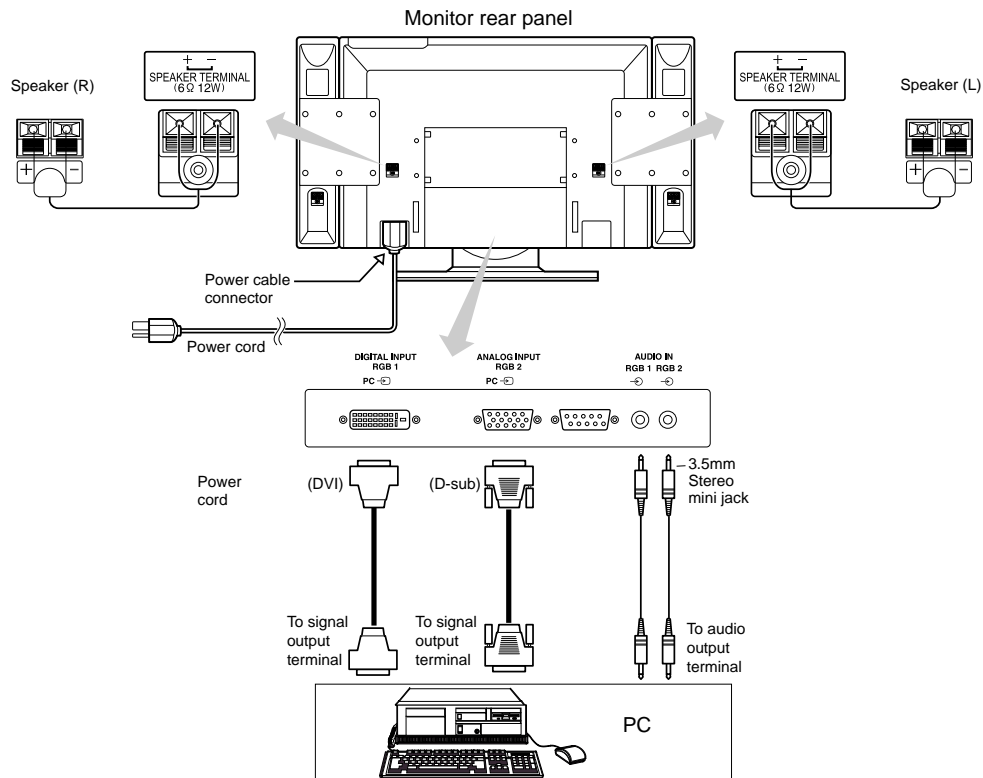

INSTALLATION INSTRUCTIONS (continued)

Speaker Cable Connection

Make sure the polarity of the connections.

Speaker side

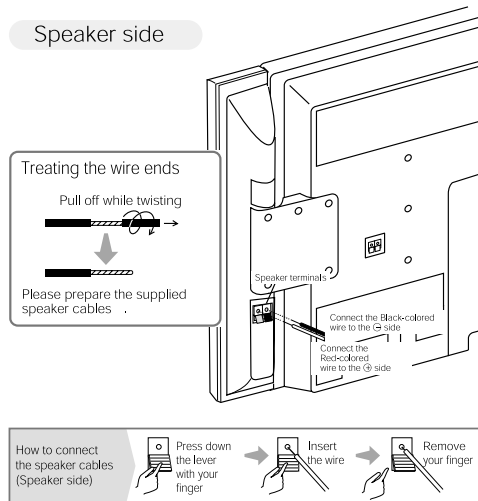

Monitor side

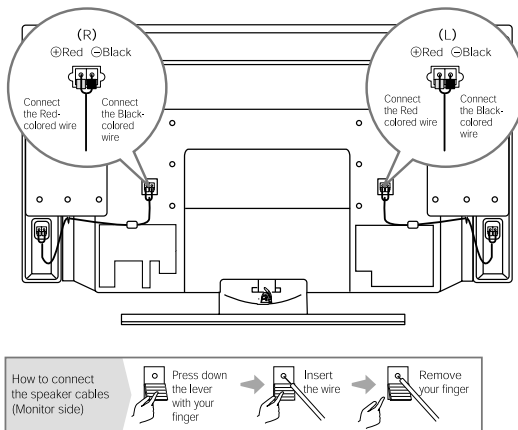

ENGLISH

Power Cord Connection

Connect the power cord, after completing all other connections.

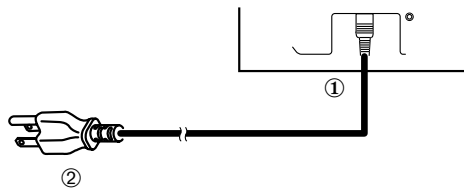

- ① Connect the power cord to this device.
 - ② Connect the power cord plug to the power outlet.
- (The type of plug is different from this drawing for some countries.)

CAUTION

- Use only the power cord provided.
- Do not use a power supply voltage other than that indicated (AC100-240V, 50/60Hz) as this may cause fire or electric shock.

OPERATING INSTRUCTIONS

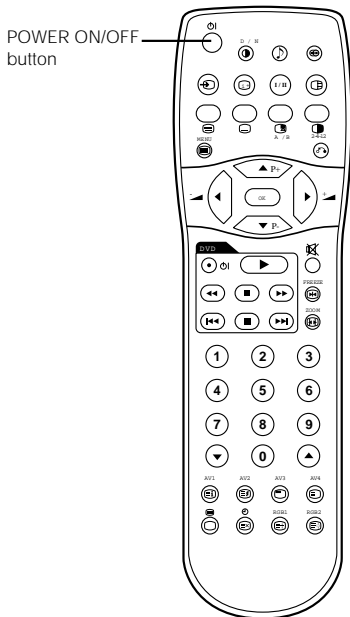
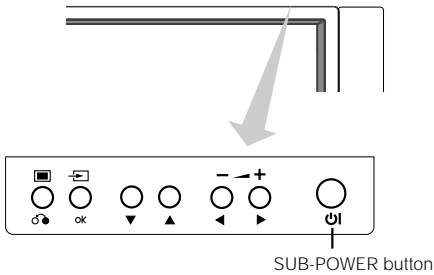
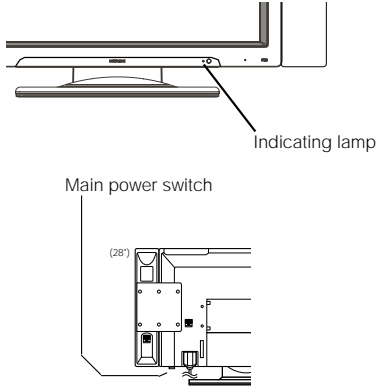

Turning Power On and Off

- To turn the monitor power ON, press the main power switch on the monitor main unit to ON, and then press the SUB POWER button or the ON/OFF or ON button on the remote control.
- To turn the monitor power OFF, press the SUB POWER button or the ON/OFF or OFF button on the remote control, and then press the main power switch on the monitor main unit to OFF.
 - During normal use, the main power switch is set in the ON position, and the monitor can then be turned ON/OFF using the SUB POWER button or the ON/OFF button on the remote control.

Indicating lamp

Indicating lamp	Power status	Operating
Off	Off	When the main power switch is set to OFF.
Lights red	Off (standby)	When the main power switch is ON, and the OFF button on the remote control or the SUB POWER button on the top of the front of the frame is OFF.
Lights green	On	When the main power switch is ON, and the ON button on the remote control or the SUB POWER button on the top of the front of the frame is ON.
Lights orange	Off (Power Save)	When the main power switch is ON, and the ON button on the remote control or the SUB POWER button on the top of the front of the frame is ON. However, the state in POWER SAVE mode

When the indicating lamp lights in orange or the message "No Sync. Signal", "Power Save" or "Invalid Scan Freq." appears on the screen, there is something unusual about the status of reception. See "Power Save Mode" or "Symptoms That Seemingly Appear to be Failures." [23](#) [25](#)

ATTENTION

- Avoid repeatedly turning the monitor on and off at short time intervals. Failures might result from such operation.
- Turn off the main power switch before leaving the monitor out of use for an extended period of time.
- If a power failure occurs while the main unit is running, it would be powered on upon recovery from the failure. Turn off the unit main power switch before leaving the main unit.

OPERATING INSTRUCTIONS (continued)

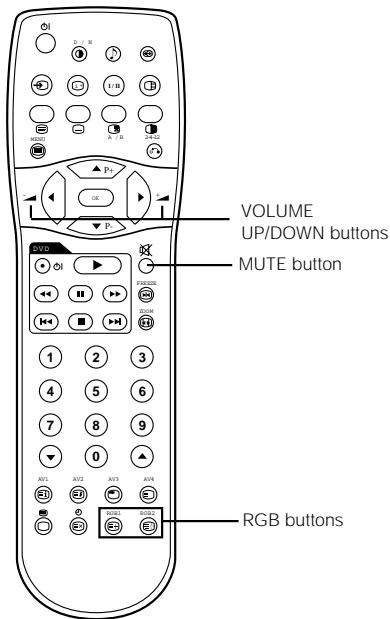
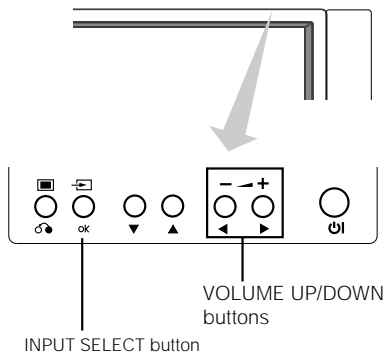

Volume Adjustment

The volume can be adjusted by pressing the VOL+ and VOL- buttons of the remote control or the ► and ◀ volume buttons of the monitor unit).

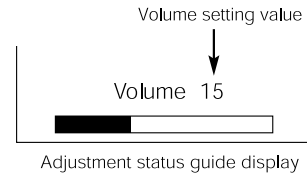

• When a button is pressed, the volume adjustment status guide will be displayed.

- The volume will increase when the VOL+ (or ►) button is pressed while the guide is being displayed.
- The volume will decrease when the VOL- (or ◀) button is pressed while the guide is being displayed.

Audio Mute

The audio volume can be temporarily mute by pressing the MUTE button of the remote control.

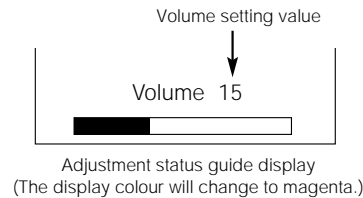

• When a button is pressed, the volume adjustment status guide (magenta) will be displayed.

- The volume setting can be lowered by pressing the VOL- button while the audio is mute.
- The muting can be cancelled by pressing the VOL+ button or MUTE button while the audio is mute.

When the MUTE button of the remote control is pressed again, the audio will be restored and the volume display (green) will appear.

Input Switching

• Input can be switched by pressing the AV1, AV2, AV3, AV4, RGB1 or RGB2 buttons of the remote control. And the way to return to a TV channel is as follows:

- Pressing INPUT SELECT button at RGB2 input screen.
- Pressing some PROGRAM SELECT buttons and select a TV channel.
- Pressing PROGRAM UP/DOWN buttons at the screen without OSD(On-screen display).

• Input can be switched in the sequence of TV → AV1 → AV2 → AV3 → AV2 → AV3 → AV4 → RGB1 → RGB2 by pressing the INPUT SELECT button of the monitor or the remote control.

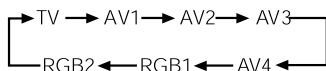

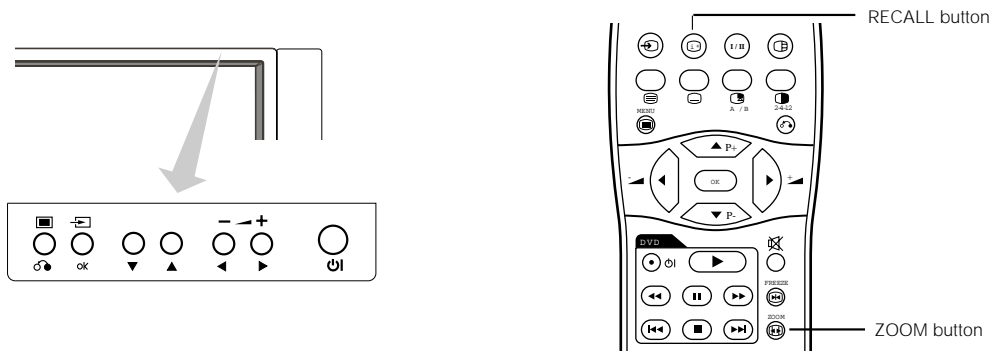

Size Switching

Each time the ZOOM button of the remote control is pressed, the screen display area will change in sequence and the status will be displayed at the bottom of the screen.

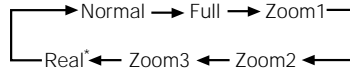

Display area selection diagram (RGB input)

Resolution	Full display	Circular display				
Display	Full	Normal	Real	Zoom1	Zoom2	Zoom3
640 X 480 (VGA)						
800 X 600 (SVGA)						
1024 X 768 (XGA)						
1280 X 1024 (SXGA)			Cant select			
1600 X 1200 (UXGA)			Cant select			
1366 X 768 (WXGA)			Cant select			
1280 X 768 (WXGA)		Cant select	Cant select	Cant select	Cant select	Cant select

Processes such as compression (thinning) and expansion are performed for the above signal display. Because of this, there is a possibility that flicker may become noticeable on Zoom (1 - 3) depending on the display contents. If this occurs, turning the Vertical Filter On **21** can reduce the flicker.

Input Signal Screen Display

The input signal status can be displayed on the screen by pressing the RECALL button of the remote control.

- The display will go out in approximately 6 seconds.

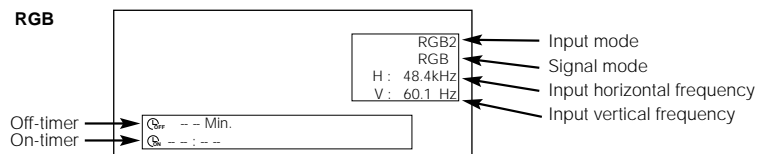

OPERATING INSTRUCTIONS (continued)

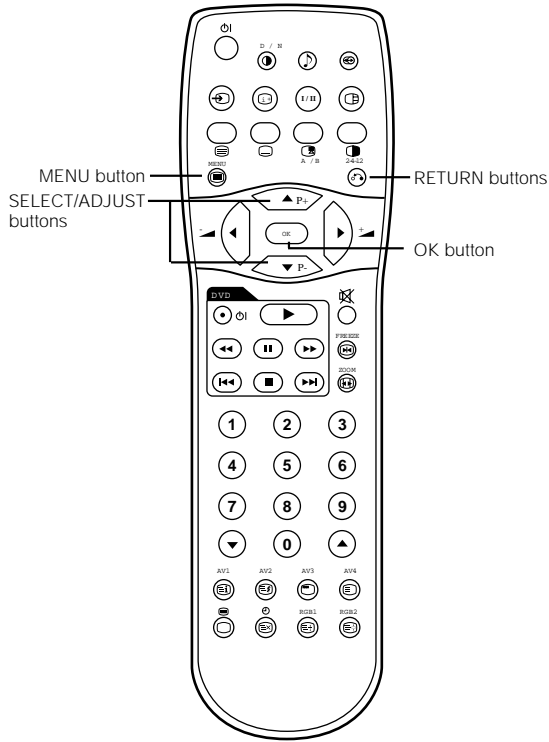

Using the Menu Screen (On-screen display system)

ENGLISH

When the MENU button is pressed, the adjustment menu screen will be displayed; from there, PC signal adjustment and setting is possible by using the SELECT button, ADJUST button and OK button.

• Refer to 18 - 22 concerning the adjustment items and the settings.

Example: Selecting the Picture screen

1. Press the MENU button to display the Main Menu screen.

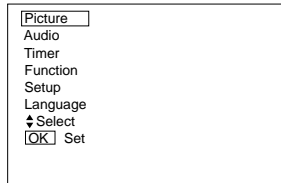

2. Press the OK button to display the Picture Menu screen. (Use the ▲ and ▼ SELECT buttons to select other items.)

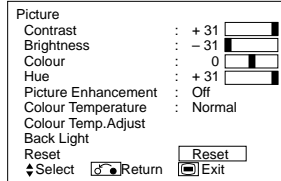

3. Use the ▲ and ▼ SELECT buttons to select the item to be adjusted and then use the ◀ and ▶ ADJUST buttons to adjust (example: Contrast).

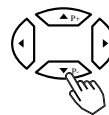

- Press the RETURN button to return to the previous screen.
- If there is no operation for a period of one minute, the Adjustment Menu screen will be closed automatically.

OPERATING INSTRUCTIONS (continued)

AUDIO MENU

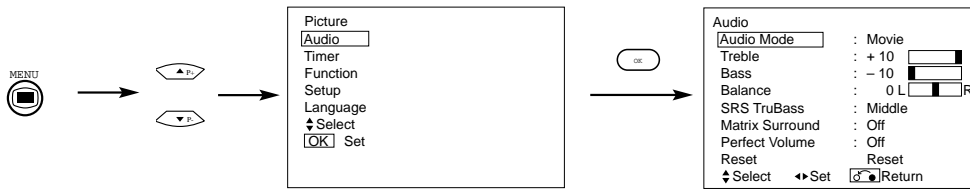

ENGLISH

Selected characters			Setup hint
Audio Mode	▶ Movie ↔ Music ↔ Speech ↔ Favourite ◀		Movie: This selects the audio suitable for Movie. Music: This selects the audio suitable for Music. Speech: This selects the audio suitable for News, Talk show etc. Favourite: This mode should be adjusted depending on user's preference.
Treble	Suppresses treble.	Enhances treble.	Adjust to taste.
Bass	Suppresses bass.	Enhances bass.	Adjust to taste.
Balance	Suppresses right-side sound.	Suppresses left-side sound.	Adjust to taste.
SRS TruBass	▶ Off ↔ Low ↔ Middle ↔ High ◀		SRS TruBass takes advantage of the ability of the human ear to be able to distinguish between two different tones. By using this ability, TruBass gives enhanced bass sound that otherwise would not be heard. Adjust it depending on the user's preference.
Matrix Surround	▶ Off ↔ On ◀		This features the spacious sound effects of a stadium.
Perfect Volume	▶ Off ↔ On ◀		This will automatically adjust volume so each channel and input has the same average volume level.
Reset	(off the function)	(waiting to reset)	The original factory settings for the items of this Menu page can be restored by pressing the OK button.

TIMER MENU

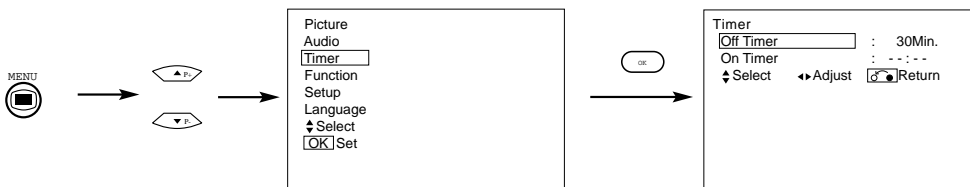

Selected characters			Setup hint
Off Timer	--Min. ↔ 30Min. ↔ 60Min. ↻ 120Min. ↔ 90Min. ↻		This function automatically sets the power to standby status when the indicated time period has elapsed.
On Timer	-- (: --) hours	(- : -) minutes	This automatically sets the power from standby to ON when the indicated time period has elapsed. The settable time is 00:00-11:59. Input the required time by ▼▲ SELECT buttons on the remote control.

FUNCTION MENU

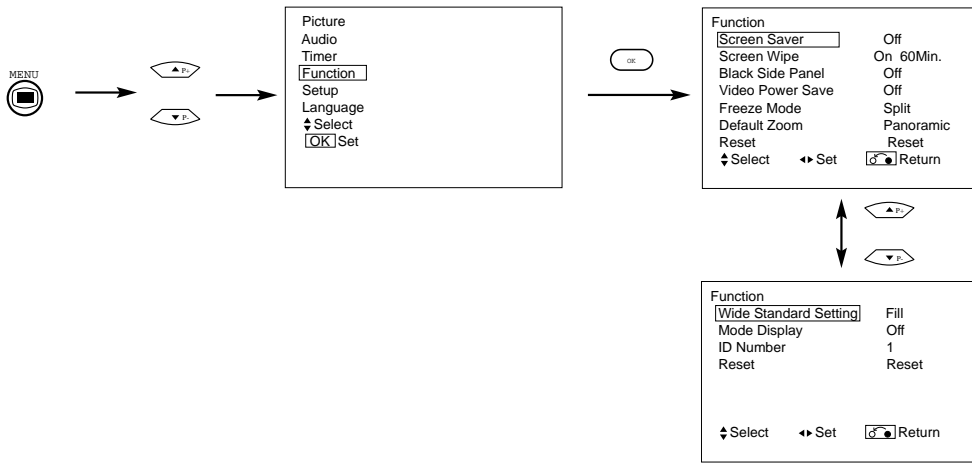

Selected characters	◀	▶	Setup hint
Screen Saver	→ Off	← 5Min. ↔ 10Min. ← ← 60Min. ↔ 40Min. ↔ 20Min. →	This moves the picture around the screen in small amounts, at set intervals, to reduce the panel image retention. This is where stationary objects, such as screen logos, leave a slight image visible after they should have disappeared.
Screen Wipe	On	60Min.	This is used to reduce the panel image retention that can occur with stationary pictures by the white field signal. Select On (continuous operation) or 60 Min. (time limit operation) and press the OK button. Press the MENU or RETURN button on the remote control to return to normal viewing.
Black Side Panel	→ Off	← On	This turns the gray sidebars On/Off when watching normal mode screen size area. It is always set to Off when the monitor powered On. It is recommended to set to Off to reduce the panel image retention.
Video Power Save	→ Off	← On	This is used to reduce power consumption for video input when there is no video signal. Setting it On will leads the monitor to the standby mode when the AV input with no signal is selected.
Freeze Mode	→ Split	← Strobe	This selects the display condition of the FREEZE mode between Split (2 pictures) and Strobe (12 pictures).
Default Zoom	→ Panoramic	← 4:3	This selects the screen display size that appears first when the power turned on.
Reset	(off the function)	(waiting to reset)	The original factory settings for the items of this Menu page can be restored by pressing the OK button.
Wide Standard Set	Fill	↔ Standard	This is used to choose the display size of a picture Set to Fill, and a 16:9 picture comes out on the size of the screen. Set to Standard, and the picture comes out in a size as it is. In this case, the picture would be displayed with slight missing on the top and bottom.
Mode Display	grayed out		This function can't be used.
ID Number	grayed out		This function can't be used.

OPERATING INSTRUCTIONS (continued)

SETUP MENU

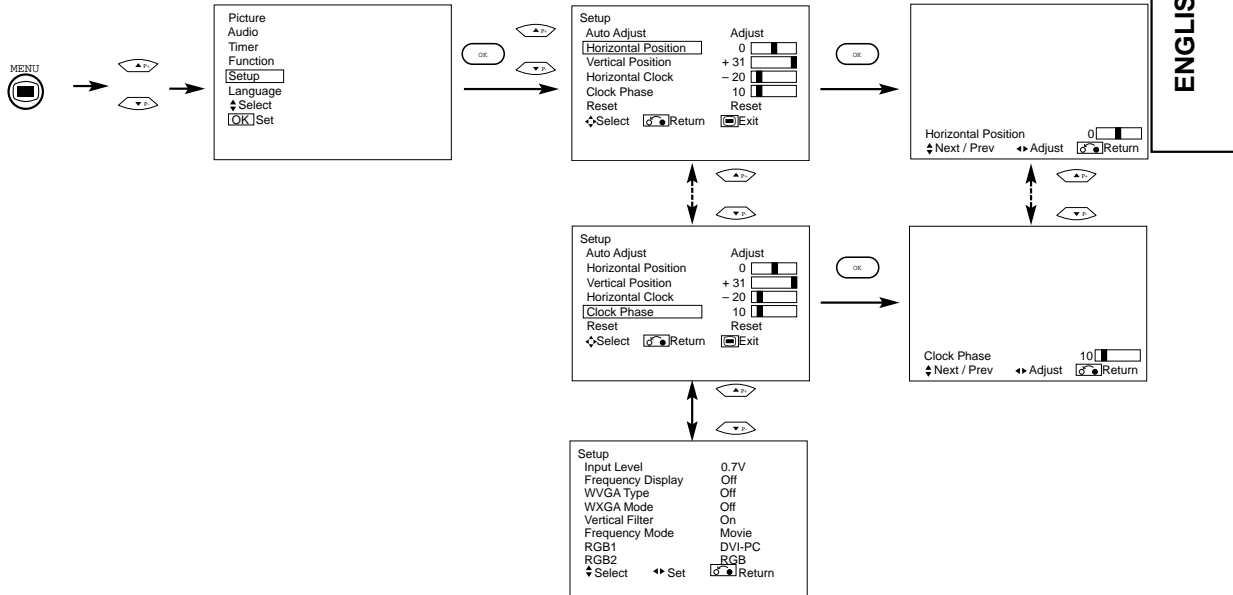

ENGLISH

Selected characters	◀	▶	Setup hint
Auto Adjust*	(Menu)	Adjust	Horizontal Position, Vertical Position, Horizontal Clock and Clock Phase are adjusted automatically.
Horizontal Position	Moves the horizontal position to left. 	Moves the horizontal position to right. 	Adjust the left-side display position. (This function is only for RGB2. It's not available (grayed out) for RGB1.)
Vertical Position	Moves down the vertical position. 	Moves up the vertical position. 	Adjust the vertical display position. (This function is only for RGB2. It's not available (grayed out) for RGB1.)
Horizontal Clock	Reduces the dot clock frequency (shrinks the right side). 	Increases the dot clock frequency (expands the right side). 	Adjust for maximum character clarity. (This function is only for RGB2. It's not available (grayed out) for RGB1.)
Clock Phase	Slows the dot clock phase (shifts slightly to left). 	Advances the dot clock phase (shifts slightly to right). 	Adjust for clear character visibility. (This function is only for RGB2. It's not available (grayed out) for RGB1.)
Reset	(off the function)	(waiting to reset)	The original factory settings for the items of this Menu page can be restored by pressing the OK button. (This is effective only for RGB2.)
Input Level			Normally set to 0.7 V. If white is found to spread across the screen, set to 1.0 V. (This is effective only for RGB2.)
Frequency Display			Set this to Off if the frequency information of the Input Signal Screen Display is not required.
WXGA Type			This is only available for W-VGA signal. When it is set to On, the display area mode can be selected Full or Real.
WXGA mode			This is only available for (PC) WXGA signal. The display area mode is selected 1280X768 or 1366X768.
Vertical Filter			Turn On when concerned about screen flicker.
Frequency Mode			Set to Movie when viewing moving images on a personal computer.
RGB1			This should correspond to the signal mode of the signal form the equipment that is connected to RGB1 DVI terminal.
RGB2			This should correspond to the signal mode of the signal form the equipment that is connected to RGB2 D-sub terminal.
RGB2 (2nd step)			This step should be set only when [Component] is selected on the 1st step. This should correspond to the signal mode of the signal from the equipment that is connected to RGB2 D-sub terminal. • Normally, set this to Auto. The signal mode of the input signal will be automatically recognized. • If the input signal contains much noise or has a low level at Auto and the operation is found erratic, set this to match the input signal.

* Depending on the type of signal displayed, displays may not be optimized through automatic adjustment. Adjust manually to optimize them.

LANGUAGE MENU

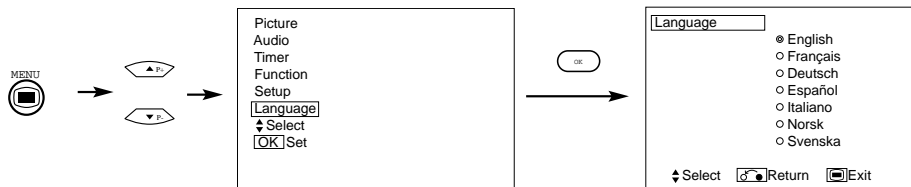

Select a language by ▼▲ SELECT buttons and press the OK button.

OTHER FEATURES

Automatic Store

Approximately 1 sec. after adjustment is completed, the adjustments will be recorded as shown in the table below.

Menu	Display	Registration condition
Picture	Contrast	For every input function, 1 setting is registered.
	Brightness	
	Colour	
	Hue	
	Picture Enhancement	
	Colour temperature	
	Colour Temp. Adjust	
	Back Light	
	R Amplitude	For every Colour Temperature, 1 setting is registered.
	G Amplitude	
	B Amplitude	
	R Cut Off	
	G Cut Off	
B Cut Off		
Audio	Audio Mode	1 setting is registered.
	Treble	For every Audio Mode, 1 setting is registered.
	Bass	
	Balance	1 setting is registered.
	SRS TruBass	For every Audio Mode, 1 setting is registered.
	Matrix Surround	
Perfect Volume		



Menu	Display	Registration condition
Function	Screen Saver	1 setting is registered.
	Screen Wipe	(not registered)
	Black Side Panel	(not registered)
	Mode Display	1 setting is registered.
	ID Number	
Setup	Auto Adjust	(not registered)
	Horizontal Position	For every signal Mode, 1 setting is registered. (Only for RGB2)
	Vertical Position	
	Horizontal Clock	
	Clock Phase	
	Input Level	1 setting is registered.
	Frequency Display	
	WVGA Type	
	WXGA Mode	
	Vertical Filter	
Frequency Mode		
Language		1 setting is registered.

- The previously recorded items will be lost.
- The signal mode can be identified by the horizontal/vertical sync frequency and the sync signal polarity. Different signals with which all the elements are the same or similar will be handled as the same signal.

OTHER FEATURES (continued)

Signal Check

Changes in the signal status are displayed on the screen as they arise.

Status	Display	Action
The input signal is switched or when the RECALL button is pressed.	A guide is displayed for the input terminal and the horizontal and vertical sync frequency.	_____
When the sync signal is no longer detected.	<ul style="list-style-type: none"> A guide displays No Sync. Signal, and Power Save (for approx. 5 sec.) When the condition continues where the sync signal cannot be detected, indicator lamp of power source changes in orange and the mode switches to power save mode. 	Recheck the personal computer power switch status and the connection status.
When the input signal does not match the monitor specifications or is in an unstable status.	A guide displays Invalid Scan Freq.	Recheck the input signal specifications.  

RGB

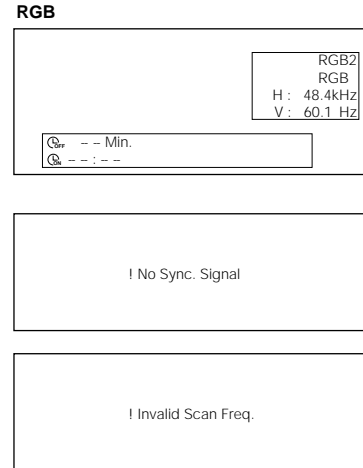

RGB2
RGB
H : 48.4kHz
V : 60.1 Hz

--- Min.

! No Sync. Signal

! Invalid Scan Freq.

ENGLISH

Power Save Mode

When the RGB, RGB2 input is selected

- When this unit is connected to a VESA DPMS computer, the Power Save (Off) mode can be set to be activated automatically when the computer is not being used to reduce power consumption by this unit.

RGB sync signal	Horizontal	Yes	No	Yes	No
	Vertical	Yes	Yes	No	No
PC signal		Active (normal display)		Blank (no display)	
Operation mode		On		Off	
Indicating lamp		Lights green		Lights orange	
Power consumption		155W		1W or less	

Returning to operating status

- Operate the personal computer, or press either the INPUT SELECT button of the main unit or the RGB1/RGB2 buttons of the remote control.

NOTES

About screen defects

- High precision technology is used in the making of LCD panels but there may be dark spots (points that do not illuminate) and bright spots (points that are too bright) in some cases. These do not indicate a malfunction.

About residual images

- In some cases, residual images may remain after the short-term display of still images and another image is displayed, but these will disappear and return to normalcy. This is not a malfunction.

About the panel screen

- LCD displays display images by illuminating phosphor inside the panel. Because of this, the temperature of the panel surface may rise in some cases. Also, LCD displays are made of finely processed glass. A reinforced glass filter is not installed over the LCD panel surface so avoid strong impact because of danger of glass breakage.

About using in a low ambient temperature

- The response speed of LCD panel becomes slow as ambient temperature falls. This feature may cause residual images in some cases, but this is not a malfunction. It will return to normalcy in a little while after the temperature becomes normal.









TROUBLESHOOTING

Symptoms That Seemingly Appear to be Failures

Make the checks suggested below depending on the symptoms observed. If the symptoms remain uncorrected, contact your dealer.

 **WARNING**
Customer servicing can be hazardous.

ENGLISH

Symptom	Point to check	See page
<ul style="list-style-type: none"> No picture with the power-indicating lamp off. 	<ul style="list-style-type: none"> Check the way the power cable is connected. Press the power switch. 	<div style="border: 1px solid black; padding: 2px; display: inline-block;">13</div> <div style="border: 1px solid black; padding: 2px; display: inline-block;">14</div>
<ul style="list-style-type: none"> The message "No Sync. Signal" or "Power Save" is displayed. No picture with the power indicating lamp lights in orange.  	<p>No sync signal is detected.</p> <ul style="list-style-type: none"> Check the way the signal cable is connected. Make sure that the switch of the computer, imaging equipment, etc., is turned on. Make sure the computer is not in the power-save mode. Check to see if the input selection matches the connection terminal. 	<div style="border: 1px solid black; padding: 2px; display: inline-block;">12</div>
<ul style="list-style-type: none"> The message "Invalid Scan Freq." is displayed. 	<p>An input signal is not received normally.</p> <ul style="list-style-type: none"> Check to see if the input signal matches the monitor specifications. Check the way the signal cable is connected. 	<div style="border: 1px solid black; padding: 2px; display: inline-block;">12</div> <div style="border: 1px solid black; padding: 2px; display: inline-block;">51</div> <div style="border: 1px solid black; padding: 2px; display: inline-block;">52</div>
<ul style="list-style-type: none"> The power indicating lamp is normally lit but no picture. 	<ul style="list-style-type: none"> Check the contrast and brightness settings (adjust them for higher contrast and brightness). Check the way the signal cable is connected. 	<div style="border: 1px solid black; padding: 2px; display: inline-block;">12</div> <div style="border: 1px solid black; padding: 2px; display: inline-block;">18</div>
<ul style="list-style-type: none"> The display image appears flowing slantwise. Text displayed across the screen appears vertically streaked, with the characters in vertical columns blurred.  	<ul style="list-style-type: none"> Adjust the dot clock frequency and phase. (Adjust the dot clock frequency first, the dot clock phase next.) (RGB input) 	<div style="border: 1px solid black; padding: 2px; display: inline-block;">21</div> <div style="border: 1px solid black; padding: 2px; display: inline-block;">27</div>
<ul style="list-style-type: none"> Text displayed across the screen appears blurred. A fine pattern flickers when displayed on the screen.  	<ul style="list-style-type: none"> Adjust the dot clock phase for the clearest viewing. (RGB input) 	<div style="border: 1px solid black; padding: 2px; display: inline-block;">21</div> <div style="border: 1px solid black; padding: 2px; display: inline-block;">27</div>
<ul style="list-style-type: none"> The remote control does not work. 	<ul style="list-style-type: none"> Check to see if the batteries are loaded in the remote control in opposite direction. Check to see if the batteries in the remote control are OK. 	<div style="border: 1px solid black; padding: 2px; display: inline-block;">9</div>

Symptom	Point to check	See page
<ul style="list-style-type: none"> The temperature of the display panel surface is high. 	<ul style="list-style-type: none"> LCD displays display images by illuminating phosphor inside the panel. In some cases, this may cause the temperature of the panel surface to increase. Please note that this is not a malfunction. 	-
<ul style="list-style-type: none"> There are locations on the screen that are different from the periphery (*). *Points that do not light, points with brightness different from that of the periphery, points with color different from that of the periphery, etc. 	<ul style="list-style-type: none"> High-precision technology is used to manufacture the LCD display panel. However in some cases, there are minor defects in some parts of the screen. Please note that this is not a malfunction. 	-
<ul style="list-style-type: none"> Coarse horizontal stripes appear in FULL display. 	<ul style="list-style-type: none"> Adjusting the Clock Phase will reduce the horizontal stripes. (RGB input) 	21
<ul style="list-style-type: none"> Flickering in the form of horizontal lines oscillating up and down. (PC INPUT MODE only) 	<ul style="list-style-type: none"> If the direct frequency from the computer is below 85Hz, try a higher frequency (upper limit 85Hz). There may be a slight attenuation of the current image. Try turning the Vertical Filter On. For this case however, the vertical resolution will drop. 	21
<ul style="list-style-type: none"> The top of the monitor heats up. 	<ul style="list-style-type: none"> When used for long periods of time, the top of the monitor may heat up. This is not a malfunction. 	-
<ul style="list-style-type: none"> Text characters are displayed with varying thicknesses. 	<ul style="list-style-type: none"> The thicknesses of characters and lines may vary if images with a vertical resolution greater than 768 lines are displayed; however this is not a malfunction. 	-

TROUBLESHOOTING (continued)

Actions to Correct Abnormal Displays

ENGLISH

Depending on the kind of system equipment used, images may not be displayed normally. In this case, make the adjustments suggested below. (only for RGB2)

Symptom 1	Text displayed across the screen appears vertically streaked, with some characters blurred (figure 1). The display image appears flowing (figure 2) (RGB input).
Example	<p>Figure 1</p>
Adjustment procedure	<ol style="list-style-type: none"> 1) Press the MENU button. The Main Menu will be displayed. 2) Press the ▼ SELECT button and select Setup. 3) Press the OK button. The Setup Menu will be displayed. 4) Press the ▼ SELECT button and select Auto Adjust. <p>When adjustment is not possible with Auto Adjust</p> <ol style="list-style-type: none"> 5) Press the MENU button. The Main Menu will be displayed. 6) Press the ▼ SELECT button and select Setup. 7) Press the OK button. The Setup Menu will be displayed. 8) Press the ▼ SELECT button and select Horizontal Clock. <p>(Display fine patterns as characters or a vertical striped pattern over the entire screen during Horizontal Clock adjustment.)</p> <ol style="list-style-type: none"> 9) Press the ► or ◀ ADJUST buttons and search for clear characters over the entire screen. 10) Perform adjustment for symptom 2 below, when the characters are blurred on the entire screen.

• The display image may be momentarily disturbed during clock adjustment but this is not a failure

Symptom 2	Text displayed across the screen appears blurred in its entirety (figure 2). A fine pattern flickers when displayed on the screen (figure 3).	
Example	<p>Figure 2</p>	<p>Figure 3</p>
Adjustment procedure	<ol style="list-style-type: none"> 1) Press the MENU button. The Main Menu will be displayed. 2) Press the ▼ SELECT button and select Setup. 3) Press the OK button. The Setup Menu will be displayed. 4) Press the ▼ SELECT button and select Auto Adjust. <p>When adjustment is not possible with Auto Adjust</p> <ol style="list-style-type: none"> 5) Press the MENU button. The Main Menu will be displayed. 6) Press the ▼ SELECT button and select Setup. 7) Press the OK button. The Setup Menu will be displayed. 8) Press the ▼ SELECT button and select Clock Phase. <p>(Display fine patterns as characters or a vertical striped pattern over the entire screen during Clock Phase adjustment.)</p> <ol style="list-style-type: none"> 9) Press ► or ◀ ADJUST buttons to make the text appear clean across the screen. 9) Press ► or ◀ ADJUST buttons to make the text appear without flickering. 	

Video Unit Function

INSTALLATION INSTRUCTIONS

Connecting to a Video Imaging Device

- (1) Make sure that the power switch of the monitor is turned off.
- (2) Make sure that the power switch of the imaging device is turned off.
- (3) Use a commercially available cable and connector to connect the signal input terminal on the rear panel of this device and the signal output terminal of the imaging device.

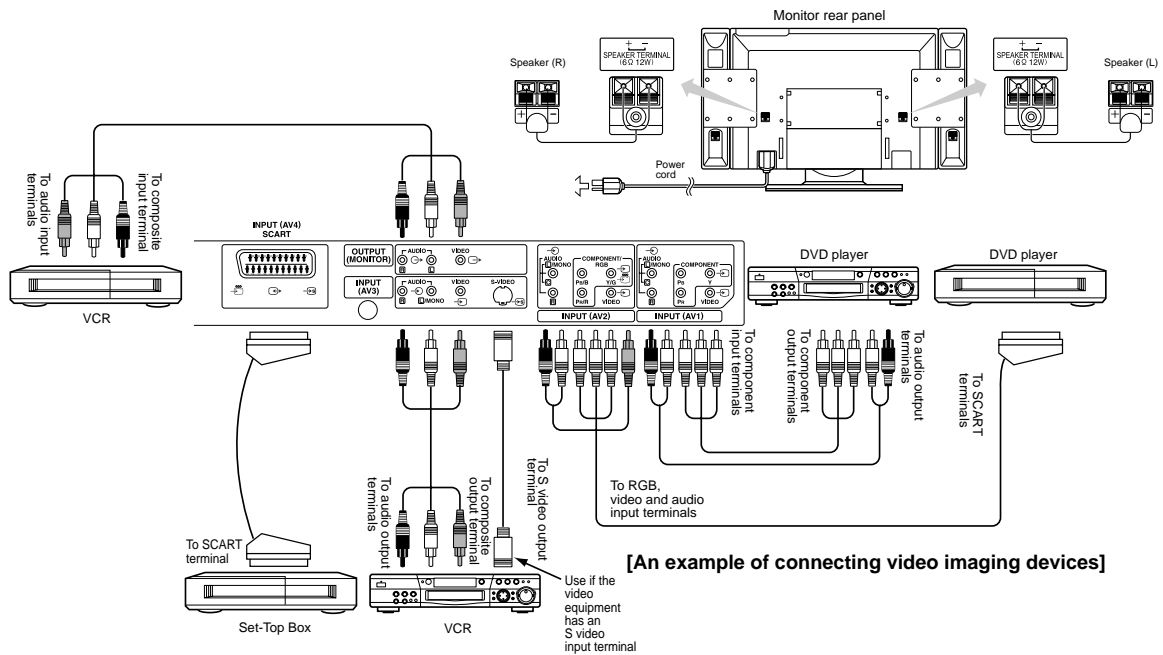

With DVI-STB and RGB component setup

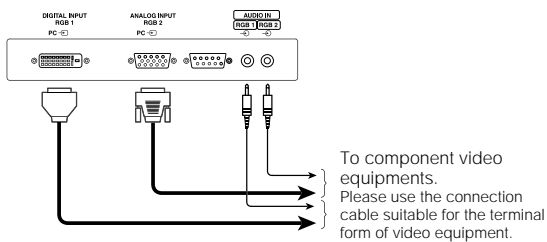

- If video equipment with an S video output terminal is used, cabling by the S video cable is recommended to provide finer video quality. (If the S video input terminal and the video input terminal of AV3 connect to the monitor at the same time, S video input would govern.)
- If the OUTPUT (MONITOR) terminal is connected to an external monitor with a 75 Ohm terminal, it is possible to view the same image as on the main unit. But it is possible to monitor only the composite video signal from AV1, AV2, AV3, or AV4 input that is displayed on the screen at the time.

Applicable video signals for each input terminal (See PRODUCT SPECIFICATIONS for details. 49)

Terminal	RCA/SCART				DVI		D-sub		Remarks
Signal	CVBS	S-video	Component	RGB	PC	STB	RGB	Component	
AV1	○		○						
AV2	○		○	○					Refer to Setup Menu. 35
AV3	○	○							Refer to Setup Menu. 35
AV4	○	○		○					Refer to Setup Menu. 35
RGB1					○	○			Refer to Setup Menu. 36
RGB2							○	○	Refer to Setup Menu. 36

(○ : Available)

OPERATING INSTRUCTIONS

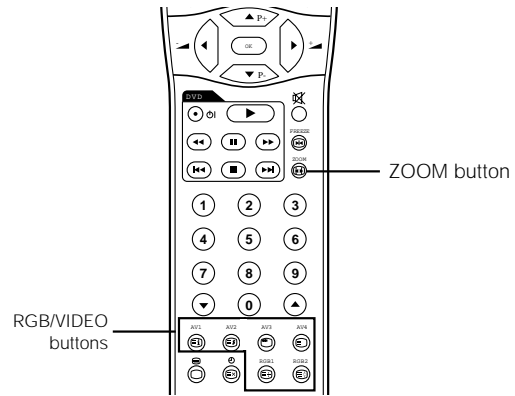
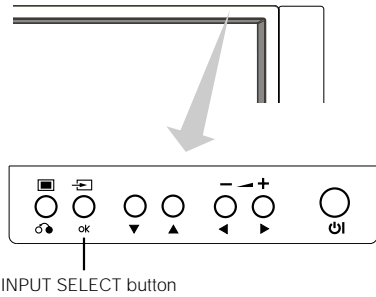

ENGLISH

Input Switching

• **Input can be switched by pressing the AV1, AV2, AV3, AV4, RGB1 or RGB2 buttons of the remote control. And the way to return to a TV channel is as follows:**

- Pressing INPUT SELECT button at RGB2 input screen.
- Pressing some PROGRAM SELECT buttons and select a TV channel.
- Pressing PROGRAM UP/DOWN buttons at the screen without OSD(On-screen display).

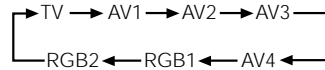

• **Input can be switched in the sequence of TV → AV1 → AV2 → AV3 → AV4 → RGB1 → RGB2 by pressing the INPUT SELECT button of the monitor or the remote control.**

Size Switching

Each time the ZOOM button of the remote control is pressed, the screen display size will change in sequence and the status will be displayed at the bottom of the screen.

- During VIDEO signal input (AV1, AV2, AV3)

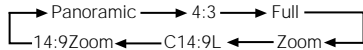

- The size will fix as Full mode and not change when receiving the component signal of 1080i/50, 1080i/60 or 720p/60.



- During AV4 signal input

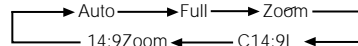

- [Auto] is the mode using the Switch signal from the equipment connected to AV4 terminal included in SCART connector No.8 pin which indicate the picture format of the video source. When Switch signal has not been detected, Default Zoom setting in the Function Menu is used to choose.
- And during some input mode except AV4, if the Switch signal is detected under the condition that [Auto] is selected for the picture size of AV4, the input mode will automatically transfer to AV4.

Display size selection diagram

When you want to	Set the display size to	Input signal	Display screen	Remarks
Play a 4:3 image in a 16:9 screen faithfully.	4 : 3	 (4:3 signal)		Blanking occurs on both sides.
Play a 4:3 image in a 16:9 screen with the height and width of the middle of the screen enlarged on equal scales and with both sides appearing somewhat enlarged.	Panoramic			
Play a 16:9 VISTA size image in the 4:3 image faithfully reproduced on the 16:9 screen.	Zoom	 (Vista)		<ul style="list-style-type: none"> • The 4:3 image is called a letterbox image. • In some cases, some slight blanking may remain at the top and bottom.
Play a 4:3 image faithfully in a 16:9 screen in the standard vertical size and horizontally squeezed.*	Full	 (Squeeze)		* An image with an aspect ratio of 16:9 shrunk horizontally to 4:3 to display in a 4:3 screen
Play a 14:9 image in a 16:9 screen expanded vertically and squeezed horizontally.	C14 : 9L	 (14:9 signal)		This mode is provided for the broadcasting program with WSS code-C14:9L.
Play a 14:9 image expanded vertically on the 16:9 screen.	14 : 9Zoom	 (14:9 signal)		This mode is provided for the broadcasting program with WSS code-14:9Zoom.

Vertical picture position can be adjusted for [Panoramic], [Zoom], [C14:9L] and [14:9Zoom] mode as follows.

1. Press ZOOM button and ▲ P+ ▼ P- SELECT buttons during picture size display.
2. Position display will appear.
3. Adjustment range of each picture size are as shown below.

[Panoramic]	- 12 to + 12
[Zoom]	- 31 to + 31
[C14:9L] and [14:9Zoom]	- 16 to + 16
4. When 1080i/60 component signal is received, vertical position can be adjusted only one step up. (The range: 0 to +1)

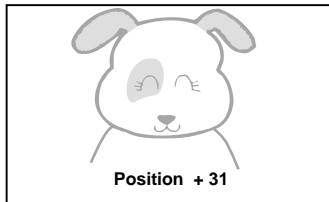

Press ▲

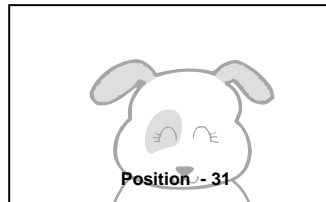

Press ▼

ATTENTION

Using a wide-screen monitor

- This monitor has a screen mode selection feature. If an incompatible screen mode is selected to play certain software, such as a TV program, the image would appear different from the original. Take this into consideration when making screen mode choices.
- Use of this monitor in its enlarged display mode with the wide feature enabled in coffee shops, hotels and other establishments for commercial or public viewing purposes could infringe on the copyright holder's right protected by Copyright Law.
- When a normal 4:3 image is displayed over the entire screen in the Panoramic mode, parts of the periphery of the image may disappear and/or appear distorted in some cases. Use the 4:3 mode to view images, which were created in 4:3 mode. This mode allows 4:3 content to be viewed without picture distortion.

OPERATING INSTRUCTIONS (continued)

ENGLISH

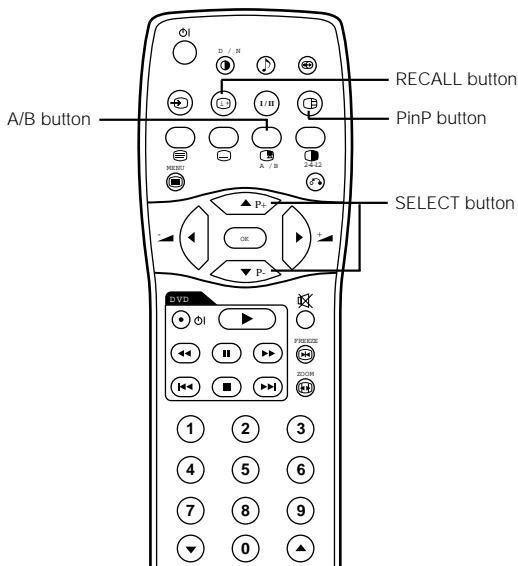
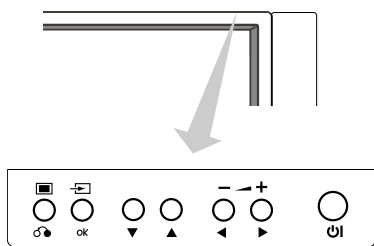

Displaying MULTI PICTURE

If the PinP button on the remote control is pressed MULTI PICTURE will display.

Activating the P-in-P mode from the RGB input screen

Pressing the PinP button one time will display 2 pictures.

- This mode can be available from RGB1(DVI-PC) and RGB2(RGB) input.
- The speaker icon can be shifted left and right by pressing the A/B button; the audio of the video will be output from the side on which the speaker icon is located.
- The sub-screen position can be selected up and down by pressing ▼ ▲ SELECT buttons.
- The sub-screen can be selected with the AV1, AV2, AV3, and AV4 buttons from the status that the speaker icon appears on the left side of AV* as shown in the diagram to the right.
- Pressing the PinP button again or the RETURN button will cancel the 2 pictures display.
- "Frequency Mode" in the Setup Menu should be set to Movie when sub-screen is the component signal of 1080i/50 or 1080i/60.

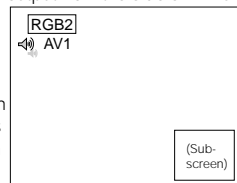

AV1: Displays the VIDEO input signal of the sub-screen.

Activating the Split mode from the video input screen

Pressing the PinP button one time will display 2 pictures.

- The speaker icon can be shifted left and right by pressing the A/B button; the audio of the video will be output from the side on which the speaker icon is located.
- The same video input mode cannot be selected for both screens at the same time.
- Pressing the PinP button again or the RETURN button will cancel the 2 pictures display.
- When the Video input is set to RGB Video, this Split mode is not possible.
- Refer to the table for 2 pictures (Split) mode.

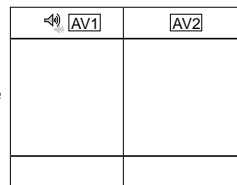

2 Pictures (Split)

Input terminal			AV1~AV4				AV1, AV2			RGB1	RGB2
	Main	Sub	PAL SECAM	NTSC3.58 NTSC4.43	576i 576p	480i 480p	1080i/50	1080i/60	720p/60	STB	Component
AV1 ~AV4	PAL, SECAM		○	○	○	○	○	○	○		
	NTSC3.58/4.43		○	○	○	○	○	○	○		
AV1 AV2	576i, 576p		○	○							
	480i, 480p		○	○							
	1080i/50		○	○							
	1080i/60		○	○							
RGB1	STB										
RGB2	Component		○	○	○	○	○	○			

(○ : Available)

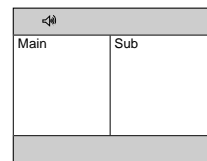

NOTE

- Even if the input of the horizontal / vertical synchronizing signal (or video signal) stops in the MULTI PICTURE display, the mode will not change to power save mode.
- Please be careful since image retention will occur if display is left in a MULTI PICTURE display state for a long period of time.

Input Signal Screen Display

The input signal status can be displayed on the screen by pressing the RECALL button of the remote control.

- The display will go out in approximately 6 seconds.

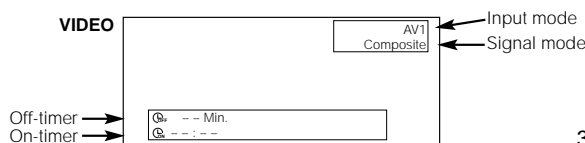

PICTURE MENU

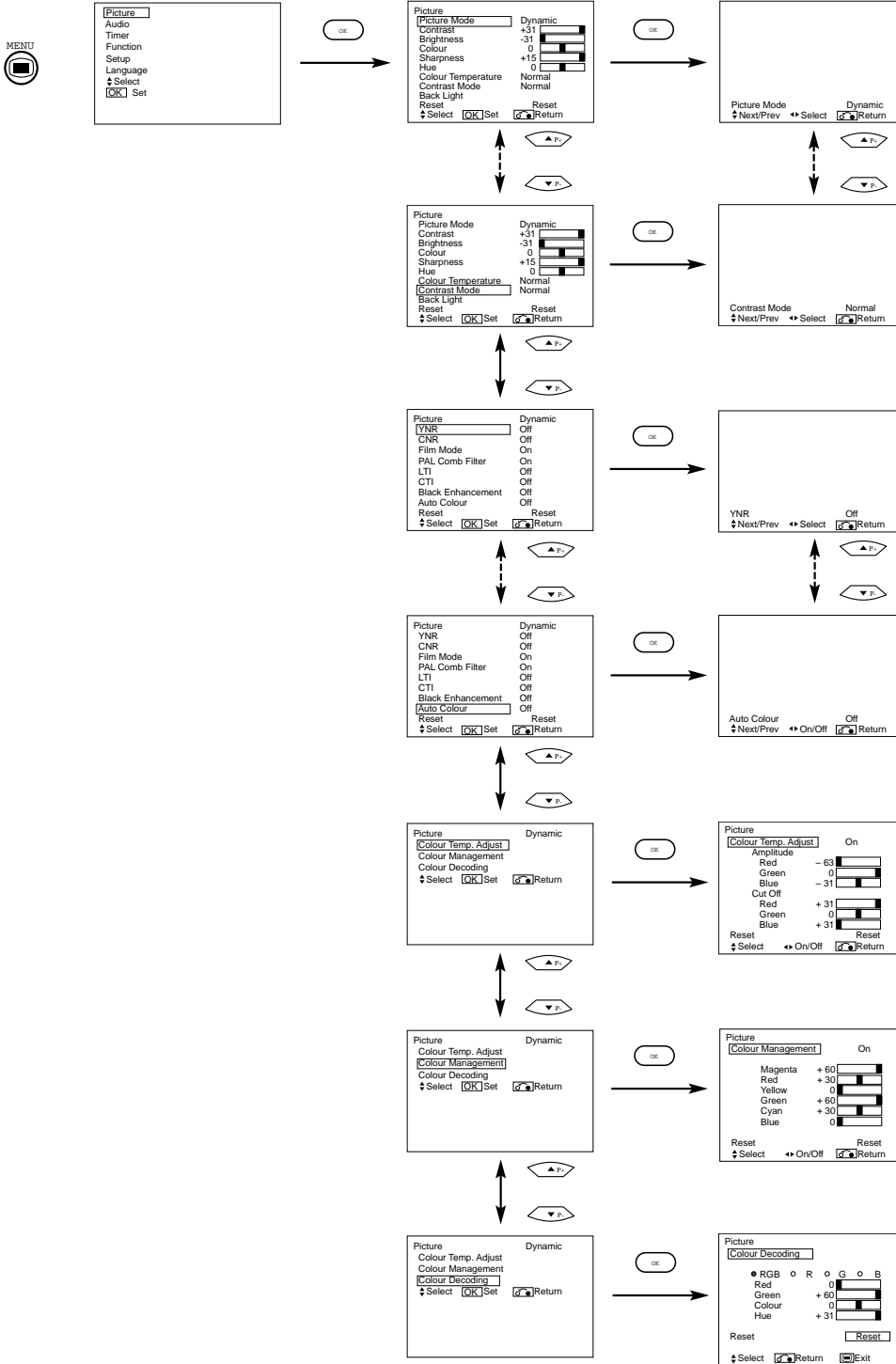

OPERATING INSTRUCTIONS (continued)

PICTURE MENU (continued)

ENGLISH

Selected characters				Setup hint
Picture Mode		Dynamic ↔ Natural		Dynamic: This setting is best for very bright ambient lighting. Natural: This setting is for normal lighting conditions.
Contrast		Narrows the gap between brightness and darkness.	Broadens the gap between brightness and darkness.	Adjust for maximum visibility to suit the ambient brightness. This can adjust further till [+40] by pressing and holding ► cursor button at [+31]. The color for [+32] to [+40] numbers will change from white to magenta. This special mode is better for dark scenes.
Brightness		Black is subdued for increased overall darkness.	Black is set off for increased overall brightness.	Adjust to taste.
Colour		Darkens colours.	Lightens colours.	Adjust to taste.
Sharpness		Soft	Sharp	Normally set to Centre position Shift to the minus (-) side for a softer effect and plus (+) for sharper picture.
Hue		Enhances red and weakens green.	Enhances green and weakens red.	This is not available to adjust when receiving PAL/SECAM signal. Then the character will be grayed out. Adjust for most realistic skin colour.
Colour Temperature		Cool ↔ Normal ↔ Warm ↔ Black / White		Normally set to Cool.
Contrast Mode		Normal ↔ Auto ↔ Dynamic		Dynamic: Emphasizes the differences between video shadings to improve the feeling of contrast. Normal: The gradation of an image is reproduced as faithfully as possible. Auto: Detects image brightness and automatically adjusts for natural brightness.
Back Light		Darkens the screen	Brightens the screen. (lights up)	Adjust to taste. (for maximum visibility)
Reset		(off the function)	(waiting to reset)	restored by pressing the OK button.
YNR		Off ↔ Low ↔ High		Performs picture signal noise reduction. Turn up to reduce noise.
CNR				
Film Mode		Off ↔ On		On: Automatically detects the movie film material and faithfully reproduces the original film image. Off: Set to OFF when switching between images does not appear natural.
PAL Comb Filter		Off ↔ On		This is available only when receiving a PAL composite signal. Turn On to reduce the discolorations in fine picture detail and provides purer colour.
LTI		Off ↔ Low ↔ Middle ↔ High		Adjusts the sharpness of the picture signal
CTI				Adjusts the sharpness of the colour signal
Black Enhancement				Adjusts the black level compensation.
Auto Colour		Off ↔ On		This is available only when receiving an NTSC composite/S.Video signal. This monitors and adjusts the colour to maintain constant colour levels. It also maintains natural flesh tones while preserving fidelity of background colours.
Colour Temp. Adjustment		Off ↔ On		Turn On when you wish to change colour temperature depending on the user's preference.
Amplitude	Red	Brighter scene is decreased in reddish colour.	Brighter scene is increased in reddish colour.	Adjust colour temperature depending on the user's preference. These settings are independently stored in each of the 4 Colour Temperature modes.
	Green	Brighter scene is decreased in greenish colour.	Brighter scene is increased in greenish colour.	
	Blue	Brighter scene is decreased in bluish colour.	Brighter scene is increased in bluish colour.	
Cut Off	Red	Dark scene is decreased in reddish colour.	Dark scene is increased in reddish colour.	
	Green	Dark scene is decreased in greenish colour.	Dark scene is increased in greenish colour.	
	Blue	Dark scene is decreased in bluish colour.	Dark scene is increased in bluish colour.	

Selected characters	◀	▶	Setup hint
Colour Management	Off ← → On		Turn On when the original balance of each colour is required to adjust depending on the user's preference.
Magenta	Magenta is weakened.	Magenta is strengthened.	This adjusts listed colours individually to make them either deeper or more pure. These settings are independently stored in each of the 4 Colour Temperature modes.
Red	Red is weakened.	Red is strengthened.	
Yellow	Yellow is weakened.	Yellow is strengthened.	
Green	Green is weakened.	Green is strengthened.	
Cyan	Cyan is weakened.	Cyan is strengthened.	
Blue	Blue is weakened.	Blue is strengthened.	
Colour Decoding	RGB ↔ R ↔ G ↔ B		Select the single colour screen when that is required to adjust R/G/B level individually depending on the user's preference. And set it back to RGB mode that indicates all colour after adjusting. Press the OK button every time the setting is changed.
Red	Darkens red only.	Lightens red only.	This adjusts R/G/B level or tint to make the colour appear natural for the user's preference. These settings are independently stored in each of the 4 Colour Temperature modes.
Green	Darkens green only.	Lightens green only.	
Colour	Darkens colours.	Lightens colours.	
Hue	Enhances red and weakens green.	Enhances green and weakens red.	

FUNCTION MENU

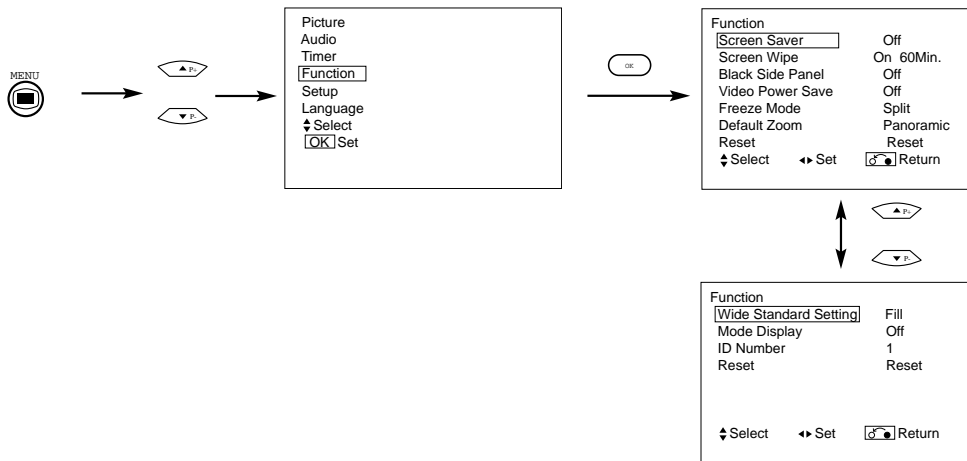

Selected characters	◀	▶	Setup hint
Video Power Save	Off ← → On		This is used to reduce power consumption for video input when there is no video signal. Setting it On will leads the monitor to the standby mode when the AV input with no signal is selected.
Default Zoom	Panoramic ↔ 4:3 14:9 Zoom		This selects the screen display size that appears first when the power turned on.

OPERATING INSTRUCTIONS (continued)

SETUP MENU

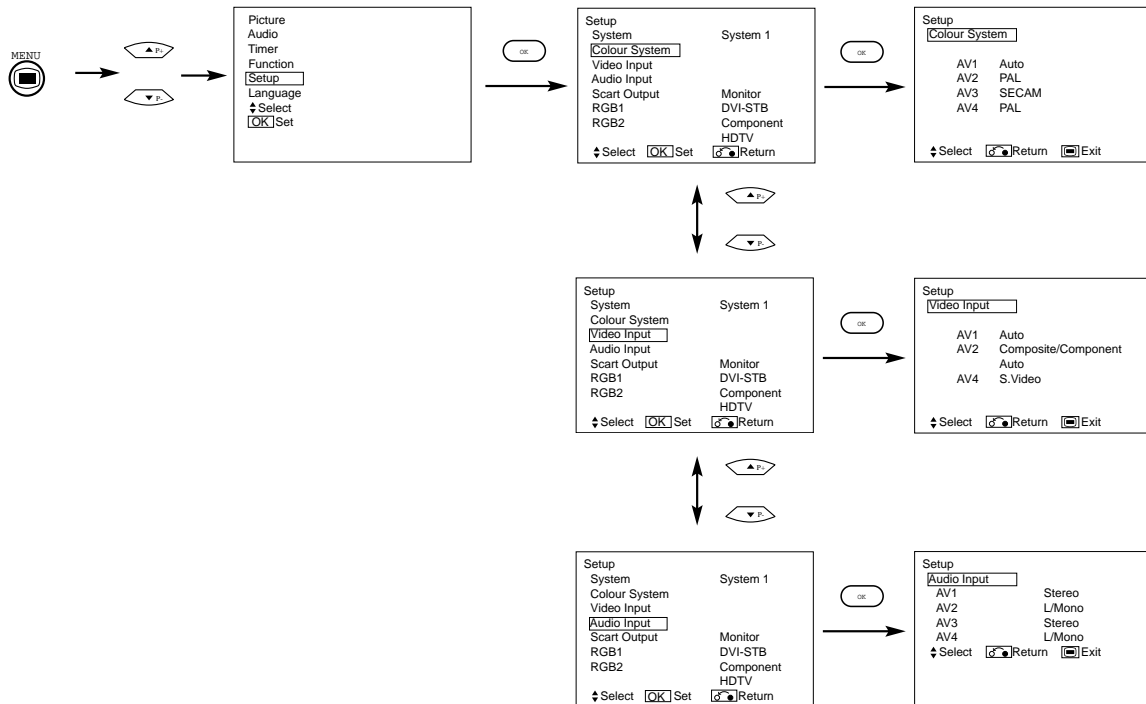

ENGLISH

Selected characters	◀ ▶	Setup hint
System	System1 ↔ System2	Do not change the original setting. (System1 : Europe/Asia, System2 : North America)
Colour System		
AV1	Auto ↔ PAL ↔ SECAM NTSC3.58 ↔ NTSC4.43	This should correspond to the colour system of the signal from the equipment that is connected to AV1 video input terminal. • Normally, set this to Auto. The system of the input signal will be automatically recognized. • If the input signal contains much noise or has a low level at Auto and the operation is found erratic, set this to match the input signal. • When the component signal is received, this would be not available (grayed out).
AV2		(Same to AV1)
AV3		
AV4		
Video Input		
AV1	Auto ↔ HDTV ↔ SDTV/DVD	This should correspond to the signal mode of the signal from the equipment that is connected to AV1 video input terminal. • Normally, set this to Auto. The signal mode of the input signal will be automatically recognized. • If the input signal contains much noise or has a low level at Auto and the operation is found erratic, set this to match the input signal.
AV2 (1st step)	RGB ↔ Composite/Component	This should correspond to the signal mode of the signal from the equipment that is connected to AV2 video input terminal.
AV2 (2nd step)	Auto ↔ HDTV ↔ SDTV/DVD	This step should be set only when [Composite/Component] is selected on the 1st step. And the procedure is same to AV1.
AV4	S.Video ↔ Composite	• If the signal from the equipment that is connected to AV4 Scart input terminal is S.Video or Composite, set this to correspond to that signal. • If the signal is RGB, it will be automatically recognized and this setting will have no effect.

Selected characters	◀ ▶	Setup hint
Audio Input		
AV1	→ Stereo ↔ L/Mono ←	This should correspond to the audio signal from the equipment that is connected to AV1 audio input terminal. If it is monaural audio, set this to L/Mono.
AV2		(Same as AV1)
AV3		
AV4		
Scart Output	→ TV ↔ Monitor ←	TV:AV4 (Scart) output will be fixed as TV signal output. Monitor:AV4 (Scart) output can view the image as on the main unit. But it is possible to monitor only the composite video signal from AV1, AV2, or AV3 input that is displayed on the screen at the time. • If Descrambler is set to On, it will be fixed as TV automatically.
RGB1	→ DVI-PC ↔ DVI-STB ←	This should correspond to the signal mode of the signal from the equipment that is connected to RGB1 DVI terminal.
RGB2 (1st step)	→ RGB ↔ Component ←	This should correspond to the signal mode of the signal from the equipment that is connected to RGB2 D-sub terminal.
RGB2 (2nd step)	→ Auto ↔ HDTV ↔ SDTV/DVD ←	This step should be set only when [Component] is selected on the 1st step. This should correspond to the signal mode of the signal from the equipment that is connected to RGB2 D-sub terminal. • Normally, set this to Auto. The signal mode of the input signal will be automatically recognized. • If the input signal contains much noise or has a low level at Auto and the operation is found erratic, set this to match the input signal.

OTHER FEATURES

Automatic Store

Approximately 1 sec. after adjustment is completed, the adjustments will be recorded as shown in the table below.

Menu	Display	Registration condition	
Picture	Picture Mode	1 setting is registered.	
	Contrast	For every input function and every Picture Mode, 1 setting is registered.	
	Brightness		
	Colour		
	Sharpness		
	Hue		
	Colour Temperature		
	Contrast Mode		
	Back Light		
	YNR		
	CNR		
	Film Mode		
	PAL Comb Filter		
	LTI		
	CTI		
	Black Enhancement		
	Auto Colour		
	Colour Temp. Adjust		
	R Amplitude		For every Colour Temperature, 1 setting is registered.
	G Amplitude		
B Amplitude			
R Cut Off			
G Cut Off	For every input function and every Picture Mode, 1 setting is registered.		
B Cut Off			
Colour Management			
Magenta	1 setting is registered.		
Red			

Menu	Display	Registration condition
Picture	Yellow	1 setting is registered.
	Green	
	Cyan	
	Blue	
	Colour Decoding	-
	Red	For every Colour Temperature, 1 setting is registered.
	Green	
	Colour	For every input function and every Picture Mode, 1 setting is registered.
Hue		
Function	Video Power Save	1 setting is registered.
	Default Zoom	
Setup	System	1 setting is registered.
	Colour System	1 setting is registered.
	AV1	
	AV2	
	AV3	
	AV4	
	Video Input	-
	AV1	1 setting is registered.
	AV2	
	AV3	
	AV4	
	Audio Input	-
	AV1	1 setting is registered.
	AV2	
AV3		
AV4		
RGB1		
RGB2		

• The previously recorded items will be lost.

TROUBLESHOOTING

Symptoms That Seemingly Appear to be Failures

Make the checks suggested below depending on the symptoms observed. If the symptoms remain uncorrected, contact your dealer.

 WARNING Customer servicing can be hazardous.
--

ENGLISH

Symptom	Point to check	See page
<ul style="list-style-type: none"> The screen becomes dark and the images cannot be seen during VCR special playback (fast forward, rewind). 	<ul style="list-style-type: none"> This sometimes occurs when a component output VCR such as the 480i is connected. This is not a malfunction; therefore, please take note that this may occur. When it does occur, change to composite output, or S.video output. 	-

Tuner Unit function

[Buttons for TELETEXT Mode]

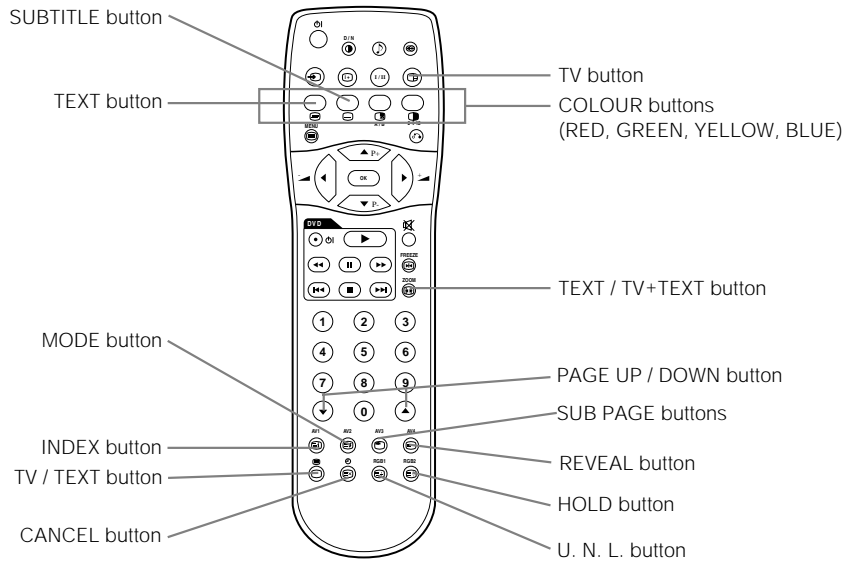

TELETEXT FUNCTION

Buttons on Remote Control	Function
TEXT	Press this to use the TELETEXT services.
TV	Press this to return to the TV mode when in the TELETEXT mode.
TV / TEXT	This switches the receiver between the TV mode and the TELETEXT mode.
TEXT / TV + TEXT	In TELETEXT mode, this button switches between TV+TEXT screen (split) and TELETEXT only.
MODE	This selects the FASTEXT and FAVOURITE modes.
INDEX	This selects the P100 page.
SUB PAGE	This allows receiving of a sub page. When the button is pressed, "S****" will be displayed at the top left of the screen.
SUB TITLE	Use this to access a subtitle service directly rather than through a TELETEXT service (subject to subtitle service broadcasting).
CANCEL	This allows the screen to return to the TV mode temporarily while searching for a required text page. When the required text page has been received, the page number will be displayed at the top left of the screen. Press the CANCEL button again to display the TELETEXT screen.
RED GREEN YELLOW BLUE	Each of these buttons selects a link page displayed at the lower part of the screen. A FAVOURITE page can also be stored in the memory using one of the colours. It can then retrieve the page stored by pressing the appropriate colour button. To store a FAVOURITE page : <ul style="list-style-type: none"> • press the MODE button ; • press a colour button for the FAVOURITE page ; • enter the FAVOURITE page number to be stored and press the same colour button again to confirm.
U. N. L	Each time this button is pressed, the screen display mode changes through the following. <div style="border: 1px solid black; padding: 5px; width: fit-content; margin: 5px auto;"> <p style="text-align: center;">normal state → upper half screen enlarged</p> <p style="text-align: center;">↑ lower half screen enlarged ←</p> </div>
HOLD	This holds the page currently being displayed on the screen. Instead of the page number, a " " indicator appears at the top of the screen. Press this button again to release the hold state.
REVEAL	This allows hidden information (found on some teletext pages) to be displayed on the screen.
PAGE UP / DOWN	These buttons increase / decrease the TELETEXT page number.

NOTE

- Certain pages do not show linked pages at the bottom of the screen. To display linked pages, press the INDEX button.

INSTALLATION INSTRUCTIONS

Connecting Antenna

Make sure that the power switch of the monitor is turned off.

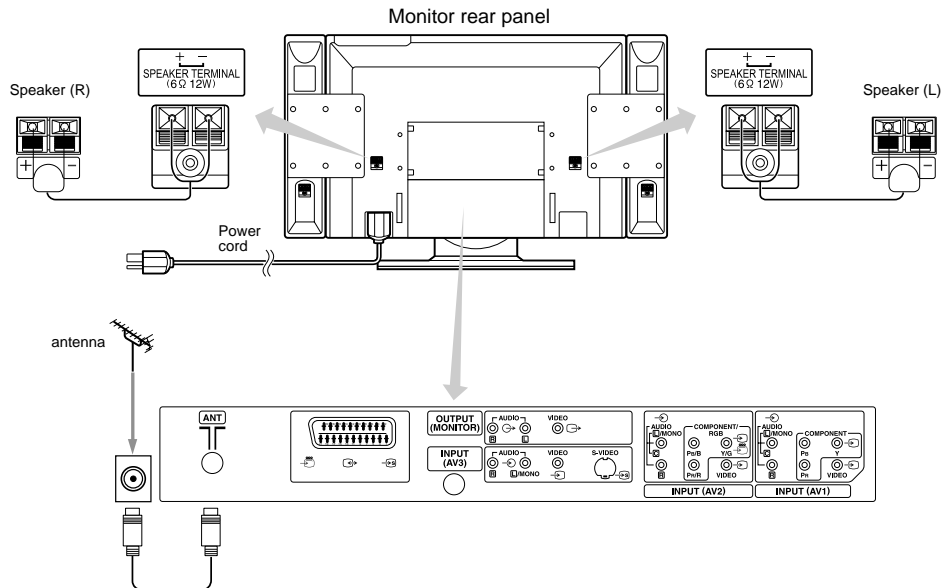

Precautions when connecting the antenna

- Please use a coaxial cable which is free from interference to connect the antenna. Avoid using a parallel flat feeder wire as interference may occur, causing reception to be unstable and stripe noise to appear on the screen.
- Avoid using indoor antenna as this may be affected by interference. Please use CATV net or outdoor antenna.
- Keep the power cord as far away from the antenna wire as possible.

If there are noise appearance in the picture of VHF-Low band channel, please use the double-shielded cable (not provided) for RF LEADS to reduce the noise.

OPERATING INSTRUCTIONS

The functions of the buttons located on the bottom of the monitor change as shown below:

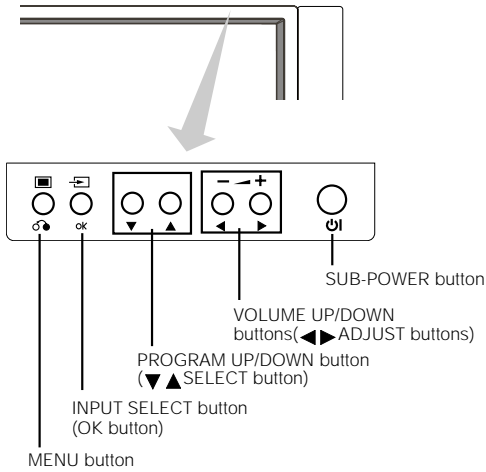

- () indicates the function while the MENU is displayed on the screen.

Input Switching

- **Input can be switched by pressing the AV1, AV2, AV3, AV4, RGB1 or RGB2 buttons of the remote control. And the way to return to a TV channel is as follows:**
 - Pressing INPUT SELECT button at RGB2 input screen.
 - Pressing some PROGRAM SELECT buttons and select a TV channel.
 - Pressing PROGRAM UP/DOWN buttons at the screen without OSD(On-screen display).
- **Input can be switched in the sequence of TV → AV1 → AV2 → AV3 → AV2 → AV3 → AV4 → RGB1 → RGB2 by pressing the INPUT SELECT button of the monitor or the remote control.**

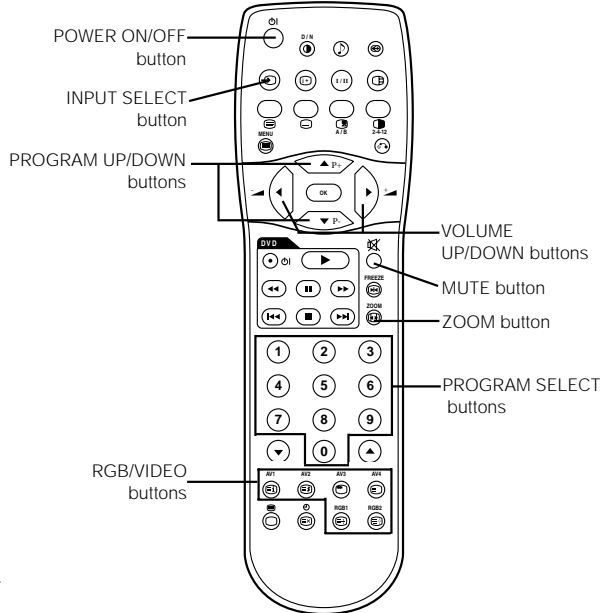
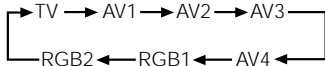

Size Switching

Each time the ZOOM button of the remote control is pressed, the screen display size will change in sequence and the status will be displayed at the bottom of the screen.

- During TV mode

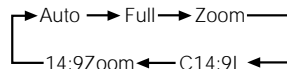

- [Auto] is the mode using WSS (Wide Screen Signals) which identify the picture format movies and programs are broadcast in. Various broadcast stations now transmit WSS. It can be detected and the monitor automatically switch to the correct format. However, some broadcasters do not transmit WSS, so this monitor will not recognize which format is being transmitted. Therefore, Default Zoom setting in the Function Menu is used to choose when a WSS has not been sent or has not been detected.

OPERATING INSTRUCTIONS (continued)

ENGLISH

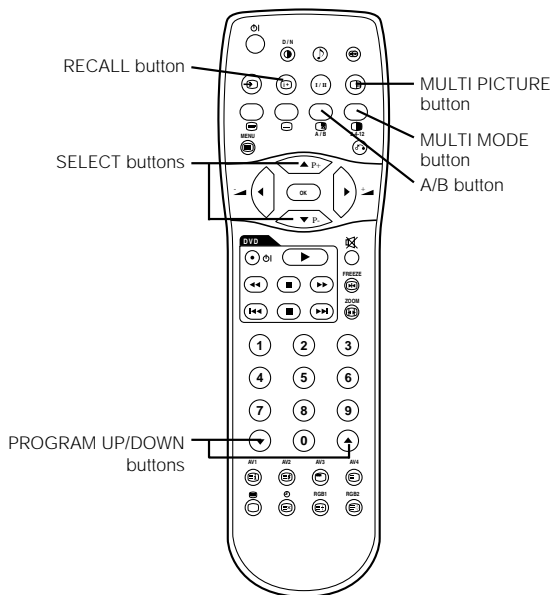

Displaying MULTI PICTURE

If the MULTI PICTURE button on the remote control is pressed, multi pictures will display. And then three types of the screen can be selected by pressing the MULTI MODE button on the remote control. The multi picture mode will change in the following sequence each time the MULTI MODE button is pressed.

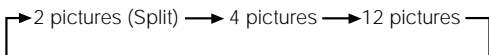

Activating the Split mode from the TV screen

Pressing the MULTI PICTURE button one time will display 2 pictures.

- The speaker icon can be shifted left and right by pressing the A/B button; the audio will be output from the side on which the speaker icon is located.
- The same signal input cannot be selected for both screens at the same time.
- The TV channel can be changed by pressing the ▲ and ▼ PROGRAM UP/DOWN buttons on the remote control.
- The signal input mode of picture-A or picture-B (the one that the speaker icon is located on) can be selected by pressing INPUT SELECT button on the remote control.
- Pressing the MULTI PICTURE button once again will cancel the multi picture mode.
- When the Video input is set to RGB Video, multi picture mode is not possible.
- Refer to the table for 2 pictures (Split) mode. [42](#)

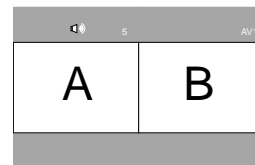

Activating the 4 pictures mode from the TV screen

Pressing the MULTI MODE button one time at the 2 pictures mode will display 4 pictures.

- Press [A/B] button to select picture A or picture B indicated by a red triangle. For pictures on right, press ▲ ▼ SELECT buttons to select picture. The selected channel number would change green.
- The TV channel can be changed by pressing the ▲ and ▼ PROGRAM UP/DOWN buttons on the remote control.
- The audio can only be output from picture A in 4 pictures mode.
- The same signal input mode cannot be selected for each screens at the same time.
- Pressing the MULTI PICTURE button at the 4 picture mode will cancel the multi picture mode. And then, pressing the MULTI PICTURE button again will display the 4 pictures.
- Refer to the table for 4 pictures mode. [42](#)

A	AV1	B1	8
		B2	6
		B3	11

Activating the 12 pictures mode from the TV screen

Pressing the MULTI MODE button one time at the 4 pictures mode will display 12 pictures.

- Starting from channel 1, preset channels will automatically display in sequence on the 12 windows.
- This function activates only in TV mode.
- After several seconds, it refreshes the picture one by one.
- Pressing the MULTI PICTURE button at the 12 picture mode will cancel the multi picture mode. And then, pressing the MULTI PICTURE button again will display the 12 pictures again.
- Pressing the MULTI MODE button at the 12 picture mode will display the 2 pictures (Split) mode.

1	2	3	4
5	6	7	8
9	10	11	12

NOTE

- Even if the input of the horizontal / vertical synchronizing signal (or video signal) stops in the multi picture display, the mode will not change to power save mode.
- Please be careful since image retention will occur if display is left in a multi picture display state for a long period of time.

2 Pictures (Split)

Input terminal			AV1-AV4				AV1, AV2			RGB1	RGB2	TELE TEXT
	Main	Sub	PAL SECAM	NTSC3.58 NTSC4.43	576i 576p	480i 480p	1080i/50	1080i/60	720p/60	STB	Component	
AV1 ~AV4		PAL, SECAM	○	○	○	○	○	○	○			○
		NTSC3.58/4.43	○	○	○	○	○	○	○			
AV1 AV2		576i, 576p	○	○								
		480i, 480p	○	○								
		1080i/50	○	○								
		1080i/60	○	○								
		720p/60	○	○								
RGB1		STB										
RGB2		Component	○	○	○	○	○	○				

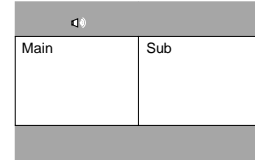

(○ : Available)

4 Pictures

Input terminal			AV1-AV4				AV1, AV2			RGB1	RGB2	TELE TEXT
	Main	Sub	PAL SECAM	NTSC3.58 NTSC4.43	576i 576p	480i 480p	1080i/50	1080i/60	720p/60	STB	Component	
AV1 ~AV4		PAL, SECAM	○	○								
		NTSC3.58/4.43	○	○								
AV1 AV2		576i, 576p	○	○								
		480i, 480p	○	○								
		1080i/50	○	○								
		1080i/60	○	○								
		720p/60	○	○								
RGB1		STB										
RGB2		Component	○	○								

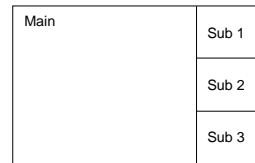

(○ : Available)

Input Signal Screen Display

The TV channel status can be displayed on the screen by pressing the **RECALL** button of the remote control.

- The display will go out in approximately 6 seconds.

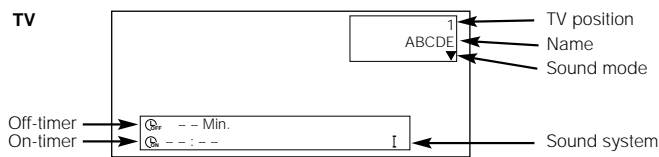

OPERATING INSTRUCTIONS (continued)

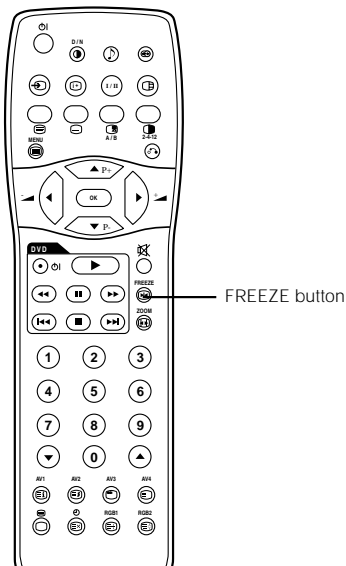

Picture Freezing

When the FREEZE button on the remote control is pressed, the screen transfers into the freeze mode.

- There are two types of freezing screen mode, Split and Strobe. These are possible to select at the "Freeze Mode" setting of the Function Menu.
- The Split mode will display 2 pictures from the same source on the screen with one active picture and the other still.
- The Strobe mode will display 12 pictures with the last picture active, while other 11 windows are still.
- Pressing the FREEZE button again changes the screen back to the normal picture.
- This function is also available from video input mode besides TV mode. Refer to the table for Freeze function as below:

	Split	Strobe
PAL, SECAM	○	○
NTSC3.58/4.43	○	○
576i	○	○
480i	○	○
576p	○	
480p	○	
1080i/50	○	
1080i/60	○	
720p/60	○	
RGB, DVI-PC		

(○ : Available)

[Split]

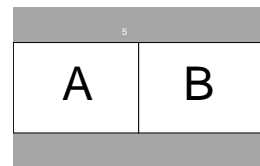

[Strobe]

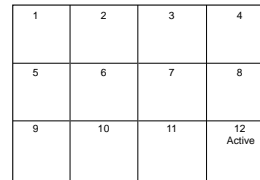

FUNCTION MENU

Refer to the page 34 . (It is same to the Picture Menu of Video Unit Functin) But 1 item is added and 5 items are deleted.

Selected characters	Navigation	Setup hint
Freeze Mode	← Split ↔ Strobe →	This selects the display condition of the FREEZE mode between Split (2 pictures) and Strobe (12 pictures).
Default Zoom	← Panoramic ↔ 4:3 →	This selects the screen display size that appears first when the power turned on.
Mode Display		Not Available (grayed out)
ID Number		Not Available (grayed out)

SETUP MENU

[During TV mode]

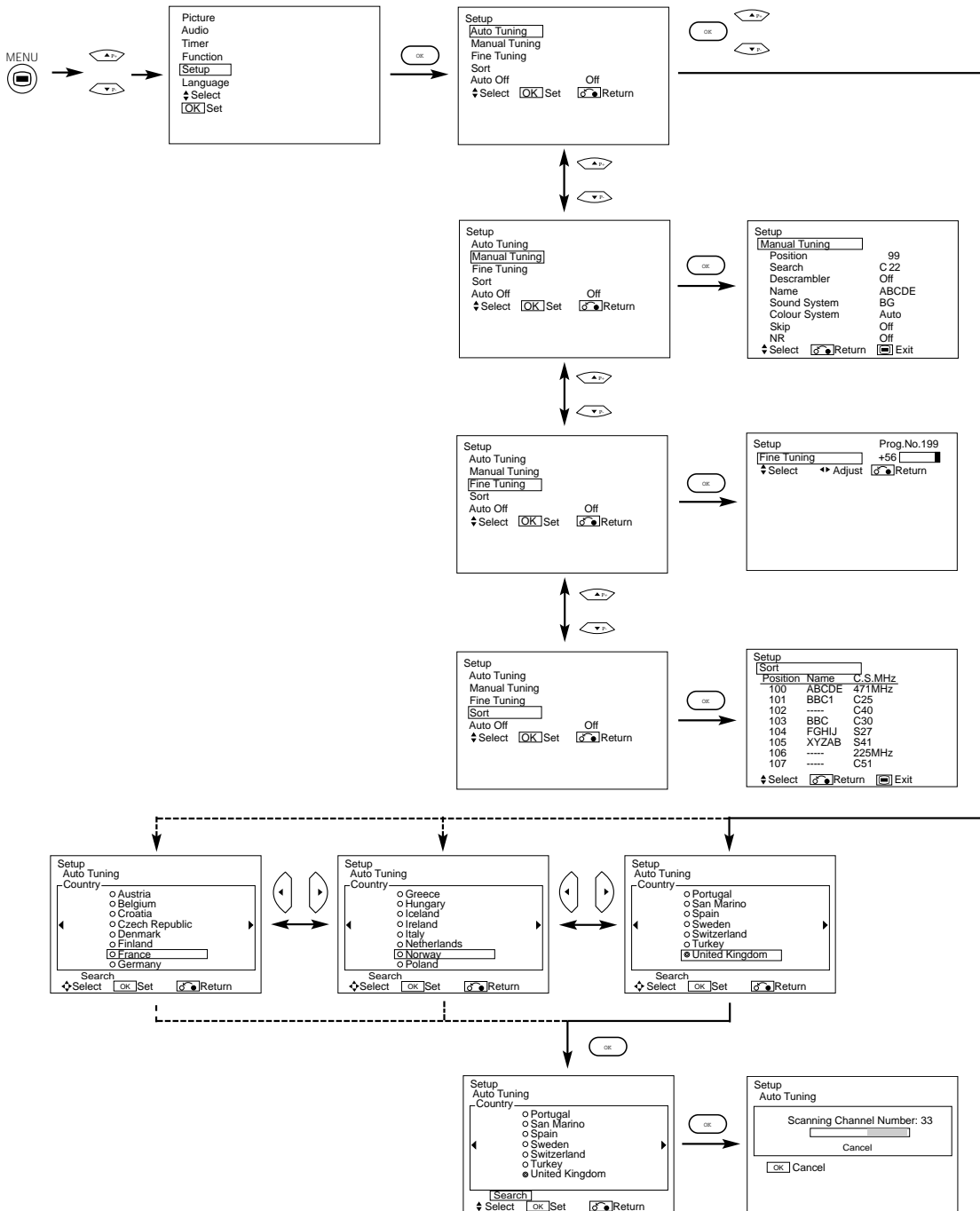

OPERATING INSTRUCTIONS (continued)

SETUP MENU (continued)

ENGLISH

Selected characters	◀	▶	Setup hint
Auto Tuning			
Country	▶ (Page1) ◀◀ (Page2) ◀◀◀ (Page3) ◀◀◀		Select the country name by ▼▲ SELECT buttons and press OK button. • If some required stations could not be preset in this auto tuning function, select and preset the required station in the required position by the manual tuning operation.
Search	-	-	Press the OK button and it starts the auto tuning.
Manual Tuning			
Position	▶ 1 ◀◀ 2 ◀◀◀ 3.....199 ◀◀◀◀ AV00 ◀◀◀◀		Set the position number. This also can be set by ⏪⏩ PROGRAM UP/DOWN buttons.
Search	-	-	At first, select the channel entry method, entering a two digit channel number(CH), entering a two digit S-band number or entering a three digit frequency(MHz), by pressing the OK button.
(C--)	-	-	Enter two digit number by pressing 0-9 NUMBER buttons. If the number is normal, then it starts the channel search.
(S--)	-	-	Enter two digit number by pressing 0-9 NUMBER buttons. If the number is normal, then it starts the channel search.
(--MHz)	-	-	Enter three digit number by pressing 0-9 NUMBER buttons. If the number is normal, then it starts the channel search.
Descrambler	▶ Off ◀◀ On ◀◀		Set this to Off normally. If it is set to On, AV4 (Scart) terminal operates as TV signal output, and the screen changes to display AV4 (Scart) input signal automatically.
Name	◻◻◻◻◻◻◻◻◻◻ (◻:a letter)		This is used to input the name of the TV station within 5 letters. After fixing the cursor on the first digit, select a letter by ▼▲ SELECT buttons and move to next digit by ▶ ADJUST button. Press the OK button again after finished. • Selectable letters are "0"~"9", "A"~"Z", "+", "-", " " (blank), ",", (comma) and "." (period).
Sound System	▶ BG ◀◀ I ◀◀◀ DK ◀◀◀◀ L' ◀◀ L ◀◀		Select the sound system through the 5 different settings.
Colour System	▶ Auto ◀◀ PAL ◀◀◀ SECAM ◀◀◀◀ NTSC3.58 ◀◀◀ NTSC4.43 ◀◀◀		Select the colour system through the 5 different settings.
Skip	▶ Off ◀◀ On ◀◀		If this is set to On, that position will be skipped while selecting positions by PROGRAM UP/DOWN buttons. This is automatically set to On for those non-broadcasting channels.
NR	▶ Off ◀◀ On ◀◀		If this is set to On, it helps to reduce the noise interference visible on the screen, especially in the weaker signal reception areas.
Fine Tuning	Decreasing the frequency data for the main tuner	Increasing the frequency data for the main tuner.	After completing the fine-tuning, press the RETURN button to exit this mode. • The variable range is -56 ~ +56.
Sort			
(A Line of position List)	-	-	Press OK button at the a line that is required to change order, then the characters will change to green. And move it up or down in the list by pressing ▼▲ SELECT buttons. And press OK button to complete it. Press the RETURN button to exit.
Auto Off	▶ Off ◀◀ On ◀◀		If this is set to On, the power will be turned off when there is no transmission signal and no operation for about 10 minutes in the TV mode.

[During VIDEO signal input]

1 item is added to the Menu shown in the page 35 .

Selected characters	◀	▶	Setup hint
Scart Output	▶ TV ◀◀ Monitor ◀◀		TV:AV4 (Scart) output will be fixed as TV signal output. Monitor:AV4 (Scart) output can view the image as on the main unit. But it is possible to monitor only the composite video signal from AV1, AV2, or AV3 input that is displayed on the screen at the time. • If Descrambler is set to On, it will be fixed as TV automatically.

OTHER FUNCTIONS

A2 / NICAM / Sound Multiplex

- The CH I / II button is only useful for NICAM and sound multiplex signals. Otherwise pressing this button will have no effect.

BILINGUAL / DUAL sound broadcast

When bilingual program is received, sound mode display appears in yellow as shown on right.

Press the CH I / II button to select the sound to be heard.

Each time the button is pressed, I, II or ▼ (force mono) appear cyclically on the screen.

When receiving NICAM signals, NICAM display will appear as below.

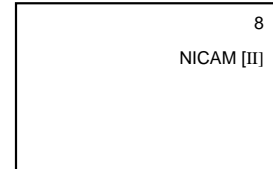

Sound multiplex signal received

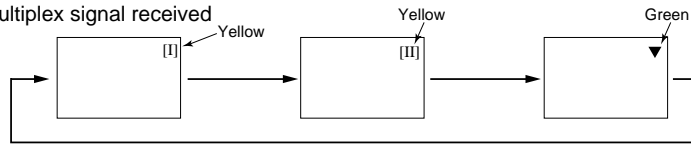

NICAM signal received

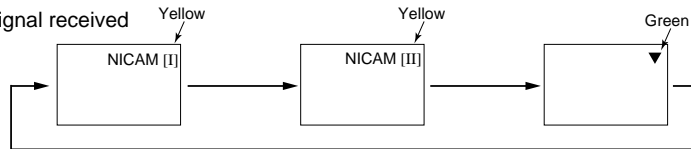

Select I, II or ▼ (force mono) to hear the CH I, CH II or MONO broadcast respectively.

STEREO sound broadcast

When a stereo program is received, sound mode display will appear in red, and you can press the CH I / II button to select between stereo and mono sound.

Each time the button is pressed, ○ or ▼ (force mono) appear cyclically on the screen.

When receiving NICAM signals, NICAM display will appear as below.



Sound multiplex signal received

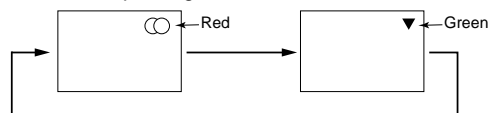

NICAM signal received

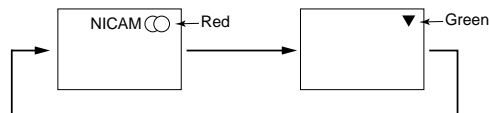

Select ○ or ▼ (force mono) to hear the STEREO or MONO broadcast respectively.

Monaural sound broadcast

When a monaural program is received, sound mode display will appear in green.

You can press the CH I / II button to select the sound mode between monaural and forced mono (sound is same).

Each time the button is pressed, ▽ or ▼ (force mono) appear cyclically on the screen.



NOTE

- If sound signal is not strong enough for quality reception, press the CH I / II button until ▼ appears on the screen to receive a clear mono sound.
- If sound has hiss noise or keep switching between stereo and mono mode due to signal condition, press the CH I / II button until ▼ appears on the screen to receive a clear mono sound.

OPERATING INSTRUCTIONS (continued)

OTHER FUNCTIONS (continued)

ENGLISH

DVD Player Selection

- You can use this remote control to operate the selected brand of DVD player by pressing the following buttons on the remote control simultaneously.

Brands of DVD Player	Press	Brands of DVD Player	Press
Hitachi	RECALL ①	RCA	RECALL ⑨
Pioneer	RECALL ②	Mitsubishi	RECALL ⑩
Panasonic	RECALL ③	Onkyo	RECALL INDEX
Toshiba	RECALL ④	Zenith	RECALL MODE
Philips	RECALL ⑤	Orion	RECALL SUB PAGE
JVC	RECALL ⑥	Shinco	RECALL CANCEL
Samsung	RECALL ⑦	Skyworth	RECALL REVEAL
Sony	RECALL ⑧	Bubuko	RECALL TV/TEXT

Example

To operate HITACHI DVD player, press and hold the **RECALL** button, followed by the ① button.

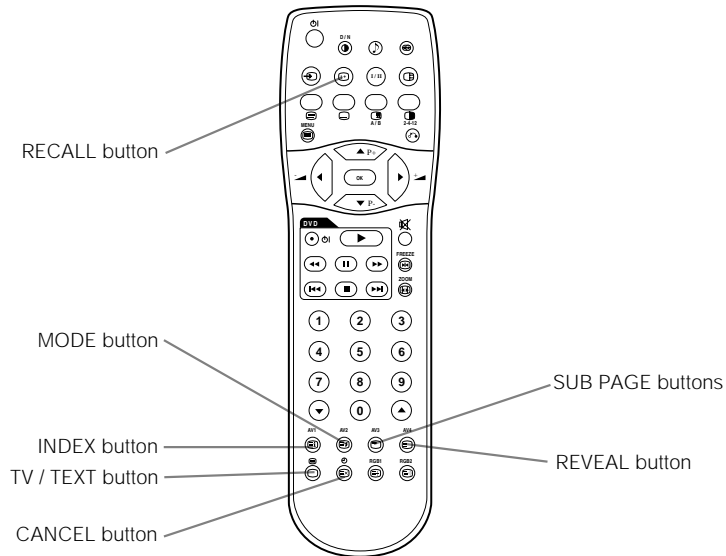

NOTE

- Not all models of the listed brands can be operated using this remote control.



TROUBLESHOOTING

Symptoms That Seemingly Appear to be Failures

Make the checks suggested below depending on the symptoms observed. If the symptoms remain uncorrected, contact your dealer.



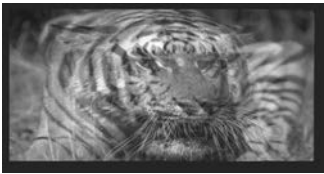
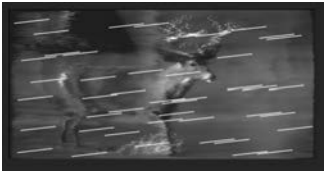

WARNING
Customer servicing can be hazardous.

Symptom	Possible reason	Remedy
 snowy picture - poor sound	(1) Connection of antenna cable to the TV is poor. (2) Corroded or poor antenna connections. (3) Antenna has moved position. (4) Adverse weather conditions. (5) Transmitter problems.	(1) Make new connection and/or change antenna plug. (2) Make new connections or renew cable. (3) Re-align antenna. (4) None. (5) Check with local Operator.
 multiple images - sound O.K	(1) Antenna has moved position. (2) TV not tuned correctly. (3) Adverse weather conditions. (4) Transmitter problems. (5) AV Input not set correctly.	(1) Re-align antenna. (2) Re-tune or fine tune TV. (3) None. (4) Check with local Operator. (5) Check the external equipment connected.
 intermittent interference	(1) Interference from electrical or mechanical motors, fluorescent lights, portable radios etc.	(1) Check devices for shielding and renew if necessary or move further from TV.
 no picture or sound	(1) TV may be in AV mode. (2) Picture/sound setting set to minimum. (3) TV in standby or power save mode.	(1) Press the INPUT SELECT button or (0) to (9) buttons on your remote control to return to normal TV mode. (2) Check picture / sound controls (go to MAIN MENU). (3) Press POWER ON / OFF button.

PRODUCT SPECIFICATIONS

ENGLISH

Panel	Display dimensions	Approx. 28 inches (599.04 (H) x 359.42 (V)
	Resolution	1280 (H) x 768 (V) pixels
Net dimensions		854 (W) x 516 (H) x 277 (D) mm
Net weight		21.9 kg
Ambient conditions	Temperature	Operating : 5°C to 35°C, Storage : -15°C to 60°C
	Relative humidity	Operating : 20% to 80%, Storage : 20% to 90% (non-condensing)
Power supply		AC100 - 240V, 50/60Hz
Power consumption/at standby		155W / <1W
Audio output		12W + 12W (6Ω)
(RGB input)		
Input signals	Input terminals	RGB1 DVI input terminal (DVI-D) RGB1 audio input terminal (3.5mm Stereo Mini Jack) RGB2 analog RGB input terminal (D-sub 15-pin) RGB2 audio input terminal (3.5mm Stereo Mini Jack)
	Video signals	0.7 V/1.0 Vp-p, analog RGB (Recommended Signal) 480i, 576i, 480p, 576p, 1080i/50, 1080i/60, 720p/60
	Sync signals	H/V separate, TTL level [2KΩ] H/V composite, TTL level [2KΩ] Sync on green, 0.3 Vp-p [75Ω]
Recommended signal		48 modes 
(Video input)		
Input signals	Input terminals	AV1: composite video input terminal (RCA) AV1: Y PB PR video input terminal (RCA) AV1: L/R audio input terminal (RCA) AV2: composite video input terminal (RCA) AV2: Y/G PB/B PR/R video input terminal (RCA) AV2: L/R audio input terminal (RCA) AV3: composite video input terminal (RCA) AV3: S video input terminal (RCA) AV3: L/R audio input terminal (RCA) AV4: composite video / S video / RGB / L/R audio input terminal (Scart)
	Video signals	AV1: PAL, SECAM, NTSC3.58, NTSC4.43 AV1: 480i, 576i, 480p, 576p, 1080i/50, 1080i/60, 720p/60 AV2: PAL, SECAM, NTSC3.58, NTSC4.43 AV2: 480i, 576i, 480p, 576p, 1080i/50, 1080i/60, 720p/60, RGB AV3: PAL, SECAM, NTSC3.58, NTSC4.43 AV4: PAL, SECAM, NTSC3.58, NTSC4.43 AV4: RGB
Video output Signal		OUTPUT (MONITOR): composite video monitor-output terminal (RCA) OUTPUT (MONITOR): L/R audio monitor- output terminal (RCA) AV4: composite video / L/R audio output terminal (SCART)
Recommended signal		15 modes 
(RF input)		
Input signals	Input terminals	ANT : 75Ω Unbalanced
	RF Video System	PAL B, G, H / I / D, K SECAM B, G / D, K / K1 / L, L'

- The monitor takes at least 30 minutes to attain the status of optimal picture quality.

Signal Input

DVI terminal (DVI-D)

Pin	Input signal	Pin	Input signal
1	T.M.D.S. Data2-	14	+5V Power
2	T.M.D.S. Data2+	15	Ground (for+5V)
3	T.M.D.S. Data2/4 Shield	16	Hot Plug Detect
4	T.M.D.S. Data4-	17	T.M.D.S. Data0-
5	T.M.D.S. Data4+	18	T.M.D.S. Data0+
6	DDC Clock	19	T.M.D.S. Data0/5 Shield
7	DDC Data	20	T.M.D.S. Data5-
8	No Connect	21	T.M.D.S. Data5+
9	T.M.D.S. Data1-	22	T.M.D.S. Clock Shield
10	T.M.D.S. Data1+	23	T.M.D.S. Clock+
11	T.M.D.S. Data1/3 Shield	24	T.M.D.S. Clock-
12	T.M.D.S. Data3-	Frame	GND
13	T.M.D.S. Data3+		

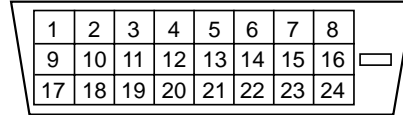

RGB terminal (D-sub 15-pin connector)

Pin	Input signal
1	R (Pr/Cr)
2	G or sync on green (Y)
3	B (Pb/Cb)
4	No connection
5	No connection
6	R.GND (Pr/Cr, GND)
7	G.GND (Y, GND)
8	B.GND (Pb/Cb, GND)
9	No connection
10	GND
11	No connection
12	[SDA]
13	H. sync or H/V composite sync
14	V.sync. [V.CLK]
15	[SCL]

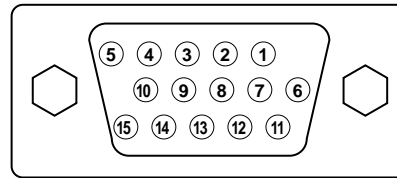

- When different kinds of input signals are simultaneously input to the monitor via a graphics board or the like, the monitor will automatically select the signals in the following priority order:

Sync signal type	Priority
H/V separate sync.	1
H/V composite sync.	2
sync.on Green *	3

*Even in the case of the recommended signals shown on the following page, there may be instances when correct display is not possible. In this case, use H/V separate sync, H/V composite sync.

() : With component input

S-input connector pin specifications

Pin	Input signal
1	Y
2	Y-GND
3	C
4	C-GND
Frame	GND

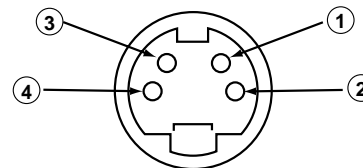

Scart connector pin specifications

Pin	Signal	Pin	Signal
1	AUDIO OUT (RIGHT)	12	Not Used
2	AUDIO IN (RIGHT)	13	RGB-R GND
3	AUDIO OUT (LEFT/MONO)	14	GND
4	AUDIO GND	15	RGB-R / S.VHS CHROMINANCE IN
5	RGB-B GND	16	BLANKING SIGNAL
6	AUDIO IN (LEFT/MONO)	17	COMPOSITE VIDEO GND
7	RGB-B IN	18	BLANKING SIGNAL GND
8	AUDIO/RGB SWITCH / 16:9	19	COMPOSITE VIDEO OUT
9	RGB-G GND	20	COMPOSITE VIDEO / S.VHS LUMINANCE IN
10	Not Used	21	GND / SHIELD (CHASSIS)
11	RGB-G IN		

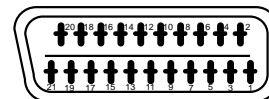

PRODUCT SPECIFICATIONS (continued)

Recommended Signal List

With Digital RGB signal input (RGB1) input

No.	Signal mode			Horizontal frequency (kHz)	Dot clock frequency (MHz)	Setup Menu Condition		Remarks
	Signal Name	Resolution	Vertical frequency (Hz)			DVI-PC	DVI-STB	
1	VGA	640 X 400	70.08	31.47	25.18	○		
2		640 X 480	59.94	31.47	25.18	○	○	
3	W-VGA	864 X 480	59.94	31.47	34.24	○		
4	W-XGA	1280 X 768	59.87	47.78	78.50	○		
5	VESA	640 X 480	72.81	37.86	31.50	○		
6		640 X 480	75.00	37.50	31.50	○		
7		640 X 480	85.01	43.27	36.00	○		
8		800 X 600	56.25	35.16	36.00	○		
9		800 X 600	60.32	37.88	40.00	○		
10		800 X 600	72.19	48.08	50.00	○		
11		800 X 600	75.00	46.88	49.50	○		
12		800 X 600	85.06	53.67	56.25	○		
13		1024 X 768	60.00	48.36	65.00	○		
14		1024 X 768	70.07	56.48	75.00	○		
15	1024 X 768	75.03	60.02	78.75	○			
16	480p	720 X 480	59.94	31.47	27.00		○	EIA-861
17	720p/60	1280 X 720	60.00	45.00	74.25		○	EIA-861
18	1080i/60	1920 X 1080	60.00	33.75	74.25		○	EIA-861

• Make sure that the signal of the equipment to be connected is compatible with the specifications of this list. (○ : acceptable)

With Analog RGB signal input (RGB2 input)

No.	Signal mode			Horizontal frequency (kHz)	Dot clock frequency (MHz)	Remarks
	Signal Name	Resolution	Vertical frequency (Hz)			
1	VGA	640 X 400	70.08	31.47	25.18	
2		640 X 480	59.94	31.47	25.18	
3	W-VGA	864 X 480	59.94	31.47	34.24	WVGA type:On
4	VESA	640 X 480	72.81	37.86	31.50	
5		640 X 480	75.00	37.50	31.50	
6		640 X 480	85.01	43.27	36.00	
7		800 X 600	56.25	35.16	36.00	
8		800 X 600	60.32	37.88	40.00	
9		800 X 600	72.19	48.08	50.00	
10		800 X 600	75.00	46.88	49.50	
11		800 X 600	85.06	53.67	56.25	
12		1024 X 768	60.00	48.36	65.00	
13		1024 X 768	70.07	56.48	75.00	
14		1024 X 768	75.03	60.02	78.75	
15		1024 X 768	85.00	68.68	94.50	
16		1152 X 864	75.00	67.50	108.00	
17		1280 X 1024	60.02	63.98	108.00	
18		1280 X 1024	75.03	79.98	135.00	
19		1280 X 1024	85.02	91.15	157.50	
20		1600 X 1200	60.00	75.00	162.00	
21		1600 X 1200	75.00	93.75	202.50	
22	1600 X 1200	85.00	106.25	229.50		

ENGLISH

23	Macintosh	640 X 480	66.67	35.00	30.24	
24		832 X 624	74.55	49.72	57.28	
25		1024 X 768	74.93	60.24	80.00	
26		1152 X 870	75.06	68.68	100.00	
27	W-XGA	1280 X 768	59.833	47.986	81.00	
28		1280 X 768	69.997	56.137	94.760	
29		1280 X 768	59.876	47.776	79.50	WXGMode:(1280x768)
30		1280 X 768	60.015	47.712	89.50	WXGMode:(1280x768)

- The type of video board or connecting cable used may not allow for correct displays adjustment of Horizontal Position, Vertical Position, Horizontal Clock and Clock Phase.
- The monitor may fail to display an animation image correctly when a signal having a vertical frequency of 85Hz or higher is input to it
- The monitor differentiates the signal modes according to the horizontal and vertical frequencies and the horizontal and vertical sync signal polarities. Note that different signals having all these elements alike may be handled as the same signal
- Displaying images with more than 768 lines of vertical resolution at Full diplay (compressed display) can result in the inter polation of stripes.

With Composite Input(AV1~AV4 input) and S-video Input (AV3 input).

No.	Signal mode			Horizontal frequency (kHz)	Dot clock frequency (MHz)	Remarks
	Signal Name	Resolution	Vertical frequency (Hz)			
1	NTSC4.43 NTSC3.58	525	59.94	15.73	—	
2	PAL SECAM	625	50.00	15.63	—	

With R, G, B Video input (AV2 and AV4 input).

No.	Signal mode			Horizontal frequency (kHz)	Dot clock frequency (MHz)	Remarks
	Signal Name	Resolution	Vertical frequency (Hz)			
1	NTSC4.43/3.58 PAL, SECAM	525 625	59.94 50.00	15.73 15.63	—	

With component input (AV1, AV2 and RGB2-component input).

No.	Signal mode			Horizontal frequency (kHz)	Dot clock frequency (MHz)	Remarks
	Signal Name	Resolution	Vertical frequency (Hz)			
1	576i	576	50.00	15.63	—	
2	480i	480	59.94	15.73	—	
3	576p	576	50.00	31.26	—	
4	480p	480	59.94	31.47	—	
5	1080i/50	1080	50.00	28.13	—	
6	1080i/60	1080	60.00	33.75	—	
7	720p/60	720	59.94	44.96	—	

- The monitor differentiates the signal modes according to the horizontal and vertical frequencies and the horizontal and vertical sync signal polarities. Note that different signals having all these elements alike may be handled as the same signal.
- Displaying images with more than 768 lines of vertical resolution at Full diplay (compressed display) can result in the interpolation of stripes.

Guarantee

Thank You for purchasing this Hitachi Television.

In the unlikely event that this product should develop a fault, we undertake to repair or replace any part of the product which fails due to a manufacturing defect within 12 months of the date of purchase provided that ...

1. the product has been installed and used only in accordance with the instructions supplied with the product.
2. the product has not been repaired, maintained, or modified by any person other than a Hitachi authorized dealer.
3. the product serial number has not been removed or altered.

- this guarantee does not apply to a product acquired second hand or for commercial or communal use.
- this guarantee does not cover the replacement of exhausted batteries, the adjustment of user controls, or aerial alignment.
- any parts replaced under this guarantee shall become the property of HITACHI EUROPE LTD..
- please note that evidence of the date of purchase will be required before any service under this guarantee is carried out.

Use the boxes provided below to record your TV's Model and Serial Number - these are found on the rating plate located on the rear of the LCD screen. Also, record where and when you purchased this T.V. This information will help any future queries you may have and should be used in all correspondence with Hitachi service centres.

MODEL	SERIAL NUMBER	DEALER/STORE	DATE PURCHASED

This guarantee does not affect your statutory rights.

In all cases of difficulty please consult your Hitachi dealer.

Free Manuals Download Website

<http://myh66.com>

<http://usermanuals.us>

<http://www.somanuals.com>

<http://www.4manuals.cc>

<http://www.manual-lib.com>

<http://www.404manual.com>

<http://www.luxmanual.com>

<http://aubethermostatmanual.com>

Golf course search by state

<http://golfingnear.com>

Email search by domain

<http://emailbydomain.com>

Auto manuals search

<http://auto.somanuals.com>

TV manuals search

<http://tv.somanuals.com>