

HITACHI

SERVICE MANUAL

SM008

28LD5200E
(PW1L)

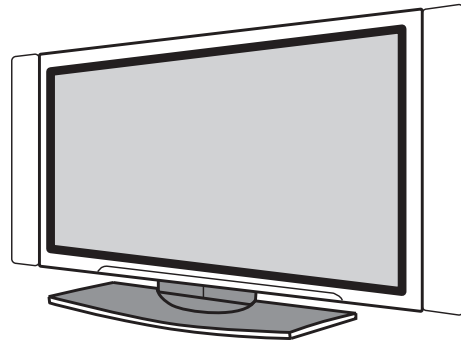

Caution

Be sure to read this manual before servicing. To assure safety from fire, electric shock, injury, harmful radiation and materials, various measures are provided in this HITACHI LCD monitor.

Be sure to read cautionary items described in the manual to maintain safety before servicing.

Service Warning

1. Since Panel Module is made of glass, handling the broken Module shall be taken care sufficiently in order not to be injured.
2. Replacing work shall be started after the Panel Module and the AC/DC Power supply become sufficiently cool.
3. Special care shall be taken to the display area in order not to damage its surface.
4. The Panel Module shall not be touched with bare hand to protect its surface from stains.
5. It is recommended to use clean soft gloves during the replacing work in order to protect not only the display area of the Panel Module but also a serviceman himself.

Contents

1. Features -----	3	7. Replacement parts list-----	23
2. Specifications-----	4	8. Block diagram -----	24
3. Component names-----	5	9. Connection diagram -----	26
4. Adjustment -----	6	10. Wiring diagram -----	27
5. Troubleshooting-----	19	11. Disassembly diagram-----	28
6. Self diagnosis function -----	22		

SPECIFICATIONS AND PARTS ARE SUBJECT TO CHANGE FOR IMPROVEMENT.

LCD Television



March 2004 Digital Media Division

CAUTION FOR SAFETY





Please read this page before repairing the monitor.







This page explains the following items to ensure the safety of set and prevent accidents during repair work.

- We explain by symbols what damage or injury may occur if errors are made.

 Warning	This symbol means "possible to cause death or serious injury"
 Caution	This symbol means "possible to cause damage or something may break"

- We symbols below have the following meanings.

	This symbol means " CAUTION "		This symbol means " MUST "
	This symbol means " POSSIBLE to ELECTRIC SHOCK "		This symbol means " DO NOT "

 WARNING	
<p>■ Should follow instructions.</p> <p> Indicates cabinet, chassis and parts by label, which need special attention. Please follow notes and Safety Instructions of User's Manual.</p>	<p>■ Should keep same style of wiring or component.</p> <p> Monitor uses tubes or tapes, which are insulators, and some components are kept a distance from surface of PWB for safety.</p> <p>Internal leads kept from hot part or high voltage part by clammer or styling, so please return to original condition to prevent electric shock or fire.</p>
<p>■ Prevent electric shock.</p> <p> Please take care during working because monitor has high voltage part and power supply part.</p> <p>Possible to die if you touch these places by mistake.</p> <p>Please disconnect power plug during overhaul, reassembly or changing parts. You could die or suffer from electric shock if you touch live part.</p>	<p>■ Should do safety check when finished.</p> <p> Every part (removed screws, component and wiring) should be returned to previous condition.</p> <p>Check around repair for possible damage by mistake and measure the insulated impedance by meg-ohm meter. Confirm the value of impedance, that value is more than 4M ohm. It could cause electric shock or fire if this value is less than 4M ohm.</p>
<p>■ Use recommended components.</p> <p> Please use same characteristic component, which is same as original for your safety and reliability. Especially those marked by \triangle in parts list and circuit diagram.</p> <p>It may cause electric shock or fire if you use non-recommended component.</p>	<p>■ Nobody can check and repair the code and combination circuit of HDCP.</p> <p> Never remove the shield case, which is attached to the code and combination circuit of HDCP.</p>

PRECAUTIONS

- **How to clean the LCD screen panel of the monitor**

Before cleaning the monitor, turn off the monitor and disconnect the power plug from the power outlet.

To prevent scratching or damaging the LCD screen face, do not knock or rub the surface with sharp or hard objects. Clean the screen with a soft cloth moistened with warm water and dry with a soft cloth. If it is not enough, then use a cloth with mild detergent. Do not use harsh or abrasive cleaners.

- **How to clean the cabinet of the monitor**

Use a soft cloth to clean the cabinet and control panel of the monitor. When excessively soiled dilute a neutral detergent in water, wet and wring out the soft cloth and afterward wipe with a dry soft cloth.

Never use acid/alkaline detergent, alcoholic detergent, abrasive cleaner, powder soap, OA cleaner, car wax, glass cleaner, etc. especially because they would cause discoloration, scratches or cracks.

1. Features

- **Large-screen, high-definition LCD panel**

The 28-inch color LCD panel, with a resolution of 1280 (H) x 768(V) pixels, creates a high-definition, large-screen (aspect ratio : 15:9) and low-profile flat display. Free from electromagnetic interferences from geomagnetic sources and ambient power lines, the panel produces high-quality display images free from color misconvergence and display distortion.

- **High Performance Digital Processor**

A wide range of personal computer signals can be handled, from 640 x 400, 640 x 480 VGA to 1600 x 1200 UXGA.

(RGB Analog input)

- **Easy-to-use remote control and on screen display system**

The remote control included eases the work of setting display controls. Further, the on-screen display system, displays the status of signal reception and display control settings in an easy-to-view fashion.

- **Power saving system**

The International ENERGY STAR® power saver feature saves power consumption automatically when input signals are not available.

When connected to a VESA DPMS-compliant PC, the monitor cuts its power consumption while it is idle.

- **TruBass SRS (●) TruBass**

TruBass, SRS and (●)® symbol are trademarks of SRS Labs, Inc.

TruBass technology is incorporated under license from SRS Labs, Inc.

- One mini D-sub terminal and one DVI-D terminal for RGB input

The D-sub terminal can also receive the RGB-component by On-Screen Display control.

- One composite/S.video input terminal and two component video input terminals.

One component input is possible to switch to RGB signal input from the Menu screen.

- One SCART terminal for the signal of the European standard.

It operates as composite/S.video input and RGB input terminal, or composite video output terminal.

- One composite video output terminal as a monitoring output.

- Various input/output terminals.

- Tuner and TELETEXT receiver.

- High performance type of the remote control.

28LD5200E (PW1L)

2. Specifications

Panel	Display dimensions	Approx. 28 inches (599.04 (H) x 359.42 (V) mm)
	Resolution	1280 (H) x 768 (V) pixels
Net dimensions		854 (W) x 516 (H) x 277 (D) mm
Net weight		21.9kg
Ambient conditions	Temperature	Operating : 5°C to 35°C, Storage : 0°C to 60°C
	Relative humidity	Operating : 20% to 80%, Storage : 20% to 90% (non-condensing)
Power supply		AC100 - 240V, 50/60Hz
Power consumption/at standby		155W / <1W
Audio output		12W + 12W (6Ω)
(RGB input)		
Input signals	Input terminals	RGB1 DVI input terminal (DVI-D) RGB1 audio input terminal (3.5mm Stereo Mini Jack) RGB2 analog RGB input terminal (D-sub 15-pin) RGB2 audio input terminal (3.5mm Stereo Mini Jack)
	Video signals	0.7 V/1.0 Vp-p, analog RGB (Recommended Signal) 480i, 576i, 480p, 576p, 1080i/50, 1080i/60, 720p/60
	Sync signals	H/V separate, TTL level [2KΩ] H/V composite, TTL level [2KΩ] Sync on green, 0.3 Vp-p [75Ω]
(Video input)		
Input signals	Input terminals	AV1: composite video input terminal (RCA) AV1: Y PB PR video input terminal (RCA) AV1: L/R audio input terminal (RCA) AV2: composite video input terminal (RCA) AV2: Y/G PB/B PR/R video input terminal (RCA) AV2: L/R audio input terminal (RCA) AV3: composite video input terminal (RCA) AV3: S video input terminal (RCA) AV3: L/R audio input terminal (RCA) AV4: composite video / S video / RGB / L/R audio input terminal (Scart)
	Video signals	AV1: PAL, SECAM, NTSC3.58, NTSC4.43 AV1: 480i, 576i, 480p, 576p, 1080i/50, 1080i/60, 720p/60 AV2: PAL, SECAM, NTSC3.58, NTSC4.43 AV2: 480i, 576i, 480p, 576p, 1080i/50, 1080i/60, 720p/60, RGB AV3: PAL, SECAM, NTSC3.58, NTSC4.43 AV4: PAL, SECAM, NTSC3.58, NTSC4.43 AV4: RGB
Video output Signal		OUTPUT (MONITOR): composite video monitor-output terminal (RCA) OUTPUT (MONITOR): L/R audio monitor- output terminal (RCA) AV4: composite video / L/R audio output terminal (SCART)
(RF input)		
Input signals	Input terminals	ANT : 75Ω Unbalanced
	RF Video System	PAL B, G, H / I / D, K SECAM B, G / D, K / K1

Applicable video signals for each input terminal

Terminal	RCA/SCART				DVI		D-sub	
	CVBS	S-video	Component	RGB	PC	STB	RGB	Component
AV1	○		○					
AV2	○		○	○				
AV3	○	○						
AV4	○	○		○				
RGB1					○	○		
RGB2							○	○

(○ : Available)

28LD5200E (PW1L)

3. Component names

[Main unit]

Control panel

These buttons are located on the top.

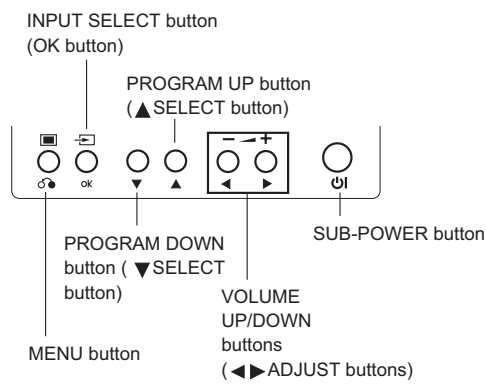

() indicates the function while the MENU is displayed on the screen.

[Remote Control]

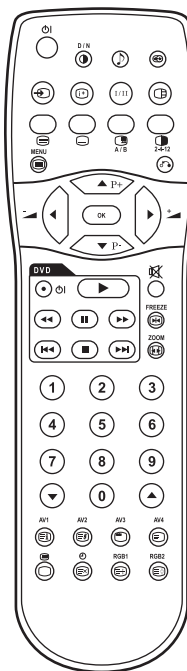

CLE-958

4.Adjustment

• How to get to Adjustment mode

Using the front control buttons with the set turned off (standby) can activate it.

Press the SUB-POWER(⏻) button, INPUT SELECT(↺) button and ▼ button at the same time, and hold for more than 5 seconds.

The set turns on in adjustment mode with OSD.

• Changing data and Selecting Adjustment code

When the set is in adjustment mode, the cursor ◀, ▶, ▲, ▼ and OK buttons of the remote control or front panel may be used as the adjustment keys.

▲, ▼ buttons are used for selecting adjustment code.

◀, ▶ buttons are used for changing data values.

OK button is used for confirming the data.

After finishing the necessary adjustment press MENU button. Adjustment mode is released and the set returns to normal condition.

• Memory Initialize operation

NOTE: The execution of this function returns the adjustment codes to the preset values, therefore, adjustment data will be lost.

Procedure

- (1) Enter Adjustment Mode.
- (2) Select MEMORY INIT adjustment code (No.704) and change the data value from 0 to 1.
- (3) Activate MEMORY INIT by pressing OK button for more than 3 seconds.
- (4) Select No.374 and change data value from 1 to 0.
- (5) Check that the receiving channel goes to AV1. Unit is set to preset values.

28LD5200E (PW1L)

● Service adjustment items by I²C-bus control

O : Should be adjusted
Δ : Should be followed previous data

ADJ. No.	Function		Maximum Value	Default	Changed Component			
	Adjustment Items	Mode			Formatter PWB	VIDEO PWB	TUNER PWB	LCD PANEL
0	R DRIVE1 [TV/VIDEO/DSUB-COMP]	COOL	255	230	Δ			○
1	G DRIVE1 [TV/VIDEO/DSUB-COMP]	COOL	255	230	Δ			○
2	B DRIVE1 [TV/VIDEO/DSUB-COMP]	COOL	255	255	Δ			○
3	R DRIVE2 [TV/VIDEO/DSUB-COMP]	NORMAL	255	230	Δ			○
4	G DRIVE2 [TV/VIDEO/DSUB-COMP]	NORMAL	255	230	Δ			○
5	B DRIVE2 [TV/VIDEO/DSUB-COMP]	NORMAL	255	230	Δ			○
6	R DRIVE3 [TV/VIDEO/DSUB-COMP]	WARM	255	230	Δ			○
7	G DRIVE3 [TV/VIDEO/DSUB-COMP]	WARM	255	230	Δ			○
8	B DRIVE3 [TV/VIDEO/DSUB-COMP]	WARM	255	230	Δ			○
9	R DRIVE4 [TV/VIDEO/DSUB-COMP]	BLACK & WHITE	255	230	Δ			○
10	G DRIVE4 [TV/VIDEO/DSUB-COMP]	BLACK & WHITE	255	230	Δ			○
11	B DRIVE4 [TV/VIDEO/DSUB-COMP]	BLACK & WHITE	255	230	Δ			○
12	R DRIVE1 [DVI-PC/DVI-STB/DSUB-RGB]	COOL	255	230	Δ			○
13	G DRIVE1 [DVI-PC/DVI-STB/DSUB-RGB]	COOL	255	230	Δ			○
14	B DRIVE1 [DVI-PC/DVI-STB/DSUB-RGB]	COOL	255	255	Δ			○
15	R DRIVE2 [DVI-PC/DVI-STB/DSUB-RGB]	NORMAL	255	230	Δ			○
16	G DRIVE2 [DVI-PC/DVI-STB/DSUB-RGB]	NORMAL	255	230	Δ			○
17	B DRIVE2 [DVI-PC/DVI-STB/DSUB-RGB]	NORMAL	255	230	Δ			○
18	R DRIVE3 [DVI-PC/DVI-STB/DSUB-RGB]	WARM	255	230	Δ			○
19	G DRIVE3 [DVI-PC/DVI-STB/DSUB-RGB]	WARM	255	230	Δ			○
20	B DRIVE3 [DVI-PC/DVI-STB/DSUB-RGB]	WARM	255	230	Δ			○
21	R DRIVE4 [DVI-PC/DVI-STB/DSUB-RGB]	BLACK & WHITE	255	230	Δ			○
22	G DRIVE4 [DVI-PC/DVI-STB/DSUB-RGB]	BLACK & WHITE	255	230	Δ			○
23	B DRIVE4 [DVI-PC/DVI-STB/DSUB-RGB]	BLACK & WHITE	255	230	Δ			○
24	Black Level(RGB_AMP)	TV/VIDEO	254					
25	Black Level(RGB_AMP)	PC	254	127				
26	Reference Amplitude(RGB_AMP)	TV/VIDEO	254	127				
27	Reference Amplitude(RGB_AMP)	PC	254	127				
28	Display for Max. Amplitude Level	Main	-	-				
29	Display for Max. Amplitude Level	SUB	-	-				
30	SUB_CONTRAST(RF)	MAIN	15	7				
31	SUB_CONTRAST (AV1)	MAIN/SUB COMPOSITE mode	15	7				
32	SUB_CONTRAST(RF)	SUB	15	7				
33	SUB_CONTRAST (AV4)	MAIN/SUB COMPOSITE mode	15	7				
34	SUB_COLOR(VIDEO-PAL/SECAM)	MAIN	15	0				
35	SUB_COLOR(RF-PAL/SECAM)	MAIN	15	3				
36	SUB_COLOR(VIDEO-NTSC)	MAIN	15	0				
37	SUB_COLOR(RF-NTSC)	MAIN	15	11				
38	SUB_COLOR(VIDEO-PAL/SECAM)	SUB	15	0				
39	SUB_COLOR(RF-PAL/SECAM)	SUB	15	3				
40	SUB_COLOR(VIDEO-NTSC)	SUB	15	0				
41	SUB_COLOR(RF-NTSC)	SUB	15	11				
42	TINT(VIDEO)	MAIN	63	33	Δ	○		
43	TINT(RF)	MAIN	63	33	Δ	○		
44	TINT(VIDEO)	SUB	63	33	Δ	○		
45	TINT(RF)	SUB	63	33	Δ	○		
46	S_B-Y_ADJ	MAIN	15	8				
47	S_R-Y_ADJ	MAIN	15	8				
48	S_B-Y_ADJ	SUB	15	8				
49	S_R-Y_ADJ	SUB	15	8				
50	BPF_Q (4.43MHz)	MAIN	3	3				
51	BPF_f0 (4.43MHz)	MAIN	3	1				
52	Y_DL (4.5MHz) For Asia	MAIN	10	5				
53	Y_DL (5.5MHz PAL/NTSC4.43) For Asia	MAIN	10	3				
54	Y_DL (5.5MHz SECAM) For Asia	MAIN	10	0				
55	Y_DL (6.0PAL/NTSC4.43) For Asia	MAIN	10	9				
56	Y_DL (6.0SECAM) For Asia	MAIN	10	9				
57	Y_DL (VIDEO PAL/NTSC4.43)	MAIN	10	6				
58	Y_DL (VIDEO SECAM)	MAIN	10	8				
59	Y_DL (VIDEO NTSC)	MAIN	10	6				
60	BELL_f0	MAIN	1	0				
61	Y_OUT_LEVEL (VIDEO)	MAIN	63	13				
62	Initialize function for EEPROM of Video PWB board		1	0				
63	Y_OUT_LEVEL (TEXT)	MAIN	63	0				
64	C_OUT_LEVEL (VIDEO)	MAIN	63	21				
65	Check condition of EEPROM of Video PWB board	0:Normal, 1:Abnormal(Fail or no assembly)	1	-				
66	C_OUT_LEVEL (TEXT)	MAIN	63	0				
67	Y_OUT_LEVEL (TEXT)	SUB	63	12				
68	Y_OUT_LEVEL (VIDEO)	SUB	63	13				
69	Dispersion Time of Sustain current 0: 2 Times, 1: 4 times	For Dynamic (Day) mode	1	0				
70	C_OUT_LEVEL (TEXT)	SUB	63	7				
71	C_OUT_LEVEL (VIDEO)	SUB	63	21				
72	Dispersion Time of Sustain current 0: 2 Times, 1: 4 times	For Natural (Night) mode	1	1				
73	BPF_Q (4.43MHz)	SUB	3	3				
74	BPF_f0 (4.43MHz)	SUB	3	1				
75	Y_DL (4.5MHz) For Asia	SUB	10	5				
76	Y_DL (5.5MHz PAL/NTSC4.43) For Asia	SUB	10	2				
77	Y_DL (5.5MHz SECAM) For Asia	SUB	10	0				
78	Y_DL (6.0PAL/NTSC4.43) For Asia	SUB	10	7				
79	Y_DL (6.0SECAM) For Asia	SUB	10	10				
80	Y_DL (VIDEO PAL/NTSC4.43)	SUB	10	8				
81	Y_DL (VIDEO SECAM)	SUB	10	6				
82	Y_DL (VIDEO NTSC)	SUB	10	5				
83	BELL_f0	SUB	1	0				
84	C_TRAP_SW (COMB=OFF-PAL/NTSC4.43/NTSC3.58)	MAIN	1	0				
85	C_TRAP_SW (COMB=OFF-PAL/NTSC4.43/NTSC3.58)	SUB	1	0				
86	MVM(VIDEO)	-	1	0				
87	AFC_GAIN (AV00)	-	3	0				
88	AFC_GAIN (AV1)	-	3	0				
89	AFC_GAIN (AV2)	-	3	0				
90	AFC_GAIN (AV3)	-	3	0				
91	AFC_GAIN (AV4)	-	3	0				
92	S_INHBT	-	1	0				
93	S_ID	-	1	0				

28LD5200E (PW1L)

O : Should be adjusted
 Δ : Should be followed previous data

ADJ. No.	Function		Maximum Value	Default	Changed Component			
	Adjustment Items	Mode			Formatter PWB	VIDEO PWB	TUNER PWB	LCD PANEL
94	S_GP	-	3	0				
95	S_V_ID	-	1	0				
96	BELL/HPF	-	3	3				
97	Cb offset1	MAIN	15	8				
98	Cr offset1	MAIN	15	8				
99	Cb offset1	SUB	15	8				
100	Cr offset1	SUB	15	8				
101	Sharpness Gain(VIDEO) PAL	MAIN	15	10				
102	Sharpness Gain(RF)	MAIN	15	5				
103	Sharpness EQ(4.5MHz)	MAIN	3	1				
104	Sharpness EQ(5.5MHz)	MAIN	3	1				
105	Sharpness EQ(6.0/6.5MHz)	MAIN	3	1				
106	Sharpness EQ(VIDEO)	MAIN	3	1				
107	Sharpness f0(VIDEO) PAL	MAIN	3	2				
108	Sharpness f0(RF)	MAIN	3	2				
109	Sharpness Gain(VIDEO) PAL	SUB	15	9				
110	Sharpness Gain(RF)	SUB	15	5				
111	Sharpness EQ(4.5MHz)	SUB	3	1				
112	Sharpness EQ(5.5MHz)	SUB	3	1				
113	Sharpness EQ(6.0/6.5MHz)	SUB	3	1				
114	Sharpness EQ(VIDEO)	SUB	3	1				
115	Sharpness f0(VIDEO) PAL	SUB	3	2				
116	Sharpness f0(RF)	SUB	3	2				
117	LPF	MAIN	1	0				
118	LPF	SUB	1	0				
119	SECAM D-Trap	MAIN/SUB	1	1				
120	FILTER SW(RF)	MAIN	1	0				
121	FILTER SW(RF)	SUB	1	0				
122	NTSC Comb(Comb off)	SUB	1	1				
123	HS Phase	MAIN	1	0				
124	HS Phase	SUB	1	0				
125	P/N ID	MAIN	1	0				
126	P/N ID	SUB	1	0				
127	Y/C_SEP_MODE (COMB=OFF-PAL)	-	3	0				
128	Y-Pi0	-	1	0				
129	Y-EQ_GAIN	-	3	2				
130	Y-EQ/N.C LIM	-	3	0				
131	Y-LPF	-	1	0				
132	V-EMPH_GAIN	-	7	3				
133	V-EMPH_NL	-	7	3				
134	V-EMPH_CORE	-	3	1				
135	D RANGE	-	1	0				
136	DY_GAIN	MAIN NTSC mode	15	9				
137	DC_GAIN	MAIN NTSC mode	15	6				
138	VAP_GAIN	MAIN NTSC mode	7	5				
139	VAP_INV	MAIN NTSC mode	31	31				
140	YH_CORE	MAIN NTSC mode	3	0				
141	YHCGAIN	MAIN NTSC mode	1	1				
142	CDL	MAIN NTSC mode	7	3				
143	YNRK	MAIN NTSC mode	1	1				
144	YNRINV	MAIN NTSC mode	1	0				
145	YNRLIM	MAIN NTSC mode	3	1				
146	CNRK		1	1				
147	CNRINV		1	0				
148	CNRLIM		3	1				
149	YPFG		15	8				
150	SEPA_LEVEL	480i/576i	3	2				
151	SEPA_LEVEL	480p/576p	3	2				
152	SEPA_LEVEL	1080i_50	3	2				
153	SEPA_LEVEL	1080i_60/720p	3	2				
154	AUTO_FM/AM(D11-D8)	-	15	2				
155	AUTO_FM/AM(D7-D0)	-	254	189				
156	A2_THRESHOLD(D11-D8)	-	15	0				
157	A2_THRESHOLD(D7-D0)	-	254	112				
158	PRE_AM	Except 4.5MHz (Except Dual/Stereo mode)	254	17				
159	VOL_SCART1 (D15-D8)	-	254	115				
160	VOL_SCART1 (D7-D5)	-	7	0				
161	PRE_SCART	-	254	31				
162	PRE_FM	4.5MHz(JAPAN)	254	34				
163	PRE_FM	4.5MHz(Except BTSC-SAP mode)	254	32				
164	PRE_FM	4.5MHz(BTSC-SAP)	254	60				
165	PRE_FM	4.5MHz(Except KOREA-Dual/Stereo mode)	254	19				
166	PRE_FM	4.5MHz(KOREA-Dual/Stereo)	254	34				
167	PRE_FM	Except 4.5MHz(Except Dual/Stereo mode)	254	17				
168	PRE_FM	Except 4.5MHz(Dual/Stereo mode)	254	27				
169	PRE_NICAM	-	254	57				
170	Screen Saver-Picture shift amount 0:1pixel 1:2pixel 2:3pixel		2	0				
171	Thermo sensor function available or not 0:None,1:Yes		1	0				
172	Video Input function available or not at RGB1 & RGB2 mode	0:Not available, 1:Available	1	1				
173	Screen Saver-Picture shift direction 0:dia 1:cross 2:up/down 3:left/right		3	0				
174	AUDIO Function available 0:NO,1:YES		1	1				
175	Remote Function available 0:NO,1:YES		1	1				
176	Power Save On/Off Setting at Initialize,Reset and Shipping	0:Change 1: Don't Change	2	0				
177	DVI-STB/RGB-COMPONENT Function available 0:NO,1:YES		1	0				
178	Dynamic Backlight function 0:No, 1:Yes	For LCD model	1	1				
179	ISM Control for WVGA		1	1				
180	Terminal Mode Function available 0:Not Available, 1:Available	RS232C	1	0				
181	Black insert function 0:Not available, 1:Available	For Dynamic mode or Day mode (For LCD model only)	1	0				
182	AGC_LEVEL AGCL	ALL Mode	3	0				
183	TEXT_H sync delay	-	127	0				
184	TEXT_V sync delay	-	127	50				
185	TEXT_H_POSITION	-	254	42				
186	TEXT_V_POSITION	-	254	38				
187	Lower Limits value for Sync Detect of 2ms interval	For AFC at TV mode	254	25				

28LD5200E (PW1L)

O : Should be adjusted
 Δ : Should be followed previous data

ADJ. No.	Function		Maximum Value	Default	Changed Component			
	Adjustment Items	Mode			Formater PWB	VIDEO PWB	TUNER PWB	LCD PANEL
188	Upper Limits Value for Sync Detect of 2ms interval	For AFC at TV mode	254	40				
189	Lower Limits value for Sync Detect of 2ms interval	For Free Running at TV mode	254	30				
190	Upper Limits Value for Sync Detect of 2ms interval	For Free Running at TV mode	254	45				
191	Lower Limits value for Sync Detect of 2ms interval	For AUTO OFF at TV mode	254	25				
192	Upper Limits Value for Sync Detect of 2ms interval	For AUTO OFF at TV mode	254	35				
193	Lower Limits value for Sync Detect of 2ms interval	For Free Running at AV mode	254	30				
194	Upper Limits Value for Sync Detect of 2ms interval	For Free Running at AV mode	254	45				
195	Counting time for discrimination of IV	-	31	2				
196	Dispersion Time of Sustain current 0: 2 Times, 1: 4 times	For PC mode	1	1				
197	Counting time for discrimination of SYNC	-	31	2				
198	Input Source of IV/II judgment(0:M30625/TA1370)	Component Mode	1	0				
199	Counting time for discrimination of IV(M30625/TA1370)	-	31	2				
200	Y_DL (6.5MHz PAL/NTSC4.43) For Asia	Main	10	7				
201	Y_DL (6.5MHz SECAM) For Asia	Main	10	10				
202	Y_DL (6.5MHz PAL/NTSC4.43) For Asia	Sub	10	4				
203	Y_DL (6.5MHz SECAM) For Asia	Sub	10	10				
204	PDP-BLK ON/OFF	1:ON, 0:OFF	1	0				
205	Counting time for discrimination of II(M30625/TA1370)	-	31	2				
206	Sharpness f0(L)	Sub	3	2				
207	NJW1320_OUT1_GAIN	VIDEO PWB	1	0				
208	NJW1320_OUT2_GAIN	VIDEO PWB	1	0				
209	Sharpness f0(L')	Sub	3	2				
210	AFC_GAIN (Except AV00 mode)	Except AV00 mode	3	0				
211	Recovery to an error of OSC frequency of Ceramic resonator for timer	-	62	34				
212	Brightness Center (CM)	NT2/NT3/HD2/HD3/PAL2/PAL3/HD9/HD10/NT4/PAL4	254	128				
213	Brightness Center (CM)	HD1/HD4/HD5/HD6/HD7/HD8	254	128				
214	Brightness Center (CM)	MULTI PICTURE/NT1/PAL1	254	128				
215	Reset function of accumulation time for WVGA/LCD Panel	0:Normal 1:Reset	1	0				
216	Contrast Center (CM) Except WVGA & LCD	TV/VIDEO(AV3/AV4 mode)	254	137				
217	Power key function available or not (At Force AVC mode)	0:Available 1:Cannot	1	0				
218	Color Center (CM)	NT1/NT2/NT4/HD3/HD4/HD6/PAL4	127	46				
219	Color Center (CM)	PAL1/PAL2/HD8/HD9	127	50				
220	Color Center (CM)	NT3/HD1/HD2/HD5/PAL3/HD7/HD10	127	58				
221	Tint Center (CM)	PAL1	254	140				
222	Tint Center (CM)	NT1/NT2/NT4/HD3/HD4/HD6	254	130				
223	Tint Center (CM)	PAL2/HD8/HD10/PAL4	254	108				
224	Tint Center (CM)	NT3/HD1/HD2/HD5/PAL3/HD7/HD9	254	140				
225	Center of Sharpness (HV Enhancer Gain for Y) For Europe	TV	31	15				
226	Center of Sharpness (HV Enhancer Gain for Y) For Europe	VIDEO	31	15				
227	Center of Sharpness (HV Enhancer Gain for Y) For Europe	HD5/HD6	31	6				
228	Center of Sharpness (HV Enhancer Gain for Y) For Europe	HD1/HD4/HD7/HD8	31	10				
229	Center of Sharpness (HV Enhancer Gain for Y) For Europe	HD2/HD3/HD9/HD10	31	10				
230	Center of Sharpness (HV Enhancer Gain for Y) For Europe	NT2/NT3/PAL2/PAL3/NT4/PAL4	31	14				
231	Center of Sharpness (HV Enhancer Gain for Y) For Europe	TEXT(for split)	31	7				
232	Maximum Value of Contrast at REAL/NORMAL mode	-	254	188				
233	Offset Value of Contrast data at SPLIT mode	-	120	55				
234	Offset value of gain for Black Stretch function	Except OFF/LOW/HIGH mode	63	33				
235	Demonstration [White] 0:3:None,4:0.5:+10W,6:+20W,7:+30W	Mode(common)	7	5				
236	Demonstration 0:Normal, 1:Peak	Mode	1	1				
237	Demonstration [Middle] 0:+0W,1:+10W,2:+20W,3:+30W	Mode(common)	3	3				
238	Demonstration 0:Normal, 1:Peak	Mode	1	0				
239	Horizontal Enhance	TEXT	3	3				
240	YNR Input Level at Low level for DVI-STV Mode	1080i-60/1080i-50/720p-60	7	2				
241	YNR Input Level at Low level for DVI-STV Mode	480i/480p/576i/576p/VGA	7	2				
242	CNR Input Level at Low level for DVI-STV Mode	1080i-60/1080i-50/720p-60	7	2				
243	CNR Input Level at Low level for DVI-STV Mode	480i/480p/576i/576p/VGA	7	2				
244	Vertical Enhance	TEXT	3	3				
245	Demonstration Mode 0:(Off), 1:(On)	-	1	0				
246	WVGA sys_state	For WVGA	1	0				
247	WVGA BRIGHTNESS	For WVGA	1	0				
248	Enhancer gain of VH for C	TEXT	31	0				
249	YNR(NR) Input Level	RF Mode	7	3				
250	YNR Input Level at Low level for AV1-4 Mode	VIDEO	7	3				
251	YNR Input Level at Low level for AV1-4 Mode	NT2/NT3/PAL2/PAL3/NT4/PAL4	7	3				
252	YNR Input Level at Low level for AV1-4 Mode	HD1/HD4/HD5/HD6/HD7/HD8	7	3				
253	YNR Input Level at Low level for AV1-4 Mode	HD2/HD3/HD9/HD10	7	3				
254	CNR Input Level at Low level for AV1-4 Mode	VIDEO	7	3				
255	CNR Input Level at Low level for AV1-4 Mode	NT2/NT3/PAL2/PAL3/NT4/PAL4	7	3				
256	CNR Input Level at Low level for AV1-4 Mode	HD1/HD4/HD5/HD6/HD7/HD8	7	3				
257	CNR Input Level at Low level for AV1-4 Mode	HD2/HD3/HD9/HD10	7	3				
258	Heat APC function (HAPC) available	-	1	1				
259	yselect(0:1.0 1:2.2 2:2.8)	TV/VIDEO	2	1				
260	yselect(0:1.0 1:2.2 2:2.8)	DVI-PC/DVI-STB/DSUB-RGB	2	1				
261	Select for APC function	-	1	0				
262	"CCFMD" function	TV/VIDEO	1	0				
263	"CCFMD" function	DVI-PC/DVI-STB/DSUB-RGB	1	0				
264	NTSC/EBU(CCFORM)	NT1/NT2/HD3/HD4/HD6/HD8/HD10/PAL1/PAL2	1	0				
265	NTSC/EBU(CCFORM)	TV/VIDEO/NT3/PAL3/HD1/HD2/HD5/HD7/HD9/NT4/PAL4	1	0				
266	NTSC/EBU(CCFORM)	DVI-PC/DVI-STB/DSUB-RGB	1	0				
267	Correction for Tracking (DCBON)	TV/VIDEO-Color Temp. : COOL	1	0				
268	Correction for Tracking (DCBON)	TV/AV-Col. Temp. : Nor/War	1	1				
269	Correction for Tracking (DCBON)	DVI-PC/DVI-STB/DSUB-RGB	1	1				
270	Color Temp. Correction	-	3	2				
271	Typical Value of Contrast OSD	DYNAMIC	31	31				
272	PC Power Save function (0:Impossible 1:Possible)	-	1	1				
273	Waite Time for POWER SAVE function (s)	VIDEO/PC	254	15				
274	Lower Limits value for Sync Detect of 2ms interval	For Power Save at AV mode	254	5				
275	Upper Limits Value for Sync Detect of 2ms interval	For Power Save at AV mode	254	200				
276	Horizontal Position of OSD	60Hz	15	7				
277	Vertical Position of OSD	60Hz	15	7				
278	PinP Function 0:PinP, 1:Infomation1, 2:Infomaiton Split	-	2	0				
279	Select for WIDE Mode	-	1	1				
280	Temperature for Fun start (Temp_High)	-	254	58				
281	Temperature for Fun stop (Temp_Low)	-	254	55				

28LD5200E (PW1L)

O : Should be adjusted
Δ : Should be followed previous data

ADJ. No.	Function		Maximum Value	Default	Changed Component			
	Adjustment Items	Mode			Formater PWB	VIDEO PWB	TUNER PWB	LCD PANEL
282	Display of internal temperature C°(Temperature)		125	-				
283	Display of Panel map version		255	-				
284	accumulation time for Panel (hours)		65535	-				
285	Initialize function 0:Keep data, 1:Initialize	No.0-No.23,30-33,42-45,289,293,294Adj No.741-743,	1	-				
286	L standard PLL gating HIGH [Europe model]		1	0				
287	Select for APC output [Except Europe model]	Main FE	2	1				
288	Q mode 0:Freeze, 1:Move 1, 2:Move 2	50Hz	2	1				
289	AGC adjustment (MFE) [Except Europe model]	MAIN	63	50	Δ		O	
290	AGC adjustment (MFE) [Europe model]	MAIN	63	20				
291	AGC INPUT(MFE)	MAIN	-	-				
292	Q mode 0:Freeze, 1:Move 1, 2:Move 2	70Hz(PC)	2	0				
293	SUB CONTRAST AV2	MAIN/SUB COMPOSITE mode	15	8				
294	SUB CONTRAST AV3	MAIN/SUB COMPOSITE mode	15	8				
295	Contrast Center (CM) Except WVGA & LCD	AV2	254	137				
296	Contrast Center (CM) Except WVGA & LCD	AV1	254	137				
297	Brightness center (CM) offset	AV2	254	127				
298	Brightness center (CM) offset	AV1	254	127				
299	Q mode 0:Freeze, 1:Move 1, 2:Move 2	60Hz	2	1				
300	3D ON/OFF 0:ON,1:OFF(Through)		1	0				
301	Input Select of TA1370 0:HD1/VD1,1:HD3/VD3	Main/Sub	1	0				
302	Sharpness Gain(RF/NR)	Main/Sub	15	3				
303	3Line Y/C Main- Sub SW	0:Main, 1: Sub	1	0				
304	Offset Value(+/-) of Upper Limit (for TB1274:SUB-CONT)	Single Picture mode	18	2				
305	Offset Value(+/-) of Upper Limit (for FC :RGB-AMP)	Multi Picture mode	18	2				
306	Reference Amplitude(RGB_AMP)	Multi Picture mode	254	90				
307	Component Frq.(fH) Setup (0:28/31/33/45KHz,1:28/31/45KHz)		1	0				
308	Target value of White peak Adj.	Single Picture mode	237	235				
309	Sharpness Gain(S VIDEO)	Main	15	7				
310	Sharpness Gain(S VIDEO)	Sub	15	7				
311	Select color control (0: Asia, 1: South America)	Main/Sub	1	0				
312	Sharpness Gain Main(N-PAL)		15	8				
313	Sharpness f0 Main(N-PAL)		3	2				
314	Sharpness Gain Sub (N-PAL)		15	9				
315	Sharpness f0 Sub (N-PAL)		3	2				
316	Delay Time ON/OFF for Lipsync circuit 0:Off, 1:On		1	1				
317	Sync Mode SW		7	0				
318	Set Sound System at Auto mode of Sound Sys. (0:auto,1:4.5MHz)	Main	1	0				
319	Power condition at power save mode of PC mode after done RESET function	0:Keep last condition, 1:Return to normal condition	1	0				
320	Switch to North USA model from Europe software. OSD change (Wide Mode,...)	0:For Europe, 1:Foe USA (DAY/NIGHT,...)	1	0				
321	Count Souce for ON/OFF Timer	0:MCU-250ms, 1:AC-50/60Hz	1	0				
322	Select Wide mode for Europe model (Normal= 5mode/ For Service= 10 mode)	0:Normal, 1:For service	1	0				
323	Forced AVC type available	0:Normal type , 1: Forced AVC type	1	0				
324	Sharpness Gain Main(M-PAL)		15	8				
325	Sharpness f0 Main(M-PAL)		3	2				
326	Sharpness Gain Sub (M-PAL)		15	9				
327	Sharpness f0 Sub (M-PAL)		3	2				
328	CNR Input Level at Low level for Dsub Comp. Mode	NT2/NT3/PAL2/PAL3/NT4/PAL4	7	2				
329	CNR Input Level at Low level for Dsub Comp. Mode	HD1/HD4/HD5/HD6/HD7/HD8	7	2				
330	CNR Input Level at Low level for Dsub Comp. Mode	HD2/HD3/HD9/HD10	7	2				
331	Sharpness Gain(VIDEO) NTSC3.58	MAIN	15	12				
332	Sharpness f0(VIDEO) NTSC3.58	MAIN	3	2				
333	Sharpness Gain(VIDEO) NTSC3.58	SUB	15	10				
334	Sharpness f0(VIDEO) NTSC3.58	SUB	3	2				
335	Sharpness Gain(VIDEO) SECAM,B/W	MAIN	15	10				
336	Sharpness f0(VIDEO) SECAM,B/W	MAIN	3	2				
337	Sharpness Gain(VIDEO) SECAM,B/W	SUB	15	8				
338	Sharpness f0(VIDEO) SECAM,B/W	SUB	3	2				
339	Sharpness Gain(VIDEO) NTSC4.43	MAIN	15	9				
340	Sharpness f0(VIDEO) NTSC4.43	MAIN	3	2				
341	Sharpness Gain(VIDEO) NTSC4.43	SUB	15	8				
342	Sharpness f0(VIDEO) NTSC4.43	SUB	3	2				
343	Brightness Limited Function of PANEL [APSON]		1	1				
344	VsVa WAIT TIMER [RISTIM]		15	5				
345	Initial value of Contrast	Panel life -Extend1	127	93				
346	Interval time of correction time	Panel life -Extend1	127	10				
347	Additional value of Contrast	Panel life -Extend1	127	1				
348	Initial value of Contrast	Panel life -Extend2	127	63				
349	Interval time of correction time	Panel life -Extend2	127	6				
350	Additional value of Contrast	Panel life -Extend2	127	1				
351	L_PLL_GAIN		1	0				
352	AS[YHECLPL0_P0]	RF/Multi	15	2				
353	AS[YHECLPL1_P0]	NT1-except RF/PAL1-except RF	15	2				
354	[YHECLPL2_P0]	HD	15	1				
355	AS[YHECLPL3_P0]	NT2,3,4/PAL2,3,4	15	10				
356	SEPA_LEVEL_DSUB	480i/576i	3	2				
357	SEPA_LEVEL_DSUB	480p/576p	3	2				
358	SEPA_LEVEL_DSUB	1080i_50	3	2				
359	SEPA_LEVEL_DSUB	1080i_60/720p	3	2				
360	HD-PHASE_DSUB	480i/576i	63	20				
361	HD-PHASE_DSUB	480p/576p	63	20				
362	HD-PHASE_DSUB	1080i_50	63	20				
363	HD-PHASE_DSUB	1080i_60/720p	63	20				
364	Y_DL (L)	MAIN	10	4				
365	Y_DL (L')	MAIN	10	4				
366	Y_DL (L)	Sub	10	1				
367	Y_DL (L')	Sub	10	1				
368	Sharpness Gain(L)	MAIN	15	10				
369	Sharpness Gain(L')	MAIN	15	10				
370	Sharpness Gain(L)	SUB	15	8				
371	Sharpness Gain(L')	SUB	15	8				
372	Sharpness f0(L)	MAIN	3	2				
373	Sharpness f0(L')	MAIN	3	2				
374	BURN-IN enable/ disenable	0:Disenable, 1:Enable	1	1				
375	BURN-IN mode		2	2				

28LD5200E (PW1L)

O : Should be adjusted
 Δ : Should be followed previous data

ADJ. No.	Function		Maximum Value	Default	Changed Component			
	Adjustment Items	Mode			Formatter PWB	VIDEO PWB	TUNER PWB	LCD PANEL
376	CM_THRESHOLD (D15-D8)	-	254	0				
377	CM_THRESHOLD (D7 -D0)	-	254	36				
378	Sharpness Gain(RF M)	MAIN	15	11				
379	Sharpness Gain(RF M)	Sub	15	11				
380	Sharpness f0 (RF M)	Main	3	2				
381	Sharpness f0 (RF M)	SUB	3	2				
382	Counting value of 2ms Sync.Detect	MAIN	-	-				
383	Counting value of 2ms Sync.Detect	SUB	-	-				
384	TB1274 Read Data(00h)	Main	-	-				
385	TB1274 Read Data(01h)	Main	-	-				
386	TB1274 Read Data(00h)	Sub	-	-				
387	TB1274 Read Data(01h)	Sub	-	-				
388	MSP Read Data (CONTROL) (D15-D8)		-	-				
389	MSP Read Data (CONTROL) (D7 -D0)		-	-				
390	MSP Read Data (STANDARD_RES) (D15-D8)		-	-				
391	MSP Read Data (STANDARD_RES) (D7 -D0)		-	-				
392	MSP Read Data (STATUS) (D15-D8)		-	-				
393	MSP Read Data (STATUS) (D7 -D0)		-	-				
394	TA1370G Read Data(00h)	Video board side	-	-				
395	TA1370G Read Data(01h)	Video board side	-	-				
396	TA1370G Read Data(00h)	Formater side	-	-				
397	TA1370G Read Data(01h)	Formater side	-	-				
398	uPD64084 Read Data(00H)		-	-				
399	uPD64084 Read Data(01h)		-	-				
400	Language (Refer to below)		6	0				
401	Hotel Mode(0:No,1:Yes)		1	0				
402	Analog Data (0:Keep EEPROM,1:Not Keep to EEPROM)		1	0				
403	Maximum Volume Limit		63	63				
404	Power Mode(0>Last mode, 1:Pos1, 2:V1, 3:V2, 4:V3, 5:V4)		5	0				
405	Channel Select(0:CCIR, 1:CHINA)		1	0				
406	Auto_sound 4.5 (0:Korea, 1:BTSC, 2:Japan)		2	0				
407	T/TEXT(0: None, 1:Yes)		1	1				
408	TEXT Language		7	0				
409	IIC BUS Data/Clock Open(0:Close, 1:Open)		1	0				
410	Channel Preset(0:VESTEL, 1:GIFU, 2:HAMA, 3:HFD,4:AUSTRALIA)		4	1				
411	Detect and Disply Tele-Cinema (0:normal 1:Tele Cinema)		-	-				
412	V FREQ 60Hz Force (0:None, 1:Yes)	Main/Sub	1	0				
413	COLOR SYSTEM CONTROL-MODE(0:BW, 2:3.58NTSC, 3:4.43NTSC,...)	Main	-	-				
414	COLOR SYSTEM CONTROL-MODE(0:BW, 2:3.58NTSC, 3:4.43NTSC,...)	Sub	-	-				
415	Horizontal Filter SW [HHPF0]	NTSC	1	0				
416	Enhancer Gain [HHPF1]	PAL	1	0				
417	Enhancer Gain [HHPF2]	HD	1	0				
418	Horizontal Coring Level(Enhancer Gain) AS[HECOR0_PO]	NT1-RF	15	1				
419	Horizontal Coring Level(Enhancer Gain) AS[HECOR1_PO]	PAL1-RF/Multi	15	1				
420	Horizontal Coring Level(Enhancer Gain) [HECOR2_PO]	NT1-Video	15	1				
421	Horizontal Coring Level(Enhancer Gain) [HECOR3_PO]	PAL1-Video	15	1				
422	Horizontal Coring Level(Enhancer Gain) [HECOR4_PO]	NT2/NT3/NT4/PAL2/PAL3/PAL4	15	0				
423	Horizontal Coring Level(Enhancer Gain) [HECOR5_PO]	HD2/HD3/HD9/HD10	15	1				
424	Horizontal Coring Level(Enhancer Gain) [HECOR6_PO]	HD1/HD4/HD5/HD6/HD7/HD8	15	0				
425	Horizontal Coring Level(Enhancer Gain) [HECORPC_PO]	PC	15	1				
426	Horizontal Coring Level(Enhancer Gain) EU[HECORE_PO]	PAL1-RF/multi	15	1				
427	Vertical Coring Level(Enhancer Gain) AS[VECOR0_PO]	NT1-RF	15	1				
428	Vertical Coring Level(Enhancer Gain) AS[VECOR1_PO]	PAL1-RF/multi	15	1				
429	Vertical Coring Level(Enhancer Gain) [VECOR2_PO]	NT1-Video	15	1				
430	Vertical Coring Level(Enhancer Gain) [VECOR3_PO]	PAL1-Video	15	1				
431	Vertical Coring Level(Enhancer Gain) [VECOR4_PO]	NT2/NT3/NT4/PAL2/PAL3/PAL4	15	0				
432	Vertical Coring Level(Enhancer Gain) [VECOR5_PO]	HD2/HD3/HD9/HD10	15	0				
433	Vertical Coring Level(Enhancer Gain) [VECOR6_PO]	HD1/HD4/HD5/HD6/HD7/HD8	15	0				
434	Vertical Coring Level(Enhancer Gain) [VECORPC_PO]	PC	15	0				
435	Vertical Coring Level(Enhancer Gain) EU[VECORE_PO]	PAL1-RF/multi	15	0				
436	Horizontal Coring Level(Enhancer Gain) AS[HECOR0_P1]	NT1-RF	15	1				
437	Horizontal Coring Level(Enhancer Gain) AS[HECOR0_P2]	PAL1-RF/multi	15	1				
438	Horizontal Coring Level(Enhancer Gain) [HECOR0_P3]	NT1-Video	15	0				
439	Horizontal Coring Level(Enhancer Gain) [HECOR0_P4]	PAL1-Video	15	1				
440	Horizontal Coring Level(Enhancer Gain) [HECOR0_P5]	NT2/NT3/NT4/PAL2/PAL3/PAL4	15	0				
441	Horizontal Coring Level(Enhancer Gain) [HECOR0_P6]	HD2/HD3/HD9/HD10	15	1				
442	Horizontal Coring Level(Enhancer Gain) [HECOR0_P7]	HD1/HD4/HD5/HD6/HD7/HD8	15	1				
443	Horizontal Coring Level(Enhancer Gain) [HECORPC_P1]	PC	15	1				
444	Horizontal Coring Level(Enhancer Gain) EU[HECORE_P1]	PAL1-RF/multi	15	1				
445	Vertical Coring Level(Enhancer Gain) AS[VECOR0_P1]	NT1-RF	15	1				
446	Vertical Coring Level(Enhancer Gain) AS[VECOR0_P2]	PAL1-RF/multi	15	1				
447	Vertical Coring Level(Enhancer Gain) [VECOR0_P3]	NT1-Video	15	1				
448	Vertical Coring Level(Enhancer Gain) [VECOR0_P4]	PAL1-Video	15	1				
449	Vertical Coring Level(Enhancer Gain) [VECOR0_P5]	NT2/NT3/NT4/PAL2/PAL3/PAL4	15	1				
450	Vertical Coring Level(Enhancer Gain) [VECOR0_P6]	HD2/HD3/HD9/HD10	15	15				
451	Vertical Coring Level(Enhancer Gain) [VECOR0_P7]	HD1/HD4/HD5/HD6/HD7/HD8	15	0				
452	Vertical Coring Level(Enhancer Gain) [VECORPC_P1]	PC	15	0				
453	Vertical Coring Level(Enhancer Gain) EU[VECORE_P1]	PAL1-RF/multi	15	0				
454	YFRNR Input Gain (Main) 2pictures [MYNRG0]	except HD-HD	7	1				
455	(HD-NTSC,HD-PAL (sub) [MYNRG1]	HD-HD	7	4				
456	4pictures [MYNRG2]	NT-* /PAL-*	7	1				
457	[MYNRG3]	HD-*	7	4				
458	YFRNR Input Gain(Sub) [YCNRG0]	2pictures	7	4				
459	[YCNRG1]	4pictures/12pictures	7	1				
460	CFRNR Input Gain 8Main) 2pictures [MCNRG0]	except HD-HD	7	3				
461	<HD-NTSC,HD-PAL(Sub) [MCNRG1]	HD-HD	7	4				
462	[MCNRG2]		7	4				
463	[MCNRG3]	HD-*	7	4				
464	CFRNR Input Gain [SCNRG0]	2pictures	7	3				
465	[SCNRG1]	4pictures/12pictures	7	4				
466	YFRNR Transition Level [MYNRP0]	NT1/PAL1/multi	7	1				
467	[MYNRP5]	NT1/PAL1-Video	7	0				
468	[MYNRP6]	NT2/NT3/NT4/PAL2/PAL3/PAL4	7	0				
469	[MYNRP7]	HD2/HD3/HD9/HD10	7	0				

28LD5200E (PW1L)

O : Should be adjusted
 Δ : Should be followed previous data

ADJ. No.	Function	Mode	Maximum Value	Default	Changed Component			
					Formatter PWB	VIDEO PWB	TUNER PWB	LCD PANEL
470	[MYNRP8]	HD1/HD4/HD5/HD6/HD7/HD8	7	0				
471	YFRNR Transition Level (Main/Sub) [MCNRP0]	NT1/PAL1/multi	7	2				
472	[MCNRP5]	NT1/PAL1-video	7	2				
473	[MCNRP6]	NT2/NT3/NT4/PAL2/PAL3/PAL4	7	2				
474	[MCNRP7]	HD2/HD3/HD9/HD10	7	2				
475	[MCNRP8]	HD1/HD4/HD5/HD6/HD7/HD8	7	0				
476	Vertical Enhancer [YVEG0_P0]	NTSC/PAL(-except RF)	15	8				
477	[YVEG1_P0]	HD2/HD3/HD9/HD10	15	12				
478	[YVEG2_P0]	HD1/HD4/HD5/HD6/HD7/HD8	15	8				
479	AS[YVEG3_P0]	PAL1-RF/multi	15	8				
480	EU[YVEG0_E_P0]	PAL1-RF/multi	15	8				
481	Vertical RGB Gain For Y/G [YVDSBG0_P0]	NTSC/PAL/multi	3	0				
482	[YVDSBG1_P0]	HD2/HD3/HD9/HD10	3	0				
483	[YVDSBG2_P0]	HD1/HD4/HD5/HD6/HD7/HD8	3	0				
484	Vertical RGB Coring For Y/G [YVDSBG0_P0]	NTSC/PAL/multi	7	0				
485	[YVDSBG1_P0]	HD	7	3				
486	Vertical Enhancer Clip for Y/G [YVECLP0_P0]	NTSC/PAL/multi	1	1				
487	[YVECLP1_P0]	HD	1	1				
488	Vertical Clip Offset level [YVECLP0_P0]	NTSC/PAL/multi	15	7				
489	[YVECLP1_P0]	HD	15	1				
490	Vertical Non Linear Peaking for Y/G [YVNL0_P0]	NTSC/PAL/multi	63	0				
491	[YVNL1_P0]	HD	63	0				
492	Horizontal HPF Peak Freq SW for Y/G [YHHPF0_P0]	NTSC/PAL/multi	3	2				
493	[YHHPF1_P0]	HD2/HD3/HD9/HD10	3	1				
494	[YHHPF2_P0]	HD1/HD4/HD5/HD6/HD7/HD8	3	1				
495	Horizontal Enhancer Gain for Y/G [YHEG0_P0]	NTSC/PAL(except -RF)	15	15				
496	[YHEG1_P0]	HD2/HD3/HD9/HD10	15	15				
497	[YHEG2_P0]	HD1/HD4/HD5/HD6/HD7/HD8	15	0				
498	AS[YHEG3_P0]	PAL1-RF/multi	15	15				
499	EU[YHEG0_E_P0]	PAL1-RF/multi	15	15				
500	Hrozontal DSB Gain for Y/G [YHDSBG0_P0]	NTSC/PAL/multi	3	3				
501	[YHDSBG1_P0]	HD2/HD3/HD9/HD10	3	0				
502	[YHDSBG2_P0]	HD1/HD4/HD5/HD6/HD7/HD8	3	0				
503	Horizontal DSB Coring for Y/G [YHDSBC0_P0]	NTSC/PAL/multi	7	1				
504	[YHDSBC1_P0]	HD	7	0				
505	Horizontal Enhancer Clip for Y/G [YHECLP0_P0]	NTSC/PAL/multi	1	0				
506	[YHECLP1_P0]	HD	1	0				
507	Horizontal Clip Offset Level for Y/G AS[YHECLP0_P0]	RF/multi	15	2				
508	AS[YHECLP1_P0]	NT1-except RF/PAL1-except RF	15	2				
509	[YHECLP2_P0]	HD	15	1				
510	EU[YHECLP0_E_P0]	RF/multi	15	4				
511	EU[YHECLP1_E_P0]	NT1-except RF/PAL1-except RF	15	4				
512	Horizontal Non Linear Peaking for Y/G [YHNL0_P0]	NTSC/PAL/multi	63	0				
513	[YHNL1_P0]	HD	63	0				
514	Coring Amplitude for Y/G [YCOR0_P0]	NT1-RF/PAL1-RF/multi	7	7				
515	[YCOR1_P0]	NT1-Video/PAL1-Video	7	5				
516	[YCOR2_P0]	NT2/NT3/NT4/PAL2/PAL3/PAL4	7	3				
517	[YCOR3_P0]	HD2/HD3/HD9/HD10	7	1				
518	[YCOR4_P0]	HD1/HD4/HD5/HD6/HD7/HD8	7	1				
519	Vertical Enhancer Gain for Y/G [YVEG0_P1]	NTSC/PAL(-RF以外)	15	15				
520	[YVEG1_P1]	HD2/HD3/HD9/HD10	15	4				
521	[YVEG2_P1]	HD1/HD4/HD5/HD6/HD7/HD8	15	15				
522	AS[YVEG3_P1]	PAL1-RF/multi	15	15				
523	EU[YVEG0_E_P1]	PAL1-RF/multi	15	15				
524	Vertical DSB Gain for Y/G [YVDSBG0_P1]	NTSC/PAL/multi	3	3				
525	[YVDSBG1_P1]	HD2/HD3/HD9/HD10	3	0				
526	[YVDSBG2_P1]	HD1/HD4/HD5/HD6/HD7/HD8	3	2				
527	Vertical DSB Coring for Y/G [YVDSBC0_P1]	NTSC/PAL/multi	7	7				
528	[YVDSBC1_P1]	HD	7	0				
529	Vertical Enhancer Clip for Y/G [YVECLP0_P1]	NTSC/PAL/multi	1	1				
530	[YVECLP1_P1]	HD	1	0				
531	Vertical Clip Offset Level for Y/G [YVECLP0_P1]	NTSC/PAL/multi	15	15				
532	[YVECLP1_P1]	HD	15	8				
533	Vertical Non Linear Peaking for Y/G [YVNL0_P1]	NTSC/PAL/multi	63	0				
534	[YVNL1_P1]	HD	63	0				
535	Horizontal HPF Pead Freq SW for Y/G [YHHPF0_P1]	NTSC/PAL/multi	3	2				
536	[YHHPF1_P1]	HD2/HD3/HD9/HD10	3	2				
537	[YHHPF2_P1]	HD1/HD4/HD5/HD6/HD7/HD8	3	2				
538	Horizontal Enhancer Gain for Y/G [YHEG0_P1]	NTSC/PAL(except-RF)	15	15				
539	[YHEG1_P1]	HD2/HD3/HD9/HD10	15	15				
540	[YHEG2_P1]	HD1/HD4/HD5/HD6/HD7/HD8	15	15				
541	AS[YHEG3_P1]	PAL1-RF/multi	15	15				
542	EU[YHEG0_E_P1]	PAL1-RF/multi	15	15				
543	Horizontal DSB Gain for Y/G [YHDSBG0_P1]	NTSC/PAL/multi	3	2				
544	[YHDSBG1_P1]	HD2/HD3/HD9/HD10	3	0				
545	[YHDSBG2_P1]	HD1/HD4/HD5/HD6/HD7/HD8	3	2				
546	Horizontal DSB Coaring for Y/G [YHDSBC0_P1]	NTSC/PAL/multi	7	7				
547	[YHDSBC1_P1]	HD	7	7				
548	Horizontal Enhancer Clip for Y/G [YHDSBC0_P1]	NTSC/PAL/multi	1	0				
549	[YHDSBC1_P1]	HD	1	0				
550	Horizontal Clip Offset Level for Y/G AS[YHCLP0_P1]	RF/multi	15	4				
551	AS[YHCLP1_P1]	except NT1-RF/PAL1-except RF	15	4				
552	[YHECLP2_P1]	HD	15	5				
553	EU[YHECLP0_E_P1]	RF/multi	15	4				
554	EU[YHECLP1_E_P1]	NT1-except RF/PAL1-except RF	15	4				
555	Horizontal Non Linear Peaking for Y/G [YHNL0_P1]	NTSC/PAL/multi	63	0				
556	[YHNL1_P1]	HD	63	0				
557	Coring Amplitude for Y/G [YCOR0_P1]	NT1-RF/PAL1-RF/multi	7	7				
558	[YCOR1_P1]	NT1-video/PAL1-video	7	4				
559	[YCOR2_P1]	NT2/NT3/NT4/PAL2/PAL3/PAL4	7	3				
560	[YCOR3_P1]	HD2/HD3/HD9/HD10	7	2				
561	[YCOR4_P1]	HD1/HD4/HD5/HD6/HD7/HD8	7	4				
562	Vertical enhancer Gain for B-Y/B, R-Y/R [CVEG0]	NTSC/PAL/multi	15	15				
563	[CVEG1]	HD	15	9				

28LD5200E (PW1L)

O : Should be adjusted
 Δ : Should be followed previous data

ADJ. No.	Function		Maximum Value	Default	Changed Component			
	Adjustment Items	Mode			Formatter PWB	VIDEO PWB	TUNER PWB	LCD PANEL
564	DSB Gain of Vertical for B-Y/B, R-Y/R [CVDSBG0]	NTSC/PAL/multi	3	0				
565	[CVDSBG1]	HD	3	0				
566	DSB coring of Vertical for B-Y/B, R-Y/R [CVDSBC0]	NTSC/PAL/multi	7	0				
567	[CVDSBC1]	HD	7	0				
568	Vertical enhancer Clip for B-Y/B, R-Y/R [CVECLP0]	NTSC/PAL/multi	1	0				
569	[CVECLP1]	HD	1	0				
570	Horizontal HPF Peak Freq. SW for B-Y/B, R-Y/R [CHHPF0]	NTSC/PAL/multi	3	2				
571	[CHHPF1]	HD	3	2				
572	Horizontal Enhancer Gain for B-Y/B, R-Y/R [CHEG0]	NTSC/PAL/multi	15	15				
573	[CHEG1]	HD	15	9				
574	Horizontal DSB Gain for B-Y/B, R-Y/R [CHDSBG0]	NTSC/PAL/Multi Picture	3	0				
575	[CHDSBG1]	HD	3	0				
576	Horizontal DSB Coring for B-Y/B, R-Y/R [CHDSBC0]	NTSC/PAL/Multi Picture	7	0				
577	[CHDSBC1]	HD	7	0				
578	Horizontal Enhancer Clip for B-Y/B, R-Y/R [CHECLP0]	NTSC/PAL/Multi Picture	1	0				
579	[CHECLP1]	HD	1	0				
580	Coring Amplitude for B-Y/B, R-Y/R [CC0R0]	NTSC/PAL/Multi Picture	7	1				
581	[CC0R1]	HD	7	1				
582	B-Y Clamp offset [Except D Sub Component]	NT1/2/3,HD2/3,PAL1/2/3,HD9/10	255	128				
583	R-Y Clamp offset [Except D Sub Component]	NT1/2/3,HD2/3,PAL1/2/3,HD9/10	255	128				
584	B-Y Clamp offset [Except D Sub Component]	HD1/4,HD7/8	255	128				
585	R-Y Clamp offset [Except D Sub Component]	HD1/4,HD7/8	255	128				
586	B-Y Clamp offset [Except D Sub Component]	HD5/6	255	128				
587	R-Y Clamp offset [Except D Sub Component]	HD5/6	255	128				
588	B-Y Clamp offset [D Sub Component]	NT1/2/3,HD2/3,PAL1/2/3,HD9/10	255	128				
589	R-Y Clamp offset [D Sub Component]	NT1/2/3,HD2/3,PAL1/2/3,HD9/10	255	128				
590	B-Y Clamp offset [D Sub Component]	HD1/4,HD7/8	255	128				
591	R-Y Clamp offset [D Sub Component]	HD1/4,HD7/8	255	128				
592	B-Y Clamp offset [D Sub Component]	HD5/6	255	128				
593	R-Y Clamp offset [D Sub Component]	HD5/6	255	128				
594	B-Y Clamp offset [DVI-STB]	480i/576i/480p/576p/VGA	255	128				
595	R-Y Clamp offset [DVI-STB]	480i/576i/480p/576p/VGA	255	128				
596	B-Y Clamp offset [DVI-STB]	1080i-50/1080i-60	255	128				
597	R-Y Clamp offset [DVI-STB]	1080i-50/1080i-60	255	128				
598	B-Y Clamp offset [DVI-STB]	720p-60	255	128				
599	R-Y Clamp offset [DVI-STB]	720p-60	255	128				
600	Y OUT LEVEL M (4.5) For Asia	Main	63	15				
601	Y OUT LEVEL B/G (5.5) For Asia	Main	63	13				
602	Y OUT LEVEL D/K (6.5) For Asia	Main	63	16				
603	Y OUT LEVEL I (6.0) For Asia	Main	63	14				
604	Y OUT LEVEL B/G (5.5) For Europe	Main	63	13				
605	Y OUT LEVEL D/K (6.5) For Europe	Main	63	16				
606	Y OUT LEVEL I (6.0) For Europe	Main	63	19				
607	Y OUT LEVEL L (6.5) For Europe	Main	63	13				
608	Y OUT LEVEL L' (6.1) For Europe	Main	63	12				
609	Y OUT LEVEL M (4.5) For US	Main	63	13				
610	C OUT LEVEL M (4.5) For Asia	Main	63	7				
611	C OUT LEVEL B/G (5.5) For Asia	Main	63	13				
612	C OUT LEVEL D/K (6.5) For Asia	Main	63	13				
613	C OUT LEVEL I (6.0) For Asia	Main	63	13				
614	C OUT LEVEL B/G (5.5) For Europe	Main	63	8				
615	C OUT LEVEL D/K (6.5) For Europe	Main	63	8				
616	C OUT LEVEL I (6.0) For Europe	Main	63	3				
617	C OUT LEVEL L (6.5) For Europe	Main	63	8				
618	C OUT LEVEL L' (6.1) For Europe	Main	63	8				
619	C OUT LEVEL M (4.5) For US	Main	63	13				
620	Y OUT LEVEL M (4.5) For Asia	Sub	63	14				
621	Y OUT LEVEL B/G (5.5) For Asia	Sub	63	13				
622	Y OUT LEVEL D/K (6.5) For Asia	Sub	63	15				
623	Y OUT LEVEL I (6.0) For Asia	Sub	63	13				
624	Y OUT LEVEL B/G (5.5) For Europe	Sub	63	13				
625	Y OUT LEVEL D/K (6.5) For Europe	Sub	63	16				
626	Y OUT LEVEL I (6.0) For Europe	Sub	63	20				
627	Y OUT LEVEL L (6.5) For Europe	Sub	63	13				
628	Y OUT LEVEL L' (6.1) For Europe	Sub	63	13				
629	Y OUT LEVEL M (4.5) For US	Sub	63	13				
630	C OUT LEVEL M (4.5) For Asia	Sub	63	7				
631	C OUT LEVEL B/G (5.5) For Asia	Sub	63	13				
632	C OUT LEVEL D/K (6.5) For Asia	Sub	63	13				
633	C OUT LEVEL I (6.0) For Asia	Sub	63	13				
634	C OUT LEVEL B/G (5.5) For Europe	Sub	63	13				
635	C OUT LEVEL D/K (6.5) For Europe	Sub	63	13				
636	C OUT LEVEL I (6.0) For Europe	Sub	63	13				
637	C OUT LEVEL L (6.5) For Europe	Sub	63	13				
638	C OUT LEVEL L' (6.1) For Europe	Sub	63	13				
639	C OUT LEVEL M (4.5) For US	Sub	63	13				
640	Contrast Center (CM) ((Contrast Offset (CM) for only WVGA& LCD model))	DVI-PC	254	128				
641	Contrast Center (CM) ((Contrast Offset (CM) for only WVGA& LCD model))	DVI-STB (With Setup)	254	149				
642	Contrast Center (CM) ((Contrast Offset (CM) for only WVGA& LCD model))	DVI-STB (Without Setup)	254	128				
643	Contrast Center (CM) ((Contrast Offset (CM) for only WVGA& LCD model))	DSUB-RGB	254	128				
644	Contrast Center (CM) ((Contrast Offset (CM) for only WVGA& LCD model))	Expand DSUB-RGB (Reserved)	254	128				
645	Contrast Center (CM) ((Contrast Offset (CM) for only WVGA& LCD model))	DSUB-COMP	254	137				
646	Brightness Center (CM)	DVI-PC	254	128				
647	Brightness Center (CM)	DVI-STB	254	128				
648	Brightness Center (CM)	DSUB-RGB	254	128				
649	Brightness Center (CM)	Expand DSUB-RGB (Reserved)	254	128				
650	Brightness Center Offset	DSUB-COMP	254	127				
651	Color Center (CM)	DVI-PC	127	64				
652	Color Center (CM)	DVI-STB (480i/576i/480p/576p)	127	62				
653	Color Center (CM)	DVI-STB (720p-60/1080i-60/1080i-50)	127	62				
654	Color Center (CM)	DVI-STB (VGA)	127	62				
655	Color Center (CM)	DSUB-RGB	127	64				
656	Tint Center (CM)	DVI-PC	254	128				
657	Tint Center (CM)	DVI-STB (480i/576i/480p/576p)	254	128				

28LD5200E (PW1L)

O : Should be adjusted
 Δ : Should be followed previous data

ADJ. No.	Function		Maximum Value	Default	Changed Component			
	Adjustment Items	Mode			Formatter PWB	VIDEO PWB	TUNER PWB	LCD PANEL
658	Tint Center (CM)	DVI-STB (720p-60/1080i-60/1080i-50)	254	128				
659	Tint Center (CM)	DVI-STB (VGA)	254	128				
660	Tint Center (CM)	DSUB-RGB	254	128				
661	Center of Sharpness (HV Enhance Gain for Y)	DVI-STB (480i/576i)	31	14				
662	Center of Sharpness (HV Enhance Gain for Y)	DVI-STB (480p/576p)	31	10				
663	Center of Sharpness (HV Enhance Gain for Y)	DVI-STB (720p-60)	31	6				
664	Center of Sharpness (HV Enhance Gain for Y)	DVI-STB (1080i-60/1080i-50)	31	10				
665	Center of Sharpness (HV Enhance Gain for Y)	DVI-STB (VGA)	31	10				
666	DVI-STB Setup 0:None VGA/Others Yes, 1:All none 2:All have	DVI-STB mode	2	0				
667	HSYNC De-Jitter 0:Low (Disabled), 1:(High (Enabled)	DVI-PC	1	0				
668	HSYNC De-Jitter 0:Low (Disabled), 1:(High (Enabled)	DVI-STB	1	0				
669	HSYNC De-Jitter 0:Low (Disabled), 1:(High (Enabled)	AVC	1	0				
670	Offset level of Horizontal CLIP for Y/G AS[YHCECLPL3_P0]	NT2-4/PAL2-4	15	10				
671	EU[YHCECLPL3_E_P0]	NT2-4/PAL2-4	15	10				
672	Offset level of Horizontal CLIP for Y/G AS[YHCLPL3_P1]	NT2-4/PAL2-4	15	15				
673	EU[YHCECLPL3_E_P1]	NT2-4/PAL2-4	15	15				
674	Y_DL (4.5MHz) For US	Main	10	7				
675	Y_DL (4.6MHz) For US	Sub	10	7				
676	Y_DL (5.5MHz PAL/NTSC4.43) For Europe	Main	10	4				
677	Y_DL (5.5MHz SECAM) For Europe	Main	10	1				
678	Y_DL (6.0PAL/NTSC4.43) For Europe	Main	10	8				
679	Y_DL (6.0SECAM) For Europe	Main	10	5				
680	Y_DL (5.5MHz PAL/NTSC4.43) For Europe	Sub	10	2				
681	Y_DL (5.5MHz SECAM) For Europe	Sub	10	0				
682	Y_DL (6.0PAL/NTSC4.43) For Europe	Sub	10	4				
683	Y_DL (6.0SECAM) For Europe	Sub	10	0				
684	Y_DL (6.5MHz PAL/NTSC4.43) For Europe	Main	10	5				
685	Y_DL (6.5MHz SECAM) For Europe	Main	10	5				
686	Y_DL (6.5MHz PAL/NTSC4.43) For Europe	Sub	10	2				
687	Y_DL (6.5MHz SECAM) For Europe	Sub	10	0				
688	Center of Sharpness (HV Enhancer Gain for Y) For Asia/US	TV	31	15				
689	Center of Sharpness (HV Enhancer Gain for Y) For Asia/US	VIDEO	31	15				
690	Center of Sharpness (HV Enhancer Gain for Y) For Asia/US	HD5/HD6	31	6				
691	Center of Sharpness (HV Enhancer Gain for Y) For Asia/US	HD1/HD4/HD7/HD8	31	10				
692	Center of Sharpness (HV Enhancer Gain for Y) For Asia/US	HD2/HD3/HD9/HD10	31	10				
693	Center of Sharpness (HV Enhancer Gain for Y) For Asia/US	NT2/NT3/PAL2/PAL3/NT4/PAL4	31	14				
694	Center of Sharpness (HV Enhancer Gain for Y) For Asia/US	TEXT(2pictures)	31	15				
695	Contrast mode-Dynamic> SW (TV) 0:Dynamic 1:Dynamic+Auto	TV	1	1				
696	V detection(FORMATTER PWB) 0:out of range 128: NO V (or out of spec) 255:interrupt	50/60Hz	255	-				
697	H detection(FORMATTER PWB) 0:out of range 128: NO V (or out of spec) 255:interrupt	15/28/31/33/45kHz	255	-				
698	V detection (VIDEO PWB) 0:out of range 128:NO V 255 interrupt	50/60Hz	255	-				
699	H detection (VIDEO PWB) 0:out of range 128:NO V 255 interrupt	15/28/31/33/45kHz	255	-				
700	Q mode 0:Freeze, 1:Move 1, 2:Move 2 For 55V	50Hz[Natural/Night] mode	2	1				
701	Q mode 0:Freeze, 1:Move 1, 2:Move 2 For 55V	60Hz[Natural/Night] mode	2	1				
702	Dispersion Time of Sustain current 0: 2 Times, 1: 4 times	For PC-Movie mode	1	1				
703	SMPLING	For CCD	255	0				
704	POLLING	For CCD	255	15				
705	START	For CCD	7	2				
706	TIMEOUT	For CCD	30	5				
707	STATUS	For CCD	7	2				
708	CCD-HP	For CCD	79	40				
709	CCD-CLK	For CCD	79	57				
710	Sharpness Gain	For Main 480i/576i	15	10				
711	Sharpness EQ	For Main 480i/576i	3	1				
712	Sharpness f0	For Main 480i/576i	3	1				
713	Cb Offset1	For Main 480i/576i	15	8				
714	Cr Offset1	For Main 480i/576i	15	8				
715	Y out level	For Main 480i/576i	63	15				
716	C out level	For Main 480i/576i	63	15				
717	Sharpness Gain	For Sub 480i/576i	15	10				
718	Sharpness EQ	For Sub 480i/576i	3	1				
719	Sharpness f0	For Sub 480i/576i	3	1				
720	Cb Offset1	For Sub 480i/576i	15	8				
721	Cr Offset1	For Sub 480i/576i	15	8				
722	Y out level	For Sub 480i/576i	63	15				
723	C out level	For Sub 480i/576i	63	15				
724	Offset value of adjusted TINT for impact to No.42-45	For COMPAL factory	20	11				
725	Use item No.724 0:No, 1:Yes	For COMPAL factory	1	0				
726	Free		-	-				
727	Free		-	-				
728	Free		-	-				
729	Free		-	-				
730	Free		-	-				
731	Free		-	-				
732	Free		-	-				
733	Free		-	-				
734	Free		-	-				
735	Free		-	-				
736	Free		-	-				
737	Free		-	-				
738	Free		-	-				
739	Free		-	-				
740	Gain adjustment of RGB amplifier (FLAON)	Main	-	-	O			O
741	Gain adjustment of RGB amplifier	Sub	-	-	O			O
742	Automatic White Peak Adj.	Single Picture mode	-	-	O			O
743	Automatic White Peak Adj.	Multi Picture mode	-	-	O			O
744	EEPROM Initialize(0:No, 1:Yes)		1	0				
745	Enter to service menu of sub mi-con		-	-				

28LD5200E (PW1L)

● The Expression of input signal mode (format)

PAL1: RF, S and Composite of PAL/SECAM

PAL2: Component of PAL (YCBCR)

PAL3: Component of PAL (YPBPR)

PAL4: Component of PAL (YCBCR-SCART)

PAL: PAL1-4

NT1: S and Composite of NTSC

NT2: Component of NTSC (YCBCR)

NT3: Component of NTSC (YPBPR)

NT4: Component of NTSC (YCBCR-SCART)

NTSC: NTSC1-4

HD1-6: Component (shown in the table→)

HD7: Component of 1080i/50 (YPBPR)

HD8: Component of 1080i/50 (YCBCR)

HD9: Component of 576p (YPBPR)

HD10: Component of 576p (YCBCR)

HD: HD1-10 of Component

TV: NTSC / HD

PC: PC signal

Video Input	System	Judgment of H.Frequency	Video Input Setup	Mode
AV1 AV2	PAL	15.75kHz (576i)	Auto	PAL2
			SDTV/DVD	PAL2
			HDTV	PAL3
	NTSC	15.75kHz (480i)	Auto	NT2
			SDTV/DVD	NT2
			HDTV	NT3
	PAL	31.25kHz (576p)	Auto	HD10
			SDTV/DVD	HD10
			HDTV	HD9
	NTSC	31.50kHz (480p)	Auto	HD3
			SDTV/DVD	HD3
			HDTV	HD2
	NTSC	45.00kHz (720p)	Auto	HD5
			SDTV/DVD	HD6
			HDTV	HD5
PAL	28.125kHz (1080i)	Auto	HD7	
		SDTV/DVD	HD8	
		HDTV	HD7	
NTSC	33.75kHz (1080i)	Auto	HD1	
		SDTV/DVD	HD4	
		HDTV	HD1	

● Factory Reset

After all of the adjustments of main chassis are finished, perform FACTORY RESET.

Press the SUB-POWER(⏻) button, INPUT SELECT(↵) button and ▲ button at the same time, and hold for more than 5 seconds.

The unit is set to factory settings.

28LD5200E (PW1L)

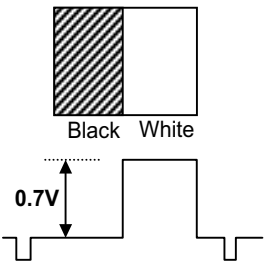
Item	AUTOMATIC SIGNAL LEVEL ADJUSTMENT –RGB (1)	
	Preparation	Procedure
(1)	Input the adjustment signal of VGA (60Hz) format into RGB2 [D-sub] input terminal. <u>the adjustment signal</u> <div style="border: 1px dashed black; padding: 5px; margin: 10px auto; width: fit-content;"> <p style="font-size: small;">The signal level of black area should be pedestal level. This signal must not be inserted characters etc.</p> <div style="text-align: center;">  </div> </div>	(1) Select RGB2 and enter the service adjustment mode. (2) Select No.740 “RGB Amp. Gain ADJ.” and press OK button for more than 2 seconds to start the adjustment. It will complete the adjustment after the OSD of “AUTO MODE” disappeared.

[Note] Never adjust without use of the specified signal.

If that were done by mistake, the picture would become abnormal in black level, contrast and color. In this case, it will be recovered by re-adjustment in the specified way.

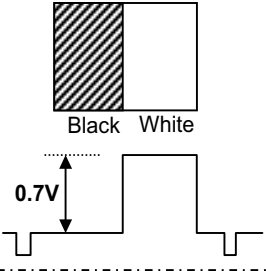
Item	AUTOMATIC SIGNAL LEVEL ADJUSTMENT –RGB (2)	
	Preparation	Procedure
(1)	Input the adjustment signal of 576p or 480p format into AV1 input terminal. <u>the adjustment signal</u> <div style="border: 1px dashed black; padding: 5px; margin: 10px auto; width: fit-content;"> <p style="font-size: small;">The signal level of black area should be pedestal level. This signal must not be inserted characters etc.</p> <div style="text-align: center;">  </div> </div>	(1) Select AV1 and enter the service adjustment mode. (2) Select No.740 “RGB Amp. Gain ADJ.” and press OK button for more than 2 seconds to start the adjustment. It will complete the adjustment after the OSD of “AUTO MODE” disappeared. (3) Select No.741 “RGB Amp. Gain ADJ.” and press OK button for more than 2 seconds to start the adjustment. It will complete the adjustment after the OSD of “AUTO MODE” disappeared.

[Note] Never adjust without use of the specified signal.

If that were done by mistake, the picture would become abnormal in black level, contrast and color. In this case, it will be recovered by re-adjustment in the specified way.

28LD5200E (PW1L)

Item	COLOR TEMPERATURE ADJUSTMENT -VIDEO	
	Preparation	Procedure
(1)	Set CRT COLOR ANALYZER(CA-210) at the center of the screen panel.	<p>[Adjustment of Cool mode]</p> <p>(1) Enter the service adjustment mode, and confirm that Adjustment NO 0,1 are set as 230. NO2 is set as 255. If initial x and y value are larger than specification, No.0:R drive(cool) will be adjusted(decrease from 230) No.1:G drive(cool) will be adjusted(decrease from 230) No.2:B drive(cool) is set as 255</p> <p>(2) If initial x or y value is smaller than specification. No2:B drive(cool) will be adjusted(decrease from 255), until one of x,y is in spec and another value is higher than spec. (* When both x and y are in spec value, it is end of adjustment)</p> <p>(3) According to a x and y value, the following adjustment of (3)-1 or (3)-2. (3)-1 If x value is higher than spec. No.0:R drive(cool) will be adjusted(decrease from 230) (3)-2 If y value is higher than spec, No1:G drive(cool) will be adjusted(decrease from 230) * No.0:R or No.1:F should be set as 230</p> <div style="border: 1px dashed black; padding: 5px; margin: 5px 0;"> <p style="text-align: center;"><Specification> Color Temperature (Cool) for Video 25000K-6MCD x=0.257 ± 0.005 y=0.256 ± 0.005</p> </div> <p>[Adjustment of Normal mode] No Adjustment. (11000K) Adjustment No.3,4 and 5 are set as 230.</p> <p>[Adjustment of Warm mode]</p> <p>(4) Enter the service adjustment mode, and confirm that Adjustment NO.6,7 and 8 are all set as 230. In factory setting mode No.8:B drive(warm) will be adjusted(decrease from 230), until one of x,y is in spec and another value is higher than spec. (* When both x and y are in spec value, it is end of adjustment)</p> <p>(5) According to x and y value, the following adjustment of (5)-1 or (5)-2. (5)-1 If x value is higher than spec. No.6:R drive(warm) will be adjusted(decrease from 230) (5)-2 If y value is higher than spec, No7:G drive(warm) will be adjusted(decrease from 230) No.6 or No.7:F should be set as 230.</p> <div style="border: 1px dashed black; padding: 5px; margin: 5px 0;"> <p style="text-align: center;"><Specification> Color Temperature (Warm) for Video 7500K x=0.302 ± 0.005 y=0.317 ± 0.005</p> </div> <p>[Adjustment of Black / White mode]</p> <p>(6) Enter the service adjustment mode, and confirm Adjustment NO.9,10 and 11 are all set as 230. In factory setting mode No.11:B drive(B/W) will be adjusted(decrease from 230), until one of x,y is in spec and another value is higher than spec. (* When both x and y are in spec value, it is end of adjustment.)</p> <p>(7) According to x and y value, the following adjustment of (7)-1 or (7)-2. (7)-1 If x value is higher than spec. No.9:R drive(B/W) will be adjusted(decrease from 230)</p> <p>(7)-2 If y value is higher than spec, No.10:G drive(B/W) will be adjusted(decrease from 230) No.9 or No.10: should be set as 230.</p> <div style="border: 1px dashed black; padding: 5px; margin: 5px 0;"> <p style="text-align: center;"><Specification> Color Temperature (B/W) for Video 5400K x=0.335 ± 0.005 y=0.343 ± 0.005</p> </div>
(2)	Input the full-white raster signal to AV1 component terminal and select AV1. <u>Signal condition</u> 480i component Video level: 0.56Vp-p Sync level: 0.286Vp-p Setup level: 0V	
(3)	Set the display size to "Full". Set the Contrast mode of picture menu "Auto". Set the Picture mode of Picture menu "Dynamic".	

5. Troubleshooting

● How to get to Burn-in mode

This mode displays the test patterns of some single color raster in turn. These signals are from built-in generator of LCD monitor.

Using the front control buttons with the set turned off (standby) can activate this mode.

Press the SUB-POWER(⏻) button, INPUT SELECT(↺) button and VOLUME DOWN(⏮) button at the same time, and hold for more than 5 seconds.

The set turns on with single color raster and the OSD of [BURN IN: ON].

To escape from this mode, press the SUB-POWER(⏻) button, INPUT SELECT(↺) button and ▲ button at the same time, and hold for more than 5 seconds. Burn-in mode will be released.

● How to recover the remote and front key function

If remote and front key cannot operate after miss set special function by front keys, these functions can recover by below method.

Press the SUB-POWER(⏻) button, INPUT SELECT(↺) button and ► button at the same time, and hold for more than 5 seconds.

The set turns on the service menu mode.

Select No.175 and data set from [0] to [1].

Or

Press the SUB-POWER(⏻) button and ► button at the same time, and hold for more than 5 seconds

28LD5200E (PW1L)

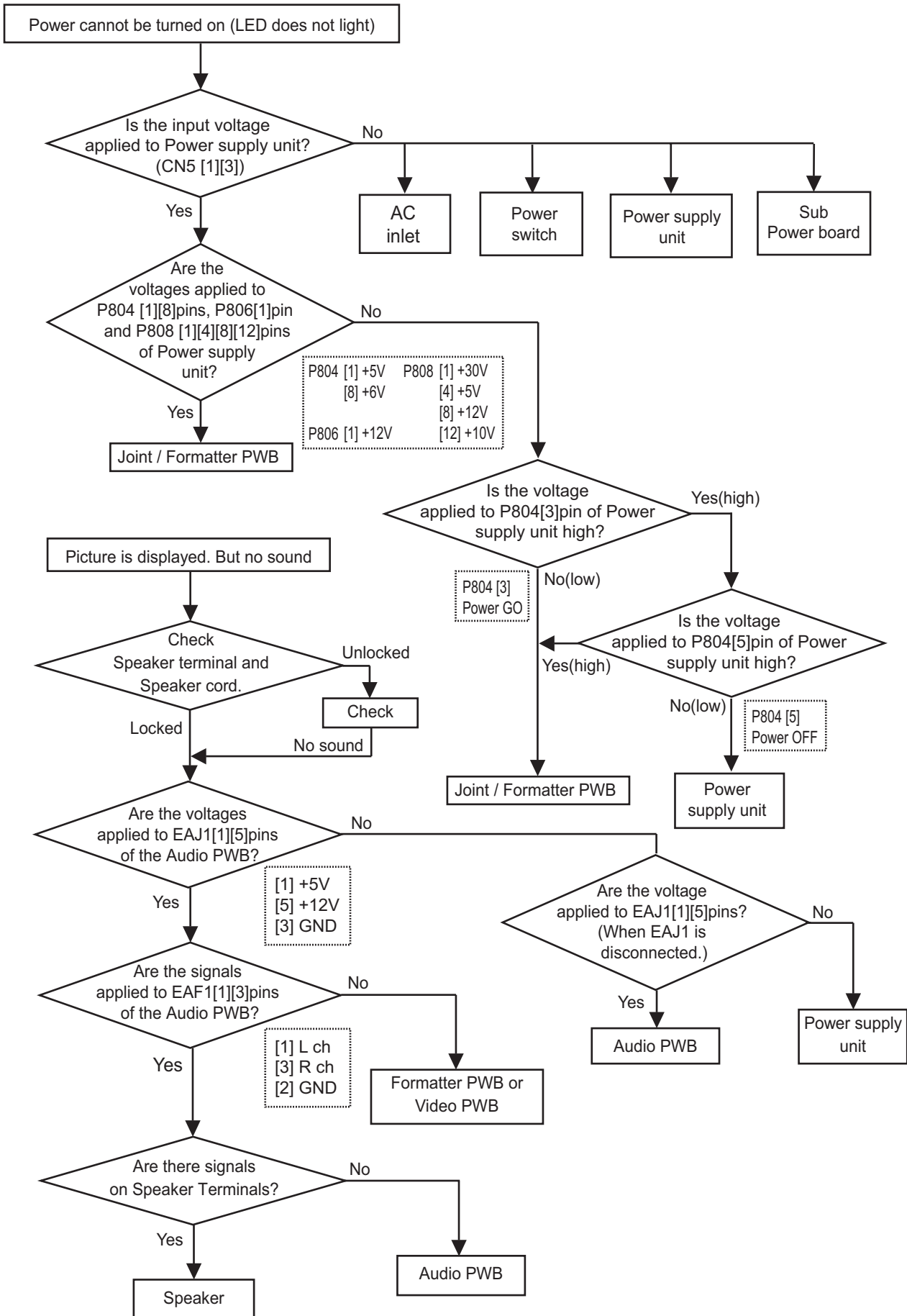

28LD5200E (PW1L)

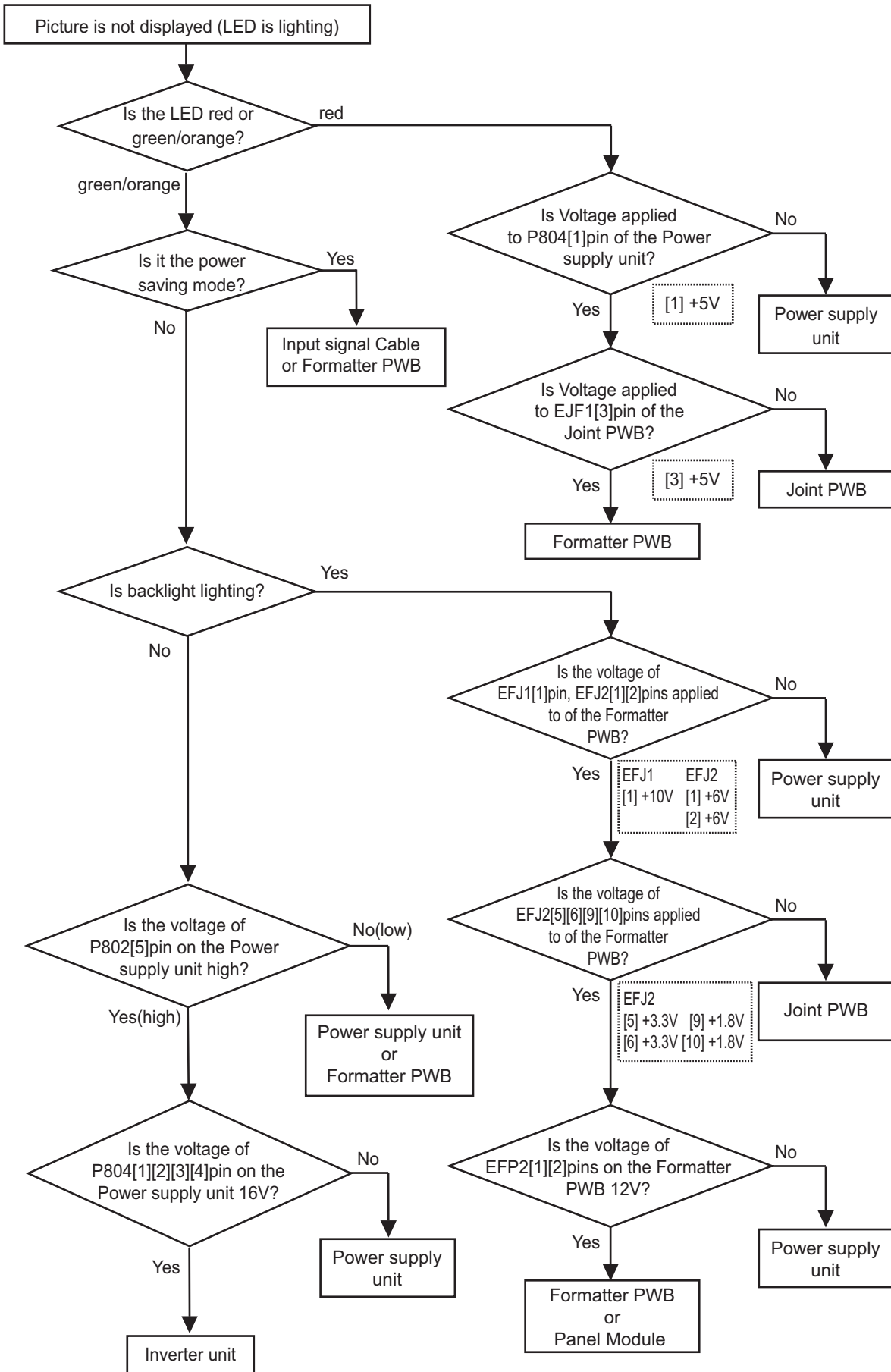

6. Self-Diagnosis Function

Signal circuit check mode: It indicates the check result on some points of the signal circuit and the history of them with On-Screen Display (OSD).

● Signal circuit self-diagnosis function

This function is for the failure of the signal circuit, for example the phenomenon as below:

"Sometimes power turns off abnormally." "Sometimes picture disappears abnormally."

To enter to this Self-Diagnosis mode, follow the next steps:

Preparation:

- 1) The Power Cord should be connected to AC line and the Main Power switch should be turned on.
- 2) Turn the power off by the SUB-POWER(⏻) button of the monitor or the remote control.

Procedure:

- 1) Press the SUB-POWER(⏻) button and ▲ button on the bottom of the monitor at the same time, and keep it for more than 5 seconds after the power turned on.
- 2) The monitor will be turned on, and it will display On-Screen Display of the Self-check result and the failure history as below.
- 3) Any operation would cancel the Self -Diagnosis mode.
- 4) The following table shows the OSD symbols and contents of failure PWB in which failure most probably would be allocated according to the number of blinks.

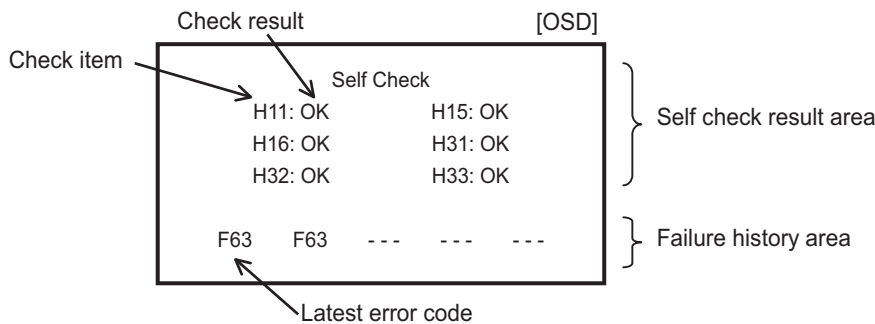

Code	stored up in failure history	Self checking item	Problem	Phenomenon	Cause
C10*	—	—	No sync. (Snow noise)	OSD of " ! Check Antenna " appears.	No connection of ANT cable Preset tuning is not yet
H11*	—	○	Tuner problem	Cannot receive the main signal from antenna	Communication error of U101
H15	—	○	Composite video SW IC problem	Cannot receive picture and audio Cannot change input mode	Communication error of I201
H16	—	○	Component video SW IC problem	No component picture Cannot change input mode	Communication error of I202
H31	—	○	Color demodulator IC problem	Abnormal color Dark picture	Communication error of I501
H32	—	○	Sync. separator IC problem	Unsynchronized picture	Communication error of I601
H33	—	○	3D Y/C separator IC problem	Abnormal color Dark picture / No picture	Communication error of I302
H71*	—	○	T/Text IC problem	No T/Text No picture	Communication error of IT01
H72*	—	○	Sound MPX IC problem	No sound from antenna Cannot change MPX sound	Communication error of IN01
F63	○	—	I ² C-bus latch problem	Cannot store setting data (Ex. Channel, Volume etc.)	SCL3/SDA3 latched up

*) This code is no meaning for the models except 32/42PD5000TA because those are without tuner circuit.

If you clear history of failure, make FACTORY RESET: enter the factory setting mode; press the SUB-POWER(⏻) button, INPUT SELECT(↺) button and ▲ button on the bottom of the monitor at the same time. And keep it for more than 5 seconds after the power turned on.

**THE UPDATED PARTS LIST
FOR THIS MODEL IS
AVAILABLE ON ESTA**

8. Block diagram

Block diagram 1/2

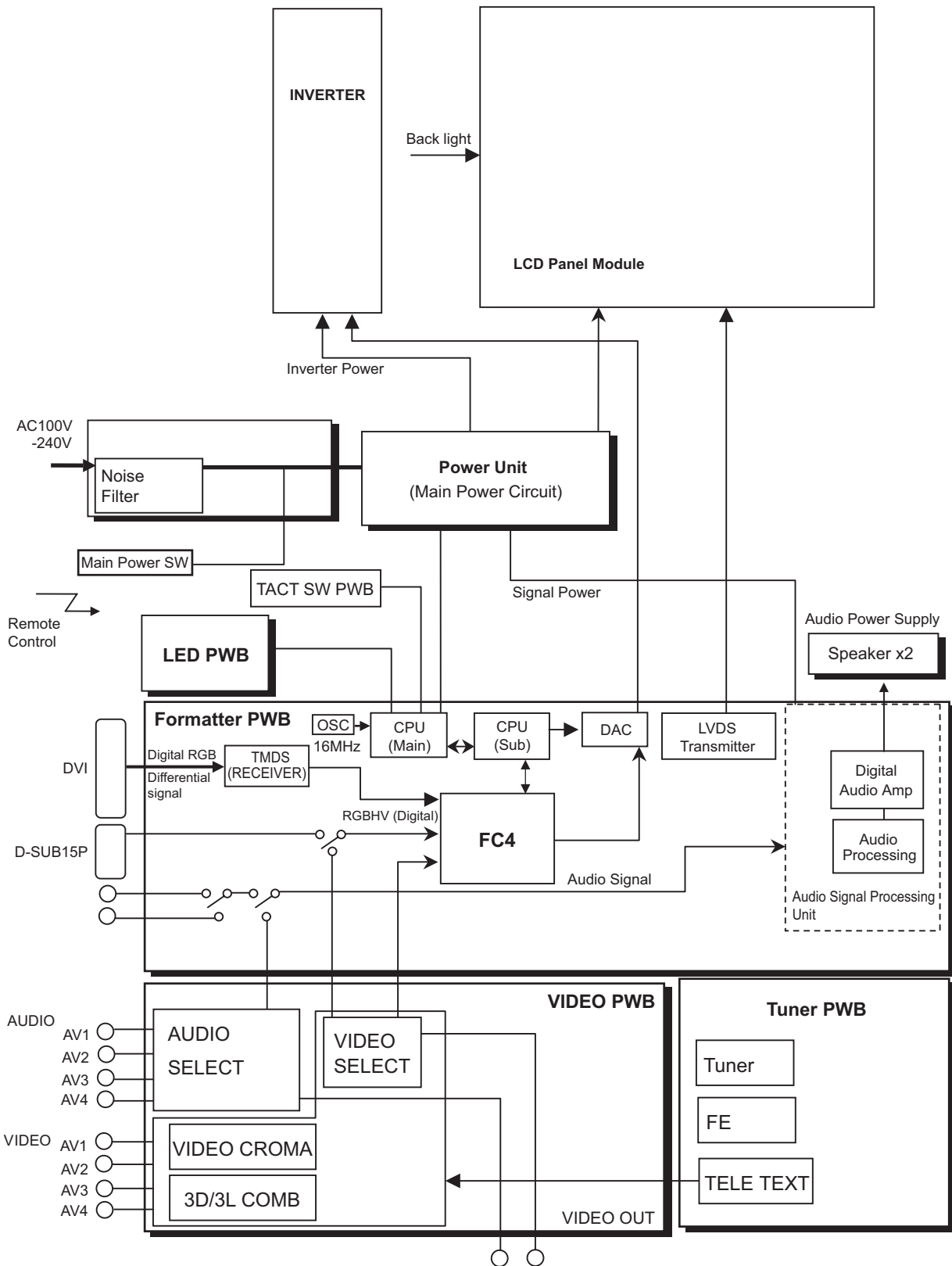

9. Connection diagram

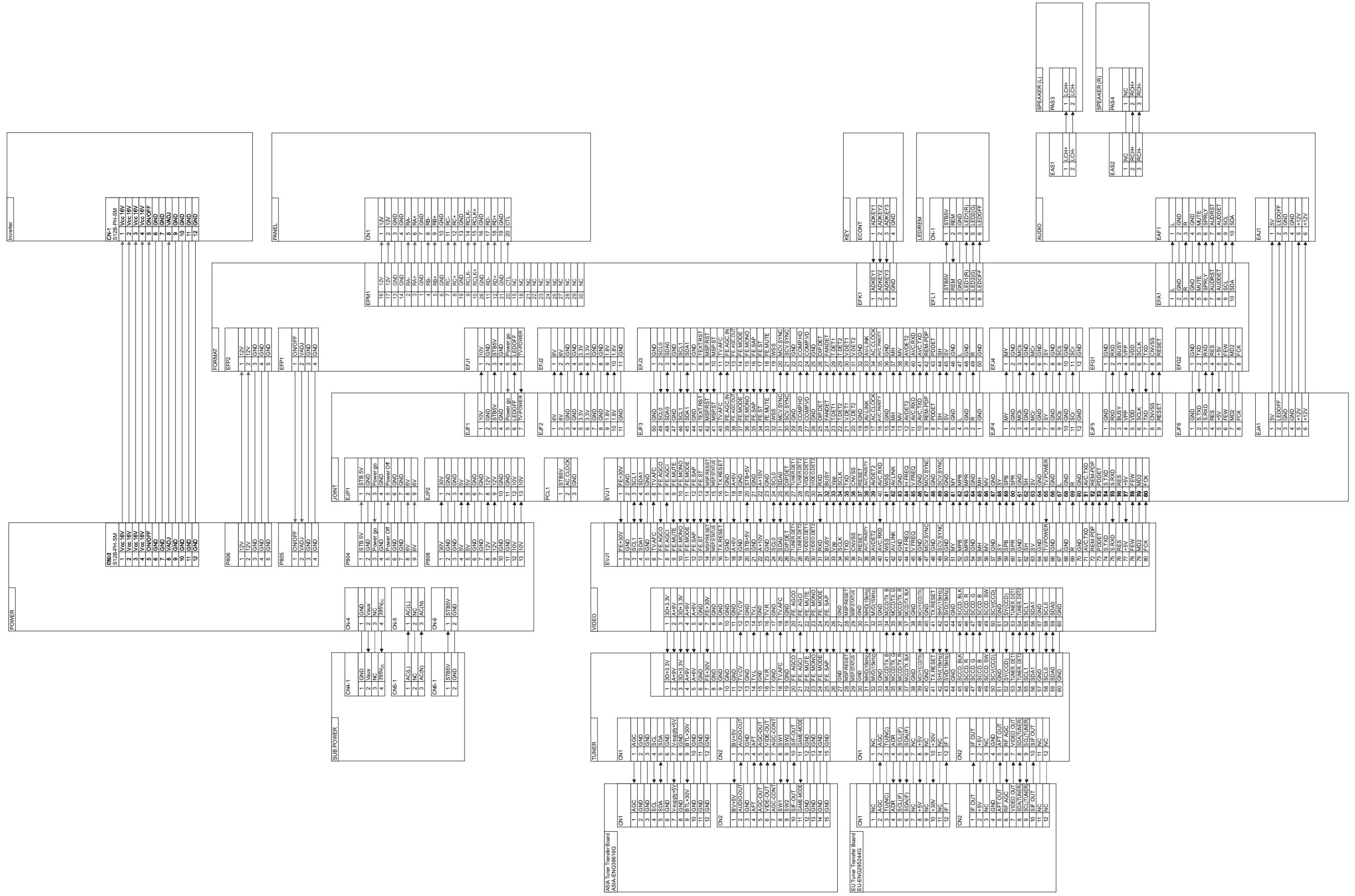

11. Disassembly diagram

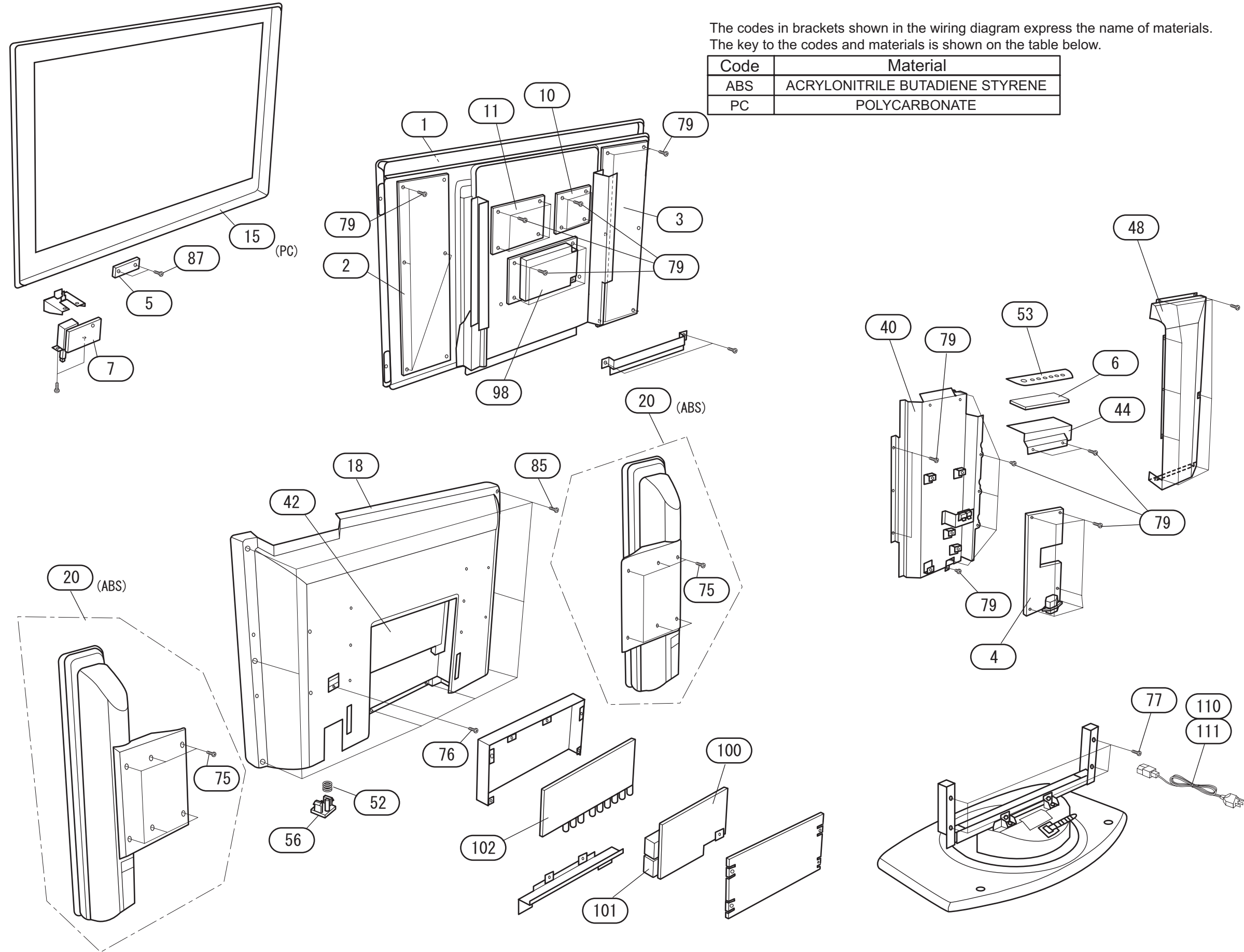

The codes in brackets shown in the wiring diagram express the name of materials.
The key to the codes and materials is shown on the table below.

Code	Material
ABS	ACRYLONITRILE BUTADIENE STYRENE
PC	POLYCARBONATE

HITACHI

Hitachi, Ltd. Tokyo, Japan
International Sales Division
THE HITACHI ATAGO BUILDING,
No. 15-12 Nishi Shinbashi, 2 - Chome,
Minato - Ku, Tokyo 105-8430, Japan.
Tel: 03 35022111

HITACHI EUROPE LTD,

Whitebrook Park
Lower Cookham Road
Maidenhead
Berkshire
SL6 8YA

UNITED KINGDOM

Tel: 01628 643000
Fax: 01628 643400
Email: consumer-service@hitachi-eu.com

HITACHI EUROPE S.A.

364 Kifissias Ave. & 1, Delfon Str.
152 33 Chalandri
Athens

GREECE

Tel: 1-6837200
Fax: 1-6835964
Email: service.hellas@hitachi-eu.com

HITACHI EUROPE GmbH

Munich Office
Dornacher Strasse 3
D-85622 Feldkirchen bei München

GERMANY

Tel: +49-89-991 80-0
Fax: +49-89-991 80-224
Hotline: +49-180-551 25 51 (12ct/min)
Email: HSE-DUS.service@hitachi-eu.com

HITACHI EUROPE S.A.

Gran Via Carlos III, 86, planta 5
Edificios Trade - Torre Este
08028 Barcelona

SPAIN

Tel: 93 409 2550
Fax: 93 491 3513
Email: atencion.cliente@hitachi-eu.com

HITACHI EUROPE srl

Via Tommaso Gulli N.39, 20147
Milano, Italia

ITALY

Tel: +39 02 487861
Tel: +39 02 38073415 Servizio Clienti
Fax: +39 02 48786381/2
Email: customerservice.italy@hitachi-eu.com

HITACHI Europe AB

Box 77 S-164 94 Kista

SWEDEN

Tel: +46 (0) 8 562 711 00
Fax: +46 (0) 8 562 711 13
Email: csgswe@hitachi-eu.com

HITACHI EUROPE S.A.S

Lyon Office
B.P. 45, 69671 BRON CEDEX

FRANCE

Tel: 04 72 14 29 70
Fax: 04 72 14 29 99
Email: france.consommateur@hitachi-eu.com

HITACHI EUROPE LTD (Norway) AB

STRANDVEIEN 18

1366 Lysaker

NORWAY

Tel: 67 5190 30
Fax: 67 5190 32
Email: csgnor@hitachi-eu.com

HITACH EUROPE AB

Egebækgård
Egebækvej 98
DK-2850 Nærum

DENMARK

Tel: +45 43 43 6050
Fax: +45 43 60 51
Email: csgnor@hitachi-eu.com

HITACHI EUROPE AB

Neopoli / Niemenkatu 73
FIN-15140 Lahti

FINLAND

Tel : +358 3 8858 271
Fax: +358 3 8858 272
Email: csgnor@hitachi-eu.com

Hitachi Europe Ltd

Bergensesteenweg 421
1600 Sint-Pieters-Leeuw

BELGIUM

Tel: +32 2 363 99 01
Fax: +32 2 363 99 00
Email: sofie.van.bom@hitachi-eu.com

HITACHI EUROPE LTD

Na Sychrove 975/8
101 27 Praha 10 - Bohdalec

CZECH REPUBLIC

Tel: +420 267 212 383
Fax: +420 267 212 385
Email: csgnor@hitachi-eu.com

www.hitachidigitalmedia.com

Free Manuals Download Website

<http://myh66.com>

<http://usermanuals.us>

<http://www.somanuals.com>

<http://www.4manuals.cc>

<http://www.manual-lib.com>

<http://www.404manual.com>

<http://www.luxmanual.com>

<http://aubethermostatmanual.com>

Golf course search by state

<http://golfingnear.com>

Email search by domain

<http://emailbydomain.com>

Auto manuals search

<http://auto.somanuals.com>

TV manuals search

<http://tv.somanuals.com>