

USER'S MANUAL
用戶手冊
用戶手冊

HITACHI
Inspire the Next

LCD Television

Model Name
26LD9000TA
32LD9000TA



READ THE INSTRUCTIONS INSIDE CAREFULLY.
KEEP THIS USER'S MANUAL FOR FUTURE REFERENCE
For future reference, record the serial number of your television.
SERIAL NO. _____
This serial number is located on the rear of the television.

HDMI™
HIGH-DEFINITION MULTIMEDIA INTERFACE

ENGLISH

USER'S MANUAL

Thank you for purchasing the HITACHI LCD Television.
Please read this user manual carefully before operating
this product.

To ensure proper operation, please read and follow ALL
the instructions, especially the "IMPORTANT SAFETY
INSTRUCTIONS" and "SAFETY PRECAUTIONS".
Please keep this user manual for future reference.

CONTENTS

About This Manual	3	Mute	20
Trademark Credits.....	3	Input Switching to TV/AV1~4, HDMI, and RGB.....	21
About Software.....	3	Input Signal Screen Display.....	21
SAFETY PRECAUTIONS	4	MENU OPERATION	22
About the Symbols	4	How to use the On-Screen Display (OSD) system	22
Cleaning and Maintenance.....	7	Language Menu	22
ABOUT LCD PANEL	8	Setup Menu (TV mode).....	23
Common phenomena of LCD Panel	8	Setup Menu (RGB mode)	25
Features	9	Picture Menu (TV mode).....	26
Supplied Accessories	9	Picture Menu (RGB mode).....	28
COMPONENT NAMES	10	Audio Menu	29
Main Unit	10	Timer Menu	30
Remote Control	11	FUNCTION.....	31
PREPARATION.....	12	About Teletext.....	31
Remote Control Batteries Installation.....	12	Size Switching.....	32
Caution When Moving the Main Unit.....	12	Audio Switching	34
Safety Precaution on Main Unit Installation	13	Power Save Mode.....	35
Anti-Tumble Measures	13	TROUBLESHOOTING.....	36
CONNECTION.....	14	When Following Messages Appear on the Screen....	36
Terminal Positions.....	14	Symptom and Check List.....	36
Connecting Procedure.....	14	PRODUCT SPECIFICATIONS	39
BASIC OPERATION	19	Signal Input	40
Power On/Off.....	19	Recommended Signal List.....	41
Volume Up/Down	20		

IMPORTANT SAFETY INSTRUCTIONS

- Read this instruction thoroughly.
- Retain this instruction for future reference.
- Heed all warnings and cautions to prevent possible danger.
- Follow all instructions. Improper handling could cause personal injury and/or serious damage to the unit that may shorten its service time.
- Do not block any ventilation openings.
- Install the product in accordance with the manufacture's instructions.
- Before calling for the technical support or service technician, read "TROUBLESHOOTING" (36~38) to determine the symptoms when problems occur during installation or operation of the product.
- If serious problems happen (such as smoke or an abnormal odor from the unit), turn off the Main Power, unplug the Power Cord, and then, contact your local dealer immediately.

INSTRUCTIONS

Thank you for purchasing the HITACHI LCD Television. We hope that you will enjoy the great performance with this product.

This LCD Television has been designed to meet the International standards. However, it could cause personal injuries and property damage if improperly handled. In order to prevent potential danger and obtain maximum benefit from your set, please observe the following instructions when installing, operating, and cleaning the product.

Keep this manual for future reference, and record the serial number of your set in the space provided on the front cover page of this manual.

ENGLISH

About This Manual

- The information in this manual is subject to change without notice.
- This manual has been created with extra care. In case that you have any comments or questions regarding this manual, please contact your local dealer or our Customer Service Center.
- Before operating this set, please fully understand the prerequisite such as specifications or constraints of the hardware and software. We are not responsible and have no liability for any loss, damage or injury as a result of misuse.
- Reproduction, copying, use, modification, and/or transmission in whole or in part of this manual are prohibited without any prior written permission
- All other products and company names used in this manual are trademarks or registered trademarks of their respective owners.

Trademark Credits

- VGA and XGA are trademarks of International Business Machines Corporation.
- APPLE and Macintosh are registered trademarks of Apple Computer Inc.
- VESA is a registered trademark of the Video Electronics Standard Association.
- HDMI, the HDMI logo and High-Definition Multimedia Interface are trademarks or registered trademarks of HDMI Licensing LLC.

Even if no special notation has been made of company or product trademarks, these trademarks have been fully respected.

About Software



You may not alter, decompile, disassemble, decrypt, or otherwise reverse-engineer the Software installed in this product, which are prohibited by law.



SAFETY PRECAUTIONS





For your safety, please read the following precautions carefully before using this product. Improper use would cause serious personal injuries and/or damage to your property or this product.

About the Symbols













The following are the symbols used in this manual and affixed on the unit itself. Please fully understand the meanings of the symbols before reading the precautions in this section.

	WARNING	Never ignore the instruction. There are risks of serious injuries or possible death to the user.
	CAUTION	Do not ignore the instruction. There are possibilities of personal injuries and/or property damage.

Other Symbols	
	The triangle with illustration is intended to alert the users that there are possibilities of fire, burst, or high temperature if the product is handled improperly. Each illustration within the triangle specifies the contents in detail. (The figure on the left is an example.)
	The circle with diagonal line and illustration is intended to prohibit the users from doing the indicated actions when handle the product. Each illustration within this symbol specifies the contents in detail. (The figure on the left is an example.)
	The blacked out circle with illustration is intended to constrain the users to follow the indicated actions when handle the product. Each illustration within this symbol specifies the contents in detail. (The figure on the left is an example.)















 WARNING	
There is a risk of fire, electric shock, or serious injury.	
<ul style="list-style-type: none"> ■ Unplug the power cord immediately when serious problems happen. <ul style="list-style-type: none"> ● Serious problems such as <ul style="list-style-type: none"> ● Smoke, abnormal odor or sound comes out from the product. ● No picture, no sound or distorted picture on the display. ● Foreign objects (such as water, metals etc) get inside the unit. Do not continue using the product under these abnormal conditions. Turn off the Main Power, unplug the Power Cord, and contact your dealer immediately. For your safety, never try to repair the product by yourself. 	 Disconnect the plug from the power outlet.
<ul style="list-style-type: none"> ■ Do not insert liquids or any foreign objects (such as metals or flammable items) inside the unit. <ul style="list-style-type: none"> ● In case it happens, turn off the main power, unplug the Power Cord, and contact your dealer immediately. ● Use special caution when younger children are around the unit. 	
<ul style="list-style-type: none"> ■ Do not remove cover, or modify the product. <ul style="list-style-type: none"> ● High-voltage components are installed inside of the unit. Removing covers can expose you to high voltage, electrical shock, and other dangerous conditions. ● Contact your local dealer to perform servicing such as inspection, adjustment, or repair work. 	  Do not disassemble.

SAFETY PRECAUTIONS (continued)



 WARNING	
There is a risk of fire, electric shock, or serious injury.	
<ul style="list-style-type: none"> ■ Install the unit at a proper area where it does not expose anyone to any danger. <ul style="list-style-type: none"> ● If you hit against the edge of the unit, you may be injured. 	
<ul style="list-style-type: none"> ■ Do not place any objects on top of the unit. <p>Objects such as</p> <ul style="list-style-type: none"> ● Liquid containers (vase, fish tank, flowerpot, cosmetics or liquid medicine). ● If water or any liquid spill onto the unit, it may cause short-circuit and result in fire or electrical shock. ● In case that it happens, turn off the Main Power, unplug the Power Cord, and contact your dealer immediately. ● Do not place anything heavy on top of the unit. ● Do not climb on or hang from the unit. ● Do not let your pets get on top of the unit 	
<ul style="list-style-type: none"> ■ Do not expose this unit to rain or moisture. <ul style="list-style-type: none"> ● Never use this unit in the bathroom or shower room. ● Beware when you use this product outside, especially in rainy or snowy weather, and at the beach or waterfront. ● When the product gets wet, it could cause fire or electrical shock. 	 
<ul style="list-style-type: none"> ■ Unplug this unit during lightning storm. <ul style="list-style-type: none"> ● To reduce the risk of electrical shock, do not touch the product when starts lightning. 	  Disconnect the plug from the power outlet
<ul style="list-style-type: none"> ■ Do not do anything that may damage the Power Cord. <ul style="list-style-type: none"> ● Do not damage, modify, twist, forcibly bend, heat, or pull excessively the Power Cord. ● Do not place heavy objects (including the unit itself) on top of the Power Cord. ● If the Power Cord is damaged, contact your dealer for repairs or exchange. 	
<ul style="list-style-type: none"> ■ Use only with designated power supply voltage. <ul style="list-style-type: none"> ● To prevent the risk of fire and electrical shock, operate this product only with the power supply voltage indicated on the unit. 	
<ul style="list-style-type: none"> ■ Beware not to drop or have any impact on the unit. <ul style="list-style-type: none"> ● Take extra care while moving the unit. ● There is no protection glass on the surface of the LCD panel. Thus, do not press the panel surface with your fingers or hands. Or do not hit anything against the television. These actions would damage the LCD cells or the panel surface and could cause the failure or personal injuries. ● In case that you drop the unit or the cabinet is damaged, turn off the Main Power, unplug the Power Cord and contact your local dealer immediately. ● Continuing use of the product with above conditions would cause fire or electrical shock. 	
<ul style="list-style-type: none"> ■ Clean dust or metals on or around the blade of the power plug regularly. <ul style="list-style-type: none"> ● Continuing use of the product with above condition may cause fire or electrical shock. ● Always unplug the Power Cord first, and clean the blade with dry cloth. 	
<ul style="list-style-type: none"> ■ Do not place the unit on an unstable surface. <p>Unstable places such as</p> <ul style="list-style-type: none"> ● Sloped place or shaky rack, table, stand or trolley. ● If the unit falls down, it could cause personal injury. 	

ENGLISH

SAFETY PRECAUTIONS (continued)

 CAUTION	
<ul style="list-style-type: none"> ■ Do not place the unit at the dusty place. It could cause malfunction. 	
<ul style="list-style-type: none"> ■ Do not cover or block any ventilation holes on the product. The television would overheat, and it could cause fire or damage the product which may shorten its service life. <ul style="list-style-type: none"> ● Install the product in accordance with the instructions in this manual. ● Do not place the unit with ventilation side down. ● Do not install the unit on the carpet or bedclothes. ● Do not cover the television with table cloth etc. 	
<ul style="list-style-type: none"> ■ Be sure to ground the earth cable correctly. <ul style="list-style-type: none"> ● Especially when you use Power Cord adapter, be sure to connect the earth cable to the ground terminal. Incorrect connection would cause fire or electrical shock. ● For your safety, always make sure to unplug the Power Cord before connect or disconnect the earth cable. 	 Supply connect the ground wire
<ul style="list-style-type: none"> ■ Follow the Anti-tumble measures in this manual. <ul style="list-style-type: none"> ● If the television tumble down, there is a risk of personal injury and possible death. Also, it would damage the product seriously. 	
<ul style="list-style-type: none"> ■ Do not install this product near the medical devices. <ul style="list-style-type: none"> ● To prevent malfunction of the medical devices, do not use this product and the medical devices in the same room. 	
<ul style="list-style-type: none"> ■ Do not place the CRT-based television near the speaker of the LCD Television. <ul style="list-style-type: none"> ● It could cause the partial discoloration or blurring of the image on the CRT-based television. ● Please install it away from the speaker of the LCD Television. 	
<ul style="list-style-type: none"> ■ Disconnect all of the external connection cables and detach the anti-tumble measures before moving the unit. <ul style="list-style-type: none"> ● It may cause fire, electrical shock, or personal injuries. 	
<ul style="list-style-type: none"> ■ Connect the power plug securely. <ul style="list-style-type: none"> ● Improper connection will cause overheat and may result in fire. ● Do not touch the blade of the plug while connecting it to the wall socket. It could cause electrical shock. ● If the plug is not fitted for the wall socket, contact your dealer for replacement. 	 
<ul style="list-style-type: none"> ■ Do not handle the Power Cord with wet hands. <ul style="list-style-type: none"> ● It could result in electrical shock. 	
<ul style="list-style-type: none"> ■ Do not pull the cord when you unplug the Power Cord. <ul style="list-style-type: none"> ● It may damage the cord and could result in fire or electrical shock. ● Hold the plug when disconnecting it. 	
<ul style="list-style-type: none"> ■ Unplug the Power Cord when unused the product for long periods of time. 	
<ul style="list-style-type: none"> ■ Handle the batteries properly. <ul style="list-style-type: none"> ● Improper or incorrect use of the batteries may cause corrosion or battery leakage, which could cause fire, personal injury or taint damage to the property. ● Use only the types of the batteries which are indicated in this manual. ● Do not install new batteries with used ones. ● Install the batteries correctly by following the polarity (+ and -) indications on the battery compartment. ● Do not dispose the used batteries as domestic waste. Dispose them in accordance with the local regulations. 	

SAFETY PRECAUTIONS (continued)

PRECAUTIONS	
<ul style="list-style-type: none"> ■ Do not install the unit in high temperature. It could damage the cabinet or parts of the product. <ul style="list-style-type: none"> ● Do not install near any heat sources such as radiator, heat registers, stoves, or other apparatus that produce heat. ● Keep the unit out of direct sunlight. It could increase the temperature of the unit and cause malfunction. 	
<ul style="list-style-type: none"> ■ Viewing Advice <ul style="list-style-type: none"> ● The lighting of the environment in which the product is used should be appropriate. Too bright / dark environment is not good for your eyes. ● Take time to relax your eyes occasionally. ● When you use this product, keep away from the television 3~7 times of the vertical length of the panel. This is the best viewing distance in order to protect your eyes against eyestrain. ● Adjust the volume in appropriate level, especially during the night. 	
<ul style="list-style-type: none"> ■ When transporting this product: <ul style="list-style-type: none"> ● When the product needs to be transported due to moving or repair, use the carton box and buffer material comes with this product. ● Do not keep this product lying sideways during transportation. It could damage the panel surface or degrade the phosphors of the panel. 	
<ul style="list-style-type: none"> ■ Keep away from the television when you use radio. This television is designed to meet the international EMI standards due to prevent the interference against the radio. However, the unit may generate noise in the radio. <ul style="list-style-type: none"> ● If the noise is in the radio, please try the following actions. <ul style="list-style-type: none"> • Adjust the direction of the radio antenna in order not to receive the interference radio wave from the unit. • Keep the radio away from the television. • Use coaxial cable for the antenna. 	
<ul style="list-style-type: none"> ■ About the infrared communication devices: <ul style="list-style-type: none"> ● The infrared communication devices such as cordless microphone or cordless headphone may not be available around the television. It is because of the communication failure. Please note that this is not malfunction. 	
<ul style="list-style-type: none"> ■ When you dispose this product at the end of its life, follow the regulations at your residential area. <ul style="list-style-type: none"> ● For more information, contact the local authority or the dealer where you purchased the product. 	

ENGLISH

Cleaning and Maintenance

Please make sure to unplug the power cord before cleaning the television.

<ul style="list-style-type: none"> ■ How to clean the LCD panel of the television. <ul style="list-style-type: none"> ● Wipe the panel with a lint-free and dry cloth in order to prevent damage to the panel surface. ● Do not use a chemical cloth or cleaner. Depending on the ingredients, it may cause discoloration and damage the panel surface. ● Do not wipe with a hard cloth or rub hard. It may hurt the panel surface. ● In case of the greasy dirt such as fingerprint, wipe with a lint-free cloth moistened by a diluted neutral detergent solution, and then wipe with a soft and dry cloth. ● Do not use a spray cleaner. It could cause malfunction.
<ul style="list-style-type: none"> ■ How to clean the cabinet of the television. <ul style="list-style-type: none"> ● The following may cause crack, deformation, and paint peeling. <ul style="list-style-type: none"> • Do not wipe the cabinet with benzene, thinner, and other chemical products. • Do not spray volatile solutions such as insecticide over the cabinet. • Do not leave the cabinet in prolonged contact with plastic or rubber materials. ● Do not use a chemical cloth, cleaner or wax. Depending on the ingredients, it may cause crack and deformation. ● Use a lint-free cloth to clean the cabinet and control panel of the television. In case of the heavy dirt, wipe with a soft cloth moistened by a diluted neutral detergent solution, and then wipe with a soft and dry cloth. ● Never use the following detergents. It could cause crack, discoloration, and scratch. <ul style="list-style-type: none"> • Acid/ alkaline detergent, alcoholic detergent, abrasive cleaner, powder soap, OA cleaner, car wax, glass cleaner, etc.



ABOUT LCD PANEL

Common phenomena of LCD Panel

The following are the common phenomena when operating LCD Panel due to its structural reason. Please note that they are not malfunctions.

- Defective Spots on Panel

The LCD panel is manufactured with high-precision technology. However, there might be some spots that are not emitted, brighter than the others, or in different colors, etc.

- Surface on Panel

The LCD panel displays images by blinking the fluorescent lamps internally. This could raise the temperature of the display surface.

In addition, do not impact strongly on the surface of the panel because LCD panel is made with fine processing glass.

- Residual image



When a still image or menu is displayed on the screen for a short time (about a minute) and then switches to another image, it may leave an "after-image" on the screen.

The residual image will disappear on its own.

- The Usage under the Low Temperature Environment

Because of the structural characteristics of the LCD panel, the response speed of the LCD panel becomes slower when the ambient temperature around the television becomes too low. In some cases, it may cause the residual image.

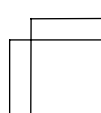
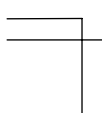
The residual image will disappear on its own as the temperature goes up and back to normal.



FEATURES

Enjoy not only beautiful and high quality pictures on the display, but also various kinds of useful and convenient functions in your daily life!

- Large-screen and high-definition LCD panel.
- Improved Digital signal processor.
- Accept more digital input devices with HDMI terminals.
- Great diversity of connecting terminals to cover wide range of audio-visual equipments.
- Enjoy the image from PC with large, high-definition LCD screen.
- Easy-to-use On-Screen Display system operating with Remote control.
- Low power consumption with Power Saving feature.

ENGLISH

SUPPLIED ACCESSORIES

Check the supplied accessories before installation.
In case of missing or damaged, please contact with dealer immediately.

User Manual

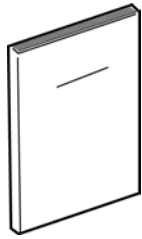

Remote Control



AA size batteries
X2

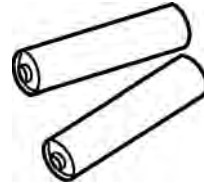

Power Cord
(BS Type)*



*The type of power plug provided may be different from this drawing for some countries.

COMPONENT NAMES

Main Unit

Front Panel

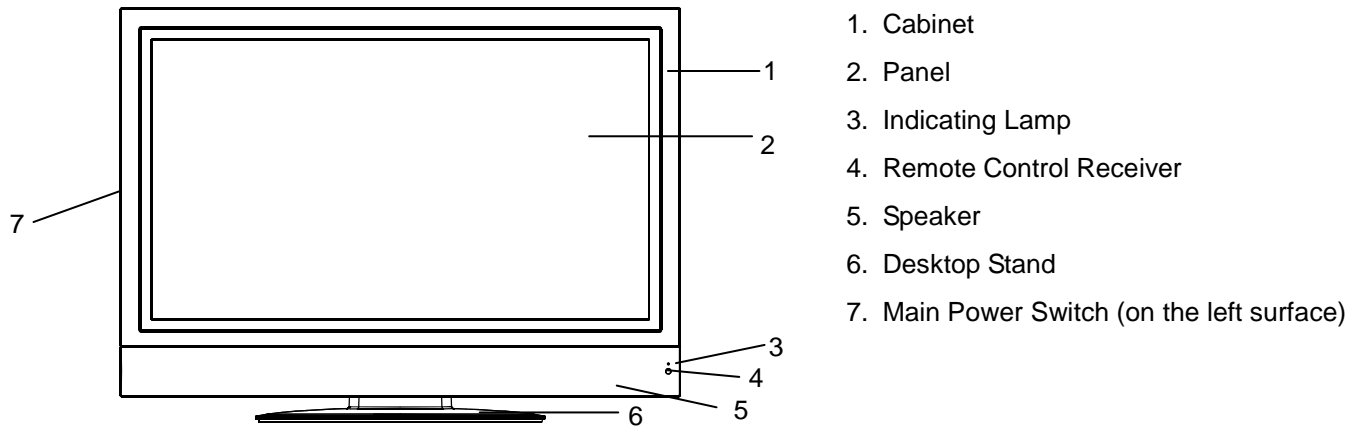

Rear Panel

1. Side Input
2. Power Cord Socket
3. Terminal Board (External Device Connection)
4. Control Panel (see below for details)

Please refer to 14 ~ 18 for the detailed information for the connections.

32LD900TA

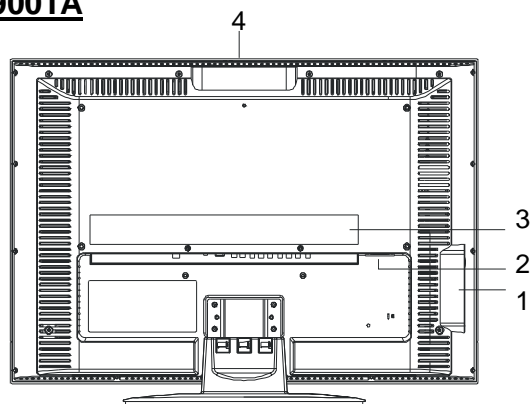

26LD900TA

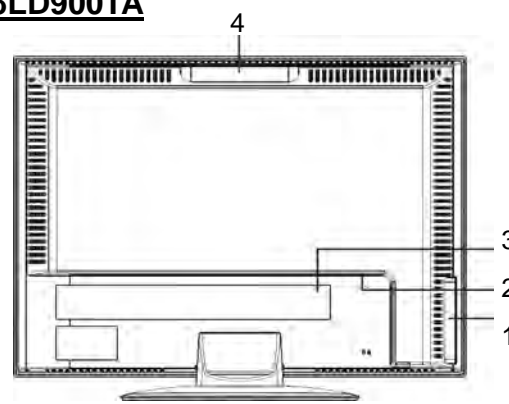

Control Panel (including Card Slot)

These buttons are located on the top.

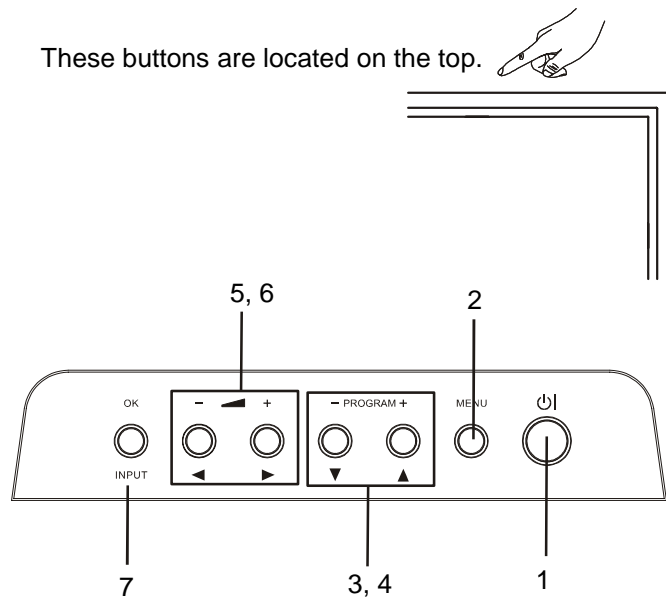

1. Sub Power button
2. Menu button
3. Channel UP/ ▲ button
4. Channel DOWN/ ▼ button
5. Volume UP ▲ +/▶ button
6. Volume DOWN - ◀/◄ button
7. Input button

COMPONENT NAMES (Continued)

Remote Control

ENGLISH



- 1. Power ON/OFF**
- 2. [Color (Red, Green, Yellow, Blue)]**
- 3. TV Select (TV)**
Press this button to change input to TV.
- 4. Input Select (AV1/AV2/AV3/AV4/HDMI/RGB)**
Press this button to change input mode.
- 5. Program Select**
Press these buttons to select a TV program directly.
- 6. Freeze [Hold]**
Press this button to change the picture to freeze mode.
- 7. MENU**
- 8. Cursor**
- 9. Volume Up/Down**
- 10. MUTE**
- 11. [Index]**
- 12. Picture Size**
Press this button to change picture size.
- 13. Recall**
Pressing this button shows the input signal status.
- 14. [TV ↔ Text]**
Teletext mode can be changed each time pressed in the following sequence. TV→Teletext→Mix mode
- 15. Return**
You can use this to return to the previous menu.
- 16. OK**
- 17. Picture Mode**
Picture mode can be changed each time pressed in the following sequence. Dynamic→Natural→ Cinema
- 18. Channel Up/Down[P +/-]**
- 19. CHI/II**
This is exclusively for TV audio I/II mode.
- 20. [Reveal]**
- 21. [Sub Title]**
- 22. [Cancel]**

NOTE

Some buttons are only for Teletext mode, and other buttons have different functions in Teletext mode from the use of TV mode. Those buttons are indicated by []. Refer to "About Teletext" on [31](#).

PREPARATION

Remote Control Batteries Installation

This remote control operates on 2 "AA" batteries.

1. Open the battery compartment cover.

- Slide open the battery compartment cover on the backside of the remote control in the direction of an arrow.

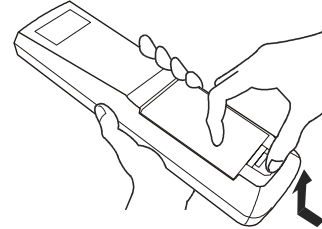

2. Installing the batteries.

- Install 2 "AA" batteries (included) making sure the polarities match the indication inside the compartment.

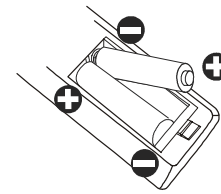

3. Close the battery compartment cover.

- To close the battery compartment cover, slide the cover in the direction of an arrow till it clicks shut.

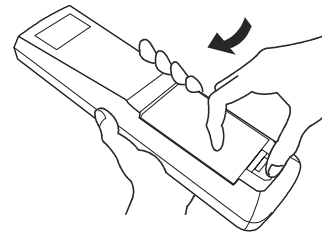

CAUTION

It could cause corrosion or battery leakage and may result in physical injury and/or property damage including fire.

- Never mix used and new batteries in the device.
- Replace all the batteries in a device at the same time.
- Remove the batteries if the remote control is not going to be used for an extended period of time.

To avoid possible failure, read the following instructions and handle the remote control properly.

- Do not drop or have an impact on the remote control.
- Do not spill water or any liquid on the remote control.
- Do not place the remote control on the wet object.
- Do not place the remote control under the direct sunlight or near sources of excessive heat.

Caution When Moving the Main Unit

As this product is heavy, whenever it is moved, two people are required to transport it safely.

When moving the unit, hold it by the top and bottom frame of the LCD screen. (See the figures below for details.)

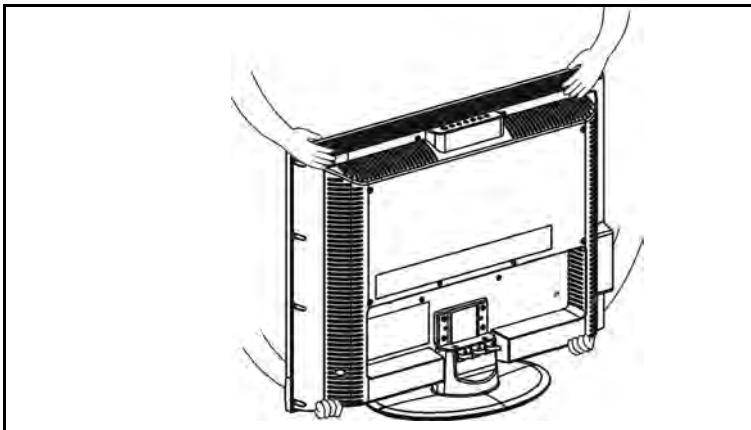

PREPARATION(continued)

Safety Precaution on Main Unit Installation

Read SAFETY PRECAUTIONS (4 to 7) carefully besides this page.

The Desktop Stand has been used for the illustration in this manual.

When installing the main unit, be sure to use the specified mount units in order to obtain maximum performance and maintain the safety.
We assume no responsibility or liability for personal injuries or property damages caused by use of other mount units or improper installation.

As for the installation instruction, please read each user manual of the mount units: for Desktop Setup, Wall Mounting, and Ceiling Mounting.

In case of using Wall or Ceiling Mounting unit, by contacting your local dealer, ask the specified installation specialist to set up. Never attempt to install it by yourself. It could cause injuries or damages

Please leave the adequate space around this television in order to avoid increasing the internal temperature.
Make sure not to block any ventilation holes.
Do not install the television in the small space such as inside the rack, closet or the box.
Leave more than 10cm of clearance from each side of television and 30cm from the top of television to wall.

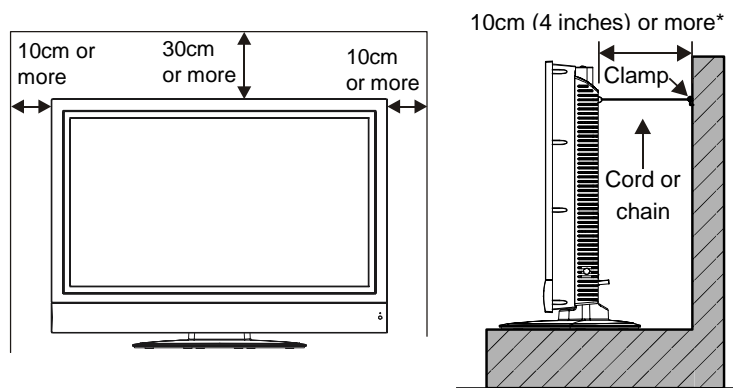

Anti-Tumble Measures

Install in a stable place and implement safety measure against overturning.

Securing to a wall or pillar

Using a commercially available cord, chain and clamp, secure the set to a firm wall or pillar.

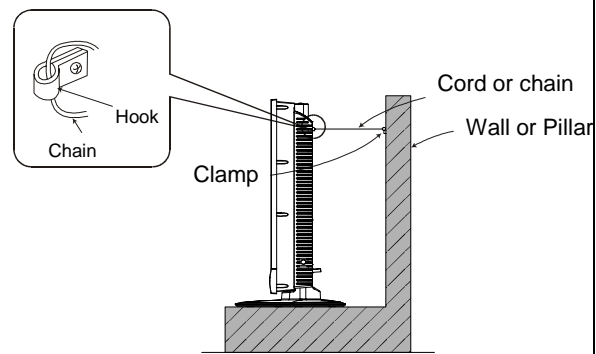

Securing to ceiling

Using a commercially available cord, chain, and clamp secure the set to a ceiling.

NOTE

- For more information regarding the mounting of the unit, please contact your dealer.
- Please install the unit at a proper area where it does not expose anyone to the danger of hitting themselves (for example their hands, head or face, etc) against the edge of the unit and cause personal injury.

CONNECTION

Terminal Positions

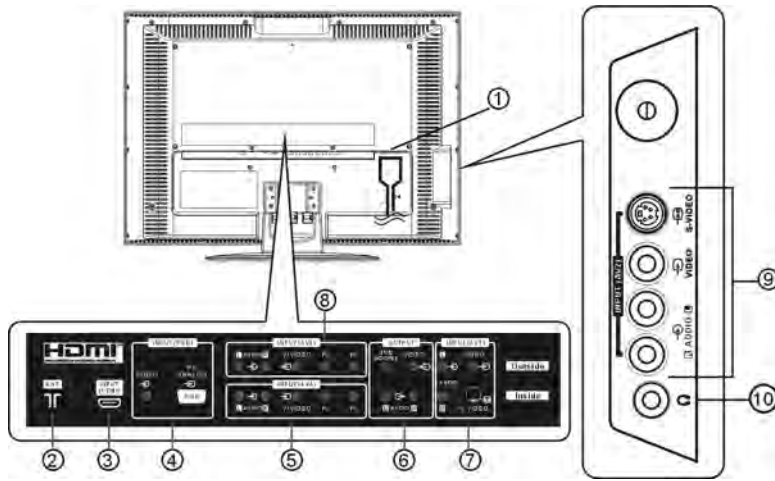

Rear

1. Power Cord Socket
2. Aerial Socket
3. HDMI
4. RGB
5. AV4
6. Monitor Out and Sub Woofer
7. AV1
8. AV3

Side

9. AV2
10. Headphone output

Connecting Procedure

Your television is ready for various kinds of connections. Make a connection in the following steps. Be sure to turn off the Main Power first when connecting external equipments.

1. **Connect Power Cord to the rear panel.**
2. **Connect Aerial Lead.**
3. **Connect your external equipments to the television if any.**
4. **Connect the Power Plug to the Wall Socket.**

1. Connect Power Cord to Rear Panel.

Connect Power Cord to the television.

* Make sure not to connect the Power Plug to the Wall Socket until all connections are completed.

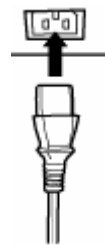



2. Connecting Aerial Lead.

There are two ways to connect Aerial Lead.

When you do not have any other external equipment: STB
Connect the Aerial Lead directly into the Socket at rear panel.

When you have one or more external devices to connect:

1. Use RF cable to connect between each equipment and Antenna.
2. Connect the Aerial Lead to an equipment "In" Socket marked .
3. Connect the RF cable from the equipment "Out" to the other equipment "In".
4. Then, connect from the equipment "Out" to "ANT" on the LCD screen Socket on marked .

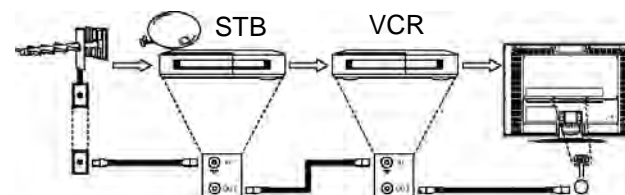

[Example: Connecting Antenna through STB and VCR.]

Precautions when connecting the aerial

- Please use a coaxial cable which is free from interference to connect the aerial. Avoid using a parallel flat feeder wire as interference may occur, causing reception to be unstable and stripe noise to appear on the screen.
- Avoid using indoor aerial as this may be affected by interference. Please use CATV net or outdoor aerial.
- For safety, install an external aerial conforming to AS1417.1 (applicable for Australia only)
- If there are noise appearance in the picture of VHF-Low band channel, please use the double-shielded cable (not provided) for RF LEADS to reduce the noise.

CONNECTION (continued)

Connecting Procedure (continued)

3. Connecting to External Equipment

• Terminals on Rear

AV1 can be connected to the equipment with an S-Video output and Composite output.

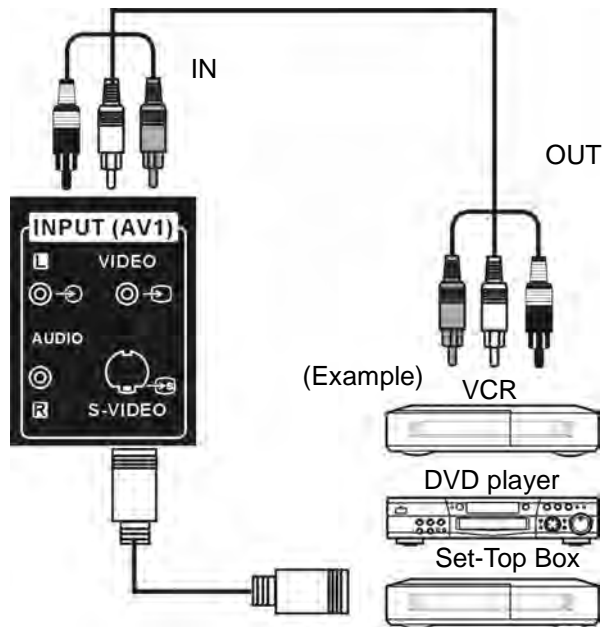

If your external device has a S-video terminal, S-VIDEO connection is recommended for higher quality picture.

AV3 and AV4 can be connected to the equipment with either Component or Composite output. Depending on whether the Y/VIDEO input of your selected equipment is Y signal or Video signal, it automatically regards as Component or Composite. When using as Composite, do not insert the jacks into P_B or P_R.

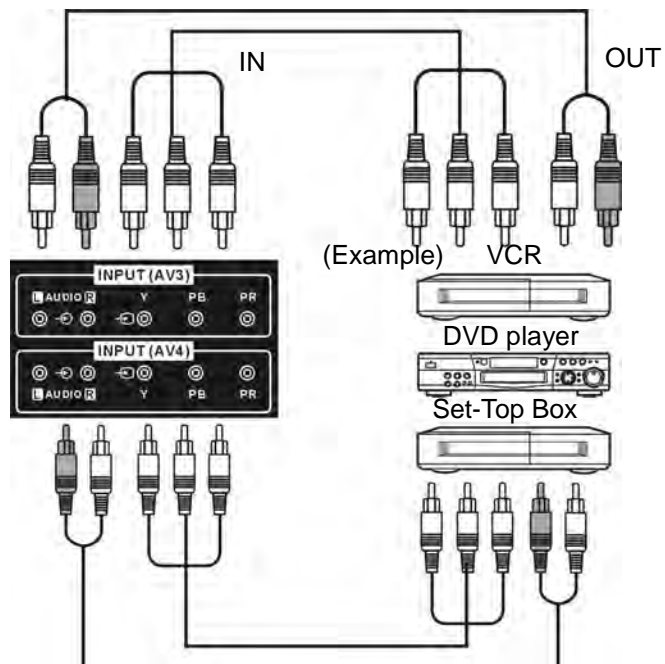

If your external device has a Component terminal, COMPONENT connection is recommended for higher quality picture.

CONNECTION (continued)

Connecting Procedure (continued)

Monitor Out can be used to display same image as main unit on another television. When this output terminal is connected to an external television with a 75 Ohm terminal, the same image from composite (AV1~4), or S-Video, or RF signal can be displayed to the external television.

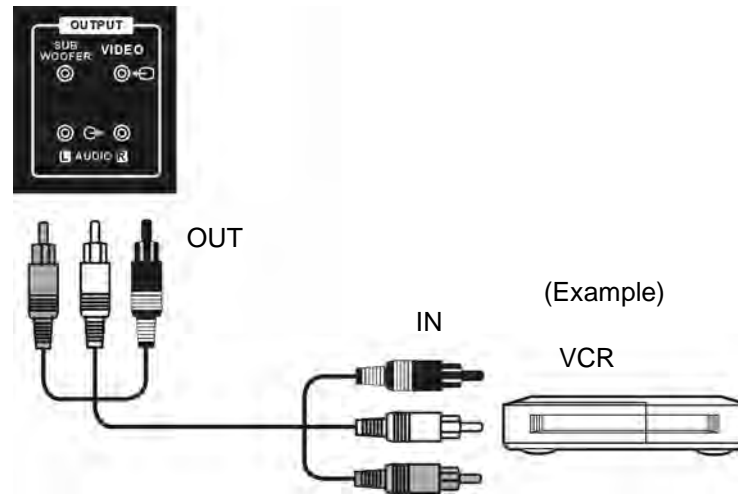

Sub Woofer terminal can bring the deep bass sound from the external speaker.

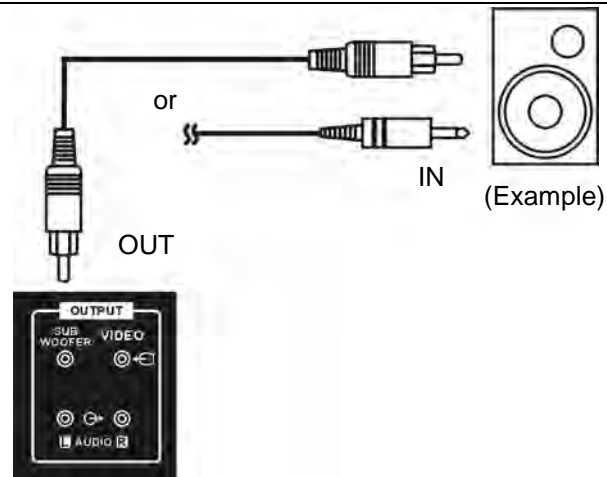

PC terminals (D-sub 15 pin + audio) is connected to PC, which allows Analog RGB signal.

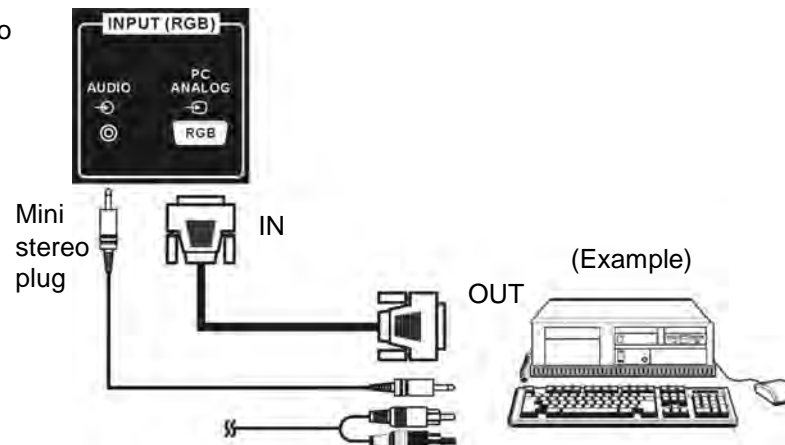

CONNECTION (continued)

Connecting Procedure (continued)

HDMI terminals can be connected to the devices with HDMI output.

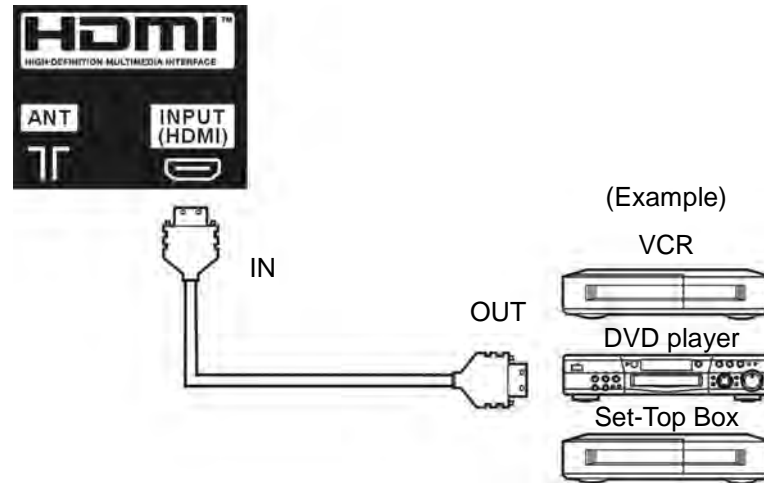

ENGLISH

Information

HDMI(High Definition Multimedia Interface) is next-generation multimedia I/O interface. Only one cable is used to transmit all video/audio/control signals, which creates easy connection. Moreover, those digital signals can produce high quality data without any degradation.

If your external device has a HDMI terminal, HDMI connection is recommended for higher quality picture and sound.

- Terminals on Side

Since the following terminals are located on the side, it is very convenient to use the extra device on a temporary basis after done the connections on the rear panel.

AV2 can be connected to the equipment with an S-Video output and composite output.

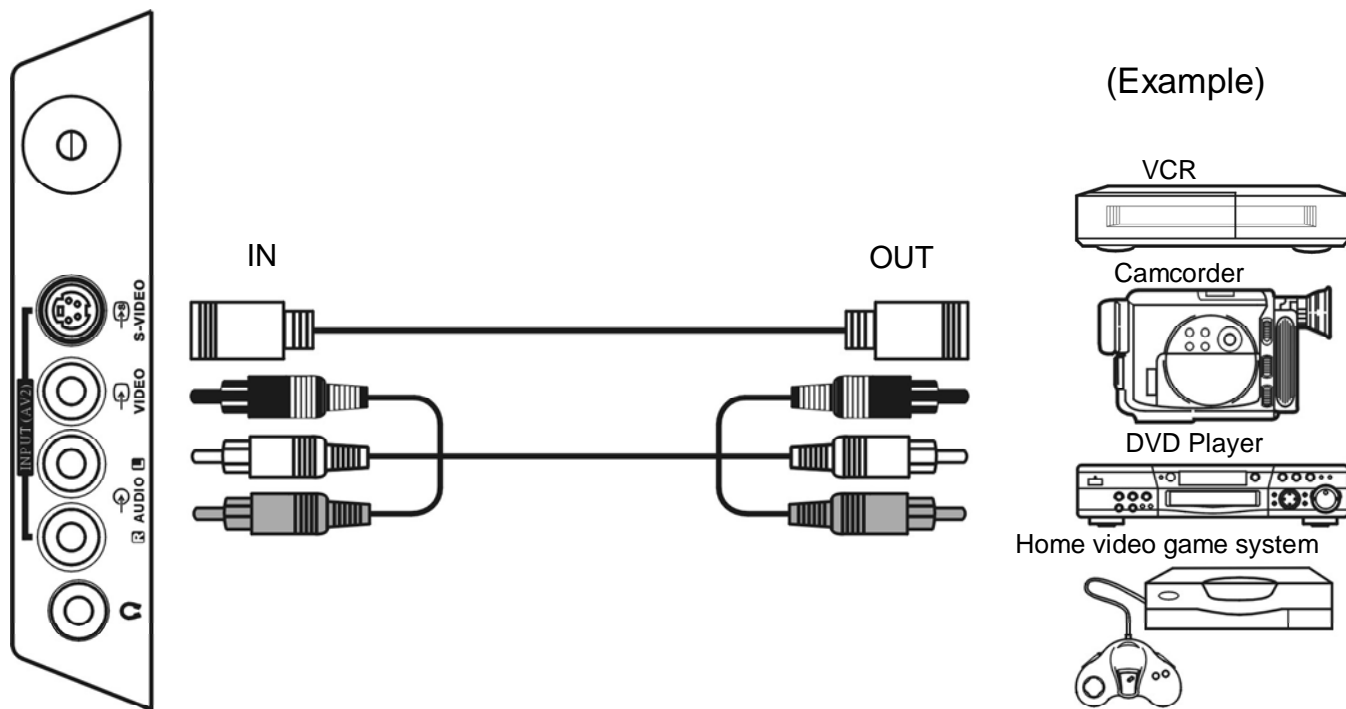

If your external device has a S-video terminal, S-VIDEO connection is recommended for higher quality picture.

CONNECTION (continued)

Connecting Procedure (continued)

Headphone The detail settings can be adjusted from Audio Menu on page 29.

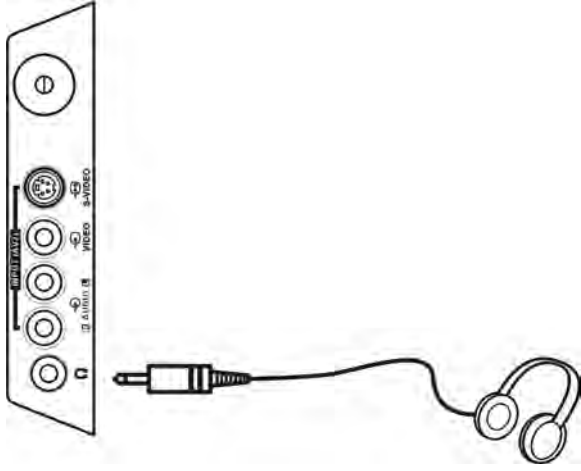

The audio from the speaker will be muted when connecting the headphone to this terminal.

4. Connecting the plug into the wall socket

Connect the Power Cord after completing all other connections.

(The type of plug is different from this drawing for some countries.)

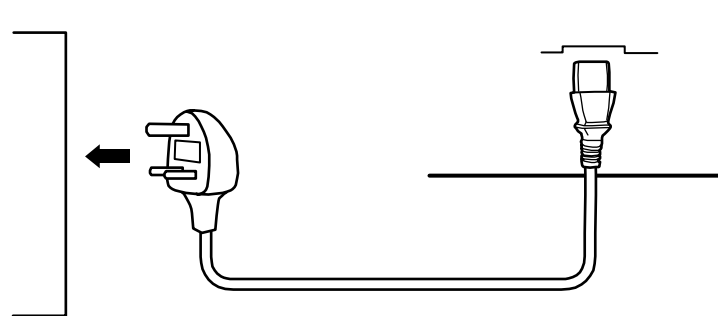

CAUTION

- Use only the Power Cord provided.
- Do not use a power supply voltage other than that indicated (AC100-240V, 50/60Hz). It may cause fire or electric shock.
- For the LCD panel, a three-core power cord with a ground terminal is used for efficiency protection. Always be sure to connect the Power Cord to a three-pronged grounded outlet and make sure that the cord is properly grounded. If you use a power source converter plug, use an outlet with a ground terminal and screw down the ground line.
- Ensure that both ends of power cord are easily accessible.
- If you have to change the power cord, please use the certified power cord that meets your region's safety standard.

BASIC OPERATION

POWER On/Off

Now, turn On the main power of the unit. Make sure that the Power Cord has plugged into the wall socket.

Main Power switch (on the left surface)

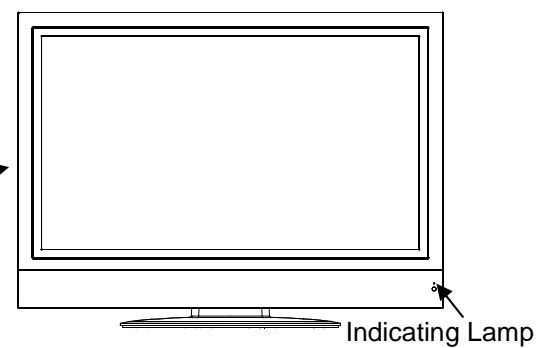

ENGLISH

- To turn On the power of the television:
 1. Press the **Main Power switch** on the television.
 - The Indicating Lamp will illuminate in **Red** (Standby mode).
 2. Press **Sub Power button** either on the control panel or on the remote control.
 - The color of the Indicating Lamp turns into **Green**, and the image will display on the screen.

Sub Power button



- To turn Off the power of the television:
 1. Press **Sub Power button** either on the control panel or on the remote control.
 - The image disappears from the screen and the Indicating Lamp turns into **Red** (Standby mode).

Sub Power button



2. Press **Main Power switch** to completely turn Off the power of the unit.

The Indicating Lamp Status Check

Indicating Lamp Status	Power Status	Power Switch Status
Off	Off	Main power → Off
Red	Standby mode	Main power → On Sub Power button → Off
Green	On	Main power → On Sub Power button → On
Orange	Power Save mode*	Main power → On Sub Power button → On



* About Power Save mode, see [Power Save Mode] and [When Following Messages Appear on the Screen] on [35](#) and [36](#) for details.

Note

- If the image does not appear on the screen at all, or have any problem, see TROUBLESHOOTING on [36](#) ~ [38](#). It may help you to solve the problems.
- You can turn ON the power only by pressing the **Sub Power button** during the Standby mode.
- Do not switch the power On/Off repeatedly in a short period of time. It could cause malfunction.
- To avoid sudden surges of electricity when the power comes back on, turn Off the main power of the unit before you leave if there is a blackout during use of the unit.

BASIC OPERATION (continued)

Volume UP/DOWN



1. To increase the sound volume, press  + button on the remote control, or **Volume Up** button on the control panel.
 - The Volume Indicator value on the screen will shift right.
2. To decrease the sound volume, press -  button on the remote control or **Volume Down** button on the control panel.
 - The Volume Indicator value on the screen will shift left.



Volume Up/Down button

Mute button

Mute

1. To mute the sound, press  button on the remote control.
 - The sound of the unit is temporarily turned Off.
 - When the audio mode is set to **Mute**, mute icon  will be displayed at the left-bottom corner of the TV.
2. To turn the sound back, press  button again, or Volume Up button on either remote control or the control panel.

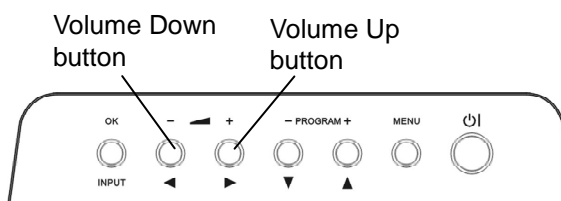

NOTE

You can decrease the volume by pressing -  button while muted the volume.

BASIC OPERATION (continued)

Input Switching to TV/AV1~4, HDMI, and RGB

Input Switching to TV/AV1~4, HDMI, and RGB

By pressing Input Select button, you can switch the input.

- To watch actual broadcast, press Input Select button on the control panel, the numeric buttons or Channel Up / Down button on the remote control.
- To display the image outputting from the external equipments connected to each terminal (AV1~4, HDMI and RGB), select

1. Press Input Select buttons on the remote control.

2. The Input modes can be also switched by using Input Select button on the control panel.

Each time this button is pressed, the screen displays corresponding mode by following order.

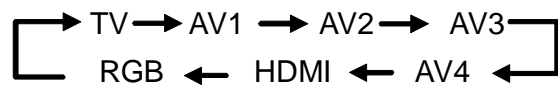

3. To directly go back to TV mode, pressing channel Up/Down buttons on either remote control or the control panel.

Also, you can use the numeric buttons on the remote control.

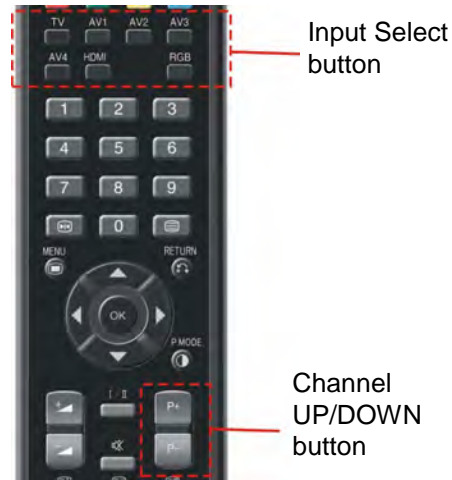

Input Select button

Channel UP/DOWN button

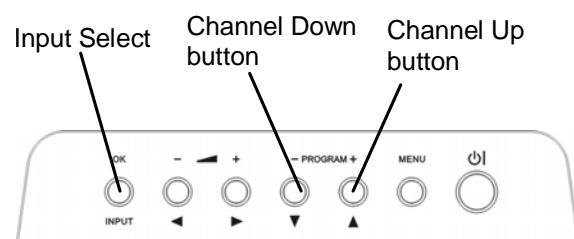

Input Select

Channel Down button

Channel Up button

ENGLISH

Input Signal Screen Display

The input signal status can be displayed on the screen by pressing the RECALL button of the remote control.

- The display will go out in approximately 6 seconds.

TV



VIDEO

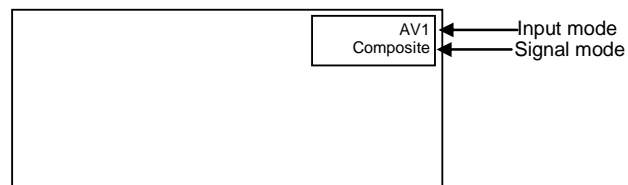

RGB

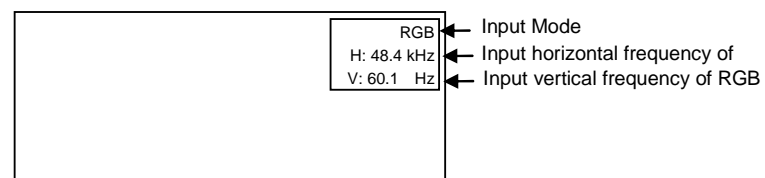





RECALL button

MENU OPERATION

How to use the On-Screen Display (OSD) system

With the On-Screen Display system, you can access the various kinds of the features and functions in this product.

• Basic Operation

1. Press  button on the remote control or **Menu** button on the control panel of the unit. The **Main Menu** is displayed on the screen as shown on the right.
2. To select the item, press **▲** or **▼** buttons.
The selected item will be highlighted in Green.
3. Press  button to set your selection.
The selected menu page will be displayed on the screen.
4. Use **▲** or **▼** buttons to choose the item on the MENU page.
Press  button to set your selection.
5. Use **◀** or **▶** buttons to adjust the item values or choose options.
Press  button to set your selection.
6. To exit from the menu, press  button.

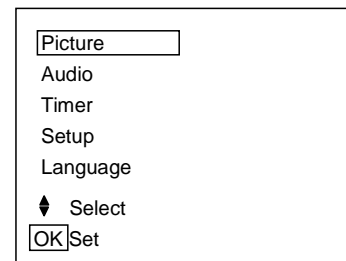

<Main Menu>



NOTE

The OSD menu screen will be closed automatically when no operation has been made for about one minute.

Language Menu

Select the language from the list so that you can display the OSD menu in the selected language.

How to set Language

1. Enter the "Language" menu from the Main Menu.
2. Select the appropriate language with **▲** or **▼** button from the list.
The white dot is marked inside of the circle of selected language.
3. Press  button to set your selection.
The white dot is marked inside of the circle when the selection is fixed.
4. Press  button to exit from the entire OSD menu.

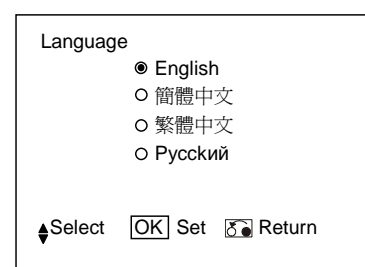

MENU OPERATION (continued)

Setup Menu (TV mode)

With this menu, you can access various kinds of features relating to TV channel settings.

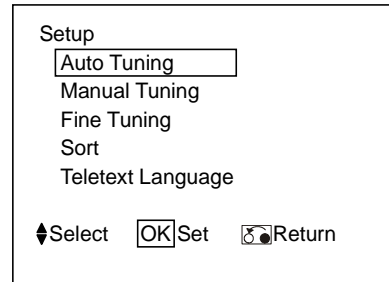



ENGLISH

Selected Items		Setup hint
Auto Tuning	Mode	Position Select the way to display the channels on the screen. The position numbers are displayed on the screen. (1~125)
		Direct The channel number 1~57 are displayed as C* *, and the channel number 1~42 are displayed as Z* *.
	Search	Tune the local channels automatically. Press button to start searching.
Manual Tuning	Position	Press channel up (+) down (-) buttons to input position number (1~125) or channel number (C* * or Z* *).
	Frequency	When Auto Tuning Mode is set to [position], search the frequency by using ◀▶ buttons.
		When Auto Tuning Mode is set to [Direct], this function is not available (grayed out).
	Name	<ol style="list-style-type: none"> 1. Move the cursor to the first digit and select the letters with ▲▼ buttons. 2. Move to the next digit with ▶ button. 3. Press button again when you finish inputting all the letters. <ul style="list-style-type: none"> • The selectable letters are as follows: "0"~"9", "A"~"Z", "+", " " (blank), "-" (displayed as blank), and "." (period).
Sound System	Auto	Select the sound system from 5 different modes.
	M	
	BG	
	I	
	DK	

MENU OPERATION (continued)

Setup Menu (TV mode) (continued)

Selected Items		Setup hint
Manual Tuning	Color System	Auto PAL SECAM NTSC4.43 NTSC3.58
	Skip	Off On
Fine Tuning	-56~+56	▶: Increase the frequency data for the main tuner. ◀: Decrease the frequency data for the main tuner.
Sort		You can change the order of channels as follows. 1. Move the cursor to the Channel row you want to change order and then, press  button. 2. The color of the letters on the designated line will be turned into green bracket and with []. 3. Move the designated row by using ▲▼ buttons. 4. Press  button to fix the position. • This function is not available (grayed out) when the Auto Tuning Mode is set to [Direct].
Teletext Language		Select Teletext Language from 5 different categories (West Europe, East Europe, Cyrillic, and Arabic) according to the area. Example: West Europe: Asian countries where the Teletext is broadcasting in English such as Singapore, Australia, and Malaysia. East Europe : Poland, Sweden, Hungary Cyrillic : Russia Arabic : Arab countries

MENU OPERATION (continued)

Setup Menu (RGB mode)

With this menu, you can adjust the display condition of the image which is inputting from the RGB terminals.
By pressing ▼ button at the bottom of the 1st Setup menu page, the 2nd Setup menu page will appear on the screen.

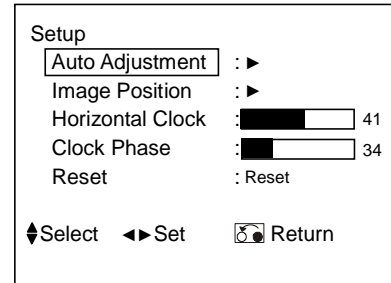

ENGLISH

Selected Items		Setup hint
Auto Adjustment		Adjust Horizontal Position, Vertical Position, Horizontal Clock, and Clock Phase automatically. <ul style="list-style-type: none"> • Press button to start auto adjustment. The message "Auto Adjusting" is displayed. • Depending on the type of the signal, there is a possibility that the display may not be adjusted in its optimum condition with this function. In that case, please adjust
Image Position*		Adjust the display position horizontally. <ul style="list-style-type: none"> • When the position exceeds the possible range, the display color will turn into Magenta.
Horizontal Clock*	0~63	Minimize the vertical stripes on the screen.
Clock Phase*	0~100	Minimize the blurring of the letters and stripes on horizontal row. <ul style="list-style-type: none"> • Make sure to adjust <u>Horizontal Clock first</u> before adjusting Clock Phase.
Reset		Reset image position.

MENU OPERATION (continued)

Picture Menu (TV mode)

In this menu, you can make specific adjustments for the picture based on your preference.
By pressing .button at the ▼ bottom of each menu page, the next Picture menu page will appear on the screen.

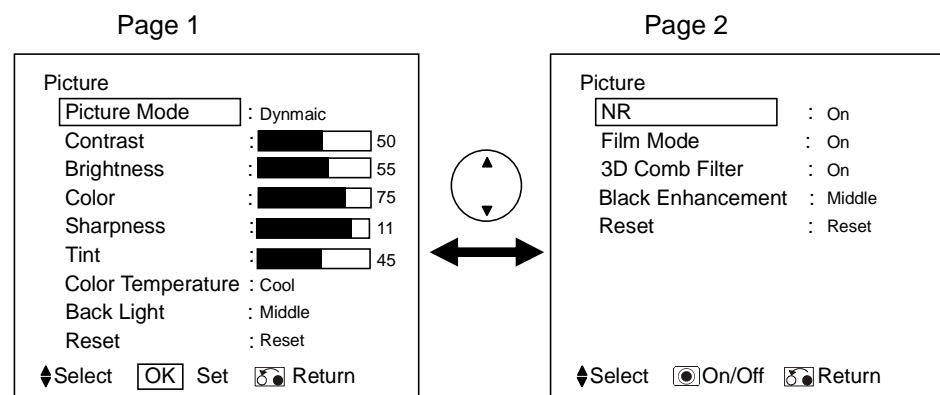

Selected Items		Setup hint
Picture Mode	Natural	You can make the better selection from 3 modes depending on the lighting condition and intended use. Dynamic : Suitable for the brighter conditions. Natural : Suitable for the normal lighting condition. Cinema : Suitable for watching movie.
	Dynamic	
	Cinema	
Contrast*	0~100	This adjusts the contrast to meet the lighting environment by using ◀▶.
Brightness*	0~100	With this function, black is adjusted to change the overall brightness by using ◀▶.
Color*	0~100	It can adjust color density based on your preference by using ◀▶.
Sharpness*	0~12	Preferred sharpness can be adjusted by pressing ◀ button for Softer image or ▶ button for Sharper image.
Tint*	0~90	Pressing ◀ button enhances red and weakens green, while pressing ▶ button weakens red and enhances green. The setup hint is adjusting for the realistic skin color. This is not available by PC mode when receiving RGB signal.
Color Temperature*	Cool	You can select from 4 settings (default) depending on the color condition with ◀▶ buttons.
	Warm	
	User	
	Normal	
Back Light	Low	Adjust the brightness of the Back Light for the maximum visibility.
	Middle	
	High	

MENU OPERATION (continued)

Picture Menu (TV mode) (continued)

Selected Items		Setup hint
NR	Off	The noise on the screen or interference could be reduced, especially at the area of weak electric field.
	On	
Film Mode*	Off	On: Automatically identify if it is the movie film and faithfully reproduces the original film images.
	On	Off: Set to Off if the image does not look natural during turning on.
3D Comb Filter	Off	This is available only when receiving NTSC/PAL composite signal. This reduces the dot and color blurring in minute scales so that it can reproduce purer color.
	On	
Black Enhancement*	Off	Adjusts the black level compensation.
	Low	
	Middle	
	High	
Reset		Each item on this menu screen can be restored to the original factory settings by pressing  button.

ENGLISH

Information

The items indicated by “*” can be stored the setting for each of inputs and picture modes (Dynamic/Natural/Cinema). You can enjoy different setting depending on the selected input such as VCR in AV1.

In addition, the items indicated by “**” can be stored the setting for each of color temperature modes.

MENU OPERATION (continued)

Picture Menu (RGB mode)

In this menu, you can make specific adjustments for the RGB picture based on your preference.

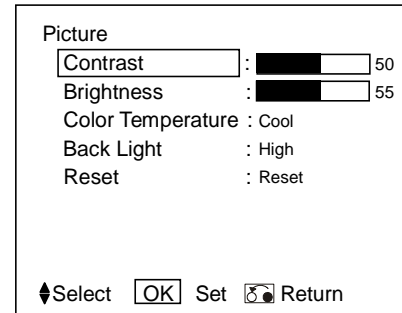

Selected Items		Setup hint
Contrast	0~100	This adjusts the contrast to meet the lighting environment by using ◀▶.
Brightness	0~100	With this function, black is adjusted to change the overall brightness by using ◀▶.
Color Temperature	Cool	You can select from 4 settings (default) depending on the color condition with ◀▶ buttons.
	Normal	
	Warm	
	User	
Back Light	Low	Adjust the brightness of the Back Light for the maximum visibility.
	Middle	
	High	
Reset		Each item on this menu screen can be restored to the original factory settings by pressing (OK) button.

Information

There is a useful function to automatically store the setting on menu in almost every item so that you do not have to reset every time. Furthermore, the following items can be stored more specifically.

MENU OPERATION (continued)

Audio Menu

With this menu, you can adjust and customize the audio condition as you like.

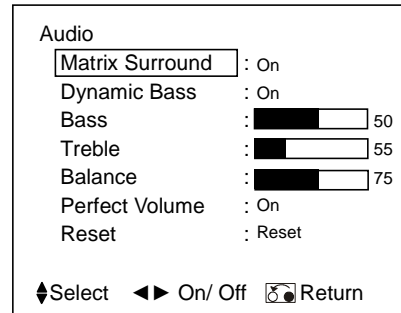

ENGLISH

Selected Items		Setup hint
Matrix Surround	Off	The surround sound is mixed to left and right in order to create the illusion of virtual surround speakers.
	On	
Dynamic Bass	Off	Dynamic Bass gives you the enhanced bass sound. Low frequency signals can be boosted while the output signal amplitude is measured.
	On	
Bass	-10~+10	Adjust the Bass of the sound.
Treble	-10~+10	Adjust the Treble of the sound.
Balance	-10~+10	Adjust the balance of the sound comes out from right and left side of the speakers.
Perfect Volume*	Off	It will automatically adjust the volume to its average level each time you change the channel.
	On	
Reset		Reset all the set values on this Menu Page to the original factory settings.

Information

There is a useful function to automatically store the setting on menu in almost every item so that you do not have to reset every time. Furthermore, the following items can be stored more specifically.

MENU OPERATION (continued)

Timer Menu

This allows your **television** to turn Off (Standby mode) at set time automatically, which you may find useful.

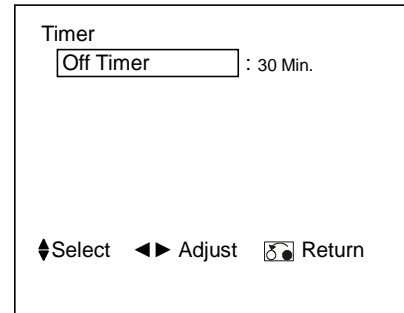

Selected Items		Setup hint
Off Timer	Off	This function automatically sets the power to Standby mode when the selected time period has elapsed.
	30Min.	
	60Min.	
	90Min.	
	120Min.	

FUNCTION

About Teletext

● What is “Teletext”

Teletext is the written information services provided by each TV channel.
Most TV channels provide information via Teletext such as:









- TV program schedule
- Weather forecasts
- Sports results
- Newsflash

● How to operate the Teletext

You can display the Teletext simply by pressing the remote control buttons.

NOTE

Select Teletext language from Setup Menu shown on [24](#)

Operation	Press
To switch Teletext mode: Teletext mode can be changed each time pressed in the following sequence. TV→Teletext→Mix mode	 [TV ↔ Text]
To display Index page.	 [Index]
To access Subtitle service directly (if the channel has the Subtitle service broadcasting).	 [Subtitle]
To display Hidden text. ex. The answers of the Quiz or the Game page. Press again to close the revealed answer.	 [Reveal]
To return to actual broadcast temporarily while searching for the Teletext page you request. When the search is done, the designated page # will be displayed on the upper left of the screen. Press again to return to Teletext page.	 [Cancel]
To access the link pages which are displayed at the bottom of the page. (Select the buttons corresponding to the colors of the letters on screen.)	 [Color]
To hold the text picture.	 [Hold]
To change Teletext page #: ex. Press P+/P- to increase/decrease page number of Teletext.	 [P +/-]

Information

- Some Teletext pages do not display Link Pages at the bottom of the screen. Press  button to display them.

FUNCTION (continued)

Size Switching



Each time  button of the remote control is pressed, the screen display size is switched in sequence, and the status will be displayed at the bottom of the screen.

TV/AV signal input

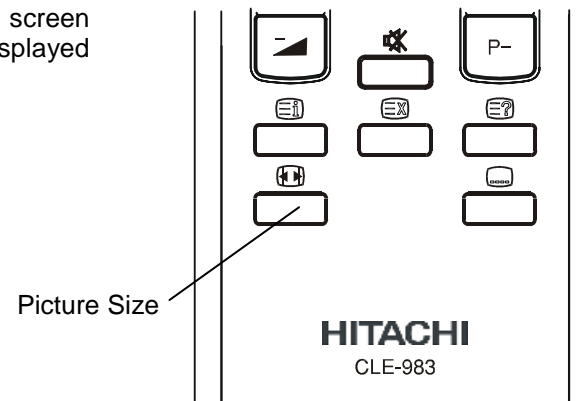
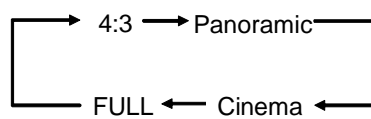
TV/AV1/AV2/AV3/AV4 /HDMI



You can display the image at optimum condition by selecting display size depending on the current output image as shown below.

Current Output Image (Input Signal)	Display Size	To display suitable screen as follows.
 (4:3 Signal)	4:3	Play a 4:3 image on screen faithfully. Blanking occurs on both sides.
	Panoramic	Play a 4:3 image which enlarges horizontal and vertical size of the middle in equal scales, and displays both sides appearing much wider.
 (Cinema)	Cinema	Play a 21:9 image in 4:3 image (Cinema size) expanding vertically. *In some case, slight blanking may remain at the top and bottom.
 (Squeeze)	Full	Play a 4:3 image faithfully in the standard vertical size and horizontally squeezed.

Information

Aspect ratio represents horizontal : vertical ratio on screen.
For example, vista image is 16:9 in 4:3 image.

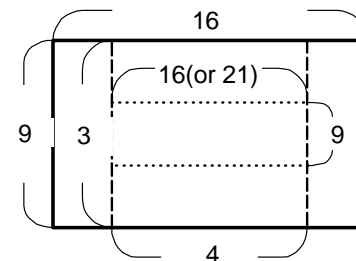

CAUTION

Using a wide-screen television

- This television has a screen mode selection feature. If an incompatible screen mode is selected to play certain software, such as a TV program, the image would appear different from the original. Take this into consideration when making screen mode choices.
- Use of the wide feature displaying enlarged pictures in coffee shops, hotel and other establishments for commercial or public viewing purposes could infringe on the copyright holder's right protected by Copyright Law.
- When a normal 4:3 image (not wide screen) is displayed over the entire screen in the Panoramic mode, the peripheral image may disappear partly and/or appear distorted in some cases. Use 4:3 mode to view the image reflecting original intention.

FUNCTION (continued)

Size Switching (continued)

RGB signal input

RGB signal input only support Full size

Display Area Selection Diagram

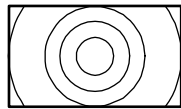
Resolution	Full display
Display	
640 X 480 (VGA)	
800 X 600 (SVGA)	
1024 X 768 (XGA)	

ENGLISH

FUNCTION (continued)

Audio Switching

Sound Multiplex (TV mode)

You can make optimum use of available audio by pressing  bottom of remote control. Audio can be switched only if receiving sound multiplex signals; otherwise, pressing this button will have no effect, such as when only mono sound is received.

These can be divided into two main categories: Bilingual/Dual Sound broadcast and Stereo broadcast.

Bilingual/Dual Sound broadcast

Bilingual broadcast is the broadcast available on the main and sub languages, while dual sound broadcast is available on the primary and secondary sounds; for example, some sports programs contain broadcast commentary on a game as primary sound, and a commentary about a team as the secondary.

When bilingual program is received, sound mode display appears in yellow as shown.

Each time  button is pressed, the display is switched in the sequence of following.

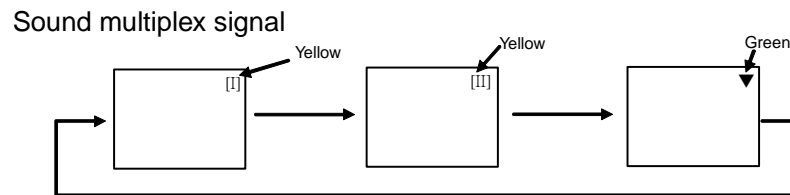

[I]...Main language/Primary Sound
[II]...Sub language/Secondary Sound
▼...force mono: This selects main language or primary sound.

Stereo broadcast

With stereo broadcast, you can enjoy different sound from either side.

When a stereo program is received, sound mode display will appear in red as shown.

Press  button to switch between stereo and mono sound.

Sound multiplex signal

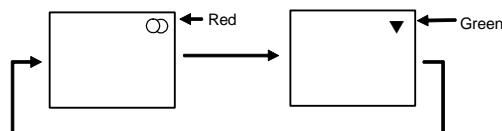

◉...stereo
▼...Force Mono

NOTE

- Please select ▼ (force mono) in case of poor reception, noise, poor stereo sound due to signal condition so that you can receive a clear mono sound.
- ▼ represents the Mono broadcast.

FUNCTION (continued)

Power Save Mode

When the RGB input is selected

- When this unit is connected to a VESA DPMS computer, the Power Save mode (Operation mode : Off) can be set to be activated automatically when the computer is not being used to reduce power consumption by this unit.

RGB sync signal	Horizontal	Yes	No	Yes
	Vertical	Yes	Yes	No
PC signal		Active (normal display)	Blank (no display)	
Operation mode		On	Off	
Indicating lamp		Lights green	Lights orange	

Returning to operating status

- Operate the personal computer, or press either the INPUT SELECT button of the control panel or the RGB button of the remote control.





TROUBLESHOOTING

Before calling service technician, check the following tables first. If the problem is not be solved with the suggested procedures, contact your local dealer. For your safety, NEVER try to repair the product by yourself.

When Following Messages Appear on the Screen

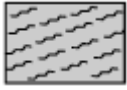

Message	Condition / Action	Page
Power Save	This indicates it is in Power Save mode. (in RGB mode) The indicating lamp lights in orange.	19, 35
No Sync. Signal	The unit cannot detect any signals from any input terminals. <ul style="list-style-type: none"> Check if the cable is connected correctly and firmly. Check if the power of the external equipments is ON. Check if the input selection matches the connection terminal. Check if the PC is in Power Save mode or not. 	14, 19
Invalid Scan Freq.	The unit receives signals not supported by the television. <ul style="list-style-type: none"> Check if the cable is connected correctly and firmly. Check if the input signal is compatible with the specification of the television. 	39, 41
Not Available	This shows when the selected operation is not available.	
Check Antenna	Check the connection status when this message appears.	14
Auto Adjusting	This indicates that it is in the process of auto adjusting. (in RGB mode)	15

Symptom and Check List

Symptom	Check list	Page
No picture – no sound	<ul style="list-style-type: none"> Check the Indicating lamp status (Off, Red, Green, or Orange). Check the connection of the Power Cord and/or other cables. Check if the Main Power of the unit or external equipments is ON. Check if the TV mode is selected. Check if the TV is in "Standby mode" or "Power Save mode". Adjust the values in "Picture menu" and "Audio menu". 	14, 18 19, 23 35
Snowy picture-poor sound	 <ul style="list-style-type: none"> Check the antenna connection and direction. The TV station may have broadcast difficulties. Try another channel. 	14
Multiple images-normal sound	 <ul style="list-style-type: none"> Check the antenna connection and direction. Fine tuning the TV. Check the connection of the external equipments. The TV station may have broadcast difficulties. Try another channel. 	14, 23
Intermittent interference	 <ul style="list-style-type: none"> Check if the source of interference is shielded well. Remove those kinds of electrical devices away from the TV. 	
Normal picture, but no sound	<ul style="list-style-type: none"> Check the volume level. Check if the  button has been press or not. Make sure that the headphone is NOT connected. Check the connection of the external equipments. 	20
No picture – normal sound	<ul style="list-style-type: none"> Check the volume level of "Brightness" and "Contrast" in "Picture Menu". 	26, 28
The remote control does not work.	<ul style="list-style-type: none"> Check if the batteries are installed correctly. The batteries might be exhausted. Replace them with new ones. Remove all the obstructions in front of the sensor window on the unit. Check if the buttons of the control panel can work. 	11, 12
Normal picture but no color-normal sound	<ul style="list-style-type: none"> Check the connection of the external equipments. Check the "Color System" in "Picture Menu". 	26

TROUBLESHOOTING(continued)







Symptom and Check List (continued)

Symptom	Check list	Page
<ul style="list-style-type: none"> No picture The Indicating lamp → Off 	<ul style="list-style-type: none"> Check if the Power Cord is plugged into the socket firmly. Check if the Main Power is ON. 	14, 19
<ul style="list-style-type: none"> No picture The Indicating lamp → Orange It means that the unit is in "Power Save mode". 	<ul style="list-style-type: none"> Check if all the cables of the external equipments are connected correctly and firmly. Check if the power of the external equipments is <u>ON</u>. Check if the TV/AV mode has been selected correctly. Check if the PC is in Power Save mode or not. Refer to "Power Save mode" and "When following messages appears on the screen" 	35
<ul style="list-style-type: none"> No picture The indicating lamp → Green 	<ul style="list-style-type: none"> Check if the signal cable is connected correctly and firmly. Adjust the level of Brightness and Contrast lower. 	14, 18
<ul style="list-style-type: none"> The top of the television and surface of the panel heat up. 	<ul style="list-style-type: none"> It may happen when you use the unit for long hours. Turn off the Main Power of the unit for a while. Please note that this is not malfunction. 	39, 41
<ul style="list-style-type: none"> Image cannot be displayed in the correct position. 	<ul style="list-style-type: none"> Press  button to check if the input signal of the displayed image is compatible with the specification of the television. 	39, 41
<ul style="list-style-type: none"> When the VCR is in special playback features (Fast forward or Rewind), the screen gets dark and cannot see the image at all. 	<ul style="list-style-type: none"> It could happen when the VCR is connected to Component output, such as 480i. This is not malfunction. Try Composite output or S-video output and check the picture again. 	
<ul style="list-style-type: none"> Screen display size cannot be switched correctly. 	<ul style="list-style-type: none"> The display size is fixed at "FULL" when the receiving signals are 1080i/60Hz, 1080i/50Hz, 720p/60Hz, or 720p/50Hz. Check the signal status by pressing the  button on the remote control. 	32, 33
<ul style="list-style-type: none"> Cannot be displayed the image from HDM. 	<ul style="list-style-type: none"> Check if the cables are connected correctly. Check the output format of the equipments. (Please refer to "Connecting Procedure" and "Recommended Signal List".) 	17, 41

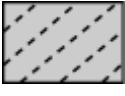
ENGLISH

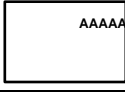
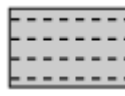
TROUBLESHOOTING(continued)

Symptom and Check List (continued)

Symptom		Check list	Page
<ul style="list-style-type: none"> The image on the screen is moving in an oblique direction. (PC input mode only) 		<ul style="list-style-type: none"> Adjust "Horizontal Clock" and "Clock Phase". 	25
<ul style="list-style-type: none"> The coarse horizontal stripes could be seen in full-display mode. (PC input mode only) 		<ul style="list-style-type: none"> Adjust "Horizontal clock". 	25
<ul style="list-style-type: none"> The part of the image is lacking. (PC input mode only) 		<ul style="list-style-type: none"> Try "Auto Adjust". 	25
<ul style="list-style-type: none"> The horizontal stripes are moving vertically with flickering screen. (PC input mode only) 		<ul style="list-style-type: none"> Check the Signal status of the PC by pressing  button on the remote control. If the Vertical Frequency of the PC is set to less than 70Hz, adjust its level higher (up to 70Hz). 	25
<ul style="list-style-type: none"> When the characters are displayed on the whole screen, <u>the vertical stripes appear and some of the characters are blurred.</u> (PC input mode only). 		<ul style="list-style-type: none"> Try "Auto Adjust". If the display condition is not improved with Auto Adjust, adjust "Horizontal Clock". 	25
<ul style="list-style-type: none"> When the letter string is displayed in full-screen, <u>all of the characters</u> on the screen are blurred. (PC input mode only) 		<ul style="list-style-type: none"> Try "Auto Adjust". If the condition is not improved with Auto Adjust, adjust "Clock Phase" till you get clearest image. 	25
<ul style="list-style-type: none"> When the small patterns are displayed on the screen, the entire screen is flickering. (PC input mode only) 		<ul style="list-style-type: none"> Try "Auto Adjust". If the condition is not improved with Auto Adjust, adjust "Clock Phase" till you gets flicker-free display. 	25
<ul style="list-style-type: none"> The thickness of the letters, lines, etc is <u>not</u> displayed evenly. (PC input mode only) 		<ul style="list-style-type: none"> It could happen when the image with more than 768 lines of vertical resolution is displayed. Please note this is not malfunction. 	

PRODUCT SPECIFICATIONS

SPECIFICATION		32LD9000TA	26LD9000TA
Panel	Display dimensions	Approx. 32 inches (698 (H) x 392 (V) mm, diagonal 801mm)	Approx. 26 inches (626.0(H) x 373.0(V)mm, diagonal 600.53 mm)
	Resolution	1366 (H) x 768 (V) pixels	
Net dimensions Excluding Stand:		790 (W) x 550 (H) x 120 (D) mm	624(W) x 507(H) x 250(D)
Net weight		Including Speakers / Stand: 19kg	13.5 Kg
Ambient conditions	Temperature	Operating: 5°C to 35°C, Storage: 0°C to 40°C	
	Relative Humidity	Operating: 20% to 80%, Storage: 20% to 90% (non-condensing)	
Power supply		AC100 - 240V, 50/60Hz	
Power consumption/at standby		135W/1W	125W/1W
Audio output	Speaker total	20W	14W
(VIDEO input)			
Input terminals		AV1.2: composite video input terminal (RCA) L/R audio input terminal (RCA) AV3.4: component video input terminal (RCA) L/R audio input terminal (RCA) HDMI : HDMI input terminal	
Input signals		Composite video: PAL, SECAM, NTSC3.58, NTSC4.43, PAL60 Component video: 480i, 576i, 480p, 576p, 720p/50, 720p/60, 1080i/50, 1080i/60	
Output signals		OUTPUT (MONITOR): composite video monitor-output terminal (RCA) OUTPUT (MONITOR): L/R audio monitor- output terminal (RCA) OUTPUT (HEADPHONE): L/R audio monitor- output terminal (Mini-pin) OUTPUT (SUB-WOOFER): Woofer output terminal	
(RF input)			
Input terminal / Receiving range		ANT: 75Ω Unbalanced / 38~884MHz	
RF Video System		PAL B, G, H / I / D, K SECAM B, G / D, K / K1 NTSC-M	
(RGB input)			
Input terminals		Analog RGB input terminal (D-sub 15-pin) Audio input terminal (3.5mm Stereo Mini Jack)	
Input signals		0.7 V, analog RGB (Recommended Signal)	
Sync signals		H/V separate, TTL level [2K Ω]	

- The television takes at least 30 minutes to attain the status of optimal picture quality.

ENGLISH

PRODUCT SPECIFICATIONS (continued)

Signal Input

RGB terminal (D-SUB 15-PIN CONNECTOR)

Pin	Input signal
1	R
2	G or sync on green
3	B
4	No connection
5	No connection
6	R.GND
7	G.GND
8	B.GND
9	No connection
10	GND
11	No connection
12	[SDA]
13	H. sync
14	V.sync. [V.CLK]
15	[SCL]

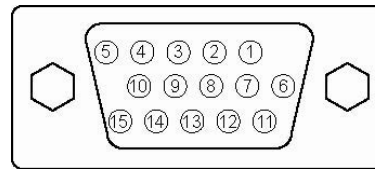

When different kinds of input signals are simultaneously input to the TV via a graphics board or the like, the TV only support H/V separate sync signal.

S-input connector pin specifications

Pin	Input Signal
1	Y
2	Y-GND
3	C
4	C-GND
Frame	GND

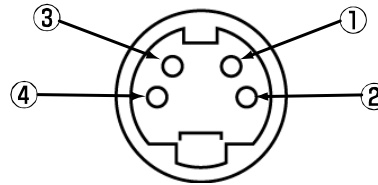

HDMI Connector Input pin specifications

Pin	Input Signal	Pin	Input Signal
1	T.M.D.S. Data2+	11	TMDS Clock Shield
2	T.M.D.S. Data2	12	TMDS Clock
3	T.M.D.S. Data2-	13	CEC
4	T.M.D.S. Data1+	14	Reserved(N.C. on
5	T.M.D.S. Data1	15	SCL
6	T.M.D.S. Data1-	16	SDA
7	T.M.D.S. Data0+	17	DDC/CED Ground
8	T.M.D.S. Data0	18	+5V Power
9	T.M.D.S. Data0-	19	Hot Plug Detect
10	T.M.D.S. Clock+		

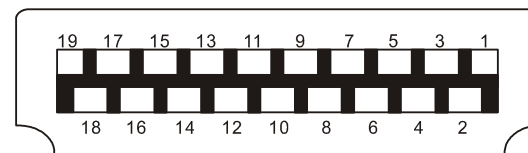

PRODUCT SPECIFICATIONS (continued)

Recommended Signal List

With HDMI INPUT

No.	Signal mode			Horizontal frequency (kHz)	Dot clock frequency (MHz)	Remarks
	Signal Name	Resolution	Vertical frequency (Hz)			
1	VGA	640x480	59.94	31.47	25.18	
2	480i	720(1440)x480	60	15.75	27.00	
3	480P	720x480P	60	31.5	27.00	
4	576i	720(1440)x576	50	15.63	27.00	
5	576P	720x576P	50	31.25	27.00	
6	720P/60	1280x720	60	45	74.25	
7	720P/50	1280x720	50	37.5	74.25	
8	1080i/60	1920x1080	59.94	33.75	74.25	
9	1080i/50	1920X1080	50	28.13	74.25	

With RGB input

No.	Signal mode			Horizontal frequency (kHz)	Dot clock frequency (MHz)	Remarks
	Signal Name	Resolution	Vertical frequency (Hz)			
1	VGA	720 x 400	70.09	31.47	25.18	
2	VGA	640 x 480	59.94	31.47	25.18	
3	SVGA	800 x 600	56.25	35.16	36.0	
4	SVGA	800 x 600	60.32	37.88	40.0	
5	SVGA	800 x 600	72.19	48.08	50.0	
6	XGA	1024 x 768	60.00	48.36	65.0	
7	XGA	1024 x 768	70.07	56.48	75.0	

- The type of video board or connecting cable used may not allow for correct displays adjustment of Horizontal Position, Vertical Position, Horizontal Clock and Clock Phase.
- The television may fail to display an animation image correctly when a signal having a vertical frequency of 72Hz or higher is input to it.
- The television differentiates the signal modes according to the horizontal and vertical frequencies and the horizontal and vertical sync signal polarities. Note that different signals having all these elements alike may be handled as the same signal.
- Displaying images with more than 768 lines of vertical resolution a Full display (compressed display) can result in the interpolation of stripes.

ENGLISH

Free Manuals Download Website

<http://myh66.com>

<http://usermanuals.us>

<http://www.somanuals.com>

<http://www.4manuals.cc>

<http://www.manual-lib.com>

<http://www.404manual.com>

<http://www.luxmanual.com>

<http://aubethermostatmanual.com>

Golf course search by state

<http://golfingnear.com>

Email search by domain

<http://emailbydomain.com>

Auto manuals search

<http://auto.somanuals.com>

TV manuals search

<http://tv.somanuals.com>