

HITACHI

Solid State Color TV

32CX39B

32FX49B

32UX59B

36CX39B

36FX49B

36UX59B

OPERATING GUIDE



IMPORTANT SAFEGUARDS

2-4

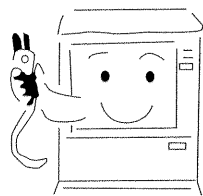

FIRST TIME USE

5-23



THE REMOTE CONTROL

24-34

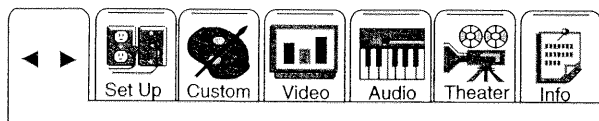

**ULTRATEC BIT-MAP
ON-SCREEN DISPLAY**

35-59

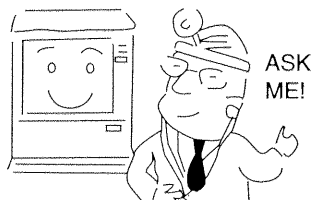





USEFUL INFORMATION INDEX

60-67



IMPORTANT

Follow all warnings and instructions marked on this color television.

| | | | |
|--|--|---------------------------------------|--|
|  <table border="1"><tr><td>WARNING</td></tr><tr><td>RISK OF ELECTRIC SHOCK DO NOT OPEN</td></tr></table>  | WARNING | RISK OF ELECTRIC SHOCK DO NOT OPEN |  <p>The lightning flash with arrowhead symbol, within an equilateral triangle, is intended to alert the user to the presence of uninsulated "dangerous voltage" within the product's enclosure that may be of a sufficient magnitude to constitute a risk of electric shock to persons.</p> |
| WARNING | | | |
| RISK OF ELECTRIC SHOCK DO NOT OPEN | | | |
| <p>CAUTION: TO REDUCE THE RISK OF ELECTRIC SHOCK, DO NOT REMOVE COVER (OR BACK). NO USER SERVICEABLE PARTS INSIDE. REFER SERVICING TO QUALIFIED SERVICE PERSONNEL.</p> |  <p>The exclamation point within an equilateral triangle, is intended to alert the user to the presence of important operating and maintenance (servicing) instructions in the literature accompanying the appliance.</p> | | |

WARNING:
TO PREVENT FIRE OR SHOCK HAZARD, DO NOT EXPOSE
THIS COLOR TELEVISION TO RAIN OR MOISTURE.

NOTE:

- There are no user serviceable parts inside the television.
- Model and serial numbers are indicated on back side of the television.

CAUTION:

- Adjust only those controls that are covered in the instructions, as improper changes or modifications not expressly approved by Hitachi could void the user's authority to operate the TV.

MODIFICATIONS:



- The FCC requires the user to be notified that any changes or modifications made to this device that are not expressly approved by Hitachi America, Ltd. Home Electronics Division may void the user's authority to operate the equipment.

POWER SOURCE

This HITACHI color television is designed to operate on 120 volts 60Hz, AC current. Insert power cord into a 120 volt 60Hz outlet.

TO PREVENT ELECTRIC SHOCK, DO NOT USE THE TELEVISION'S (POLARIZED) PLUG WITH AN EXTENSION CORD, RECEPTACLE, OR OTHER OUTLET UNLESS THE BLADES AND GROUND TERMINAL CAN BE FULLY INSERTED TO PREVENT BLADE EXPOSURE.

NEVER CONNECT THE TELEVISION TO 50HZ, DIRECT CURRENT, OR ANYTHING OTHER THAN THE SPECIFIED VOLTAGE.

NOTE: This television receiver will display television closed captioning, ( or ), in accordance with paragraph 15.119 of the FCC rules.



CAUTION: Never remove the back cover of the television as this can expose you to very high voltages and other hazards. If the television does not operate properly, unplug the television and call your authorized dealer or service shop.



IMPORTANT SAFEGUARDS

CAUTION:

- Read all of these instructions.
- Save these instructions for later use.
- Follow all warnings and instructions marked on the television.

SAFETY POINTS YOU SHOULD KNOW ABOUT YOUR HITACHI COLOR TELEVISION

Our reputation has been built on the quality, performance, and ease of service of HITACHI televisions.

Safety is also foremost in our minds in the design of these units. To help you operate these products properly, this section illustrates safety tips which will be of benefit to you. Please read it carefully and apply the knowledge you obtain from it to the proper operation of your HITACHI television.

Please fill out your warranty card and mail it to HITACHI. This will enable HITACHI to notify you promptly in the improbable event that a safety problem should be discovered in your product model.

FOR YOUR PERSONAL SAFETY

1. This television set is equipped with a polarized alternating-current line plug (a plug having one blade wider than the other). This plug will fit into the power outlet only one way. This is a safety feature. If you are unable to insert the plug fully into the outlet, try reversing the plug. If the plug should still fail to fit, contact your electrician to replace your obsolete outlet. Do not defeat the safety purpose of the polarized plug.



2. When the power cord or plug is damaged or frayed, unplug the television from the wall outlet and refer servicing to qualified service personnel.

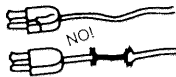

3. Do not overload wall outlets and extension cords as this can result in fire or electric shock.

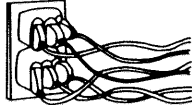

4. Do not allow anything to rest on or roll over the power cord, and do not place the television where the power cord is subject to traffic or abuse. This may result in a shock or fire hazard.



5. Do not attempt to service the television yourself as opening or removing covers may expose you to dangerous voltage or other hazards. Refer all servicing to qualified service personnel.

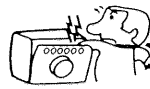

6. Never push objects of any kind into the television's cabinet slots as they may touch dangerous voltage points or short out parts that could result in a fire or electric shock. Never spill liquid of any kind on the television.

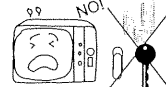

7. If the television has been dropped or the cabinet has been damaged, unplug the television from the wall outlet and refer servicing to qualified service personnel.

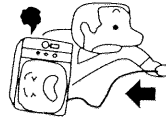

8. If liquid has been spilled into the television set, unplug it from the wall outlet and refer service to qualified service personnel.



9. Do not subject your television to impact of any kind. Be careful not to damage the picture tube surface.



10. Unplug the television from the wall outlet before cleaning. Use a damp cloth for cleaning. Do not use liquid or aerosol cleaners.

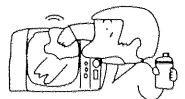

11-1. Do not place the television on an unstable cart, stand, or table. The television may fall, causing serious injury to a child or an adult, and serious damage to the appliance. Use only with a cart or stand recommended by the manufacturer, or sold with the television. Wall or shelf mounting should follow the manufacturer's instructions, and should use a mounting kit approved by the manufacturer.



11-2. An appliance and cart combination should be moved with care. Quick stops, excessive force, and uneven surfaces may cause the appliance and cart combination to overturn.



PROTECTION AND LOCATION OF YOUR TELEVISION

12. Do not use the television near water, for example, near a bathtub, washbowl, kitchen sink, or laundry tub, in a wet basement, or near a swimming pool, etc.

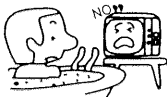

• Never expose the television to rain or water. If the set has been exposed to rain or water, unplug television from wall outlet and refer to qualified service personnel.

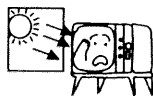

13. Choose a place where light (artificial or sunlight) does not shine directly on the screen.

14. Avoid dusty places. Accumulated dust inside the chassis may cause failure of the television when high humidity persists.



15. The television has slots or openings in the cabinet for ventilation purposes which provide reliable operation of the receiver and protect the television from overheating. These openings must not be blocked or covered.

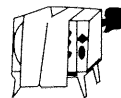

• Never cover the slots or openings with cloth or other material.

• Never block the bottom ventilation slots of the television by placing it on a bed, sofa, rug, etc.



• Never place the television near or over a radiator or heat register.



• Never place the television in a built-in enclosure unless proper ventilation is provided.





SAFETY TIPS

PROTECTION AND LOCATION OF YOUR TELEVISION

16-1. If an outside antenna is connected to the television, be sure the antenna system is grounded so as to provide some protection against voltage surges and built-up static charges. Section 810 of the National Electrical Code, NFPA No. 70-1975, provides information with respect to proper grounding of the mast and supporting structure, grounding of the lead-in wire to an antenna discharge unit, size of grounding conductors, location of antenna discharge unit connection to grounding electrode, and requirements for the grounding electrode.

16-2. **Note to CATV system installer:** (Only for television with CATV reception). This reminder is provided to call the CATV system installer's attention to Article 820-40 of the NEC that provides guidelines for proper grounding and, in particular, specifies that the cable ground shall be connected to the grounding system of the building, as close to the point of cable entry as practical.

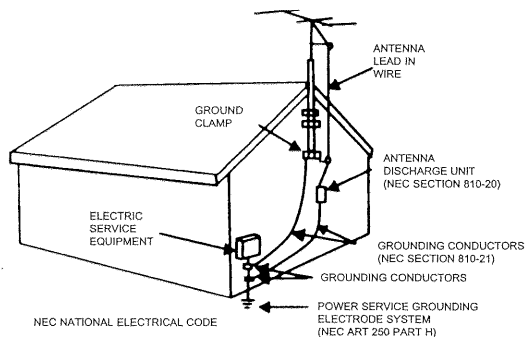

EXAMPLE OF ANTENNA GROUNDING AS PER NATIONAL ELECTRICAL CODE INSTRUCTIONS.

17. An outside antenna system should not be located in the vicinity of overhead power lines or other electrical lights or power circuits, or where it can fall into such power lines or circuits. When installing an outside antenna system, extreme care should be taken to keep from touching such power lines or circuits as contact with them might be fatal.

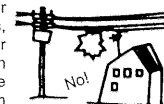

18. For added protection for the television during a lightning storm, or when it is unused for long periods of time, unplug it from the wall outlet and disconnect antenna. This will prevent damage due to lightning and power-line surges.



OPERATION OF YOUR TELEVISION

19. This television should be operated only from the type of power source indicated on the marking label. If you are not sure of the type of power supply at your home, consult your dealer or local power company. For televisions designed to operate from battery power, refer to the operating instructions.

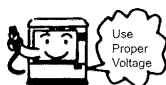

20. If the television does not operate normally by following the operating instructions, unplug the television from the wall outlet and refer servicing to qualified service personnel. Adjust only those controls that are covered in the instructions as improper adjustment of other controls may result in damage and will often require extensive work by a qualified service technician to restore the television to normal operation.



21. If your television is to remain unused for a period of time, (such as when going on a holiday), turn the television OFF and unplug it from the wall outlet.



IF THE TELEVISION DOES NOT OPERATE PROPERLY

22. If you are unable to restore normal operation by following the detailed procedure in your operating instructions, do not attempt any further adjustments. Unplug the television and call your dealer or service technician.



23. Whenever the television is damaged or fails, or if there is a distinct change in performance that indicates a need for service, unplug the television and have it checked by a qualified service technician.

24. It is normal for some televisions to make occasional snapping or popping sounds, particularly when being turned on or off. If the snapping or popping is continuous or frequent, unplug the set and consult your dealer or service technician.

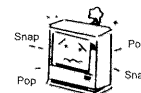

FOR SERVICING AND MODIFICATION

25. Do not use attachments not recommended by the television manufacturer as they may cause hazards.



26. If replacement parts are required, be sure the service technician has used replacement parts specified by the manufacturer that have the same characteristics as the original part. Unauthorized substitutions may result in fire, electric shock, or other hazards.

27. Upon completion of any service or repairs to the television, ask the service technician to perform routine safety checks to determine that the television is in safe operating condition.

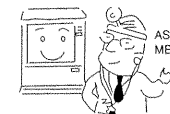

PICTURE CAUTIONS

Picture Burn Prevention

- Continuous on-screen displays such as video games, stock market quotations, computer generated graphics, and other fixed (non-moving) patterns can cause permanent damage to television receivers. Such "PATTERN BURNS" constitute misuse and are NOT COVERED by your HITACHI Factory Warranty.
- When using Picture-in-Picture function, the sub-picture should not be left permanently in one corner of the screen or a "PATTERN BURN" may develop over a long period of time.

Public Viewing of Copyrighted Material

Public viewing of programs broadcast by TV stations and cable companies, as well as programs from other sources, may require prior authorization from the broadcaster or owner of the video program material.

ACCESSORIES

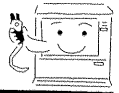

Check that you have the following accessories before disposing of the packing material.

1. Remote Control Unit (See Part No. below)
2. Two "AA" size, 1.5V batteries (For Remote Control Unit).

For information regarding how to obtain these accessories, please call TOLL FREE 1-800-448-2244 for the nearest HITACHI Authorized parts Distributor in the United States. For Alaska and Hawaii, please contact your nearest HITACHI regional office.

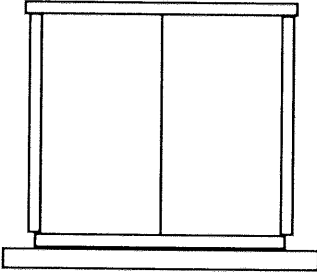
| PARTS NAME | PART NO. | ILLUSTRATION |
|--|---|--|
| <p>36UX59B 32UX59B CLU-4111UI REMOTE CONTROL</p> | <p>HL00238</p> | |
| <p>36FX49B 36CX39B 32FX49B 32CX39B CLU-4111U REMOTE CONTROL</p> | <p>HL00239</p> | |
| <p>32V TELEVISION STAND SP316B (Not included, order separately)</p> | <p>H530022</p> | <p>CUSTOM HITACHI TELEVISION STAND</p>  <p>Excellent for VCR and video-tape storage. Special features includes curved smoke glass doors and an adjustable shelf.</p> <p>Available in Black.</p> |
| <p>32V TELEVISION STAND SP317B (Not included, order separately)</p> | <p>H530023 (upgrade)</p> | |
| <p>36V TELEVISION STAND SP351B (Not included, order separately)</p> | <p>H530024</p> | |

CAUTION: Television stand models SP316B and SP317B are designed for use only with a 32 inch or smaller television set. Television stand model SP351B is designed for use with a 36 inch or smaller television set. Use of a smaller stand, a non Hitachi recommended stand or a generic stand may result in instability, causing possible injury.

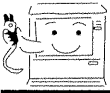

REMOTE CONTROL BATTERY INSTALLATION AND REPLACEMENT

1. Open the battery cover of the remote control by pushing the notched part of the cover with your fingers.
2. Insert two new "AA" size batteries for the remote control. When replacing old batteries, push them towards the springs and lift them out.
3. Match the batteries to the (+) and (-) marks in the battery compartment.
4. Replace the cover.

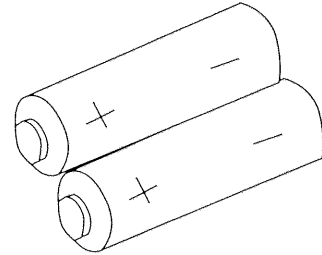

BOTTOM VIEW

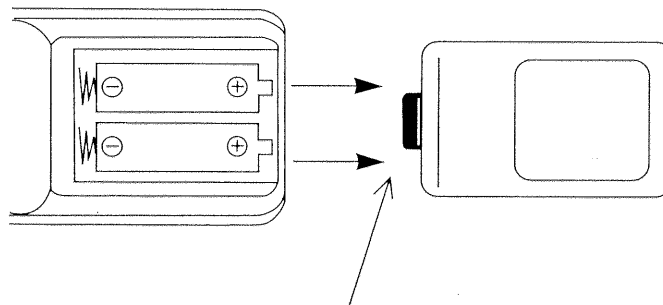

Push in and lift up on tab to remove back cover.

CAUTION:

1. If your television set is to remain unused for a long period of time, for instance when you go on vacation, unplug the television from the wall outlet.
2. Do not subject the remote control to shocks such as dropping it on the floor, etc. Precision parts may be damaged.
3. Do not allow the remote control to become wet and avoid placing it in areas of high humidity. Do not leave it on or near a heater. Excess heat or moisture may cause the unit to cease operation.
4. If the batteries become exhausted, remote control operation may become erratic or stop altogether. Replace the old batteries with new "AA" type.

NOTES:

1. The CHANNEL NO. and VOLUME are not displayed simultaneously.
2. To operate your TV, point the remote control at the remote sensor of the TV.

HOW TO SET UP YOUR NEW HITACHI COLOR TV

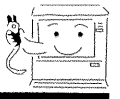

ANTENNA

Unless your TV is connected to a cable TV system or to a centralized antenna system, a good outdoor color TV antenna is recommended for best performance. However, if you are located in an exceptionally good signal area that is free from interference and multiple image ghosts, an indoor antenna may be sufficient.

LOCATION

Select an area where sunlight or bright indoor illumination will not fall directly on the picture screen. Also, be sure that the location selected allows a free flow of air to and from the perforated back cover of the set.

To avoid cabinet warping, cabinet color changes, and increased chance of set failure, do not place the TV where temperatures can become excessively hot, for example, in direct sunlight or near a heating appliance, etc.

VIEWING

The major benefit of the HITACHI Color Television is its large viewing screen. To see this large screen at its best, test various locations in the room to find the optimum spot for viewing. The drawings give several suggestions.

The best picture is seen by sitting directly in front of the TV and about 6 to 9 feet from the screen. During daylight hours, reflections from outside light may appear on the screen. If so, drapes or screens can be used to reduce the reflection or the TV can be located in a different section of the room.

If the TV's audio output will be connected to a Hi-Fi system's external speakers, the best audio performance will be obtained by placing the speakers equidistant from each side of the receiver cabinet and as close as possible to the height of the picture screen center. For best stereo separation, place the external speakers at least four feet from the side of the TV, place the surround speakers to the side or behind the viewing area. Differences in room sizes and acoustical environments will require some experimentation with speaker placement for best performance.

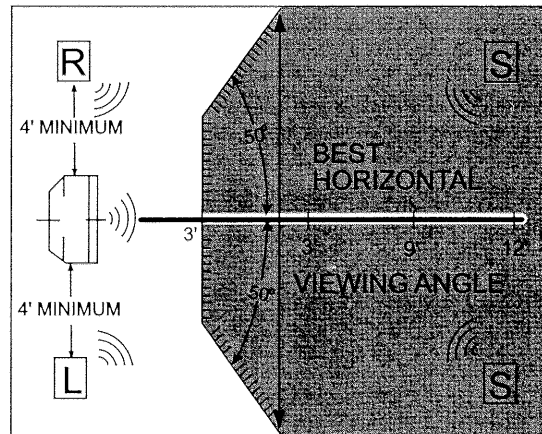
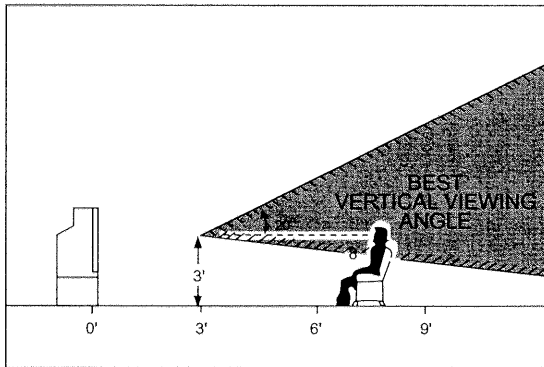

 **CAUTION:** Magnetic fields, such as those of external speakers, may cause the picture to distort if they are placed too close to the television. Move the magnetic field source away from the television until there is no picture distortion.

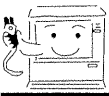

HOOK-UP CABLES AND CONNECTORS

Most video/audio connections between components can be made with shielded video and audio cables that have phono connectors. For best performance, video cables should use 75-Ohm coaxial shielded wire. Cables can be purchased from most stores that sell audio/video products. Below are illustrations and names of common connectors. Before purchasing any cables, be sure of the output and input connector types required by the various components and the length of each cable.

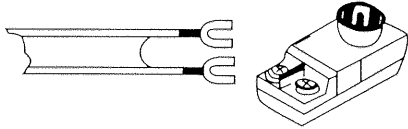

300-Ohm Twin Lead Connector

This outdoor antenna cable must be connected to an antenna adapter (300-Ohm to 75-Ohm).



"F" Type 75-Ohm Coaxial Antenna Connector

For connecting RF signals (antenna or cable TV) to the antenna jack on the television.

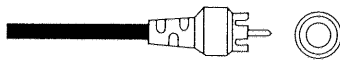

Phono Connector

Used on all standard video and audio cables which connect to inputs and outputs located on the television's rear jack panel and front control panel.



S-Video (Super Video) Connector

This connector is used on camcorders, VCRs, and laserdisc players with an S-Video feature in place of the standard video cable to produce a high quality picture.

Antenna Connections

1. VHF (75-Ohm) antenna/CATV (Cable TV)

When using a 75-Ohm coaxial cable system, connect the outdoor antenna or CATV coaxial cable to the ANT A (75-Ohm) terminal. If you have a second antenna or cable TV system, connect the coaxial cable to the ANT B terminal.

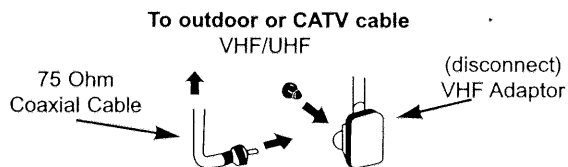

3. When both VHF and UHF antennas are connected

Attach an optional ANTENNA MIXER to the TV antenna terminal and connect the cables to the ANTENNA MIXER.

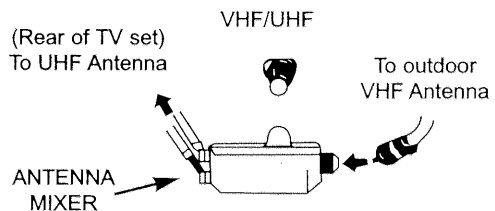

2. VHF (300-Ohm) antenna/UHF antenna

When using a 300-Ohm twin lead from an outdoor antenna disconnect the (VHF or UHF) indoor antenna leads from screws of the (VHF or UHF) adaptor and connect outdoor (VHF or UHF) antenna leads to these screws of a (VHF or UHF) adaptor.

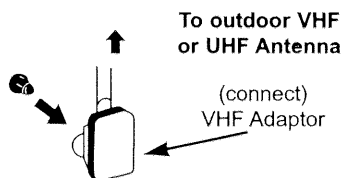

Notes:

1. If an outdoor antenna/CATV is used, disconnect the indoor antenna. Ghosting and poor reception may result if both the indoor and outdoor antennas/CATV are connected at the same time.
2. Consult your dealer or service store for the ANTENNA MIXER and (VHF or UHF) adaptor.
3. The special converter (decoder) will be supplied by the cable company.

FRONT PANEL CONTROLS FOR 32UX59B AND 36UX59B

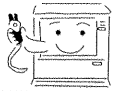

FRONT VIEW

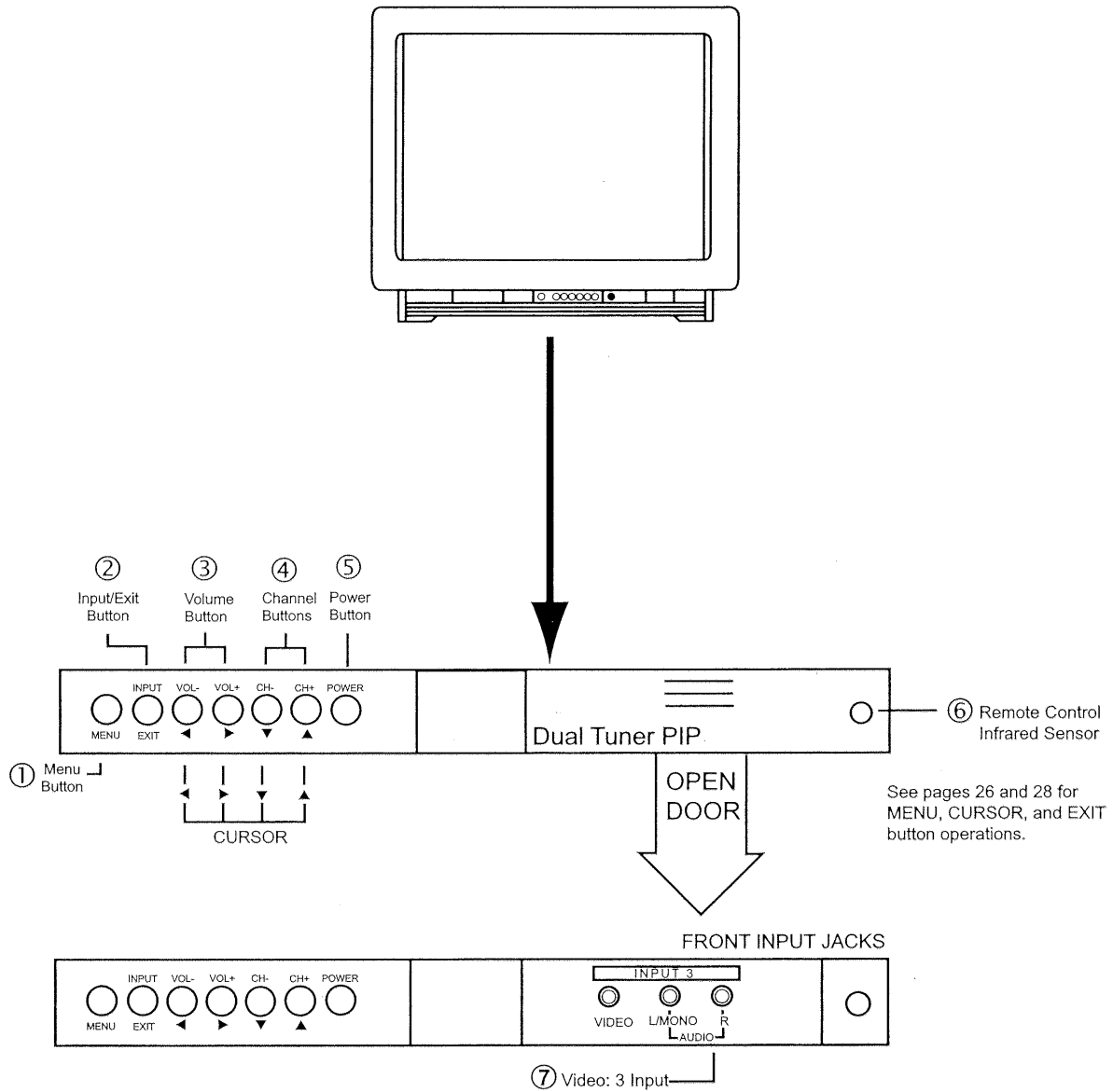

A detailed explanation of the circled numbers is on page 11.

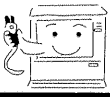

FRONT PANEL CONTROLS FOR 32CX39B, 32FX49B, 36CX39B AND 36FX49B

FRONT VIEW

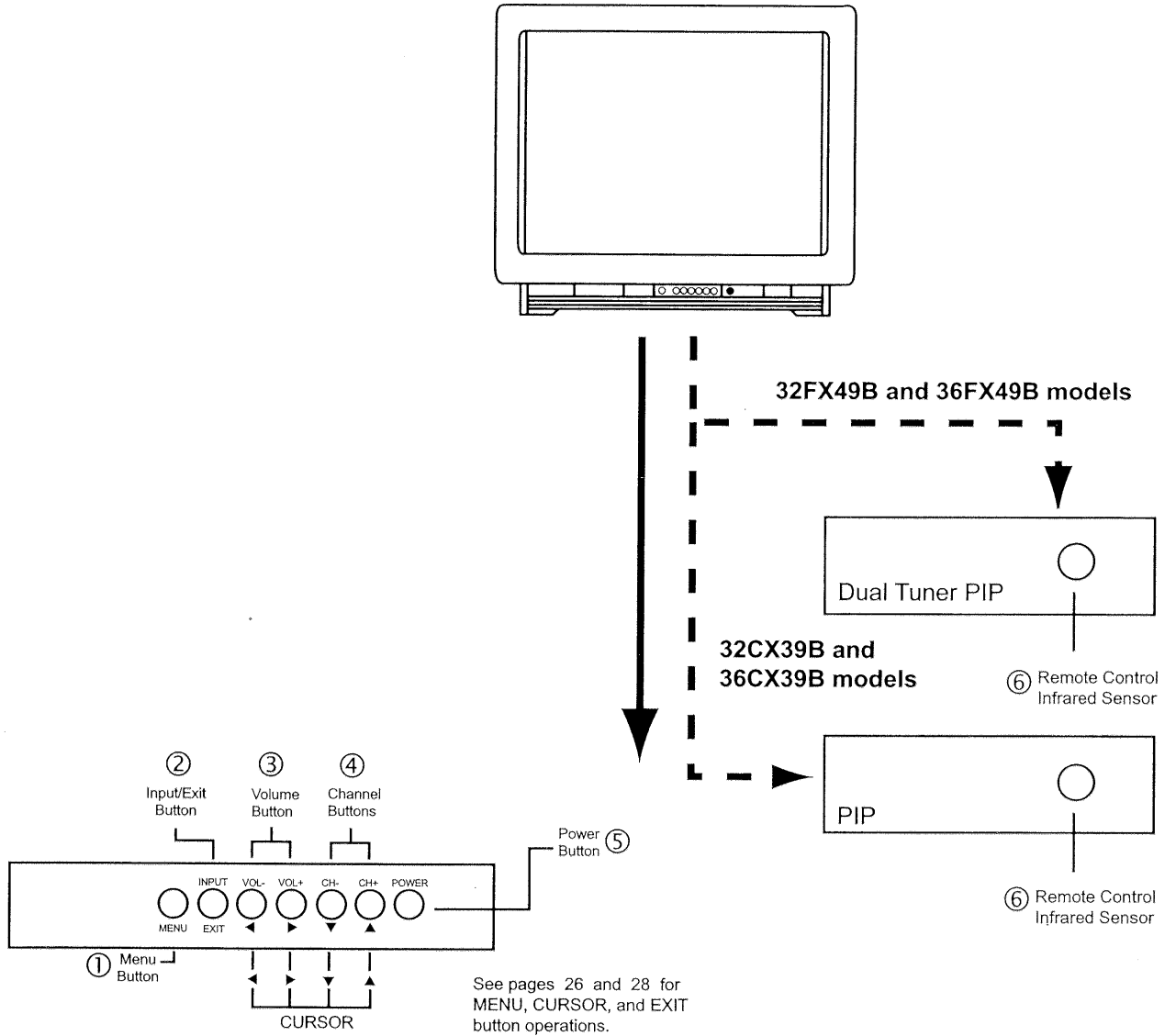

A detailed explanation of the circled numbers is on page 11.

FRONT PANEL JACKS AND CONNECTIONS

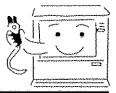

- ① **MENU Button**
This button allows you to enter the MENU, making it possible to set TV features to your preference with out using the remote.
- ② **INPUT/EXIT button**
Press this button to select the current antenna or VIDEO source. Your selection is shown in the top right corner of the screen. This button also serves as the EXIT button when in MENU mode.
- ③ **VOLUME Level**
Press these buttons for your desired sound level. The volume level will be displayed on the TV screen.
- ④ **CHANNEL Selector**
Press these buttons until the desired channel appears in the top right corner of the TV screen.
- ⑤ **POWER Button**
Press this buttons to turn the TV on or off.

NOTE: Your HITACHI TV will appear to be turned off if there is no video input when a VIDEO Source is selected. Press the INPUT button until the normal broadcast picture appears. (See page 27). If the picture does not appear, the power is OFF.

- ⑥ **REMOTE CONTROL INFRARED Sensor**
Point your remote control at this area when selecting channels, adjusting volume, etc.
- ⑦ **FRONT INPUT JACKS (32UX59B and 36UX59B models)**
Use these audio/video jacks for a quick hook-up to a camcorder or VCR to instantly view your favorite show or new recording. Press the INPUT button until VIDEO:3 appears in the top right corner of the TV screen. If you have mono sound, insert the audio cable into the left channel jack.

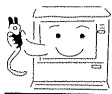

FRONT PANEL JACKS AND CONNECTIONS (32UX59B AND 36UX59B)

The front panel jacks are provided as a convenience to allow you to easily connect a camcorder or VCR as shown in the following examples:

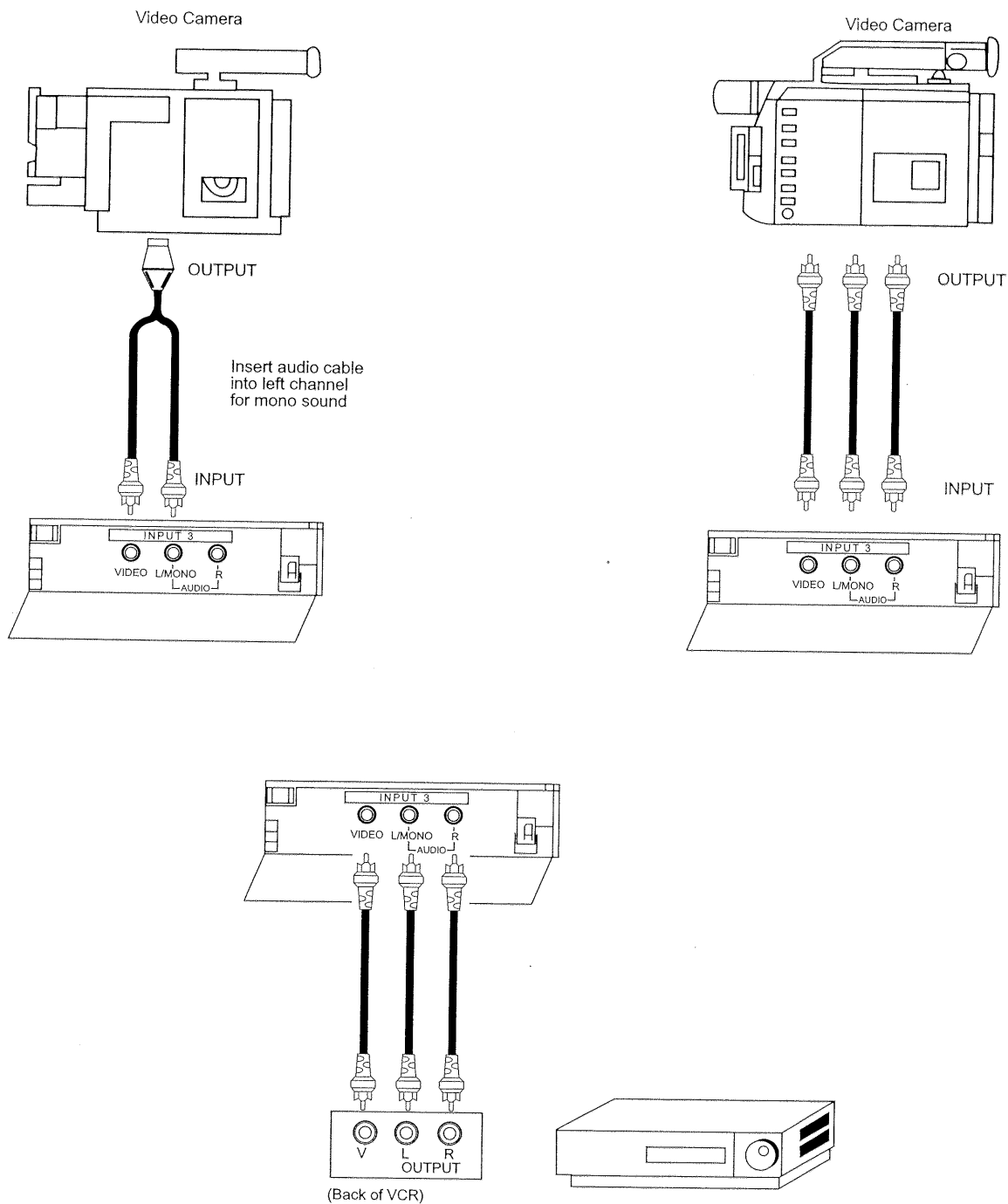

NOTE: Completely insert connection cord plugs when connecting to front panel jacks. If you do not, the picture that is played back may be abnormal.

REAR PANEL JACKS (32UX59B, 32FX49B, 36UX59B AND 36FX49B)

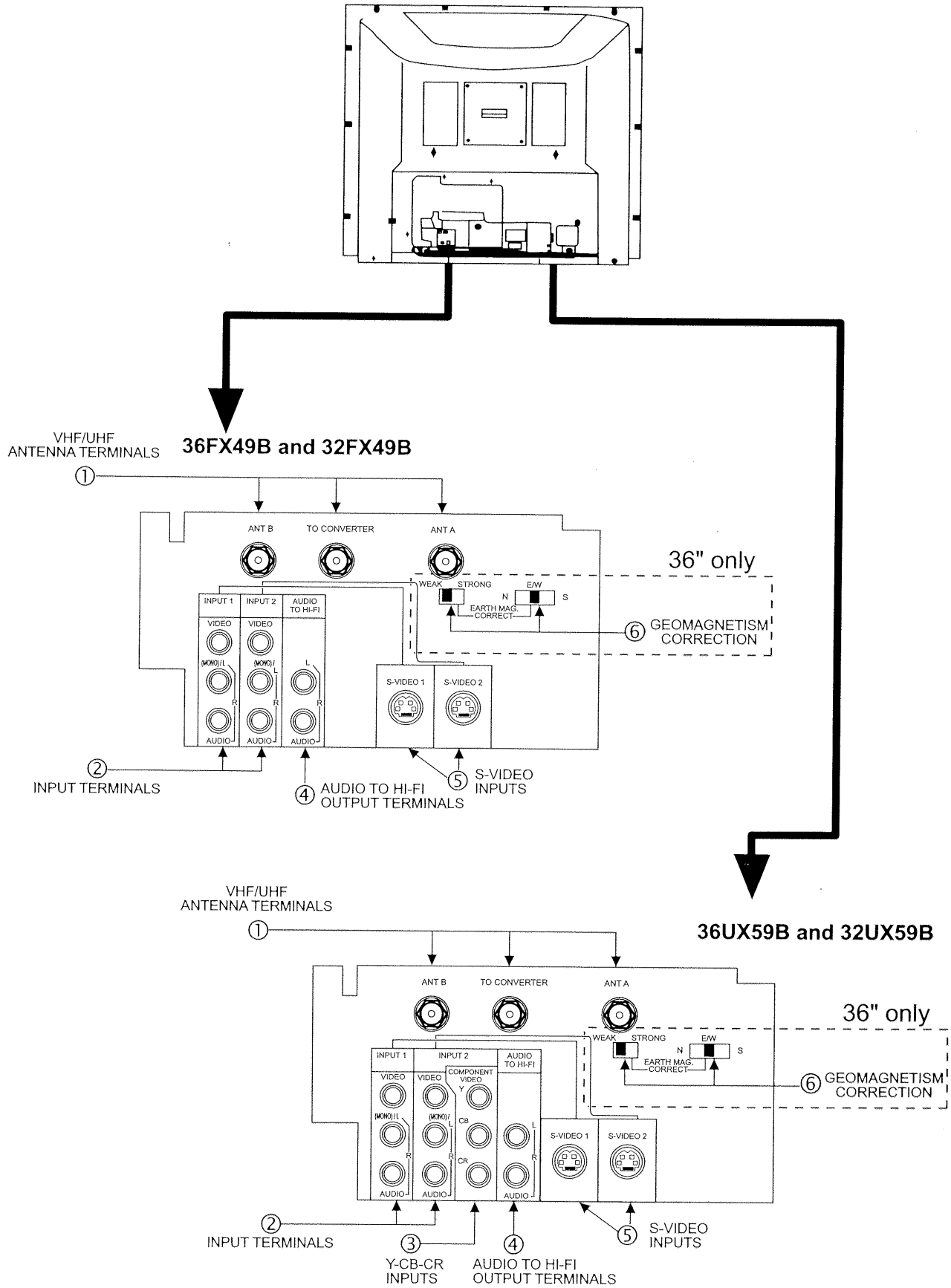
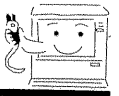

A detailed explanation of the circled numbers is on page 15.



REAR PANEL JACKS (32CX39B AND 36CX39B)

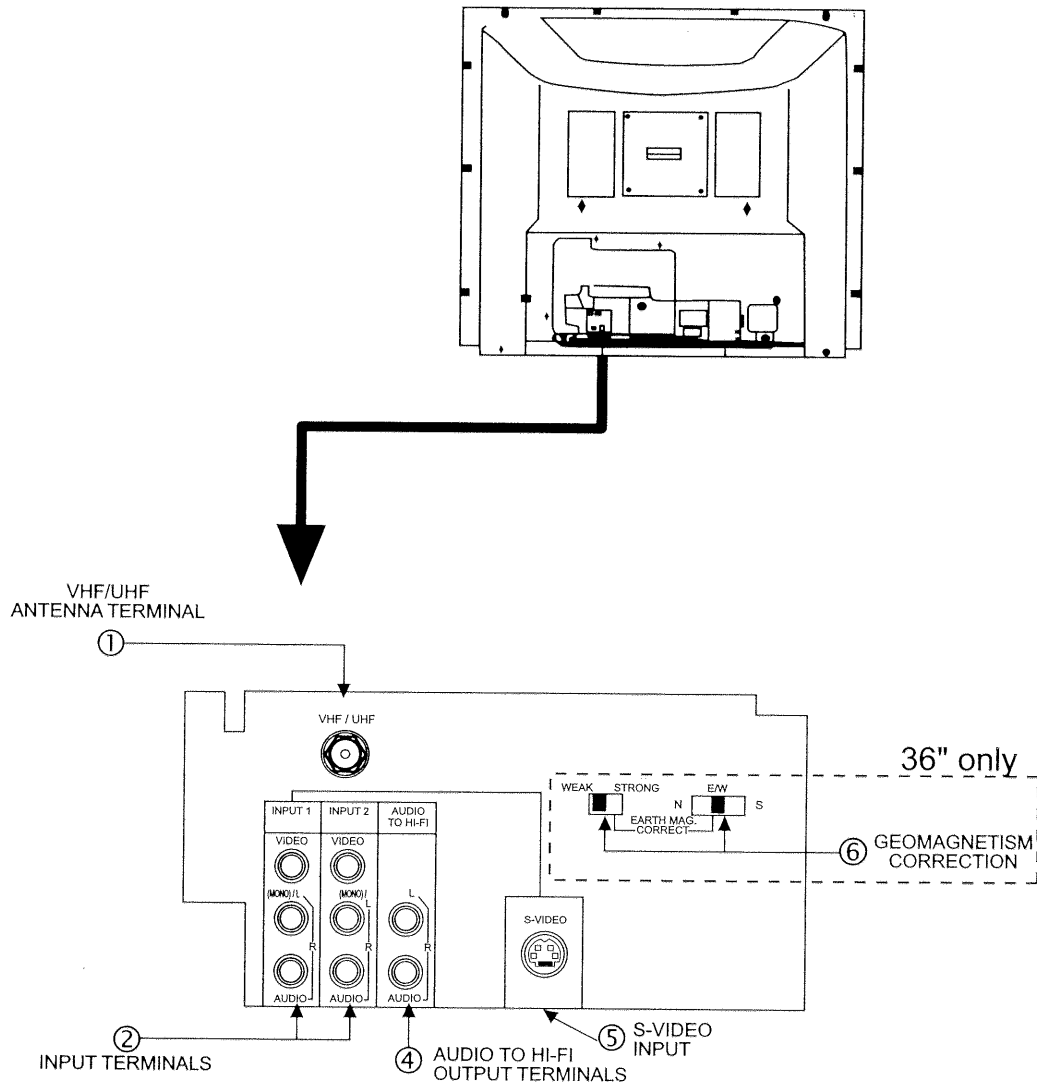

A detailed explanation of the circled numbers is on page 15.

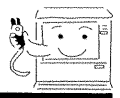

REAR PANEL JACKS

① Antenna Input (36CX39B and 32CX39B models)

The VHF/UHF terminal can be used for normal TV, cable TV (CATV), video game, etc.

Antenna Inputs (36/32UX59B and 36/32FX49B models)

The remote control allows you to switch between two separate 75-Ohm RF antenna inputs, ANT A and ANT B. ANT A input can be displayed as a main picture or sub-picture. ANT B can only be displayed as a main picture. (ANT B cannot be displayed as a sub-picture). The antenna output labeled "TO CONVERTER" allows ANT A connection to pass directly to a different source such as a cable box.

② Audio/Video Inputs

The INPUT button will step through each video source and antenna source input each time it is pressed. Use the audio and video inputs to connect external devices, such as VCRs, camcorders, laserdisc players, etc. (If you have mono sound, insert the audio cable into the left channel jack).

③ Y-CB-CR Input: 2 (36UX59B and 32UX59B models)

This input provides Y-CB-CR jacks for connecting equipment with this capability, such as a DVD Player.

NOTE: 36/32FX49B and 36/32CX39B models do not have Y-CB-CR Inputs.

④ Audio to HI-FI

These jacks provide variable audio output to a separate stereo amplifier. With this connection, the audio to the stereo can be controlled by the television's main volume. Use these jacks for the SURROUND Left and Right channels. (See page 23)

⑤ S-Video

Inputs 1, 2 for 36/32UX59B and 36/32FX49B models and Input 1 for 36/32CX39B models provide S-Video jacks for connecting equipment with S-Video output capability.

⑥ Geomagnetism Correction (36" models)

The effects of geomagnetism may cause an uneven (partially) colored picture depending on the direction the TV is facing. Adjust the TV as follows for best performance:

1. Turn the Power "Off".
2. Decide on the installation position and direction of the TV. Check the direction the TV is facing at this time.
3. Set the DIRECTION and STRENGTH switches (on back of the TV) according to the direction of the screen as shown in the table.

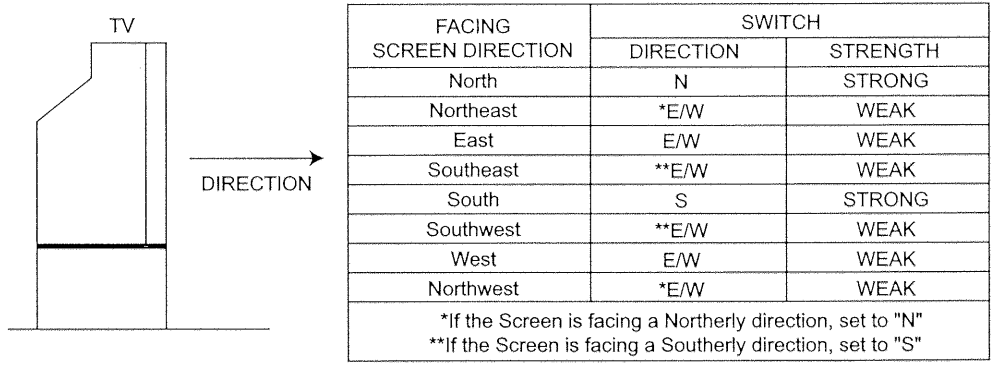

4. After setting the switches, place the TV in the decided location.
5. After relocating the TV, turn the power "ON" and check to make sure that the screen color (especially at the corners) is even. Depending on the installation location (especially where it is susceptible to geomagnetism, for example, in a reinforced concrete building), in this case, set the DIRECTION and STRENGTH switches to set the optimum picture.
6. In certain areas, if the screen points North or South, color unevenness may be reduced when the STRENGTH switch is set to STRONG rather than WEAK.

NOTE: If you move your TV, the DIRECTION and STRENGTH switches may need to be reset.

TIPS ON REAR PANEL CONNECTIONS

The S-Video connections are provided for high performance laserdisc players, VCRs etc. that have this feature. Use these connections in place of the standard video connection if your device has this feature.

COMPONENT: Y-CBCR connections are provided for high performance components, such as DVD players. Use these connections in place of the standard video connection if your device has this feature.

When using the Y-CBCR input jacks, connect your components audio output to the TV's Input 2 Left and Right Audio input jacks. If your device has only one audio output (mono sound), connect it to the left audio jack on the television.

Refer to the operating guide of your other electronic equipment for additional information on connecting your hook-up cables.

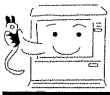

REAR PANEL CONNECTIONS (32UX59B AND 36UX59B)

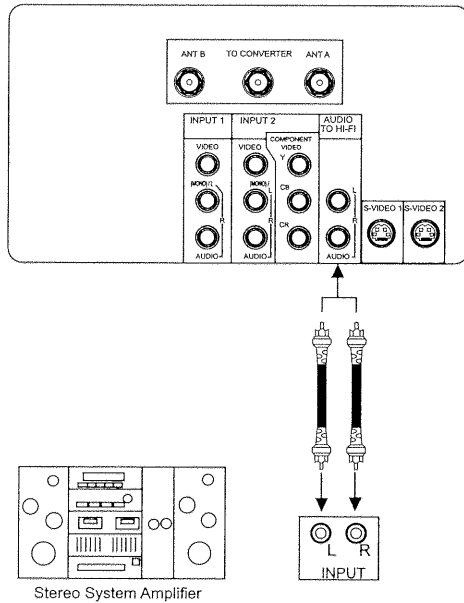
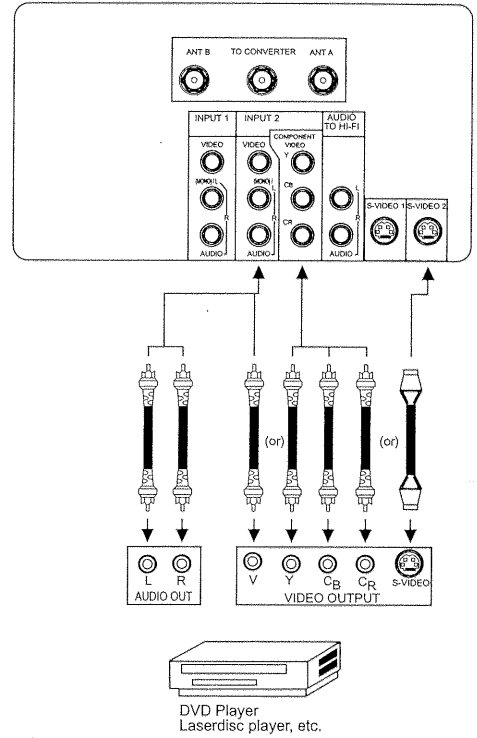
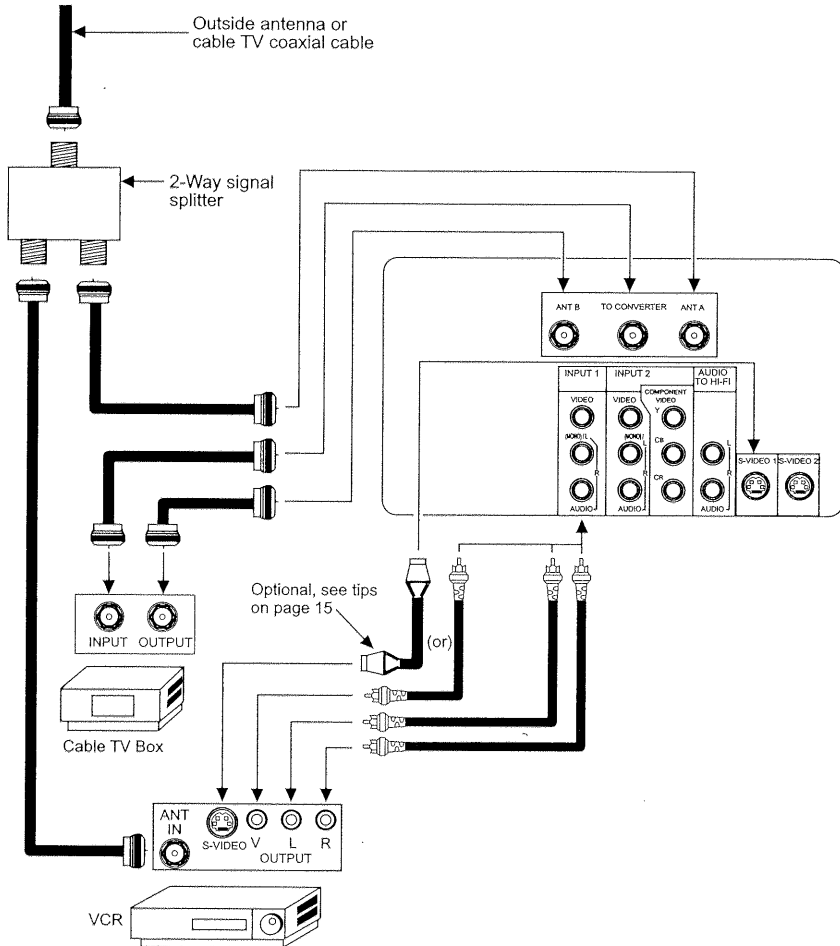

Typical full feature setup. Follow connections that pertain to your personal entertainment system.

REAR PANEL CONNECTIONS (36FX49B AND 32FX49B)

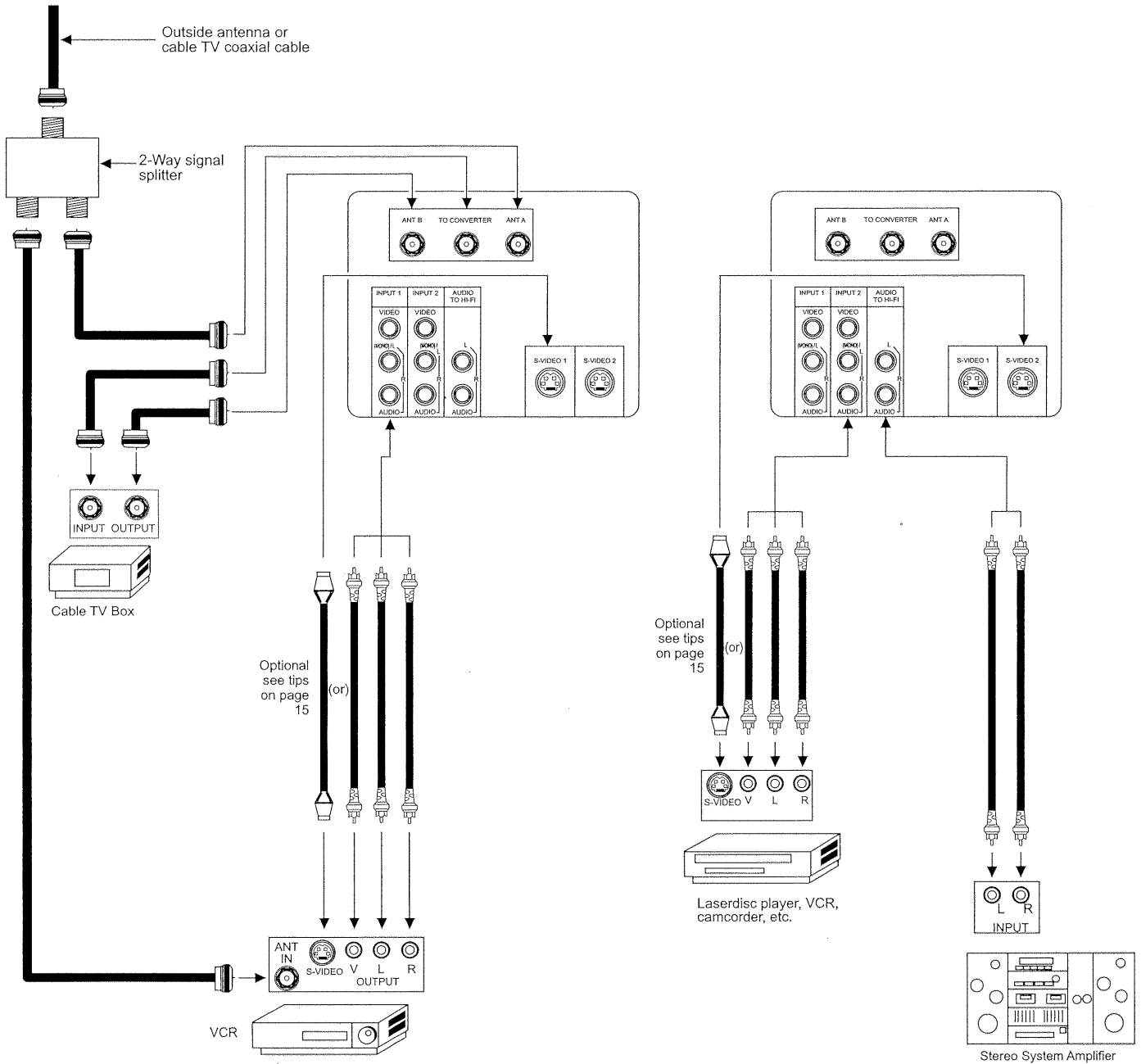
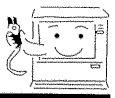

Typical full feature setup. Follow connections that pertain to your personal entertainment system.

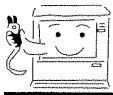

REAR PANEL CONNECTIONS (32CX39B AND 36CX39B)

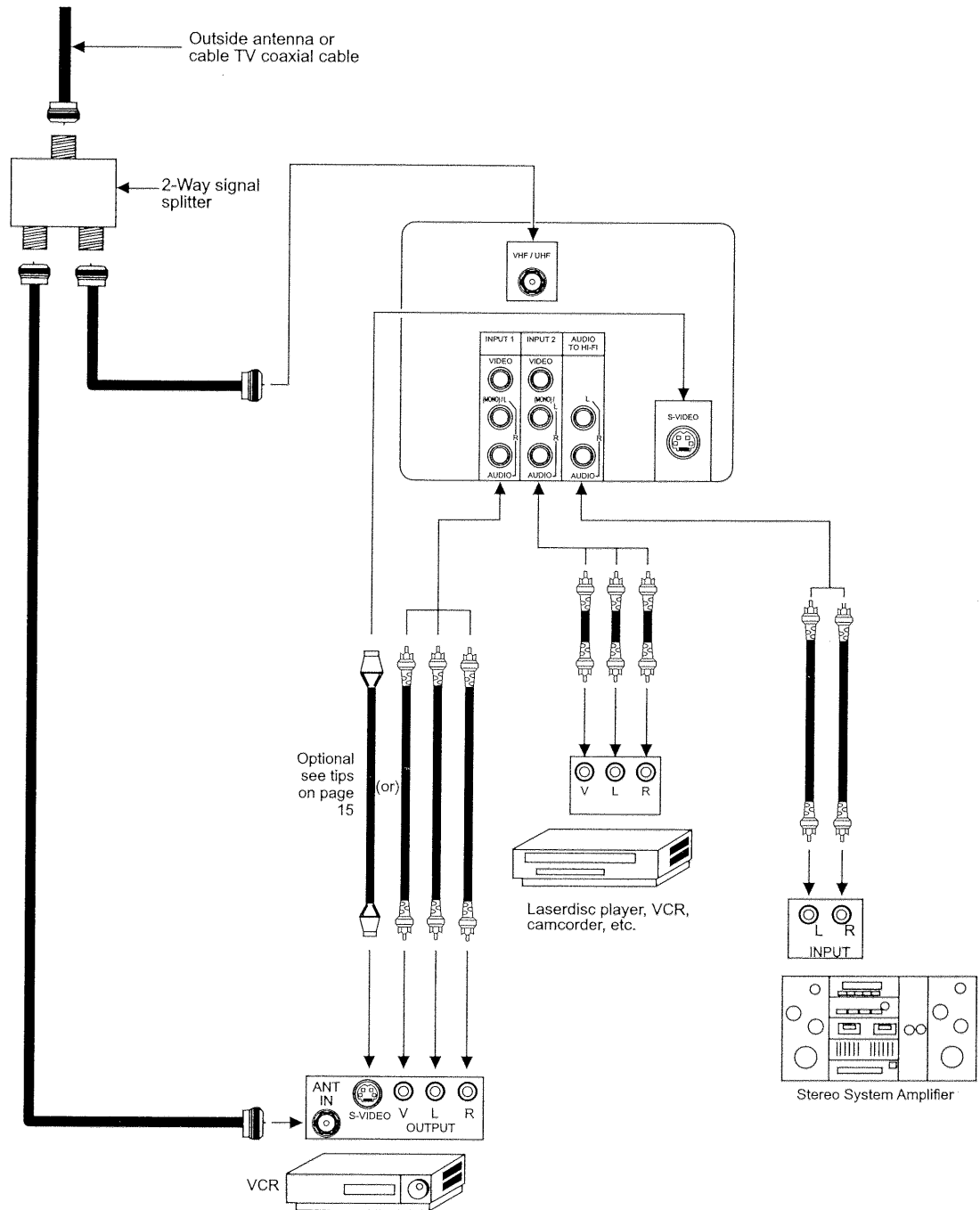

Typical full feature setup. Follow connections that pertain to your personal entertainment system.

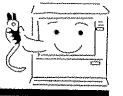

EXTERNAL CONNECTIONS

CONNECTING EXTERNAL AUDIO AMPLIFIER

To control the audio level of an external audio amplifier with the remote control, connect the system as shown below.

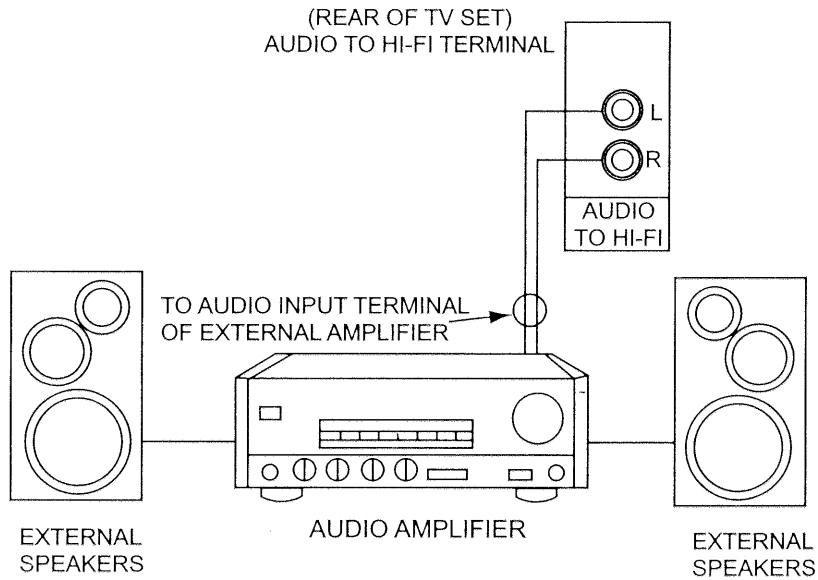

NOTE: To prevent damage to the speaker and distorted sound, set the volume control of the audio amplifier lower and adjust the sound using the remote control of the TV set.

CONNECTING EXTERNAL VIDEO SOURCES

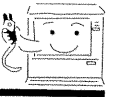

CONNECTING A STEREO VCR OR STEREO LASERDISC PLAYER

1. Connect the cable from the VIDEO OUT of the VCR of the laserdisc player to the INPUT (VIDEO) jack on the TV set below.
2. Connect the cable from the AUDIO OUT R of the VCR or the laserdisc player to the INPUT(AUDIO/R) jack.
3. Connect the cable from the AUDIO OUT L of the VCR or the laserdisc player to the INPUT(AUDIO/L) jack.
4. Press the INPUT button to view the program from the VCR or laserdisc player. The mode VIDEO disappears automatically after approximately eight seconds.
5. Press the INPUT button to return to the previous source.

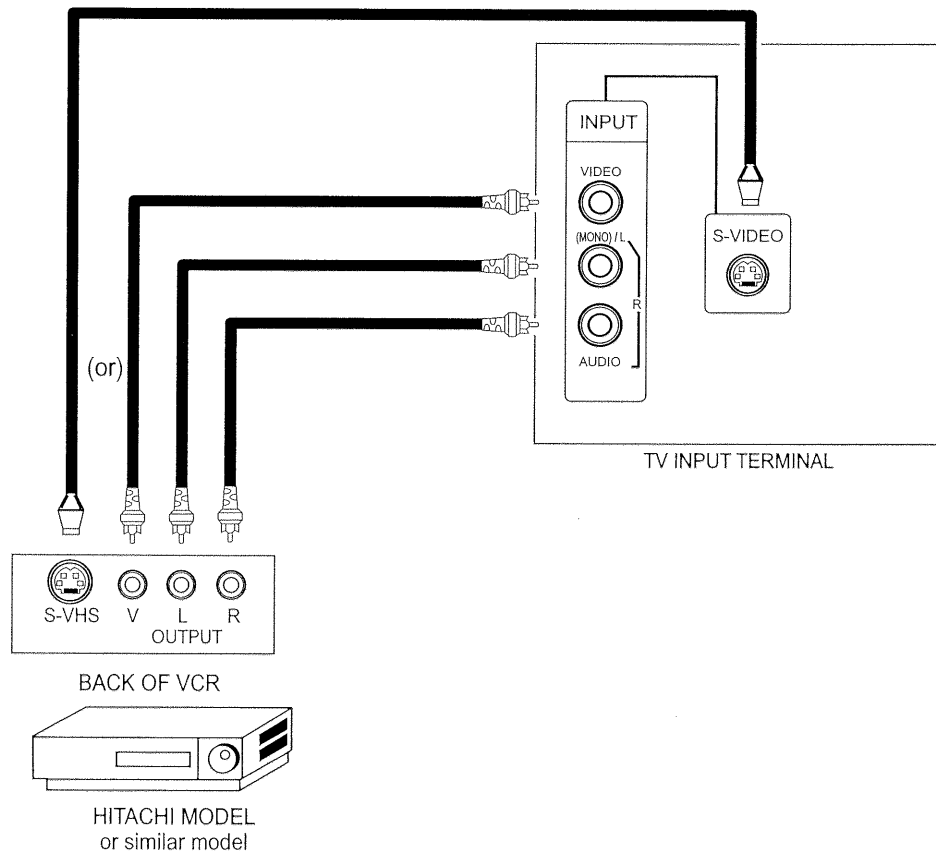

NOTE: Completely insert the connection cord plugs when connecting to rear panel jacks. The picture that is played back will be abnormal if the connection is loose.

If you have an S-VHS VCR, use the S-INPUT cable in place of the standard video cable.



CONNECTING EXTERNAL VIDEO SOURCES

CONNECTING A STEREO LASERDISC PLAYER OR DVD PLAYER WITH COMPONENT OUTPUT CAPABILITY.

1. Connect the cable from the Y OUT of the Laserdisc or the DVD player to the INPUT 2 (Y) jack as shown below.
2. Connect the cable from the C_B OUT of the Laserdisc or the DVD player to the INPUT 2 (C_B) jack, as shown below.
3. Connect the cable from the C_R OUT of the Laserdisc or the DVD player to the INPUT 2 (C_R) jack, as shown below.
4. Connect the cable from the AUDIO OUT R of the Laserdisc or DVD player to the INPUT 2 (AUDIO/R) jack.
5. Connect the cable from the AUDIO OUT L of the Laserdisc or DVD player to the INPUT 2 (AUDIO/L) jack.
6. Press the INPUT button until Y-CBCR appears, to view the program from the Laserdisc or DVD player. The mode Y-CBCR disappears automatically after approximately eight seconds.
7. Press the INPUT button to return to the previous source.

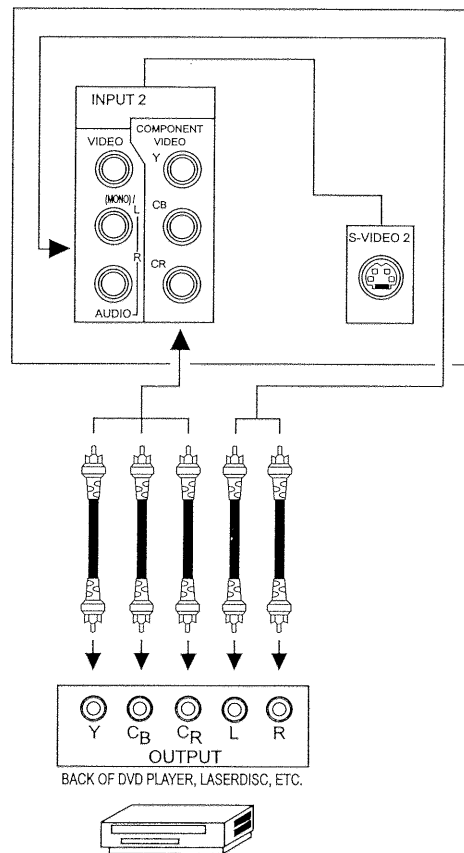

NOTE: Completely insert the cable connection when connecting to rear panel jacks. The picture that is played back will be abnormal if the connection is loose.
If you have a COMPONENT DVD or LASERDISC, use the COMPONENT connections in place of the standard or S-Video connection.
See Page 15 for TIPS ON REAR PANEL CONNECTIONS.

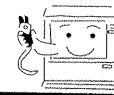

AUDIO SYSTEM SETUP

Match the numbers below to the diagrams for speaker placement and refer to the table for the different surround sound requirements (See page 57 for SURROUND functions).

- ① The television's internal speakers.
- ② These speakers are connected to a separate audio amplifier. Use the "Audio to HI-FI" output on the television.

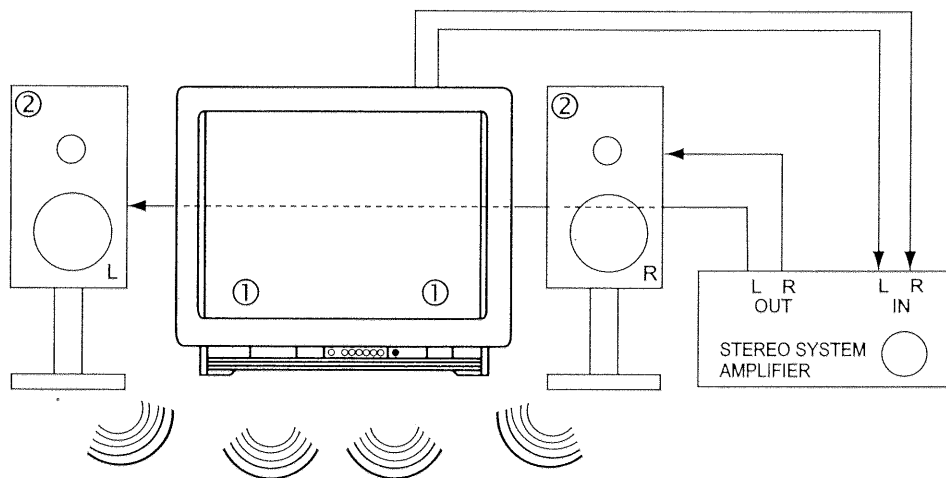

| 3 WAYSURROUND FEATURE | REQUIRED CONNECTION | OPTIONAL CONNECTION | EFFECT |
|-----------------------|---------------------|---------------------|--|
| OFF | ① | ② | Receive mono and stereo sound. |
| MUSIC | ① ② | -- | At stereo input, sound of music will be louder. Surround channel added to left and right audio amplifier speakers. |
| MOVIE | ① ② | -- | Movie theater reproduction, surround channel added to left and right audio amplifier speakers. |
| SIMULATE | ① | ② | At mono input, sound will be louder. |



THE REMOTE CONTROL

In addition to controlling all the functions on your HITACHI Color TV, the new remote control is designed to operate different types of VCRs, CATV (Cable TV), and satellite converters with one touch. Basic operation keys are grouped together in one area.

To operate your TV, point the remote control at the remote sensor of the TV and press the TV button. The remote will now control your television.

To operate your VCR, point the remote at the remote sensor of the VCR and press the VCR button. The remote will now control your VCR. (See page 32 for instructions on how to program the remote to control your VCR).

To operate your cable/satellite box, point the remote at the remote sensor of the cable/satellite box and press the CABLE button. The remote will now control your cable/satellite box. (See page 33 for instructions on how to program the remote to your cable/satellite box).

These buttons allow the remote to control your TV, VCR, or cable/satellite box depending on which mode is chosen, as explained above.

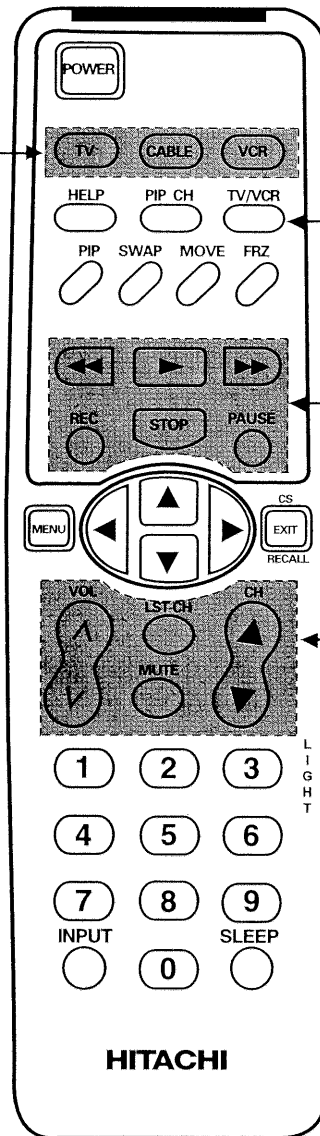

TV/VCR BUTTON

When the remote is in the TV or VCR mode, this is the TV/VCR button. When the remote is in the CABLE mode, this is the A/B button.

PRECODED VCR BUTTONS

These buttons always transmit the chosen pre-coded VCR codes.

LIGHT BUTTON (CLU-4111UI)

When you are in a dark room, press the light button on the side of the remote to light up the buttons shown. The light will stay on for about 8 seconds if the light button is not pressed again. These buttons will not appear to light if the room is too bright.

HOW TO USE THE REMOTE TO CONTROL YOUR TV



A detailed explanation of the circled numbers follows on pages 26 to 28.

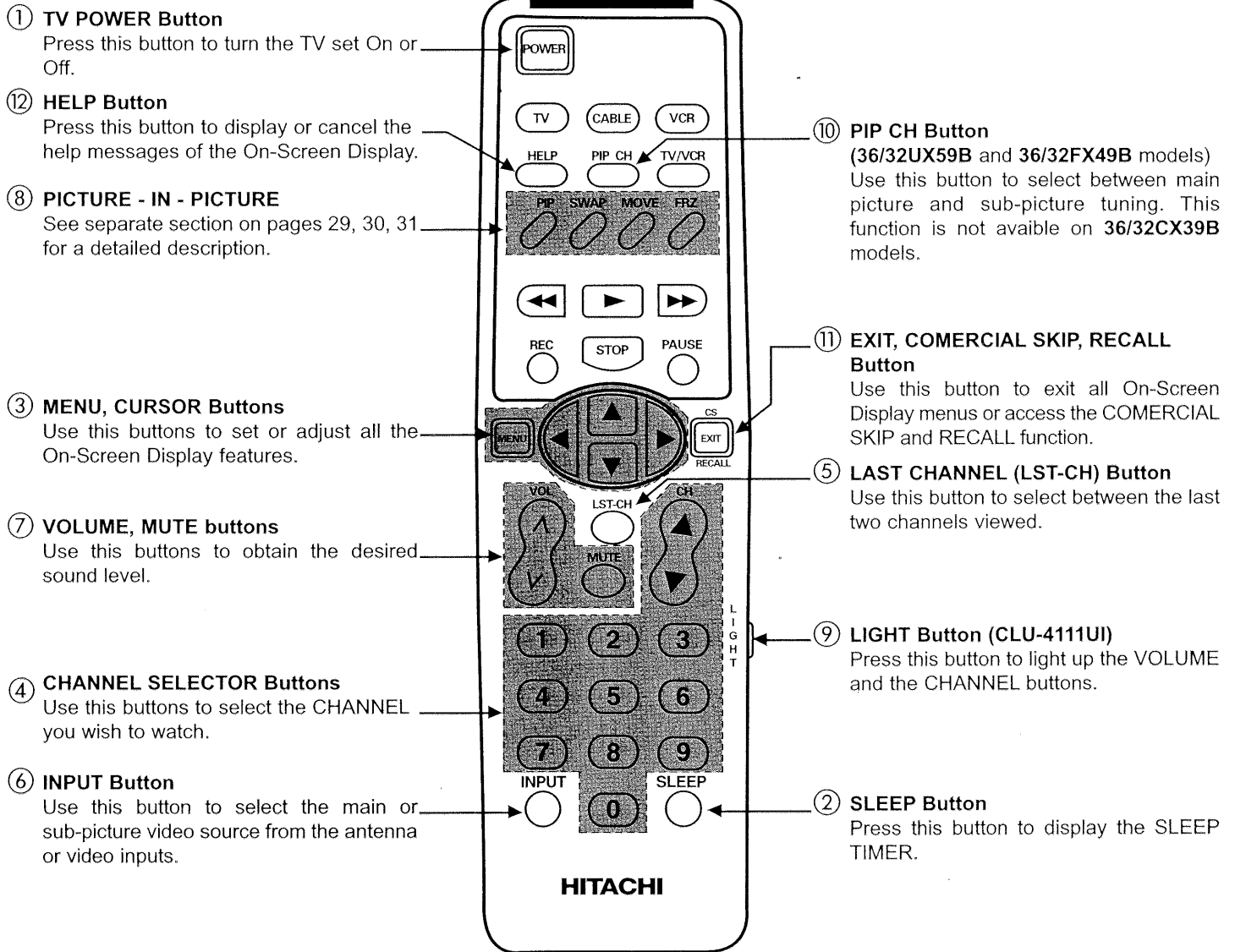



HOW TO USE THE REMOTE TO CONTROL YOUR TV

① **TV POWER Button**
Press this button to turn the TV set on or off. If a Special Event Reminder is set, it will be displayed when the TV is first turned on. (See page 58).

② **SLEEP Button**
Press this button to display the SLEEP TIMER in the lower left corner of the screen. Every subsequent press of this button will add 15 minutes to the timer, up to a maximum of three hours.

③ **MENU, CURSOR Buttons**
All On-Screen Display features can be set or adjusted by using these buttons.

The MENU button will start the On-Screen Display.

The CURSOR buttons will highlight functions or adjust and set different features when MENU is pressed.

The CURSOR button will move PIP position when PIP is on.

CURSOR buttons will also give you access to FAMILY FAVORITE On-Screen Display.

④ **CHANNEL SELECTOR Buttons**
Enter two or three numbers to select channels. Enter "0" first for channels 1 to 9. For channels 100 and above, press the "1" button and wait for two seconds before pressing the last two digits of the channel.

Channel selection may also be performed by pressing CH up (▲) or down (▼).

You may also use these buttons for channel scanning. Press and hold the CH up (▲) or down (▼) buttons and the TV will start quickly scanning through the channels. Release the CH up (▲) or down (▼) buttons when the TV scans to the channel you wish to watch and the TV will tune to that channel.

NOTE: The TV may not receive some channels if you are not in the correct SIGNAL SOURCE mode. (See page 39).

⑤ **LAST CHANNEL (LST-CH) Button**
Use this button to select between the last two channels viewed. (Good for watching two sporting events, etc).

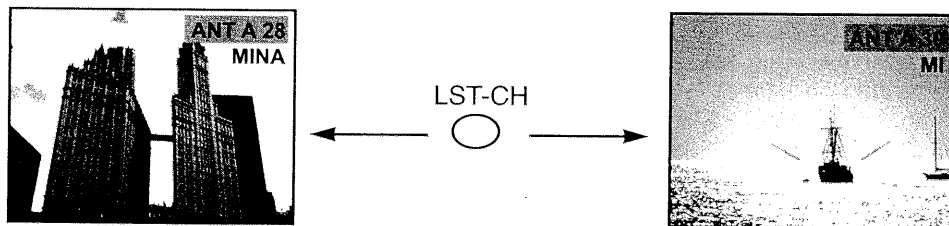

HOW TO USE THE REMOTE TO CONTROL YOUR TV



⑥ INPUT Button

36/32UX59B and 36/32FX49B models:

The INPUT button will select between both antenna signals and the video inputs; if the Sub-Picture is on, and the main picture is chosen with the PIP CH, the main picture will alternate between the video inputs and both antenna sources by every press of the INPUT button, if the Sub-Picture is chosen with the PIP CH, the Sub-Picture will alternate between the video inputs and antenna A source by every press of the INPUT button.

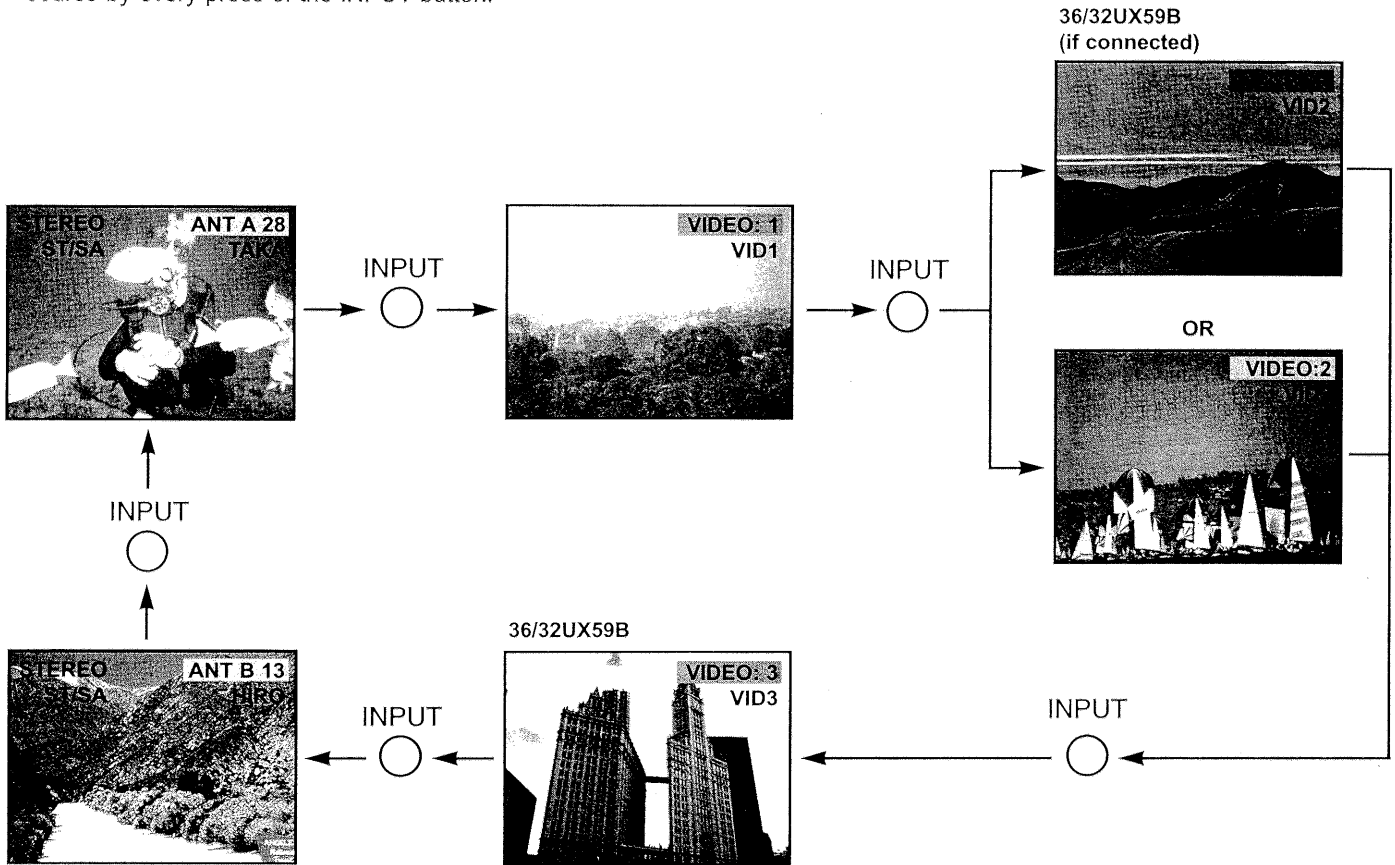

36/32CX39B models:

The INPUT button will select between antenna signal and the two sets of video inputs; if the Sub-Picture is on, the Sub-Picture will alternate between the two sets of video inputs and antenna source by every press of the INPUT button.

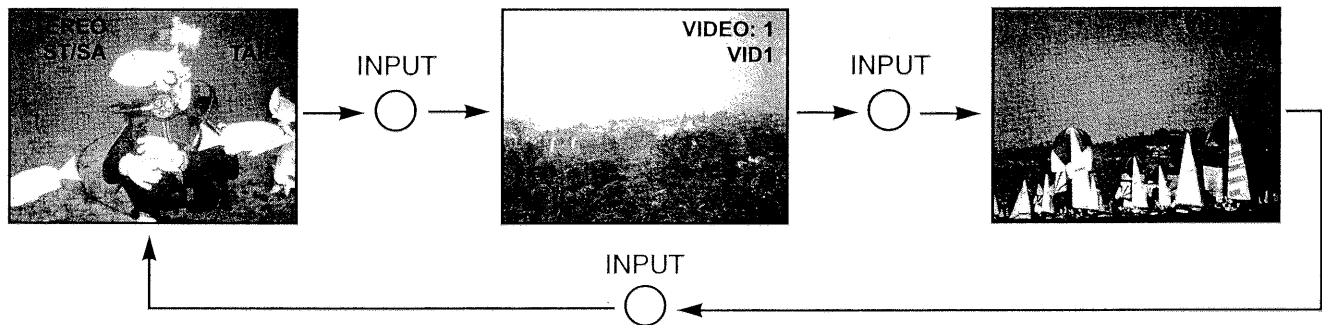

- Note:**
1. 36/32UX59B and 36/32FX49B models, antenna B can not be displayed as a Sub-Picture,
 2. 36/32UX59B models, Y-CBCR can not be displayed as a Sub-Picture.
 3. Signals priority:
 - Component Signal (Y-CBCR); Has the highest priority when connected in VIDEO 2 mode.
 - Super Video Signal; Has a higher priority than the normal video signal in VIDEO 1 and VIDEO 2 modes.



HOW TO USE THE REMOTE TO CONTROL YOUR TV

⑦ VOLUME, MUTE buttons

Press the VOLUME up (▲) or down (▼) button until you obtain the desired sound level.

To reduce the sound to one half of normal volume (SOFT MUTE) to answer the telephone, etc., press the MUTE button. Press the MUTE button again to turn the sound off completely (MUTE). To restore the sound, press the MUTE button one more time, or press the VOLUME up (▲) button.

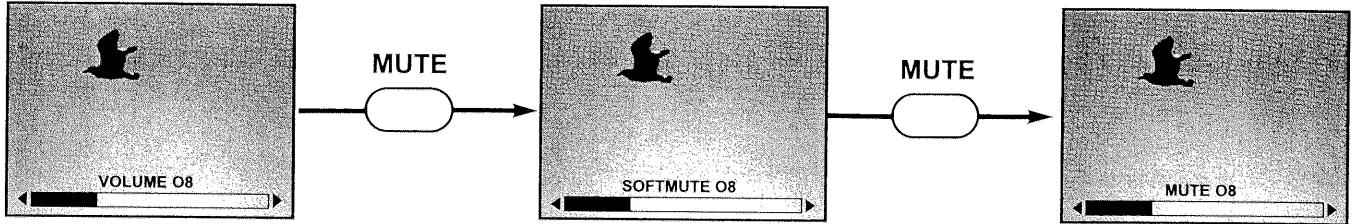

⑧ PICTURE-IN-PICTURE

See separate section on pages 29, 30 and 31 for a description.

⑨ LIGHT Button (CLU-4111UI)

When you are in a dark room, press this button to light up the volume and the channel buttons. The light will stay on for about eight seconds if no buttons are pressed. The buttons will not appear to light if the room is too bright.

⑩ PIP CH Button (36/32UX59B and 36/32FX49B models)

Use the PIP CH button to select between main picture and sub-picture tuning. The gray background on the channel number will indicate which channel is being controlled. This function it's not available on 36/32CX39B models.

⑪ EXIT COMMERCIAL SKIP, RECALL Button.

When in MENU mode, this button will exit all On-Screen Displays.

Press this button two times, in a 2 seconds interval of time, when no menu is displayed to access the COMMERCIAL SKIP (CS) function. The COMMERCIAL SKIP timer icon will be displayed in the lower left corner of the screen beginning from 30 seconds of time out. Every subsequent press of this button will add 30 seconds to the COMMERCIAL SKIP timer, up to a maximum of 180 seconds. In COMMERCIAL SKIP, you can change to any station you wish to view with CH Up or Down and the digit keys, but after the COMMERCIAL SKIP timer reaches zero, it automatically changes back to the original station.

Press this button when no menu is displayed to enable RECALL function. Use the RECALL function to check the channel being received, or if it has stereo (ST) or second audio (SAP).

You can also check the time, CHANNEL and VIDEO ID, if they are set.

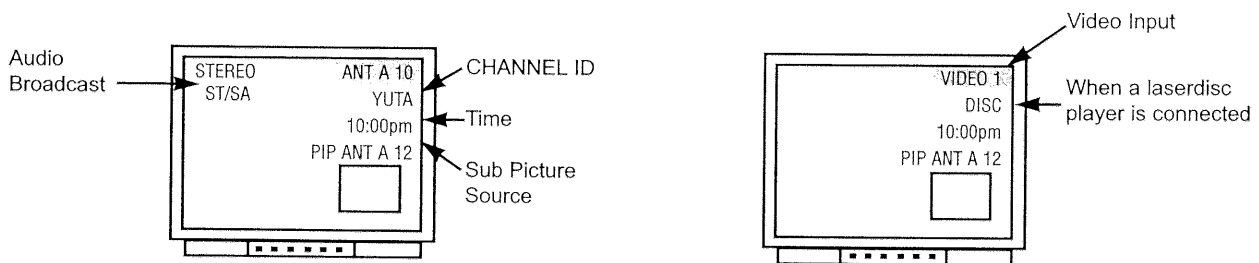

⑫ HELP Button.

Press this button if help is needed to change menu settings, and our context sensitive help system will provide explanations and/or directions for whatever function your cursor is on at that time.

Press this button again to cancel the help messages.



PICTURE-IN-PICTURE (PIP)

36/32UX59B and 36/32FX49B models:

The Picture-in-Picture feature is convenient when you want to watch more than one program at the same time. You can watch a TV program while viewing other programs from the antenna source or any of the video inputs.

Your HITACHI Color TV incorporates Dual Tuner technology designed for improved viewing enjoyment. This Dual Tuner feature allows you to view antenna inputs on both the main picture and Sub-Picture simultaneously, with separate tuning control for each. The Dual Tuner can operate with only one input (ANT A only) or two inputs (ANT A and ANT B).

ANT A input can be viewed as the main picture and as the Sub-Picture. ANT B can only be viewed as a main picture. To select between main picture and PIP Sub-Picture while tuning, press PIP CH button on the remote. The gray background will move with every press of the PIP CH button. When the gray background is on the top channel display, channel tuning is for the main picture. When the gray background is on the lower channel display, channel tuning is for the Sub-Picture. This method of picture tuning is the same for one antenna input (ANT A only) and two antenna inputs (ANT A and ANT B).

36CX39B and 32CX39B models:

Do not incorporate Dual Tuner technology.

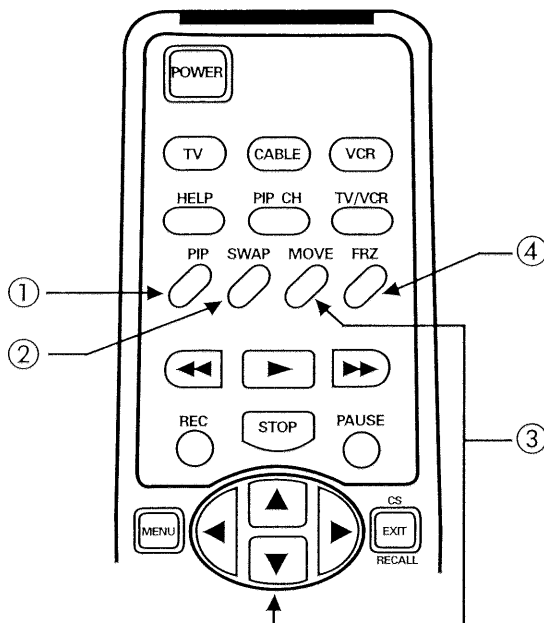

① PIP button

36UX59B, 32UX59B, 36FX49B and 32FX49B models:

Press the PIP button and a Sub-Picture appears in one corner of the screen. Press the button again to remove the Sub-Picture from the screen. Use the PIP CH button to select between main and Sub-Picture tuning control (indicated by the gray background on the channel numbers). Press the INPUT button when Sub-Picture channel tuning is being controlled, to change between the Video Inputs and ANT A antenna source (ANT B source cannot be viewed as a Sub-Picture).

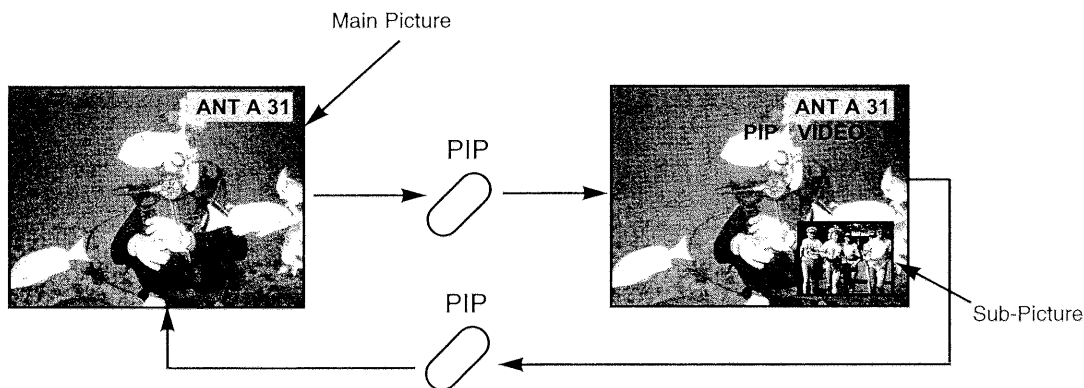

NOTE: When PIP is displayed, the CURSOR button will not activate the FAMILY FAVORITE menu. The CURSOR button will move the PIP position.



PICTURE-IN-PICTURE (PIP)

36CX39B and 32CX39B models:

Press the PIP button and a Sub-Picture appears in one corner of the screen. Press the button a second time to remove the Sub-Picture from the screen.

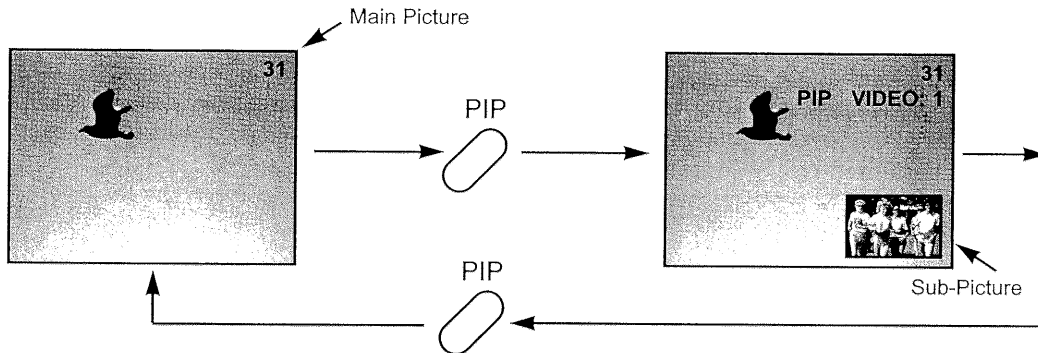

② SWAP Button

If you wish to switch what is being shown on the main picture to the Sub-Picture, press the SWAP button.

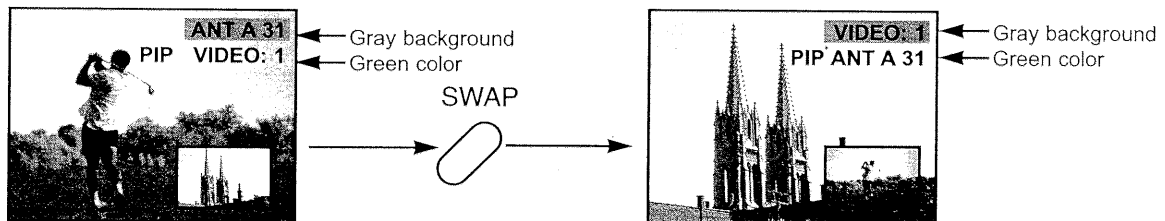

NOTE: The SWAP function will not operate if ANT B input is set as the main channel (ANT B input cannot be displayed as a sub-picture).
Models **36/32CX39B** do not have ANT B input.

③ MOVE Button

To move the sub-picture to another corner, press the MOVE button. The sub-picture moves one step counterclockwise every time the MOVE button is pressed. (Example below illustrates the MOVE operation for initial shipping conditions. If you have customized a PIP position, the MOVE operation may differ slightly from this example).
It is also possible to customize the PIP position. To do this, press the CURSOR ▲, ▼, ►, ◀ buttons.

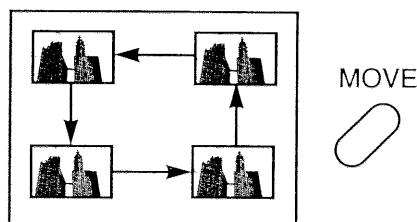

PICTURE-IN-PICTURE (PIP)

④ FREEZE (FRZ) Button

If you wish to freeze the Sub-Picture, press the FRZ button. This is convenient when trying to write down the address for a mail order company, recording statistics for a sporting event, etc. To return the picture to motion, press the FRZ button again.

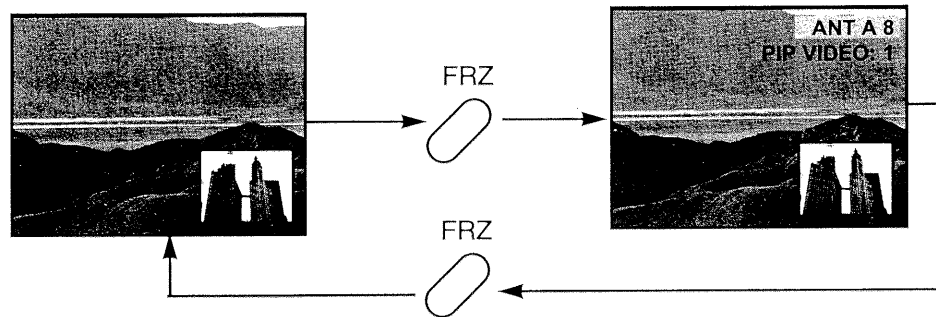

⑤ QUICK FREEZE (FRZ) Button

Press this button without a Sub-Picture to freeze the picture you are currently viewing. Press this button again to return to normal viewing.

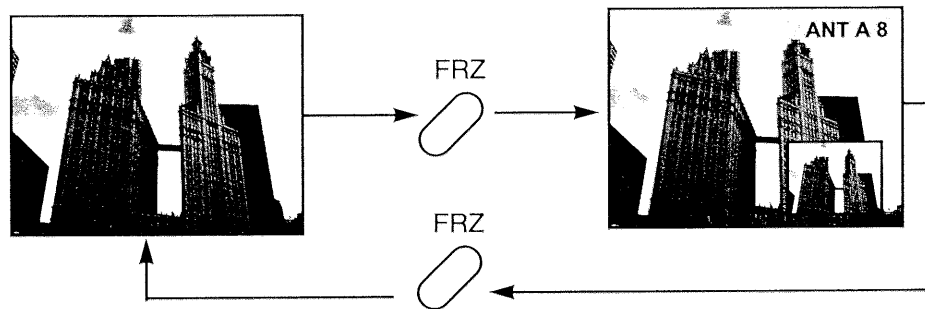

NOTE: 36/32UX59B models, Y-CBCR signal can not be displayed as a Sub-Picture.

 **CAUTION:** A pattern burn may develop if the Sub-Picture is left in the same corner permanently. If the PIP feature is used frequently, occasionally shift the Sub-Picture to a different corner. You may also vary its position using the CURSOR ◀, ▶, ▲, or ▼ buttons.



USING THE REMOTE TO CONTROL VCR FUNCTIONS

Operating the precoded function for your VCR.

This remote is designed to operate different types of VCRs. You must first program the remote to match the remote system of your VCR. (Refer to page 34).

1. Turn ON your VCR.
2. Aim the remote control at the front of your VCR.
3. Press the VCR button to switch to the VCR pre-coded mode.
4. Hold down the VCR button on the remote, enter the two digit preset code that matches your VCR as shown in page 34. The remote will turn off your VCR when the correct two digit preset code is entered. When this occurs, the remote control is programmed for your VCR. If the VCR does not turn off after five seconds, try a different two digit preset code.
5. The remote will now control your VCR.

VCR Button

This button allows the remote to control your VCR by setting it to VCR mode.

EXCLUSIVE TV Buttons

These buttons are for operating the TV.

PRECODED VCR Buttons

These buttons transmit the chosen precoded VCR codes. For some VCRs, you must press the RECORD button twice to record a program

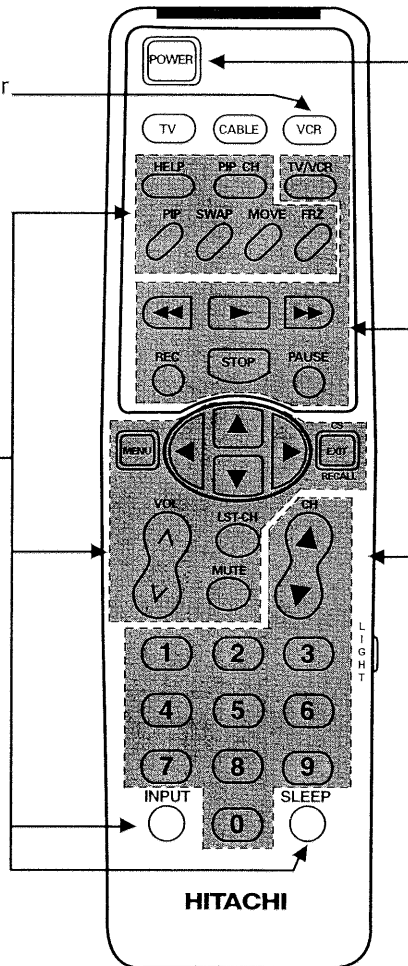

NOTES:

1. If your VCR cannot be operated after performing the above procedures, your VCR's code has not been precoded into the remote.
2. In the unlikely event that your VCR cannot be operated after performing the above procedures, please consult your VCR operating guide.
3. The remote control will remember the codes you have programmed until the batteries are removed from the remote control. After replacing the batteries repeat the entire programming procedure as stated above.
4. The INPUT button will act as your VCR '100' button if required.

NOTE: Refer to instruction manual of the VCR for operation of the buttons exclusively for the VCR.

USING THE REMOTE TO CONTROL CABLE BOX/SATELLITE FUNCTIONS



Operating the precoded function for your cable/satellite box.

This remote is designed to operate different types of cable boxes and satellite systems. You must first program the remote to match the remote system in your cable/satellite box. (Refer to page 34).

1. Turn ON your cable/satellite box.
2. Aim the remote control at the front of your cable/satellite box.
3. Press the CABLE button on the remote to switch to cable/satellite mode.
4. Hold down the CABLE button on the remote, enter the two digit preset code that matched your cable/satellite box as shown on page 34. The remote will turn off your cable/satellite box when the correct two digit preset code is entered. When this occurs, the remote control is programmed for your cable/satellite box. If the cable/satellite box does not turn off after five seconds, try another two digit preset code.
5. The remote will now control your cable/satellite box.

CABLE Button

This button allows the remote to control your cable/satellite box by setting it to cable

EXCLUSIVE TV Buttons

These buttons are for operating the TV.

PRECODED CABLE/SATELLITE Box Buttons

These buttons transmit the chosen precoded CABLE/SATELLITE codes.

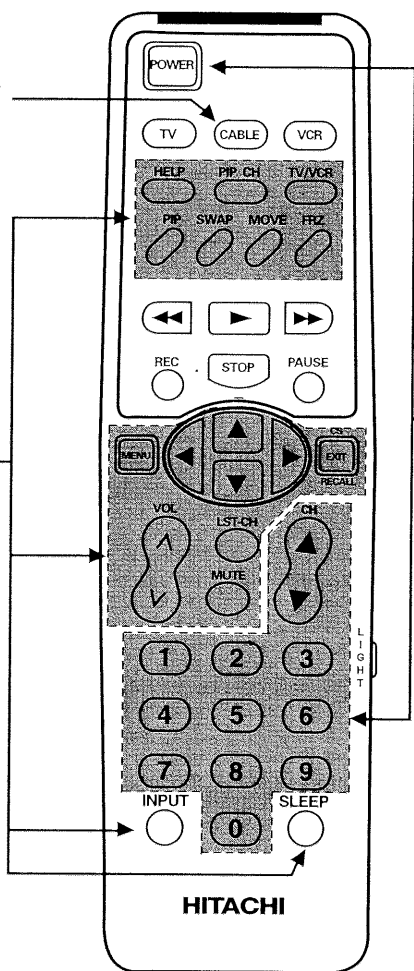

NOTES:

1. If your cable/satellite box cannot be operated after performing the above procedures, your cable/satellite box code has not been precoded into the remote.
2. In the unlikely event that your cable/satellite box cannot be operated after performing the above procedures, please consult your cable/satellite box operating guide.
3. The remote control will remember the codes you have programmed until the batteries are removed from the remote control. After replacing the batteries repeat the entire programming procedure as stated above.



CABLE/SATELLITE AND VCR CODES (CLU-4111U, CLU-4111UI)

| CABLE BRAND | CODE | VCR BRAND | CODE | | |
|--------------------|----------------------------------|-----------------|---|------------------------|--|
| ABC | .00, 02, 04, 05, .07, 08, 11, 44 | Adventura | .00 | Optimus | .09, 18, 23, 38, 41, 58, 59 |
| Antronix | .25, 43 | Aiko | .68 | Optonica | .27 |
| Archer | .23, 25, 43 | Aiwa | .00 | Orion | .54, 60 |
| Belcor | .42 | Akai | .13, 19, 21, 26, 39 | Panasonic | .07, 35, 41, 50, 59 |
| Cable Star | .42 | American High | .07 | Penney | .07, 09, 10, 12, 22, 51, 61 |
| Cabletenna | .43 | Asha | .51 | Pentax | .28, 61, 62 |
| Cableview | .43 | Audiovox | .09 | Philco | .07 |
| Century | .23 | Beaumarck | .51 | Philips | .07, 27, 36 |
| Citizen | .23, 29 | Bell & Howell | .38 | Pilot | .09 |
| Colour Voice | .15, 17 | Broksonic | .40, 43, 48, 54, 56 | Pioneer | .23, 31 |
| Comtronics | .18 | Calix | .09 | Portland | .03 |
| Contec | .12 | Canon | .07 | Protec | .33 |
| Dae Ryung | .04 | Capehart | .03 | Pulsar | .11, 20 |
| Eastern | .01 | Carver | .36 | Quarter | .16 |
| Everquest | .10, 18 | CCE | .33, 66 | Quartz | .16 |
| Focus | .31 | Citizen | .09, 66 | Quasar | .07, 35, 41, 59 |
| Garrard | .23 | Colt | .33 | Radio Shack | .00, 09, 55 |
| GC Electronics | .25, 42 | Craig | .09, 17, 33, 51, 52 | Radix | .09 |
| Gemini | .10 | Cybernex | .20, 51 | Randex | .09 |
| General Instrument | .05, 33, 52 | Daewoo | .03, 15, 68 | RCA | .24, 28, 35, 39, .44, 61, 62, 64 |
| Gold Star | .18, 22 | Daytron | .03 | Realistic | .00, 07, 09, 16, 17, .18, 27, 29, 38, 51 |
| Hamlin | .45, 46, 48, 49 | Dynatech | .00 | Ricoh | .08, 65 |
| Hitachi | .05 | Electrohome | .09 | Runco | .11 |
| Hytex | .44 | Electroponic | .09 | Salora | .34 |
| Jasco | .23, 29 | Emerex | .04 | Samsung | .15, 20, 21, 51 |
| Jerrold | .02, 05, 06, 08, 10, 33, 52 | Emerson | .00, 01, 08, 09, 14, 26, .32, 37, 40, 43, 45, 46, .48, 49, 53, 54, 58, 60, 66 | Sanky | .11, 18 |
| Linsay | .31 | Fisher | .17, 22, 29, 38 | Sansui | .13, 31, 52 |
| Magnavox | .16 | Fuji | .05, 07 | Sanyo | .16, 17, 38, 51 |
| Memorex | .09 | Funai | .00, 55 | Scott | .14, 16, 40, 43, 47, 48, 49 |
| Movie Time | .20, 41 | GE | .07, 24, 28, 44 | Sears | .02, 07, 09, 16, 17, .22, 29, 31, 38, 61, 62 |
| Novaplex | .38 | Gerrard | .00, 55 | Sharp | .18, 27 |
| NSC | .20, 41 | Go Video | .67 | Shintom | .33 |
| Oak | .12, 44 | Goldstar | .09, 10 | Shogun | .20, 51 |
| Panasonic | .09, 13, 21 | Gradiente | .00 | Singer | .33 |
| Panther | .39 | Grundig | .68 | Sony | .04, 05, 06, 07, 65 |
| Paragon | .09 | Harley Davidson | .00 | STS | .61 |
| Philips | .15, 16, 17, 23 | Harman/Kardon | .10, 34 | Sunpak | .65 |
| Pioneer | .22, 36 | Harwood | .32, 33 | Sylvania | .00, 07, 14, 36 |
| Popular Mechanics | .31 | Headquarter | .16 | Symphonic | .00, 55 |
| Pulsar | .09 | Hi-Q | .17 | Tatung | .13 |
| RCA | .13 | Hitachi | .00, 13, 28, 55, 61, 62, 63 | Teac | .00, 13 |
| Realistic | .25 | Jensen | .13 | Technics | .07, 41 |
| Recoton | .31 | JVC | .02, 13, 31 | Teknika | .00, 07, 09 |
| Regal | .27, 45 | KEC | .09, 66 | TMK | .08, 45, 51 |
| Regency | .01 | Kenwood | .10, 13, 31 | Torevision | .09, 51 |
| Rembrandt | .05 | KLH | .33 | Toshiba | .14, 15, 29, 47, 49, 57 |
| Runco | .09 | Kodak | .07, 09 | Unitech | .51 |
| Samsung | .18, 22 | Lloyd | .00 | Vector | .15 |
| Scientific Atlanta | .03, 04, 11, 34, 53 | Lloyd's | .45 | Vector Research | .10, 12 |
| Seam | .35 | Logik | .33 | Video Concepts | .12, 15, 26 |
| Signal | .10, 18 | LXI | .09 | Videosonic | .51 |
| SL Marx | .18 | Magnavox | .07, 11, 38, 64 | Wards | .00, 07, 17, 18, 24, .27, 33, 49, 51, 61, 64 |
| Sprucer | .13 | Magnin | .47 | XR-1000 | .00 |
| Starcom | .02, 10 | Marantz | .07, 36 | XR-1001 | .07 |
| Stargate | .10, 18 | Marta | .09 | XR-1002 | .33 |
| Starquest | .10 | Matsushita | .07 | Yamaha | .10 |
| Sylvania | .00 | MEI | .07 | Zenith | .05, 06, 11 |
| Tandy | .27 | Memorex | .00, 08, 09, 11, .16, 17, 18, 38, 51 | | |
| Television | .18 | MGA | .14, 26 | SATELLITE BRAND | CODE |
| Texscan | .00 | MGN Technology | .51 | General Instruments | .30 |
| TFC | .28 | Minolta | .61, 62 | Hitachi | .54, 55 |
| Tocom | .06, 07 | Mitsubishi | .14, 26, 31, 34, 42 | Jerrold | .30 |
| Toshiba | .09 | Motorola | .07, 18 | Primestar | .30 |
| Tusa | .10 | MTC | .00, 51 | RCA | .37, 56, 57 |
| TV 86 | .20 | Multitech | .00, 33 | Sony | .40 |
| Unika | .23, 25, 43 | NAD | .23 | | |
| United Artists | .44 | NEC | .10, 12, 13, 31, 38 | | |
| United Cable | .02 | Nikko | .09 | | |
| Universal | .23, 24, 25, 42, 43 | Noblex | .51 | | |
| Videoway | .16, 20, 27 | Olympus | .07 | | |
| Zenith | .09, 47, 50 | | | | |
| Zentek | .31 | | | | |



ULTRATEC OSD

1. Press MENU on the remote control to display the different features on your HITACHI Color TV.
2. Press the CURSOR buttons to highlight a different feature.
3. Press EXIT on the remote control to quickly exit from a menu.
4. Press HELP on the remote control when a menu is displayed, and text will appear giving a description of that menu.

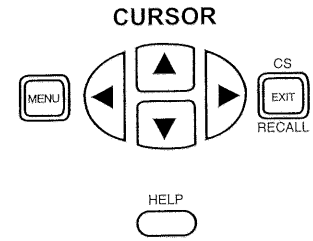

This part of the screen shows what selections are available.

The icon shows the available moves on the menu.

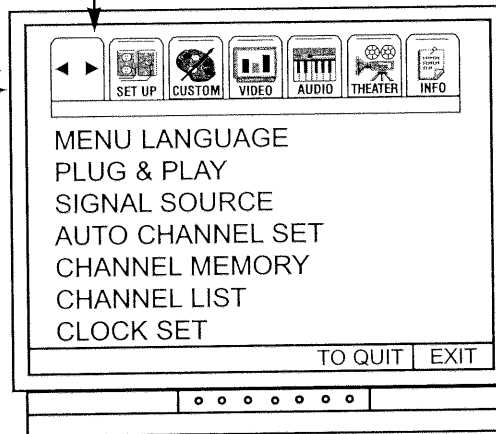

This part of the screen shows how to quit and browse the menu.

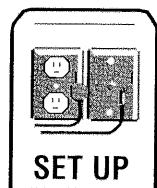

| | |
|------------------|---|
| MENU LANGUAGE | Choose English, French, or Spanish text. |
| PLUG & PLAY | Optimum hook up for your system. |
| SIGNAL SOURCE | Select antenna or cable TV. |
| AUTO CHANNEL SET | First time set up for channel buttons. |
| CHANNEL MEMORY | Channel buttons, add, skip. |
| CHANNEL LIST | Check channel name, scan and PARENTAL CONTROL |
| CLOCK SET | Set before using timer features. |



| | |
|------------------|--|
| CHANNEL ID | Label channels PAY 1, ABC, etc. |
| VIDEO ID | Label video inputs VCR1, LASER1, etc. |
| FAMILY FAVORITES | Allows you to set and view favorite channels. |
| PARENTAL CONTROL | Block channel picture and sound. |
| 4 EVENT PROGRAM | Turn TV on and off once, daily, or weekly. |
| AUTO LINK | Automatically turn TV on with any VIDEO input. |
| CLOSED CAPTION | Feature to display dialogue/text. |
| MENU BACKGROUND | Select from three types of backgrounds. |



| | |
|-------------------|---------------------------------------|
| CONTRAST | Adjust contrast. |
| BRIGHTNESS | Adjust brightness. |
| COLOR | Adjust color. |
| TINT | Adjust tint. |
| SHARPNESS | Adjust sharpness. |
| RESET | Set VIDEO settings to factory preset. |
| ADVANCED SETTINGS | Improve picture performance. |



| | |
|-------------------|---------------------------------------|
| BASS | Adjust bass. |
| TREBLE | Adjust treble. |
| BALANCE | Adjust balance. |
| RESET | Set AUDIO settings to factory preset. |
| ADVANCED SETTINGS | Improve sound performance. |
| VOLUME CORRECTION | Lower Volume on selected channels. |

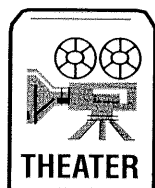

| | |
|----------|--|
| SURROUND | Special sound effects. |
| OFF | Surround On and OFF. |
| MUSIC | Listener has the feeling of being in a concert hall. |
| MOVIES | Listener has the feeling of being in a movie theater. |
| SIMULATE | At mono input, sound is increased simulating a stereo like surround. |



| | |
|----------------|---|
| SPECIAL | Set TV to remind you of birthdays, etc. |
| EVENT REMINDER | |
| CALENDAR | Check day, month, year, and special events. |

SET UP

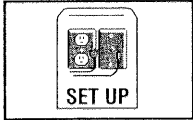

Select INITIAL SETUP when setting your TV up for the first time. Use the CURSOR ▲ or ▼ on the remote to highlight the function desired.

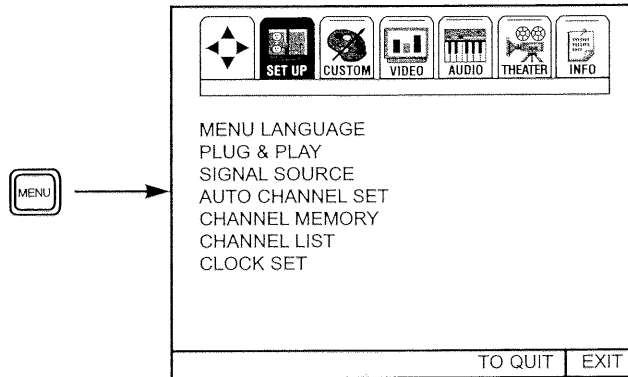

NOTE: To see an auto-demonstration of the on-screen displays with HELP text displayed, press and hold the POWER button on the TV set for approximately five seconds. Press the POWER button on the TV again to end the auto-demonstration.

MENU LANGUAGE This feature will allow you to select any one of three different languages for all on-screen displays.

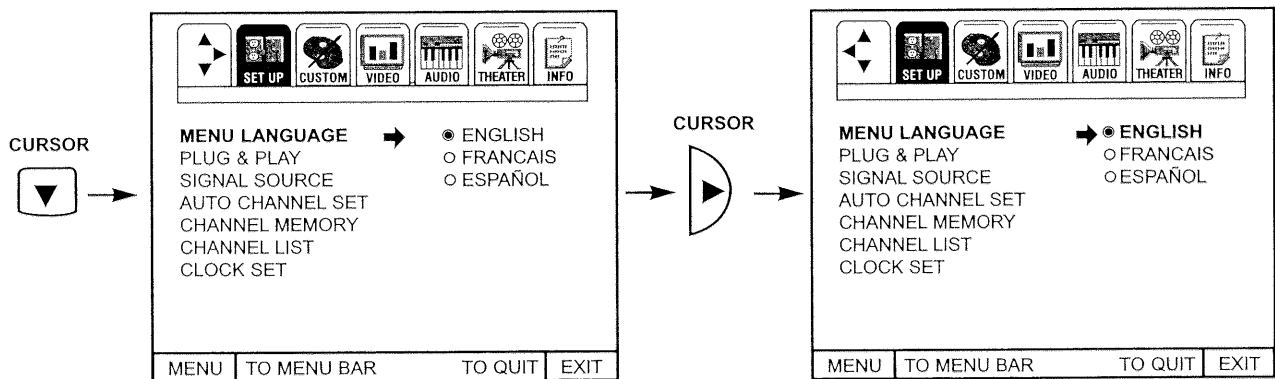

Use CURSOR ▲ or ▼ to select the MENU LANGUAGE of your choice.

Press EXIT to quit menu or CURSOR ◀ to return to previous menu.



PLUG & PLAY

This graphic guide function will help you to properly set up your TV or Home Theater System. Simply answer two questions and a graphic will be displayed, showing you the optimum setup for your personalized system.

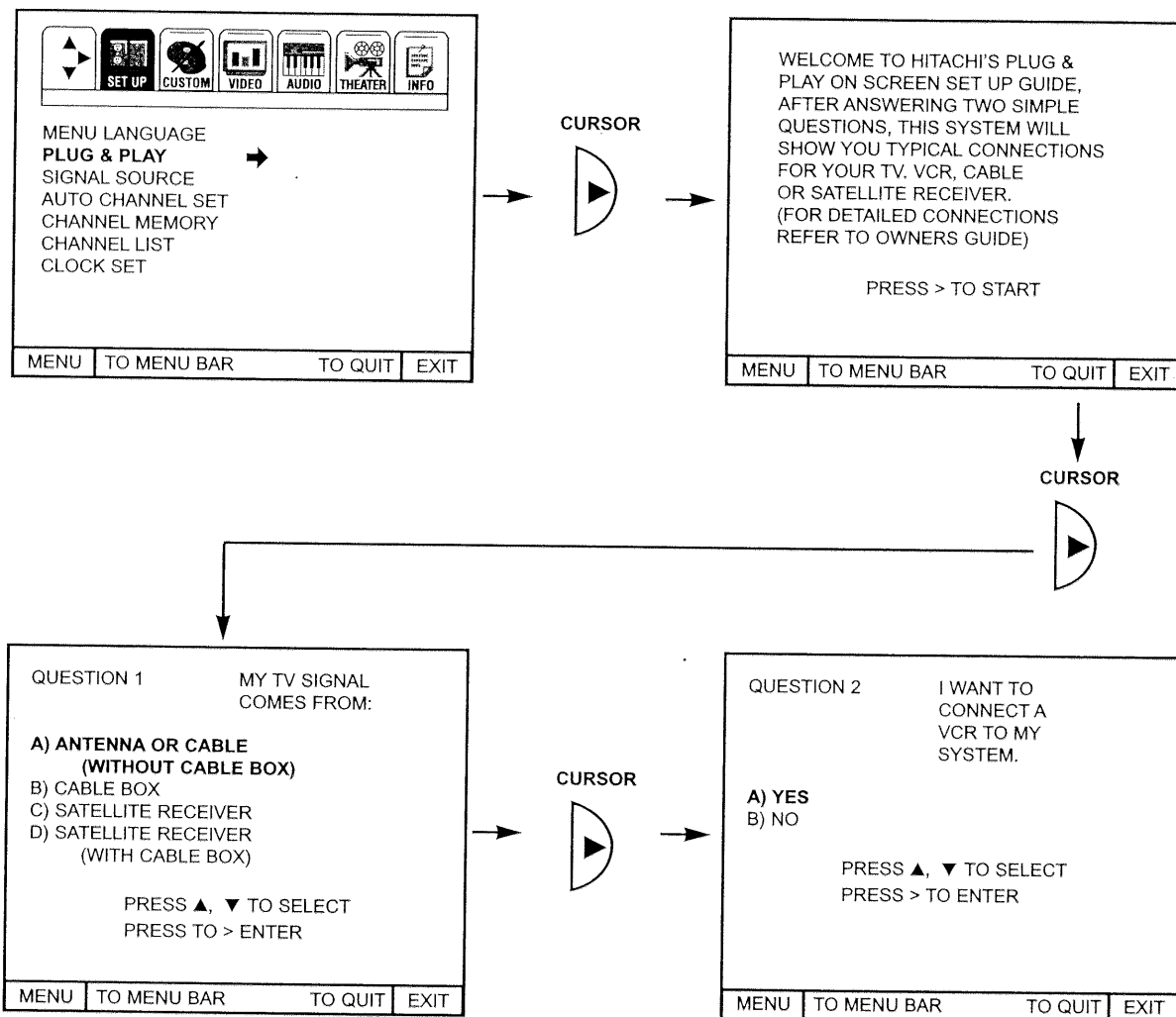

Press CURSOR ▲ or ▼ to highlight the correct answers to both questions.

Press CURSOR ► to display the graphic guide.

Press EXIT to quit menu or CURSOR ► to begin AUTO CHANNEL SET. (See page 40).

SET UP

SIGNAL SOURCE

Select ANTENNA if you are using an indoor or outdoor antenna. Select CATV if you have cable TV.

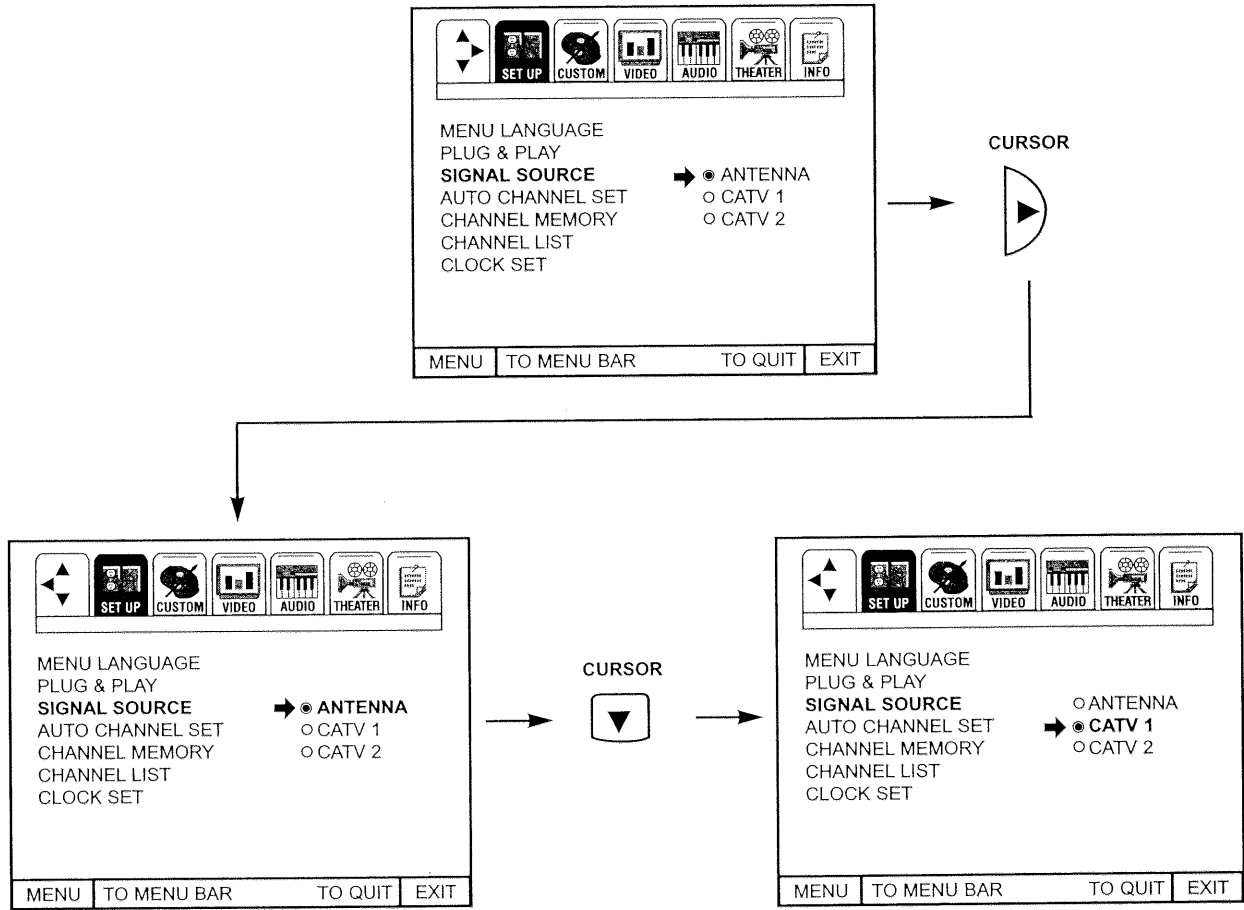

Press CURSOR ▲ or ▼ to highlight and select the correct SIGNAL SOURCE mode.
Press EXIT to quit MENU or CURSOR ◀ to return to previous menu.

| RECEPTION BAND | | |
|-------------------------------|------------------------------|-------------------------|
| AIR | CATV 1 OR CATV 2 | |
| | CATV CHANNEL | Indicated on the screen |
| VHF 2 ~ 13ch UHF 14 ~ 69ch | VHF 2 ~ 13 | 2 ~ 13 |
| | Mid band A ~ I | 14 ~ 22 |
| | A-5 ~ A-1 | 95 ~ 99 |
| | Super band J ~ W | 23 ~ 36 |
| | Hyper band W + 1 ~ W + 28 | 37 ~ 64 |
| | Ultraband W + 29 ~ W + 84 | 65 ~ 125 |

Reception channels for each mode are shown at the left.
Refer to your cable or TV guide for channel identification standards.
If certain CATV channels are poor or not possible in CATV1 mode, set SIGNAL SOURCE to CATV2.

AUTO CHANNEL SET

This feature will automatically store active TV channels in CHANNEL MEMORY. This will allow you to skip unused channels when using CHANNEL UP (▲) or DOWN (▼).

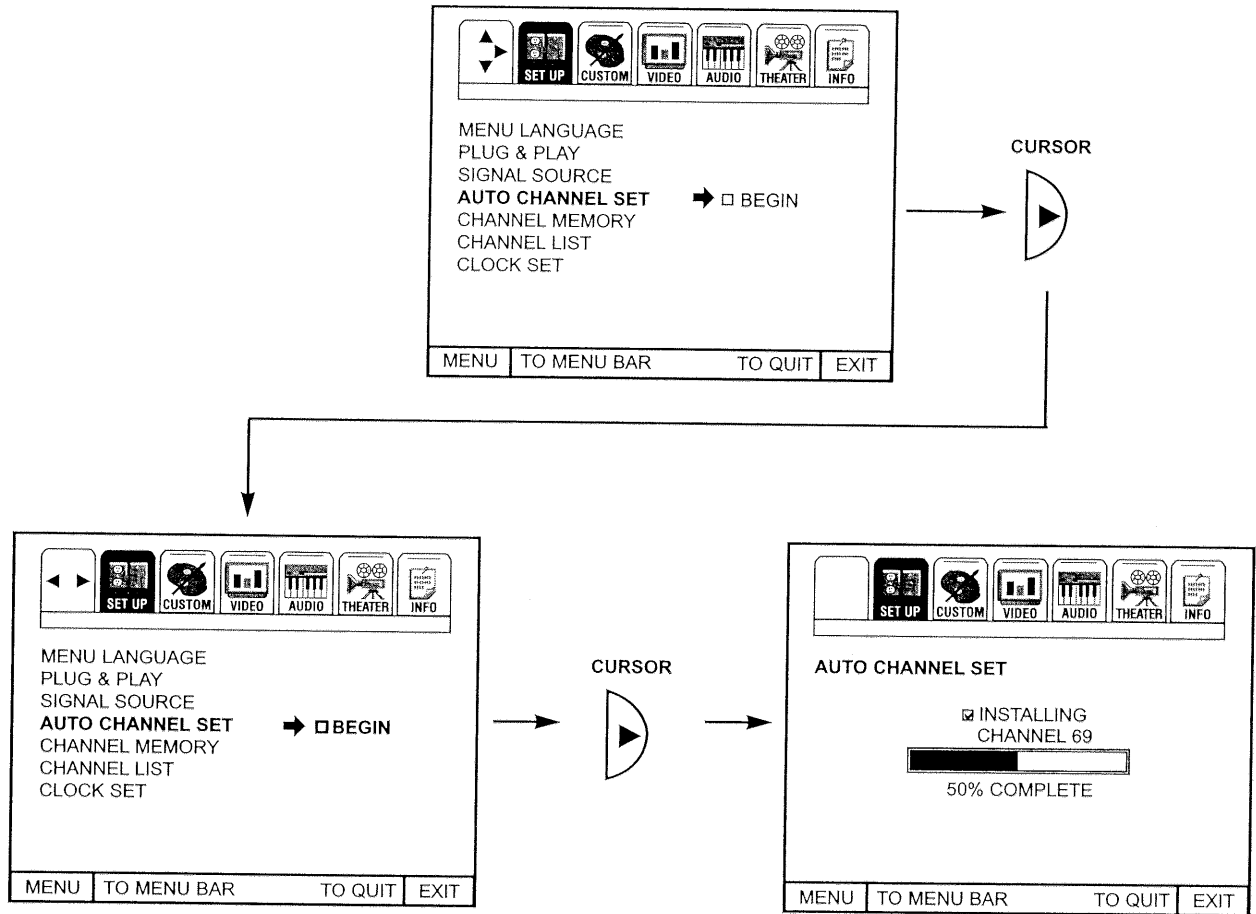

If the EXIT button is pressed while the AUTO CHANNEL SET function is engaged, programming will stop. After AUTO CHANNEL SET press EXIT to quit or CURSOR ◀ to return to previous menu.

36/32UX59B and 36/32FX49B models:

If two antennas are connected, switch antenna inputs with the INPUT button and repeat AUTO CHANNEL SET for the second antenna input.

Remember to select the correct SIGNAL SOURCE mode before using AUTO CHANNEL SET for the second antenna input. See CHANNEL MEMORY to add or erase additional channels. (See page 41).

SET UP

CHANNEL MEMORY

Use this function after AUTO CHANNEL SET to add or erase additional channels to the remote control CHANNEL ▲ or ▼ buttons.

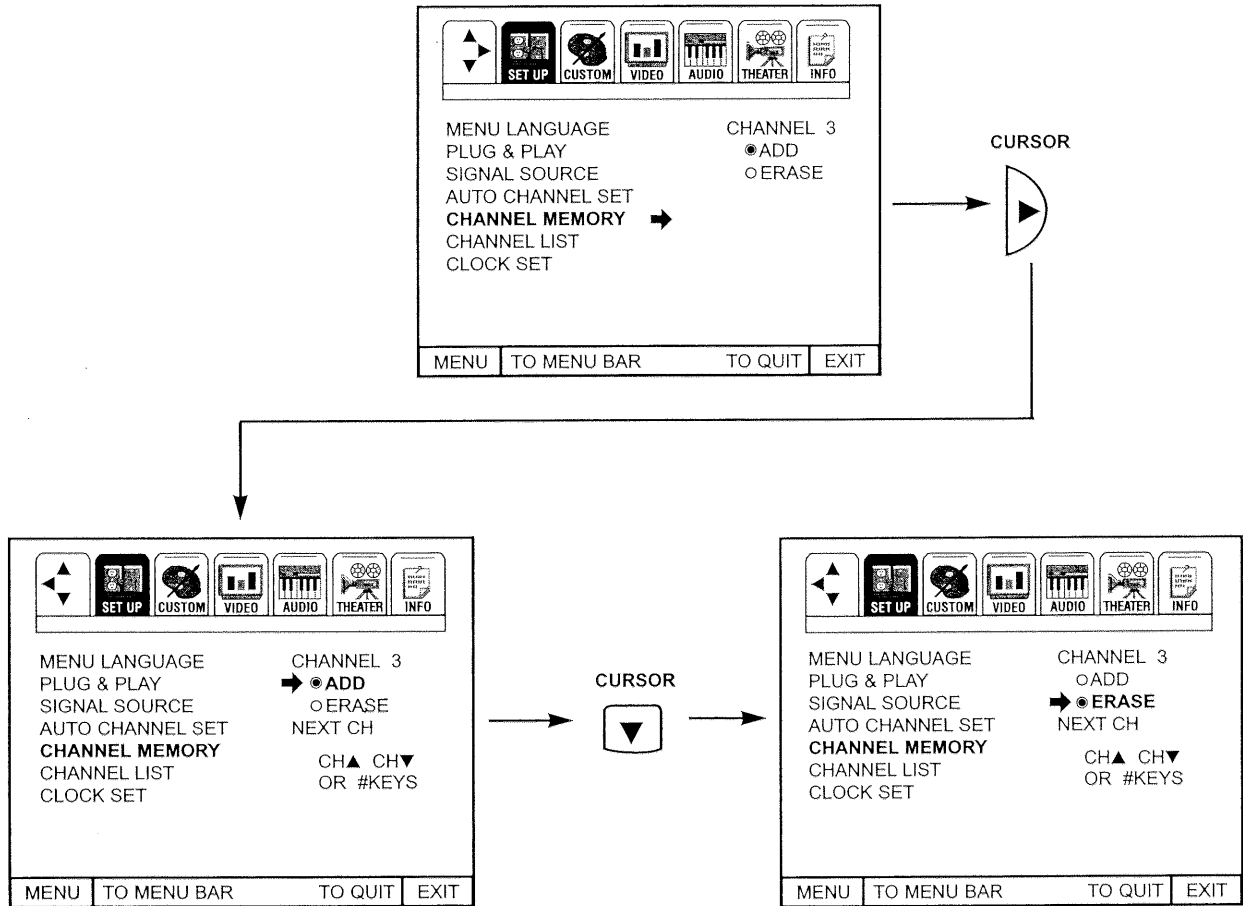

Add or erase additional channels while still in CHANNEL MEMORY using CHANNEL ▲ or ▼ or the number buttons to change the channel.

Press EXIT to quit menu or CURSOR ◀ to return to previous menu.

CHANNEL LIST

This function allows you to review which channels are labeled in CHANNEL ID (ID), which have been added to CHANNEL MEMORY (SCAN), and which are protected by PARENTAL CONTROL LOCK (LOCK).

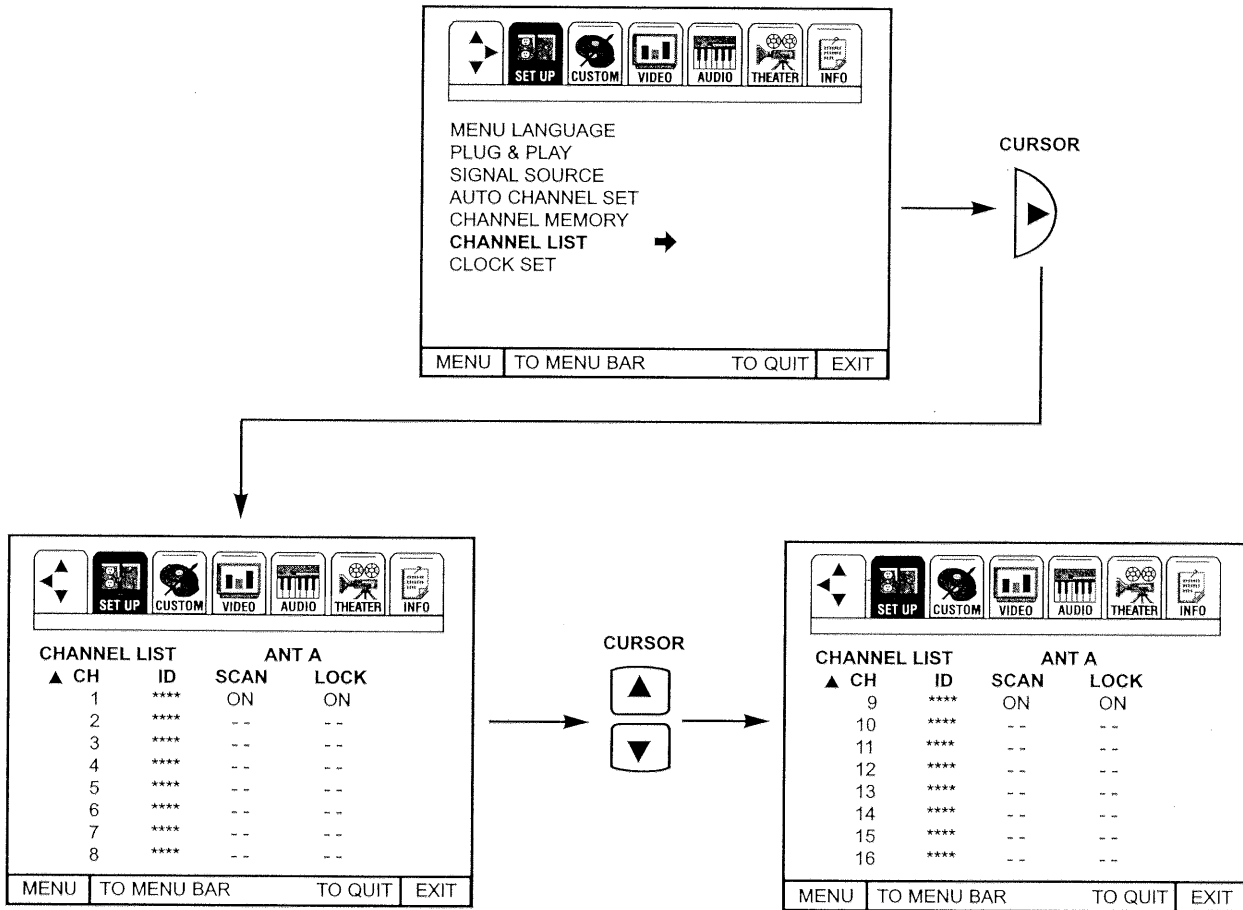

Press CURSOR ▲ or ▼ to review more channels.

Press EXIT to quit menu or CURSOR ◀ to return to previous menu.

NOTE: Each touch of CURSOR ▲ or ▼ will display the next eight channels. For TV models **36/32UX59B** and **36/32FX49B**, if source ANT B is selected, the header should read "Channel List ANT B".

SET UP

CLOCK SET

The time must be set before you can use the CALENDAR, 4 EVENT PROGRAM, SPECIAL EVENT REMINDER, or TV TIME OUT.

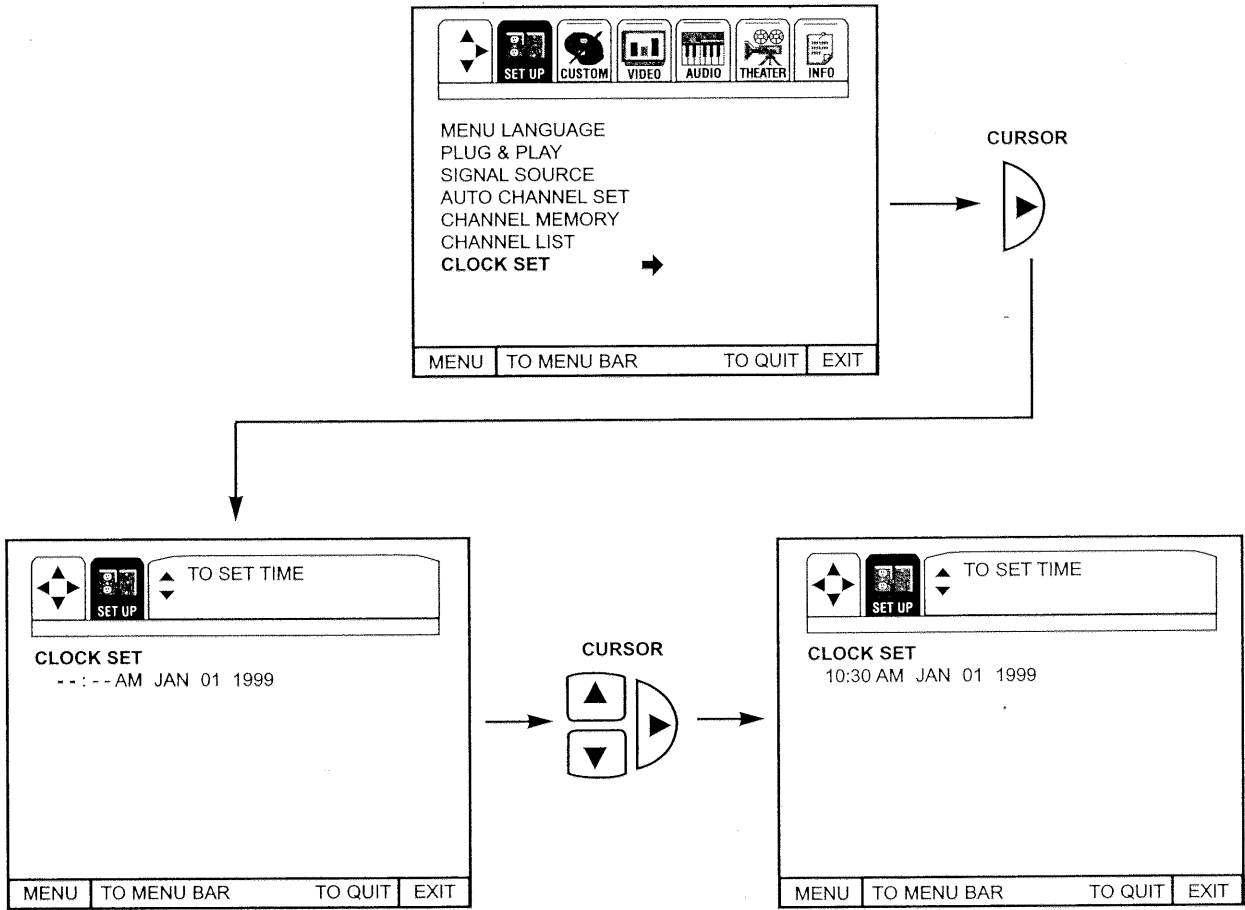

Use CURSOR ▲ or ▼ to set the time, date, and year.

Press CURSOR ◀ or ▶ to change position.

Press EXIT to quit menu or CURSOR ◀ to return to previous menu when the CURSOR is in the first position.



This selection contains advanced features which will make TV viewing easier and more enjoyable.

CHANNEL ID

Use this feature to give up to 20 channels a name when ANTENNA signal source is selected and up to 60 channels a name when CATV1 signal source is selected.

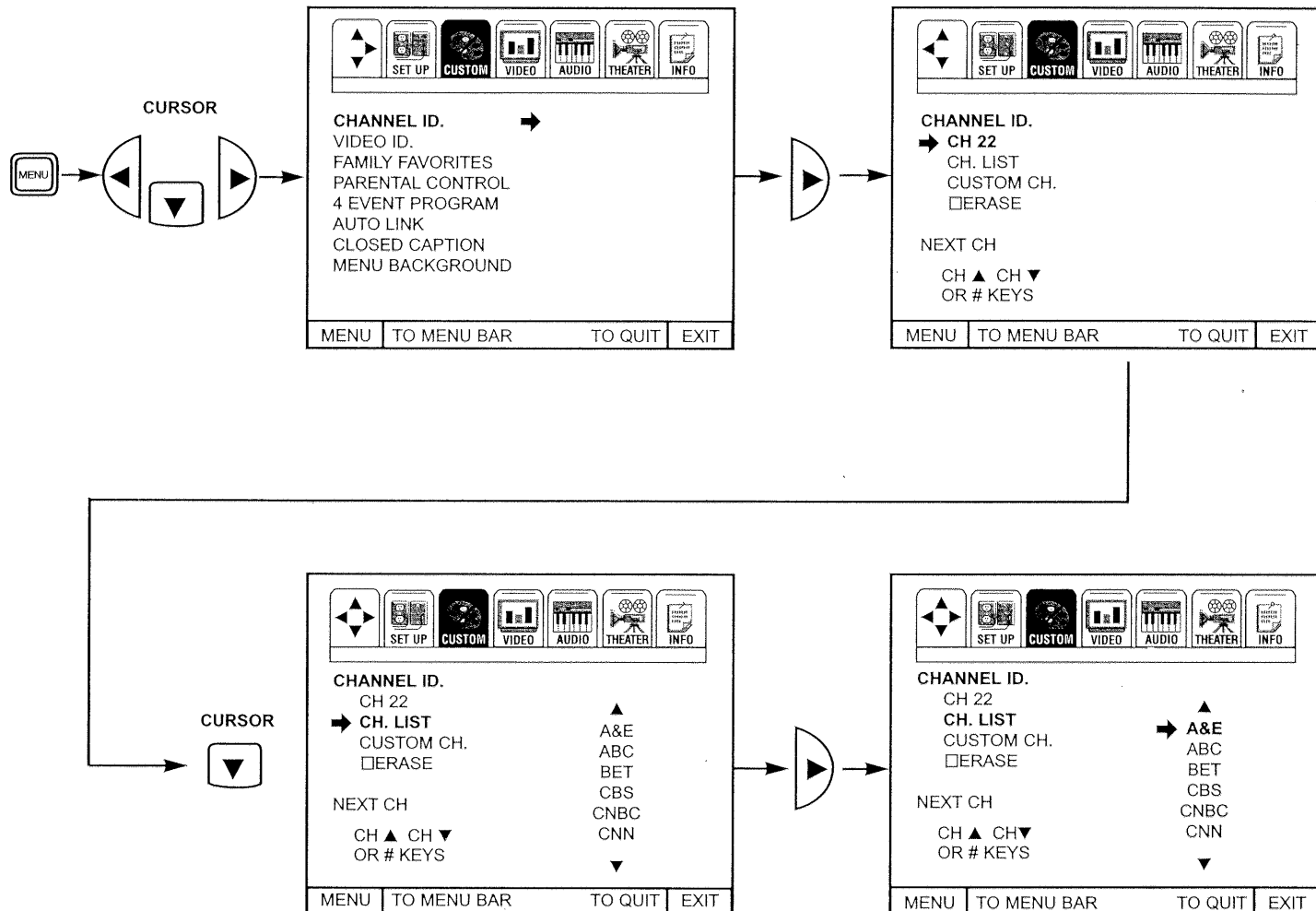

Press **CURSOR** ▲ or ▼ to scroll through the preset CHANNEL LIST.
Press **CURSOR** ► to select desired CHANNEL ID.

To customize CHANNEL ID, select **CUSTOM CH.**

Press **CURSOR** ► to enter Custom mode.

Press **CURSOR** ▲ or ▼ to select letter.

Press **CURSOR** ► or ◀ to change character position.

(*) represents a blank space.

Press **CHANNEL** ▲ or ▼ and the number buttons to select and label additional channels.

Press **EXIT** to quit menu or **CURSOR** ◀ to return to previous menu when the **CURSOR** is in the first position.

Select **ERASE** to delete a CHANNEL ID.

NOTE: (36/32UX59B and 36/32FX49B models). If ANT A and ANT B are in the same SIGNAL SOURCE mode (see page 39), the CHANNEL ID for both antenna inputs will be the same. CHANNEL ID will be displayed only when channel is displayed as main picture.

CUSTOM

VIDEO ID.

Use this feature to give a name to any of the video inputs.

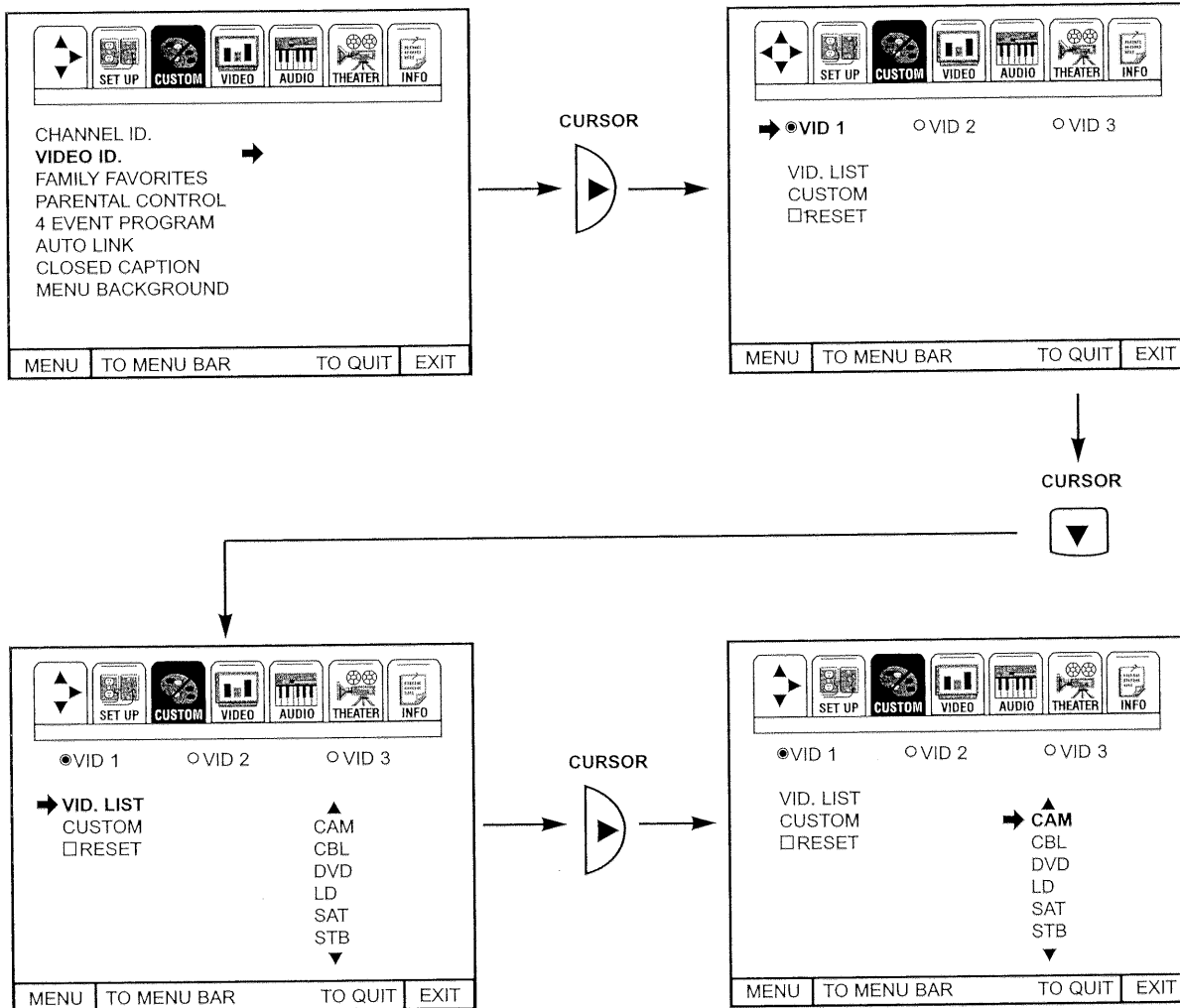

- Press CURSOR ▲ or ▼ to scroll through the preset VIDEO LIST.
- Press CURSOR ► to select desired VIDEO ID.
- To customize VIDEO ID, select CUSTOM.
- Press CURSOR ► to enter Custom mode.
- Press CURSOR ▲ or ▼ to select letters.
- Press CURSOR ► or ◀ to change position.
- Press EXIT to quit menu or CURSOR ◀ to return to previous menu when the CURSOR is in the first position.

(★) represents a blank space.
 Select RESET to erase a VIDEO ID to original condition.

NOTE: 1. VIDEO ID will be displayed only when VIDEO input is displayed as main picture.
 2. VIDEO:3 (VID3) only available on **36UX59B** and **32UX59B** models.



FAMILY FAVORITES (MENU)

This function allows you to group your favorite channels into six personalized categories that you can rename. A total of 24 channels can be stored in the FAMILY FAVORITES function.

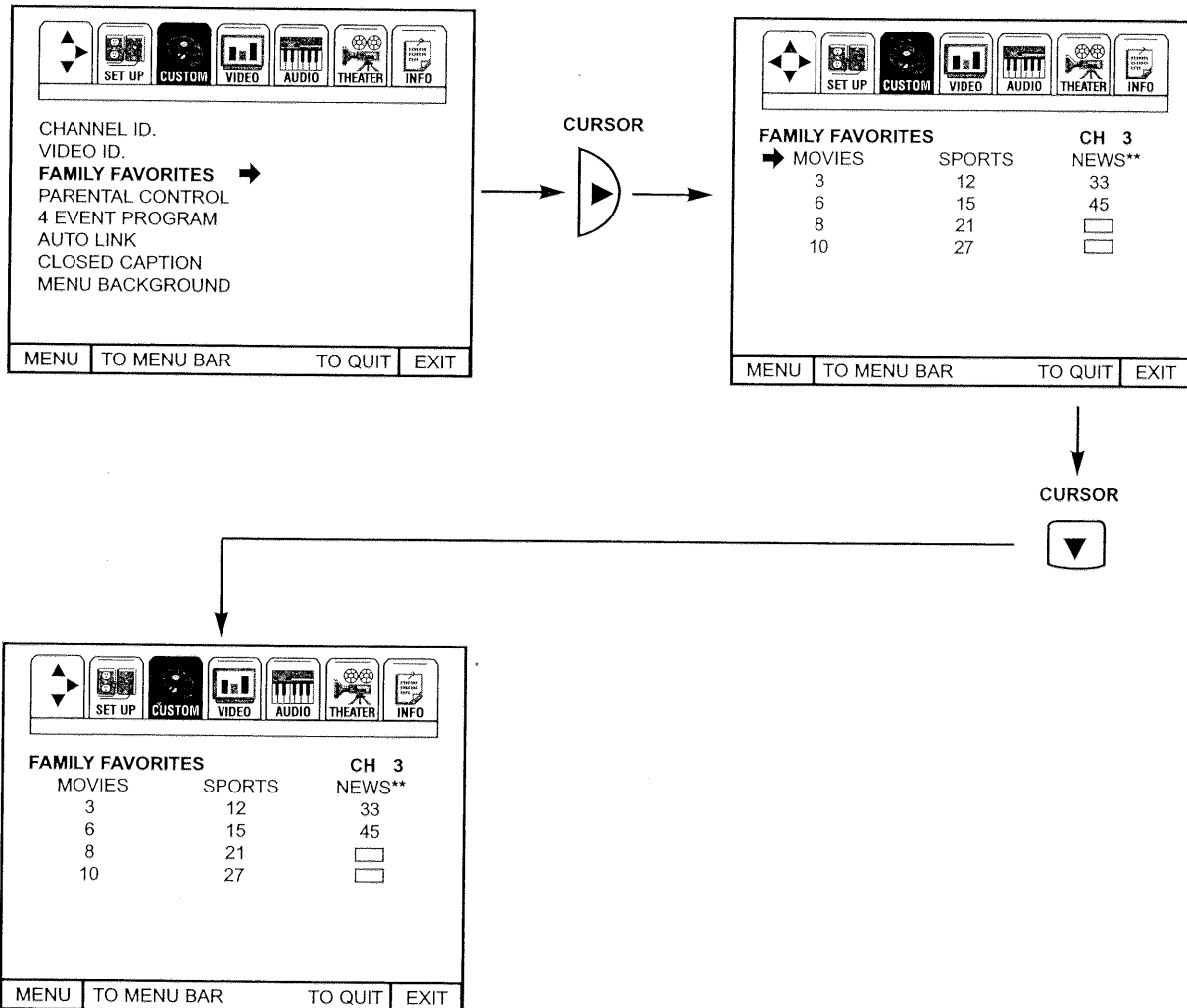

Press CURSOR ► To access the second part of the FAMILY FAVORITES menu when the cursor is in the first position. Channel stored with AUTO CHANNEL SET will automatically be stored in FAMILY FAVORITES.

To rename the categories, use the CURSOR buttons to highlight the category you would like to rename. Use CURSOR ▲ or ▼ to change letters and CURSOR ► to select the next character to change.

To enter a channel into a category, highlight the channel location to be stored.

Press CHANNEL ▲ or ▼ or the number buttons to enter the desired channel. Repeat until category has been set with your favorite channels. The channel to be added is displayed in the top right corner of the On Screen Display. Enter channel 00 to erase a favorite channel.

To reset categories and channels back to original factory preset, press RECALL while you are renaming a category.

Press EXIT to quit menu, or CURSOR ◀ to return to previous menu when the CURSOR is in the first position.

NOTE: (36/32UX59B and 36/32FX49B models). This function cannot be accessed when ANT B is the main channel. When the set is in a SIGNAL SOURCE different from ANT A, the message "PLEASE SWITCH TO ANT A" will appear.

CUSTOM

FAMILY FAVORITES (OPERATION)

Use this function to tune the main picture to a desired favorite channel.

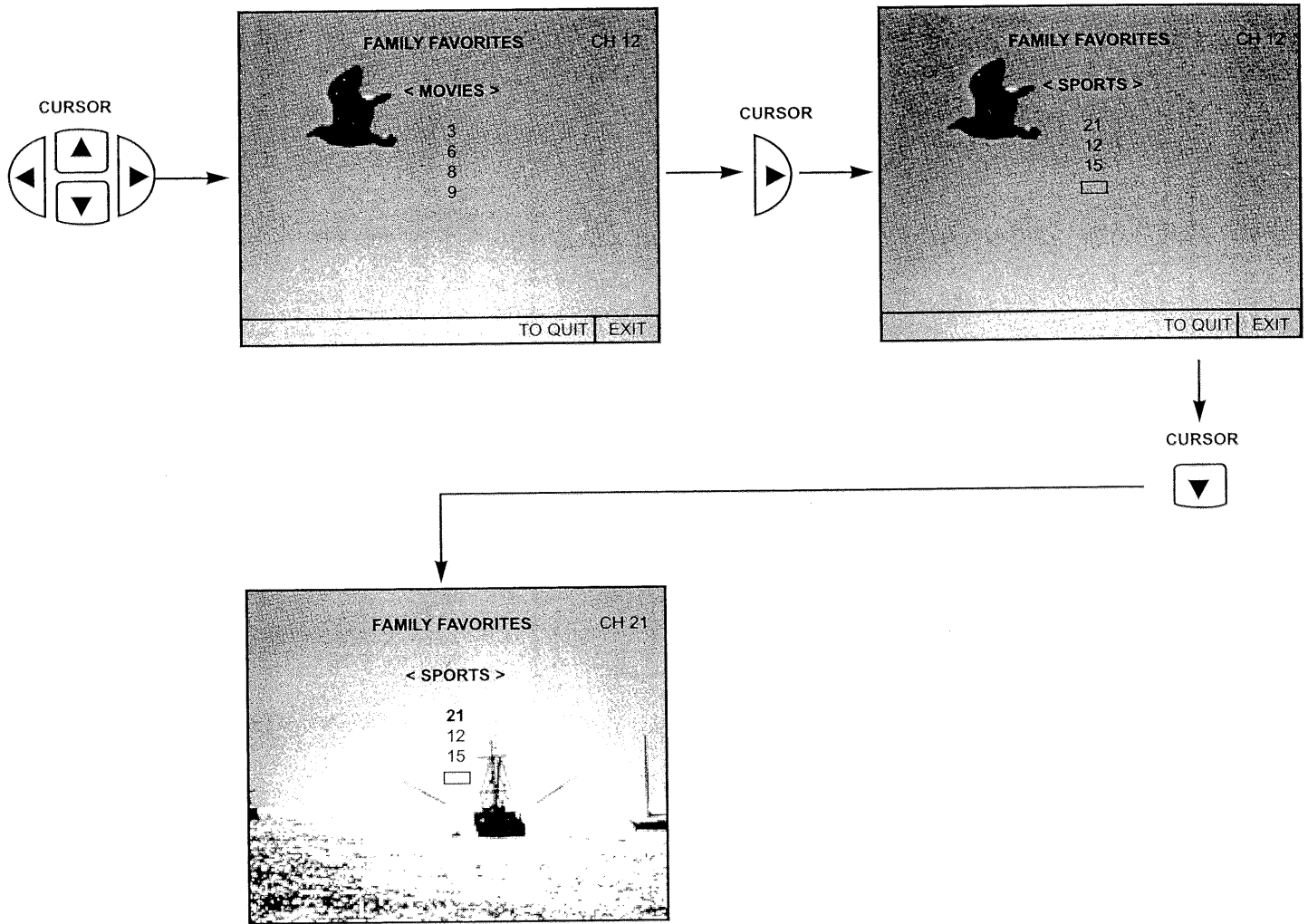

Press the CURSOR button.

Select a category using CURSOR ◀ or ▶ buttons.

Use CURSOR ▲ or ▼ buttons to highlight a favorite channel and the TV will automatically tune to that channel.

Press EXIT to remove FAMILY FAVORITES OSD from the screen.

NOTE: When PIP is displayed, the cursor will not activate the FAMILY FAVORITE menu. The CURSOR button will move the PIP position.



PARENTAL CONTROL

This function will block out the picture and sound of the selected channel or video input. It can also be used to keep the TV from being view for a scheduled amount of time that you set.

The code to enter PARENTAL CONTROL is a four digit code number. The factory preset code is 0000. Use the number buttons to select secret code.

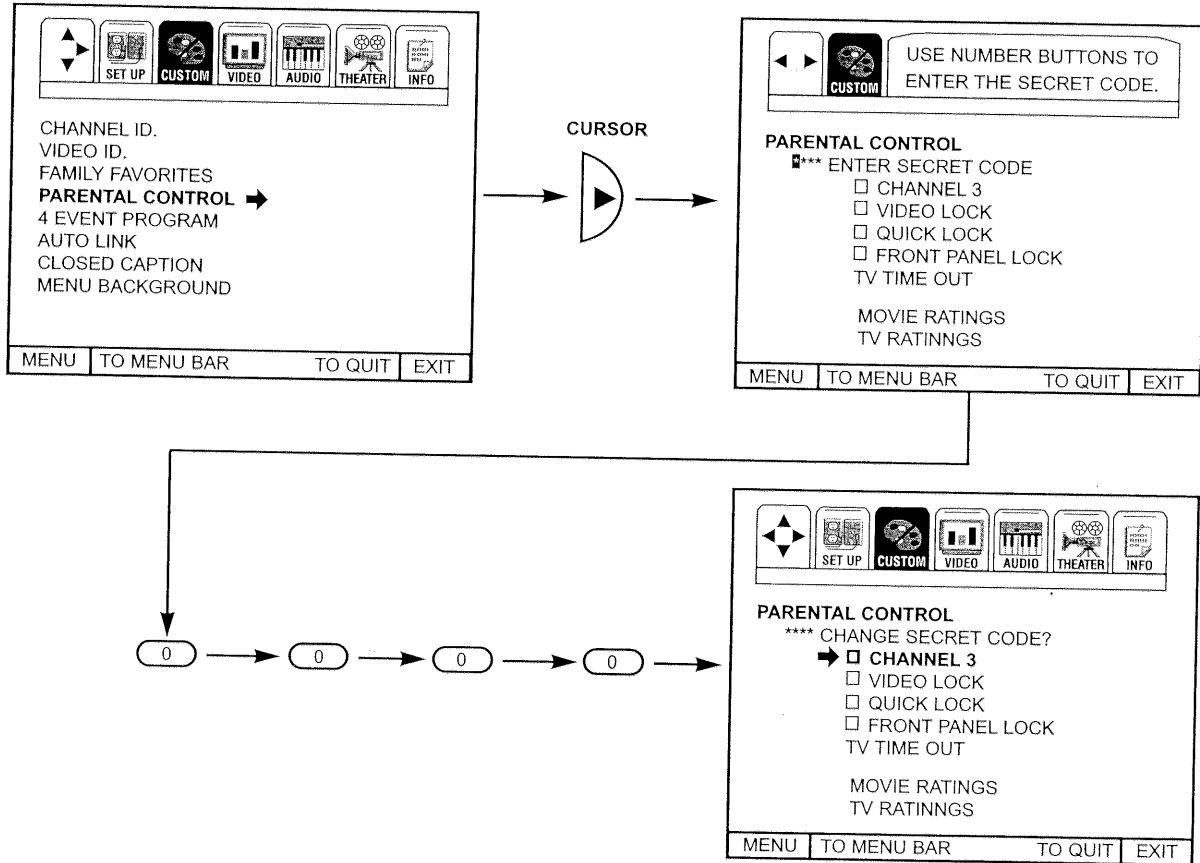

Use CURSOR ▲ or ▼ to highlight function and the CURSOR ► button to set ON or OFF.

- When CHANNEL is turned on, the picture and sound for the chosen channel will be blocked out.
- When VIDEO LOCK is turned on, the picture and sound for the video inputs will be blocked out.
- When QUICK LOCK is turned on, the picture and sound for channels 3, 4 and all video inputs will be blocked out.
- When FRONT PANEL LOCK is turned on, all buttons on the front panel will be deactivated, except the power button.
- When TV TIME OUT is turned on, you can set the BEGIN and END times and the TV cannot be viewed during that time period. (Set clock first). Use CURSOR ▲ or ▼ to highlight ONCE (TV will time out one time only), DAILY (TV will come out every day), WEEKLY (TV will time out one time a week) or OFF (to disable this function) and then press cursor ► to select your choice.

To change the key number, select CHANGE SECRET CODE. Enter a new four digit key number you prefer.

If you forget your key number, use the factory code 7777 to erase your key number. This will reset the key number back to the factory preset 0000.

Press EXIT to quit menu or cursor ◀ to return to the previous menu.

NOTE:

1. For MOVIE/TV RATINGS please refer to the PARENTAL CONTROL and MOVIE/TV RATINGS Reference guide.
2. (36/32UX59B and 36/32FX49B models). If ANT A and ANT B are in the same SIGNAL SOURCE mode (see page 39), when a channel is locked, it is locked on both antenna inputs.
When using TV TIME OUT make sure the clock is set (see page 43).

CUSTOM

4 EVENT PROG.

This function will automatically turn the TV on and off, one time only, every day or once a week.

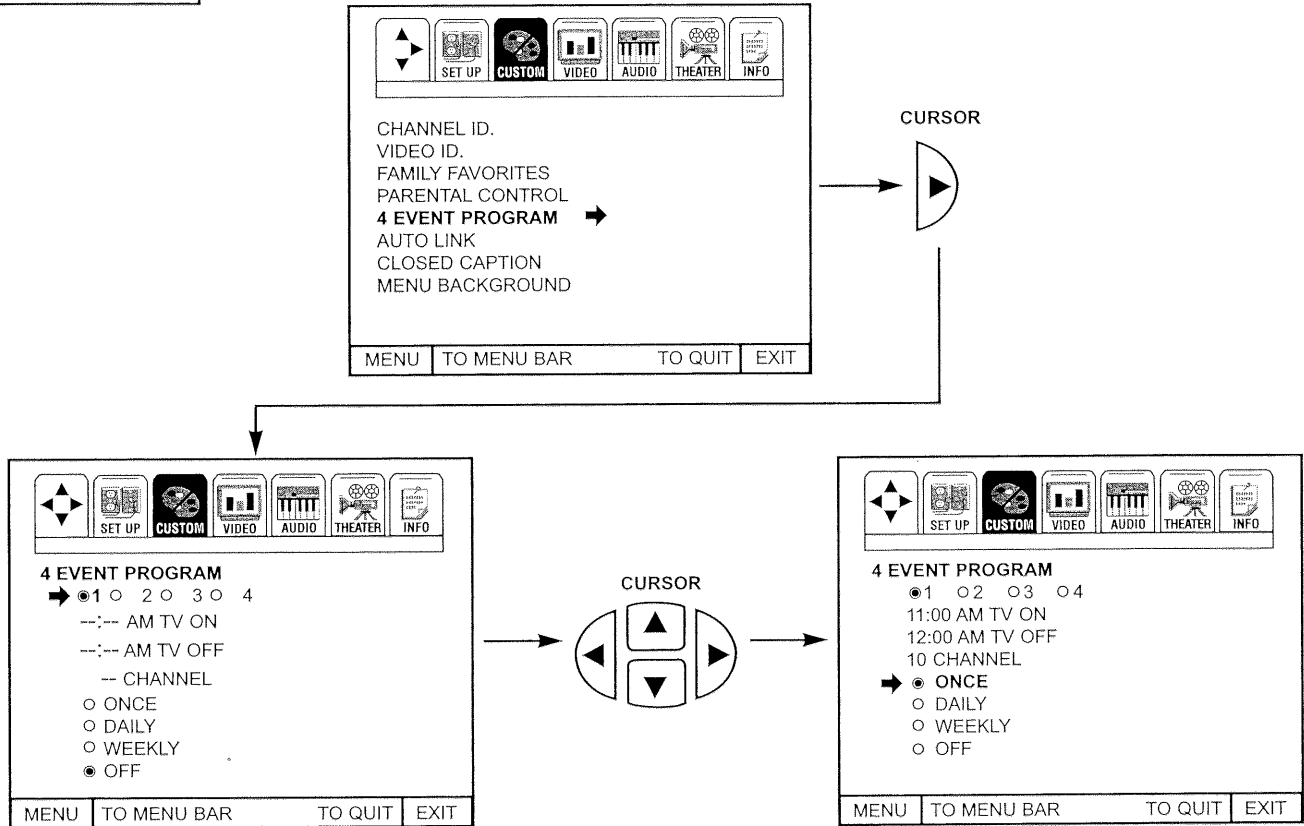

Press CURSOR ► to select PROGRAM 1, 2, 3, or 4.

Press CURSOR ▲ or ▼ to select the time the TV will turn on and off.

Use CURSOR ► to change position.

Press CURSOR ▲ or ▼ to highlight then CURSOR ► to select MODE: ONCE (TV will turn on/off one time only) or MODE: DAILY (TV will turn on/Off at the same time every day), or MODE: WEEKLY (TV will turn on/off at same time every week) and MODE: OFF (to disable this function).

Press CURSOR ▲ or ▼, or CHANNEL (▲) or (▼), or number buttons to set the channel the TV will tune to when it automatically turns on.

Press EXIT to quit menu or CURSOR ◀ to return to previous menu, when the CURSOR is in first position.

If the clock is not set, you can not use this function and the screen below will appear.

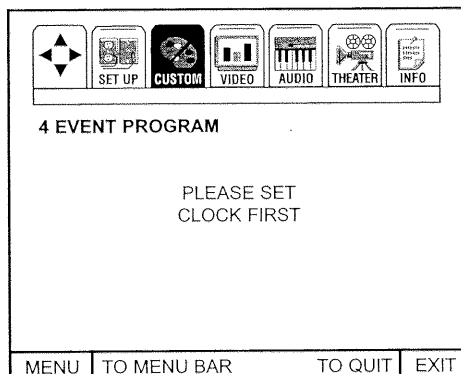

NOTE: 1. The OFF Timer will only activate if the TV was turned on by the ON Timer or tuned by the ON Timer, and no channel selection was made after this time. If a channel selection is made after the ON Timer activates, the OFF Timer will deactivate.
 2. If no remote control button is pressed after ON Timer is activated, the TV will automatically turn off after three hours.

CAUTION: Do not use your TV as a deterrent when away from home by using the ON and OFF TIMERS. For safety, the TV should be turned off when you are away from home.



AUTO LINK

Use this function to automatically turn the TV on and tune to VIDEO source when it detects a VIDEO input.

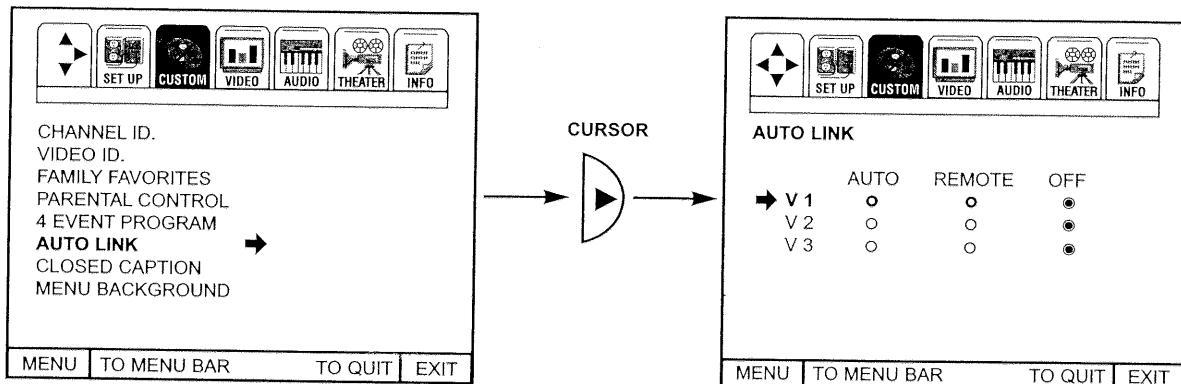

Use CURSOR ▲ or ▼ to select Input.
 Use CURSOR ► to change AUTO LINK setting.

When AUTO is selected, the TV will turn on and tune to VIDEO source automatically, when the VIDEO source input device is turned on. This is convenient when you want to watch a movie with your VCR, laserdisc player or DVD player.

When REMOTE is selected, the TV will turn on and tune to VIDEO source automatically, when a VIDEO source input device is turned on and the VCR, laserdisc or DVD play button on your remote control is pressed. This is convenient when you want to record a movie with your VCR and watch it later.

Select OFF to disable this function.
 Press EXIT to quit menu or CURSOR ◀ to return to previous menu.

- NOTE:**
1. Once the TV has been turned on using the AUTO LINK feature, it must be reset before AUTO LINK is used again. To do this, turn your VCR, laserdisc or DVD player OFF. This feature is now reset and will turn on your TV as described above.
 2. When using REMOTE mode, any remote control button will substitute for your video input device play button. However, intended operation is for use with your VCR, laserdisc or DVD play button.
 3. Video:3 is only available on **36/32UX59B** models.

CUSTOM

CLOSED CAPTION

Closed captions are the dialogue, narration, and/or sound effects of a television program or home video which are displayed on the TV screen. Your local TV program guide denotes these programs as or .

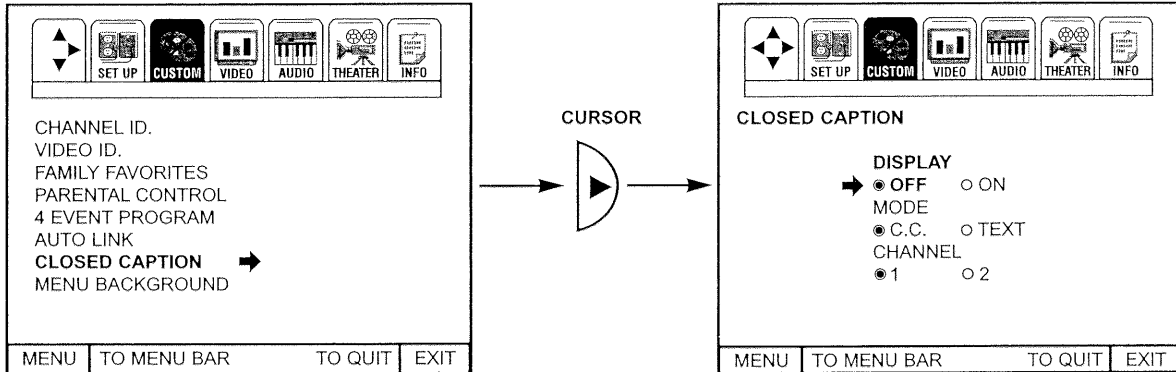

DISPLAY: ON/OFF will turn the display on or off.

MODE: C.C. (Closed Caption) is for the program you are viewing.

TEXT is for additional information such as news reports or a TV program guide. This information covers the entire screen and viewing the TV program is not possible. TEXT may not be available with every program.

CHANNEL: 1 is used for the primary language (usually English).
2 is sometimes used for a second language (may vary by region).

Use CURSOR ▲ or ▼ to highlight the function to change then press CURSOR ► to change the function. Press EXIT to quit menu or CURSOR ◀ to return to previous menu.

MENU BACKGROUND

This function allows you to choose from three menu backgrounds.

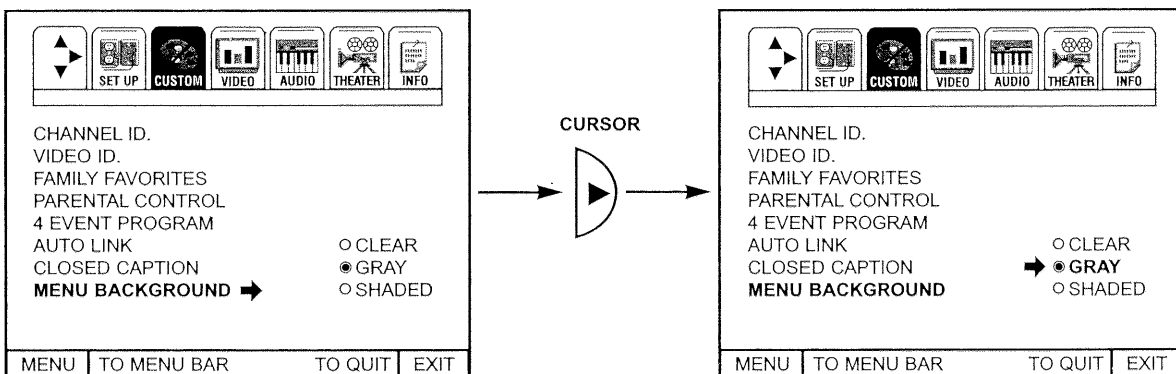

Use CURSOR ▲ or ▼ to change MENU BACKGROUND setting.

Press EXIT to quit menu or CURSOR ◀ to return to previous menu.

Select CLEAR and no background is visible, select GRAY and a gray background is visible (no picture can be seen behind menu screen), select SHADED and a light background is visible.

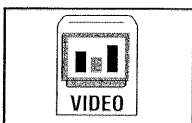

Select VIDEO to adjust picture settings exactly the way you want it and improve picture quality.

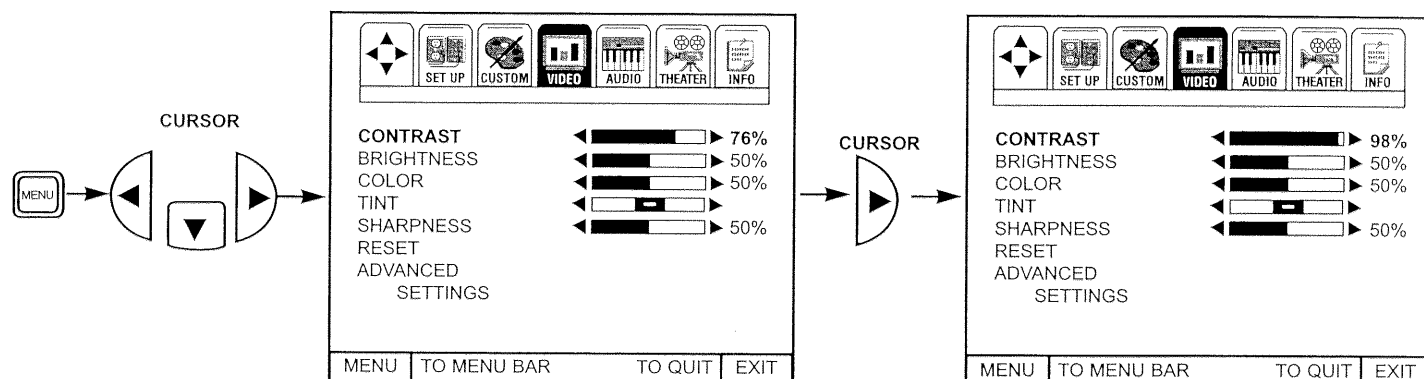

Use the CURSOR ▲ or ▼ buttons to highlight the function to be adjusted.
 Press the CURSOR ◀ or ▶ buttons to adjust the function.
 Press EXIT to quit menu.

NOTE: If CONTRAST is selected, you are adjusting CONTRAST. The additional menu items BRIGHTNESS, COLOR, TINT, and SHARPNESS can be selected and adjusted in the same manner.

- | | |
|-------------------|--|
| CONTRAST | Use this function to change the contrast between black and white levels in the picture. |
| BRIGHTNESS | Use this function to adjust overall picture brightness. |
| COLOR | Use this function to adjust the level of color in the picture. |
| TINT | Use this function to adjust flesh tones so they appear natural. (It may be necessary to adjust TINT to obtain optimum picture quality when using the COMPONENT: Y-CBCR Input:2 jacks, 36/32UX59B models only) |
| SHARPNESS | Use this function to adjust the amount of fine detail in the picture. |
| RESET | When RESET is selected, press CURSOR ▶ to return video adjustments to factory preset conditions. |

VIDEO

ADVANCED SETTINGS Select VIDEO to adjust picture settings exactly the way you want it and improve picture quality.

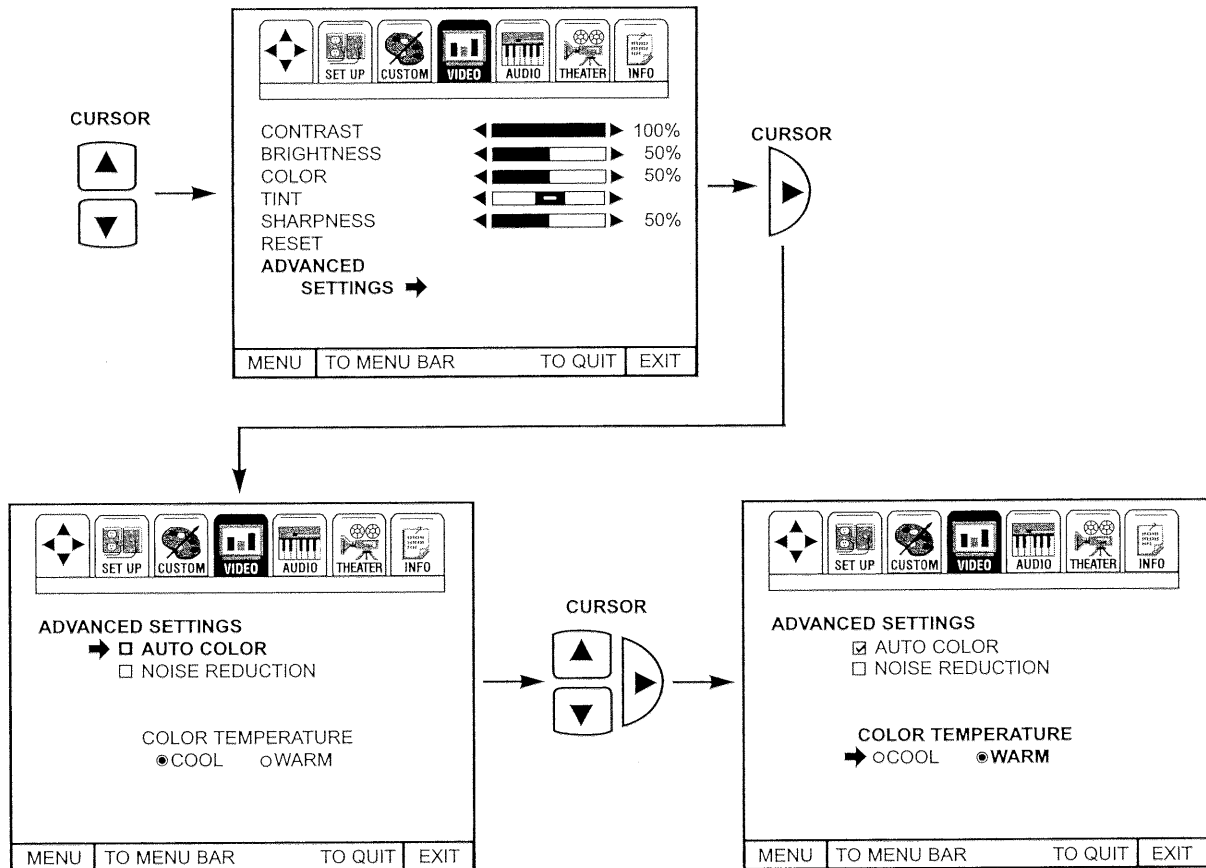

Use the CURSOR ▲ or ▼ to select function.

Press the CURSOR ► to change the function setting. When the function has an “✓” in the box, it is ON.

Press EXIT to quit menu or CURSOR ◀ to return to previous menu.

AUTO COLOR

The AUTO COLOR function automatically monitors and adjusts the color to maintain constant color levels even after a program or channel changes. It also maintains natural flesh tones while preserving fidelity of background colors.

NOTE: It may be necessary to set AUTO COLOR-ON to obtain optimum picture quality when using the COMPONENT: Y-C_BC_R Input jacks. (36/32UX59B models)

NOISE REDUCTION

The NOISE REDUCTION function automatically reduces conspicuous noise in the picture without degrading picture quality.

COLOR TEMPERATURE

Set this to WARM for hotter colors with more red, or set to COOL for less intense colors with more blue.



Select AUDIO SETTINGS to adjust the TV to your preference and to improve the sound quality.

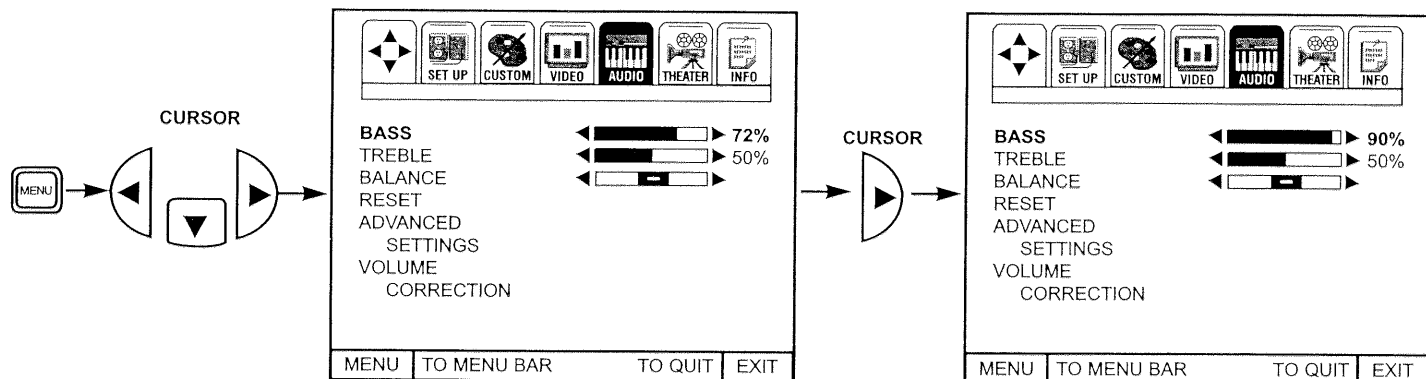

Use CURSOR ▲ or ▼ to highlight the function to be adjusted.

Press CURSOR ◀ or ▶ to adjust the function.

Use CURSOR ▲ or ▼ to highlight RESET, ADVANCED SETTINGS, or VOLUME CORRECTION then CURSOR ▶ to Select.

Press EXIT to quit menu.

NOTE: If BASS is selected you are adjusting BASS. The additional menu items TREBLE and BALANCE can be selected and adjusted in the same manner.

BASS

This function controls the low frequency audio to all speakers.

TREBLE

This function controls the high frequency audio to all speakers.

BALANCE

This function will control the left to right balance of the TV internal speakers, the AUDIO TO HI FI output.

RESET

When RESET is selected, press CURSOR ▶ to return audio adjustments to factory preset conditions.

AUDIO

ADVANCED SETTINGS

Use ADVANCED SETTINGS to improve the sound performance of your TV depending on listening conditions.

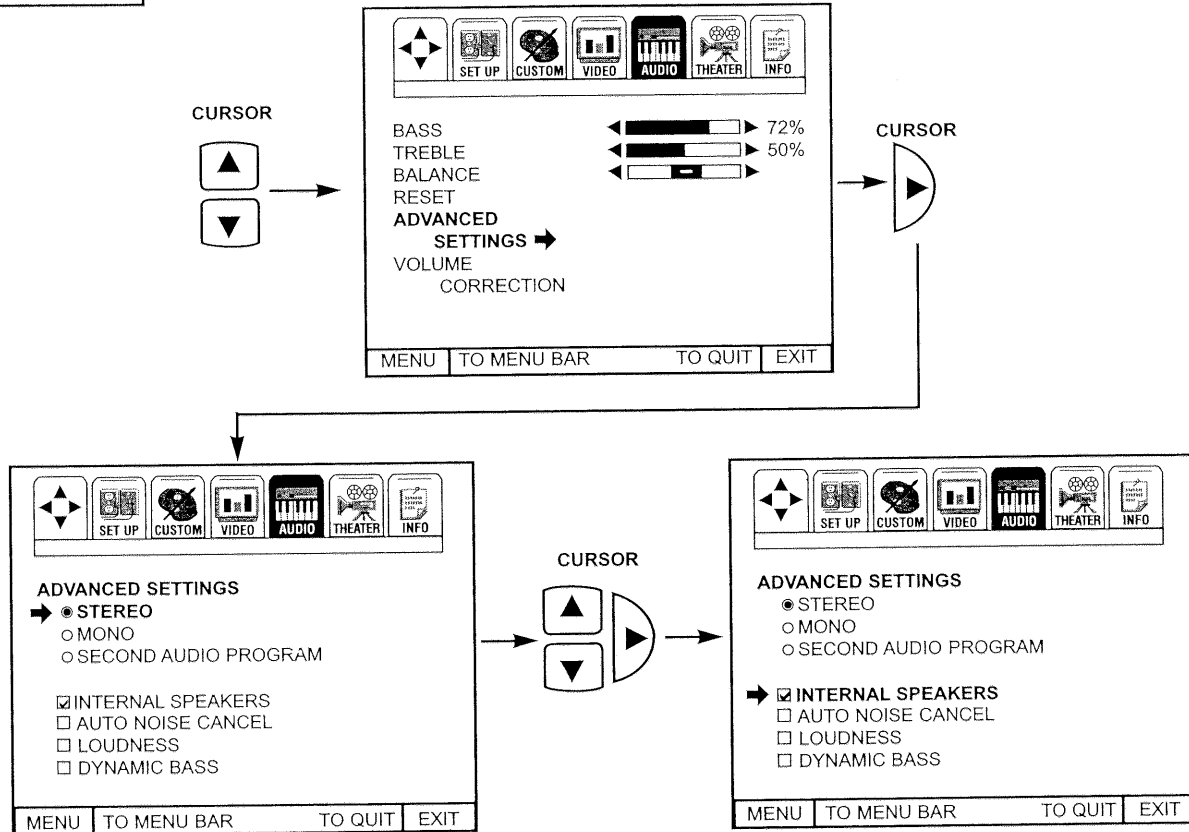

Press CURSOR ▲ or ▼ to highlight a function.

Press CURSOR ► to change the function setting. When the function has an “✓” in the box, it is ON.

Press EXIT to quit menu or CURSOR ◀ to return to previous menu.

MTS MODE

Multi-Channel Television Sound will allow you to select STEREO (a stereo broadcast), MONO (monaural sound) used when receiving a weak stereo broadcast or SAP (second audio program) which may be a secondary language, weather report, etc. The sources received will be displayed at the Top left side of the TV. The source you select will be displayed above the sources received. See example below for each selection when both stereo and second audio are received (monaural is always received).

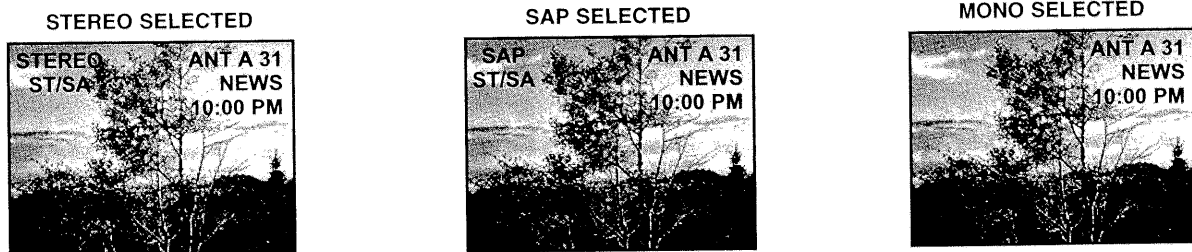

INTERNAL SPEAKERS

This function is useful when first setting up the external speakers, or if you prefer to use only speakers from a separate stereo system.

AUTO NOISE CANCEL

This function eliminates the noise between stations. If a channel is tuned and is noisy, this function will automatically eliminate the audio for that channel.

LOUDNESS

This function will improve the quality of both low and high frequency sounds when listening at low volume levels.

DYNAMIC BASS (36UX59B and 32UX59B models)

This function allows you to enjoy spectacular bass sound that would normally be heard only with expensive home speaker systems.

NOTE: Dynamic Bass Function is only available for 36UX59B and 32UX59B models.

VOLUME CORRECTION

Use this function to reduce the volume level of up to four channels that sound loud compared to other channels.

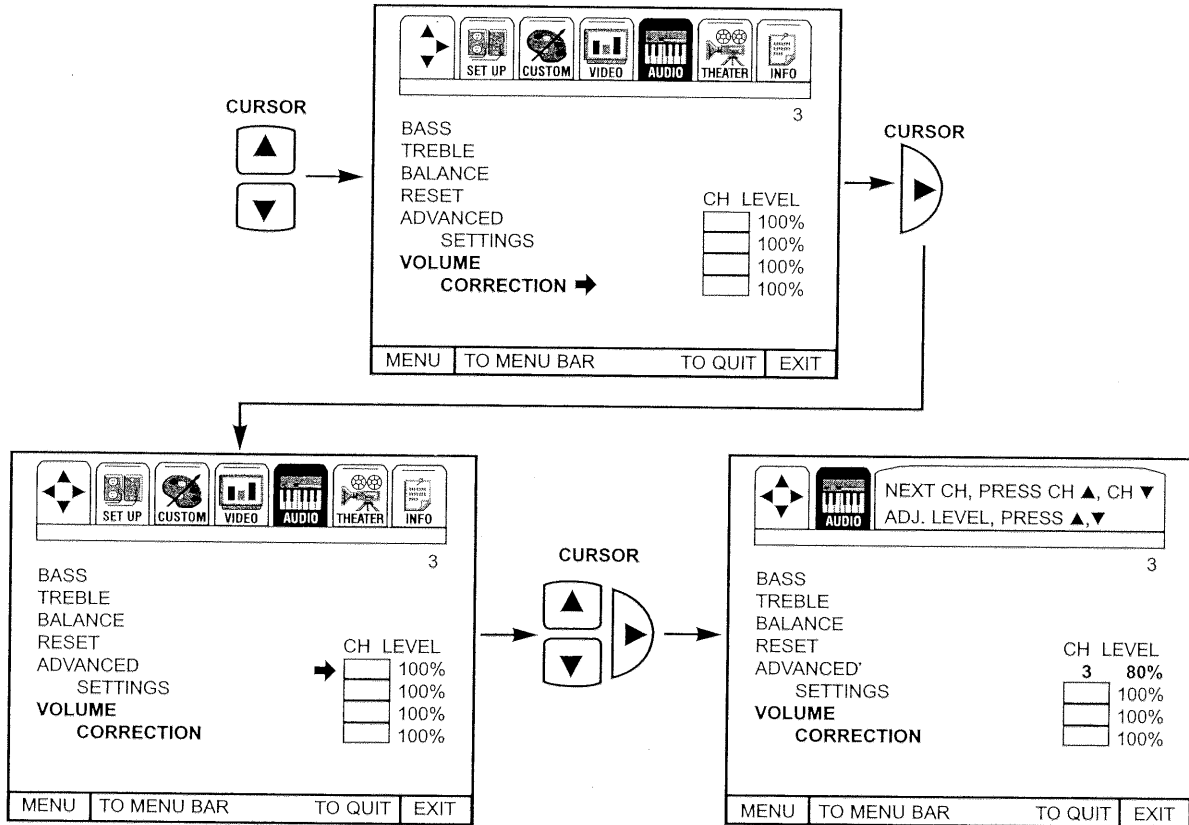

- Press CURSOR ▲ or ▼ to highlight one of the four volume corrections, then CURSOR ► to select.
- Press CHANNEL ▲ or ▼ and number buttons to select a channel.
- Press CURSOR ▲ or ▼ to adjust volume level in 5% increments.
- Press EXIT to quit menu or CURSOR ◀ to return to previous menu.

NOTE: Volume Correction adjustment is for the channel display in the top right corner of the screen. To adjust a different channel, you must select the channel with the channel or number buttons and press CURSOR ►.

If the channel has been corrected before, use the CURSOR ▲ or ▼ to highlight and CURSOR ► to select that channel, then use the CURSOR ▲ or ▼ to change the level.

To erase a channel from volume correction, select CHANNEL 00 when in incrementing mode.

The volume level will change from 50% to 100% in increments of 5%.

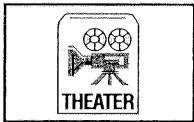

Use this function to choose Sound settings for a true THEATER experience.

SURROUND

Surround sound allows the viewer to enjoy sound which provides a feeling of “presence” from stereo broadcasts and VCR tapes recorded with stereo sound. Also at mono input, simulating a stereo will increase the sound giving the listener simulated surround sound.

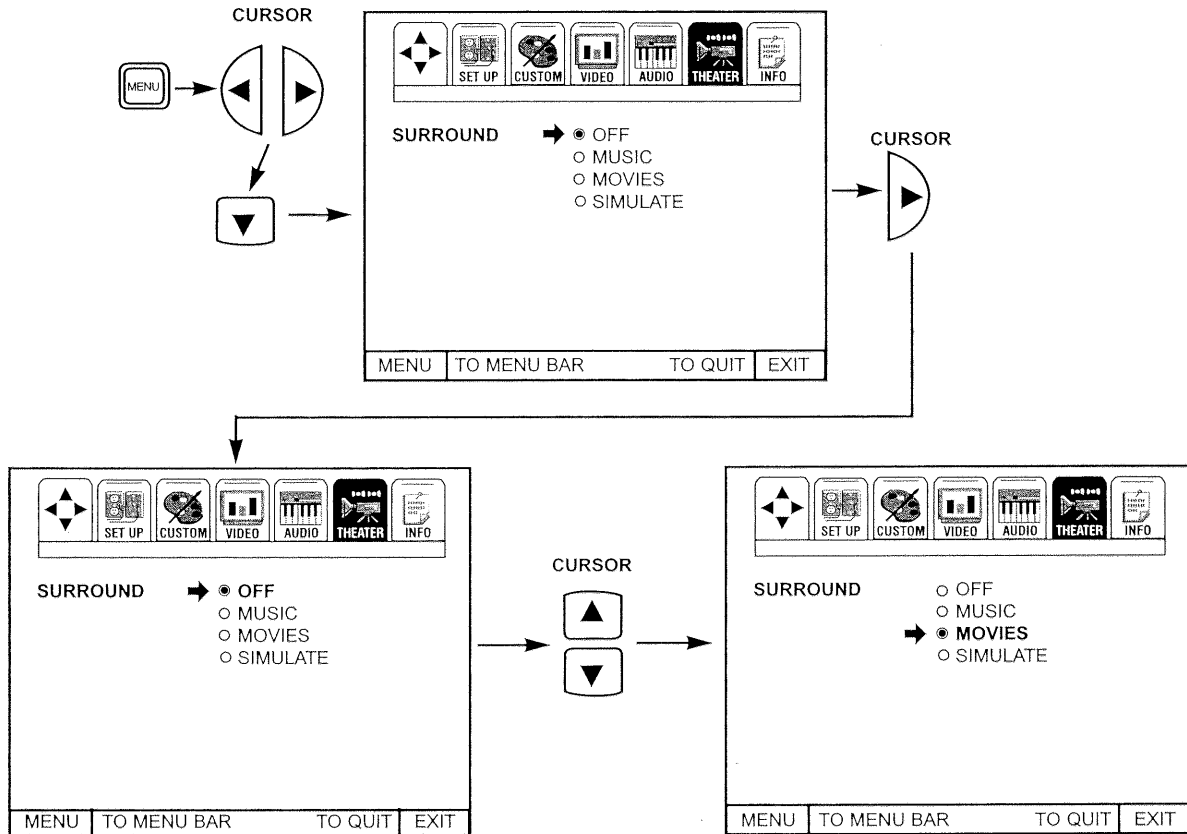

Press CURSOR ▲ or ▼ to highlight and change a surround function.
Press exit to quit or CURSOR ◀ to return to previous menu.

SURROUND OFF

Use this for normal stereo/mono broadcasts.

NOTE: If sound is noisy when a stereo broadcast is received, and the TV is set to the SURROUND mode, decrease the TREBLE control or turn the Surround OFF.

MOVIE SURROUND

Listener is surrounded by many sound sources such as a movie theater reproduction.

NOTE: Some TV systems do not transmit optimum audio channel separation which can reduce the effectiveness of the MOVIE SURROUND function.

MUSIC SURROUND

Resonant Sound-Listener has the feeling of being in a concert hall. At stereo input, the sound of music increases.

SIMULATE SURROUND

At mono input, sound is increased, simulating a stereo like Surround.

Your VCR must be a Hi-Fi or stereo unit. See page 21 for stereo VCR connection. Set must be outputting stereo. (See MTS Mode: Stereo on page 55).



This function allows your TV to assist you with your busy day-to-day schedule.

SPECIAL EVENT REMINDER

Use this function to set up to six special events into memory. These events can then be viewed in CALENDAR mode.

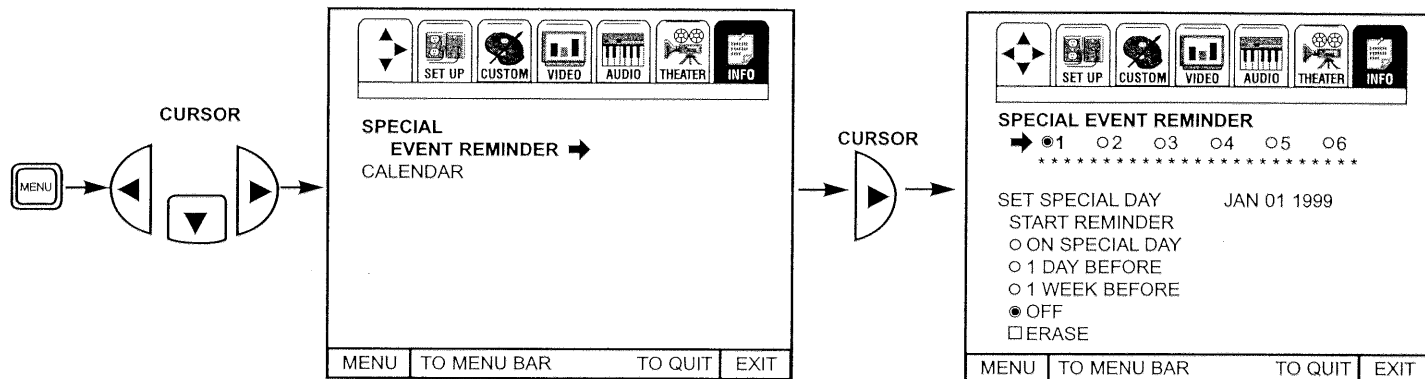

Press CURSOR ► to select EVENT 1 to 6.

Press CURSOR ▼ to select reminder message section and then Press CURSOR ► to enter reminder message section.

Press CURSOR ▲ or ▼ to select a letter.

Press CURSOR ◀ or ▶ to change position.

Highlight the day of first reminder using CURSOR buttons, then press CURSOR ► to select.

Select date of reminder using CURSOR buttons.

To erase SPECIAL EVENT, select ERASE then press CURSOR ►.

Press EXIT to quit menu or CURSOR ◀ to return to previous menu, when the CURSOR is in the first position.

If the clock is not set, you can not use this function and the next screen will appear.



- NOTE:**
1. When the TV is turned on, the SPECIAL EVENT REMINDER message will automatically appear at the selected time.
 2. Each special event message can be a maximum of 20 characters.

INFO

CALENDAR

Use this function to check the day, month, and year.

Dates programmed in SPECIAL EVENT REMINDER will appear blinking and special event message will be displayed.

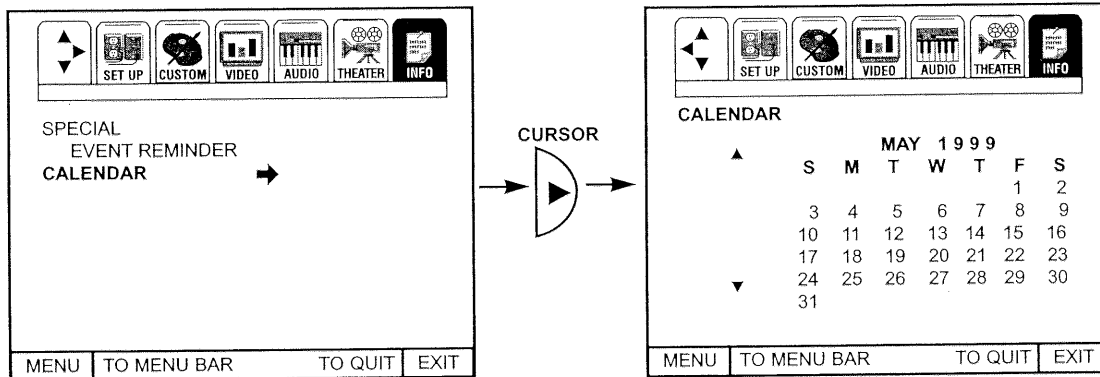

Press CURSOR ▲ or ▼ to change the month.

Press EXIT to quit menu or CURSOR ◀ to return to previous menu.

If the clock is not set, you can not use this function and the next screen will appear.

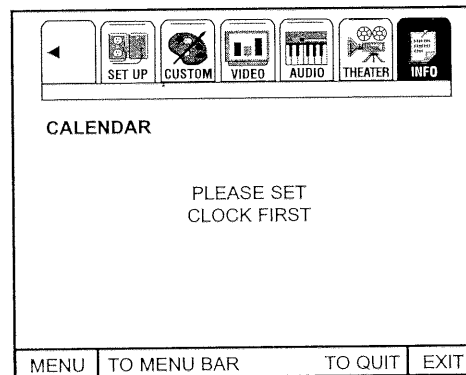

- NOTE:**
1. Dates of SPECIAL EVENT REMINDER will appear blinking. Special event message will be displayed only if current date is within the Day Of First Reminder Specifications as chosen in SPECIAL EVENT REMINDER. (See page 58).
 2. A special icon appears next to "CALENDAR" when a Special Event Reminder is set.



CARE OF YOUR HITACHI COLOR TV AND YOUR REMOTE CONTROL

DO

Make sure the TV set is turned OFF when cleaning the screen.

Dust the screen and cabinet with a soft cloth.

Clean the screen with a soft cloth moistened in warm water and dry with a soft cloth. A mild soap may be used if the screen is extremely dirty.

Place your television away from extreme heat, humidity, and extremely dusty places.

Remove the plug from the wall outlet if your television will not be used for a long period of time, for instances, when you go on vacation.

DO NOT

Do not clean your screen or cabinet with strong cleaners, polishes or a chemically treated cloth.

Do not place rubber or vinyl products or cellophane tape on your television.

Do not touch the screen too often.



Do not subject the remote control to shocks such as dropping it on the floor, etc. Physical damage to the precision parts may result.

Avoid placing the remote control in a high humidity place or getting it wet. Do not leave it on or near a heater. Excessive heat or moisture may cause the unit to cease operation.

When the batteries run down, remote control operation will become erratic or possibly stop altogether. Replace the old batteries with two new "AA" size batteries.

RECEPTION PROBLEMS

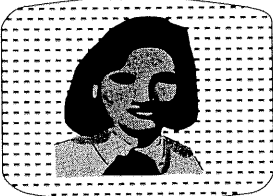
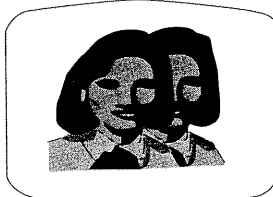

| | |
|--|---|
|  | <ul style="list-style-type: none">• IGNITION NOISE: Black spots or horizontal streaks may appear, picture may flutter or drift. Usually caused by interference from automobile ignition systems, neon lamps, electrical drills, and other electrical appliances. |
|  | <ul style="list-style-type: none">• GHOSTS: Ghosts are caused by the television signal following two paths. One is the direct path and the other is reflected from tall buildings, hills or some other objects. Changing the direction or position of the antenna may improve reception. Ghosting may also be caused by defects in the antenna system such as unshielded leads or connecting several sets to the same antenna without using multiple antenna couplers. |
|  | <ul style="list-style-type: none">• SNOW: If your receiver is located in the fringe area of a television station where the signal is weak, your picture may be marred by the appearance of small dots. When the signal is extremely weak, it may be necessary to install a special antenna to improve the picture. |
|  | <ul style="list-style-type: none">• RADIO FREQUENCY INTERFERENCE: The interference produces moving ripples or diagonal streaks, and in some cases, causes loss of contrast in the picture. |

NOTE: The TV set can generate sound distortion in external devices such as a radio. Please separate radio equipment from the TV set to a considerable distance.



| SYMPTOMS | CHECK THESE ITEMS AND TRY THESE ADJUSTMENTS | | | | | | | | | | | |
|---------------------------------|---|----------------------------------|-----------------------------|---------------------------------------|---|---------------------------------------|------------------------------|-------------------------|---------------------------|----------------------|---------------------|-----------------------|
| | Be sure external connection is correct | Be sure power cord is plugged in | Be sure TV is switched "ON" | Try another channel (station trouble) | Check antenna connections (station trouble) | Check antenna for broken lead-in wire | Check for local interference | Adjust Contrast control | Adjust Brightness control | Adjust Color control | Adjust Tint control | Adjust Volume control |
| No picture, no sound | ● | ● | ● | ● | ● | ● | ● | | | | | |
| Sound OK, picture poor | ● | | | ● | ● | ● | ● | ● | ● | | | |
| Picture OK, sound poor | ● | | | ● | ● | ● | ● | ● | | | | ● |
| Picture blurred | ● | | | ● | ● | ● | ● | ● | | | | |
| Lines or streaks in picture | | | | ● | ● | ● | ● | ● | | | | |
| Poor reception on some channels | | | | ● | ● | ● | ● | ● | | | | |
| Picture rolls vertically | | | | ● | | | | ● | | | | |
| No color | ● | | | ● | ● | ● | ● | | | ● | | |
| Poor color | ● | | | ● | ● | ● | ● | | | ● | ● | |

HITACHI Color Television incorporates advanced power surge protection technology designed to protect against component or circuit damage due to external or internal voltage power surges.

IF YOUR TELEVISION SHOULD APPEAR TO HAVE A LOSS OF POWER, PLEASE FOLLOW THIS PROCEDURE:

1. Press the power switch (ON/OFF switch) once.
2. If there is still no power, wait 30 seconds and press the power switch again.
3. If there is still no power, unplug the power cord from the wall. Wait 30 seconds and plug the power cord back in. Press the power switch again.

This protective technology should provide for years of lasting entertainment from your HITACHI Color Television.



USEFUL INFO

Features:

- Dual Antenna Inputs (**36/32UX59B** and **36/32FX49B** models)
- Superfine Picture Quality 700 Line Horizontal Resolution
- Remote Transmitter (Controls many VCR, cable box, and satellite brands)
- P-in-P Functions
- ULTRATEC BIT-MAP OSD
- Full set of input jacks, including S-Video
- Closed Caption Decoder
- Comb Filter, Wide-Band Video-Amp, Color Temperature Control and AUTO COLOR function
- MTS (Multi-Channel Television Sound) Stereo Broadcast Reception
- 3D Surround Sound (3 way)
- VM-Velocity Modulation (**36UX59B** and **32UX59B** models)
- COMPONENT: Y/C_B/C_R Input jacks (**36UX59B** and **32UX59B** models)
- Improved AUTO LINK
- Dynamic Bass (**36UX59B** and **32UX59B** models)

Screen Size: 32V (32 inches measured diagonally) **32UX59B**, **32FX49B** and **32CX39B**.
 36V (36 inches measured diagonally) **36UX59B**, **36FX49B** and **36CX39B**.

Inputs:

- Power InputAC 120V, 60Hz
- Power Consumption (maximum)

| | |
|----------------------|-------|
| 36UX59B | .188W |
| 36FX49B | .183W |
| 36CX39B | .171W |
| 32UX59B | .177W |
| 32FX49B | .172W |
| 32CX39B | .166W |
- Antenna input impedance75 Ohm
- Channel coverage181 ch.

| | |
|---------------------|--------------|
| VHF-Band | .2 ~ 13 |
| UHF-Band | .14 ~ 69 |
| CATV Mid Band | .A-5 ~ A-1 |
| | .A-1 |
| Super Band | .J-W |
| Hyper Band | .W+1 - W+28 |
| Ultra Band | .W+29 - W+84 |
- Video1.0Vp-p, 75 Ohm
- S-Video

| | |
|-----------------------|--------------------|
| Luminance (Y) | .1.0Vp-p, 75 Ohm |
| Chrominance (C) | .0.286Vp-p, 75 Ohm |
- Audio input level47k Ohm
- Average input level470mVrms
- Maximum input level940mVrms
- Component Video

| | |
|----------------------------|------------------|
| Luminance (Y) | .1.0Vp-p, 75 Ohm |
| Chrominance (Cb, Cr) | .0.7Vp-p, 75 Ohm |

Outputs:

- Audio470mVrms, 1k Ohm

Dimensions:

| | 32CX39B | 36CX39B |
|----------------|---------------------------------|----------------------------------|
| | 32FX49B | 36FX49B |
| | 32UX59B | 36UX59B |
| • Height (in). | 26 ⁵ / ₁₆ | 29 ¹⁷ / ₃₂ |
| • Width (in). | 31 ¹ / ₁₆ | 35 |
| • Depth (in). | 22 ¹ / ₄ | 24 ¹³ / ₃₂ |

NOTE: Due to improvements, specifications in this operating guide are subject to change without notice.



USEFUL INFO

HITACHI

*Service
hotline*

To locate an authorized
HITACHI service facility
in the continental U.S.A.
and Canada,

DIAL TOLL FREE

7 days a week, 24 hours a day

800 HITACHI

(1-800-448-2244)

Hitachi America, LTD. Home Electronics Division

Hitachi has made every effort to assure you hours of trouble free operation from your unit. However, should you require service, a network of Hitachi Authorized Service Facilities has been established in all 50 states and Puerto Rico. Each facility will provide you with convenient and expedient assistance. Our service hotline operator will direct you to the Hitachi Authorized Service Facility nearest you. Just present proof of purchase and/or delivery receipts to the Hitachi Authorized Service Facility, and service will be rendered in accordance with the terms of the limited warranty as stated on your warranty card or operating guide.

Should you have any questions regarding warranty, service, operation, or technical assistance, please contact:

**Hitachi America, LTD.
Home Electronics Division**
1855 Dornoch Court
San Diego, CA 92173

*In Canada, please contact: 1-800-HITACHI
(1-800-448-2244)*

HITACHI (HSC) Canada Inc
6740 Campobello Road
Mississauga, Ont. L5N 2L8

Free Manuals Download Website

<http://myh66.com>

<http://usermanuals.us>

<http://www.somanuals.com>

<http://www.4manuals.cc>

<http://www.manual-lib.com>

<http://www.404manual.com>

<http://www.luxmanual.com>

<http://aubethermostatmanual.com>

Golf course search by state

<http://golfingnear.com>

Email search by domain

<http://emailbydomain.com>

Auto manuals search

<http://auto.somanuals.com>

TV manuals search

<http://tv.somanuals.com>