

# HITACHI

Color Plasma Display

**USER'S MANUAL**

---

Model

**42PD580DTA**

**READ THE INSTRUCTIONS INSIDE CAREFULLY.  
KEEP THIS USER'S MANUAL FOR FUTURE REFERENCE.**

For future reference, record the serial number of your Plasma TV.

**SERIAL NO.** \_\_\_\_\_

The serial number is located on the rear of the Plasma TV.

**NOTE:**

The information in this manual is subject to change without notice. The manufacturer assumes no responsibility for any errors that may appear in this manual.

**TRADEMARK ACKNOWLEDGEMENT**

VGA and XGA are registered trademarks of International Business Machines Corporation.

APPLE and Macintosh are registered trademarks of Apple Computer, Inc.

VESA is a trademark of a nonprofit organization, Video Electronics Standard Association.

All brand or product names are trademarks or registered trademarks of their respective holders.



**HITACHI**

# USER'S MANUAL

Thank you very much for purchasing the HITACHI PDP TV. Before using your TV, please carefully read the "SAFETY INSTRUCTIONS" and this "USER'S MANUAL" so you will know how to operate the PDP TV properly. Keep this manual in a safe place. You will find it useful in the future.

**Notes on Installation Work:**

This product is marketed assuming that it is installed by qualified personnel with enough skill and competence. Always have an installation specialist or your dealer install and set up the product. HITACHI cannot assume liabilities for damage caused by mistake in installation or mounting, misuse, modification or a natural disaster.

**Note for Dealers:**

After installation, be sure to deliver this manual to the customer and explain to the customer how to handle the product.

# IMPORTANT SAFETY INSTRUCTIONS



## Read before operating equipment

Follow all warnings and instructions marked on this television.

1. Read these instructions.
2. Keep these instructions.
3. Heed all warnings.
4. Follow all instructions.
5. Do not use this apparatus near water.
6. Clean only with a dry cloth.
7. Do not block any ventilation openings. Install in accordance with the manufacturer's instructions.
8. Do not install near any heat sources such as radiators, heat registers, stoves, or other apparatus (including amplifiers) that produce heat.
9. Do not defeat the safety purpose of the polarized or grounding-type plug. A polarized plug has two blades with one wider than the other. A grounding type plug has two blades and a third grounding prong. The wide blade or the third prong are provided for your safety. If the provided plug does not fit into your outlet, consult an electrician for replacement of the obsolete outlet.
10. Protect the power cord from being walked on or pinched particularly at plugs, convenience receptacles, and the point where they exit from the apparatus.
11. Only use the attachments/accessories specified by the manufacturer.
12.  Use only with the cart, stand, tripod, bracket, or table specified by the manufacturer, or sold with the apparatus. When a cart is used, use caution when moving the cart/apparatus combination to avoid injury from tip-over.
13. Unplug this apparatus during lightning storms or when unused for long periods of time.
14. Refer all servicing to qualified service personnel. Servicing is required when the apparatus has been damaged in any way, such as power-supply cord or plug is damaged, liquid has been spilled or objects have fallen into apparatus, the apparatus has been exposed to rain or moisture, does not operate normally, or has been dropped.

15. Televisions are designed to comply with the recommended safety standards for tilt and stability.

Do not apply excessive pulling force to the front, or top, of the cabinet which could cause the product to overturn resulting in product damage and/or personal injury.

16. Follow instructions for wall, shelf or ceiling mounting as recommended by the manufacturer.
17. An outdoor antenna should not be located in the vicinity of overhead power lines or other electrical circuits.
18. Under no circumstances remove the rear cover of your PDP TV.  
Never guess or take any chances with electrical equipment of any kind - it is better to be safe than sorry!
19. After the PDP TV has been on for any length of time, you will notice that the screen becomes warm. Please note that this is normal.  
Sometimes the screen might have some tiny bright or dark spots. Please note that this is normal.
20. To prevent scratches or damages to the Plasma screen, do not knock or rub the surface with sharp or hard objects.  
Clean the screen with a soft cloth moistened with warm water and dry with a soft cloth. A mild soap may be used if the screen is extremely dirty. Do not use harsh or abrasive cleaners!
21. Use a soft cloth to clean the cabinet and control panel of the PDP TV. When excessively soiled dilute a neutral detergent in water, wet and wring out the soft cloth and afterward wipe with a dry soft cloth.  
Never use acid/alkaline detergent, alcoholic detergent, abrasive cleaner, powder soap, OA cleaner, car wax, glass cleaner, etc. especially because they would cause discoloration, scratches or cracks.

This product contains lead. Dispose of this product in accordance with applicable environmental laws. For product recycling and disposal information, contact your local government agency.

Do not place any objects on the top of the television which may fall or cause a child to climb to retrieve the objects.

## PREVENTION OF SCREEN BURN

Continuous on-screen displays such as video games, stock market quotations, computer generated graphics, and other fixed (nonmoving) patterns can cause permanent damage to television receivers. Such "SCREEN BURNS" constitute misuse and are **NOT COVERED** by your HITACHI Factory Warranty.

## PUBLIC VIEWING OF COPYRIGHTED MATERIAL

Public viewing of programs broadcast by TV stations and cable companies, as well as programs from other sources, may require prior authorization from the broadcaster or owner of the video program material.

## FEATURES

### Large-screen, high-definition plasma display panel

The 42-inch color plasma display panel, with a resolution of 1024 (H) x 1024(V) pixels, creates a high-definition, large-screen (aspect ratio : 16:9) and low-profile flat display. Free from electromagnetic interferences from geomagnetic sources and ambient power lines, the panel produces high-quality display images free from color misconvergence and display distortion.

### High Performance Digital Processor

A wide range of input signals can be handled, including composite, component, and HDMI.

High Definition Digital Processor creates the fine-textured image with dynamic contrast.

In addition, it corresponds to a broad array of personal computer signals, from 640 x 400 and 640 x 480 VGA to 1280 x 1024 XGA.(PC RGB Input)

### Easy-to-use remote control and on screen display system

The remote control included eases the work of setting display controls. Further, the on-screen display system, displays the status of signal reception and display control settings in an easy-to-view fashion.

### Power saving system

The power saver feature saves power consumption automatically when input signals are not available. When connected to a VESA DPMS-compliant PC, the PDP TV cuts its power consumption while it is idle.

### Connecting to an Audio Visual Device

- One S-Video terminal, one composite terminal, one component terminals, a HDMI terminal and a PC RGB input terminal have been added.
- A video output terminal is also provided as a monitoring output.
- A wide range of devices can also be connected besides personal computers.

### Options

TV stand or wall mount

# CONTENTS

<b>IMPORTANT SAFETY INSTRUCTIONS .....</b>	<b>2</b>	<b>OTHER FUNCTIONS .....</b>	<b>43</b>
<b>FEATURES .....</b>	<b>3</b>	Audio Switching .....	43
<b>SAFETY INSTRUCTIONS .....</b>	<b>5</b>	Signal Check .....	44
<b>IMAGE RETENTION OF PLASMA DISPLAY ..</b>	<b>9</b>	Power Save Mode.....	45
<b>COMPONENT NAMES.....</b>	<b>10</b>	<b>TROUBLESHOOTING .....</b>	<b>46</b>
Main Unit .....	10	Symptoms That Seemingly Appear to be Failures .....	46
Remote control .....	11	Actions to Correct Abnormal Displays .....	48
Loading Batteries .....	11	<b>PRODUCT SPECIFICATIONS .....</b>	<b>49</b>
Handling the Remote Control.....	11	Recommended Signal List .....	50
Function Buttons.....	12		
<b>INSTALLATION INSTRUCTIONS .....</b>	<b>19</b>		
Installation.....	19		
Connecting to an Audio Visual Device.....	20		
Connecting to a PC.....	24		
Power Cord Connection .....	25		
<b>OPERATING INSTRUCTIONS.....</b>	<b>26</b>		
Turning Power On and Off .....	26		
Input Switching .....	27		
Volume Adjustment .....	27		
Audio Mute .....	27		
Input Signal Screen Display .....	28		
Using the Menu Screen (On-screen display system) .....	29		
Video Menu.....	30		
Image Menu.....	31		
Audio Menu .....	32		
Language Menu.....	32		
System Menu.....	33		
Using the HDTV Menu Screen.....	36		
Edit Channel.....	37		
Parental Guidance.....	38		
Installation.....	39		
General Setting.....	41		
System.....	42		

## Notes about This Manual

- The information in this manual is subject to change without notice.
- While meticulous care has been taken in the preparation of this manual, you are requested to notify your dealer or us should you have any comments, views or questions about our product.
- Fully understand the prerequisites to using the product, such as hardware and software specifications and constraints, in using the product. We are not held liable for damages caused by improper handling of the product.
- Reproduction of this manual in whole or in part without our prior written permission is prohibited.
- The product names mentioned in this manual may be trademarks or registered trademarks of their respective owners.



## SAFETY INSTRUCTIONS

This PDP TV has been designed and manufactured to meet international safety standards, but like any electrical equipment, care must be taken if you are to obtain the best results and safety is to be assured. Before using this product, please read and understand the Safety Instructions thoroughly to ensure correct usage, and follow all the instructions.

### About the Symbols

Various symbols are used in this manual, the user's manual and on the product itself to ensure correct usage, to prevent danger to the user and others, and to prevent property damage. The meanings of these symbols are described below. It is important that you read these descriptions thoroughly and fully understand the contents.



**WARNING**

This symbol indicates information that, if ignored, could possibly result in personal injury or even death due to incorrect handling.



**CAUTION**

This symbol indicates information that, if ignored, could result possibly in personal injury or physical damage due to incorrect handling.

#### Typical Symbols



This symbol indicates an additional warning (including cautions). An illustration is provided to clarify the contents.



This symbol indicates a prohibited action. The contents will be clearly indicated in an illustration or nearby (the symbol to the left indicates that disassembly is prohibited).



This symbol indicates a compulsory action. The contents will be clearly indicated in an illustration or nearby (the symbol to the left indicates that the power plug should be disconnected from the power outlet)



**WARNING**

Never use the PDP TV if a problem should occur.

Abnormal operations such as smoke, strange odor, no image, no sound, excessive sound, damaged casing, elements, cables, penetration of liquids or foreign matter, etc. can cause a fire or electrical shock.

In such case, immediately turn off the power switch and then disconnect the power plug from the power outlet. After making sure that the smoke or odor has stopped, contact your dealer. Never attempt to make repairs yourself because this could be dangerous.

Do not insert liquids or foreign objects.

Penetration of liquids or foreign objects could result in fire or electrical shock. Use special caution in households where children are present.

If liquids or foreign objects should enter the television, immediately turn off the power switch, disconnect the power plug from the power outlet and contact your dealer.

- Do not place the television in a bathroom.
- Do not expose the television to rain or moisture.
- Do not place flower vases, pots, cups, cosmetics, liquids such as water, etc on or around the television.
- Do not place metals, combustibles, etc on or around the television.

Never disassemble or modify the PDP TV.

The television contains high voltage components. Modification could result in fire or electrical shock.

- Never remove any fixed cover.

Do not give the PDP TV any shock or impact.

If the television should be shocked and/or broken, it could result in an injury, and continued use could result in fire or electrical shock. If the glass panel is broken or damaged, immediately turn off the power switch, disconnect the power plug from the power outlet and contact your dealer.

Do not place the PDP TV on an unstable surface.

If the television should be dropped and/or broken, it could result in an injury, and continued use could result in fire or electrical shock.

- Do not place the television on an unstable, slant or vibrant surface such as a wobbly or inclined stand.

Do not obstruct the ventilation of the PDP TV.

If the ventilation is obstructed during the operation of the television or just after switching off the power, it could result in damage and shorten the lifespan of your television due to overheating. Make sure there is ample ventilation.

- Keep a space of 100mm (10cm) or more between the sides, rear and top of the television and other objects such as walls.
- Do not place anything around ventilation openings of the television.
- Never block ventilation openings.
- Do not put the PDP panel side up.
- Do not cover the television with a tablecloth, etc.
- Do not place the television on a carpet or bedding, or near a curtain.

Use only the correct power outlet.

Incorrect power supply could result in fire or electrical shock. Use only the correct power outlet depending on the indication on the television and the safety standard.

- The enclosed power cord must be used depending on the power outlet to be used.



Disconnect the plug from the power outlet.



Do not disassemble.



## SAFETY INSTRUCTIONS (continued)

### About the Symbols (continued)

#### **WARNING**

Be cautious of the power cord connection.

Incorrect connection of the power cord could result in fire or electrical shock.

- Do not touch the power cord with a wet hand.
- Check that the connecting portion of the power cord is clean (with no dust), before using. Use a soft and dry cloth to clean the power plug.
- Insert the power plug into a power outlet firmly. Avoid using a loose, unsound outlet or contact failure.
- Do not cut off the fitted power plug, the removal of which could lead to impaired performance. If you wish to extend the lead, obtain an appropriate extension lead or consult your dealer.
- Should you require replacing the fuse in the molded plug with a new fuse, then please replace with new one of the same value, type and approval as the original. Ensure the fuse cover is returned to its original position.



Be sure to keep safety ground connection.

Connect the ground terminal of AC inlet of this television with the ground terminal provided at the power outlet using the enclosed power cord. If the provided plug does not fit your outlet, consult an electrician for replacement of the obsolete outlet.



Surely connect the ground wire.

Be careful in handling the power cord and external connection cables.

If you keep using a damaged the power cord or cables, it can cause a fire or electrical shock. Do not apply too much heat, pressure or tension to the power cord and cables.

If the power cord or cables are damaged (exposed or broken core wires, etc.), contact your dealer.

- Do not place the television or heavy objects on the power cord and cables. Also, do not place a spread, cover, etc, over them because this could result in the inadvertent placing of heavy objects on the concealed power cord or cables.
- Do not pull the power cord and cables. When connecting and disconnecting the power cord or cables, do it with your hand holding the plug or connector.
- Do not place the cord near the heater.
- Do not touch the power plug just after disconnecting it from the power outlet to prevent electric shock.
- Do not touch the power plug when lightening is close to you.
- Avoid coiling the power cord and bending it sharply.
- Protect the power cord from being walked on, pinched particularly at plugs, conveniences receptacles, and the point where they exit from the apparatus.
- Do not modify the power cord.



Be careful in handling the battery of the remote control.

Incorrect handling of the battery could result in fire or personal injury. The battery may explode if not handled properly.

- Keep the battery away from children and pets. If swallowed consult a physician immediately for emergency treatment.
- Do not allow the battery to be exposed to fire or water.
- Avoid fire or high-temperature environment.
- Do not hold the battery with metallic tweezers.
- Keep the battery in a dark, cool and dry place.
- Do not short circuit the battery.
- Do not recharge, disassemble or solder the battery.
- Do not physically impact the battery.
- Use only the battery specified in the manual of this television.
- Make sure the plus and minus terminals are correctly aligned when loading the battery.
- If you observe a leakage of the battery, wipe out the liquid and then replace the battery. If the liquid adheres your body or clothes, rinse well with water.
- Obey the local laws on disposing the battery.



## SAFETY INSTRUCTIONS (continued)

### About the Symbols (continued)

#### CAUTION

Be careful in moving the PDP TV  
Neglect could result in an injury or damage.

- Do not move the television during use. Before moving, disconnect the power plug and all external connections.
- You are advised to move the television with two persons.
- Avoid any impact or shock to the television; particularly take care of glass screen.

Do not put anything on top of the PDP TV.

Placing anything on the television could result in loss of balance or falling, and cause an injury or damage. Use special caution in households where children are present.

Avoid a humid or dusty place.

Placing the television in a smoke, a highly humid, dusty place, oily soot or corrosive gas could result in fire or electrical shock.

- Do not place near the kitchen, a humidifier or other place where there is oil, smoke or humidity.

Avoid a high temperature environment.

The heat could have adverse influence on the television and other parts, and could result in transformation, melting or fire.

- Do not place the television, the remote control and other parts in direct sunlight or near a hot object such as heater, etc.
- Do not put the television in a place where the temperature is widely changing.

Remove the power cord for complete separation.

- For safety purposes, disconnect the power cord if the television is not to be used for prolonged periods of time.
- Before cleaning, turn off and unplug the television. Neglect could result in fire or electrical shock.

#### PRECAUTIONS

Installation environment

Do not obstruct a ventilation hole.

Do not put the television on carpet or blanket, or near a curtain which has a possibility of obstructing a ventilation hole of the television. Do not put the television in the following places.

- Hot places such as near heater, place exposed to the direct rays of the sun.
- A place where the temperature is widely changing.
- Places with soot, dust or high humidity.
- Poor air ventilation place.
- Place near fire.
- A wet place such as bathroom, or shower room.
- Place where you can trip over it.
- Always vibrating or strongly vibrating places.
- Distorted or unstable places.

How to view the PDP TV

If you use the television in too dark a room, your eyes may become tired. Please use it in a reasonably bright room.

Avoid direct rays of the sun to the screen in order to prevent eye fatigue. Your eyes will get fatigued after viewing the television for long period of time. Relax your eyes by viewing away from the television from time to time.

Please watch the television in downward direction.

Note on image retention

The plasma PDP TV illuminates phosphor to display images. The phosphor has a finite illumination life. After extended periods of illumination, the brightness of the phosphor will be degraded to such extent that stationary images would burn-in that part of the screen as grayed-out images.

Tips to prevent such image retention are:

- Do not display images having sharp brightness differences or high-contrast images, such as monochrome characters and graphic patterns, for long.
- Do not leave stationary images appearing for long, but try to refresh them at appropriate intervals of time, or try to move them using screen saver function.
- Turn down the contrast and brightness controls.

How to clean the plasma screen panel of the PDP TV

Before cleaning the television, turn off the television and disconnect the power plug from the power outlet.

To prevent scratching or damaging the PDP screen face, do not knock or rub the surface with sharp or hard objects. Clean the screen with a soft cloth moistened with warm water and dry with a soft cloth. If it is not enough, then use a cloth with mild detergent. Do not use harsh or abrasive cleaners.

How to clean the cabinet of the PDP TV

Use a soft cloth to clean the cabinet and control panel of the television. When excessively soiled dilute a neutral detergent in water, wet and wring out the soft cloth and afterward wipe with a dry soft cloth.

Never use acid/alkaline detergent, alcoholic detergent, abrasive cleaner, powder soap, OA cleaner, car wax, glass cleaner, etc. especially because they would cause discoloration, scratches or cracks.



Disconnect the plug from the power outlet.

## SAFETY INSTRUCTIONS (continued)

### About the Symbols (continued)

#### Prevention of an obstacle to Radio receivers

This television has been designed pursuant to the international EMI standards. This is to prevent a problem to Radio receivers.

- Keep the television away from Radio.
- Adjust Radio antennas in order for the television not to receive interference.
- The antenna cable of Radio should be kept away from the television.
- Use a coaxial cable for antenna.

You can check if this television influences Radio receivers by turning off all other equipment other than the television. If you find a problem receiving Radio when using the television, check the instructions mentioned above.

#### Precautions for the cable connection

- Do ensure that all connections, (including the power plug, extension leads and interconnections between the pieces of equipment), are properly made and in accordance with the manufacturers instructions. Switch off and withdraw the power plug before making or changing connections.
- Confirm the connector is fixed tightly when the signal cable is connected. Also confirm the screws on the connector are tightened.
- Plug the power cord of the television into a different socket from that for other equipment, such as Radio etc.
- Use a plug with ground terminal and make sure that it connects to the ground.

#### Precaution during transportation

Please pay attention when you transport this television because it is heavy.

Furthermore, use the original carton box and its packaging materials when the television is transported. Failure to transport the television in any carton except the original carton may result in damage to the television. Save the original carton box and all packing material.

#### Do not physically impact the remote control.

A physical impact could cause damage or malfunction of the remote control.

- Take care not to drop the remote control.
- Do not place heavy objects on the remote control.

#### Avoid strong rays.

Any strong rays (such as direct sun rays or room lighting) onto the remote control sensors could invalidate the remote control.

#### Avoid radio interference.

Any interfering radiation could cause distorted images or noises.

- Avoid radio generator such as a mobile telephone, transceiver, etc. around the television.

#### Set the sound volume at a suitable level.

It is better to keep the volume level low and close the windows at night to protect the neighborhood environment.

#### Precautions for the installation

- Do not use makeshift stands and NEVER fix legs with wood screws - to ensure complete safety, always fit the manufacturers approved stand or legs with the fixings provided according to the instructions.
- Use only with the cart, stand, tripod, bracket, or table specified by the manufacturer, or sold with the apparatus. When a cart is used, use caution when moving the cart/apparatus combination to avoid injury from tip-over.
- This product is designed to comply with the recommended safety standards for tilt and stability. Do not apply excessive pulling force to the front, or top, of the cabinet that could cause the product to overturn resulting in product damage and/or personal injury.
- Follow instructions for wall, shelf or ceiling mounting as recommended by the manufacturer.
- Only use the attachments/accessories specified by the manufacturer.
- Consult your dealer if you are in any doubt about installation, operation or safety of your equipment.

#### Other precautions

- Do not leave equipment switched on when it is unattended unless it is specifically stated that it is designed for unattended operation or has a stand-by mode. Switch off using the switch on the equipment and show your family how to do this. Make special arrangements for infirm or handicapped people.
- Disposal of this product may require specific instructions pertaining to your resident region.
- Never guess or take any chances with electrical equipment of any kind - it is better to be safe than sorry!

## IMAGE RETENTION OF PLASMA DISPLAY

There are different characteristics that result in panel image retention depending on how the plasma display is used. Situations and effective usage methods related to ghosting are provided below.

### Image retention characteristics of a plasma display

The image retention phenomenon of a plasma panel occurs due to partial phosphor degradation arising from partial character and figure display.

For example, when the character image as shown in Fig. A at the right is continuously displayed for a long period of time, the only part of the phosphor (Red, Green, Blue) that will degrade will be the color of the applicable character display portion.

Consequently, when a white image is displayed on the entire screen as shown in Fig. a, the character marks displayed up to that time will become a color difference visible to the eye, but the phosphor will never burn.

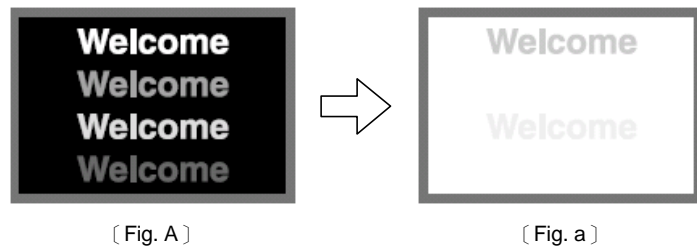

■ The degree of image retention is proportional to the brightness of the characters and figures displayed as well as the display time.

- The tendency of the phosphor is to degrade more the brighter the characters and figures are displayed. When images of figures with different levels of brightness, as shown in Fig. B, are continuously displayed for a long period of time, it becomes easier for image marks at locations when the brighter figures are displayed to be noticeable.

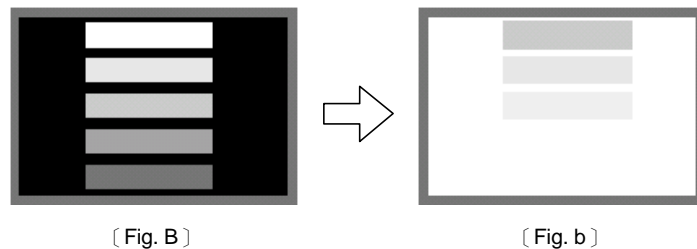

\* The image retention images in this document are exaggerated for the purpose of explanation. The actual manner in which the image retention is seen differs depending on the operation time and brightness.

### Methods to Reduce the Occurrence of Image Retention

- Lower the Contrast and Brightness settings of the plasma display as much as possible.  
A function is provided in the display that controls the brightness of the screen to reduce degradation of the panel. Using this function makes it possible to reduce image retention.
  - Set the PDP TV to a "Move Screen" display.  
Move Screen function works to reduce image retention when displaying images on the four corners, such as TV station logos and clock display.  
(Settings can be made using Move Screen from Function MENU shown on  .)
  - Using in combination with moving images  
Since the degradation of the fluorescent material progresses comparatively uniform for moving images, the occurrence of partial image retention can be controlled. We recommend to use in combination with moving images such as a DVD.
- \* Please be careful since image retention will occur if display is left in PIP display state for a long period of time.  
\* Television broadcasts include images displayed for long periods of time in which the left and right or top and bottom of the image are cut and broadcast station name or time are displayed for a long period of time at the same portion of the screen. Image retention in these portions can be expected to occur, so please be aware.

## Notes

### About screen defects

- High precision technology is used in the making of plasma panels but there may be dark spots (points that do not illuminate) and bright spots (points that are too bright) in some cases. These do not indicate a malfunction.

### About residual images

- In some cases, residual images may remain after the short-term display of still images and another image is displayed, but these will disappear and return to normalcy. This is not a malfunction.

### About the panel screen

- Plasma displays display images by means of electrical discharges inside the panel. Because of this, the temperature of the panel surface may rise in some cases. Also, plasma displays are made of finely processed glass. A reinforced glass filter is installed over the panel surface but avoid strong impact because there is still danger of glass breakage.

# COMPONENT NAMES

## Main Unit

Front

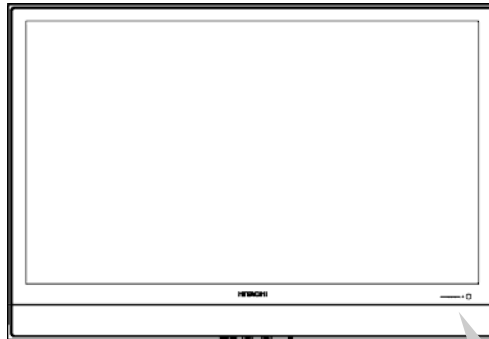

### Control panel

- Adjustment buttons are located on the bottom.
- The front bezel is provided with indications to distinguish the adjustment buttons.

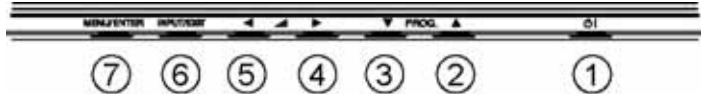
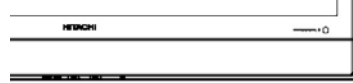

- ① POWER
- ② PROGRAM▲/UP▲
- ③ PROGRAM▼/DOWN▼
- ④ VOLUME►/RIGHT►
- ⑤ VOLUME◄/LEFT◄
- ⑥ INPUT/EXIT
- ⑦ MENU/ENTER

• Normal button action/Button action when MENU engaged

Indicating lamp 26

Remote-control receiver 11

Main power switch 26

• The main power switch is located at the back, on the right side.

### Caution when moving the main unit

- As this product is heavy, whenever it is moved, two people are required to transport it safely.
- Whenever the unit is moved it should be lifted forwards using the two handgrips at the back, and the unit should then be held at the base on both sides for stability.

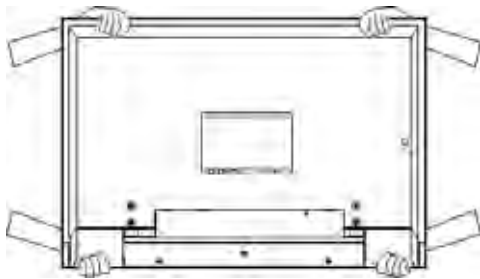

Rear

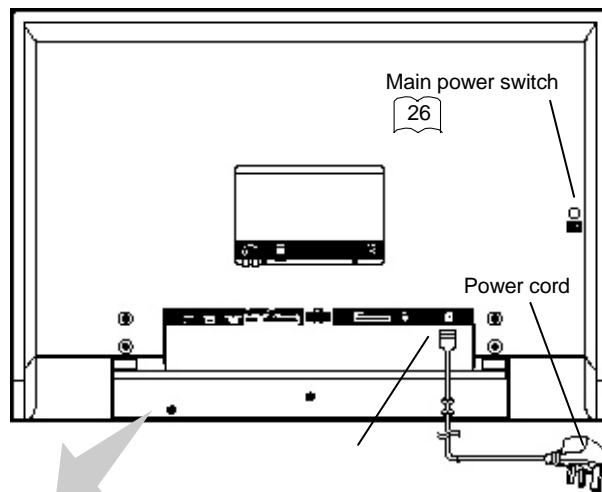

Main power switch 26

Power cord

### External device connection terminals



\* Input terminals from 20 to 24.

## COMPONENT NAMES (continued)

### Remote control

#### Loading Batteries

1. Open the battery cover of the remote control by pressing the notched part of the cover with your fingers and pulling the cover off.
2. Insert two new "AAA" size batteries for the remote control. When replacing old batteries, push them towards the springs and lift them out.
3. Match the batteries to the (+) and (-) marks in the battery compartment.
4. Replace the cover.

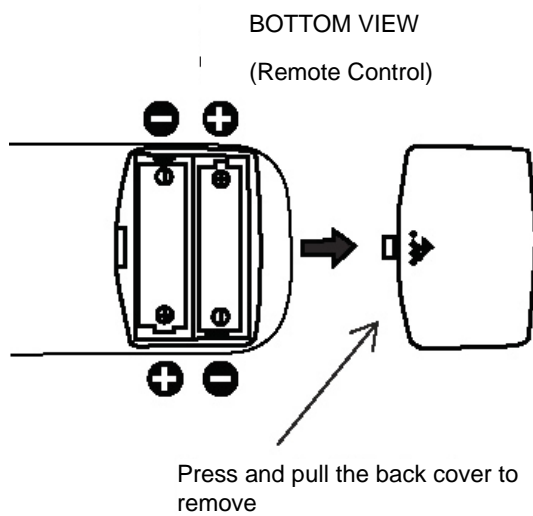

#### Handling the Remote Control

Use the remote control within about 5 m from front of the unit's remote control sensor and within 30 degrees on both sides.

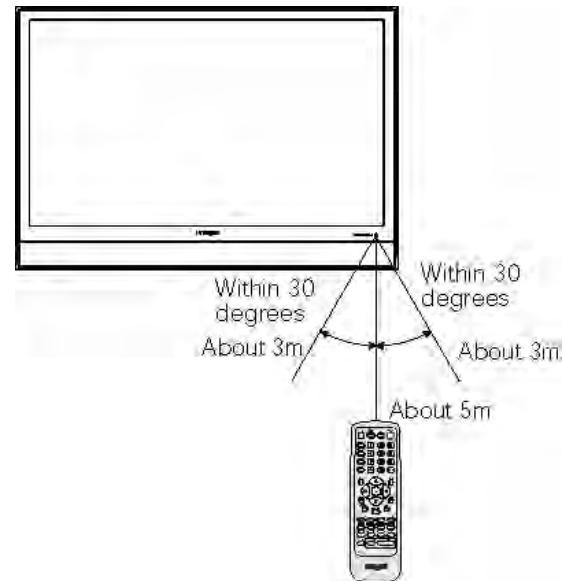

#### CAUTION

- Do not use new and old batteries together. The batteries could explode or leak, resulting in fires, physical injury, or stains.
- When loading batteries, observe their correct polarities as marked on the product. If loaded in the wrong direction, the batteries could explode or leak, resulting in fires, physical injury, or stains.

#### ATTENTION

- Do not drop or impact the remote control.
- Do not splash the remote control with water or put it on a wet object to avoid possible failures.
- Before leaving the remote control out of use for an extended period of time, remove the batteries from it.
- If the remote control begins to lack responsiveness, replace the batteries.
- Strong light such as direct sunlight impinging on the photoreceptor of the remote control can cause operational failure. Position this unit to avoid direct contact with such light.

## COMPONENT NAMES (continued)

### Remote control (continued)

#### Function Buttons

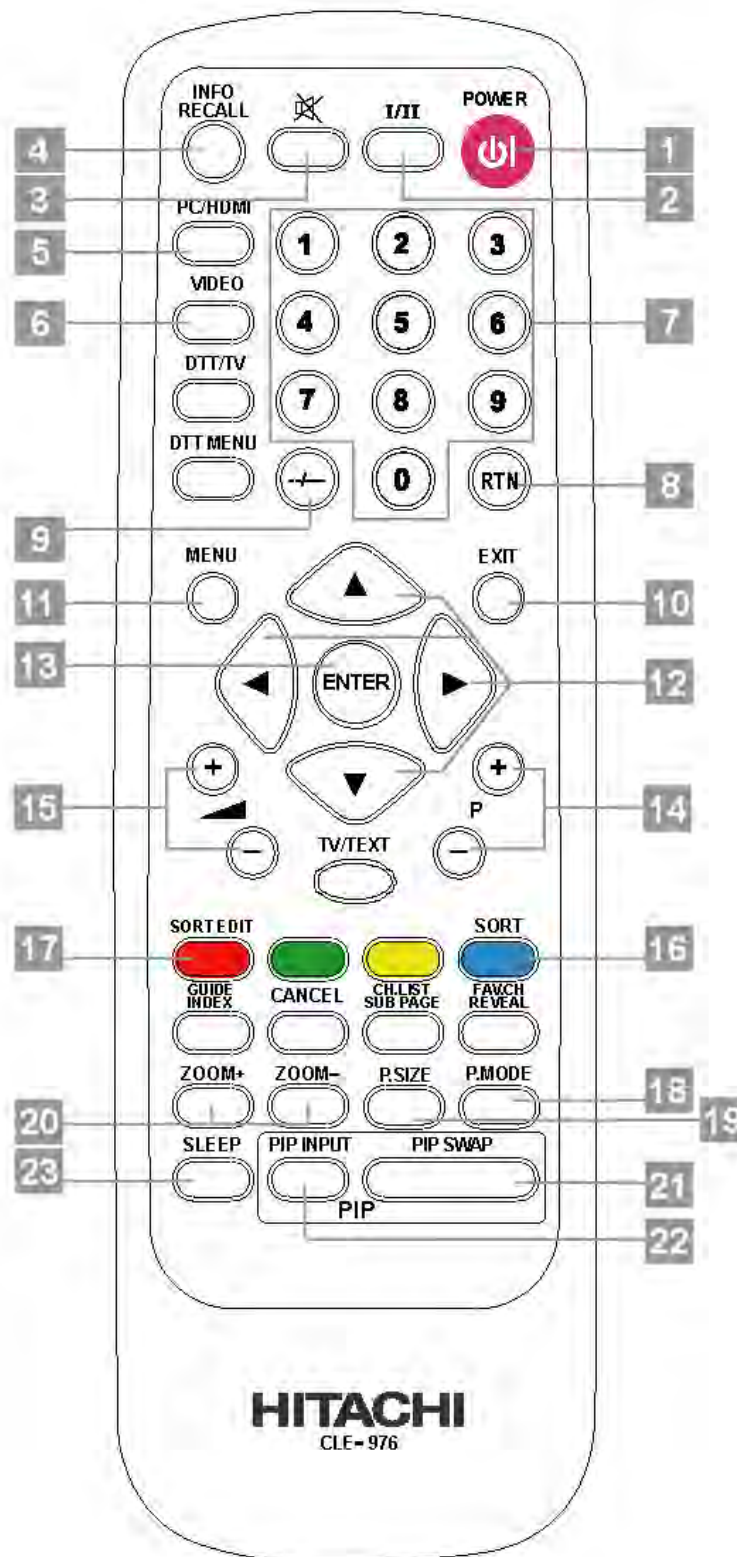

**NOTE**

ZOOM+ & ZOOM- buttons :  
This function not support.

**1. POWER button**

Press this button to turn the TV set on or standby.







**2. I/II button**

Press to select sound mode: Mono Stereo , Language A [ I ] , Language B [ II ] .



## COMPONENT NAMES (continued)

### Remote control (continued)

3.  (MUTE) button  
Press to mute the volume. Press again to restore the volume.
4. **RECALL button**  
Press to display source input signal on the display. When the PIP function is working, press to display audio source. Then press  buttons to select between the sound of your main picture or PIP.
5. **PC/HDMI button**  
Press to switch directly to PC and HDMI mode. Press repeatedly to circle through the selections.
6. **VIDEO button**  
Shortcut to access the Composite Video, S-Video, and Component mode. Press repeatedly to circle through the selections.
7. **NUMBER buttons**  
Use Number buttons with  button to choose specific channel.
8. **RTN (RETURN) button**  
Press this button to toggle between the current and last channel viewed and press jump back to last page of OSD.
9.  button  
Press this button to choose specific number channel for three code upper channel.
10. **EXIT button**  
This button will exit all On-Screen Displays.
11. **MENU button**  
The MENU button will start the OSD.
12.   buttons  
Press Up/Down/Left/Right buttons to adjust the options under OSD menu.
13. **ENTER button**  
Press ENTER button to select the functions under OSD menu.
14. **CHANNEL POSITION+/- buttons**  
Press Channel +/ Channel - buttons to change channels under TV mode.
15. **VOLUME+/- buttons**  
Press Vol+ / Vol- buttons to increase and decrease the volume.
16. **SORT button**  
Press to access the TV channel list table.
17. **SORT EDIT button**  
Press SORT EDIT button to enter function menu for editing, channel name, Insert, and delete the channel from list table.
18. **P. MODE button**  
Press to select Natural, Cinema and Dynamic picture mode. Press repeatedly to circle through the selections.

## COMPONENT NAMES (continued)

### Remote control (continued)

#### 19. P. SIZE button

Press repeatedly to change image to different size. Sizes include Full, 4:3 Standard, Panoramic, 4:3 Zoom and 16:9 zoom.

4:3 Standard	Use this side mode to display conventional (4:3) images. Side panels (gray areas) are placed to the left and right of the image to preserve the original aspect ratio of the source. Note: Use this mode for only 15% of your total viewing time to prevent uneven aging of the phosphors. Phosphors in the lighted area of the picture will age more rapidly than the gray areas.
16:9 Zoom	Use this side mode to display conventional (4:3) sources by linearly increasing image expansion from the center towards the edges of the display area in order to fill it.
4:3 Zoom	Use these side modes to zoom in on conventional (4:3) sources.
Full	Use this side mode to display 16:9 sources like HDTV and DVD's preserving the original 16:9 side ratio.
Panoramic	Use this side to Zoom-in once while in 16:9 side.

Depending on the input signal format received, the picture format ratio allows you to adjust the images through the following options.

#### (1) TV/Composite/S-Video/Component(480i/480p/576i/576p) Input

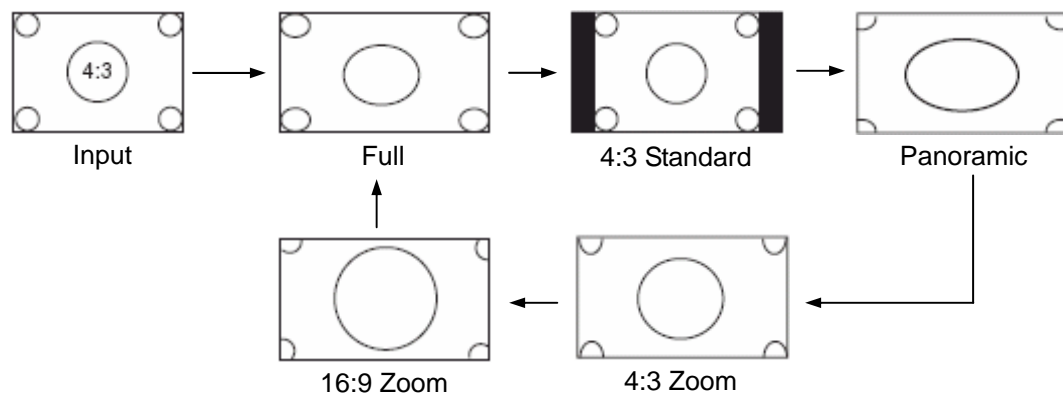

#### (2) Component(720p/1080i)/HDMI Input

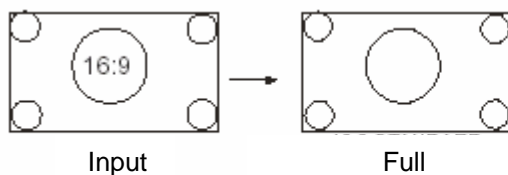

#### (3) RGB Input

Auto adjust to full size. (Aspect ratio is not changeable.)

#### ATTENTION

Using a wide picture size.

- This TV has a picture size selection feature. If an incompatible size is selected to play certain software, such as a TV program, the image would appear different from original. Take this into consideration when making picture size choices.
- Use of this TV in its enlarged display mode with the wide feature enabled in coffee shops and other establishments for commercial or public viewing purposes could infringe on the copyright holders right protected by Copyright Law.
- When a normal 4:3 image is displayed over the entire picture in the Panoramic mode, parts of the periphery of the image may disappear and appear distorted in some cases. Use the 4:3 mode to view image, which were created in 4:3 mode.

#### 20. ZOOM +/- buttons

This function not support.

#### 21. PIP SWAP button

Press to exchange the main video signal source with PIP video signal source.

## COMPONENT NAMES (continued)

### Remote control (continued)

#### 22. PIP INPUT button

Activate PIP by pressing PIP Input button to select desired video input. To turn off PIP by keep pressing PIP Input button until the PIP window disappear. PIP source cannot be the same with main video source. (Component YC<sub>B</sub>C<sub>R</sub> /YP<sub>B</sub>P<sub>R</sub>, HDMI and PC RGB are not accessible to PIP) / (HDMI 480i / 576i cannot support PIP function.)

Main Sub	TV	HDTV	Composite	S-Video	Component	HDMI	PC RGB
TV		○	○	○	○	○	×
HDTV	○		○	○	○	○	×
Composite	○	○		○	○	○	×
S-Video	○	○	○		○	○	×
Component	×	×	×	×		×	×
HDMI	×	×	×	×	×		×
PC RGB	×	×	×	×	×	×	

#### NOTE

For changing TV channel under PIP function, Press directly channel+/-, number and return buttons on remote control to change the channel.

#### 23. SLEEP button

Press the sleep button repeatedly to set the sleep timer to 30, 60, 90, and 120 minutes

## COMPONENT NAMES (continued)

### Remote control (continued)

#### Teletext Function Buttons

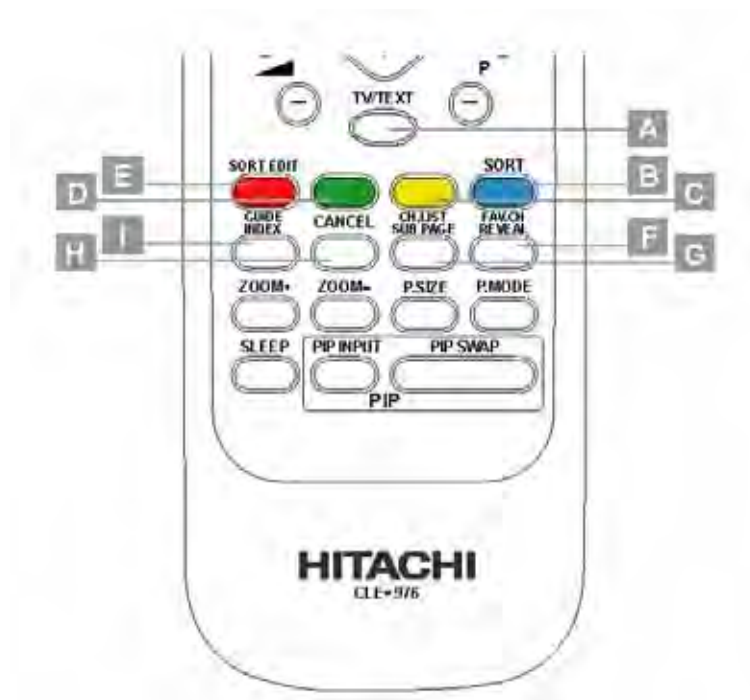

#### A. TV/TEXT button

Press to switches between the TV mode and the Teletext mode.

#### B. BLUE button

Press to operate the Teletext function in Teletext pattern. (Function depends on the Teletext pattern.)

#### C. YELLOW button

Press to operate the Teletext function in Teletext pattern. (Function depends on the Teletext pattern.)

#### D. GREEN button

Press to operate the Teletext function in Teletext pattern. (Function depends on the Teletext pattern.)

#### E. RED button

Press to operate the Teletext function in Teletext pattern. (Function depends on the Teletext pattern.)

#### F. REVEAL button

Press this allows hidden information (found on some Teletext pages) to be displayed on the screen.

#### G. SUB PAGE button

Use this to activate sub page mode directly in Teletext service.

#### H. CANCEL button

This allows the screen to return to the TV mode temporarily while searching for a required text page. When the required text page has been received, the page number will be displayed at the top left of the screen. Press the CANCEL button again to display the Teletext screen.

#### I. INDEX button

Press this button to select the index page that displays the list of Teletext contents.

#### NOTE

- Certain pages do not show linked pages at the bottom of the screen. To display linked pages, press the INDEX button.
- Refer to Teletext Language shown on  34 .

## COMPONENT NAMES (continued)

### Remote control (continued)

#### HDTV Function Buttons

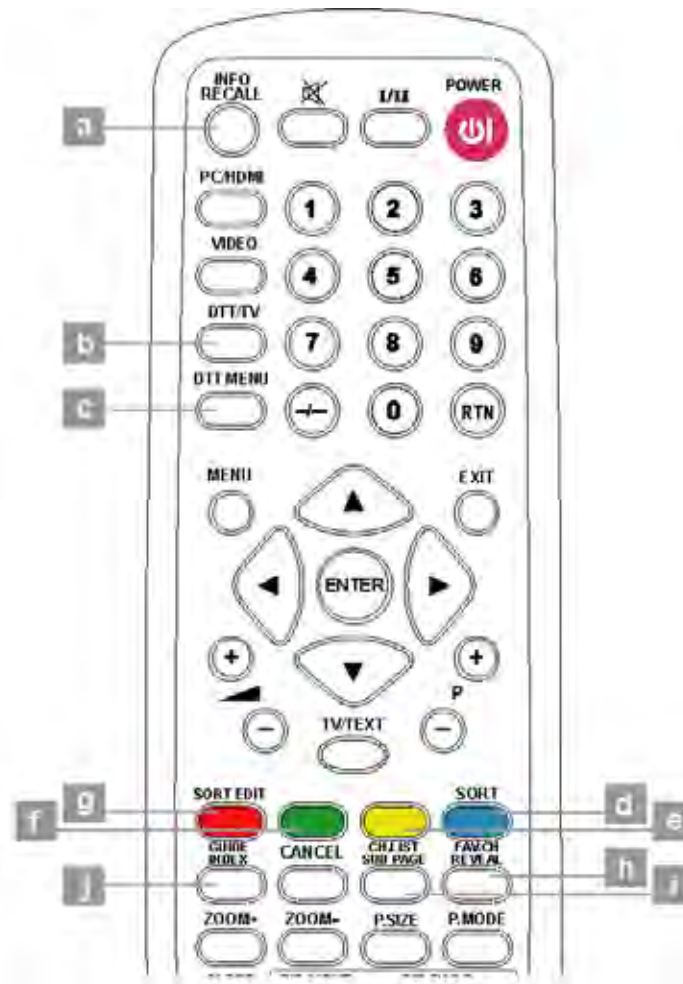

**a. INFO button**

Switch between Viewing mode, Channel Banner, and Channel Banner with Extended Info.

**b. DTT/TV button**

Press to switches between HDTV mode and TV mode.

**c. DTT MENU button**

Press to access HDTV OSD menu for features adjustment.

**d. BLUE button**

Press to operate the HDTV function in HDTV OSD. (Function depends on the HDTV OSD.)

**e. YELLOW button**

Press to operate the HDTV function in HDTV OSD. (Function depends on the HDTV OSD.)

**f. GREEN button**

Press to operate the HDTV function in HDTV OSD. (Function depends on the HDTV OSD.)

**g. RED button**

Press to operate the HDTV function in HDTV OSD. (Function depends on the HDTV OSD.)

**h. FAV CHANNEL button**

Press to switch directly to your favorite channel.

## COMPONENT NAMES (continued)

### Remote control (continued)

**i. CANCEL LIST button**

Use this to switch directly to your HDTV channel list.

**j. GUIDE button**

Use this to switch directly to HDTV guide.

## INSTALLATION INSTRUCTIONS

### Installation

- If you have purchased the model without the stand attached:  
When installing the monitor, use the optional stand CMPAD42T.  
The desktop stand has been used for the installation in this manual.

#### WARNING

- Use one of the special mount units to install this product. A mount of insufficient strength or inadequate design can cause overturning or dropping and result in fire, electrical shock or injury. Please note that our company assumes absolutely no responsibility for personal injuries or property damage caused by use of other mount units or improper installation.
- Have this unit mounted in a stable place. Take measures to prevent it from tumbling down to avoid possible.

#### CAUTION

- In order to prevent an internal temperature increase, maintain a space of 10cm (4 inches) or more between the sides and other objects such as walls, etc., so that the ventilation holes are not blocked. (\*)
- Using a commercially available cord, chain and clamp, secure the set to a firm wall or pillar.

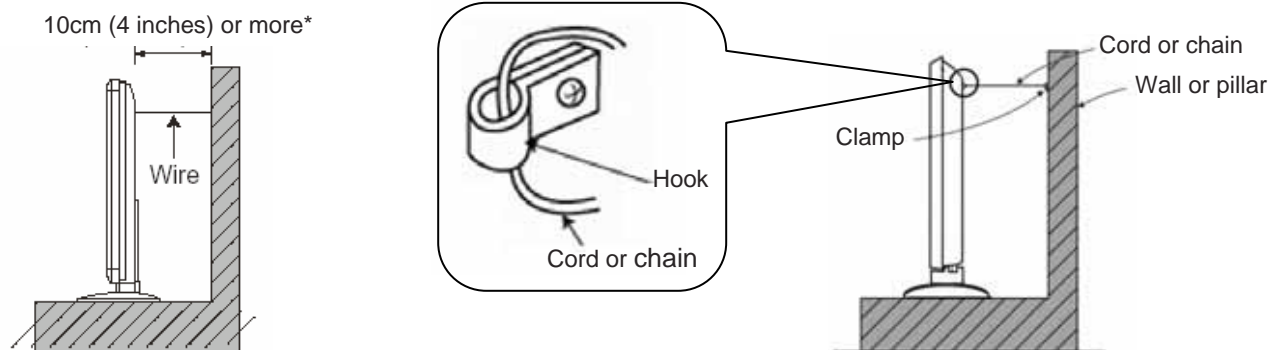

#### PRECAUTIONS

Please avoid installing the TV directly on the wooden floor. Depending on the quality and condition of the floor, the desktop stand may stick to the floor face, and the surface could come off when the TV is lifted up.

Read **SAFETY INSTRUCTIONS** (  5 to  8 ) carefully to ensure maximum safety before proceeding to these steps:

- Choose an appropriate site and install the product on a level table where the stand is secure.
  - Install the PDP TV to have ready access to a power socket available.
- Make sure that the power switch of this device is turned off.

## INSTALLATION INSTRUCTIONS (continued)

### Connecting to an Audio Visual Device

- (1) Make sure that the signal of the audio visual device to be used is compatible with the specifications of this device. See “PRODUCT SPECIFICATIONS” concerning the specifications of this device. 49~ 51
- (2) Make sure that the power switch of the PDP TV is turned off.
- (3) Make sure that the power switch of the audio visual device is turned off.
- (4) Use a commercially available cable and connector to connect the signal input terminal on the rear panel of this device and the signal output terminal of the audio visual device.

#### CONNECTING AN DIGITAL TV ANTENNA

1. Attach a DVB-T antenna cable to the DVB-T terminal.
2. Connect the outdoor antenna cable lead-in to the terminal marked DVB-T IN on the rear of the TV set.
3. Connect all power sources before activating the PDP TV.
4. Turn on the PDP TV.
5. Press DTT/TV on the remote to choose HDTV mode.
6. When operating the HDTV at first time, please execute “Installation” menu 39 for normally display.

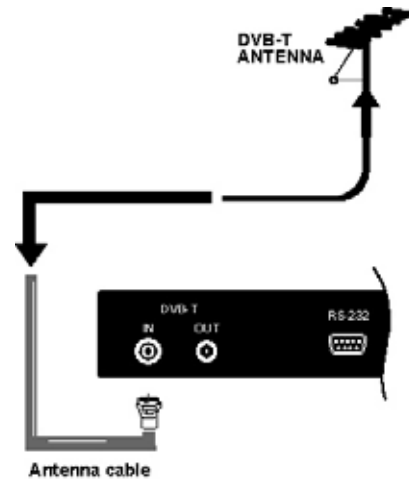

#### CONNECTING AN ANALOG TV CABLE OR AN ANALOG ANTENNA WITHOUT A TV CABLE BOX

1. Use an antenna cable connects to an outdoor antenna.
2. Connect all power sources before activating the PDP TV.
3. Turn on the PDP TV.
4. To use the TV, press DTT/TV button on the remote to choose TV mode.
5. When operating the TV at first time, its TV system is at “default factory mode” and this mode cannot display the image normally on the screen. In order to watch the TV program without problem, please execute “TV Channel Setup” menu 33 for normally display.

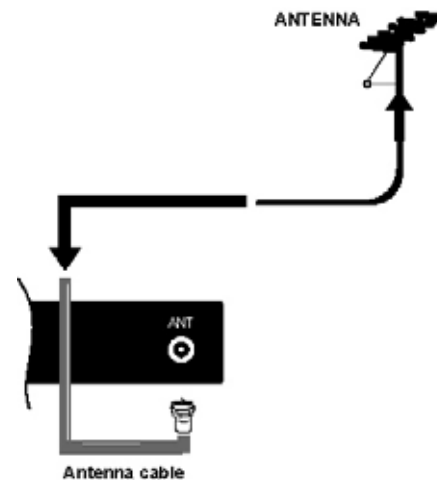

#### Precautions when connecting the antenna

- Please use a coaxial cable which is free from interference to connect the antenna.
- Avoid using a parallel flat feeder wire as interference may occur, causing reception to be unstable and stripe noise to appear on the screen.
- Avoid using indoor antenna as this may be affected by interference. Please use CATV net or outdoor antenna.
- Keep the power cord as far away from the antenna wire as possible.
- For safety, install an external antenna conforming to AS1417.1 (applicable for Australia only)

If there are noise appearance in the picture of VHF-Low band channel, please use the double-shielded cable (not provided) for RF LEADS to reduce the noise



## INSTALLATION INSTRUCTIONS (continued)

### Connecting to an Audio Visual Device (continued)

#### CONNECTING HDTV SOURCES

HDTV input sources, such as a digital cable box, digital satellite receiver, or digital terrestrial receiver box, can be connected as desired, using the appropriate cable system.

1. Connect the HDTV source device using the appropriate cable pair, in the following order of preference:  
HDMI cable or Component cable and audio cable
2. Connect all power sources before activating the PDP TV.
3. Turn on the PDP TV.
4. Press the button corresponding to the appropriate signal source (HDMI, or Component Video-YC<sub>B</sub>C<sub>R</sub>/YP<sub>B</sub>P<sub>R</sub>)

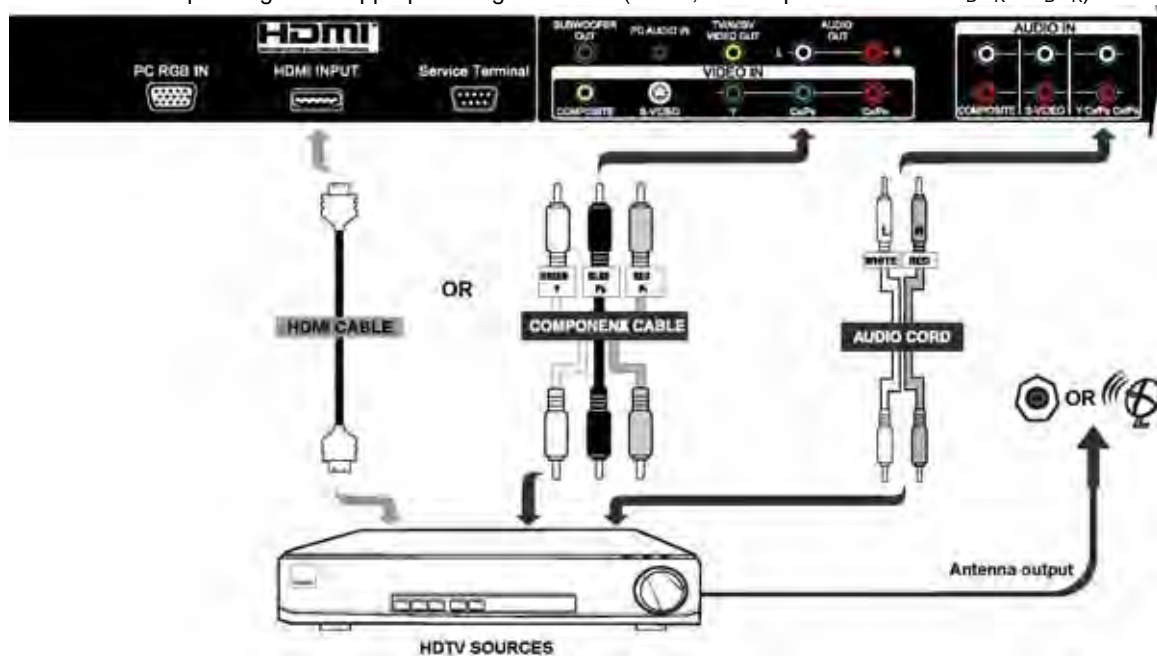

#### CONNECTING A TV CABLE BOX OR SATELLITE RECEIVER

1. Connect the TV Cable Box or Satellite Receiver device using:  
Component cable and Audio cable or S-Video cable and Audio cable or Composite cable and Audio cable.
2. Connect all power sources before activating the PDP TV.
3. Turn on the PDP TV.
4. Press the button corresponding to the appropriate signal source (Component Video, YC<sub>B</sub>C<sub>R</sub>/YP<sub>B</sub>P<sub>R</sub>, S-Video or Composite Video)

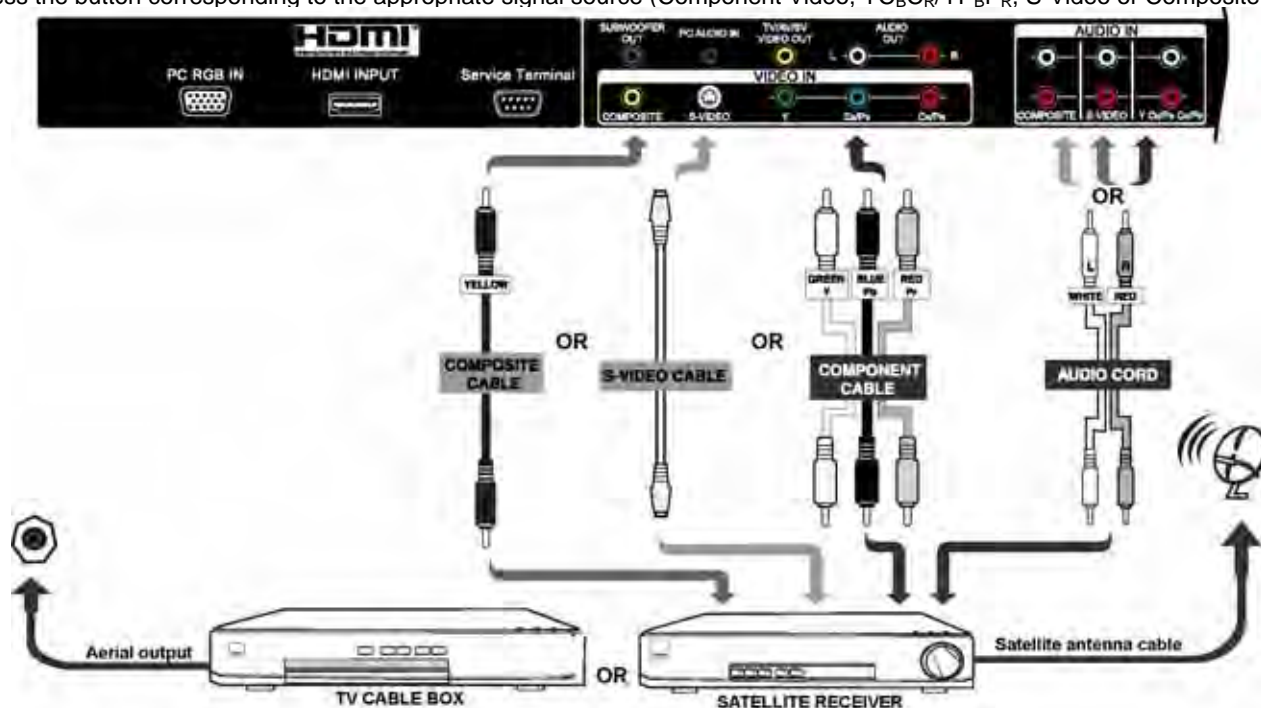

## INSTALLATION INSTRUCTIONS (continued)

### Connecting to an Audio Visual Device (continued)

#### CONNECTING A DVD PLAYER

1. Connect the DVD player using:  
HDMI cable or Component cable and Audio cable or S-Video cable and Audio cable or Composite cable and Audio cable.
2. Connect all power sources before activating the PDP TV.
3. Turn on the PDP TV.
4. Press the button corresponding to the appropriate signal source (HDMI, Component Video, YC<sub>B</sub>C<sub>R</sub>/YP<sub>B</sub>P<sub>R</sub>, S-Video or Composite Video)

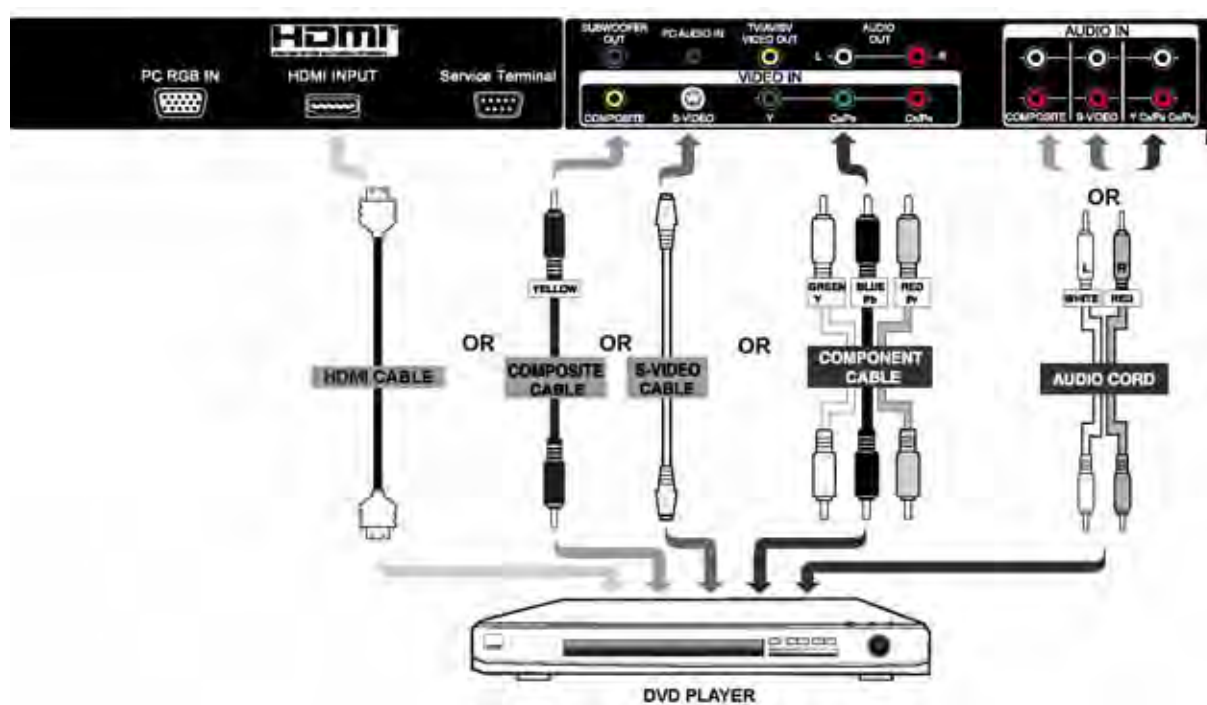

#### CONNECTING A AUDIO RECEIVER

- For improved sound quality, you may want to play the audio of the PDP through your stereo system.
1. Use an audio cable and Subwoofer cable to connect the PDP's audio output jacks to the line input jacks on the A/V receiver.
  2. Connect all power sources before activating the PDP TV.
  3. Turn on the PDP TV.
  4. Press the MENU to display the menu, then press ▲ ▼ to select Audio.
  5. Press Enter, then press ▲ ▼ to select subwoofer and press ◀ ▶ to select On/Off.

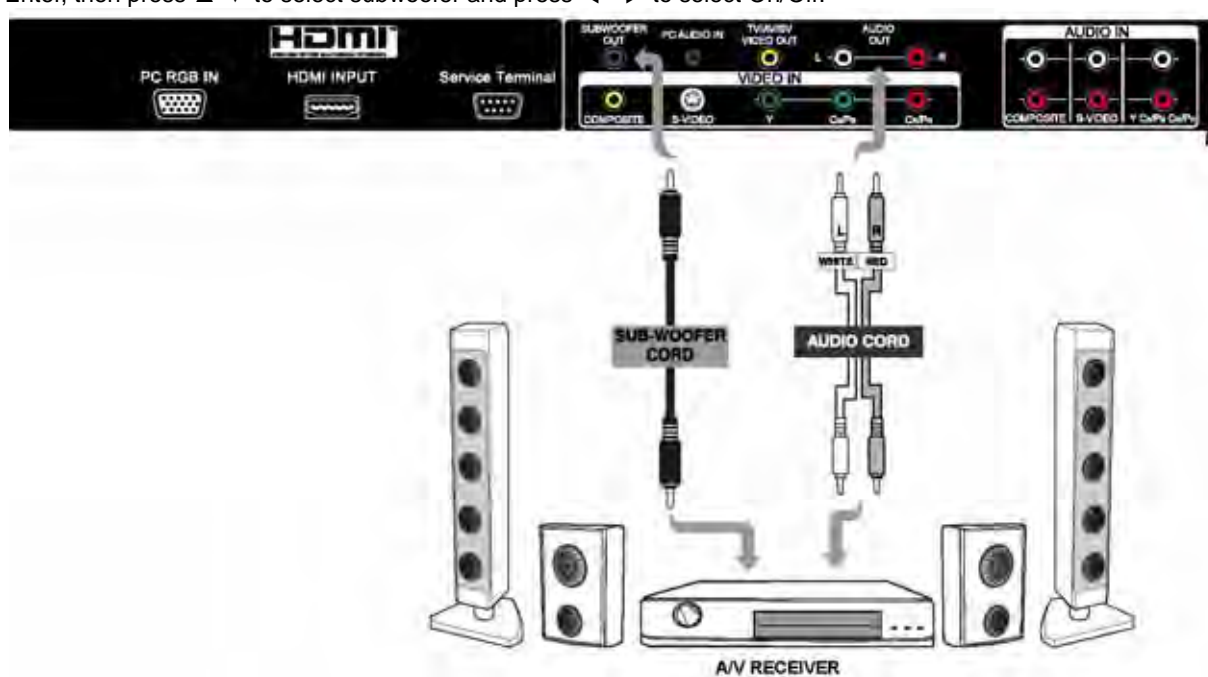

## INSTALLATION INSTRUCTIONS (continued)

### Connecting to an Audio Visual Device (continued)

**NOTES:**

- If the Video OUTPUT (Monitor) terminal is connected to an external monitor with a 75 Ohm terminal, it is possible to view the same image as on the main unit. But it is possible to monitor only the TV signal, Composite Video signal or the S-Video signal that is displayed on the screen at the time.
- If a Video equipment with an S-Video output terminal is used, cabling by the S-Video cable is recommended to provide finer Video quality.

### **HDMI**

- HDMI, the HDMI logo and High-Definition Multimedia Interface are trademarks or registered trademarks of HDMI Licensing LLC.
- HDMI (High-Definition Multimedia Interface) is a digital interface based on DVI (Digital Visual Interface), which is an added function for audio visual equipment.
  - It does not have degradation by transmission since it is digital.
  - With only one cable, it is possible to transmit both picture signals and audio signals.
- In case of using analog audio, when connecting with DVI-HDMI transformation connector, use analog RGB audio terminal for input.

## INSTALLATION INSTRUCTIONS (continued)

### Connecting to a PC

- (1) Make sure that the display signal of the personal computer to be used is compatible with the specifications of this device. See "PRODUCT SPECIFICATIONS" concerning the specifications of this device 49 ~ 51 .
- (2) Make sure that the power switch of the personal computer is turned off.
- (3) Connect the signal input terminal (PC RGB INPUT) on the rear panel of this device to the display signal output terminal of the personal computer.
  - Use a cable that fits the input terminal of this device and the output terminal of the personal computer.
  - Depending on the type of personal computer being connected, the use of an optional conversion adapter or the adapter provided with the personal computer may be necessary in some cases. For details, refer to the instruction manual of the personal computer or ask the personal computer manufacturer or your local retail dealer.

#### CONNECTING PC

1. Connect the PC using:
  - D-Sub cable and  $\varnothing$  3.5 mm Audio cable
2. Connect all power sources before activating the PDP TV.
3. Turn on the PDP TV.
4. Press the button corresponding to the appropriate signal source (PC RGB)

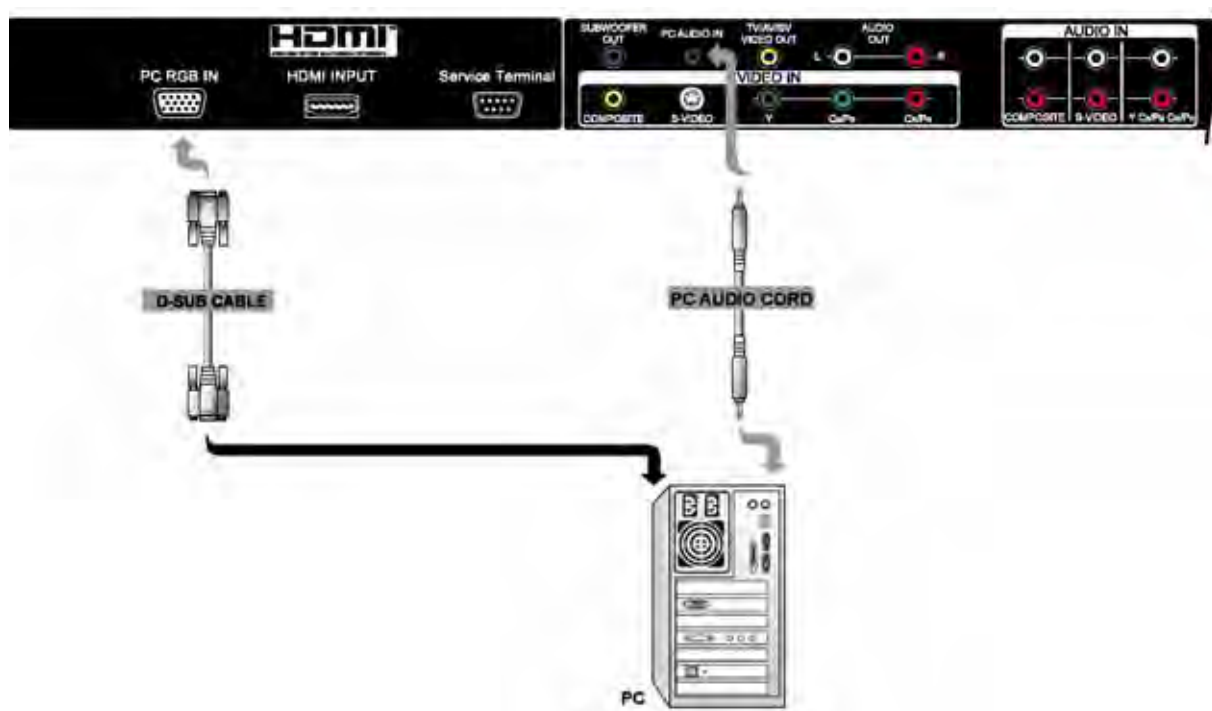

#### NOTE

- This PDP TV can automatically detect and display the signal format. Please refer to "Recommended Signal List" on

51

## INSTALLATION INSTRUCTIONS (continued)

### Power Cord Connection

Connect the power cord, after completing all other device connections.

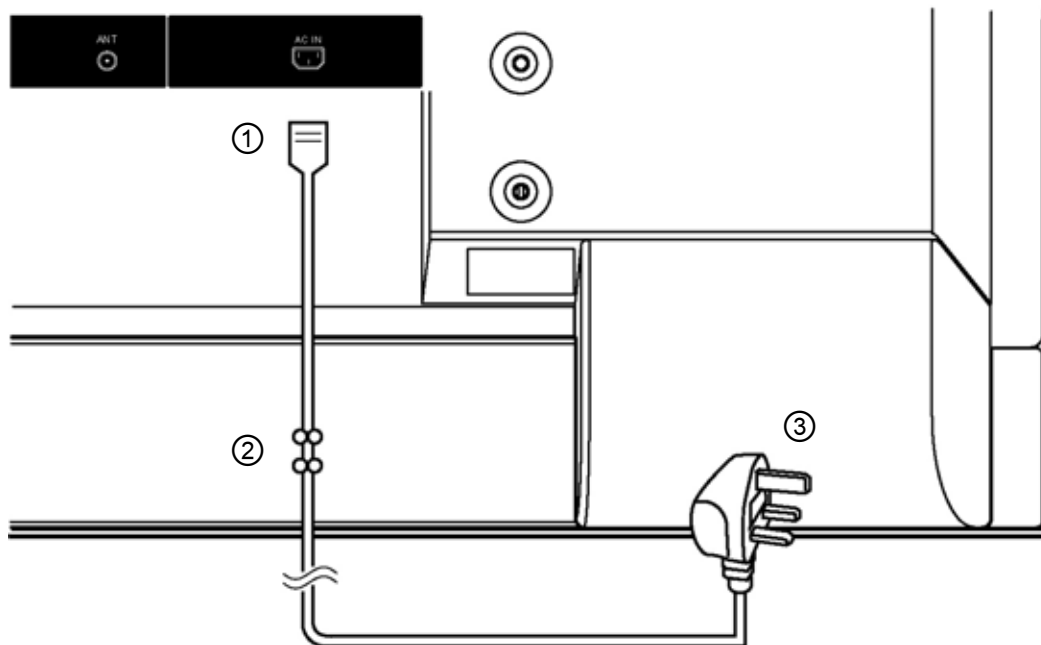

- ① Connect the power cord to this device.
  - ② Use the binders to fix the power cord.
  - ③ Connect the power cord plug to the power outlet.
- (The type of plug is different from this drawing for some countries.)

#### CAUTION

- Use only the power cord provided. (Ask your local retail dealer about the power cord for TV monitor)
- Do not use a power supply voltage other than that indicated (AC100-240V, 50/60Hz) as this may cause fire or electric shock.

#### WARNING

##### **Be cautious of the power cord connection.**

Incorrect connection of the power cord could result in fire or electrical shock.

- Do not touch the power cord with a wet hand.
- Check that the connecting portion of the power cord is clean (with no dust), before using. Use a soft and dry cloth to clean the power plug.
- Insert the power plug into a power outlet firmly. Avoid using a loose, unsound outlet or contact failure.
- Do not cut off the fitted power plug, the removal of which could lead to impaired performance. If you wish to extend the lead, obtain an appropriate extension lead or consult your dealer.
- Should you require replacing the fuse in the molded plug with a new fuse, then please replace with new one of the same value, type and approval as the original. Ensure the fuse cover is returned to its origin position.

## OPERATING INSTRUCTIONS

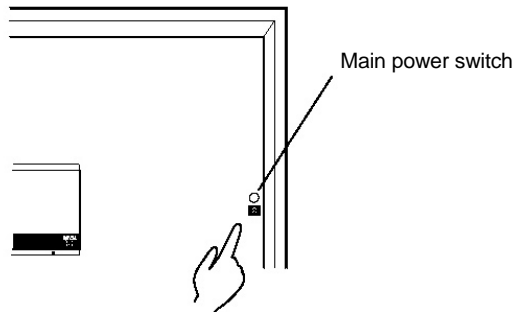
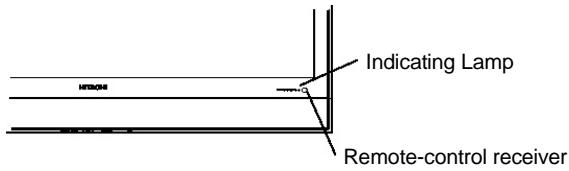

- The main power switch is located at the back, on the right side.

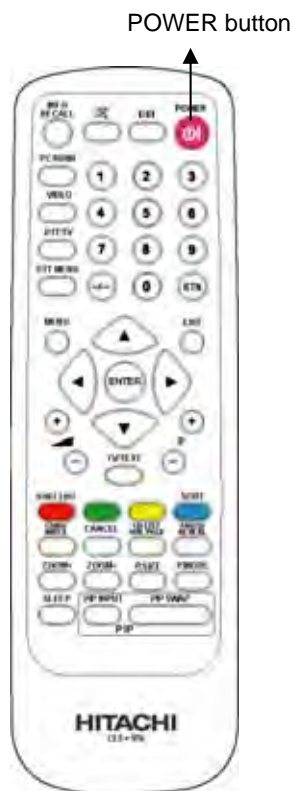
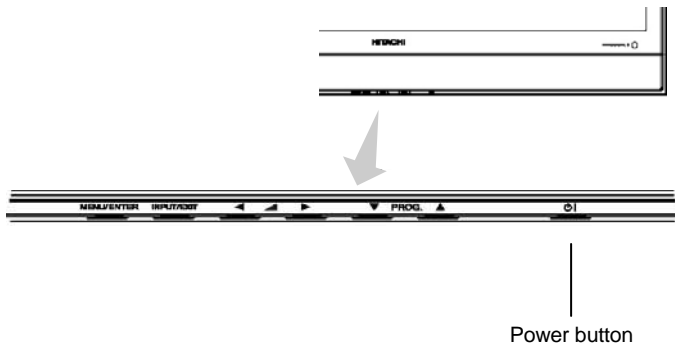

## Turning Power On and Off

- To turn the PDP TV power ON, press the main power switch on the PDP TV main unit to ON, and then press the POWER button of control panel or the POWER button on the remote control.
- To turn the TV power OFF, press the POWER button of control panel or the POWER button on the remote control, and then press the main power switch on the PDP TV main unit to OFF.
- During normal use, the main power switch is set in the ON position, and the monitor can then be turned ON/OFF using the POWER button or the POWER button on the remote control.

### Indicating lamp

Indicating Lamp	Power Status	Operating
Off	Off	When the main power switch is set to OFF.
Lights Red	Off (Stand-by)	When the main power switch is ON, and the POWER button is OFF.
Lights Orange	Off (Power Save)	When the main power switch is ON, and the power button is ON.
Lights Green	On	When the main power switch is ON, and the power button is ON.

When the indicating lamp lights in orange or the message "CABLE NO INSERT" or "Blue picture" appears on the screen, there is something unusual about the status of reception. See "Power Save Mode" or "Symptoms That Seemingly Appear to be Failures."

45 ~ 47

### ATTENTION

- Avoid repeatedly turning the PDP TV on and off at short time intervals. Failures might result from such operation.
- Turn off the main power switch before leaving the PDP TV out of use for an extended period of time.
- If a power failure occurs while the main unit is running, it would be powered on upon recovery from the failure. Turn off the unit main power switch before leaving the main unit.

## OPERATING INSTRUCTIONS (continued)

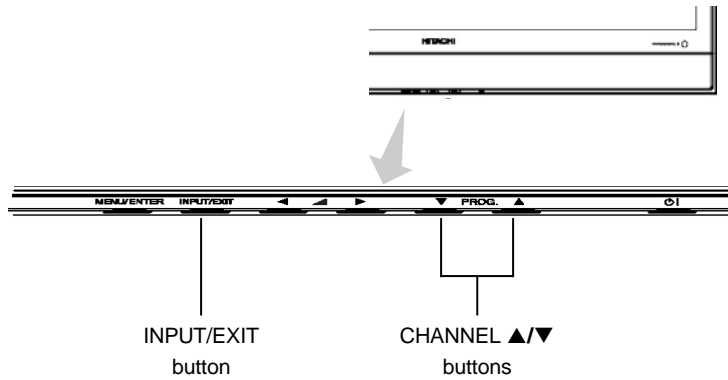

### Input Switching

- Input can be switched in the sequence of TV → HDTV → PC → HDMI → Composite-Video → S-Video → Component by pressing the INPUT button of the control panel.

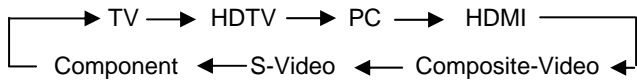

- Input can be switched to TV by pressing PROGRAM +/- buttons or NUMBER buttons of the remote control.
- Input can be switched by pressing the PC/HDMI, VIDEO or DTT/TV buttons of the remote control.

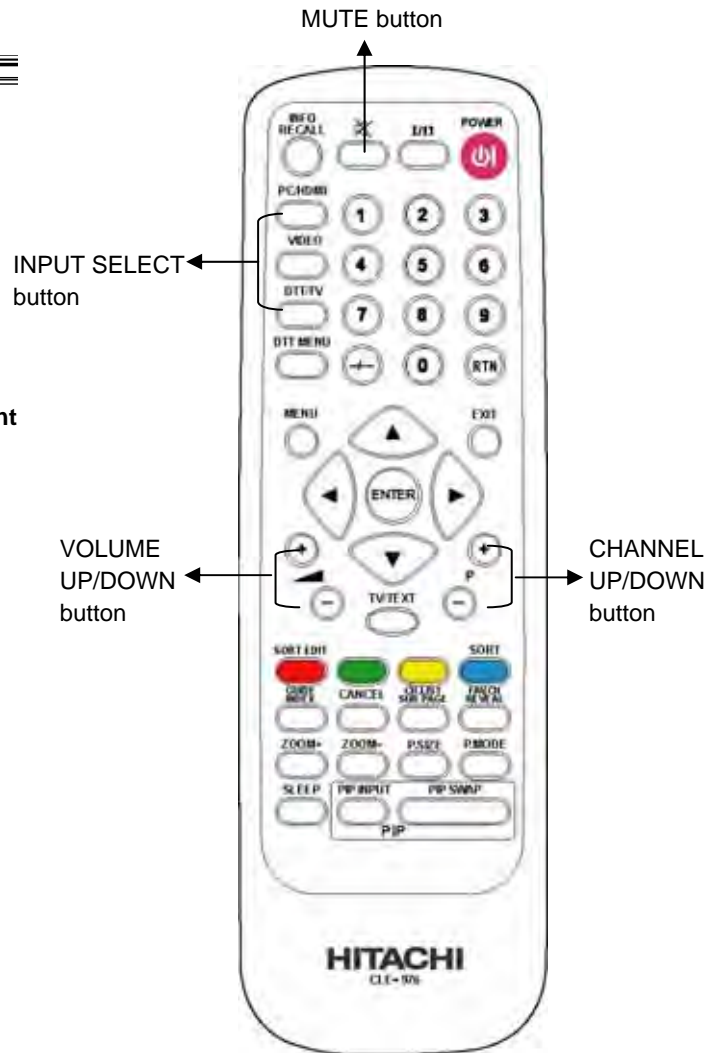

### Volume Adjustment

- The volume can be adjusted by pressing the VOLUME ◀ / ▶ of the control panel or Vol+ and Vol- buttons of the remote control.
- When a button is pressed, the volume adjustment status guide will be displayed.
  - The volume will increase when the volume ▶ or Vol+ buttons are pressed while the guide is being displayed.
  - The volume will decrease when the volume ◀ or Vol- buttons are pressed while the guide is being displayed.

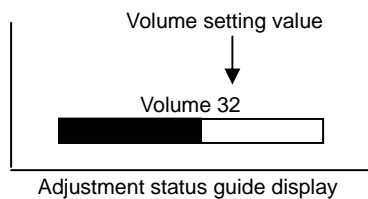

### Audio Mute

- The audio volume can be temporarily muted by pressing the MUTE button of the remote control.
  - The muting can be cancelled by pressing the volume ◀ / ▶, Vol+/- buttons or MUTE button while the audio is mute.

## OPERATING INSTRUCTIONS (continued)

### Input Signal Screen Display

The input signal status can be displayed on the screen by pressing the **RECALL** button of the remote control.

- The display will go out in approximately 3 seconds.

TV

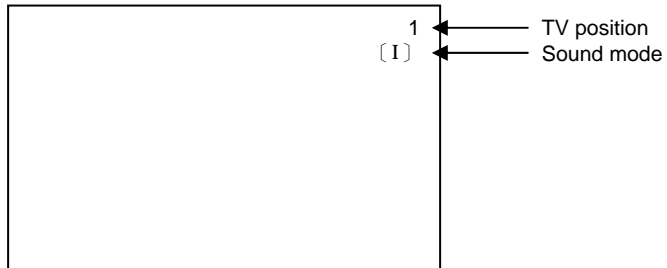

VIDEO/PC RGB

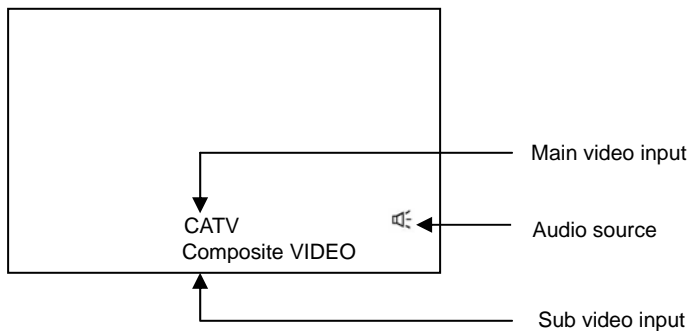
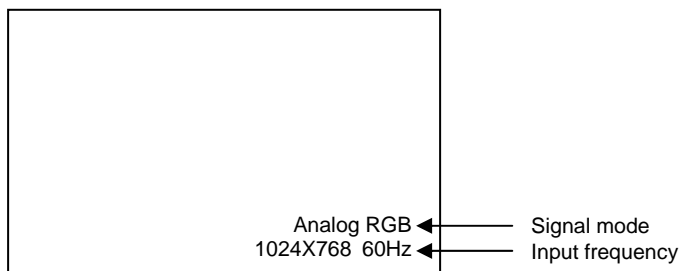

RECALL button

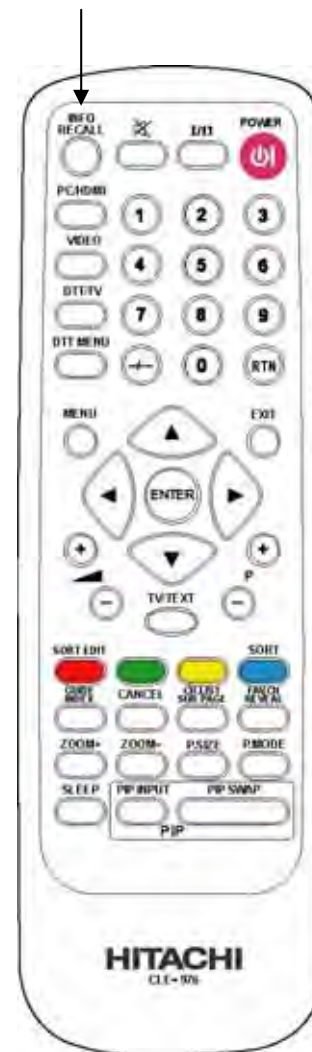

- Activate PIP by pressing PIP Input button to select desired video input.
- Press  on the remote control to select audio source of video input.
- Picture Mode, Brightness, Contrast, Color, Tint, and Sharpness can be adjusted by Audio source to settle on.



## OPERATING INSTRUCTIONS (continued)

### Using the Menu Screen (On-screen display system)

#### Control panel :

1. Press MENU of the control panel to display the OSD on your Plasma TV.
2. Use the PROGRAM to navigate to different menu item.
3. Use the VOLUME ◀▶ to adjust functions.
4. Press ENTER of the control panel to select functions.
5. Press EXIT of the control panel to quickly exit from the menu.

#### Remote control :

1. Press MENU on the remote control to display the OSD on your Plasma TV.
2. Use the to navigate to different menu item.
3. Use the ◀▶ to adjust functions.
4. Press ENTER on the remote control to select functions.
5. Press RTN on the remote control to go to the last page; press EXIT to quickly exit from the menu.

#### THERE ARE TWO DIFFERENT MODES FOR THE OSD AS BELOW:

**TV/Video Mode:** Displays when the TV, HDTV, Composite, S-video, Component or HDMI is selected.

**PC Mode:** Displays when the Analog RGB input is selected.

#### TV/Video Mode

Video	Picture Mode
	Brightness
	Contrast
	Color
	Tint
	Sharpness
	Color Temperature
	Reset
Image	P. Size
	Set Border Color
	Noise Reduction
	3:2 Pull Down
	Reset
Audio	Mute
	Volume
	Balance
	Treble
	Bass
	Subwoofer
	SRS WOW
	Reset
Language	English
	繁體中文
	简体中文
	日本語
	Русский
System	Signal Format
	Advance
	PIP Set
	TV Channel Setup (TV mode only)
	Screen Wipe

#### PC Mode

Video	Brightness
	Contrast
	H Position
	V Position
	Color Temperature
	Reset
Image	Clock Phase
	Horizontal Clock
	Auto Adjust
Audio	Mute
	Volume
	Balance
	Treble
	Bass
	Subwoofer
	SRS WOW
	Reset





## OPERATING INSTRUCTIONS (continued)

### Video Menu

#### TV/Video Mode

Selected characters	◀	▶	Setup hint
Picture Mode	Natural ↔ Cinema ↔ Dynamic 		Natural: This setting is for normal lighting conditions. Cinema: This setting is best for watching movie. Dynamic: This setting is best for very bright ambient lighting.
Brightness	Black is subdued for increased overall darkness.	Black is set off for increased overall brightness.	Adjust to preference. (Not available in Teletext mode)
Contrast	Narrows the gap between brightness and darkness.	Broadens the gap between brightness and darkness.	Adjust for maximum visibility to suit the ambient brightness.
Color	Decrease color intensity.	Increase color intensity.	Adjust to preference. (Not available in Teletext mode)
Tint	Enhances red and weakens green.	Enhances green and weakens red.	This is not available to adjust when receiving SECAM signal. Then the character will be grayed out. Adjust for most realistic skin color.
Sharpness	Soft	Sharp	Shift to the minus (-) side for a softer effect and plus (+) for sharper picture.
Color Temperature			Normally set to Cool.
Reset	(off the function)	-	The original factory settings for the items of this Menu page can be restored by pressing the ENTER button.

#### PC Mode

Selected characters	◀	▶	Setup hint
Brightness	Black is subdued for increased overall darkness.	Black is set off for increased overall brightness.	Adjust to preference.
Contrast	Narrows the gap between brightness and darkness.	Broadens the gap between brightness and darkness.	Adjust for maximum visibility to suit the ambient brightness.
H Position	Moves the horizontal position to left 	Moves the horizontal position to right 	Adjust the left-side display position.
V Position	Moves down the vertical position. 	Moves up the vertical position. 	Adjust for maximum character clarity.
Color Temperature			Normally set to Cool.
Reset	(off the function)	-	The original factory settings for the items of this Menu page can be restored by pressing the ENTER button.

## OPERATING INSTRUCTIONS (continued)

### Image Menu

#### TV/Video Mode

Selected characters	◀	▶	Setup hint
P. Size	<p>Full ↔ 4:3 Standard 16:9 zoom ↔ Panoramic 4:3 Zoom</p> <p>Available for TV/Composite/S-Video/Component(480i/480p/576i/576p) signals.</p>		Adjust to preference. Please refer to  for more detail. (Not available in Teletext mode)
	Full Component(720p/1080i)/HDMI		
Set Border Color	<p>Black ↔ Gray</p>		Adjust to when display 4:3 video. This turns the gray sidebars to the black sidebars when watching normal mode screen size area. It is always set to Off when the monitor powered On. It is recommended to set to Gray to reduce the panel image retention. (Not available in Teletext mode)
Noise Reduction	<p>Off ↔ Level1 ↔ Level2 ↔ Level3</p>		Adjust to when display static image. If this is set from Off to Level3, it helps to reduce the noise interference visible on the static image, especially in the weaker signal reception areas.
3:2 Pull Down	<p>Disable ↔ Enable</p>		Adjust to improve the picture quality.
Reset	(off the function)	-	The original factory settings for the items of this Menu page can be restored by pressing the ENTER button.

#### PC Mode

Selected characters	◀	▶	Setup hint
Clock Phase	Slows the dot clock phase (shifts slightly to left). 	Advances the dot clock phase (shifts slightly to right). 	Adjust for clear character visibility.
Horizontal Clock	Reduces the dot clock frequency (shrinks the right side). 	Increases the dot clock frequency (expands the right side). 	Adjust for maximum character clarity.
Auto Adjust	(off the function)	-	Pressing the ENTER button, automatic regulation is started. Horizontal Position, Vertical Position, Horizontal Clock and Clock Phase are adjusted automatically.

## OPERATING INSTRUCTIONS (continued)

### Audio Menu

Selected characters	◀	▶	Setup hint
Mute	Disable ← → Enable ↑                      ↓		Adjust to turn off the sound.
Volume	Turns down the volume.	Turns up the volume.	This is to set the volume for speaker.
Balance	Suppresses right-side sound.	Suppresses left-side sound.	Adjust to preference.
Treble	Suppresses treble.	Enhances treble.	Adjust to preference. (When SRS WOW select "On", this function is not available)
Bass	Suppresses bass.	Enhances bass.	Adjust to preference. (When SRS WOW select "On", this function is not available)
Subwoofer	On ← → Off ↑                      ↓		Adjust to preference. (When SRS WOW select "On", this function is not available)
SRS WOW	On ← → Off ↑                      ↓		Adjust to preference.
Reset	(off the function)	-	The original factory settings for the items of this Menu page can be restored by pressing the ENTER button.



SRS WOW is an audio enhancement technology from SRS Labs that provides deep, rich bass on any speaker system without the need for a subwoofer or additional extra physical components. For systems with a subwoofer, SRS WOW complements and enhances the bass performance. This feature can be set to On or Off.

**NOTES:** WOW, SRS and the  symbol are trademarks of SRS Labs, Inc. SRS WOW technology is incorporated under license from SRS Labs, Inc.

### Language Menu

#### TV/Video Mode

Selected characters	▲	▼	Setup hint
Language	English ← → 繁體中文 ↑                      ↓ Русский ← → 日本語		Adjust to preference.

## OPERATING INSTRUCTIONS (continued)

### System Menu

#### TV/Video Mode

**NOTES:** When operating the TV at first time, its TV system is at "default factory mode" and this mode cannot display the image normally on the screen. In order to watch the TV program without problem, please execute "TV Channel Setup" menu for normally display..

Selected characters		◀	▶	Setup hint
Signal Format		(off the function)	-	Press the ENTER button to show the information of the current input signal.
Advance		Press ENTER button to select the following functions		
3D Comb		On ↔ Off		Improve the picture quality for TV, Composite-video.
Panel Lock		On ↔ Off		This is for locking out the control panel function. Adjust to prevent children from touching.
Move Screen	Mode	Off ↔ Mode 1 ↔ Mode 2		Adjust to preference. This moves the picture around the screen to reduce the panel image retention. This is where stationary objects, such as screen logos, leave a slight image visible after they should have disappeared.
	Time	0~255 sec		Adjust to preference. This moves the picture around the screen in small amounts, at set intervals, to reduce the panel image retention. This is where stationary objects, such as screen logos, leave a slight image visible after they should have disappeared
Reset		(off the function)	-	The original factory settings for the items of this Menu page can be restored by pressing the ENTER button.
PIP Set		Press ENTER button to select the following functions		
Source		Off ↔ AV ↔ SV ↔ TV ↔ DTT		Adjust to preference.
Size		Small ↔ Medium ↔ Large		Adjust to preference.
Position		9 positions for selection: Upper Left, Upper Center, Upper Right, Middle Left, Middle Center, Middle Right, Lower Left, Lower Center, Lower Right		Adjust to preference.
Audio Source		Main ↔ PIP		Adjust to preference.
PIP Display	Brightness	Black is subdued for increased overall darkness.	Black is set off for increased overall brightness.	Adjust to preference.
	Contrast	Narrows the gap between brightness and darkness.	Broadens the gap between brightness and darkness.	Adjust for maximum visibility to suit the ambient brightness.
	Color	Decrease color intensity.	Increase color intensity.	Adjust to preference.
Swap		(off the function)	-	Press the ENTER button to change main and PIP display.
TV Channel Setup		Press ENTER button to select the following functions <b>(only available under TV mode)</b>		
Channel Auto Search	Mode	Position ↔ Direct		Select the channel entry method between position setting or direct setting. And press the ENTER button in SEARCH function to fix it. Please use auto search when you first use your TV. <ul style="list-style-type: none"> <li>• [Position] search the channel by frequency from 48.25~863.25MHz. We suggest to use these function for the channel setting</li> <li>• [Direct] search the channel by CCIR PAL B/G table. Provide the faster speed than position mode, but some channels which are not in the table may be lost.</li> </ul>
	Search	(off the function)	-	Press the ENTER button and it starts the auto tuning.

## OPERATING INSTRUCTIONS (continued)

### System Menu (continued)

#### TV/Video Mode

Selected characters		◀	▶	Setup hint
Channel Manual Search (Use to add the channel by manual)	Program	Decrease channel number	Increase channel number	Select PROGRAM and press the ◀/▶ buttons to choose the programmed number
	Band	CC ↔ CH		Select BAND and press the ◀/▶ buttons to choose the band type. ( CH-AIR / CC-CATV)
	Channel	Decrease channel number	Increase channel number	Select CHANNEL and press the ◀/▶ buttons to choose the channel number.
	Color System	AUTO ↔ PAL NTSC3.58 ↔ SECAM		Select COLOR SYSTEM and press the ◀/▶ buttons to choose the color system. (AUTO/PAL/SECAM/NTSC3.58)  (NOTE : If you do not have a clear picture or no color appears, change the color system.)
	Sound System	AUTO ↔ M DK ↔ I ↔ BG		Select SOUND SYSTEM and press the ◀/▶ buttons to choose the sound system.(AUTO/M/BG/I/DK)  (NOTE : If the SOUND SYSTEM setting for a TV channel is incorrect, it may proven the sound from being issued.)
	Fine Tune	Decrease number	Increase number	If the channel reception is poor, select FINE TUNE and press the ◀/▶ buttons to fine tune the program.
	Store	Storing the manual setting		Select STORE and press the ◀/▶ buttons to store the manual setting. When stored, OK will be displayed for short seconds.
Teletext Language	West Europe ↔ East Europe Persian ↔ Cyrillic Arabic ↔ Greek		Select the language depends on your country or area.	
Sort (Press SORT EDIT button to modify the list)	(off the function)	-		<b>NOTES</b>
Screen Wipe	(off the function)	-		This is used to white pattern to reduces the screen burn made by continuous on-screen displays. Pressing the ENTER button to start the function and press EXIT button to leave.

## OPERATING INSTRUCTIONS (continued)

### System Menu (continued)

Sort (Press SORT EDIT button to modify the list)

#### NOTES

Press ENTER button to select the following functions.

Using the NAME, DELETE, or INSERT functions rewrites the current programmed numbers list. Therefore, the programmed number of some of the TV channels will change. Follow the operation description of a function you want to use and operate the function.

• **Name** : This function registers a channel name (ID) to a TV channel.

1. Press the ▲/▼ and ◀/▶ buttons to choose a TV channel. Every time you press the ▲/▼ and ◀/▶ buttons, the programmed number changes and the picture of the TV channel stored in the programmed number appears on the screen.
2. Press the red button to start the NAME function.
3. Press the ▲/▼ and ◀/▶ buttons to edit the channel name you want to give the TV channel.
4. Press the red button to store the setting.

To return to the INITIAL SETUP menu : Press the RETURN button.

To exit a menu instantly : Press the EXIT button.

• **Insert** : This function changes a programmed number of a TV channel.

1. Press the ▲/▼ and ◀/▶ buttons to choose a program number for which you want. Every time you press the ▲/▼ and ◀/▶ buttons, the programmed number changes and the picture of the TV channel stored in the programmed number appears on the screen.
2. Press the green button to start the INSERT function.
3. Press the ▲/▼ and ◀/▶ buttons to choose a new program number.
4. Press the green button to insert the channel into the new program number.

To return to the INITIAL SETUP menu : Press the RETURN button.

To exit a menu instantly : Press the EXIT button.

• **Delete** : This function deletes a TV channel you do not want to list.

1. Press the ▲/▼ and ◀/▶ buttons to choose a TV channel  
Every time you press the ▲/▼ and ◀/▶ buttons, the programmed number changes and the picture of the TV channel stored in the programmed number appears on the screen.
2. Press the blue button to start the DELETE function.
3. Press the ▲/▼ and ◀/▶ buttons to edit the channel name you want to delete the TV channel.
4. Press the blue button to store the setting.

To return to the INITIAL SETUP menu : Press the RETURN button.

To exit a menu instantly : Press the EXIT button.

## OPERATING INSTRUCTIONS (continued)

### Using the HDTV Menu Screen

1. Make sure the physical connection is properly connected.
2. Switch on the TV.
3. Select the HDTV input on your TV by using the remote control.
4. If the PDP is moved to a different location. You should reset the receiver and do the channel scanning all over again.

#### USING THE HDTV ON-SCREEN DISPLAY (OSD) CONTROLS

1. Press DTT MENU on the remote control to display the MENU banner.
2. Use the ▲▼◀▶ to navigate to different menu item.
3. Use the ◀▶ to adjust functions.
4. Press ENTER on the remote control to select functions. Press RTN to jump back the last page of menu.
5. Press RTN on the remote control to go to the last page; press EXIT to quickly exit from the menu.

#### HDTV Main Menu

<b>Edit Channel</b>	TV Main List	This is used to edit the channel from the TV channel list.
<b>Parental Guidance</b>	No Block	Blocks selected HDTV-rating and all ratings below it. (Enter the password to change setting).
	Block G and above	
	Block PG and above	
	Block M and above	
	Block MA and above	
	Block AV and above	
	Block R and above	
	Block All	
<b>Installation</b>	Manual Scan	Search scan TV channel by channel number, frequency, bandwidth and priority
	Quick Scan	Search scan TV channel by your location
	Auto Scan	Automatically search scan TV channel
	Restore Defaults	Sets HDTV back to default settings
<b>General Setting</b>	Audio Setup	Adjusts HDTV audio setting
	Option Setup	Adjusts HDTV OSD display setting
	Change Pin	To change password
	Local Time	Sets your local time
<b>System</b>	Status	Shows the software version of your set



## OPERATING INSTRUCTIONS (continued)

### Edit Channel



1. Press the DTT MENU button to display the MENU banner.
2. Use the arrow keys ▲ or ▼ to highlight "Edit Channel", then press ENTER to show the TV channel list.

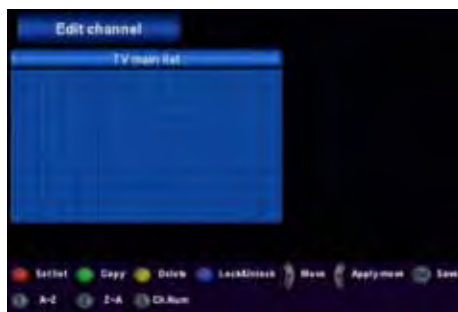

3. Use the arrow keys ▲ or ▼ to highlight the channel you want to edit.

#### • SET LIST

On pressing the red button on the remote control, you can toggle between TV MAIN LIST, FAVORITE LIST 1 and FAVORITE LIST 2, below the small TV screen on this menu you can see the name of the list.

When you haven't set up FAVORITE LIST, there's only TV MAIN LIST. Please refer to the following option COPY to learn how to set up the FAVORITE LIST.

#### • COPY (for set up FAVORITE LIST)

You can copy a channel from TV channel list to the favorite list.

- a. Highlight the channels in the channel list
- b. Use green key select the channel you want to copy to the favorite list.
- c. Each time you press the green button you will see "F1", "F2" or "F1/2" appears one after another, which means the highlighted channel can be assigned to "TV Favorite List 1", "TV Favorite List 2" or in both "TV Favorite List 1" and "TV Favorite List 2". Make sure all the channels you want to copy to the favorite channel list are correctly selected.
- d. Press the green key to copy the channel to the favorite channel list.

#### • DELETE

You can delete a channel from the TV channel list if you do not want it.

- a. Select the channel from the TV channel list using the ▲ or ▼ arrow keys.
- b. Press yellow key and X mark appears.
- c. Press the enter key to delete the selected channel.

#### • Lock/unlock

Use the ▲ or ▼ arrow keys to select the desired option and press blue key to "Lock" or "Unlock" channels/programs.

#### • Sort

There are three groups for your desired channels list once you press the number key from 1 to 3, which include, A – Z, Z – A and channel number.

#### • MOVE

You can re-arrange the channels in the TV channel list.

- a. Select the required channel by using the scroll keys.
- b. Press the ◀ or ▶ arrow key to select the channel. A yellow mark will appear to show the selection.
- c. Use the ▲ or ▼ scroll keys or numerical keys to move the selected channel to the desired location.
- d. If you want to move a group of channels, highlight the channels and press right arrow key first, and use the scroll key to highlight the entry you want to move in, then press left arrow key to apply move.

## OPERATING INSTRUCTIONS (continued)

### Parental Guidance

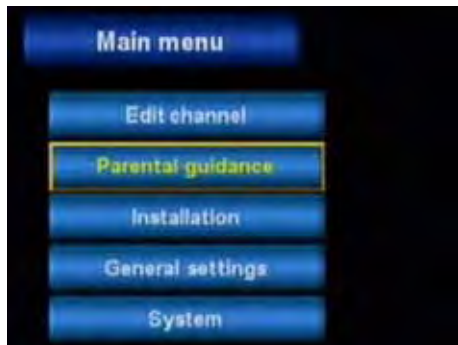

1. You can set "Parental Locking" for a selected channel to prevent your children from viewing sensitive material. Once you set the parental rating for the particular channel, the parental rating transmitted with the channel will verify if the received rating is higher than the parental lock rating. A pop-up message will say that the channel is locked. To see the channel, you have to enter a password in the Check Password Menu before viewing the channel. The default password is 0000.



2. This option will allow you to set the Parental Guidance Level for the receiver. You could use ▲ or ▼ arrow keys to scroll between different ratings. On selecting this option,

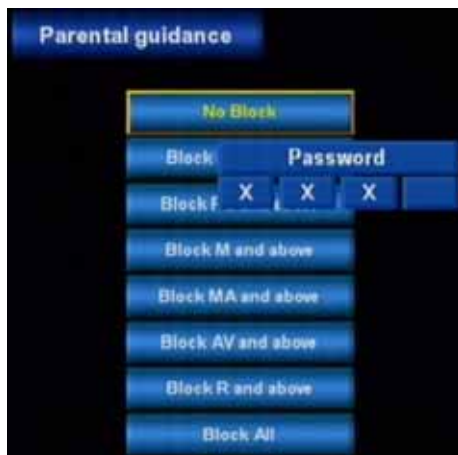

3. check password menu will pop-up. After giving the correct password, you can enter into the menu, which is shown below, for censoring the channels according to the age limits.

## OPERATING INSTRUCTIONS (continued)

### Installation

Before you use Digital TV, the available channels must first be scanned and memorized.

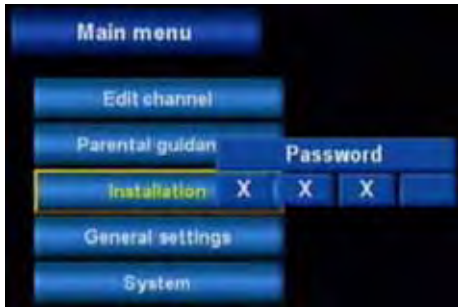

1. Press the DTT MENU button to display the MENU banner.
2. Use the arrow keys ▲ or ▼ to highlight “Installation” and enter default password “0000” to show four sub-menus.

### Manual Scan

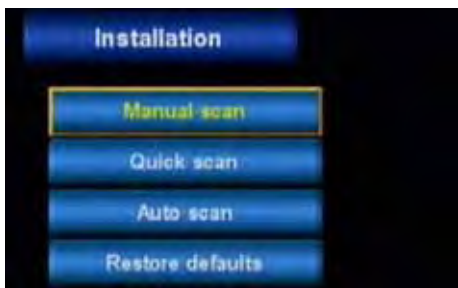

- a. Press ▲ or ▼ buttons to highlight the “Manual Scan”, and then press ENTER to launch the auto scan. A “Manual Scan” window will show.



- b. You can use the ▲ or ▼ keys to highlight a single channel, and just simply fill in all information which are inquired on the screen by remote control and then press ENTER button on the remote control to start manually scanning this single channel's signal.

### Quick Scan



- a. Press ▲ or ▼ buttons to highlight the “Quick Scan”, and then press ENTER to launch the auto scan. An “Quick Scan” window will show.

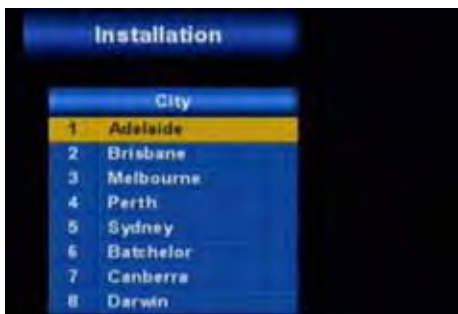

- b. Upon selecting the “Quick Scan” Option from the Search Channel menu, the default city will be displayed.

## OPERATING INSTRUCTIONS (continued)

### Installation (continued)

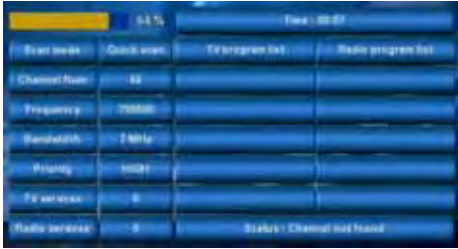

- c. Press ENTER on the city you choose by ▲ or ▼ keys, the channels / programs will be presented automatically.

**Note:** Current listed cities are for Australia; we will set individual cities for every different nations.

### Auto Scan

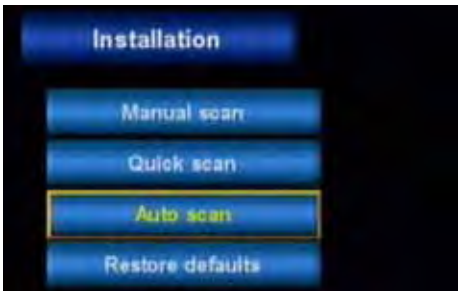

- a. Press ▲ or ▼ buttons to highlight the "Auto Scan", and then press ENTER to launch the auto scan. An "Auto Scan" window will show the SCAN status.

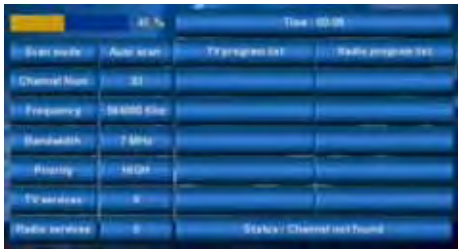

- b. Once the digital TV signal is scanned, the channel number and program name will be shown on the "Auto Scan List".
- c. When it is complete (even in processing) you can press EXIT key to leave the window and enjoy watching DTT programs.

### Restore Defaults



If you want to restore defaults, choice "OK" then all settings will be lost; if not choice "EXIT".

## OPERATING INSTRUCTIONS (continued)

### General Settings

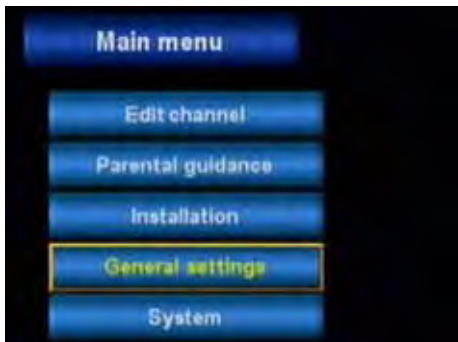

1. Press the DTT MENU button to display the MENU banner.
2. Use the arrow keys ▲ or ▼ to highlight “General Setting” and press ENTER key on remote control to show four sub-menus.
3. It will show “Audio Setup”, “Option Setup”, “Change Pin” and “Local Time”.

### Audio Setup

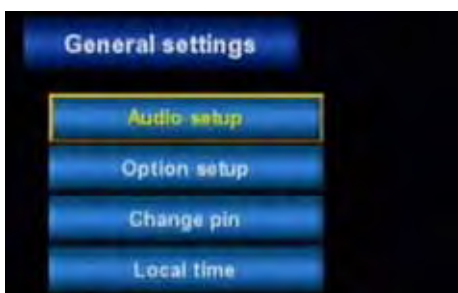

- a. Select the “Audio setup” of the “General Setting” OSD.

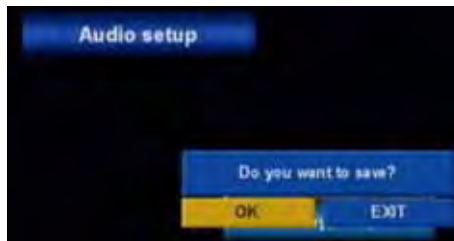
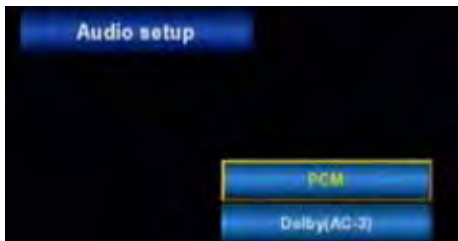

- b. You may choice PCM or Dolby then press ENTER key on the remote control.
- c. Choice “OK” then the settings will be saved; if not press “EXIT”.

### Option Setup

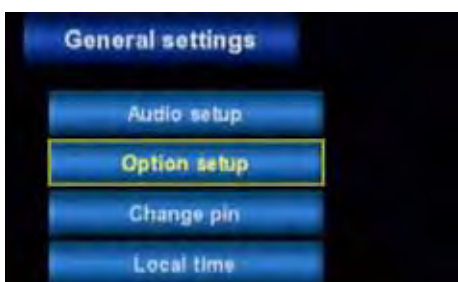

- a. Select the “Option setup” of the “General Setting” OSD.

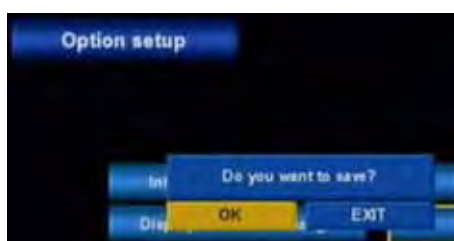

- b. Information box timeout: by adjust the timeout, you may change the time interval of the menu showing when you press DTT menu button on the remote control or doing the channel change.
- c. Choice “OK” then the settings will be saved; if not press “EXIT”.

## OPERATING INSTRUCTIONS (continued)

### General Settings (continued)

#### Change Pin

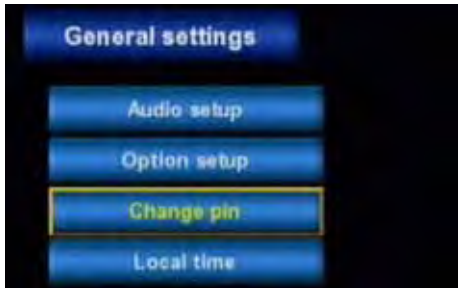

a. Select the "Change PIN" of the "General Setting" OSD.



b. Follow the instruction to change the PIN for Installation menu and parental control.

**NOTES:** 1. Before you change the password, uses the default password "0000" to enter the Menu item which requires the password.  
 2. If you forget the password, please see the following steps to set the new one:  
 a. Press YELLOW, GREEN, GREEN, RED, BLUE in change pin menu.  
 b. Press any 4 numbers.  
 c. Enter and confirm new password.

#### Local Time

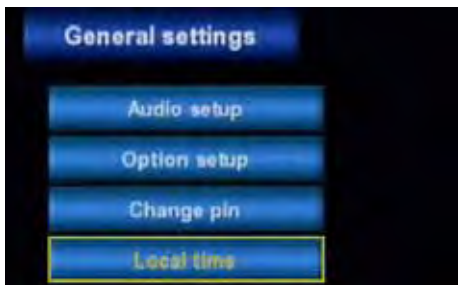

a. Select the "Local Time" of the "General Setting" OSD.



b. You may choice the time zone you are located.

### System

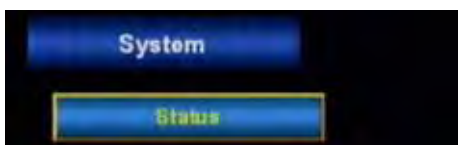

1. Press the DTT MENU button to display the MENU banner.

2. Use the arrow keys ▲ or ▼ to highlight "System" and press ENTER key on remote control to "Status" sub-menu.

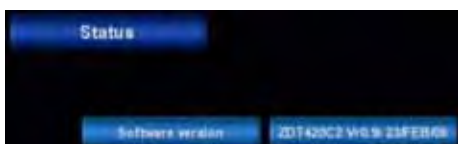

3. Press ENTER key again to show the DTT software version for service.

## OTHER FUNCTIONS

### Audio Switching

#### A2 / Sound Multiplex (TV mode)

- The I/II button in remote control is useful for sound multiplex signal. Otherwise pressing this button will have no effect.

#### BILINGUAL / DUAL sound broadcast

When bilingual program is received, sound mode display appears as shown on right.

Press the I/II button to select the sound to be heard.

Each time the button is pressed, ( I ) Language A, ( II ) Language B or ▼ Mono appear cyclically on the screen.

Sound multiplex signal received

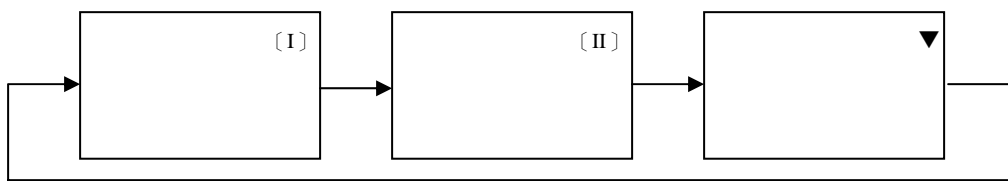

#### STEREO sound broadcast

When a stereo program is received, sound mode display will appear, and you can press the I/II button to select between stereo and mono sound.

Each time the button is pressed, ▼ Mono or ( S ) Stereo appear cyclically on the screen.

When receiving NICAM signals, NICAM display will appear as below.

Sound multiplex signal received

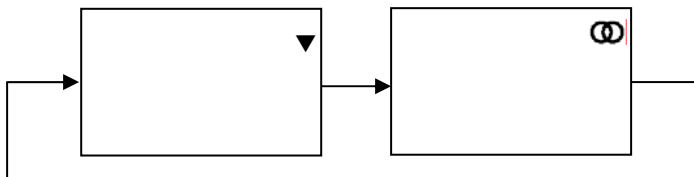

#### Monaural sound broadcast

When a monaural program is received, sound mode display will appear.

#### NOTE

- If sound signal is not strong enough for quality reception, press the I/II button until ▼ appears on the screen to receive a clear mono sound.
- If sound has hiss noise or keep switching between stereo and mono mode due to signal condition, press the I/II button until ▼ appears on the screen to receive a clear mono sound.

## OTHER FUNCTIONS (continued)

### Signal Check (Analog RGB mode)

Changes in the signal status are displayed on the screen as they arise.

Status	Display	Action
When Mode Display is set to ON, the input signal is switched or when the RECALL button is pressed.	A guide is displayed for the input terminal and the horizontal and vertical sync frequency.	_____
When the sync signal is no longer detected.	<ul style="list-style-type: none"> <li>• A guide displays No Input Signal, and Power Save (for approx. 5 sec.)</li> <li>• When the condition continues where the sync signal cannot be detected, indicator lamp of power source changes in orange and the mode switches to power save mode.</li> </ul>	Recheck the personal computer power switch status and the connection status.
When the input signal does not match the monitor specifications or is in an unstable status.	A guide displays No Input Signal.	Recheck the input signal specifications.

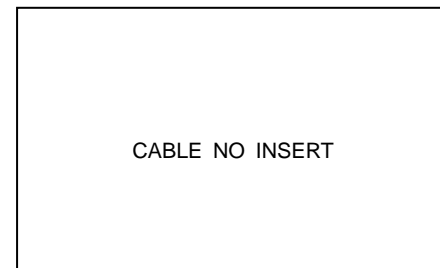
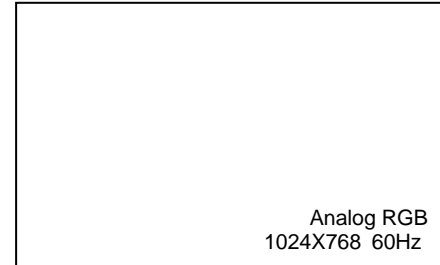

### Signal Check (TV/Video mode)

Changes in the signal status are displayed on the screen as they arise.

Mode	Status	Display	Action
TV	When the TV signal is no longer detected.	<ul style="list-style-type: none"> <li>• A guide is displayed for searching and counting down 2 minutes.</li> <li>• If the TV signal cannot be detected after 2 minutes, the PDP TV will turn off directly and indicator lamp is going to red.</li> </ul>	<ul style="list-style-type: none"> <li>• Recheck the antenna connection status.</li> <li>• Reception other than those of broadcasting stations can be considered.</li> </ul>
Video	When the sync. signal is no longer detected.	• A guide displays No Sync. Signal in orange.	<ul style="list-style-type: none"> <li>• Recheck the device power switch status and the connection status.</li> <li>• Recheck the device connection status.</li> <li>• Recheck the input signal specifications.</li> </ul>

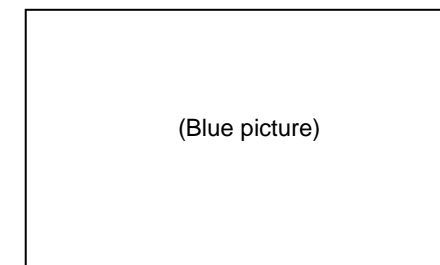



## OTHER FUNCTIONS (continued)

### Power Save Mode

#### When the Analog RGB input is selected

- When this unit is connected to a VESA DPMS computer, the Power Save (Off) mode can be set to be activated automatically when the computer is not being used to reduce power consumption by this unit.

RGB sync signal	Horizontal	Yes	No	Yes	No
	Vertical	Yes	Yes	No	No
PC signal		Active (normal display)		Blank (no display)	
Operation mode		On		Off	
Indicating lamp		Lights green		Lights orange	
Power consumption		350 W		3W (100V~240V)	

#### Returning to operating status

- Operate the personal computer, or press either the INPUT button of the main unit or the PC button of the remote control.







## TROUBLESHOOTING

### Symptoms That Seemingly Appear to be Failures

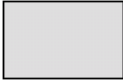
Make the checks suggested below depending on the symptoms observed. If the symptoms remain uncorrected, contact your dealer.

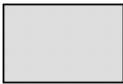
**⚠ WARNING**

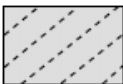
Customer servicing can be hazardous.

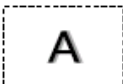
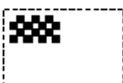
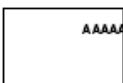
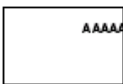
Symptom		Point to check	See page
• No picture with the power-indicating lamp off.		<ul style="list-style-type: none"> <li>• Check the way the power cord is connected.</li> <li>• Press the power switch.</li> </ul>	<div style="border: 1px solid black; padding: 2px; display: inline-block;">25</div> <div style="border: 1px solid black; padding: 2px; display: inline-block;">26</div>
<ul style="list-style-type: none"> <li>• The message "CABLE NO INSERT" is displayed.</li> <li>• Blue picture with the power indicating lamp lights in green.</li> </ul>	 	No input signal is detected. <ul style="list-style-type: none"> <li>• Check the way the signal cable is connected.</li> <li>• Make sure that the switch of the computer, imaging equipment, etc., is turned on.</li> <li>• Make sure the computer is not in the power-save mode.</li> <li>• Check to see if the input selection matches the connection terminal.</li> </ul>	<div style="border: 1px solid black; padding: 2px; display: inline-block;">24</div>
• Blue picture is displayed.		An input signal is not received normally. <ul style="list-style-type: none"> <li>• Check to see if the input signal matches the specifications.</li> <li>• Check the way the signal cable is connected.</li> </ul>	<div style="border: 1px solid black; padding: 2px; display: inline-block;">24</div> <div style="border: 1px solid black; padding: 2px; display: inline-block;">44</div>
• The power indicating lamp is normally lit but no picture.		<ul style="list-style-type: none"> <li>• Check the contrast and brightness settings (adjust them for higher contrast and brightness).</li> <li>• Check the way the signal cable is connected.</li> </ul>	<div style="border: 1px solid black; padding: 2px; display: inline-block;">21</div> <div style="border: 1px solid black; padding: 2px; display: inline-block;">30</div>
<ul style="list-style-type: none"> <li>• The display image appears flowing slantwise.</li> <li>• Text displayed across the screen appears vertically streaked, with the characters in vertical columns blurred.</li> </ul>	 	<ul style="list-style-type: none"> <li>• Adjust the dot clock frequency and phase. (Adjust the dot clock frequency first, the dot clock phase next.) (PC RGB input)</li> </ul>	<div style="border: 1px solid black; padding: 2px; display: inline-block;">31</div> <div style="border: 1px solid black; padding: 2px; display: inline-block;">51</div>
<ul style="list-style-type: none"> <li>• Text displayed across the screen appears blurred.</li> <li>• A fine pattern flickers when displayed on the screen.</li> </ul>	 	<ul style="list-style-type: none"> <li>• Adjust the dot clock phase for the clearest viewing. (PC RGB input)</li> </ul>	<div style="border: 1px solid black; padding: 2px; display: inline-block;">31</div> <div style="border: 1px solid black; padding: 2px; display: inline-block;">51</div>
• The remote control does not work.		<ul style="list-style-type: none"> <li>• Check to see if the batteries are loaded in the remote control in opposite direction.</li> <li>• Check to see if the batteries in the remote control are OK.</li> </ul>	<div style="border: 1px solid black; padding: 2px; display: inline-block;">11</div>
• The display image does not appear in the normal position.		<ul style="list-style-type: none"> <li>• Check to see if the displayed input signal match the PDP TV specification by pressing RECALL button.</li> <li>• Turn off the Move screen.</li> </ul>	<div style="border: 1px solid black; padding: 2px; display: inline-block;">33</div> <div style="border: 1px solid black; padding: 2px; display: inline-block;">49</div>
• The display has lack of picture around the screen. (PC RGB input)		<ul style="list-style-type: none"> <li>• Turn off the Move screen.</li> </ul>	<div style="border: 1px solid black; padding: 2px; display: inline-block;">33</div>
• The temperature of the display panel surface is high.		<ul style="list-style-type: none"> <li>• The plasma display panel is lighting the phosphors by the discharge of internal radiation. In some cases, this may cause the temperature of the panel surface to increase. Please note that this is not a malfunction.</li> </ul>	-

## TROUBLESHOOTING (continued)

### Symptoms That Seemingly Appear to be Failures (continued)

Symptom	Point to check	See page
<ul style="list-style-type: none"> <li>There are locations on the screen that are different from the periphery (*).</li> <li>*Points that do not light, points with brightness different from that of the periphery, points with color different from that of the periphery, etc.</li> </ul>	<ul style="list-style-type: none"> <li>High-precision technology is used to manufacture the plasma display panel, However in some cases, there are minor defects in some parts of the screen. Please note that this is not a malfunction.</li> </ul>	-
<ul style="list-style-type: none"> <li>Vertical stripes appear, depending on the screen contents.</li> </ul>	<ul style="list-style-type: none"> <li>The plasma display panel is lighting the phosphors by the discharge of internal radiation. Depending on the screen contents, in rare cases this may cause vertical stripes to appear because of failure to light. Please note that this is not a malfunction.</li> </ul>	-
<ul style="list-style-type: none"> <li>Coarse horizontal stripes appear in FULL display.</li> </ul>	<ul style="list-style-type: none"> <li>Adjusting the Clock Phase will reduce the horizontal stripes. (PC RGB input)</li> </ul>	31
<ul style="list-style-type: none"> <li>Flickering in the form of horizontal lines oscillating up and down. (PC RGB input only)</li> </ul>	<ul style="list-style-type: none"> <li>If the direct frequency from the computer is below 85Hz, try a higher frequency (upper limit 85Hz). There may be a slight attenuation of the current image.</li> </ul>	51
<ul style="list-style-type: none"> <li>The top of the monitor heats up.</li> </ul>	<ul style="list-style-type: none"> <li>When used for long periods of time, the top of the monitor may heat up. This is not a malfunction.</li> </ul>	-
<ul style="list-style-type: none"> <li>Text characters are displayed with varying thicknesses.</li> </ul>	<ul style="list-style-type: none"> <li>The thicknesses of characters and lines may vary if images with a vertical resolution greater than 512 lines are displayed; however, this is not a malfunction.</li> </ul>	-
<ul style="list-style-type: none"> <li>The screen becomes dark and the images can not be seen during VTR special playback (fast forward, rewind)</li> </ul>	<ul style="list-style-type: none"> <li>This sometimes occurs when a component output VTR such as the 480i is connected. This is not a malfunction; therefore, please take note that this may occur. When it does occur, change to composite output, or S-video output.</li> </ul>	-
<ul style="list-style-type: none"> <li>During PIP mode, sub pictures are not displayed.</li> </ul>	<ul style="list-style-type: none"> <li>Sub pictures image might not be able to be displayed, depending on the combination. (Refer to the table of PIP input table)</li> </ul>	15
<ul style="list-style-type: none"> <li>The screen display sizes are not switched.</li> </ul>	<ul style="list-style-type: none"> <li>The screen display size is fixed at "Full" as receiving VGA signal.</li> </ul>	-
<ul style="list-style-type: none"> <li>Images from HDMI are not displayed.</li> </ul>	<ul style="list-style-type: none"> <li>Check the cable and output format of connecting device. (Refer to "Connecting to an Audio Visual Device".)</li> </ul>	20 21 23 48

## TROUBLESHOOTING (continued)

### Actions to Correct Abnormal Displays



Depending on the kind of system equipment used, images may not be displayed normally. In this case, make the adjustments suggested below. (only for PC RGB)

Symptom 1	Text displayed across the screen appears vertically streaked, with some characters blurred (Figure 1). (PC RGB input).	
Example	<p>Figure 1</p>	
Adjustment Procedure	<ol style="list-style-type: none"> <li>1) Press the MENU button. The Main Menu will be displayed.</li> <li>2) Press the ▼ button and select "IMAGE".</li> <li>3) Press the ENTER button. The "IMAGE" Menu will be displayed.</li> <li>4) Press the ▼ button and select "Auto Adjust".</li> </ol>	
	<p>When adjustment is not possible with Auto Adjust</p> <ol style="list-style-type: none"> <li>5) Press the MENU button. The Main Menu will be displayed.</li> <li>6) Press the ▼ button and select "IMAGE".</li> <li>7) Press the ENTER button. The Setup Menu will be displayed.</li> <li>8) Press the ▼ button and select "Horizontal Clock". (Display fine patterns as characters or a vertical striped pattern over the entire screen during Horizontal Clock adjustment.)</li> <li>9) Press the ◀ or ▶ buttons and search for clear characters over the entire screen.</li> <li>10) Perform adjustment for symptom 2 below, when the characters are blurred on the entire screen.</li> </ol>	

- The display image may be momentarily disturbed during clock adjustment but this is not a failure.

Symptom 2	Text displayed across the screen appears blurred in its entirety (Figure 2). A fine pattern flickers when displayed on the screen (Figure 3).	
Example	<p>Figure 2</p>	<p>Figure 3</p>
Adjustment procedure	<ol style="list-style-type: none"> <li>1) Press the MENU button. The Main Menu will be displayed.</li> <li>2) Press the ▼ button and select "IMAGE".</li> <li>3) Press the ENTER button. The Setup Menu will be displayed.</li> <li>4) Press the ▼ button and select "Auto Adjust".</li> </ol>	
	<p>When adjustment is not possible with Auto Adjust</p> <ol style="list-style-type: none"> <li>5) Press the MENU button. The Main Menu will be displayed.</li> <li>6) Press the ▼ button and select "IMAGE".</li> <li>7) Press the ENTER button. The Setup Menu will be displayed.</li> <li>8) Press the ▼ button and select "Clock Phase". (Display fine patterns as characters or a vertical striped pattern over the entire screen during Clock Phase adjustment.)</li> </ol>	
	9) Press ◀ or ▶ buttons to make the text appear clean across the screen.	9) Press ◀ or ▶ buttons to make the text appear without flickering.

## PRODUCT SPECIFICATIONS

<b>Panel</b>	<b>Display dimensions</b>	Approx. 42 inches (926 (H) x 525 (V) mm, diagonal 1064mm)
	<b>Resolution</b>	1024(H) x 1024 (V) pixels
<b>Net dimensions</b>		1036 (W) x 713 (H) x 121 (D) mm
<b>Net weight</b>		33.6 kg
<b>Ambient conditions</b>	<b>Temperature</b>	Operating : 5°C to 35°C, Storage : 0°C to 40°C
	<b>Relative humidity</b>	Operating : 20% to 80%, Storage : 20% to 90% (non-condensing)
<b>Power supply</b>		AC100 - 240V, 50/60Hz
<b>Power consumption/at standby</b>		350W / <3W
<b>Audio output</b>		speaker 10W + 10W (8Ω)
<b>(RGB input)</b>		
<b>Input terminals</b>		D-Sub input terminal (D-sub 15-pin) PC audio input terminal (3.5mm Stereo Mini Jack)
<b>Input signals</b>		0.7Vp-p, analog RGB (Recommended Signal)
<b>Sync signals</b>		H/V Separate, TTL level[2kΩ] H/V Composite, TTL level[2kΩ] Sync on green, 0.3Vp-p[75Ω]
<b>Recommended signal</b>		17 modes 
<b>(Video input)</b>		
<b>Input terminals</b>		Composite video input terminal (RCA) Composite video L/R audio input terminal (RCA) S-Video input terminal S-Video L/R audio input terminal (RCA) Component - YC <sub>B</sub> C <sub>R</sub> /YP <sub>B</sub> P <sub>R</sub> video input terminal (RCA) Component - YC <sub>B</sub> C <sub>R</sub> /YP <sub>B</sub> P <sub>R</sub> L/R audio input terminal (RCA) HDMI input terminal
<b>Input signals</b>		Composite video: PAL, SECAM, NTSC Component - YC <sub>B</sub> C <sub>R</sub> /YP <sub>B</sub> P <sub>R</sub> video: 480i, 576i, 480p, 576p, 1080i/50, 1080i/60, 720p/50, 720p/60 S-Video: PAL, SECAM, NTSC HDMI: HDMI input signal
<b>Output Signal</b>		Video Output: TV/Composite video/S-Video output terminal (RCA) Audio Output: L/R audio output terminal (RCA)/Subwoofer output terminal(RCA)/ S/P DIF
<b>Recommended signal</b>		19 modes 
<b>(RF input)</b>		
<b>Input terminals</b>		ANT : 75Ω Unbalanced
<b>Analog RF Video System</b>		PAL B,G / I / D,K NTSC-M SECAM B,G / D,K
<b>Digital RF Video System</b>		DVB-T

This television takes at least 30 minutes to attain the status of optimal picture quality.

## PRODUCT SPECIFICATIONS (continued)

### Recommended Signal List

With composite input and S-Video input.

No.	Signal mode			Horizontal frequency (kHz)	Dot clock frequency (MHz)	Remarks
	Signal Name	Resolution	Vertical frequency (Hz)			
1	NTSC4.43 NTSC3.58	525	59.94	15.734	—	
2	PAL SECAM	625	50.00	15.630	—	

With Component input

No.	Signal mode			Horizontal frequency (kHz)	Dot clock frequency (MHz)	Remarks
	Signal Name	Resolution	Vertical frequency (Hz)			
1	576i	576	50.00	15.63	—	
2	480i	480	59.94	15.73	—	
3	576p	576	50.00	31.26	—	
4	480p	480	59.94	31.47	—	
5	1080i/50	1080	50.00	28.13	—	
6	1080i/60	1080	60.00	33.75	—	
7	720p/50	720	50.00	37.00	—	
8	720p/60	720	60.00	45.00	—	

With HDMI input

No.	Signal mode			Horizontal frequency (kHz)	Dot clock frequency (MHz)	Remarks
	Signal Name	Resolution	Vertical frequency (Hz)			
1	VGA	640 x 480	59.94	31.47	25.18	VESA
2	576i	720(1440) x 576	50.00	15.63	27.00	EIA-861B
3	480i	720(1440) x 480	59.94	15.73	27.00	EIA-861B
4	576p	720 x 576	50.00	31.25	27.00	EIA-861B
5	480p	720 x 480	59.94	31.47	27.00	EIA-861B
6	1080i/50	1920 x 1080	50.00	28.13	74.25	EIA-861B
7	1080i/60	1920 x 1080	60.00	33.75	74.25	EIA-861B
8	720p/50	1280 x 720	50.00	37.50	74.25	EIA-861B
9	720p/60	1280 x 720	60.00	45.00	74.25	EIA-861B

## PRODUCT SPECIFICATIONS (continued)

### Recommended Signal List (continued)

With Analog RGB signal input

No.	Signal mode			Horizontal frequency (kHz)	Dot clock frequency (MHz)	Remarks
	Signal Name	Resolution	Vertical frequency (Hz)			
1	VGA	640 x 400	70.08	31.47	25.18	
2	VGA	640 x 480	59.94	31.47	25.18	
3	VGA	640 x 480	72.81	37.86	31.50	
4	VGA	640 x 480	75.00	37.50	31.50	
5	VGA	640 x 480	85.01	43.27	36.00	
6	SVGA	800 x 600	56.25	35.16	36.00	
7	SVGA	800 x 600	60.32	37.88	40.00	
8	SVGA	800 x 600	72.19	48.08	50.00	
9	SVGA	800 x 600	75.00	46.88	49.50	
10	SVGA	800 x 600	85.06	53.67	56.25	
11	XGA	1024 x 768	60.00	48.36	65.00	
12	XGA	1024 x 768	70.07	56.48	75.00	
13	XGA	1024 x 768	75.03	60.02	78.75	
14	XGA	1024 x 768	85.00	68.68	94.50	
15	XGA	1280 x 720	60.00	45.00	74.30	
16	XGA	1280 x 960	60.00	60.00	108.00	
17	XGA	1280 x 1024	60.02	63.98	108.00	

- The type of video board or connecting cable used may not allow for correct displays adjustment of Horizontal Position, Vertical Position, Horizontal Clock and Clock Phase.
- The monitor may fail to display an animation image correctly when a signal having a vertical frequency of 85Hz or higher is input to it.
- The monitor differentiates the signal modes according to the horizontal and vertical frequencies and the horizontal and vertical sync signal polarities. Note that different signals having all these elements alike may be handled as the same signal.
- Displaying images with more than 512 lines of vertical resolution at Full display(compressed display) can result in the interpolation of stripes





## Free Manuals Download Website

<http://myh66.com>

<http://usermanuals.us>

<http://www.somanuals.com>

<http://www.4manuals.cc>

<http://www.manual-lib.com>

<http://www.404manual.com>

<http://www.luxmanual.com>

<http://aubethermostatmanual.com>

Golf course search by state

<http://golfingnear.com>

Email search by domain

<http://emailbydomain.com>

Auto manuals search

<http://auto.somanuals.com>

TV manuals search

<http://tv.somanuals.com>