

HITACHI

PROJECTION COLOR TV

46F500
51F500
57F500

51G500
57G500

OPERATING GUIDE



IMPORTANT SAFETY INSTRUCTIONS 2-3



FIRST TIME USE 4-19



THE REMOTE CONTROL 20-31

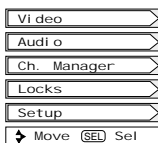

ON-SCREEN DISPLAY 32-56

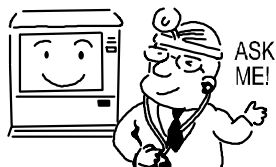

USEFUL INFORMATION INDEX 57-63

As an ENERGY STAR® Partner, Hitachi, Ltd. has determined that this product meets the ENERGY STAR® guidelines for energy efficiency.





SAFETY POINTS YOU SHOULD KNOW ABOUT YOUR HITACHI TELEVISION

Our reputation has been built on the quality, performance, and ease of service of HITACHI televisions.

Safety is also foremost in our minds in the design of these units. To help you operate these products properly, this section illustrates safety tips which will be of benefit to you. Please read it carefully and apply the knowledge you obtain from it to the proper operation of your HITACHI television.

Please fill out your warranty card and mail it to HITACHI. This will enable HITACHI to notify you promptly in the improbable event that a safety problem should be discovered in your product model.

Follow all warnings and instructions marked on this television.

	<p>CAUTION</p> <p>RISK OF ELECTRIC SHOCK DO NOT OPEN</p>			<p>The lightning flash with arrowhead symbol, within an equilateral triangle, is intended to alert the user to the presence of uninsulated "dangerous voltage" within the product's enclosure that may be of a sufficient magnitude to constitute a risk of electric shock to persons.</p>
<p>CAUTION: TO REDUCE THE RISK OF ELECTRIC SHOCK, DO NOT REMOVE COVER (OR BACK). NO USER SERVICEABLE PARTS INSIDE. REFER SERVICING TO QUALIFIED SERVICE PERSONNEL.</p>				<p>The exclamation point within an equilateral triangle, is intended to alert the user to the presence of important operating and maintenance (servicing) instructions in the literature accompanying the appliance.</p>

WARNING:
TO PREVENT FIRE OR SHOCK HAZARD, DO NOT EXPOSE THIS TELEVISION TO RAIN OR MOISTURE.

NOTE:

- There are no user serviceable parts inside the television.
- Model and serial numbers are indicated on back side of the television.

CAUTION: Adjust only those controls that are covered in the instructions, as improper changes or modifications not expressly approved by HITACHI could void the user's authority to operate the television.



MODIFICATIONS: The FCC requires the user to be notified that any changes or modifications made to this device that are not expressly approved by Hitachi America, Ltd. Home Electronics Division may void the user's authority to operate the equipment.

POWER SOURCE

THIS TELEVISION IS DESIGNED TO OPERATE ON 120 VOLTS 60Hz, AC CURRENT. INSERT THE POWER CORD INTO A 120 VOLT 60Hz OUTLET.

TO PREVENT ELECTRIC SHOCK, DO NOT USE THE TELEVISION'S (POLARIZED) PLUG WITH AN EXTENSION CORD, RECEPTACLE, OR OTHER OUTLET UNLESS THE BLADES AND GROUND TERMINAL CAN BE FULLY INSERTED TO PREVENT BLADE EXPOSURE.

NEVER CONNECT THE TELEVISION TO 50Hz, DIRECT CURRENT, OR ANYTHING OTHER THAN THE SPECIFIED VOLTAGE.

NOTE: This television receiver will display television closed captioning, ( or ), in accordance with paragraph 15.119 of the FCC rules.

 **CAUTION:** Never remove the back cover of the television as this can expose you to very high voltages and other hazards. If the television does not operate properly, unplug the television and call your authorized dealer or service center.



IMPORTANT

Read before operating equipment

Follow all warnings and instructions marked on this television.

1. Read these instructions.
2. Keep these instructions.
3. Heed all warnings.
4. Follow all instructions.
5. Do not use this apparatus near water.
6. Clean only with a dry cloth.
7. Do not block any ventilation openings. Install in accordance with the manufacturer's instructions.
8. Do not install near any heat sources such as radiators, heat registers, stoves, or other apparatus (including amplifiers) that produce heat.
9. Do not defeat the safety purpose of the polarized or grounding-type plug. A polarized plug has two blades with one wider than the other. A grounding type plug has two blades and a third grounding prong. The wide blade or the third prong are provided for your safety. If the provided plug does not fit into your outlet, consult an electrician for replacement of the obsolete outlet.
10. Protect the power cord from being walked on or pinched particularly at plugs, convenience receptacles, and the point where they exit from the apparatus.
11. Only use the attachments/accessories specified by the manufacturer.

12.  Use only with the cart, stand, tripod, bracket, or table specified by the manufacturer, or sold with the apparatus. When a cart is used, use caution when moving the cart/apparatus combination to avoid injury from tip-over.

13. Unplug this apparatus during lightning storms or when unused for long periods of time.
14. Refer all servicing to qualified service personnel. Servicing is required when the apparatus has been damaged in any way, such as power-supply cord or plug is damaged, liquid has been spilled or objects have fallen into apparatus, the apparatus has been exposed to rain or moisture, does not operate normally, or has been dropped.

Do not place any objects on the top of the television which may fall or cause a child to climb to retrieve the objects.

Projection TV's are heavy and can mark or damage floor surfaces (especially wood flooring) if moved improperly. Do not slide or force TV into position. Always roll TV allowing casters at bottom of unit to help steer and position the TV.

PREVENTION OF SCREEN BURN
 This Wide Screen TV is designed to display wide screen pictures. Images should be viewed mostly in wide screen format or zoomed to fill the screen with moving pictures. Use of side panels, top and bottom panels of standard picture formats should only be 15% of your total viewing time to prevent uneven aging of the phosphors. Phosphors in the lighted area of the picture will age more rapidly than the gray areas. Continuous on-screen displays such as video games, stock market quotations, computer generated graphics, and other fixed (non-moving) patterns can cause permanent damage to television receivers. Such "SCREEN BURNS" constitute misuse and are **NOT COVERED** by your HITACHI Factory Warranty.

PUBLIC VIEWING OF COPYRIGHTED MATERIAL
 Public viewing of programs broadcast by TV stations and cable companies, as well as programs from other sources, may require prior authorization from the broadcaster or owner of the video program material.

15. Televisions are designed to comply with the recommended safety standards for tilt and stability. Do not apply excessive pulling force to the front, or top, of the cabinet which could cause the product to overturn resulting in product damage and/or personal injury.
16. Follow instructions for wall, shelf or ceiling mounting as recommended by the manufacturer.
17. An outdoor antenna should not be located in the vicinity of overhead power lines or other electrical circuits.
18. If an outside antenna is connected to the receiver be sure the antenna system is grounded so as to provide some protection against voltage surges and built up static charges. Section 810 of the National Electric Code, ANSI/NFPA No. 70-1984, provides information with respect to proper grounding for the mast and supporting structure, grounding of the lead-in wire to an antenna discharge unit, size of grounding connectors, location of antenna-discharge unit, connection to grounding electrodes and requirements for the grounding electrode.

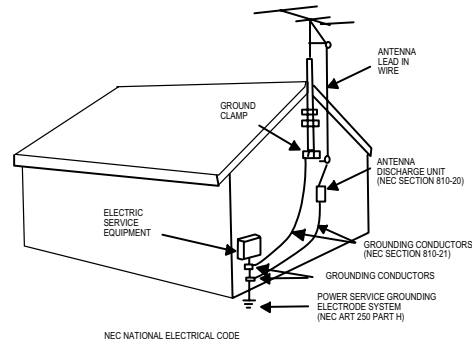

Note to the CATV system installer: This reminder is provided to call the CATV system installer's attention to Article 820-40 of the NEC that provides guidelines for proper grounding and, in particular, specifies that the cable ground shall be connected to the grounding system of the building, as close to the point of cable entry as practical.

Disposal of this product may require specific instructions pertaining to your resident state. For disposal or recycling information, please contact your local authorities or the Electronic Industries Alliance: www.eiae.org.

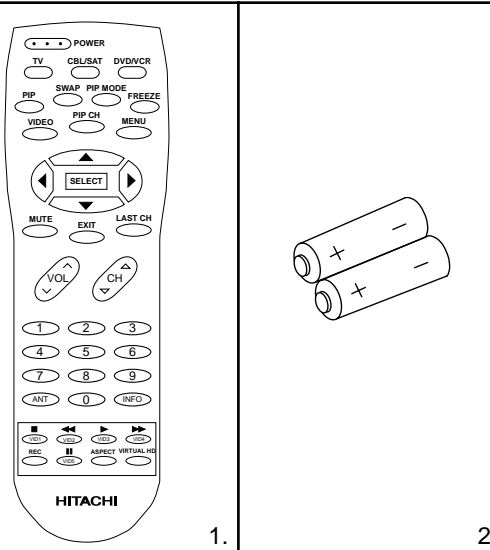
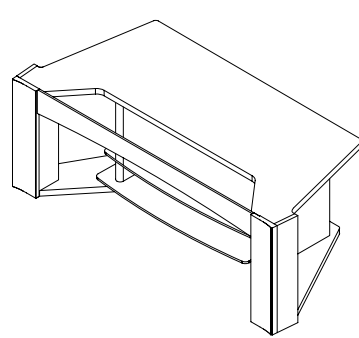

Check to make sure you have the following accessories before disposing of the packing material.

PART NAME	PART NO.	ILLUSTRATION
REMOTE CONTROL CLU-4321UG OR REMOTE CONTROL CLU-4324UG	HL01831 OR HL01834	
46" TELEVISION STAND SP-46W (Not included, order separately) OPTIONAL	H530056	

FIRST TIME USE



CAUTION: Television model 46F500 for use only with Hitachi's 46" Television Stand model SP-46W. Use with other stands is capable of resulting in instability causing possible injury.

1. Remote Control Unit is either CLU-4321UG (Part No. HL01831) or CLU-4324UG (Part No. HL01834).
2. Two "AA" size, 1.5V batteries (For Remote Control Unit).

REMOTE CONTROL BATTERY INSTALLATION AND REPLACEMENT

1. Open the battery cover of the remote control by pushing the notched part of the cover with your fingers and pulling the cover off.
2. Insert two new "AA" size batteries for the remote control. When replacing old batteries, push them towards the springs and lift them out.
3. Match the batteries to the (+) and (-) marks in the battery compartment.
4. Replace the cover.

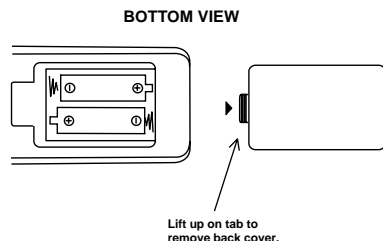

CAUTION: Danger of explosion if battery is incorrectly replaced. Replace with the same or equivalent type.



HOW TO SET UP YOUR NEW HITACHI PROJECTION TV

ANTENNA

Unless your TV is connected to a cable TV system or to a centralized antenna system, a good outdoor TV antenna is recommended for best performance. However, if you are located in an exceptionally good signal area that is free from interference and multiple image ghosts, an indoor antenna may be sufficient.

LOCATION

Select an area where sunlight or bright indoor illumination will not fall directly on the picture screen. Also, be sure that the location selected allows a free flow of air to and from the perforated back cover of the set.

To avoid cabinet warping, cabinet color changes, and increased chance of set failure, do not place the TV where temperatures can become excessively hot, for example, in direct sunlight or near a heating appliance, etc.

VIEWING

The major benefit of the HITACHI Projection Television is its large viewing screen. To see this large screen at its best, test various locations in the room to find the optimum spot for viewing.

The best picture is seen by sitting directly in front of the TV and about 10 to 18 feet from the screen. Picture brightness decreases as the viewer moves to the left and right of the receiver.

During daylight hours, reflections from outside light may appear on the screen. If so, drapes or screens can be used to reduce the reflection or the TV can be located in a different section of the room.

If the TV's audio output will be connected to a Hi-Fi system's external speakers, the best audio performance will be obtained by placing the speakers equidistant from each side of the receiver cabinet and as close as possible to the height of the picture screen center. For best stereo separation, place the external speakers at least four feet from the side of the TV, place the surround speakers to the side or behind the viewing area. Differences in room sizes and acoustical environments will require some experimentation with speaker placement for best performance.

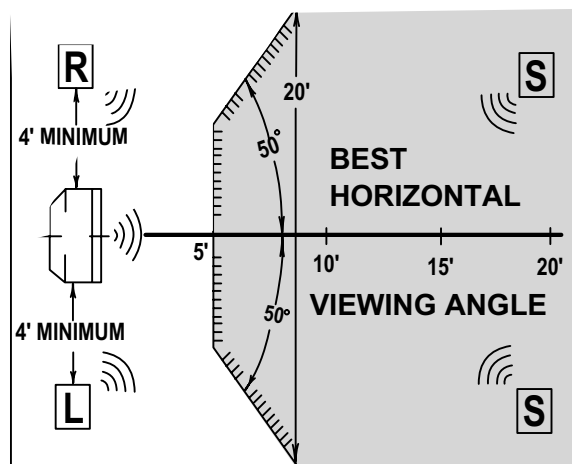
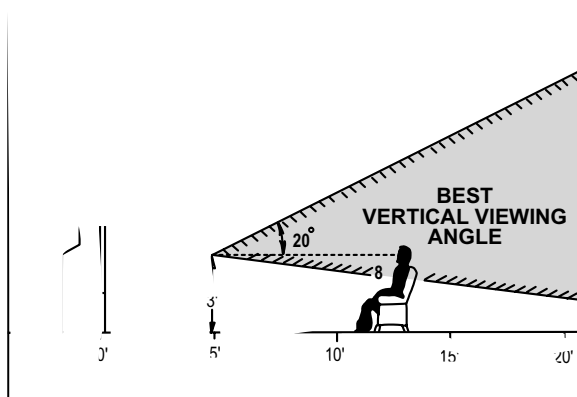

CAUTION: Magnetic fields, such as those of external speakers, may cause the picture to distort if they are placed too close to the television. Move the magnetic field source away from the television until there is no picture distortion.



HOOK-UP CABLES AND CONNECTORS

FIRST TIME USE

Most video/audio connections between components can be made with shielded video and audio cables that have phono connectors. For best performance, video cables should use 75-Ohm coaxial shielded wire. Cables can be purchased from most stores that sell audio/video products. Below are illustrations and names of common connectors. Before purchasing any cables, be sure of the output and input connector types required by the various components and the length of each cable.

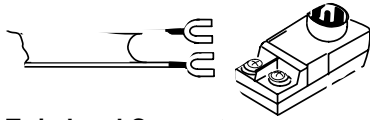

300-Ohm Twin Lead Connector

This outdoor antenna cable must be connected to an antenna adapter (300-Ohm to 75-Ohm).



"F" Type 75-Ohm Coaxial Antenna Connector

For connecting RF signals (antenna or cable TV) to the antenna jack on the television.

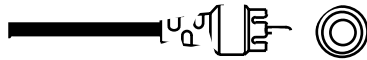

Phono Connector

Used on all standard video and audio cables which connect to inputs and outputs located on the television's rear jack panel and front control panel.



S-Video (Super Video) Connector

This connector is used on camcorders, VCRs and laser-disc players with an S-Video feature in place of the standard video cable to produce a high quality picture.

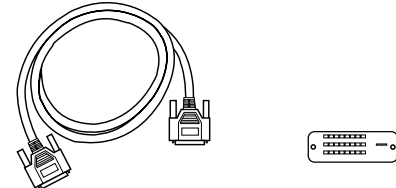

Digital Visual Interface (DVI) Connection Cable

This cable is used to connect external devices with DVI-HDTV output capability.

ANTENNA CONNECTIONS TO REAR JACK PANEL

VHF (75-Ohm) antenna/CATV (Cable TV)

When using a 75-Ohm coaxial cable system, connect the outdoor antenna or CATV coaxial cable to the ANT A (75-Ohm) terminal. If you have a second antenna or cable TV system, connect the coaxial cable to the ANT B terminal.

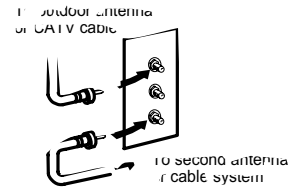

VHF (300-Ohm) antenna/UHF antenna

When using a 300-Ohm twin lead from an outdoor antenna, connect the VHF or UHF antenna leads to screws of the VHF or UHF adapter. Plug the adapter into the antenna terminal on the TV.

TO OUTDOOR VHF or UHF antenna



When both VHF and UHF antennas are connected

Attach an optional antenna cable mixer to the TV antenna terminal, and connect the cables to the antenna mixer. Consult your dealer or service store for the antenna mixer.

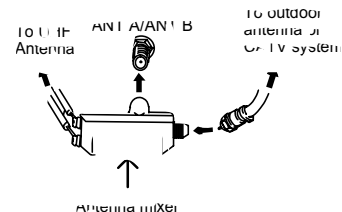



FRONT PANEL CONTROLS

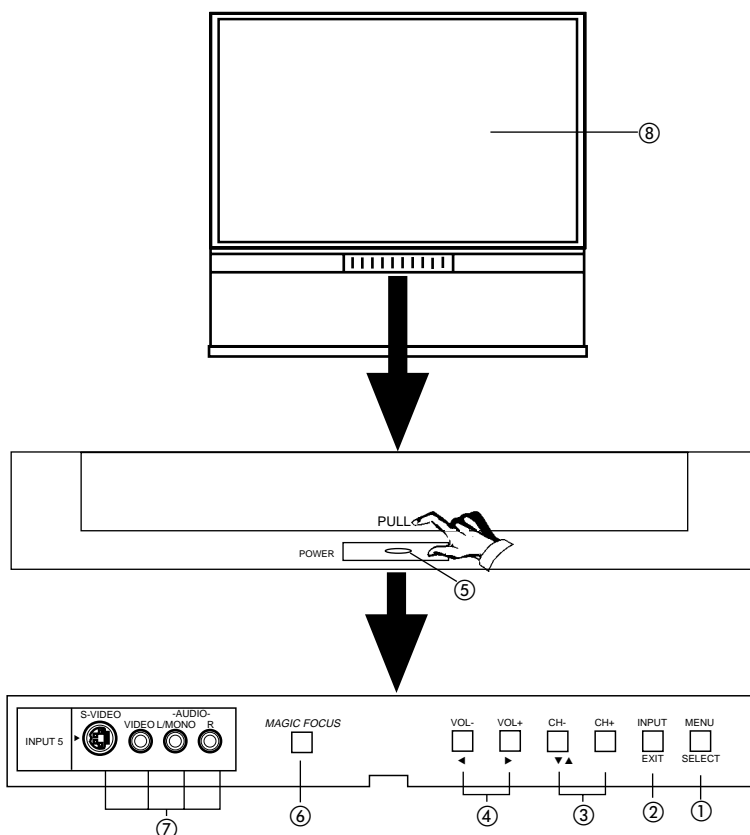

① MENU/SELECT button

This button allows you to enter the MENU, making it possible to set TV features to your preference without using the remote. This button also serves as the SELECT button when in MENU mode.

② INPUT/EXIT button

Press this button to select the current antenna source, VIDEO: 1, 2, 3, 4, 5 or alternate antenna source. Your selection is shown in the top right corner of the screen. This button also serves as the EXIT button when in MENU mode.

NOTES: Your remote control does not have an INPUT button. To change to video inputs, press VID1~VID5 buttons depending on your choice (see page 20).

③ CHANNEL selector

Press these buttons until the desired channel appears in the top right corner of the TV screen. These buttons also serve as the cursor down (▼) and up (▲) buttons when in MENU mode.

④ VOLUME level

Press these buttons for your desired sound level. The volume level will be displayed on the TV screen. These buttons also serve as the cursor left (◀) and right (▶) buttons when in MENU mode.

⑤ POWER button

Press this button to turn the TV on or off.

⑥ MAGIC FOCUS

Use this button to automatically adjust your picture quality to optimum performance (see page 36). The Magic Focus button will not work when adjustment mode is set to manual (see page 37).

⑦ FRONT INPUT JACKS (INPUT 5)

Use these audio/video jacks for a quick hook-up from a camcorder or VCR to instantly view your favorite show or new recording. Press the INPUT button until VIDEO: 5 appears in the top right corner of the TV screen. If you have mono sound, insert the audio cable into the left audio jack.

⑧ IR RECEIVER

The screen area acts as the IR receiver (remote sensor) of the TV. When using the remote control, point it towards the screen for best response.



FRONT PANEL JACKS AND CONNECTORS

FIRST TIME USE

The front panel jacks are provided as a convenience to allow you to easily connect a camcorder or VCR as shown in the following examples:

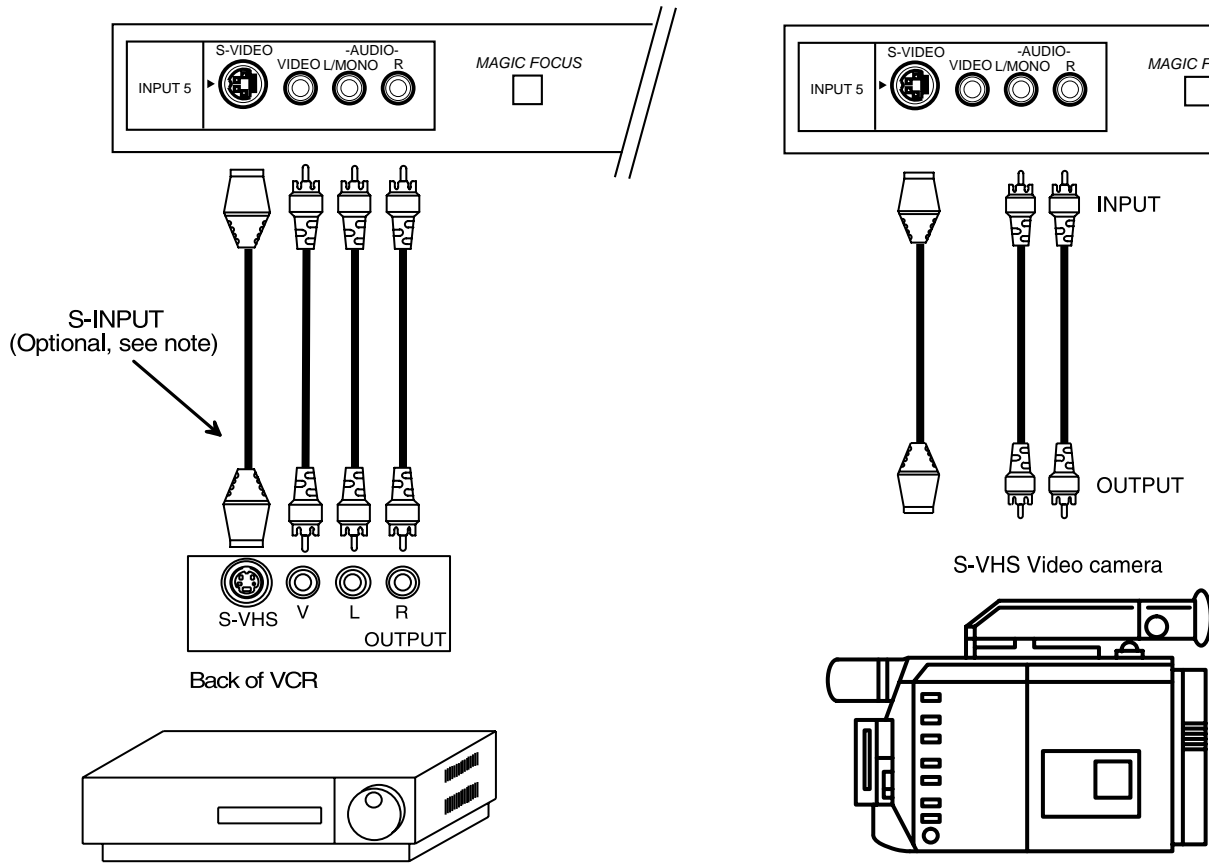

NOTE:

1. Completely insert connection cord plugs when connecting to front panel jacks. If you do not, the played back picture may be abnormal.
2. If you have a S-VHS VCR, use the S-INPUT cable in place of the standard video cable.
3. If you have a mono VCR, insert the audio cable into the left audio jack of your TV.



REAR PANEL JACKS

FIRST TIME USE

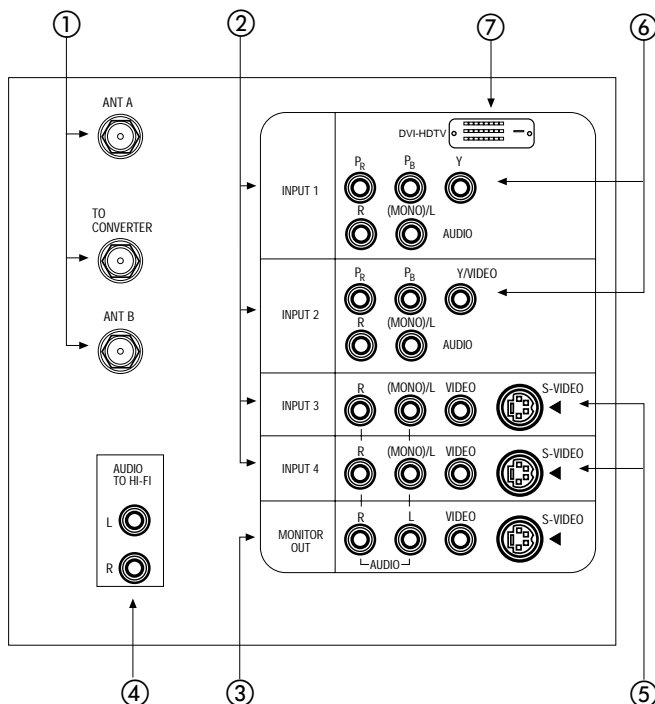

① Antenna Input/Output

The remote control allows you to switch between two separate 75-Ohm RF antenna inputs, ANT A and ANT B. ANT A input can be displayed as a main picture or sub-picture. ANT B can only be displayed as a main picture. (ANT B cannot be displayed as a sub-picture.) The antenna output labeled "TO CONVERTER" allows the ANT A connection to pass directly to a different source such as a cable box, only when ANT B is displayed as a main picture.

② Audio/Video Inputs 1, 2, 3 and 4

The VID1~VID4 buttons will select each video source each time they are pressed. Use the audio and video inputs to connect external devices, such as VCRs, camcorders, laserdisc players, DVD players etc. (If you have mono sound, insert the audio cable into the left audio jack.)

NOTE: You may use VIDEO or S-VIDEO inputs to connect to INPUT 3 and 4, but only one of these inputs may be used at a time.

③ MONITOR OUT

These jacks provide fixed audio and video signals which are used for recording. Use the S-VIDEO Output for high quality video output.

NOTE: S-VIDEO Output may be used for recording, only when the input is of S-VIDEO type.

④ AUDIO TO HI-FI Output

These jacks provide variable audio output to a separate stereo amplifier. With this connection, the audio to the stereo can be controlled by the television's main volume.

⑤ S-VIDEO Inputs 3 and 4

Inputs 3 and 4 provide S-VIDEO (Super Video) jacks for connecting equipment with S-VIDEO output capability.



⑥ Component: Y-P_BP_R Inputs

Inputs 1 and 2 provide Y-P_BP_R jacks for connecting equipment with this capability, such as a DVD player or Set Top Box. You may use composite video signal for INPUT:2.

- NOTES:**
1. Do not connect composite VIDEO and S-VIDEO to Input 3, 4 or 5 at the same time. S-VIDEO has priority over VIDEO input.
 2. Your component outputs may be labeled Y, B-Y, and R-Y. In this case, connect the components B-Y output to the TV's P_B input and the components R-Y output to the TV's P_R input.
 3. Your component outputs may be labeled Y-C_BC_R. In this case, connect the component C_B output to the TV's P_B input and the component C_R output to the TV's P_R input.
 4. It may be necessary to adjust TINT to obtain optimum picture quality when using the Y-P_BP_R inputs. (See page 35)
 5. To ensure no copyright infringement, the MONITOR OUT output will be abnormal, when using the Y-P_BP_R jacks.
 6. Input 2 (Y/VIDEO) can be used for composite video and component video input.

⑦ DVI-HDTV Input (Input 1)

Use this DVI-HDTV Input for your external devices with DVI-HDTV output such as a Set-Top-Box, high-band DTV decoders, DVD players and D-VHS with Digital Content Protection.

- NOTES:**
1. Only DTV format such as 1080i, 720p, 480i and 480p are available for DVI-HDTV input.
 2. The DVI-HDTV input is NOT compatible when used with a DVD player from a personal computer.
 3. When connecting a Set-Top-Box with a copy-protect digital out terminal, a high definition picture can be displayed on the screen in its digital form.

REAR PANEL CONNECTIONS



TYPICAL FULL-FEATURE SETUP

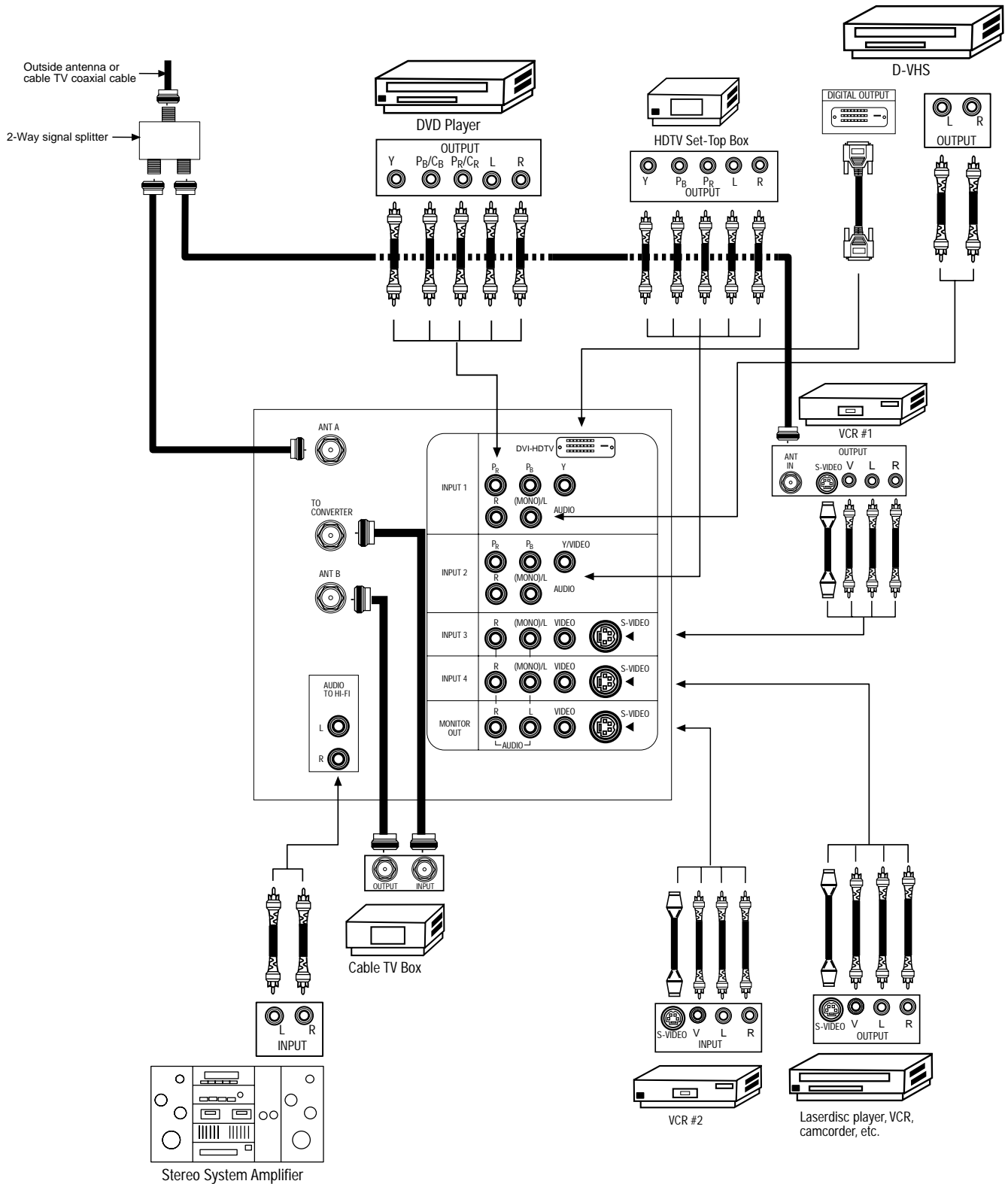

FIRST TIME USE

- NOTE:**
1. Connect only 1 component to each input jack.
 2. Follow connections that pertain to your personal entertainment system.
 3. Composite video signal can be input to Input2-Input5.
 4. Cables are not included with the purchase of this television.



TIPS ON REAR PANEL CONNECTIONS

S-VIDEO connections are provided for high performance laserdisc players, VCRs etc. that have this feature. Use these connections in place of the standard video connection if your device has this feature.

If your device has only one audio output (mono sound), connect it to the left audio jack on the television.

Refer to the operating guide of your other electronic equipment for additional information on connecting your hook-up cables.

A single VCR can be used for VCR #1 and VCR #2, but note that a VCR cannot record its own video or line output (INPUT: 3 in the example on page 11). Refer to your VCR operating guide for more information on line input-output connections.

You may use VIDEO or S-VIDEO inputs to connect to Input 3, Input 4 or Input 5, but only one of these may be used at a time.

Connect only 1 component (VCR, DVD player, camcorder, etc.) to each input jack.

COMPONENT: Y-P_BP_R (Input 1 &2) connections are provided for high performance components, such as DVD players and set-top-boxes. Use these connections in place of the standard video connection if your device has this feature. Input 2 accepts both composite and component video signals.

Your component outputs may be labeled Y, B-Y, and R-Y. In this case, connect the components B-Y output to the TV's P_B input and the components R-Y output to the TV's P_R input.

Your component outputs may be labeled Y-C_BC_R. In this case, connect the components C_B output to the TV's P_B input and the components C_R output to the TV's P_R input.

You may use composite video signal for Input 2~Input 5.

It may be necessary to adjust TINT to obtain optimum picture quality when using the Y-P_BP_R inputs. (See page 35)

To ensure no copyright infringement, the MONITOR OUT output will be abnormal, when using the Y-P_BP_R jacks.



CONNECTING EXTERNAL AUDIO DEVICES

To control the audio level of an external audio amplifier with the remote control, connect the system as shown below.

REAR PANEL OF TELEVISION

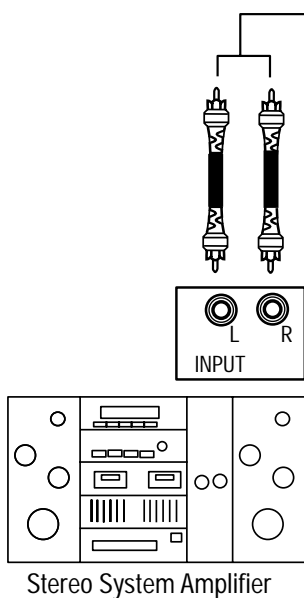
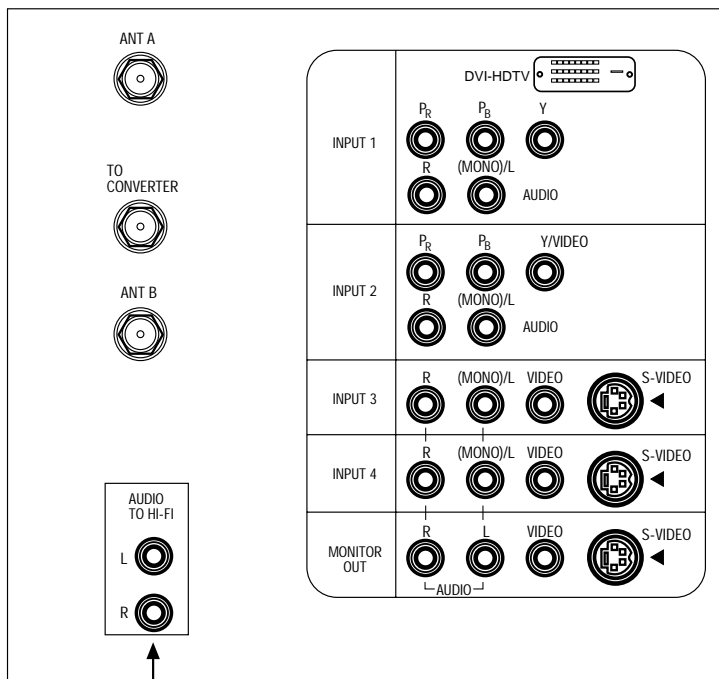

FIRST TIME USE

NOTE: 1. To prevent damage to the speaker and distorted sound, set the volume control of the audio amplifier lower and adjust the sound using the remote control of the TV set.
 2. See page 41 for AUDIO Advanced Settings.



CONNECTING EXTERNAL VIDEO SOURCES

FIRST TIME USE

The exact arrangement you use to connect the VCR, camcorder, laserdisc player, DVD player, or HDTV Set Top Box to your TV set is dependent on the model and features of each component. Check the owner's manual of each component for the location of video and audio inputs and outputs.

The following connection diagrams are offered as suggestions. However, you may need to modify them to accommodate your particular assortment of components and features. For best performance, video and audio cables should be made from coaxial shielded wire.

Before Operating External Video Source

The input mode is changed every time the VID1~VID5 button is pressed as shown below. Connect an external source to the INPUT terminal, then press the VID1~VID5 button as necessary to view the input source. (See page 22)

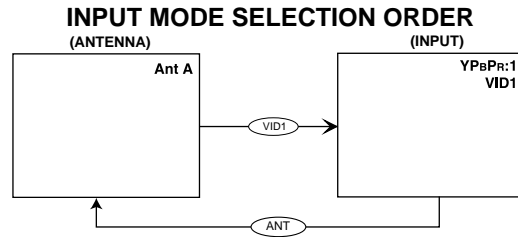

NOTE: When the TV is set to VIDEO and a video signal is not received from the VIDEO INPUT JACK on the back panel of the TV (i.e., VCR/laserdisc player, etc. is not connected or the video device is OFF), the set will appear to be OFF.



CONNECTING EXTERNAL VIDEO SOURCES

CONNECTING A MONAURAL AUDIO SOURCE TO INPUT1~INPUT5

1. Connect the cable from the VIDEO OUT of the VCR or the laserdisc player to the INPUT (VIDEO) jack, as shown on the TV set below.
2. Connect the cable from the AUDIO OUT of the VCR or the laserdisc player to the INPUT (MONO)/L(AUDIO) jack.
3. Press the VID1~VID5 button to view the program from the VCR or the laserdisc player. The VIDEO label disappears automatically after approximately four seconds.
4. Press the ANT button to return to the previous channel.

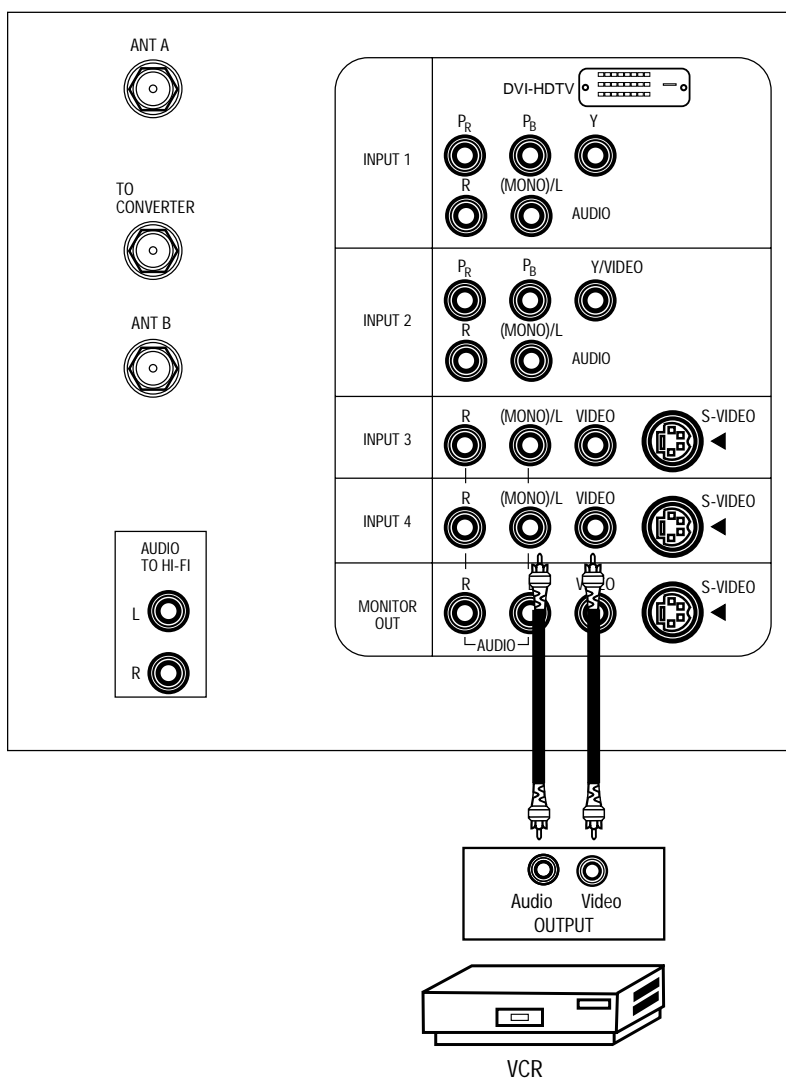

FIRST TIME USE



CONNECTING EXTERNAL VIDEO SOURCES

FIRST TIME USE

CONNECTING A STEREO SOURCE TO INPUT1-INPUT5

1. Connect the cable from the VIDEO OUT of the VCR or the laserdisc player to the INPUT (VIDEO) jack, as shown on the TV set below.
2. Connect the cable from the AUDIO OUT R of the VCR or the laserdisc player to the INPUT (AUDIO/R) jack.
3. Connect the cable from the AUDIO OUT L of the VCR or the laserdisc player to the INPUT (AUDIO/L) jack.
4. Press the VID1~VID5 button to view the program from the VCR or laserdisc player. The VIDEO label disappears automatically after approximately four seconds.
5. Press the ANT button to return to the previous channel.

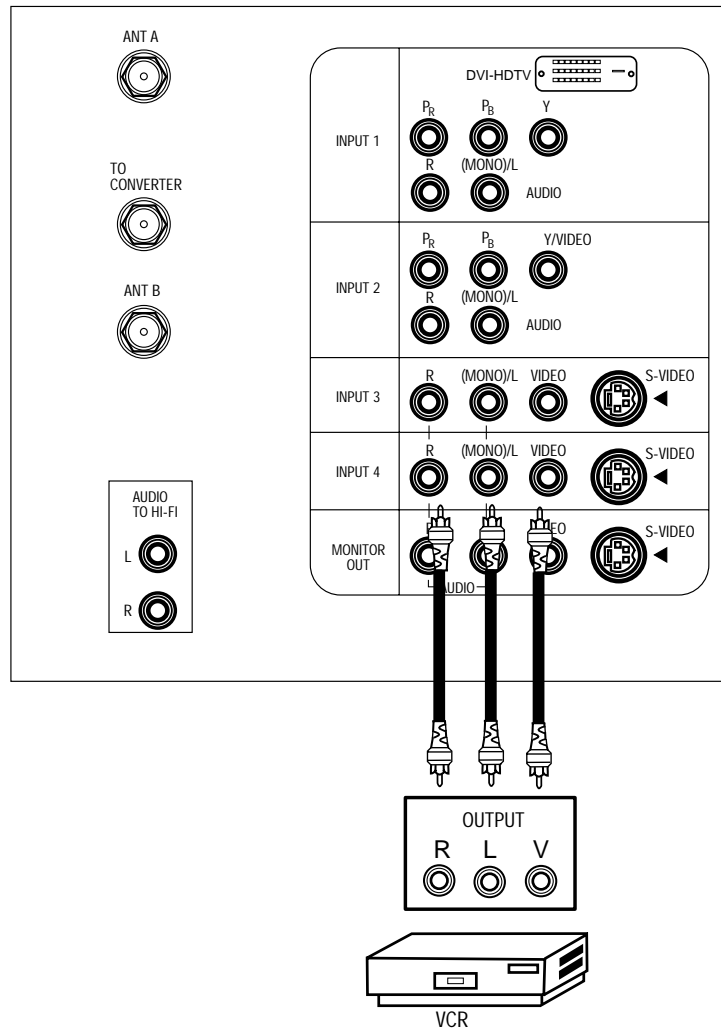

- NOTES:**
1. Completely insert the connection cord plugs when connecting to rear panel jacks. The picture and sound that is played back will be abnormal if the connection is loose.
 2. A single VCR can be used for VCR #1 and VCR #2, but note that a VCR cannot record its own video or line output. (INPUT: 3 in example on page 11) Refer to your VCR operating guide for more information on line input-output connections.



CONNECTING EXTERNAL VIDEO SOURCES

CONNECTING AN S-VIDEO SOURCE TO INPUT 3, 4 AND 5

1. Connect the cable from the S-VIDEO OUT of the VCR or the laserdisc player to the INPUT (S-VIDEO) jack, as shown on the TV set below.
2. Connect the cable from the AUDIO OUT R of the VCR or the laserdisc player to the INPUT (AUDIO/R) jack.
3. Connect the cable from the AUDIO OUT L of the VCR or the laserdisc player to the INPUT (AUDIO/L) jack.
4. Press the VID3~VID5 button to view the program from the VCR or laserdisc player. The VIDEO label disappears automatically after approximately four seconds.
5. Press the ANT button to return to the previous channel.

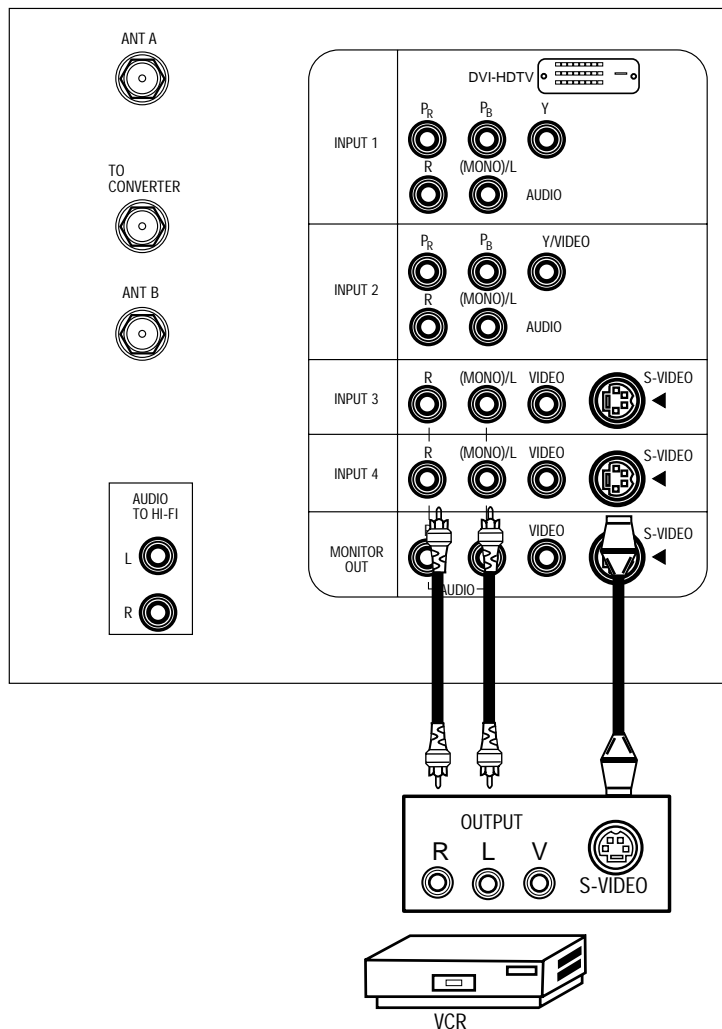

NOTES:

1. Completely insert the connection cord plugs when connecting to rear panel jacks. The picture and sound that is played back will be abnormal if the connection is loose.
2. A single VCR can be used for VCR #1 and VCR #2, but note that a VCR cannot record its own video or line output. (INPUT: 3 in example on page 11) Refer to your VCR operating guide for more information on line input-output connections.



CONNECTING EXTERNAL VIDEO SOURCES

FIRST TIME USE

CONNECTING A COMPONENT SOURCE WITH DVI-HDTV CAPABILITY TO INPUT 1.

1. Connect the DVI connection cable from the output of the HDTV set top box or DVD player to the DVI-HDTV input as shown on the TV set at right.
2. Connect the cable from the AUDIO OUT R of the HDTV set top box or DVD player to the INPUT (AUDIO/R) jack.
3. Connect the cable from the AUDIO OUT L of the HDTV set top box or DVD player to the INPUT (AUDIO/L) jack.
4. Press the VID1 button to view the program from the HDTV set top box or DVD player. The VIDEO label disappears automatically after approximately four seconds.
5. Press ANT button to return to the previous channel.

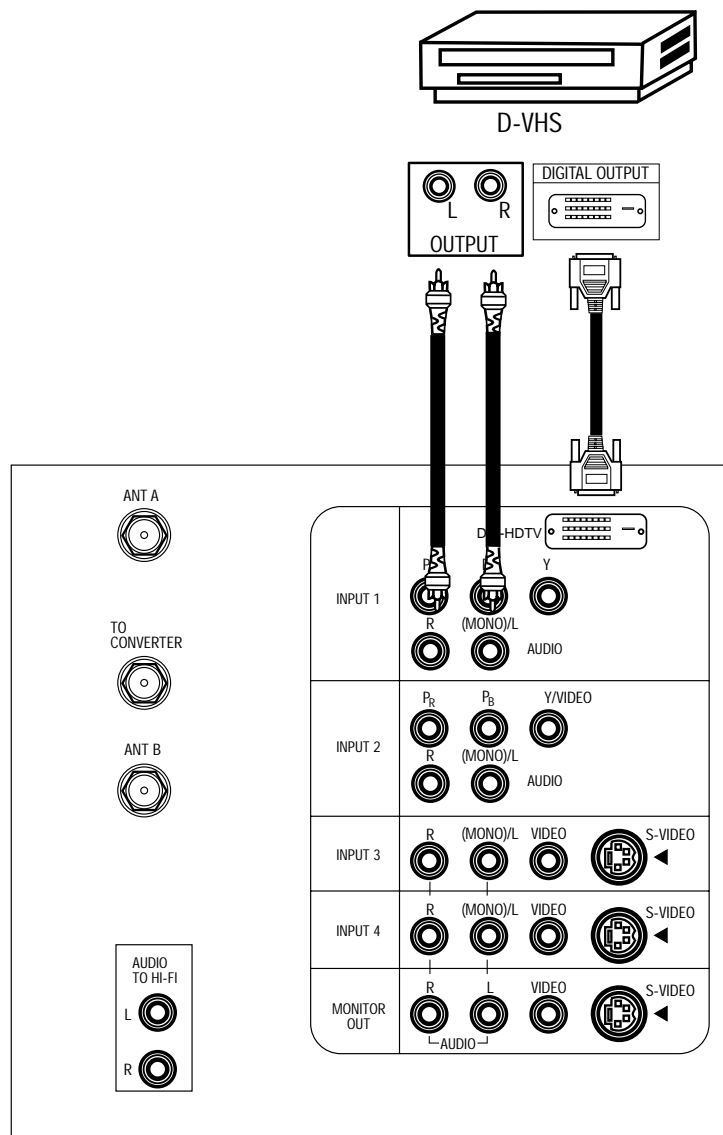



CONNECTING EXTERNAL VIDEO SOURCES

FIRST TIME USE

CONNECTING A COMPONENT SOURCE TO INPUT 1 OR 2: Y-P_BP_R.

1. Connect the cable from the Y OUT of the Laserdisc/DVD player or HDTV set top box to the INPUT (Y) jack, as shown on the TV set at right.
2. Connect the cable from the C_B/P_B OUT or B-Y OUT of the Laserdisc/DVD player or HDTV set top box to the INPUT (P_B) jack.
3. Connect the cable from the C_R/P_R OUT or R-Y OUT of the Laserdisc/DVD player or HDTV set top box to the INPUT (P_R) jack.
4. Connect the cable from the AUDIO OUT R of the Laserdisc/DVD player or HDTV set top box to the INPUT (AUDIO/R) jack.
5. Connect the cable from the AUDIO OUT L of the Laserdisc/DVD player or HDTV set top box to the INPUT (AUDIO/L) jack.
6. Press the VID1~VID2 button, to view the program from the Laserdisc/DVD player or HDTV set top box. The VIDEO label disappears automatically after approximately four seconds.
7. Press the ANT button to return to the previous channel.

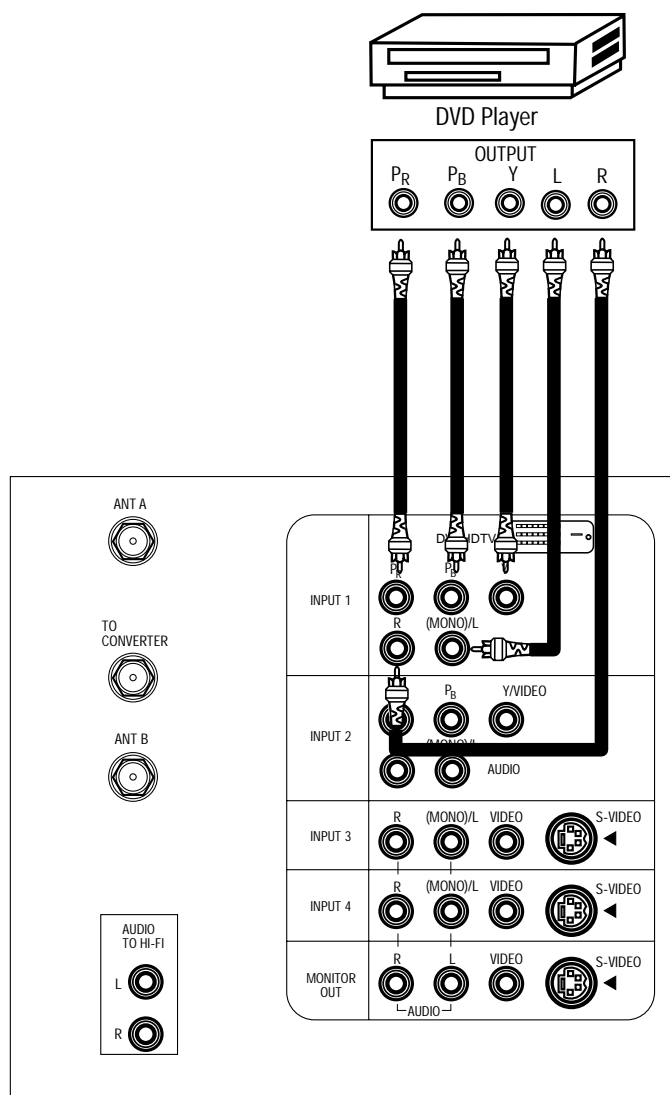

- NOTE:**
1. Completely insert the connection cord plugs when connecting to rear panel jacks. The picture and sound that is played back will be abnormal if the connection is loose.
 2. See page 12 for tips on REAR PANEL CONNECTIONS.



THE REMOTE CONTROL

In addition to controlling all the functions on your HITACHI Projection TV, the new remote control is designed to operate different types of VCRs, CBL (Cable TV) converters, satellite receiver, DVD players, and other audio/video equipment with one touch. Basic operation keys are grouped together in one area.

To operate your TV, point the remote control at the screen of the TV and press the TV button. The remote will now control your television.

To operate your cable/satellite box, point the remote at the remote sensor of the cable/satellite box and press the CABLE/SATELLITE (CBL/SAT) button. The remote will now control your cable/satellite box. (See page 29 for instructions on how to program the remote to control your cable box.)

To operate your DVD/VCR player, point the remote at the remote sensor of the DVD/VCR player and press the DVD/VCR button. The remote will now control your DVD/VCR player. (See pages 28 and 30 for instruction on how to program the remote to control your DVD/VCR player.)

THE REMOTE CONTROL

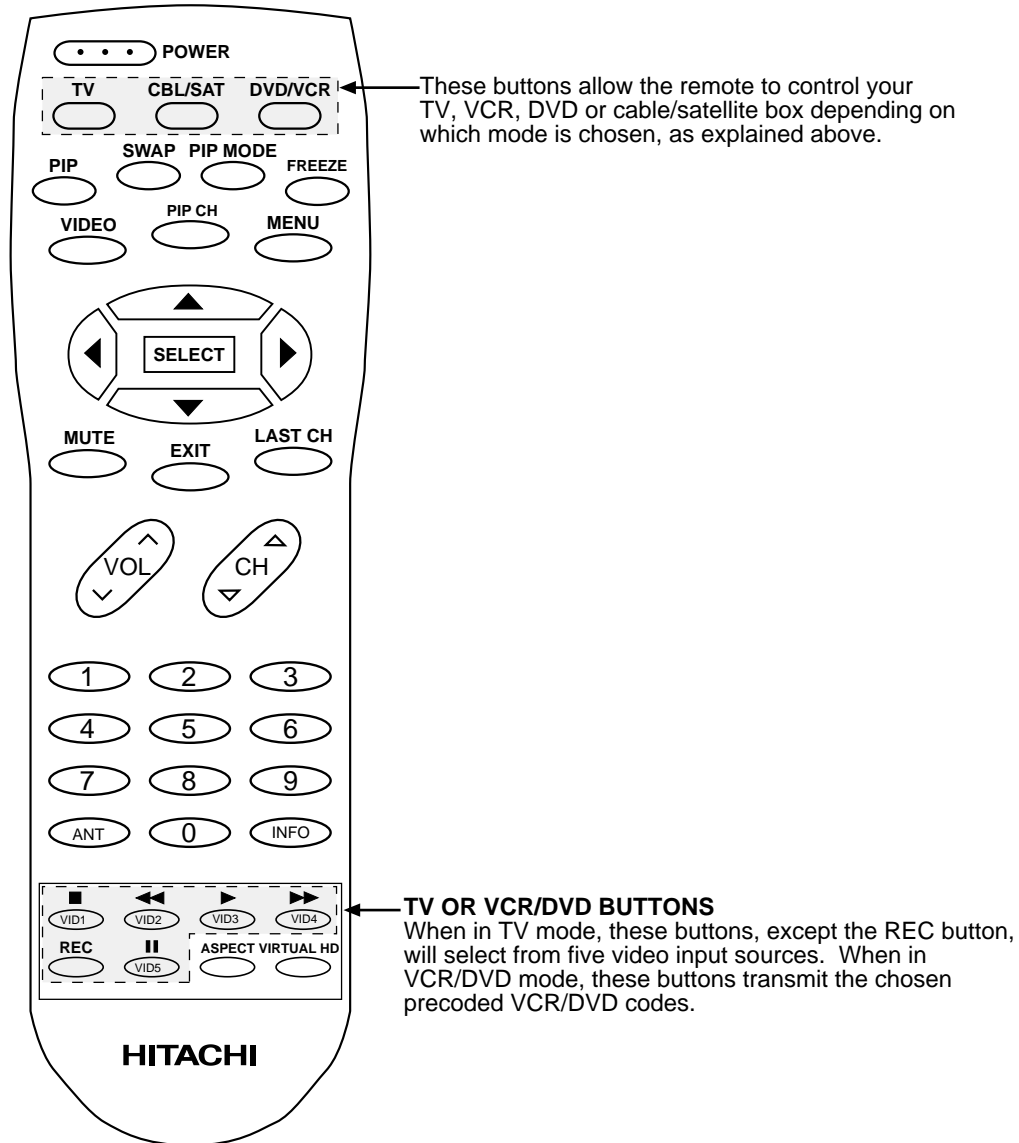

HOW TO USE THE REMOTE TO CONTROL YOUR TV

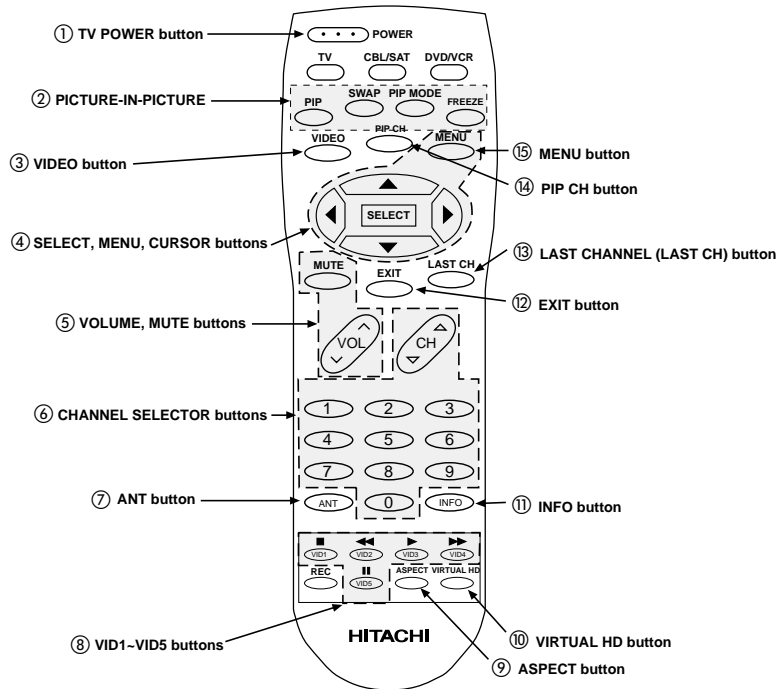

- ① **POWER button**
Press this button to turn the TV set on or off when the remote is in TV mode.
- ② **PICTURE-IN-PICTURE buttons**
See separate section on pages 25, 26 and 27 for description.
- ③ **VIDEO button**
Press this button to directly access the VIDEO adjustment menu.

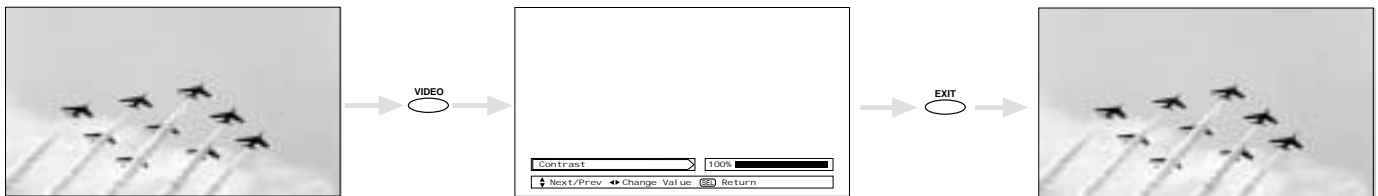

- ④ **SELECT, MENU, CURSOR buttons**
All the On-Screen Display features can be set or adjusted by using the CURSOR buttons, except for numeric entries. The CURSOR will highlight functions or adjust and set different features. Press the CURSOR toward desired direction then press the SELECT button to select.

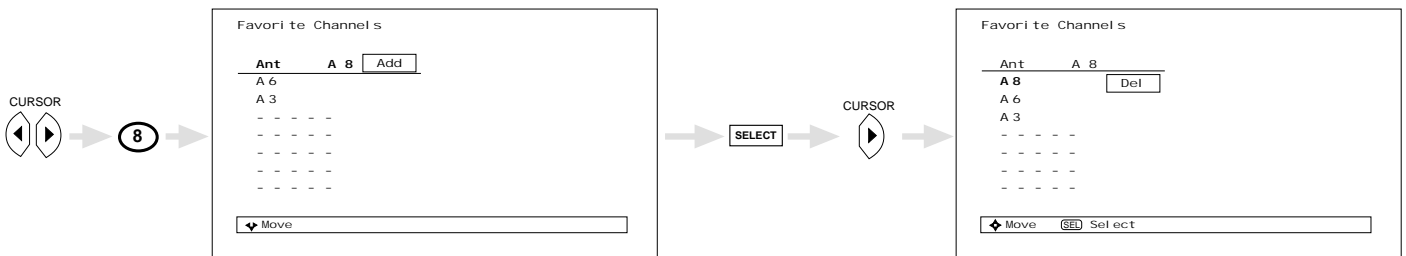

When no on-screen displays are on the TV screen, use CURSOR ◀ or ▶ to access the Favorite Channels feature.

To add channels to Favorite Channels, use the number keys to enter the channel number. Use CURSOR ▶ to highlight "Add", then press SELECT to store the channel to the Favorite Channel feature.

To delete (Del) the channel from the Favorite Channel, use CURSOR ▲, ▼ to highlight the channel, then CURSOR ▶ to highlight Delete (Del) and press SELECT to delete.

To view a Favorite Channel use CURSOR ▲, ▼ to highlight the channel and press SELECT to view.



HOW TO USE THE REMOTE TO CONTROL YOUR TV

⑤ VOLUME, MUTE button

Press the VOLUME up (▲) or down (▼) button until you obtain the desired sound level.

To reduce the sound to one half of normal volume (SOFT MUTE) to answer the telephone, etc., press the MUTE button. Press the MUTE button again to turn the sound off completely (MUTE). To restore the sound, press the MUTE button one more time, or press the VOLUME Up (▲) button.

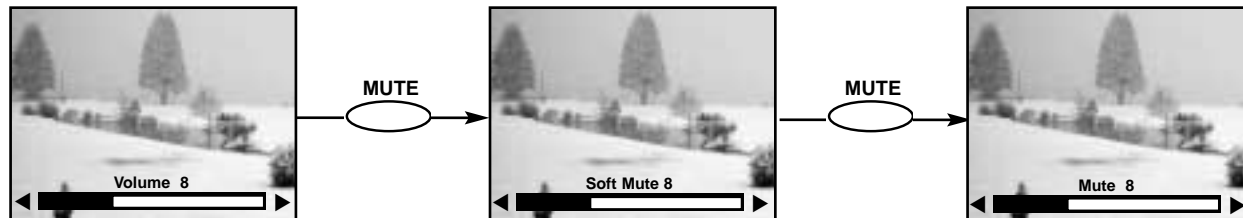

Closed Captioning will display when MUTE/SOFT MUTE is on and Closed Caption is set to AUTO (See page 56).

⑥ CHANNEL selector buttons

CHANNEL selector buttons are used to select channels, lock access code, etc.

Enter one, two, or three numbers to select channels. Enter "0" first for channels 1 to 9, or simply press the single digit channel you wish to tune then wait a few seconds for the TV to tune. For channels 100 and above, press the "1" button, wait until two dashes appear next to the channel display on your TV, then enter the remaining two numbers using the number buttons.

Channel selection may also be performed by pressing CH up (▲) or down (▼).

NOTE: The TV may not receive some channels if you are not in the correct ANTENNA/CABLE mode. (see page 51)

⑦ ANTENNA button

The ANT button will select between Antenna A and Antenna B each time the button is pressed.

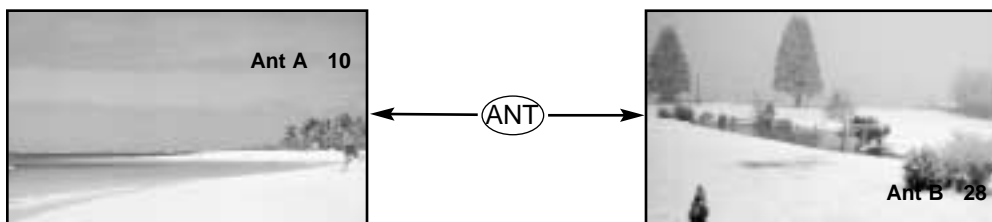

⑧ VID1 ~ VID5

When the remote control is in TV mode, press these buttons to directly select the video input sources between the five video inputs. When the remote control is in Set-Top-Box mode (STB) these buttons will control the Set-Top-Box or satellite receiver, and execute the secondary function labeled.

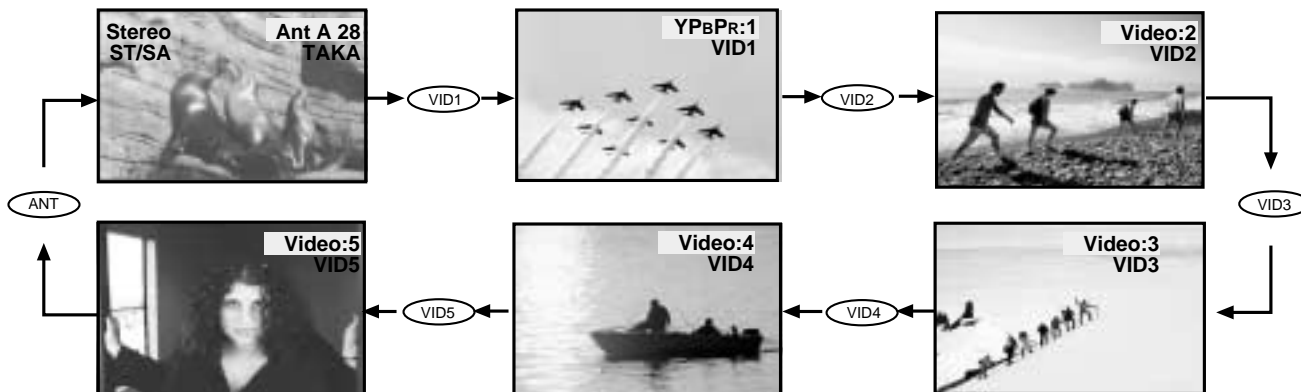

HOW TO USE THE REMOTE TO CONTROL YOUR TV



9 ASPECT button

Press this button to quickly change the picture format ASPECT ratio.

Depending on the input signal, the picture format ratio allows you to adjust the images through the following options.

- 4:3 STANDARD Use this aspect mode to display conventional (4:3) images. Side panels (gray areas) are placed to the left and right of the image to preserve the original aspect ratio of the source. Note: Use this mode for only 15% of your total viewing time to prevent uneven aging of the phosphors. Phosphors in the lighted area of the picture will age more rapidly than the gray areas.
- 4:3 EXPANDED Use this aspect mode to display conventional (4:3) sources by expanding the outer edges of the image to fill the 16:9 screen. The center of the image remains unaltered.
- 4:3 Zoom1/Zoom2 Use these aspect modes to zoom in on conventional (4:3) sources.
- 16:9 STANDARD Use this aspect mode to display 16:9 sources like HDTV and DVD's preserving the original 16:9 aspect ratio.
- 16:9 Zoom Use this aspect to Zoom-in once while in 16:9 aspect.

(1) NTSC Input

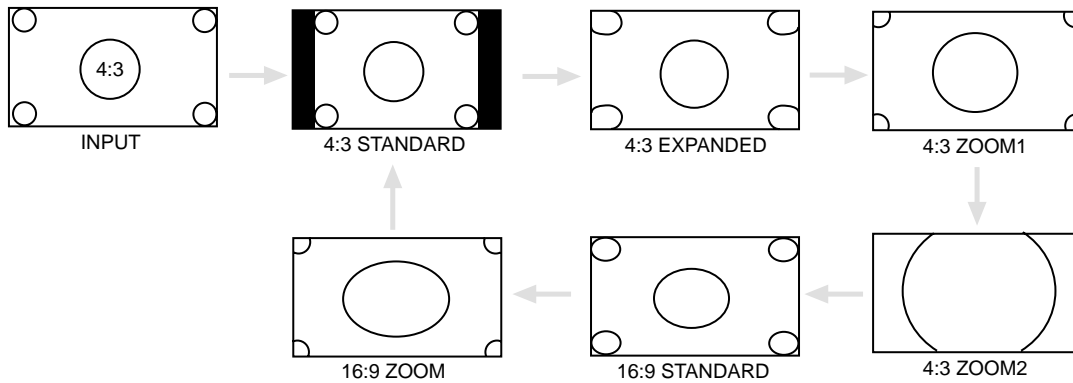

(2) 480i/480p INPUT

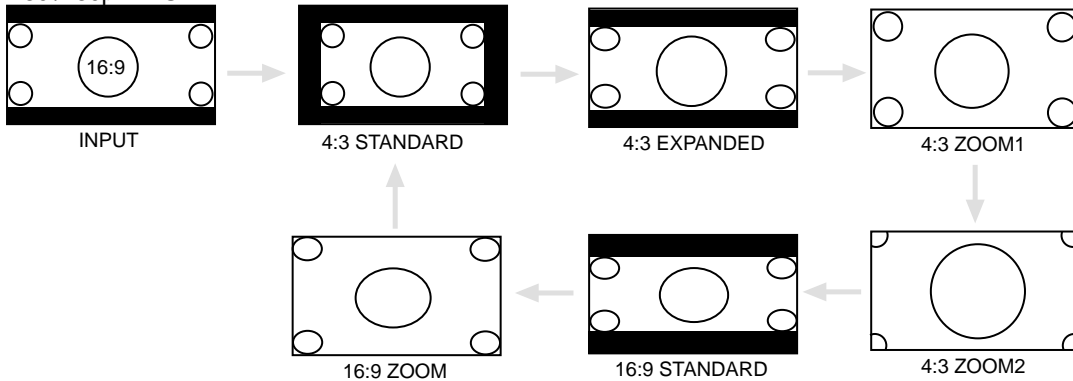

(3) 720p/1080i INPUT

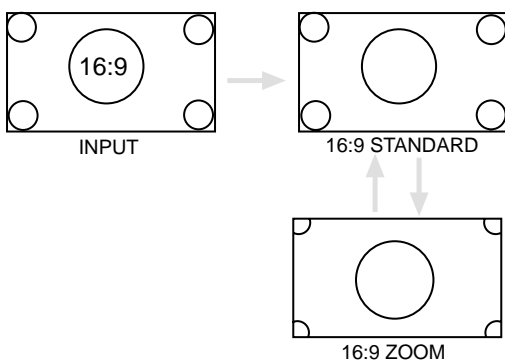



HOW TO USE THE REMOTE TO CONTROL YOUR TV

10 VIRTUAL HD button

Press this button to toggle between 1080i and 540p.

540p and 1080i represent two ways to display the TV signal.

- Progressive: The “p” in 540p tells you that the display is showing you the picture in the progressive format. With the progressive format the complete picture is created by drawing lines across the screen from left to right which fill the screen from the top to bottom. If you look very closely at the screen there will be a very small space in between each line. The progressive format is good for displaying fast moving programs such as a sporting event.
- Interlaced: The “i” in 1080i tells you that the display is showing you the picture in the interlaced format. With the interlaced format the picture is created by drawing lines across the screen from left to right which fill the screen from top to bottom, and then returning to the top and drawing another set of lines in between the first set. The TV draws the lines so fast that our eyes can’t see them. If you look very closely at the screen you will notice a smoother image than with the progressive format. The interlace format is good for displaying detailed images like feature films.
- You can compare the progressive and interlaced formats by toggling the “VIRTUAL HD” button on the remote control. Some people like the crisp picture from 540p and some people like the smooth and detailed 1080i. Hitachi offers you the choice.

Note: The VIRTUAL HD button will not change the picture with a 1080i HDTV input. HDTV signals bypass the VIRTUAL HD circuitry and are shown in their native 1080i format.

11 INFO button

Press this button when you want to check the channel being received, the picture source, if the channel has stereo (ST) or second audio program (SAP), the time and CHANNEL ID.

THE REMOTE CONTROL

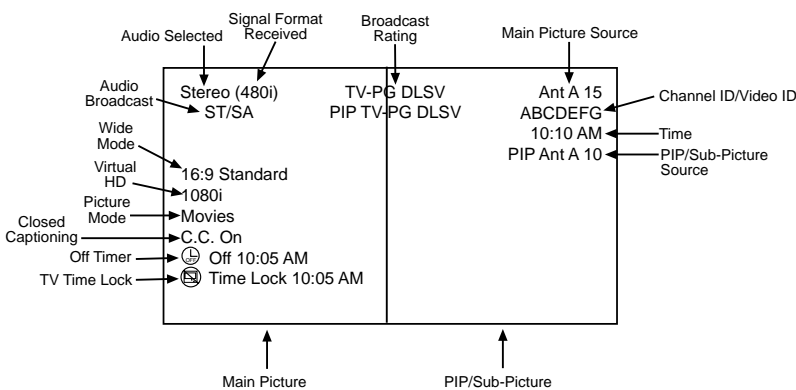

When a COMPONENT VIDEO: Y-P_B-P_R Input is connected to VIDEO: 1.



When an S-VIDEO Input is connected to VIDEO: 3.

12 EXIT button

When in MENU mode, this button will exit all On-Screen Displays.

13 LAST CHANNEL (LAST CH) button

Use this button to select between the last two channels viewed. (Good for watching two sporting events, etc.)

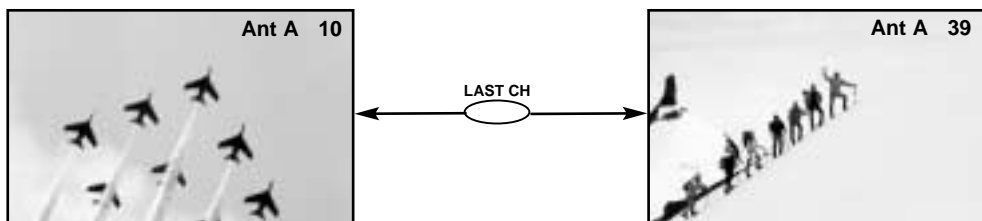

14 PIP CH button

Use the PIP CH button to select between main picture and sub-picture tuning. The channel number which is highlighted indicates what channel is being controlled.

15 MENU button

The MENU button will start the On-Screen Display.

PICTURE-IN-PICTURE (PIP)



Your HITACHI Projection TV incorporates Dual Tuner technology designed for improved viewing enjoyment. This Dual Tuner feature allows you to view antenna inputs on both the main picture and sub-picture simultaneously, with separate tuning control for each. The Dual Tuner can operate with only one input (ANT A only) or two inputs (ANT A and ANT B).

ANT A input can be viewed as both the main picture and the sub-picture simultaneously. ANT B can only be viewed as a main picture. To select between main picture and PIP sub-picture tuning, press the PIP CH button on the remote. The green highlighted channel display will move with every press of the PIP CH button. When the top channel display is highlighted, channel tuning is for the main picture. When the lower channel display is highlighted, channel tuning is for the PIP sub-picture.

The Picture-in-Picture feature is convenient when you want to watch more than one program at the same time. You can watch a TV program while viewing other programs from the ANT A source or any of the video inputs.

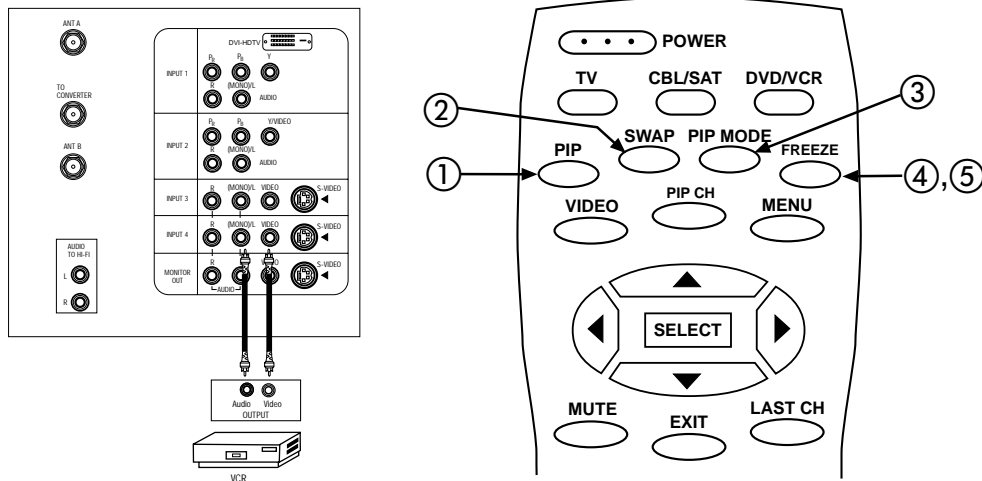

Use above connection to view VCR program as a sub-picture while viewing another program as main picture (ANT A, ANT B, V:1, V:2, V:3, V:4, or V:5). You may also view the VCR program as a main picture while viewing another program as a sub-picture (ANT A, V:1, V:2, V:3, V:4, or V:5).

① PIP button

Press the PIP button and a sub-picture will appear in one of the four different modes (POP, PIP, SPLIT or SURF), depending on the last selection of the PIP mode. To change the PIP mode, use the PIP MODE button to cycle through the four different modes.

POP MODE PICTURE-IN-PICTURE

Press the PIP button and a sub-picture appears in one of the four different modes (POP, PIP, SPLIT or SURF), depending on the last selection of the PIP mode. Press the PIP button again to remove the sub-picture from the screen. Use the PIP CH button to select between main and sub-picture tuning control (indicated by green highlighted channel display.) Press the VID1, VID2, VID3, VID4 or VID5 button when sub-picture channel tuning is being controlled, to change between VIDEO: 1, VIDEO: 2, VIDEO: 3, VIDEO:4 and VIDEO:5 and ANT:A source. (ANT B source cannot be viewed as a sub-picture.)

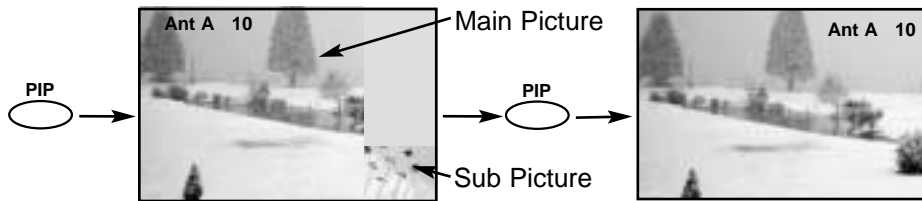

- NOTES:**
1. When ANT B is selected as the main channel, the SWAP feature is disabled.
 2. In POP mode, CURSOR ▲, ▼ will move the sub-picture up/down.
 3. Only Sound from the main picture can be heard.

PIP MODE PICTURE-IN-PICTURE (This feature is only available in 1080i input signal)

To prevent a pattern burn, occasionally move the sub-picture using the CURSOR ◀, ▶, ▲, ▼.

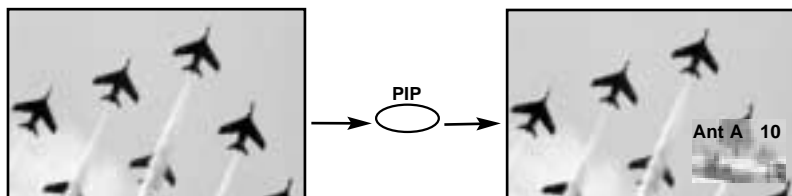

THE REMOTE CONTROL



PICTURE-IN-PICTURE (PIP)

SPLIT MODE PICTURE-IN-PICTURE

Split Mode PIP displays the main picture and sub-picture evenly on the screen.



SURF MODE PICTURE-IN-PICTURE

This feature will automatically scan all active channel numbers (those set in memory) and display them as PIP sub-pictures. Press the PIP button a second time to remove the sub-pictures from the screen.



- NOTES:**
1. If no buttons are pressed when in SURF mode, auto-scanning will continuously scan channels in memory. (see page 42)
 2. If a channel is tuned during this SURF scanning, sub-pictures will be removed from the screen.
 3. SURF MODE PIP is allowed only when ANT A is selected as the main channel.
 4. If MOVIE/TV RATINGS lock functions setting is ON, SURF mode will be deactivated.
 5. Closed Caption will not appear when SURF mode is on.

② SWAP button

If you wish to switch what is being shown on the main picture to the sub-picture, press the SWAP button.

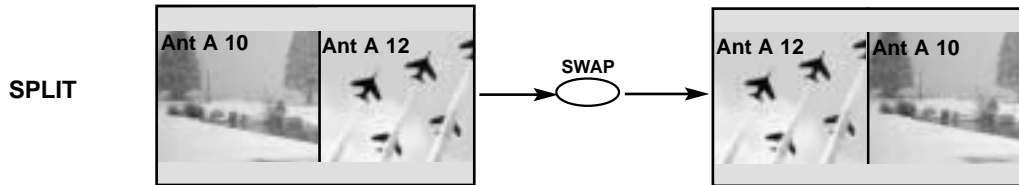

- NOTES:**
1. The SWAP button will only operate in POP/SPLIT PIP mode.
 2. The SWAP function will not operate if ANT B input is set as the main channel (ANT B input cannot be displayed as a sub-picture.)

③ PIP MODE button

To change between the different PIP modes (POP, PIP, SPLIT or SURF) press the PIP MODE button when PIP is ON. Each press of this button will change PIP to a different mode.

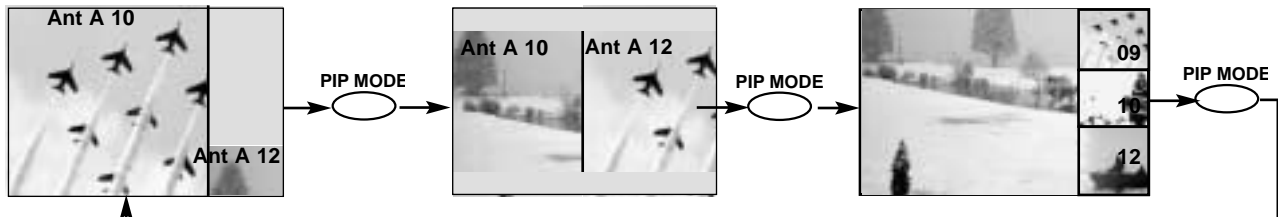

PIP MODES will depend on the type of input signal.

PICTURE-IN-PICTURE (PIP) MODES

	POP	PIP	SPLIT	SURF
NTSC (ANT A/B)	YES	x	YES	ANT A
480i	YES	x	YES	x
480p	x	x	YES	x
720p	x	x	YES	x
1080i	x	YES	YES	x



PICTURE-IN-PICTURE (PIP)

④ FREEZE button (With PIP ON)

If you wish to freeze the sub-picture, press the FREEZE button. This is convenient when trying to write down the address for a mail order company, recording statistics for a sporting event, etc. To return the picture to motion, press the FREEZE button again.

NOTE: When PIP is on, the FREEZE function will only operate when POP/PIP/SPLIT mode is chosen.

⑤ FREEZE button (with PIP OFF)

Press the FREEZE button to freeze the picture, depending on the PIP mode selected (POP Sub Freeze, SPLIT or STROBE). To change FREEZE modes, use the PIP MODE button to cycle through the three different modes.

POP SUB FREEZE (with PIP OFF)

PIP should be in POP mode. Press the FREEZE button to freeze. Press the FREEZE button again to return to normal viewing.

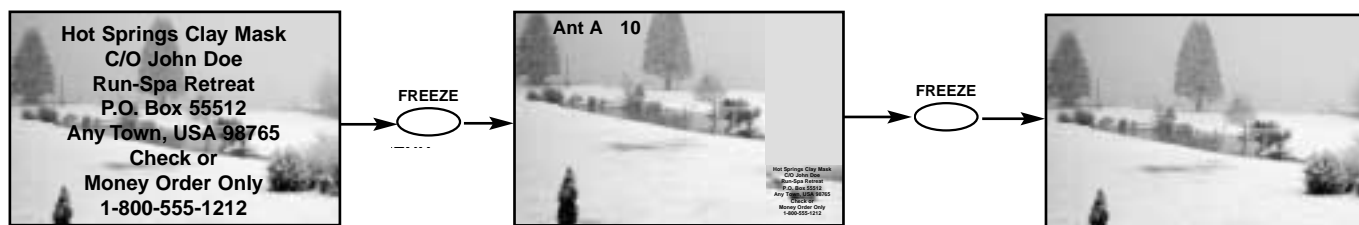

SPLIT FREEZE(with PIP OFF)

PIP should be in SPLIT mode. Press the FREEZE button to freeze the picture you are currently viewing (only the right sub-picture will freeze). Press the FREEZE button again and press the PIP button to return to normal viewing.

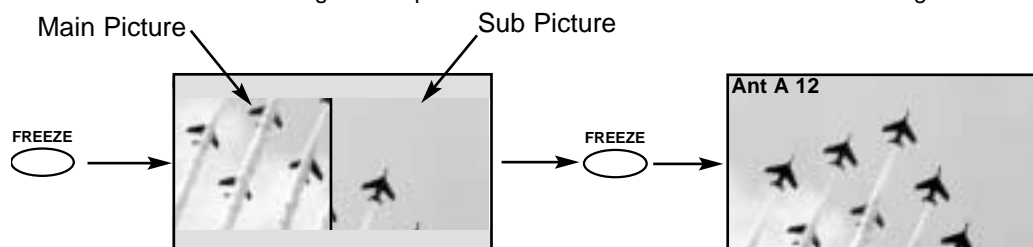

STROBE FREEZE(with PIP OFF)

PIP should be in SURF mode. Press the FREEZE button to freeze three frames of the picture you are currently viewing. Press this button again or PIP to return to normal viewing. This feature is useful for viewing a moving picture that has many details, for example, a close play in a sporting event or a golf swing.

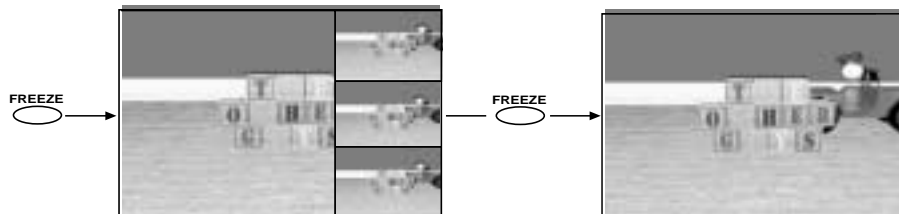

NOTES: Each freeze frame is delayed about 0.1 (1/10) second.

THE REMOTE CONTROL



USING THE REMOTE TO CONTROL VCR FUNCTIONS

Operating the precoded function for your VCR.

This remote is designed to operate different types of VCRs. You must first program the remote to match the remote system of your VCR. (refer to page 31 for pre-codes)

1. Turn ON your VCR.
2. Aim the remote control at the front of your VCR.
3. Press and release the DVD/VCR button to switch to VCR pre-coded mode.
4. Hold down the DVD/VCR button on the remote and enter the two digit preset code that matches your VCR, as shown on page 31.
5. Aim the remote at the VCR and press the POWER button. The remote will turn off your VCR when the correct two digit preset code is entered. When this occurs, the remote control is programmed for your VCR. If the VCR does not turn off, try a different two digit preset code.
6. The remote will now control your VCR.

NOTES:

1. If your VCR cannot be operated after performing the above procedures, your VCR's code has not been precoded into the remote.
2. In the unlikely event that your VCR cannot be operated after performing the above procedures, please consult your VCR operating guide.
3. The remote control will remember the codes you have programmed until the batteries are removed from the remote control. After replacing the batteries repeat the entire programming procedure as stated above.

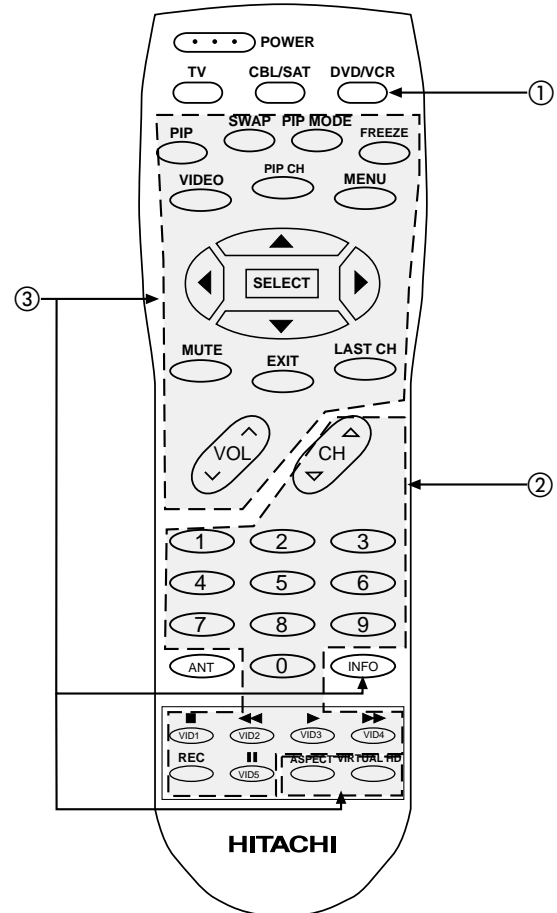

THE REMOTE CONTROL

① DVD/VCR Button

This button allows the remote to control your VCR by setting it to VCR mode.

② PRECODED VCR Buttons

These buttons transmit the chosen precoded VCR codes. For some VCRs, you must press the RECORD button twice to record a program.

③ EXCLUSIVE TV Buttons

These buttons are for operating the TV.

MY VCR CODE IS: _____

NOTE: Refer to instruction manual of the VCR for operation of the buttons exclusively for the VCR.

USING THE REMOTE TO CONTROL CABLE/SATELLITE BOX FUNCTIONS



Operating the precoded function for your cable/satellite box.

This remote is designed to operate different types of cable/satellite boxes. You must first program the remote to match the remote system of your cable/satellite box. (refer to page 31)

1. Turn ON your cable/satellite box.
2. Aim the remote control at the front of your cable/satellite box.
3. Press and release the cable/satellite (CBL/SAT) button to switch to cable/satellite pre-coded mode.
4. Hold down the CBL/SAT button on the remote and enter the two digit preset code that matches your cable/satellite box as shown on page 31.
5. Aim the remote at the cable/satellite box and press the POWER button. The remote will turn off your cable/satellite box when the correct two digit preset code is entered. When this occurs, the remote control is programmed for your cable/satellite box. If the box does not turn off, try a different two digit preset code.
6. The remote will now control your cable/satellite box.

NOTES:

1. If your cable/satellite box cannot be operated after performing the above procedures, your cable/satellite box code has not been precoded into the remote.
2. In the unlikely event that your cable/satellite box cannot be operated after performing the above procedures, please consult your cable/satellite box operating guide.
3. The remote control will remember the codes you have programmed until the batteries are removed from the remote control. After replacing the batteries repeat the entire programming procedure as stated above.

- ① **CABLE (CBL/SAT) button**
This button allows the remote to control your cable/satellite box by setting it to CABLE/SATELLITE mode.
- ② **PRECODED CABLE/SATELLITE BOX buttons**
These buttons transmit the chosen precoded cable/satellite codes.
- ③ **EXCLUSIVE TV buttons**
These buttons are for operating the TV.

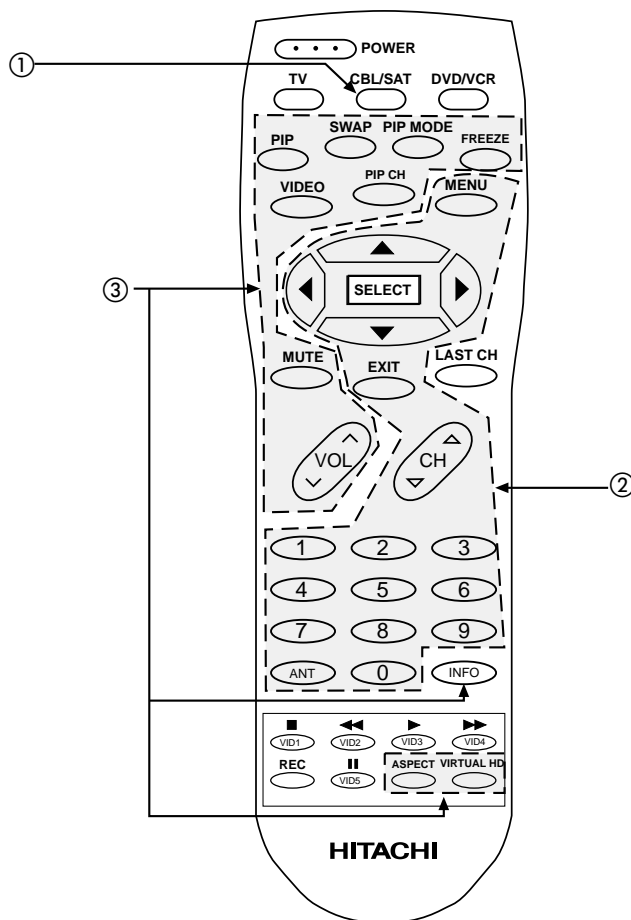

THE REMOTE CONTROL

MY CABLE/SATELLITE BOX CODE IS: _____

NOTE: Refer to instruction manual of the Cable/Satellite Box for operation of the buttons exclusively for the Cable/Satellite Box.



USING THE REMOTE TO CONTROL DVD FUNCTIONS

Operating the precoded function for your DVD player.

This remote is designed to operate different types of DVD players. You must first program the remote to match the remote system of your DVD player. (refer to page 31 for pre-codes)

1. Turn ON your DVD player.
2. Aim the remote control at the front of your DVD player.
3. Press and release the DVD/VCR button to switch to DVD pre-coded mode.
4. Hold down the DVD/VCR button on the remote and enter the two digit preset code that matches your DVD player, as shown on page 31.
5. Aim the remote at the DVD player and press the POWER button. The remote will turn off your DVD player when the correct two digit preset code is entered. When this occurs, the remote control is programmed for your DVD player. If the DVD player does not turn off, try a different two digit preset code.
6. The remote will now control your DVD player.

THE REMOTE CONTROL

NOTES:

1. If your DVD player cannot be operated after performing the above procedures, your DVD player's code has not been precoded into the remote.
2. In the unlikely event that your DVD player cannot be operated after performing the above procedures, please consult your DVD player operating guide.
3. The remote control will remember the codes you have programmed until the batteries are removed from the remote control. After replacing the batteries repeat the entire programming procedure as stated above.

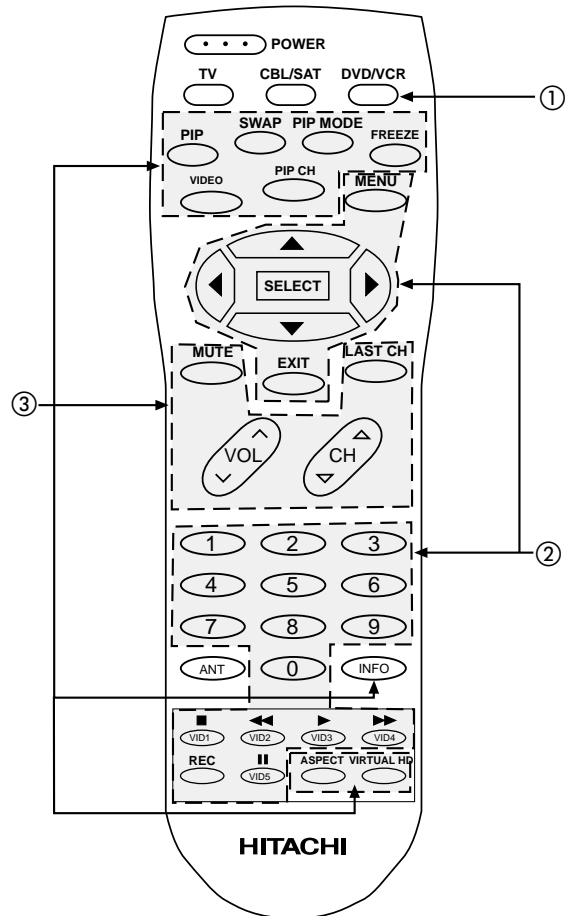

- ① **DVD/VCR Button**
This button allows the remote to control your DVD player by setting it to DVD mode.
- ② **PRECODED DVD Buttons**
These buttons transmit the chosen precoded DVD codes.
- ③ **EXCLUSIVE TV Buttons**
These buttons are for operating the TV.

MY DVD PLAYER CODE IS: _____

NOTE: Refer to instruction manual of the DVD player for operation of the buttons exclusively for the DVD player.

CABLE, SATELLITE, VCR AND DVD CODES FOR REMOTE CONTROL



CABLE BRAND	CODE
General Instrument	.17
Hamlin	.22,23,24,25
Jerold	.00,01,02,03,04,05,06,07,21
Oak	.26,27,28
Panasonic	.18,19,20
Pioneer	.13,14
Scientific Atlanta	.08,09,10
Tocom	.15,16
Zenith	.11,12

SATELLITE BRAND	CODE
Ecostar	.32
Hitachi	.29
Hughes	.33
Panasonic	.34
RCA	.30, 35
Samsung	.36
Sony	.31

VCR BRAND	CODE
Aiwa	.48
Daewoo	.45
Emerson	.20,21,22,23,24
Fisher	.34,37,38,39
Funai	.52
General Electric	.33
Goldstar	.36
Hitachi	.00,01,02,03,04,05,06
JVC	.18,49,50,51
Magnavox	.12,13, 14
Mitsubishi	.27,28,29,30
NEC	.40,41
Panasonic	.10,11
Philips	.14
Samsung	.17,25,26
Scott	.16
Sharp	.31,32
Shintom	.19
Sony	.07,08,09
Symphonic	.42
Teknica	.46
Toshiba	.15

DVD BRAND	CODE
Hitachi	.53, 59, 60
Panasonic	.55
Pioneer	.56
RCA	.57
Samsung	.59
Sanyo	.60
Sony	.54
Toshiba	.58

ON-SCREEN DISPLAY (OSD)

1. Press MENU on the remote control to display the different features on your HITACHI Projection TV.
2. Press the CURSOR ◀, ▶, ▲, ▼ to highlight a different feature.
3. Press EXIT on the remote control to quickly exit from a menu.
4. Press CURSOR ◀ or ▶ to access Favorite Channels menu.

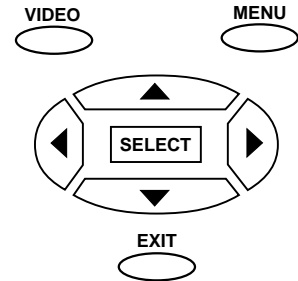

This part of the screen shows which selections are available.

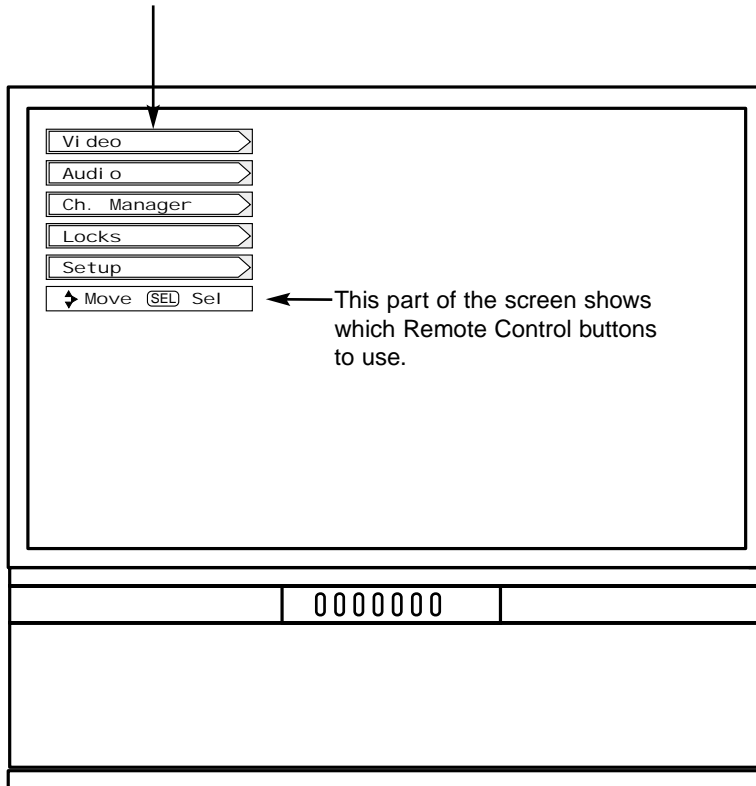

ON-SCREEN DISPLAY (OSD)

Video	Picture Mode	Select between the four picture modes: Sports, Movies, News, and Music.
	Contrast	Adjust contrast.
	Brightness	Adjust brightness.
	Color	Adjust color.
	Tint	Adjust tint.
	Sharpness	Adjust sharpness.
	Vertical Position	Centering top and bottom of the picture.
	Magic Focus	Automatic or manual alignment of the Red, Green and Blue colors to make white.
	Color System	Automatically change tint and color coordinates for DTV program.
	Advanced Settings	Improve picture performance.

Audio	Treble	Adjust the treble.
	Bass	Adjust the bass.
	Balance	Adjust the balance.
	Sound Enhancement	Set SRS and BBE surround settings.
	Advanced Settings	Improve sound performance.

Channel Manager	Ant A	View/edit Channel ID, Scan, and Lock settings in antenna A.
	Ant B	View/edit Channel ID, Scan, and Lock settings in antenna B.

Locks	Change Access Code	Change Lock access code.
	Engage Lock	Choose to lock channel, video input, and front panel.
	TV Time Lock	Set specific time to Lock TV.
	Movie Ratings	Block various types of movies and video types based on motion picture ratings.
	TV Ratings	Block various types of movies and television programming based on a parental guide ratings.
	Canadian Ratings (ENG)	Block various types of movies and television programming based on the Canadian ratings system.
	Canadian Ratings (FRN)	Block various types of movies and television programming based on the Canadian French ratings system.

Setup	Menu Preference	Choose English, French, or Spanish text.
	Set The Clock	Set the TV clock. It must be set before using Lock/Event Timer feature.
	Set The Channels	Set Channel Source and Auto Channel Scan.
	Set The Inputs	Label Video Inputs , VCR, DVD, etc.
	Set Event Timer	Turn TV on and off once, daily, or weekly.
	Set Closed Captions	Feature to display dialogue/text.
	About Your TV	Information display for this TV.

Video

Select VIDEO to adjust picture settings and improve picture quality.

Picture Mode

Use this function to choose from automatic picture settings to optimize your TV's performance.

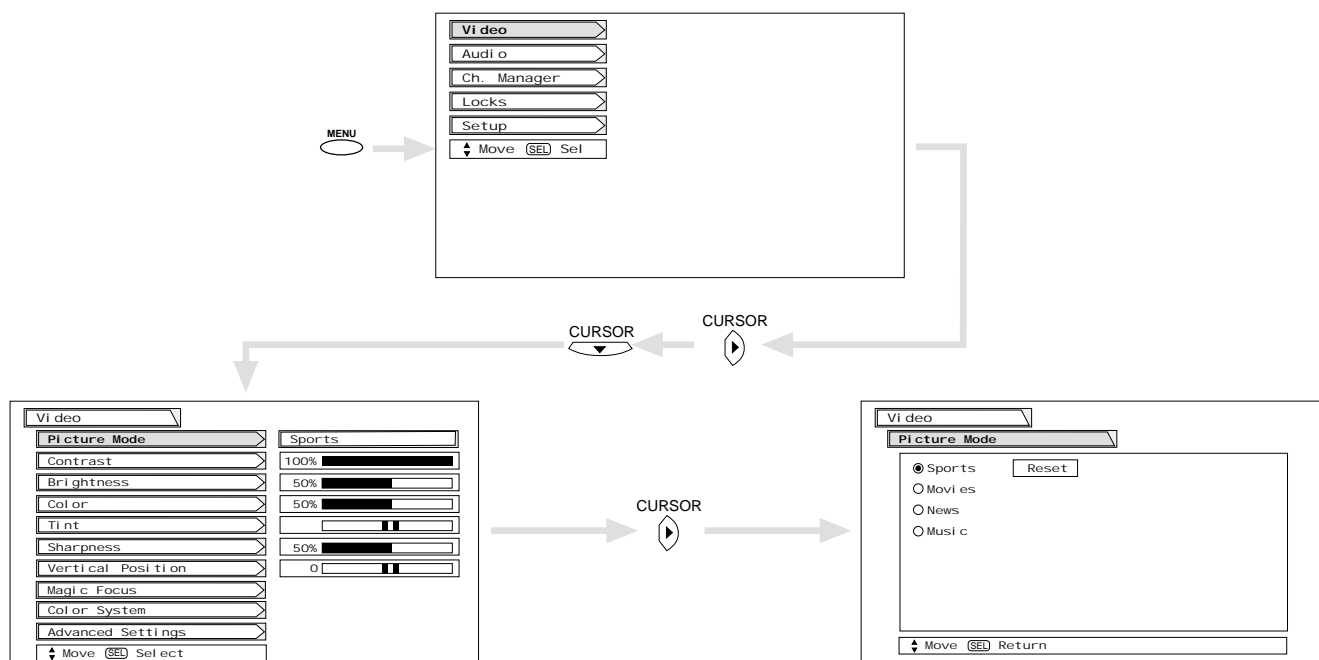

Use CURSOR ▲ or ▼ to highlight Picture Mode settings.

When SPORTS mode is selected, the following are automatically set:

CONTRAST - 100%, COLOR TEMPERATURE - HIGH, LOUDNESS - OFF, PERFECT VOLUME - OFF, BASS - 63%, SURROUND - SRS and BBE.

When MOVIES mode is selected, the following are automatically set:

CONTRAST - 60%, COLOR TEMPERATURE - STANDARD, SHARPNESS - 40%, BASS - 63%, LOUDNESS - OFF, PERFECT VOLUME - OFF, SURROUND - SRS and BBE.

NOTE: MOVIE MODE 3:2 PULLDOWN DETECTION SPECIAL FEATURE

Theatrical movies are shot on film at 24 frames or still pictures per second, instead of 30 frames or 60 fields like video. When film is transferred to video for television viewing, the disparity between the two frame rates must be reconciled. This involves a process known as 3:2 pull-down.

When MOVIE mode is selected from the Picture Mode menu, your Hitachi Projection Television will activate the circuitry for this special feature to improve video performance when watching film based sources. This 3:2 pull-down detection will only work in MOVIE mode.

When NEWS mode is selected, the following are automatically set:

CONTRAST - 75%, COLOR TEMPERATURE - MEDIUM, LOUDNESS - ON, PERFECT VOLUME - ON.

When MUSIC mode is selected, the following are automatically set:

CONTRAST - 75%, COLOR TEMPERATURE - HIGH, LOUDNESS - OFF, PERFECT VOLUME - OFF, SURROUND - BBE.

You can customize each of the above modes (SPORTS, MOVIES, NEWS, and MUSIC) to your preference to increase viewing performance and pleasure, depending upon the video program being viewed. However, if RESET is selected, each mode will reset to the initial conditions as explained above.

If RESET is selected in SPORTS mode, only SPORTS mode will return to factory conditions.

Press EXIT to quit menu or select PICTURE MODE to return to previous menu.

VIDEO

Use the CURSOR ▲ or ▼ to highlight the function to be adjusted.
Press the CURSOR ◀ or ▶ to adjust the function.
Press MENU to return to main menu or select PICTURE MODE to return to previous menu.
Press EXIT to quit menu.

Contrast	Use this function to change the contrast between black and white levels in the picture. This adjustment will only affect the picture when ADVANCED SETTINGS DIMMER is OFF.
Brightness	Use this function to adjust overall picture brightness.
Color	Use this function to adjust the level of color in the picture.
Tint	Use this function to adjust flesh tones so they appear natural.
Sharpness	Use this function to adjust the amount of fine detail in the picture.
Vertical Position	This function allows you to select when aspect style is either 4:3 EXPANDED/ZOOM1/ZOOM2. Vertical position can be changed with this mode. Adjustable range is -10 (video center is toward bottom of screen) to +10 (video center is toward top of screen).

- NOTES:**
1. If CONTRAST is selected, you are adjusting CONTRAST. The additional menu items BRIGHTNESS, COLOR, TINT, and SHARPNESS can be selected and adjusted in the same manner.
 2. It may be necessary to adjust TINT to obtain optimum picture quality when using the COMPONENT VIDEO Y-P_BP_R input jacks.
 3. If you are using the COMPONENT VIDEO input jacks (Y-P_BP_R) and notice that the TINT and COLOR are abnormal, check to make sure that VIDEO-Color System is set properly.

Magic Focus

Auto Digital Convergence Adjustment

Please turn ON your television for at least 20 minutes before using this feature.

The Magic Focus button on control panel will not work when adjustment mode is set to Manual (see page 37).

Your HITACHI Projection TV has three color projection tubes: one for red, one for green, one for blue. When mixed together in the proper proportion, the output of these three color tubes can produce any color. To produce these colors, however, the beams must be precisely aligned over each other so that the colors can be mixed. The process of aligning these picture beams is called "convergence".

Over a period of time, the picture tubes can drift out of alignment due to normal bumps and vibrations or moving the TV. If you move your TV, or if, after a time, you notice color rings or halos around objects in the picture, you may want to converge (align) the colors.

Properly converged, the lines appear white, which is actually a combination of the outputs of the three color tubes. The output of the green tube is stationary. The outputs of the red and blue tubes can be adjusted. When properly aligned, the outputs of all three tubes should be directly over each other to produce the white lines.

To simplify convergence, HITACHI incorporates a function called MAGIC FOCUS located on the front control panel, which allows the TV to self-adjust. Press this MAGIC FOCUS button and the convergence self adjustment will start and this process will take approximately 20 seconds. If this button is pressed during this process, no change in picture quality will occur. After this 20 second self-adjust period, picture quality will be optimum. (Do not move the TV during self-adjust.)

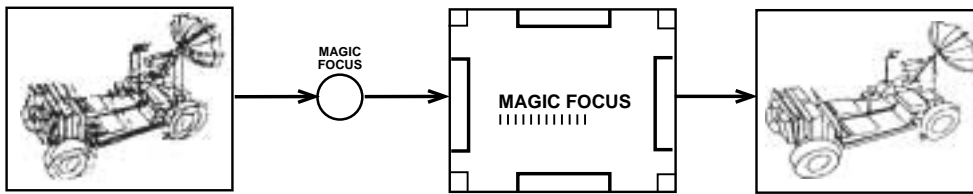

NOTES: Only a momentary press of the MAGIC FOCUS button is necessary to start AUTO DIGITAL CONVERGENCE. At any time during this convergence correction process, you may press the MAGIC FOCUS button to exit the MAGIC FOCUS mode. However, the convergence correction process needs to be completed to SAVE the new corrected convergence data.

You may also select Magic Focus from the VIDEO menu.

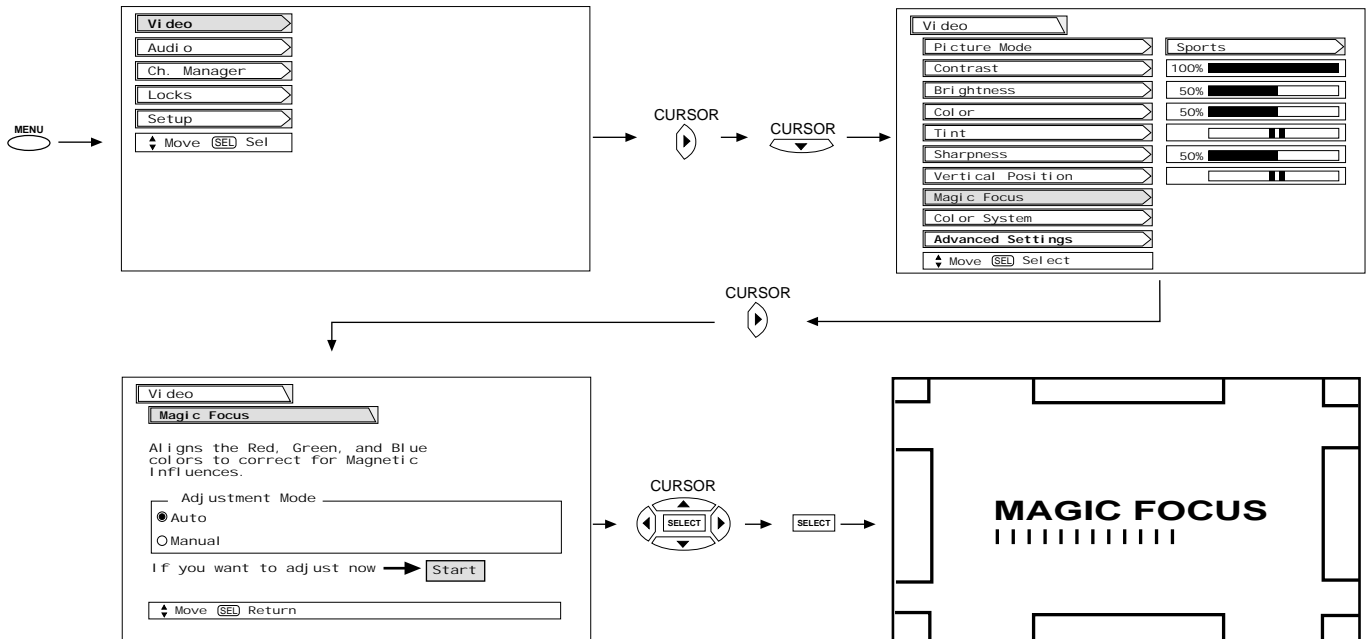

ON-SCREEN DISPLAY

VIDEO

Manual Convergence Adjustment Mode

- NOTES:**
1. Please turn ON your television for at least 20 minutes before using this feature.
 2. Auto Adjustment Mode is recommended. If convergence is still not acceptable, use the Manual Adjustment Mode. DO NOT press MAGIC FOCUS or use Auto Adjustment Mode after using Manual Adjustment Mode.

Using the Remote Control, select VIDEO-MAGIC FOCUS-MANUAL ADJUSTMENT MODE-START to access convergence crosshatch pattern. The adjustment point is indicated by the Adjustment Point Cursor.

To Move Adjustment Point

To move the Adjustment Point Cursor, use the CURSOR buttons. The Adjustment Point Cursor must be WHITE. Another way to move the Adjustment Point Cursor is to press the following buttons: [2] up, [4] left, [5] down, [6] right. If you use the number buttons while the adjustment point is WHITE, it will change to RED.

To Change the Color of Adjustment Point

Press the SELECT button repeatedly (WHITE-RED-BLUE-WHITE...). Green color is fixed and cannot be adjusted.

To Adjust the Convergence

Move the Adjustment Cursor to the point to be adjusted. Use the CURSOR ◀, ▶, ▲, ▼ to match the RED and BLUE colors to GREEN (reference color). Properly aligned, all three colors should appear white.

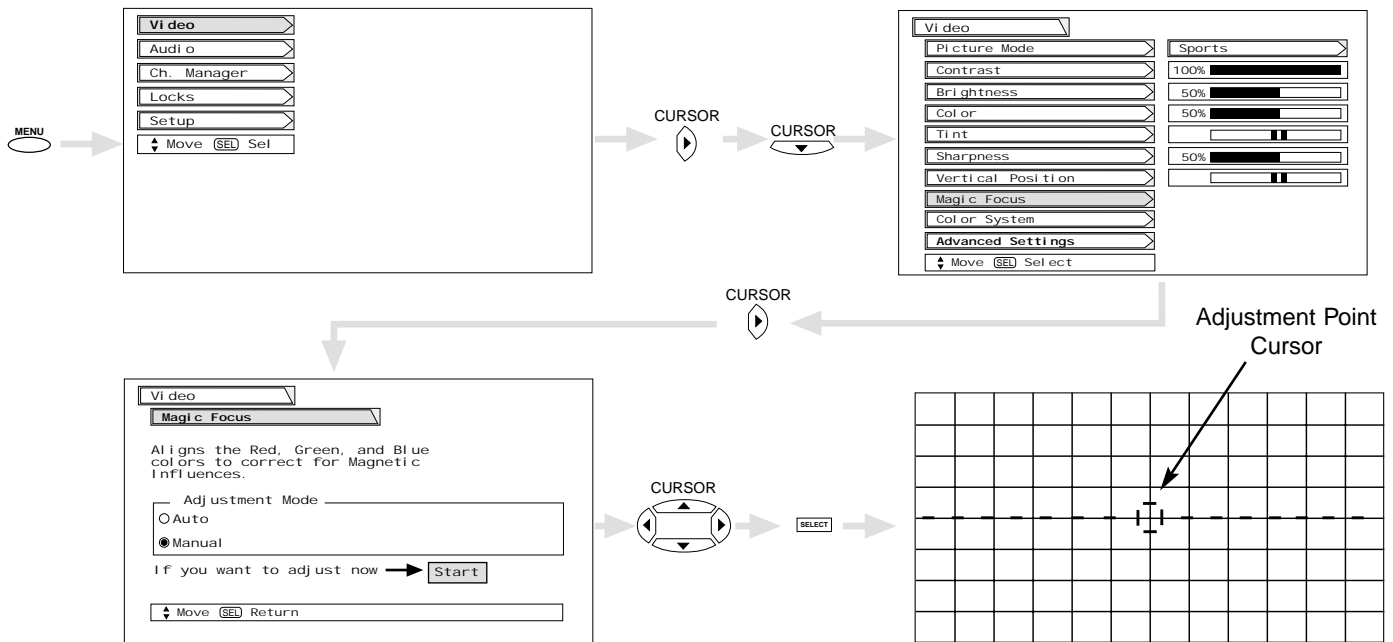

If convergence is acceptable after Manual Convergence adjustment, press EXIT button to access menu mode.

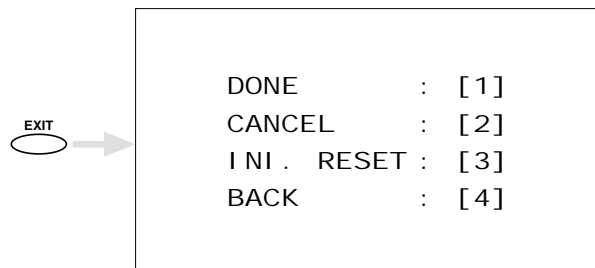

Press the [1] button on the remote control to SAVE adjusted data and return to main picture.
 Press the [2] button on the remote control to CANCEL adjusted data and return to main picture.
 Press the [3] button on the remote control to recall the factory pre-set convergence data.
 Press the [4] button on the remote control to return to the manual convergence adjustment mode (crosshatch pattern).
 Press the [9] button on the remote control to read the SAVED adjusted data. If there is no saved data, pressing the [9] button will recall the factory pre-set data.

Color System

This function allows you to automatically change tint and color coordinates for DTV programs.
 HDTV - High Definition Television - Use for High Vision Signal Y-P_BP_R from HDTV Set-Top Box.
 SDTV/DVD - Standard Definition Television or DVD (Digital Versatile Disc Player) Y-C_BC_R.

- NOTES:**
1. If Color System is set improperly (does not match actual input signal), the color and tint of the main picture will be abnormal.
 2. You must be tuned to VIDEO: 1 or 2 inputs and have a component hooked up to the Y-P_BP_R input jacks to access this color system.
 3. All component color type settings will affect only color component input you are currently viewing. If you are using both sets of component input jacks, be sure to set the color system feature for both inputs.

Advanced Settings

Your HITACHI Projection TV has an ADVANCED SETTINGS function which will automatically adjust picture settings to produce the highest quality picture possible. When ADVANCED SETTINGS is highlighted, press SELECT or CURSOR to access an ADVANCED SETTINGS feature.

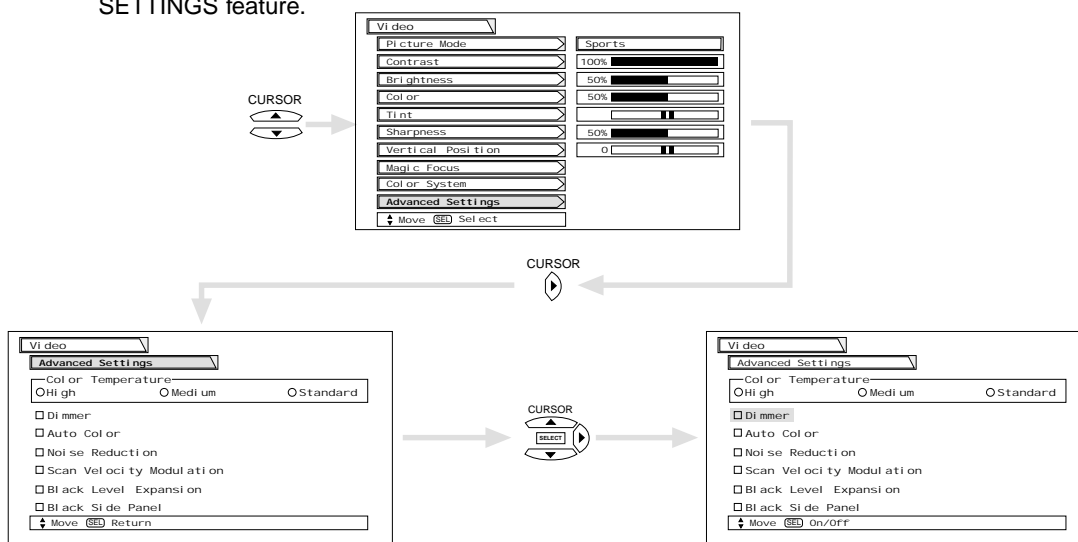

Use CURSOR ▲, ▼ to highlight functions.

Press the SELECT button to select the function setting. When the function has a “✓” in the box, it is ON.

Press the SELECT button to change COLOR TEMPERATURE setting. When the function shows a “⊙”, it is selected.

Press EXIT to quit menu or CURSOR ◀ to return to previous menu.

Color Temperature

Set this to High for less intense colors with more blue (9,300K), set to Medium for hotter colors with more red (7,500K), or set to Standard for standard colors (6,500K).

Dimmer

Turn ON the Dimmer to reduce picture contrast and brightness automatically when viewing in a dark room.

Auto Color

The AUTO COLOR function automatically monitors and adjusts the color to maintain constant color levels even after a program or channel changes. It also maintains natural flesh tones while preserving fidelity of background colors.

Noise Reduction

The NOISE REDUCTION function automatically reduces conspicuous noise in the picture without degrading picture quality. When the Noise Reduction feature is ON, the Sharpness feature is disabled.

Scan Velocity Modulation

The Scan Velocity Modulation function automatically enhances the edges between light and dark areas.

Black Level Expansion

The BLACK LEVEL EXPANSION function automatically enhances shadow detail in dark scenes.

Black Side Panel

The BLACK SIDE PANEL function turns the gray side bars on/off when watching 4:3 signals in Standard mode. The top/bottom gray bar will appear in SPLIT MODE PIP and SPLIT FREEZE.

NOTE: To maximize the operating life of the television's picture tubes when watching 4:3 signal, the Black Side Panel is cancelled at Power OFF. It is recommended to watch 4:3 signal with gray side bar.

AUDIO

Audi o

Select AUDIO to adjust the TV to your preference and to improve the sound quality.

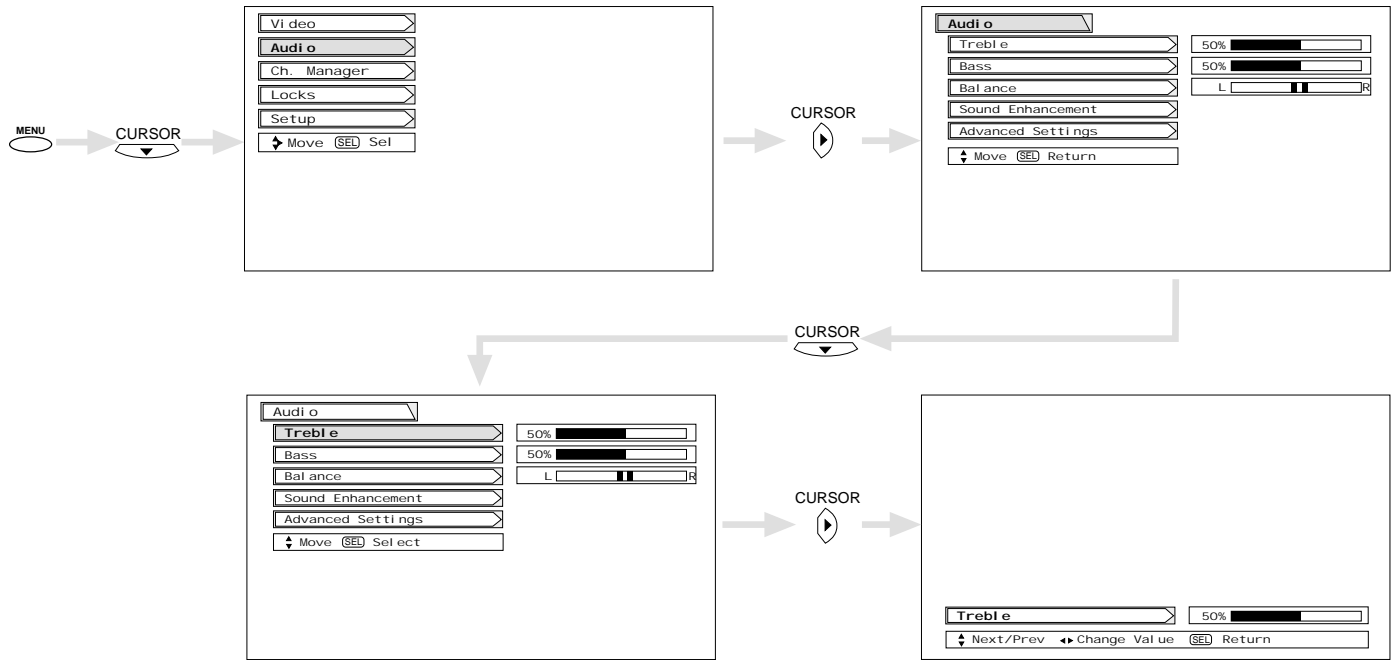

Use CURSOR ▲, ▼ to highlight functions.
 Press the SELECT button to select the function setting.
 Press CURSOR ◀ or ▶ to adjust the function.
 Press EXIT to quit MENU, or select Audio to return to the main menu.

NOTE: If TREBLE is selected you are adjusting treble. The additional menu items Bass and Balance can be selected and adjusted in the same manner.

Trebl e

This function controls the high frequency audio to all speakers.

Bass

This function controls the low frequency audio to all speakers.

Bal ance

This function will control the left to right balance of the TV internal speakers and the AUDIO TO HI-FI output.

Sound Enhancement

The following surround settings will reproduce the “live” sound you would hear in concert halls, sports stadiums, movie theaters, etc. with only two speakers.

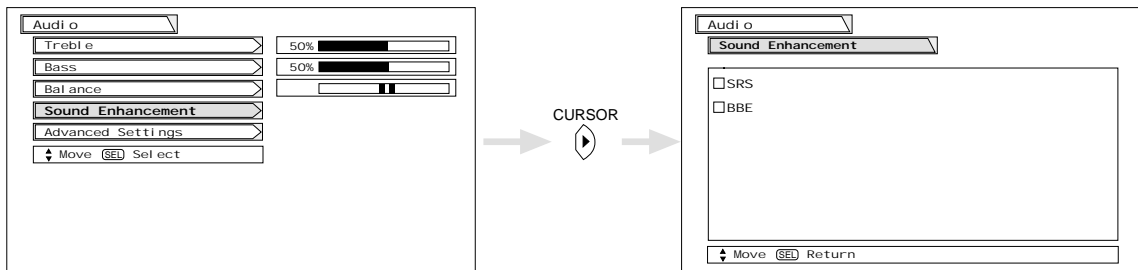

To enter SOUND ENHANCEMENT, use CURSOR ▲ or ▼ to highlight then press the SELECT button to select SOUND ENHANCEMENT of your choice.

Press CURSOR ▲ or ▼ to highlight your sound enhancement choice, and press the SELECT button to select your choice.



Based on the principles of the human hearing system, SRS technology delivers an exciting and realistic 3D Sound experience from just two external speakers (or) the two internal speakers of your HITACHI Television. If your HITACHI Television is connected to an external audio system, SRS will also create an incredible 3D sound experience from two speakers and even enhance a complete multi-speaker surround sound system.

NOTES: *SRS and the  symbol are registered trademarks of SRS Labs, Inc. SRS technology is incorporated under license from SRS Labs, Inc.

BBE Technology

Sound reproduction quality enhancement system. The BBE technology produces sound that is natural and crisp from just two speakers (or) the two internal speakers of your HITACHI television. If your HITACHI television is connected to an external audio system, BBE will also create an incredible crisp sound experience from two speakers and even more complete and accurate reproduction of the original performance. BBE brings to the listener’s ear a more complete and accurate reproduction of the original performance. Each voice, speaking or singing, each instrument or sound effect is presented with its attendant harmonics or partials more clearly audible. The ear can then more easily recognize the unique tonal colors of each sound as though the sound was being produced live.

NOTES: Licensed by BBE Sound, Inc. under USP4638258, 5510752 and 5736897. BBE and BBE symbol are registered trademarks of BBE Sound, Inc. Manufactured under license from BBE Sound, Inc.

AUDIO

Advanced Settings

Use **ADVANCED SETTINGS** to improve the sound performance of your TV, depending on listening conditions.

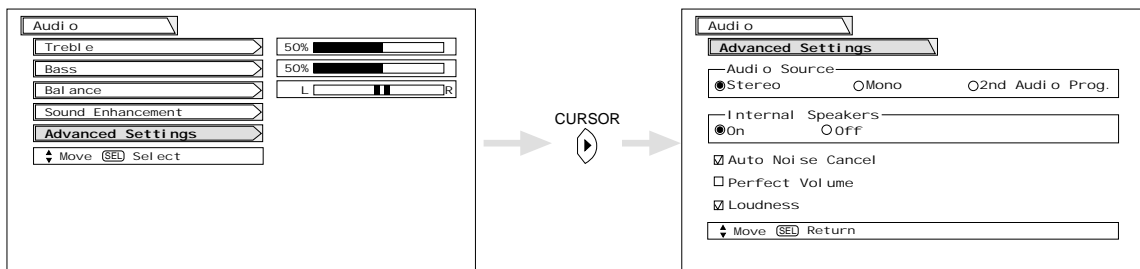

Press **CURSOR** ▲ or ▼ to highlight a function. Press the **SELECT** button to select the function setting. When the function has a “✓” in the box it is **ON**.

Audio Source

Multi-Channel Television Sound will allow you to select **STEREO** (a stereo broadcast), **MONO** (monaural sound) used when receiving a weak stereo broadcast or **SAP** (second audio program) which may be a secondary language, weather report, etc.

The mode you select will be displayed at the left edge of the TV. The source received will be displayed above the mode. See example below for each selection when both stereo and second audio are received (monaural is always received).



Internal Speakers

On - Select this feature if using the internal speakers only.

Off - Select this feature if you prefer to use only speakers from a separate stereo system.

Auto Noise Cancel

This function eliminates the noise between stations. If a channel is tuned and is noisy, this function will automatically eliminate the audio for that channel.

Perfect Volume

This function will automatically adjust volume so each channel has the same average volume level.

Loudness

This function will improve the quality of both low and high frequency sounds when listening at low volume levels.

ON-SCREEN DISPLAY

Channel Manager

This function allows you to review which channels are labeled (CH ID), which have been added to Channel Memory (SCAN), and which are protected by LOCK.

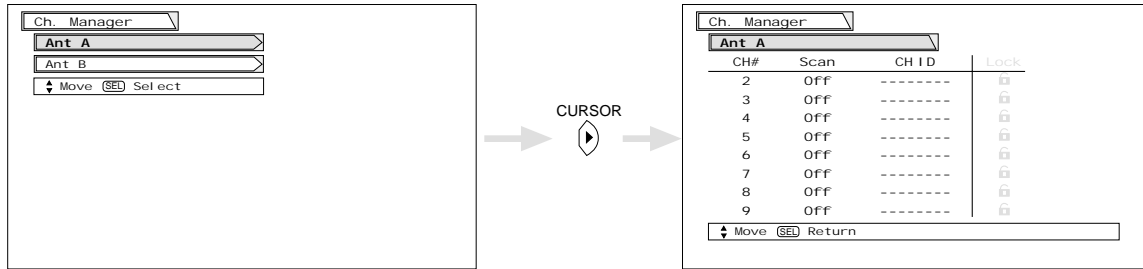

Press CURSOR ▲ or ▼ to review more channels.
Press EXIT to quit menu.

Scan

Use this feature after Auto Channel Scan is completed to add (On) or skip (Off) additional channels to the remote control channel ▲ or ▼ buttons.

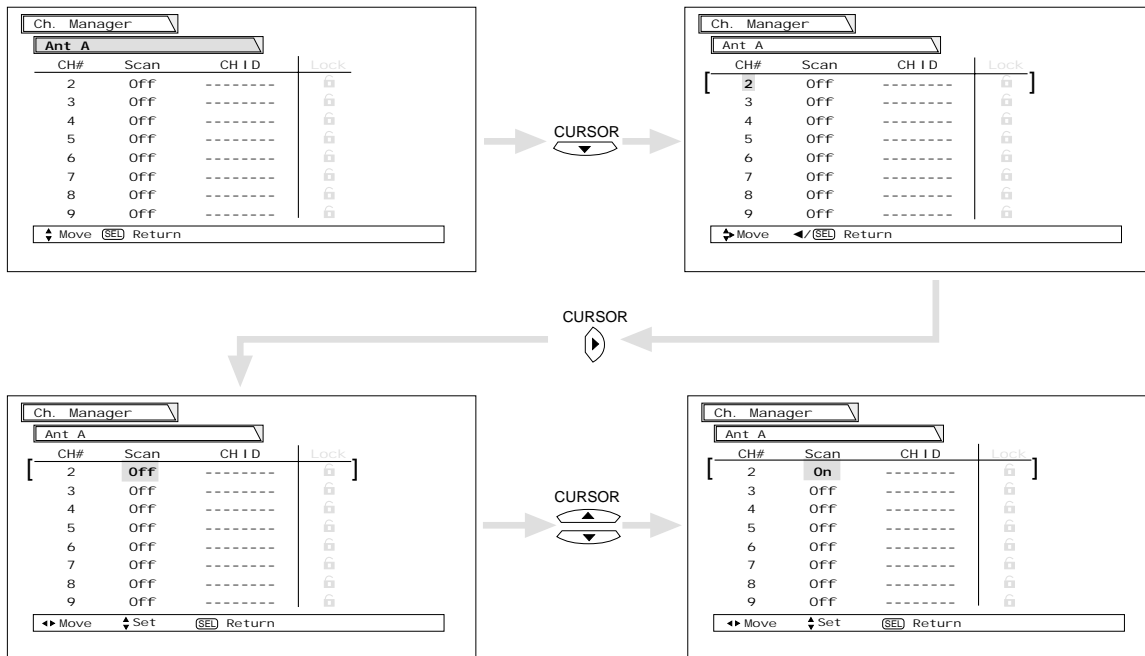

To add (Scan-On) or skip (Scan-Off) additional channels while in Channel Manager, CURSOR ◀ to highlight the channel number, then CURSOR ▲ or ▼ to highlight other channels. Once the desired channel is highlighted, CURSOR ▶ to scan column, then CURSOR ▲ or ▼ to select ON or OFF.

NOTE: Lock feature can not be selected or set in CHANNEL MANAGER.

CHANNEL MANAGER

Channel ID

This selection contains advanced features which will make TV viewing easier and more enjoyable. Use this feature to give up to 20 channels a name when ANTENNA signal source is selected and up to 60 channels a name when CATV signal source is selected.

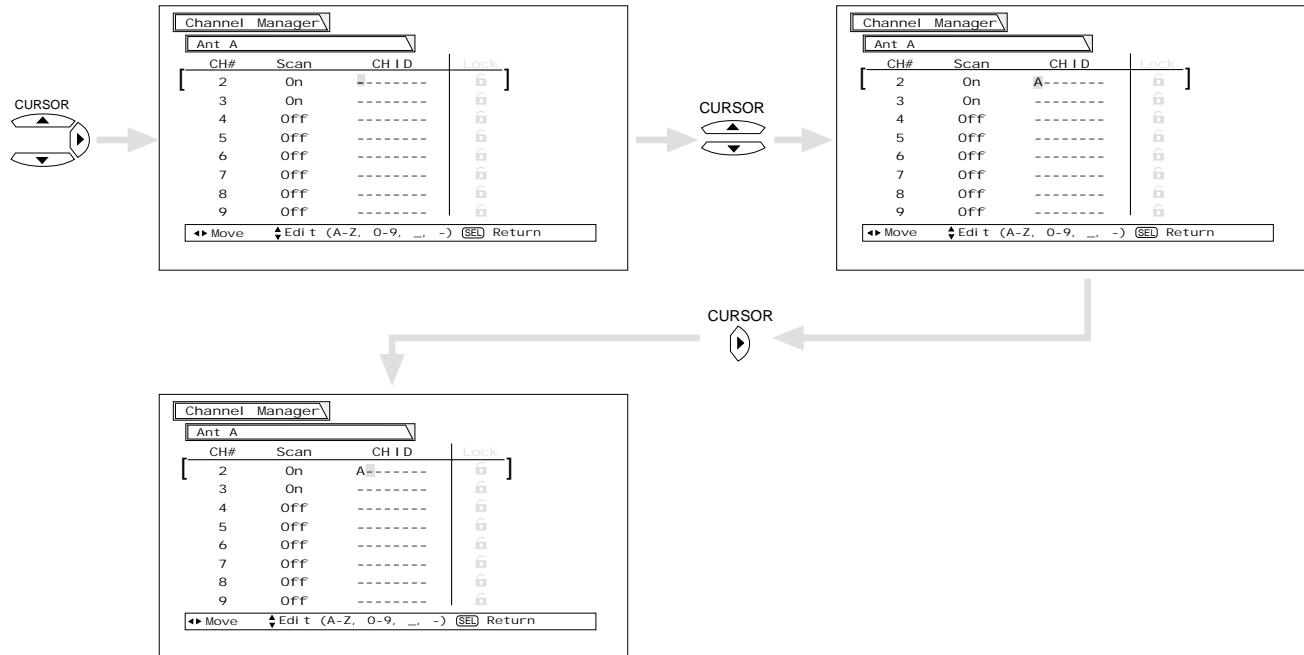

- NOTES:**
1. If ANT A and ANT B are in the same ANTENNA/CABLE mode, the CHANNEL ID for both antenna inputs will be the same.
 2. CHANNEL ID will be displayed only when channel is displayed as main picture.

Locks

This function will block out the picture and sound of the selected channel or video input. It can also be used to keep the TV from being viewed for a scheduled time period that you set.

The code to enter the Locks feature is a four digit secret code number. The factory preset code is 0000. Use the number buttons to select access code.

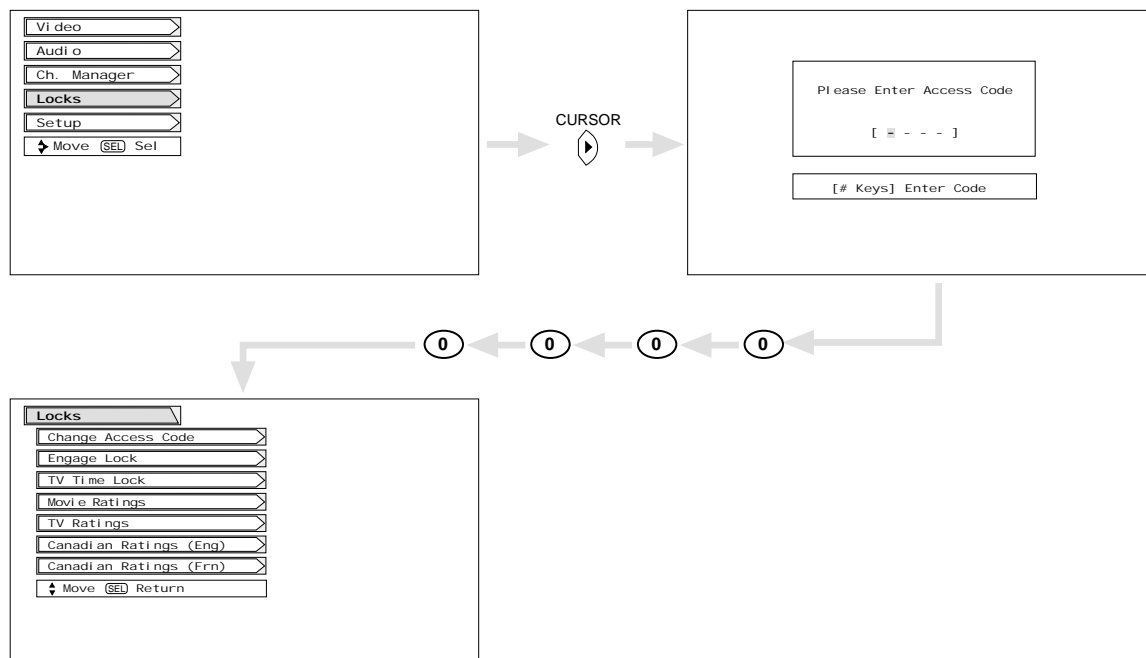

Use CURSOR ▲ or ▼ to highlight function and then press the SELECT button.

To change the access code number, select Change Access Code. Enter a new four digit key number you prefer.

Select CHANGE ACCESS CODE to change factory preset code (0000) to your preference.

When ENGAGE LOCK is selected, SET CHANNEL LOCK, SET INPUT LOCK, and SET FRONT PANEL LOCK can be set individually.

When SET CHANNEL LOCK is turned on, the picture and sound for the chosen channel will be blocked out.

When SET INPUT LOCK is turned on, the picture and sound for all video inputs and the picture and sound for channels 3, 4 will be blocked out.

When FRONT PANEL LOCK is turned on, all buttons on the Front Panel will be deactivated, except the Power button.

When TV TIME LOCK is turned on (☑ TIME LOCK) you can set the BEGIN and END times (CURSOR ►) and the TV cannot be viewed during that time period (Set clock first). Use CURSOR ▲ or ▼ to highlight ONCE (TV will time out one time only), DAILY (TV will time out every day), WEEKLY - SUN~WEEKLY - MON (TV will time out one time a week) or OFF (to disable this function).

When MOVIE RATINGS is selected, you can block various types of movies and video tapes based on motion picture ratings. Picture-in-Picture will also be blocked automatically (see page 45).

When TV RATINGS is selected, various types of television programming based on a parental guide ratings will be blocked. Picture-in-Picture will also be blocked automatically (see page 46).

Use CANADIAN RATINGS to block various types of movies and television programs based on the two rating systems used in Canada that you feel may be inappropriate due to its content (see pages 47-48).

If you forget your secret code, use the factory code 7777 to erase your key number. This will reset the secret code number back to the factory preset 0000.

Press EXIT to quit the menu.

- NOTE:**
1. If ANT A and ANT B are in the same signal source mode (see page 51), when a channel is locked, it is locked on both antenna inputs.
 2. When using TIME LOCK make sure the clock is set (see page 50).
 3. Text appears on the screen to indicate that TV TIMED LOCK is activated.
 4. If MOVIE/TV Ratings Lock and Closed Caption settings are ON, PIP SURF mode will be deactivated.

LOCKS

Movie Ratings

Use MOVIE RATINGS to block from showing any movie you feel might have inappropriate content.

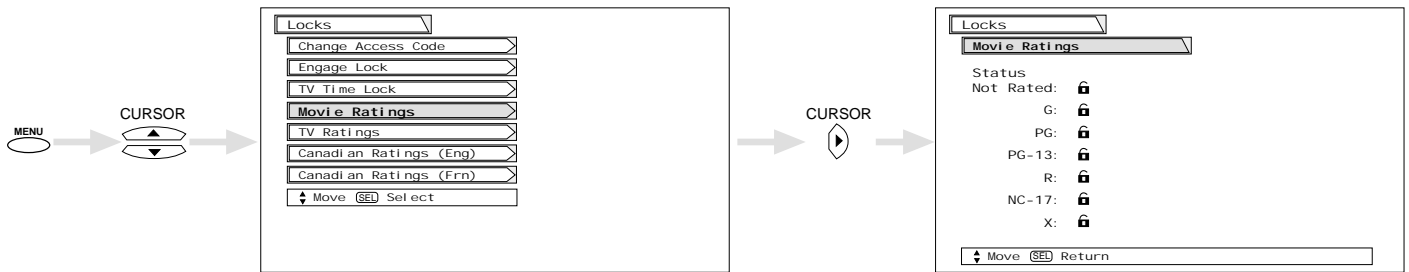

Use CURSOR ▲ or ▼ to select the MOVIE RATING category that you want to block.

Press SELECT to block the MOVIE RATING that you have selected. Once rating is selected, for example PG-13, all movies rated PG-13 and higher (R, NC-17, and X) will be blocked.

Press EXIT to quit menu or select MOVIE RATING to return to the previous menu.

Motion Picture Ratings Chart

G	General audiences. All ages admitted.
PG	Parental guidance suggested. Some material may not be suitable for children.
PG-13	Parents strongly cautioned. Some material may be inappropriate for children under 13.
R	Restricted. Under 17 requires accompanying parent or adult guardian.
NC-17	No one 17 and under admitted.
X	Adults only
NOT RATED (NR)	Contains no rating. Not Rated (NR) and Not Applicable (NA) programs. Movie has not been rated or ratings do not apply.

TV Ratings

Use TV RATINGS to block from showing any programs or movies you feel might have inappropriate content.

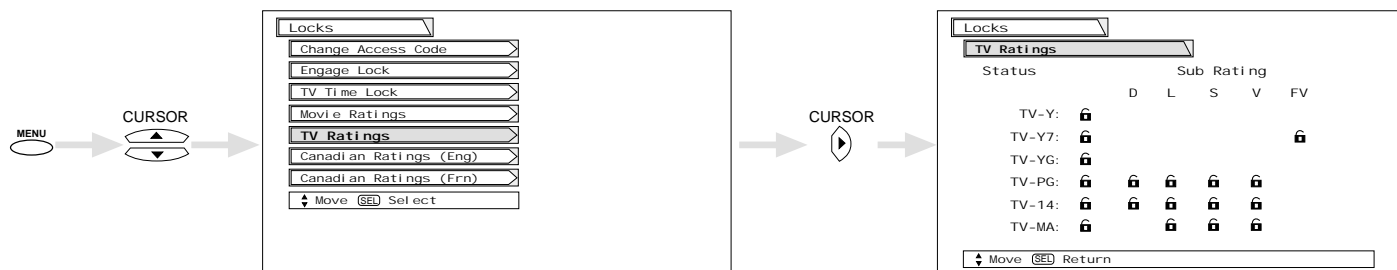

Use CURSOR ▲ or ▼ to highlight the category that you want to block. Press SELECT to block the TV RATING that you have selected. Press EXIT to quit menu or select TV RATING to return to the previous menu.

TV Parental Guide Ratings Chart

TV-Y	All children. The themes and elements in this program are specifically designed for a very young audience, including children from ages 2-6.
TV-Y7	Directed to older children. Themes and elements in this program may include mild physical or comedic violence, or may frighten children under the age of 7.
TV-G	General audience. It contains little or no violence, no strong language, and little or no sexual dialogue or situations.
TV-PG	Parental guidance suggested. The program may contain infrequent coarse language, limited violence, some suggestive sexual dialogue and situations.
TV-14	Parents strongly cautioned. This program may contain sophisticated themes, intense sexual situation, more intense violence and intensely suggestive dialogue.
TV-MA	Mature audiences only. This program may contain mature themes, indecent language, graphic violence, and explicit sexual content.
FV	Fantasy Violence
V	Violence
S	Sexual Situation
L	Adult Language
D	Sexually Suggestive Dialogue.

NOTE:

If you Block TV-14D, you will still permit TV-MA programs; If you block TV-14DV, you will automatically block TV-MAV programs, but you will still permit TV-MALS programs. This means that the TV will block violence in TV-14 and higher (TV-MA), but not language and sex.

LOCKS

Canadian Ratings (Eng)

Use Canadian Ratings (Eng) to block any type of movie and television program in Canada that you feel might be inappropriate in its content.

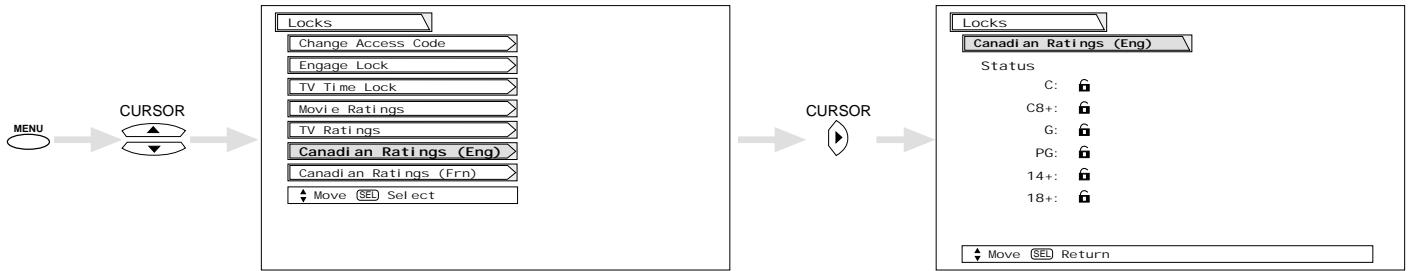

Use CURSOR ▲ or ▼ to select the CANADIAN RATINGS (Eng) category that you want to block. Press SELECT to set the CANADIAN RATINGS (Eng) that you have selected. Once rating is selected, for example C8+, all movies and television programs rated C8+ and higher (G, PG, 14+ and 18+) will be blocked automatically. Press EXIT to quit menu.

Canadian Ratings English Chart

C	Programming intended for children under age 8 - Violence Guidelines; Careful attention is paid to themes, which could threaten children's sense of security and well-being. There will be no realistic scenes of violence. Depictions of aggressive behaviour will be infrequent and limited to portrayals that are clearly imaginary, comedic or unrealistic in nature. Other Content Guidelines: There will be no offensive language, nudity or sexual content.
C8+	Programming generally considered acceptable for children 8 years and over to watch on their own - Violence Guidelines: Violence will not be portrayed as the preferred, acceptable, or only way to resolve conflict; or encourage children to imitate dangerous acts which they may see on television. Any realistic depictions of violence will be infrequent, discreet, of low intensity and will show the consequences of the acts. Other Content Guidelines: There will be no profanity, nudity or sexual content.
G	General Audience - Violence Guidelines: Will contain very little violence, either physical or verbal or emotional. Will be sensitive to themes which could frighten a younger child, will not depict realistic scenes of violence which minimize or gloss over the effects of violent acts. Other Content Guidelines: There may be some inoffensive slang, no profanity and no nudity.
PG	Parental Guidance - Programming intended for a general audience but which may not be suitable for younger children. Parents may consider some content inappropriate for unsupervised viewing by children ages 8-13. Violence Guidelines: Depictions of conflict and/or aggression will be limited and moderate; may include physical, fantasy, or supernatural violence. Other Content Guidelines: May contain infrequent mild profanity, or mildly suggestive language. Could also contain brief scenes of nudity.
14+	Programming contains themes or content which may not be suitable for viewers under the age of 14 - Parents are strongly cautioned to exercise discretion in permitting viewing by pre-teens and early teens. Violence Guidelines: May contain intense scenes of violence. Could deal with mature themes and societal issues in a realistic fashion. Other Content Guidelines: May contain scenes of nudity and/or sexual activity. There could be frequent use of profanity.
18+	Adult - Violence Guidelines: May contain violence integral to the development of the plot, character or theme, intended for adult audiences. Other Content Guidelines: May contain graphic language and explicit portrayals of nudity and/or sex.

Canadian Ratings (Frn)

Use CANADIAN RATINGS (FRN) to block Canadian French programs according to various program ratings that you feel might be inappropriate in its content.

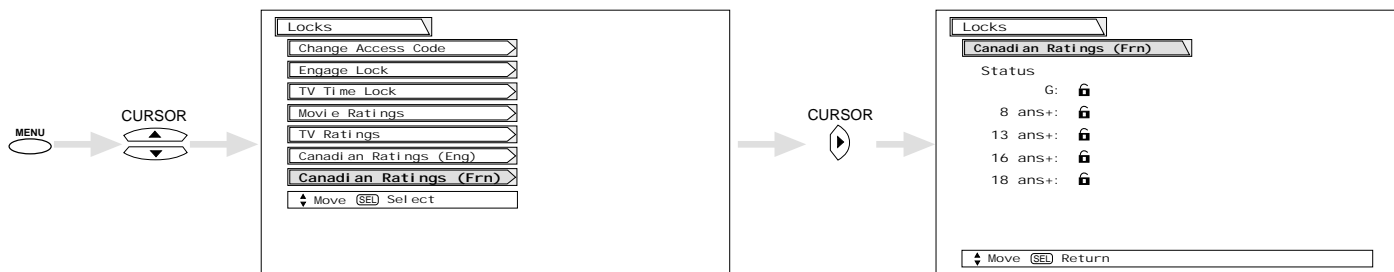

Use CURSOR ▲ or ▼ to highlight the category that you want to block. Press SELECT to set the CANADIAN RATINGS (FRN) that you have selected. Once rating is selected, for example 8 ans+, all movies and television programs rated 8 ans+ and higher will be automatically blocked. Press EXIT to quit menu or select CURSOR ◀ to return to the previous menu.

Canadian Ratings French Chart

G	General - Programming intended for audiences of all ages. Contains no violence, or the violence content is minimal or is depicted appropriately with humor or caricature or in an unrealistic manner.
8 ans +	8 + General - Not recommended for young children - Programming intended for a broad audience but contains light or occasional violence that could disturb young children. Viewing with an adult is therefore recommended for young children (under the age of 8) who cannot differentiate between real and imaginary portrayals.
13 ans +	Programming may not be suitable for children under the age of 13 - Contains either a few violent scenes or one or more sufficiently violent scenes to affect them. Viewing with an adult is therefore strongly recommended for children under 13.
16 ans +	Programming is not suitable for children under the age of 16 - Contains frequent scenes of violence or intense violence.
18 ans +	Programming restricted to adults - Contains constant violence or scenes of extreme violence.

SETUP

Setup

Select SETUP when setting your TV up for the first time. Use the CURSOR ▲ or ▼ on the remote to highlight the function desired.

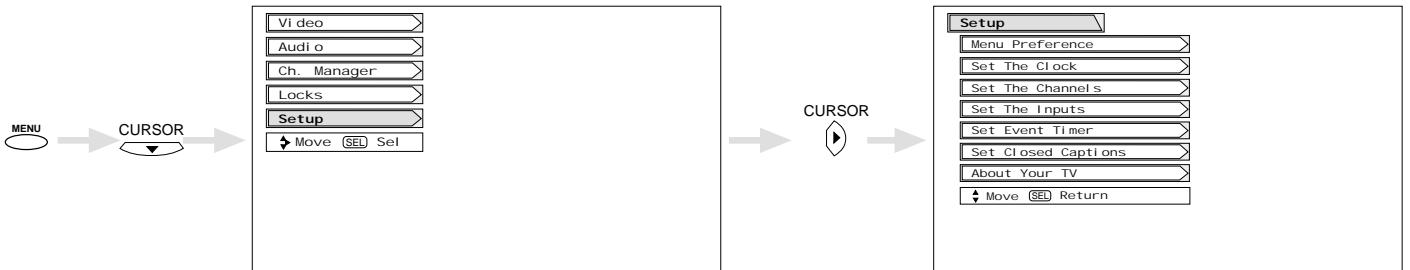

Use CURSOR ▲ or ▼ to select the sub-menu of your choice.

Menu Preference

This feature will allow you to select any one of three different languages for all on-screen displays.

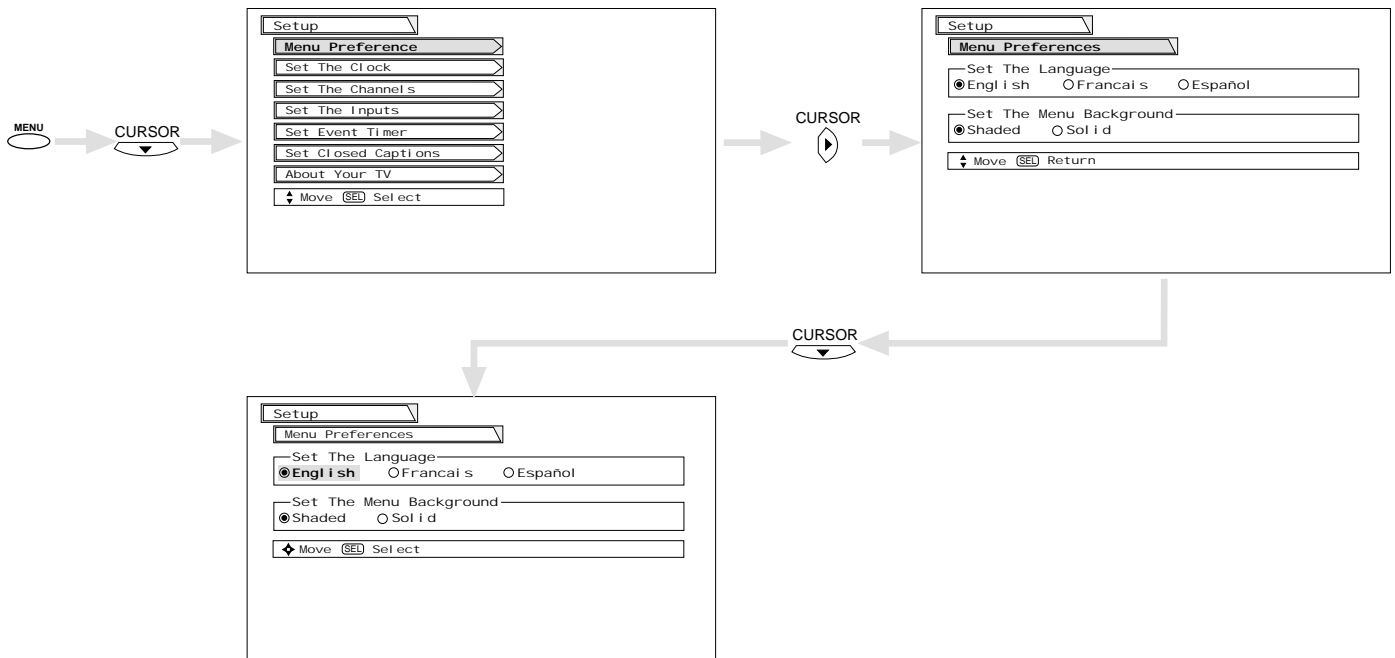

Use CURSOR ◀, ▶ to highlight the language of your choice.
Press SELECT to select the highlighted language.
Press EXIT to quit menu or select MENU PREFERENCE to return to previous menu.

Set The Menu Background

This function allows you to choose from two menu backgrounds.

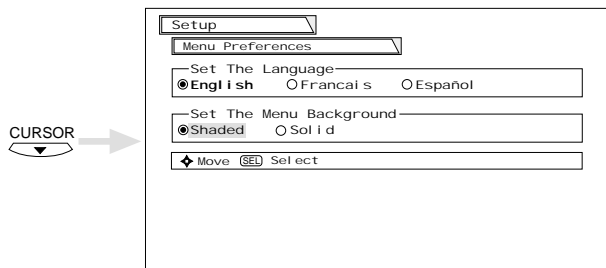

Use CURSOR ◀, ▶ to highlight SET THE MENU BACKGROUND (shaded or solid), and press the SELECT button to select setting. Press EXIT to quit menu or CURSOR ◀ to return to previous menu. Select SOLID for a black background (no picture can be seen behind menu screen), or select SHADED for a light background.

Set The Clock

The time must be adjusted before you can use the "Set Event Timer" or "TV Time Out" features.

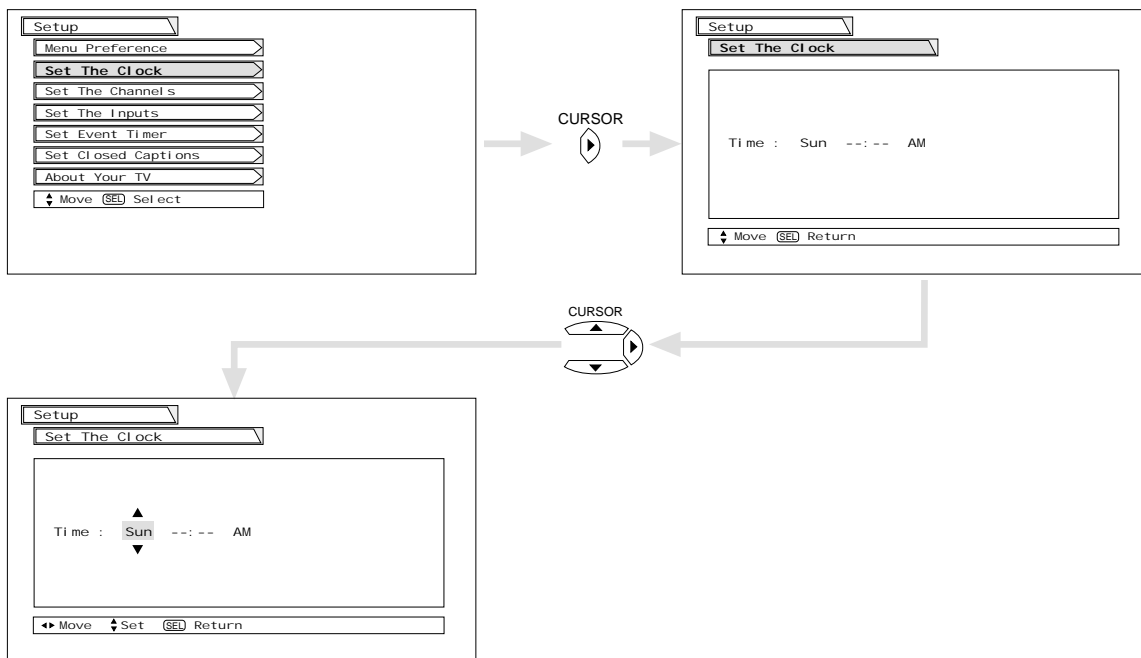

Use CURSOR ▲ or ▼ to set the time and date. Press CURSOR ◀ or ▶ to change position. Press EXIT to quit menu.

SETUP

Set The Channels

Select ANTENNA if you are using an indoor or outdoor antenna. Select Cable if you have cable TV.

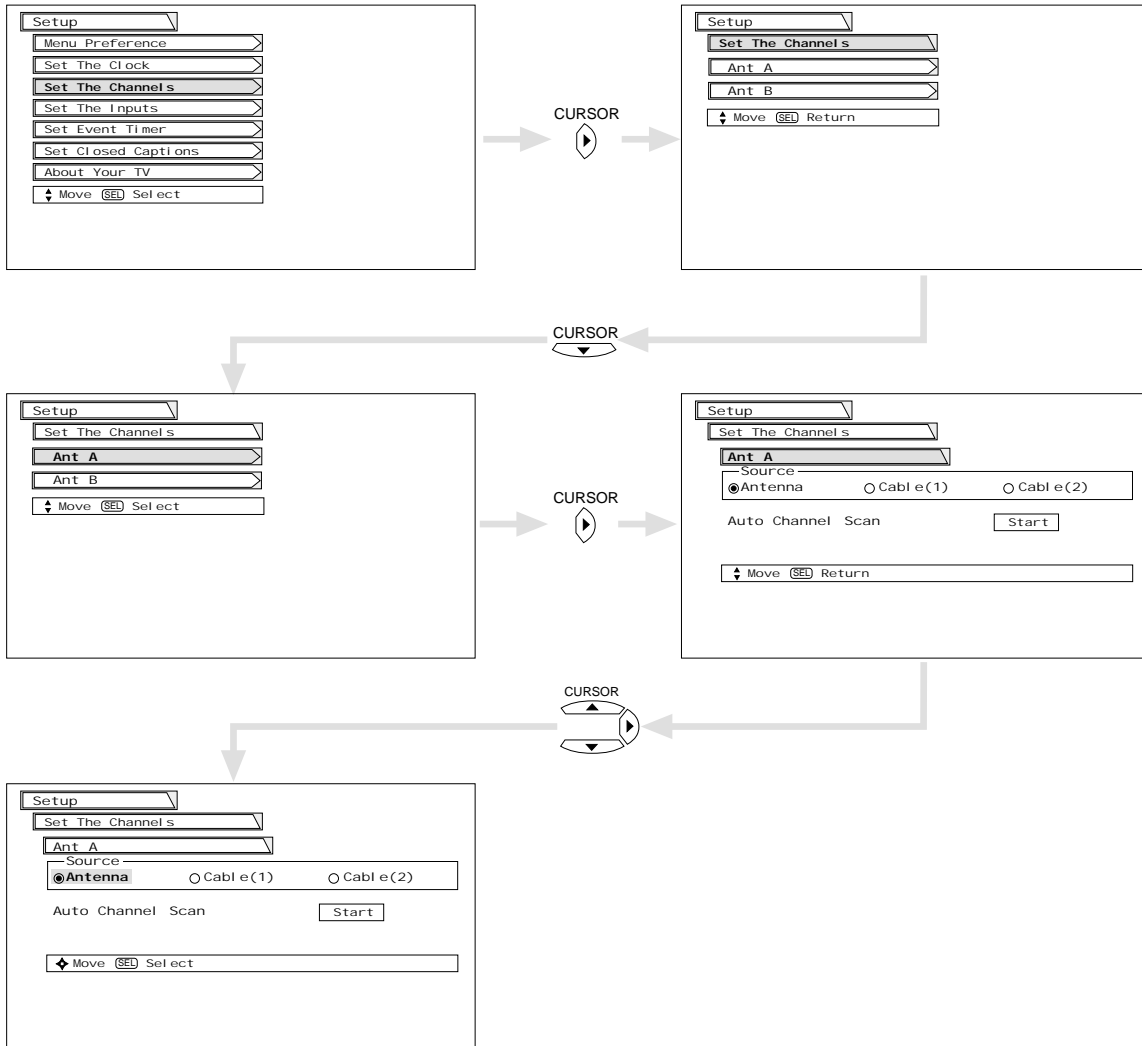

NOTE: If certain CATV channel's picture are poor or unable to be viewed in Cable (1) mode, select Cable (2).

Use CURSOR ◀, ▶ to highlight the correct signal mode.
 Press the SELECT button to select highlighted signal.
 Press EXIT to quit MENU or select ANT A to return to previous menu.

RECEPTION BAND		
AIR	CATV 1 OR CATV 2	
	CATV CHANNEL	Indicated on the screen
VHF 2 ~ 13ch UHF 14 ~ 69ch	VHF 2~13	2 ~ 13
	Mid band A~1	14 ~ 22
	A-5 ~ A-1	95 ~ 99
	Super band J~W	23 ~ 36
	Hyper band	37 ~ 64
	W + 1 ~ W + 28	65 ~ 125
	Ultraband	65 ~ 125
	W + 29 ~ W + 84	

Reception channels for each mode are shown at the left.

Refer to your cable or TV guide for channel identification standards.

Auto Channel Scan

This feature will automatically store active TV channels in Auto Channel Scan. This will allow you to skip unused channels when using CHANNEL UP (▲) or DOWN (▼).

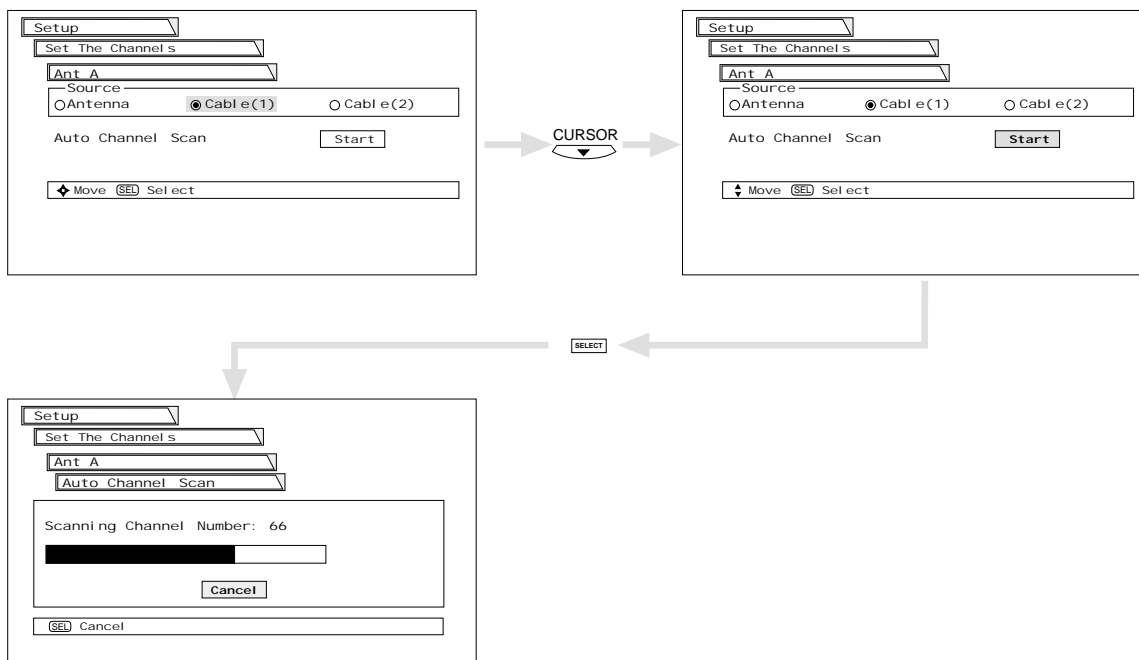

If the EXIT button is pressed while AUTO CHANNEL SCAN function is engaged, programming will stop. If two antenna are connected, switch antenna inputs with the ANT button and repeat AUTO CHANNEL SCAN for the second antenna input.

Remember to select the correct ANTENNA/CABLE mode before using AUTO CHANNEL SCAN.
See CHANNEL MANAGER - SCAN to add or to erase additional channels (see page 42).

SETUP

Set The Inputs

Use this feature to give a name to any of the five video inputs.

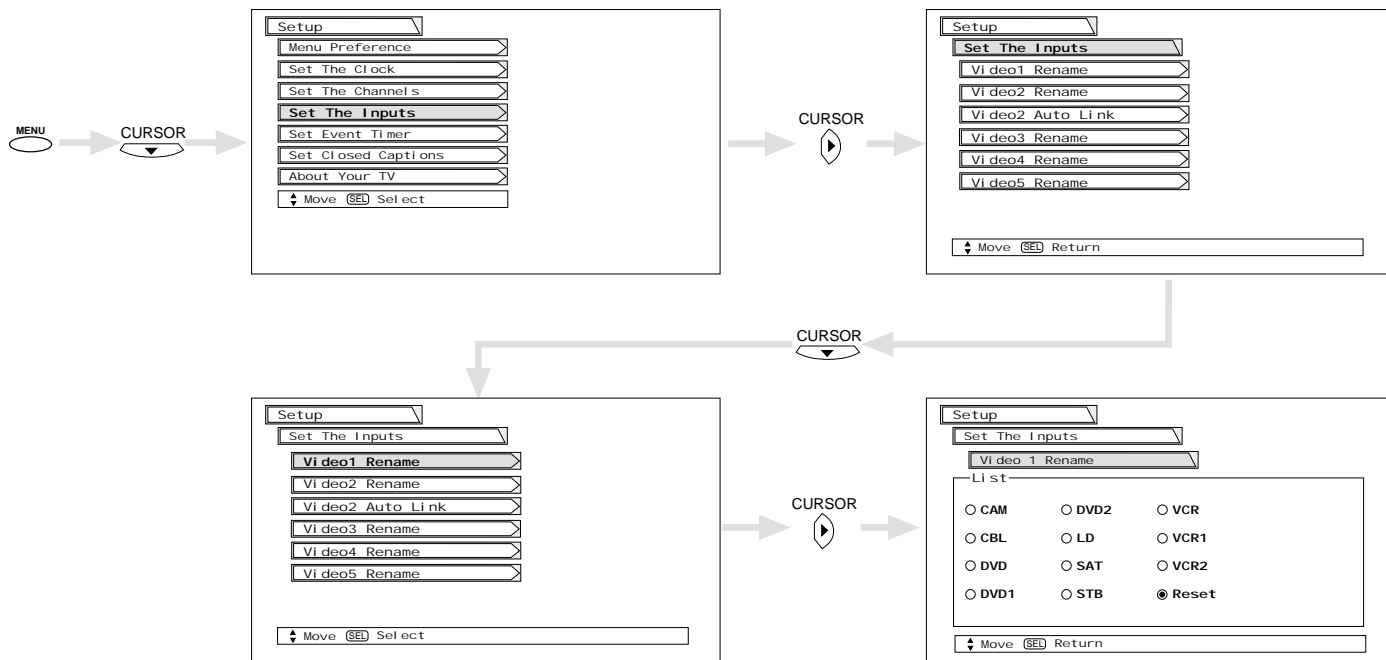

Press CURSOR ▲, ▼, ◀, ▶, to highlight the name of the video inputs.
Press the SELECT button to select desired input name.

Select RESET to set video names to original factory preset condition.

Video 2 Auto Link

Use this function to automatically turn the TV on and tune to Video2 when it detects a video signal to input 2.

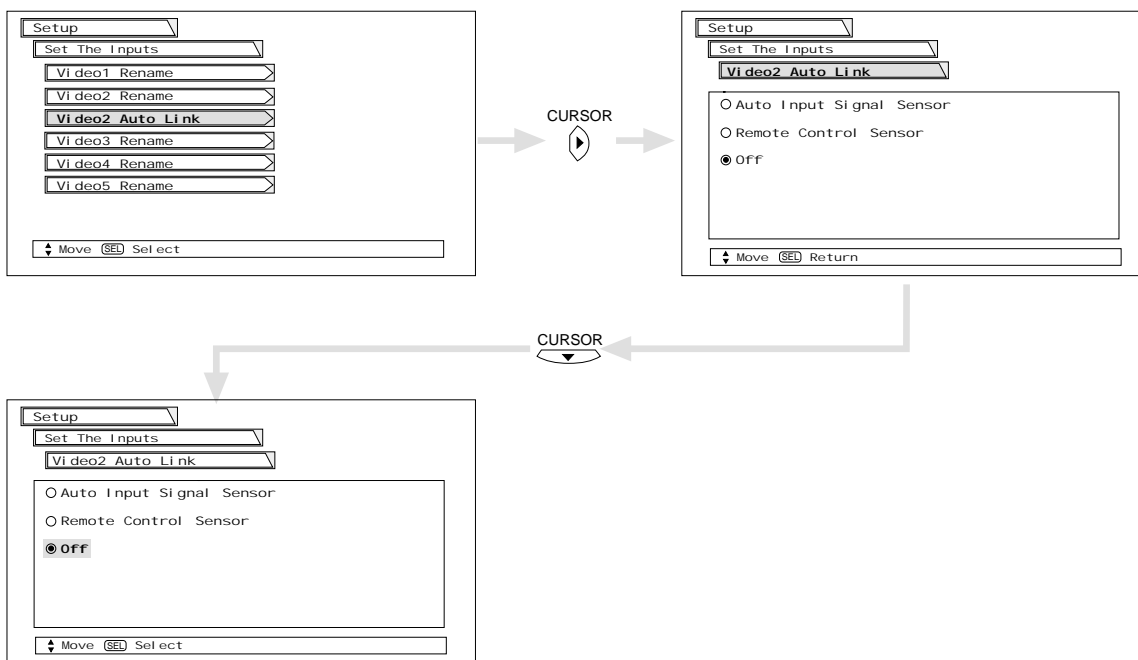

Use CURSOR ▲ or ▼, then press the SELECT button to change AUTO LINK setting.

When AUTO INPUT SIGNAL SENSOR is selected, the TV will turn on and tune to Video2 automatically, when the Video2 input device is turned on. This is convenient when you want to watch a movie with your VCR, laserdisc player, or DVD player.

When REMOTE CONTROL SENSOR is selected, the TV will turn on and switch to Video2 automatically when the Video2 input device is turned on and the VCR, laserdisc, or DVD play button on your remote control is pressed. This is convenient when you want to record a movie with your VCR and watch it later.

Select Off to disable this function.
Press EXIT to quit menu.

- NOTES:**
1. Once the TV has been turned on using the AUTO LINK feature, it must be reset before AUTO LINK is used again. To do this, turn your VCR, laserdisc, or DVD player OFF. This feature is now reset and will turn on your TV as described above.
 2. When using REMOTE CONTROL SENSOR mode, any remote control button will substitute for your video input device play button. However, intended operation is for use with your VCR, laserdisc, or DVD play button.
 3. If no remote control button is pressed after the TV is turned on by AUTO LINK, the TV will automatically turn off after three hours.

SETUP

Set Event Timer

This function will automatically turn the Projection TV on and off, one time only, every day, or once a week.

If the clock is not set, you can not use this function and the screen below will appear. The message on the screen will disappear after 3 seconds, then the screen automatically goes to the clock setup mode (see page 50).

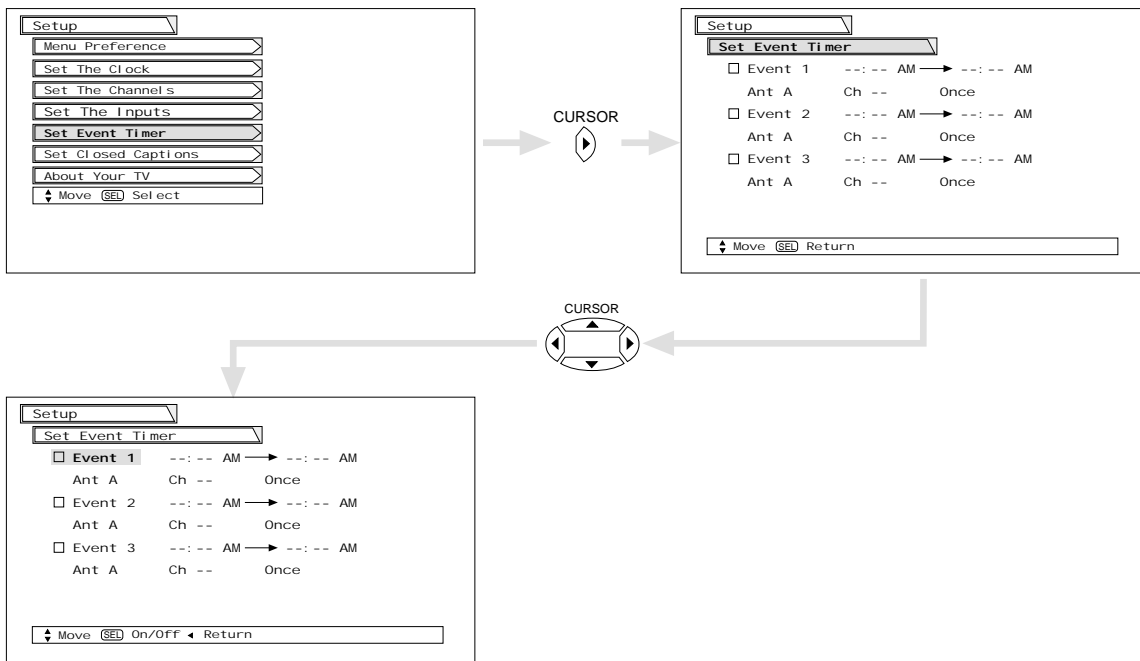
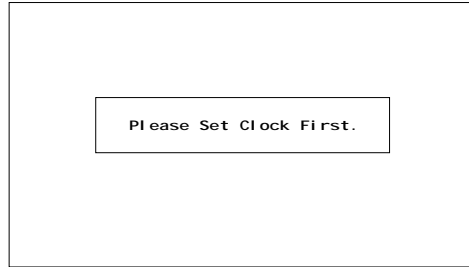

Use CURSOR ▼ to select Event 1, 2 or 3.

Use CURSOR ► to change position of On time, Off time, Antenna, Channel, and On/Off Frequency.

Use CURSOR ▲ or ▼ to select the time the TV will turn on and off.

Use CURSOR ▲ or ▼ to select the day of the week you want the timer to turn on TV.

Use number buttons to set the channel the TV will tune to when it automatically turns on.

Use CURSOR ▲ or ▼ to select mode Once (TV will turn on/off one time only), Daily (TV will turn on/off at the same time every day), or Weekly-SUN (TV will turn on/off at same time every week).

Press EXIT to quit the menu.

- NOTE:**
1. The Off Timer will only activate if the TV was turned on by the On Timer and no channel selection was made after this time. If you change the channel after the On Timer has been activated, the Off Timer will deactivate.
 2. If no remote control button is pressed after Event Timer is activated, the TV will automatically turn off after three hours. Therefore, do not Set Event Timer for more than three hours if you do not plan to control your television with the remote control.



CAUTION: Do not use your TV as a deterrent when away from home by using the On and Off Timers. For safety, the TV should be turned off when you are away from home.

Closed Caption

Closed Captions are the dialogue, narration, and/or sound effects of a television program or home video which are displayed on the TV screen. Your local TV program guide denotes these programs as **CC** or

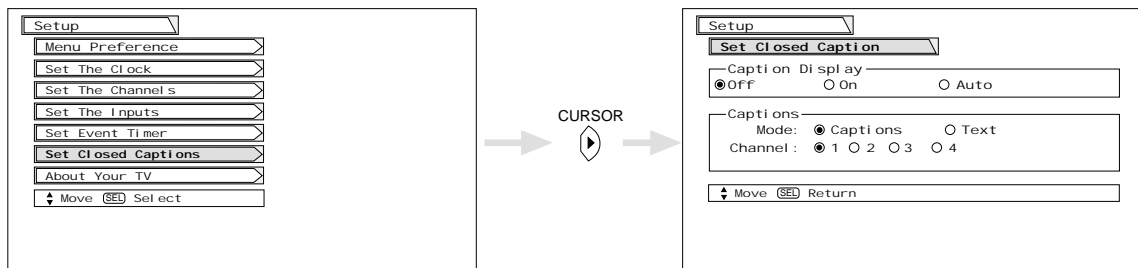

Caption Display: On/Off will turn the **CC** display on or off.

Auto will turn the **CC** display on when Mute/Soft Mute is on.

Caption Mode: Captions is for the program you are viewing.

Text is for additional information such as news reports or a TV program guide. This information covers the entire screen and viewing the TV program is not possible. Text may not be available with every **CC** program.

CHANNEL:

- 1 is used for the primary language (usually English).
- 2 is sometimes used for a second language (may vary by region).
- 3 is sometimes used for a third language (may vary by region).
- 4 is sometimes used for a fourth language (may vary by region).

Use CURSOR ▲, ▼ to highlight the function to change then press the SELECT button to change the function. Press EXIT to quit menu or CURSOR ◀ to return to previous menu.

NOTE:

1. CAPTION DISPLAY will not work when viewing a 480p, 720p, or 1080i input via the COMPONENT: Y-P_BP_R inputs.
2. When PIP Surf is on, Closed Caption will not work.

About Your TV

The TV model name and set dimensions will be displayed on the TV screen. The set dimensions of each TV model are listed on page 60.

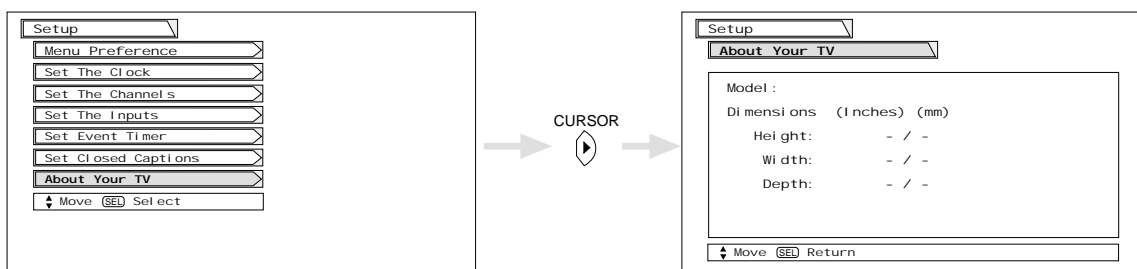

CARE OF YOUR HITACHI TELEVISION AND YOUR REMOTE CONTROL



DO

Dust the screen and cabinet with a soft cloth.

Clean the screen with a soft cloth moistened in warm water and dry with a soft cloth. A mild soap may be used if the screen is extremely dirty.

Place your Television away from extreme heat, humidity, and extremely dusty places.

Remove the plug from the wall outlet if your Television will not be used for a long period of time, for instances, when you go on vacation.

DO NOT

Do not clean your screen or cabinet with strong cleaners, polishes or a chemically treated cloth.

Do not place rubber or vinyl products or cellophane tape on your Television.

Do not touch the screen too often.

Do not subject the remote control to shocks such as dropping it on the floor, etc. Physical damage to the precision parts may result.





Avoid placing the remote control in a high humidity place or getting it wet. Do not leave it on or near a heater. Excessive heat or moisture may cause the unit to cease operation.

When the batteries run down, remote control operation will become erratic or possibly stop altogether. Replace the old batteries with two new "AA" size batteries. Do not use an old battery with a new battery.

Exposure of the viewing screen to prolonged direct sunlight or heat may cause the screen to permanently warp, resulting in a distorted picture.



Reception Problems

	<ul style="list-style-type: none">• IGNITION NOISE: Black spots or horizontal streaks may appear, picture may flutter or drift. Usually caused by interference from automobile ignition systems, neon lamps, electrical drills, and other electrical appliances.
	<ul style="list-style-type: none">• GHOSTS: Ghosts are caused by the television signal following two paths. One is the direct path and the other is reflected from tall buildings, hills or some other objects. Changing the direction or position of the antenna may improve reception. Ghosting may also be caused by defects in the antenna system such as unshielded leads or connecting several sets to the same antenna without using multiple antenna couplers.
	<ul style="list-style-type: none">• SNOW: If your receiver is located in the fringe area of a television station where the signal is weak, your picture may be marred by the appearance of small dots. When the signal is extremely weak, it may be necessary to install a special antenna to improve the picture.
	<ul style="list-style-type: none">• RADIO FREQUENCY INTERFERENCE: The interference produces moving ripples or diagonal streaks, and in some cases, causes loss of contrast in the picture.

NOTE: The TV set can generate sound distortion in external devices such as a radio. Please separate radio equipment from the TV set to a considerable distance.



SYMPTOMS	CHECK THESE ITEMS AND TRY THESE ADJUSTMENTS											
	Be sure external connection is correct	Be sure power cord is plugged in	Be sure TV is switched "ON"	Try another channel (station trouble)	Check antenna connections (back of TV)	Check antenna for broken lead-in wire	Check outside antenna	Adjust Contrast control	Adjust Brightness control	Adjust Color control	Adjust Tint control	Adjust Volume control
No Picture, no sound	●	●	●	●	●	●	●					
Sound OK, picture poor	●			●	●	●	●	●	●			
Picture OK, sound poor	●			●	●	●	●	●				●
Picture blurred	●			●	●	●	●	●				
Lines or streaks in picture				●	●	●	●	●				
Poor reception on some channels				●	●	●	●	●				
Picture rolls vertically				●				●				
No color	●			●	●	●	●			●		
Poor color	●			●	●	●	●			●	●	

HITACHI Projection Television incorporates advanced power surge protection technology designed to protect against component or circuit damage due to external or internal voltage power surges.

IF YOUR TELEVISION SHOULD APPEAR TO HAVE A LOSS OF POWER, PLEASE FOLLOW THIS PROCEDURE:

1. Press the power switch (ON/OFF switch) once.
2. If there is still no power, wait 30 seconds and press the power switch again.
3. If there is still no power, unplug the power cord from the wall. Wait 30 seconds and plug the power cord back in. Press the power switch again.

This protective technology should provide for years of lasting entertainment from your HITACHI Projection Television.



Features:

- Superfine Picture Quality
1280 Line Horizontal Resolution
- Remote (Controls many VCRs, DVD players, cable boxes, and satellite boxes.)
- New Easy-to-Use (3-Language) On-Screen Menu
- Full Set of Input Jacks, including S-VIDEO
- COMPONENT VIDEO: Y-P_B/P_R
- Velocity Modulation
- Six Aspect Modes
- Closed Caption Decoder
- 2-Tuner Picture in Picture
- Magic Focus (Auto Digital Convergence and Manual Adjustment)
- Dual Antenna Inputs
- Video Input Sensor
- 3 Dimensional Y/C Comb Filter
- Full 1080i HDTV capable when used with a Set-Top Box.
- High Bandwidth Digital Content Protection V1.0 Compatible.
- **BBE** Technology.
*Licensed by BBE Sound, Inc. under USP4638258, 5510752 and 5736897. BBE and BBE symbol are registered trademarks of BBE Sound, Inc. Manufactured under license from BBE Sound, Inc.
- **SRS** Technology.
*SRS and the  symbol are registered trademarks of SRS Labs, Inc. SRS technology is incorporated under license from SRS Labs, Inc.

Inputs:

- Power InputAC 120V, 60Hz
- Stand-by Power1.3W
- Power Consumption
- Refer to rear panel at the back of the T.V.
- Antenna input impedance75 Ohm
- Channel coverage181ch.
VHF-Band2 ~ 13
UHF-Band14 ~ 69
CATV Mid BandA-5 ~ A-1
.A-I
Super BandJ-W
Hyper BandW+1 - W+28
Ultra BandW+29 - W+84
- Video1.0Vp-p, 75 Ohm
- S-Video
Luminance (Y)1.0Vp-p, 75 Ohm
Chrominance (C)0.286Vp-p, 75 Ohm
- Component Video
Luminance (Y)1.0Vp-p, 75 Ohm
Chrominance (P_B/P_R)0.7Vp-p, 75 Ohm
- Audio input Impedance47k Ohm
- Average input level470mVrms
- DVI-HDTVDVI 25 pin

Outputs:

- Video1.0Vp-p, 75 Ohm
- Audio (Fixed)470mVrms, 1k Ohm

Dimensions:

	46F500	51F500	57F500
• Height (in.)	39 13/16	50 1/4	54 3/16
(mm)	1,011.0	1,275.0	1,376.2
• Width (in.)	44 7/16	48 3/4	54
(mm)	1,128.0	1,239.0	1,372.0
• Depth (in.)	24 1/2	25 1/16	25 8/16
(mm)	622.0	636.0	647.9
• Weight (lbs.)	160	245	273

NOTE: Due to improvements, specifications in this operating guide are subject to change without notice.



HITACHI

*Service
hotline*

To locate an authorized
HITACHI service facility
in the continental U.S.A.
and Canada,

DIAL TOLL FREE

7 days a week, 24 hours a day

800 HITACHI

(1-800-448-2244)

Hitachi America, LTD. Home Electronics Division

Hitachi has made every effort to assure you hours of trouble free operation from your unit. However, should you require service, a network of Hitachi Authorized Service Facilities has been established in all 50 states and Puerto Rico. Each facility will provide you with convenient and expedient assistance. Our service hotline operator will direct you to the Hitachi Authorized Service Facility nearest you. Just present proof of purchase and/or delivery receipts to the Hitachi Authorized Service Facility, and service will be rendered in accordance with the terms of the limited warranty as stated on your warranty card or operating guide.

Should you have any questions regarding warranty, service, operation, or technical assistance, please contact:

**Hitachi America, LTD.
Home Electronics Division**
1855 Dornoch Court
San Diego, CA 92154



**Hitachi Canada, LTD.
Digital Media Division**

Should you have any questions regarding warranty, service, operation, or technical assistance, please contact:

**In Canada:
1-800-HITACHI
(1-800-448-2244)**

**Monday - Friday EST 9:00am - 7:00pm
Saturday EST 9:00am - 5:00pm**

*Look for your French Manual on the outside of the box.
If the manual is missing, call*

**1-800-HITACHI
(1-800-448-2244)**

for a copy.

Pour de plus amples renseignements sur le service durant la période couverte par la garantie, sur le fonctionnement ou pour de l'assistance technique communiquez avec:

**Au Canada:
1-800-HITACHI
(1-800-448-2244)**

**Lundi - Vendredi L'EST 9:00am - 7:00pm
Samedi L'EST 9:00am - 5:00pm**

*La version français de votre manual se trouve a l'exterieur de la boîte.
Si le manuel est manquant, coposez le*

**1-800-HITACHI
(1-800-448-2244)**

pour obenir votre copie.

**HITACHI CANADA, LTD.
6740 Campobello Road
Mississauga, ON L5N 2L8**



A

Accessories, 4
Antennas (Connecting), 5, 6
Aspect Ratio, 23
Audio (Sound Enhancement)
 SRS, 40
 BBE, 40
Audio Settings, 39 - 41
Audio Source, 41
Auto Color, 38
Auto Noise Cancel, 41

B

Balance, 39
Bass, 39
Black Level Expansion, 38
Black Side Panel, 38
Brightness, 35

C

Channel Manager, 42 - 43
Channel Setup, 51
 Auto Channel Scan, 52
Clock
 Time, 50
Closed Captions
 Captions, 56
Color System, 38
Color Temperature, 38
Color, 35
Contrast, 35
Convergence (see Magic Focus)

D

Dimmer, 38

E

Event Timer, 55

I

Input Setup, 53 - 54

L

Language
 Menu Language, 49
Locks
 Change Access Code, 44
 Channel Lock, 44
 Input Lock, 44
 Front Panel Lock, 44
 TV Time Lock, 44
 Movie Ratings, 45
 TV Ratings, 46
 TV Ratings
 (Canadian - English), 47
 TV Ratings
 (Canadian - French), 48
Loudness, 41

M

Magic Focus
 Auto Convergence, 7, 36
 Manual Convergence, 37
Menu Preference
 Language, 49
 Background, 49
Monitor Out, 9

N

Noise Reduction, 38

P

Perfect Volume, 41
Picture Mode, 34
Picture-in-Picture (PIP), 25 - 27
Picture-outside-Picture (POP), 25

R

Remote Control
 Functions, 20 - 31
 Programming Codes, 28 - 31
 Installing Batteries, 4

S

Scan Velocity Modulation, 38
Sharpness, 35
Sound Enhancement, 40
Speakers, 41
 Connecting External Speakers, 5, 13

T

Time, 50
Tint, 35
Treble, 39

V

Vertical Position, 35
Video Settings, 34 - 38

HITACHI

Free Manuals Download Website

<http://myh66.com>

<http://usermanuals.us>

<http://www.somanuals.com>

<http://www.4manuals.cc>

<http://www.manual-lib.com>

<http://www.404manual.com>

<http://www.luxmanual.com>

<http://aubethermostatmanual.com>

Golf course search by state

<http://golfingnear.com>

Email search by domain

<http://emailbydomain.com>

Auto manuals search

<http://auto.somanuals.com>

TV manuals search

<http://tv.somanuals.com>