

HITACHI

PROJECTION COLOR TV

61SBX59B

53SBX59B

OPERATING GUIDE



IMPORTANT SAFEGUARDS

2-4

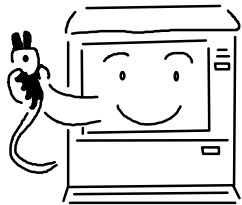

FIRST TIME USE

5-21



**THE GENIUS
REMOTE CONTROL**

22-33



**ULTRATEC BIT-MAP
ON-SCREEN DISPLAY**

34-64

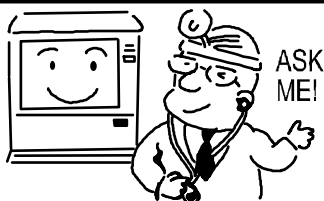







USEFUL INFORMATION INDEX

65-69



IMPORTANT

Follow all warnings and instructions marked on this projection television.

 <table border="1"><tr><td>WARNING</td><td></td></tr><tr><td colspan="2">RISK OF ELECTRIC SHOCK DO NOT OPEN</td></tr></table>	WARNING		RISK OF ELECTRIC SHOCK DO NOT OPEN		 <p>The lightning flash with arrowhead symbol, within an equilateral triangle, is intended to alert the user to the presence of uninsulated dangerous voltage within the product's enclosure that may be of a sufficient magnitude to constitute a risk of electric shock to persons.</p>
WARNING					
RISK OF ELECTRIC SHOCK DO NOT OPEN					
<p>CAUTION: TO REDUCE THE RISK OF ELECTRIC SHOCK, DO NOT REMOVE COVER (OR BACK). NO USER SERVICEABLE PARTS INSIDE. REFER SERVICING TO QUALIFIED SERVICE PERSONNEL.</p>	 <p>The exclamation point within an equilateral triangle, is intended to alert the user to the presence of important operating and maintenance (servicing) instructions in the literature accompanying the appliance.</p>				

WARNING:
TO PREVENT FIRE OR SHOCK HAZARD, DO NOT EXPOSE
THIS PROJECTION TELEVISION TO RAIN OR MOISTURE.

NOTE: ¥There are no user serviceable parts inside the television.
¥Model and serial numbers are indicated on back side of the television.
¥This television is not intended for use in a computer room.

CAUTION: Adjust only those controls that are covered in the instructions, as improper changes or modifications not expressly approved by HITACHI could void the user's authority to operate the TV.



MODIFICATIONS: The FCC requires the user to be notified that any changes or modifications made to this device that are not expressly approved by Hitachi America, Ltd. Home Electronics Division may void the user's authority to operate the equipment.

POWER SOURCE

This projection television is designed to operate on 120 volts 60Hz, AC current.
Insert power cord into a 120 volt 60Hz outlet.

TO PREVENT ELECTRIC SHOCK, DO NOT USE THE TELEVISION'S (POLARIZED) PLUG WITH AN EXTENSION CORD, RECEPTACLE, OR OTHER OUTLET UNLESS THE BLADES AND GROUND TERMINAL CAN BE FULLY INSERTED TO PREVENT BLADE EXPOSURE.

NEVER CONNECT THE TELEVISION TO 50HZ, DIRECT CURRENT, OR ANYTHING OTHER THAN THE SPECIFIED VOLTAGE.

NOTE: This television receiver will display television closed captioning, ( or ) in accordance with paragraph 15.119 of the FCC rules.

 **CAUTION:** Never remove the back cover of the television as this can expose you to very high voltages and other hazards. If the television does not operate properly, unplug the television and call your authorized dealer or service shop.



IMPORTANT SAFEGUARDS

- CAUTION:**
- ✧ Read all of these instructions.
 - ✧ Save these instructions for later use.
 - ✧ Follow all warnings and instructions marked on the television.









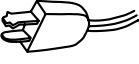
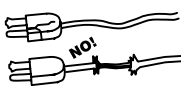

SAFETY POINTS YOU SHOULD KNOW ABOUT YOUR HITACHI PROJECTION TELEVISION

Our reputation has been built on the quality, performance, and ease of service of HITACHI televisions.



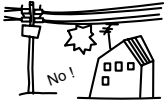



Safety is also foremost in our minds in the design of these units. To help you operate these products properly, this section illustrates safety tips which will be of benefit to you. Please read it carefully and apply the knowledge you obtain from it to the proper operation of your HITACHI television.

Please fill out your warranty card and mail it to HITACHI. This will enable HITACHI to notify you promptly in the improbable event that a safety problem should be discovered in your product model.

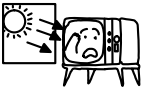
FOR YOUR PERSONAL SAFETY

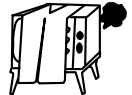
1. This television set is equipped with a polarized alternating-current line plug (a plug having one blade wider than the other.) This plug will fit into the power outlet only one way. This is a safety feature. If you are unable to insert the plug fully into the outlet, try reversing the plug. If the plug should still fail to fit, contact your electrician to replace your obsolete outlet. Do not defeat the safety purpose of the polarized plug.
 
2. When the power cord or plug is damaged or frayed, unplug the television from the wall outlet and refer servicing to qualified service personnel.
 
3. Do not overload wall outlets and extension cords as this can result in fire or electric shock.
 
4. Do not allow anything to rest on or roll over the power cord, and do not place the television where the power cord is subject to traffic or abuse. This may result in a shock or fire hazard.
 
5. Do not attempt to service the television yourself as opening or removing covers may expose you to dangerous voltage or other hazards. Refer all servicing to qualified service personnel.
 
6. Never push objects of any kind into the television's cabinet slots as they may touch dangerous voltage points or short out parts that could result in a fire or electric shock. Never spill liquid of any kind on the television.
 
7. If the television has been dropped or the cabinet has been damaged, unplug the television from the wall outlet and refer servicing to qualified service personnel.
 
8. If liquid has been spilled into the television set, unplug it from the wall outlet and refer service to qualified service personnel.
 
9. Do not subject your television to impact of any kind. Be careful not to damage the picture tube surface.
 
10. Unplug the television from the wall outlet before cleaning. Use a damp cloth for cleaning. Do not use liquid or aerosol cleaners.
 
- 11-1. Do not place the television on an unstable cart, stand, or table. The television may fall, causing serious injury to a child or an adult, and serious damage to the appliance. Use only with a cart or stand recommended by the manufacturer, or sold with the television. Wall or shelf mounting should follow the manufacturer's instructions, and should use a mounting kit approved by the manufacturer.
 
- 11-2. An appliance and cart combination should be moved with care. Quick stops, excessive force, and uneven surfaces may cause the appliance and cart combination to overturn.
 

PROTECTION AND LOCATION OF YOUR TELEVISION

12. Do not use the television near water, for example, near a bathtub, washbowl, kitchen sink, or laundry tub, in a wet basement, or near a swimming pool, etc.
 
- ✧ Never expose the television to rain or water. If the set has been exposed to rain or water, unplug television from wall outlet and refer to qualified service personnel.
 
13. Choose a place where light (artificial or sunlight) does not shine directly on the screen.
 
14. Avoid dusty places. Accumulated dust inside the chassis may cause failure of the television when high humidity persists.
 
15. The television has slots or openings in the cabinet for ventilation purposes which provide reliable operation of the receiver and protect the television from overheating. These openings must not be blocked or covered.
 
- ✧ Never block the bottom ventilation slots of the television by placing it on a bed, sofa, rug, etc.
 
- ✧ Never place the television near or over a radiator or heat register.
 
- ✧ Never place the television in a built-in enclosure unless proper ventilation is provided.
 



PROTECTION AND LOCATION OF YOUR TELEVISION

16-1. If an outside antenna is connected to the television, be sure the antenna system is grounded so as to provide some protection against voltage surges and built-up static charges. Section 810 of the National Electrical Code, NFPA No. 70-1975, provides information with respect to proper grounding of the mast and supporting structure, grounding of the lead-in wire to an antenna discharge unit, size of grounding conductors, location of antenna discharge unit connection to grounding electrode, and requirements for the grounding electrode.

16-2. **Note to CATV system installer:** (Only for television with CATV reception). This reminder is provided to call the CATV system installer's attention to Article 820-40 of the NEC that provides guidelines for proper grounding and, in particular, specifies that the cable ground shall be connected to the grounding system of the building, as close to the point of cable entry as practical.

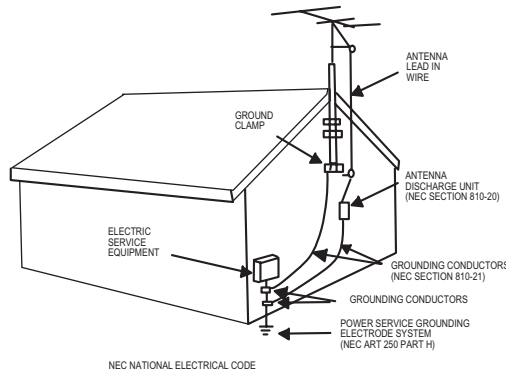

EXAMPLE OF ANTENNA GROUNDING AS PER NATIONAL ELECTRICAL CODE INSTRUCTIONS.

17. An outside antenna system should not be located in the vicinity of overhead power lines or other electrical lights or power circuits, or where it can fall into such power lines or circuits. When installing an outside antenna system, extreme care should be taken to keep from touching such power lines or circuits as contact with them might be fatal.

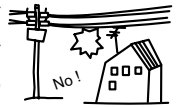

18. For added protection for the television during a lightning storm, or when it is unused for long periods of time, unplug it from the wall outlet and disconnect antenna. This will prevent damage due to lightning and power-line surges.

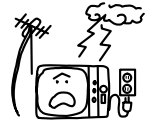

OPERATION OF YOUR TELEVISION

19. This television should be operated only from the type of power source indicated on the marking label. If you are not sure of the type of power supply at your home, consult your dealer or local power company. For televisions designed to operate from battery power, refer to the operating instructions.



20. If the television does not operate normally by following the operating instructions, unplug the television from the wall outlet and refer servicing to qualified service personnel. Adjust only those controls that are covered in the instructions as improper adjustment of other controls may result in damage and will often require extensive work by a qualified service technician to restore the television to normal operation.



21. If your television is to remain unused for a period of time, (such as when going on a holiday), turn the television OFF and unplug it from the wall outlet.



IF THE TELEVISION DOES NOT OPERATE PROPERLY

22. If you are unable to restore normal operation by following the detailed procedure in your operating instructions, do not attempt any further adjustments. Unplug the television and call your dealer or service technician.



23. Whenever the television is damaged or fails, or if there is a distinct change in performance that indicates a need for service, unplug the television and have it checked by a qualified service technician.

24. It is normal for some televisions to make occasional snapping or popping sounds, particularly when being turned on or off. If the snapping or popping is continuous or frequent, unplug the set and consult your dealer or service technician.

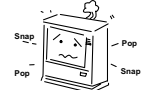

FOR SERVICING AND MODIFICATION

25. Do not use attachments not recommended by the television manufacturer as they may cause hazards.



26. If replacement parts are required, be sure the service technician has used replacement parts specified by the manufacturer that have the same characteristics as the original part. Unauthorized substitutions may result in fire, electric shock, or other hazards.

27. Upon completion of any service or repairs to the television, ask the service technician to perform routine safety checks to determine that the television is in safe operating condition.



PICTURE CAUTIONS

Picture Burn Prevention

¥ Continuous on-screen displays such as video games, stock market quotations, computer generated graphics, and other fixed (non-moving) patterns can cause permanent damage to projection television receivers. Such **PATTERN BURNS** constitute misuse and are **NOT COVERED** by your HITACHI Factory Warranty.

¥ When using Picture-in-Picture function, the sub-picture should not be left permanently in one corner of the screen or a **PATTERN BURN** may develop over a long period of time.

Public Viewing of Copyrighted Material

Public viewing of programs broadcast by TV stations and cable companies, as well as programs from other sources, may require prior authorization from the broadcaster or owner of the video program material.

ACCESSORIES



Check to make sure you have the following accessories before disposing of the packing material.

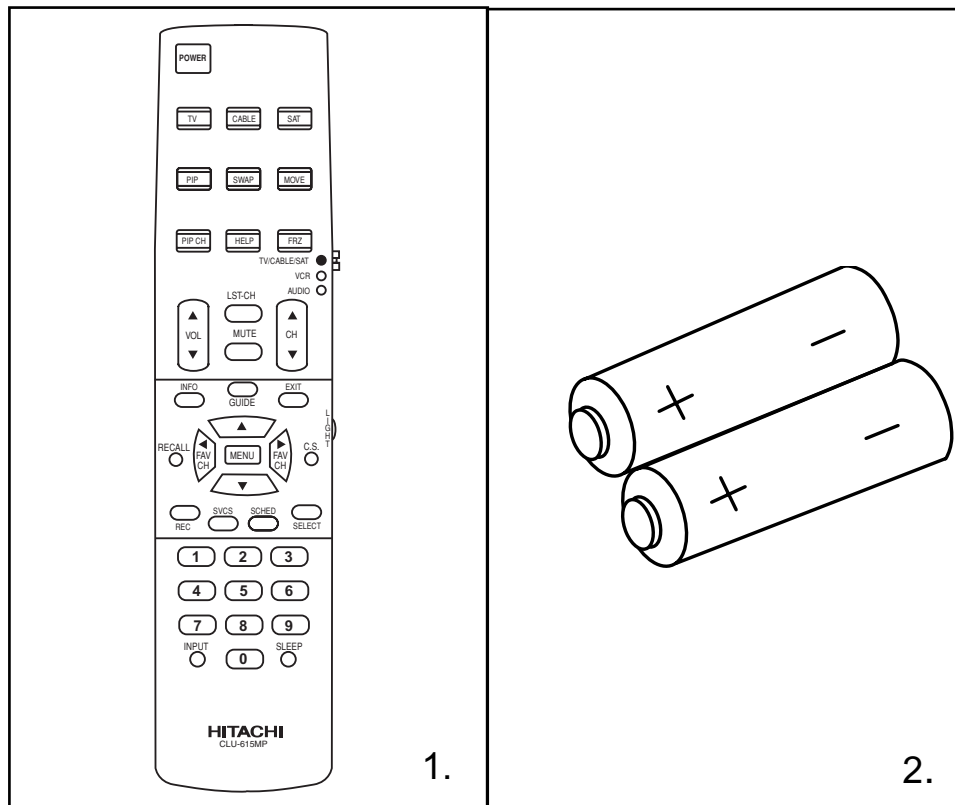

1. Remote Control Unit CLU-615MP (Part No. HL00715).
2. Two AA size, 1.5V batteries (For Remote Control Unit).

REMOTE CONTROL BATTERY INSTALLATION AND REPLACEMENT

1. Open the battery cover of the remote control by pushing the notched part of the cover with your fingers and pulling the cover off.
2. Insert two new AA size batteries for the remote control. When replacing old batteries, push them towards the springs and lift them out.
3. Match the batteries to the (+) and (-) marks in the battery compartment.
4. Replace the cover.

BOTTOM VIEW

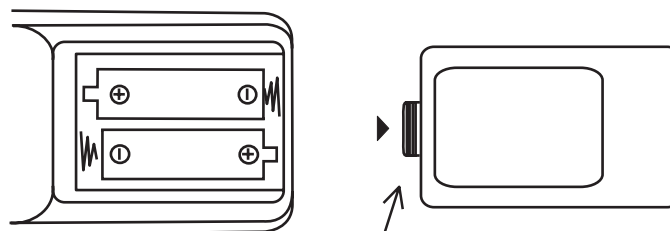

Lift up on tab to
remove back cover.



HOW TO SET UP YOUR NEW HITACHI PROJECTION TV

ANTENNA

Unless your TV is connected to a cable TV system or to a centralized antenna system, a good outdoor color TV antenna is recommended for best performance. However, if you are located in an exceptionally good signal area that is free from interference and multiple image ghosts, an indoor antenna may be sufficient.

LOCATION

Select an area where sunlight or bright indoor illumination will not fall directly on the picture screen. Also, be sure that the location selected allows a free flow of air to and from the perforated back cover of the set.

To avoid cabinet warping, cabinet color changes, and increased chance of set failure, do not place the TV where temperatures can become excessively hot, for example, in direct sunlight or near a heating appliance, etc.

VIEWING

The major benefit of the HITACHI Projection Television is its large viewing screen. To see this large screen at its best, test various locations in the room to find the optimum spot for viewing.

The best picture is seen by sitting directly in front of the TV and about 10 to 18 feet from the screen. Picture brightness decreases as the viewer moves to the left and right of the receiver.

During daylight hours, reflections from outside light may appear on the screen. If so, drapes or screens can be used to reduce the reflection or the TV can be located in a different section of the room.

If the TV's audio output will be connected to a Hi-Fi system's external speakers, the best audio performance will be obtained by placing the speakers equidistant from each side of the receiver cabinet and as close as possible to the height of the picture screen center. For best stereo separation, place the external speakers at least four feet from the side of the TV, place the surround speakers to the side or behind the viewing area. Differences in room sizes and acoustical environments will require some experimentation with speaker placement for best performance.

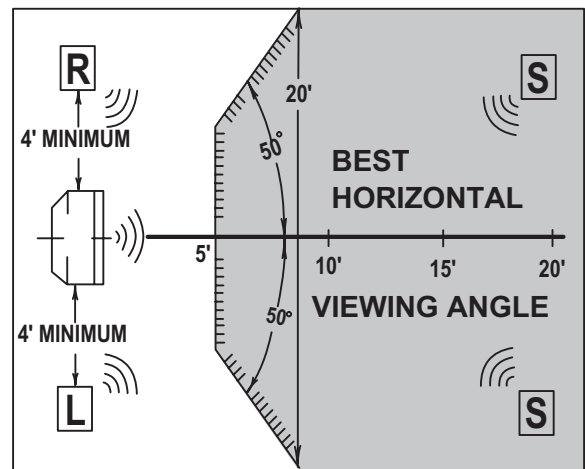
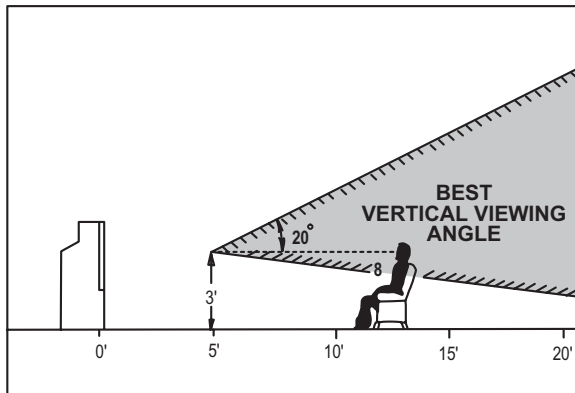

CAUTION: Magnetic fields, such as those of external speakers, may cause the picture to distort if they are placed too close to the television. Move the magnetic field source away from the television until there is no picture distortion.



HOOK-UP CABLES AND CONNECTORS

Most video/audio connections between components can be made with shielded video and audio cables that have phono connectors. For best performance, video cables should use 75-Ohm coaxial shielded wire. Cables can be purchased from most stores that sell audio/video products. Below are illustrations and names of common connectors. Before purchasing any cables, be sure of the output and input connector types required by the various components and the length of each cable.

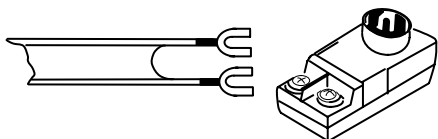

300-Ohm Twin Lead Connector

This outdoor antenna cable must be connected to an antenna adapter (300-Ohm to 75-Ohm).



S-Video (Super Video) Connector

This connector is used on camcorders, VCRs, and laserdisc players with an S-Video feature in place of the standard video cable to produce a high quality picture.

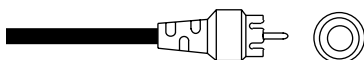

Phono Connector

Used on all standard video and audio cables which connect to inputs and outputs located on the television's rear jack panel and front control panel.



"F" Type 75-Ohm Coaxial Antenna Connector

For connecting RF signals (antenna or cable TV) to the antenna jack on the television.

ANTENNA CONNECTIONS TO REAR JACK PANEL

VHF (75-Ohm) antenna/CATV (Cable TV)

When using a 75-Ohm coaxial cable system, connect the outdoor antenna or CATV coaxial cable to the ANT A (75-Ohm) terminal. If you have a second antenna or cable TV system, connect the coaxial cable to the ANT B terminal.

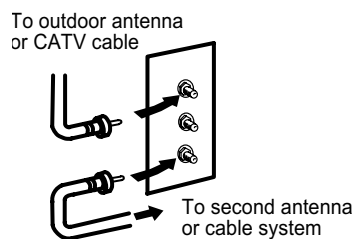

VHF (300-Ohm) antenna/UHF antenna

When using a 300-Ohm twin lead from an outdoor antenna, connect the VHF or UHF antenna leads to screws of the VHF or UHF adapter. Plug the adapter into the antenna terminal on the TV.

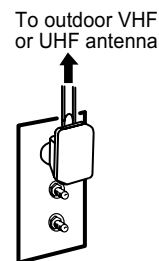

When both VHF and UHF antennas are connected

Attach an optional antenna cable mixer to the TV antenna terminal, and connect the cables to the antenna mixer. Consult your dealer or service store for the antenna mixer.

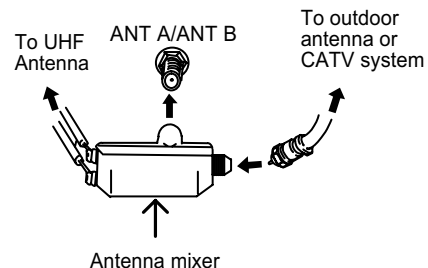



FRONT PANEL CONTROLS

FRONT VIEW

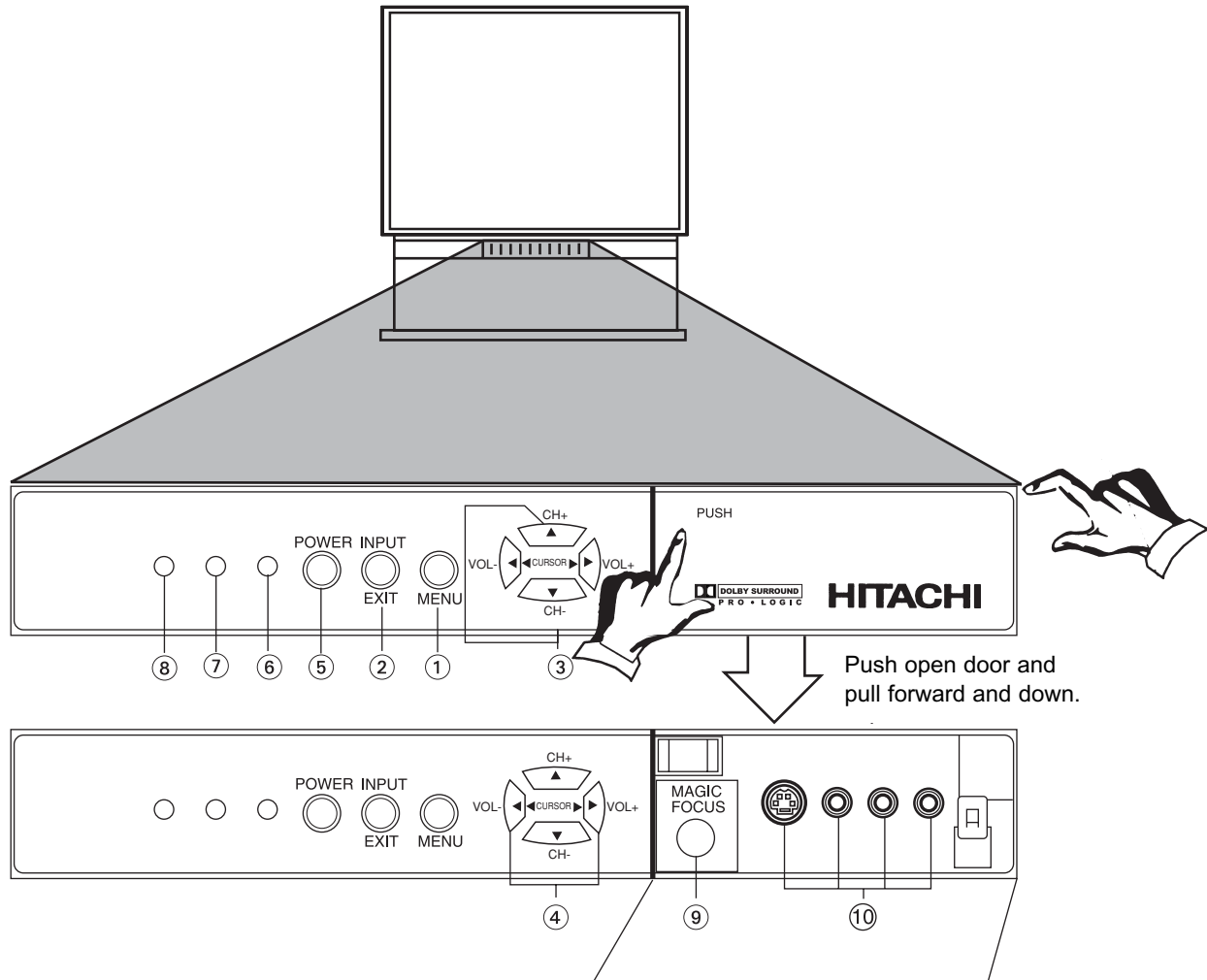

① MENU button

This button allows you to enter the MENU, making it possible to set TV features to your preference without using the remote.

② INPUT/EXIT button

Press this button to select the current antenna source, VIDEO: 1, 2, 3, or alternate antenna source. Your selection is shown in the top right corner of the screen. This button also serves as the EXIT button when in MENU mode.

③ CHANNEL selector

Press these buttons until the desired channel appears in the top right corner of the TV screen. These buttons also serve as the cursor down (▼) and up (▲) buttons when in MENU mode.

④ VOLUME level

Press these buttons for your desired sound level. The volume level will be displayed on the TV screen. These buttons also serve as the cursor left (◀) and right (▶) buttons when in MENU mode.

⑤ POWER button

Press this button to turn the TV on or off.

NOTES: Your HITACHI Projection TV will appear to be turned OFF if there is no video input when VIDEO: 1, 2, or 3 is selected. Check the Power Light to make sure the TV is turned off when not in use.

To see an auto-demonstration of the on-screen displays with HELP text displayed, press and hold the POWER button on the TV set for approximately five seconds. Press the POWER button on the TV again to end the auto-demonstration.

FRONT PANEL CONTROLS



- ⑥ **POWER light**
You will see a red light when the TV is turned on.

- ⑦ **AI (Artificial Intelligence) sensor**
The Artificial Intelligence sensor will make automatic picture adjustments depending on the amount of light in the room to give the best picture. (See page 54.)

- ⑧ **REMOTE CONTROL sensor**
Point your remote at this area when selecting channels, adjusting volume, etc.

- ⑨ **MAGIC FOCUS**
Use this button to adjust your picture quality to optimum performance. (See page 43.)

- ⑩ **FRONT INPUT JACKS (for VIDEO: 3)**
Use these audio/video jacks for a quick hook-up from a camcorder or VCR to instantly view your favorite show or new recording. Press the INPUT button until VIDEO: 3 appears in the top right corner of the TV screen. If you have mono sound, insert the audio cable into the left channel jack.



FRONT PANEL JACKS AND CONNECTIONS

The front panel jacks are provided as a convenience to allow you to easily connect a camcorder or VCR as shown in the following examples:

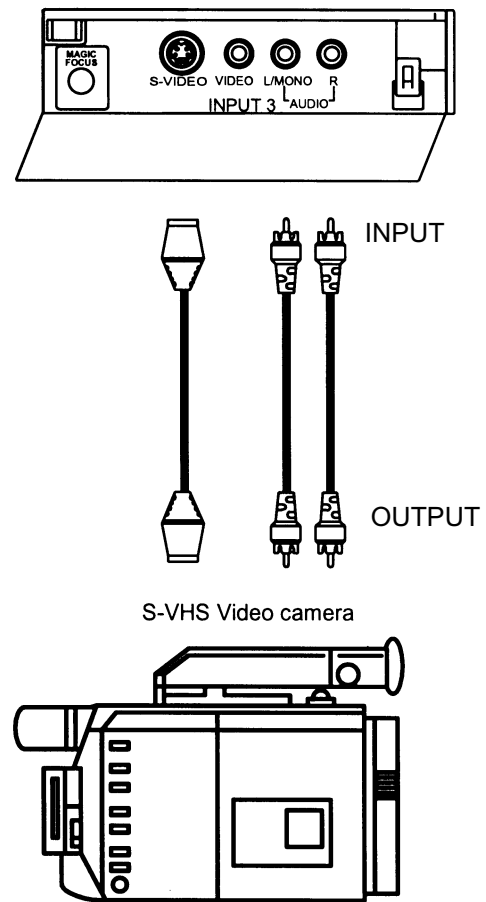
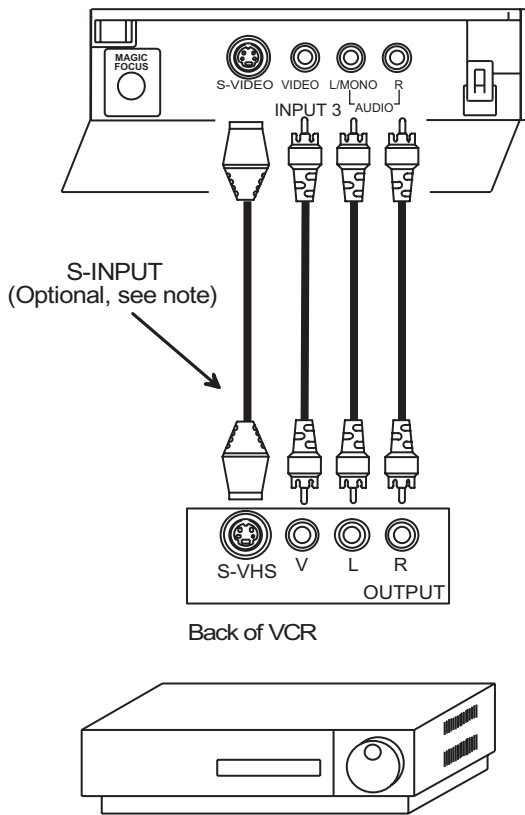

NOTE: Completely insert connection cord plugs when connecting to front panel jacks. If you do not, the played back picture may be abnormal. If you have a S-VHS VCR, use the S-INPUT cable in place of the standard video cable. If you have a mono VCR, insert the audio cable into the left channel jack of your TV.

REAR PANEL JACKS

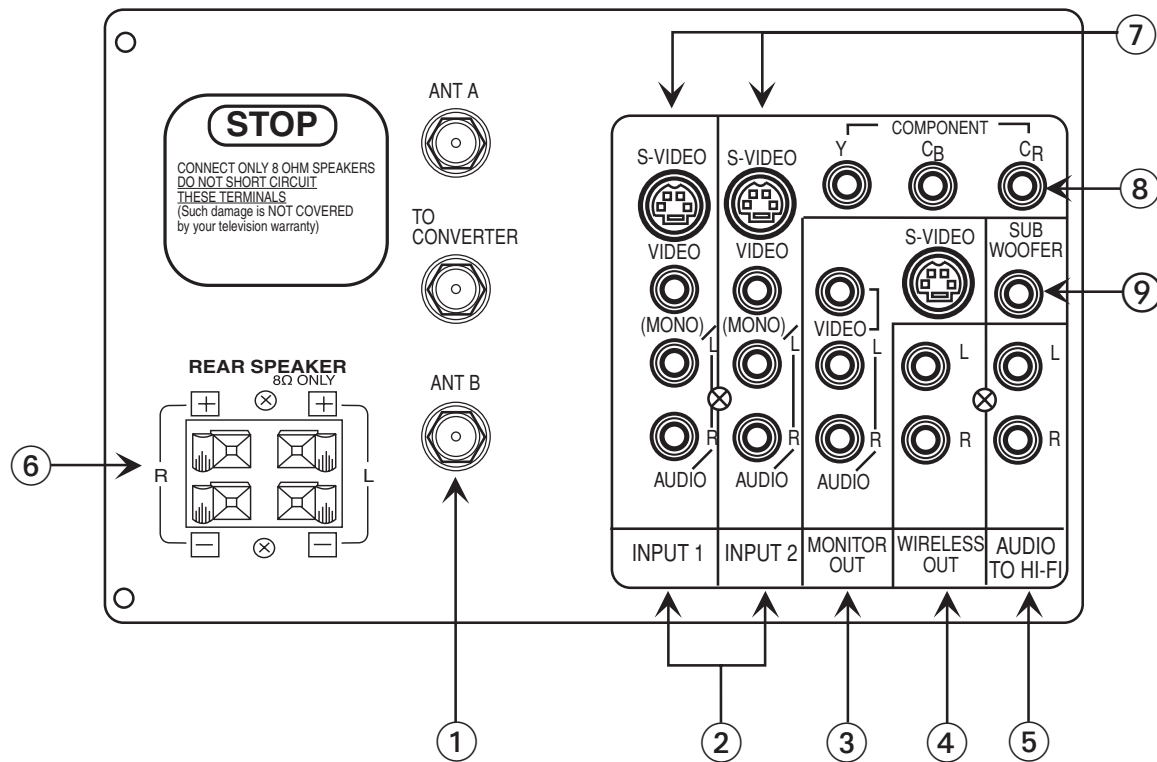

① Antenna Input/Output

The remote control allows you to switch between two separate 75-Ohm RF antenna inputs, ANT A and ANT B. ANT A input can be displayed as a main picture or sub-picture. ANT B can only be displayed as a main picture. (ANT B cannot be displayed as a sub-picture.) The antenna output labeled TO CONVERTER allows the ANT A connection to pass directly to a different source such as a cable box, when ANT B is displayed as a main picture.

② Audio/Video Inputs 1, 2

The INPUT button will step through each video source and antenna source input each time it is pressed. Use the audio and video inputs to connect external devices, such as VCRs, camcorders, laserdisc players, DVD players etc. (If you have mono sound, insert the audio cable into the left channel jack.)

NOTE: You may use VIDEO, S-VIDEO, or COMPONENT: Y-C_BC_R inputs to connect to Input 2, but note that only one of these may be used at a time.

③ Monitor Out

These jacks provide fixed audio and video signals which are used for recording. To have S-Video output, S-Video signal needs to be input to input 1 or input 2, or input 3.

④ Wireless Out

These jacks provide variable audio output to a set of wireless speakers. They can also be used for another stereo system amplifier. With this connection, the audio can be controlled by the television's main volume and also by an independent volume feature found in the THEATER-WIRELESS SOUND menu.

⑤ Audio to HI-FI

These jacks provide variable audio output to a separate stereo amplifier. With this connection, the audio to the stereo can be controlled by the television's main volume. Use these jacks for the SURROUND Left and Right channels. (See page 20).

⑥ Rear Speaker Terminals

These terminals are used to connect external speakers, which are used for the surround sound feature. The volume level is controlled by the television's main volume and also by an independent rear volume feature found in the THEATER-SURROUND menu. Use speakers with 8-Ohm impedance only.



⑦ S-Video Inputs 1 and 2

Inputs 1 and 2 provide S-Video (Super Video) jacks for connecting equipment with S-Video output capability.

⑧ Component: Y-C_BC_R Input 2

Input 2 provides Y-C_BC_R jacks for connecting equipment with this capability, such as a DVD player.

NOTES: DO NOT connect standard VIDEO or S-VIDEO to Input 2 when using Y-C_BC_R input.

When using the Y-C_BC_R input jacks, connect your components audio output to the TV's Input 2 Left and Right Audio input jacks.

Your component outputs may be labeled Y, B-Y, and R-Y. In this case, connect the components B-Y output to the TV's C_b input and the components R-Y output to the TV's C_R input.

It may be necessary to adjust TINT or turn AUTO COLOR-ON to obtain optimum picture quality when using the Y-C_BC_R inputs. (See pages 53 and 54.)

To ensure no copyright infringement, the MONITOR OUT output will be abnormal, when using the Y-C_BC_R jacks.

When using the Y-C_BC_R jacks, Input 2 will be viewed as a blank PIP sub-picture. (See page 27.)

⑨ Sub Woofer

This jack provides variable audio output to a sub-woofer accessory. With this connection, the audio can be controlled by the television's main volume and also by an independent sub-woofer volume feature found in the THEATER-SUB WOOFER menu.

REAR PANEL CONNECTIONS

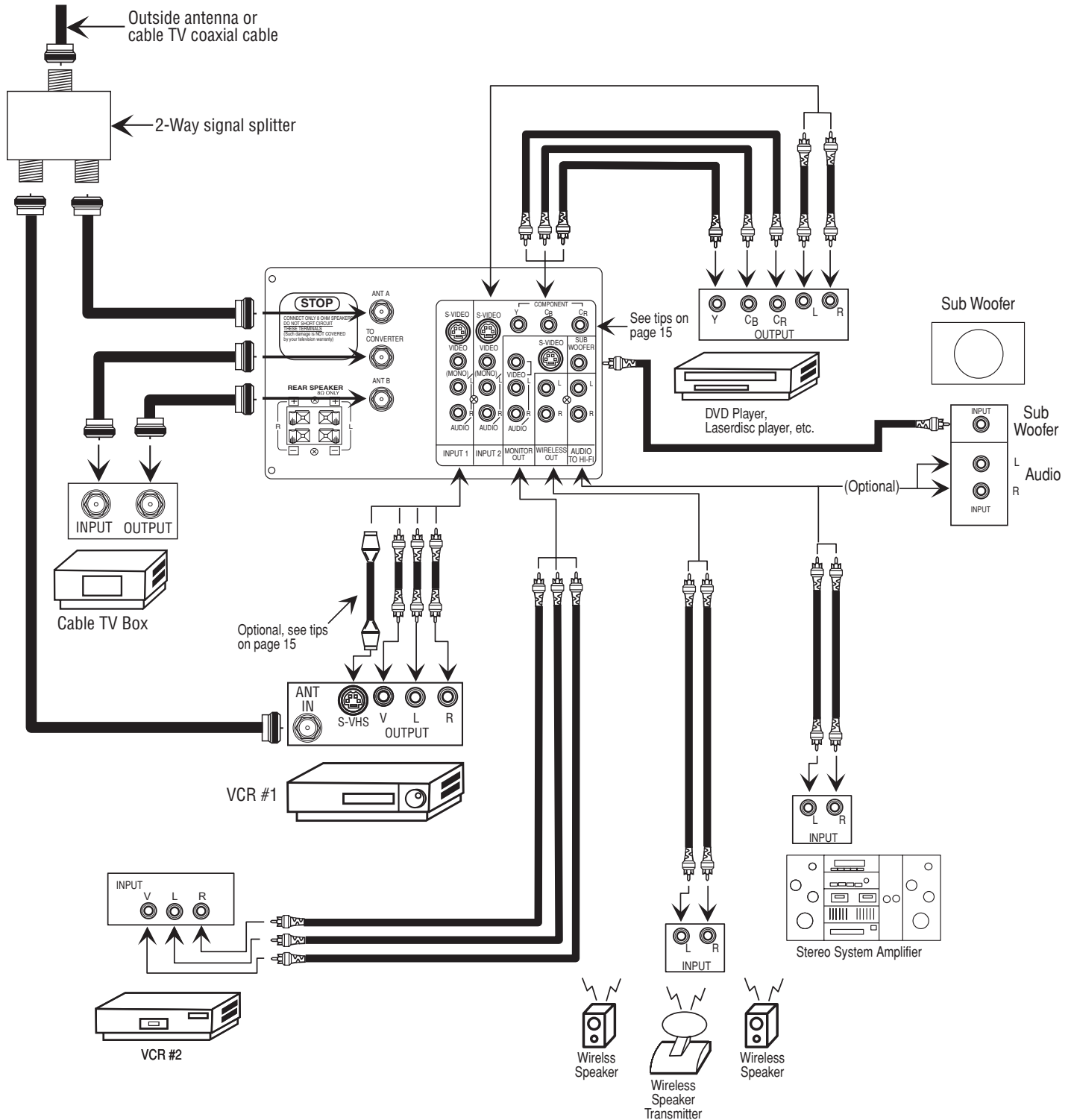

Typical full feature setup. Follow connections that pertain to your personal entertainment system.



REAR SPEAKER TERMINAL CONNECTIONS

CONNECT AFTER TURNING THE POWER TO THE TV OFF.

Press the Right Speaker button and insert the positive (+) lead wire into the hole next to the button. Once the wire is in place, pull the red button back to original position and the wire is locked into place. In the same manner, press the Right Speaker black button and insert the negative (-) lead wire. Repeat this procedure for the Left Speaker.



CAUTION: Do not short speaker terminal, (do not connect a wire directly across any two terminals). This could cause damage to your audio outputs or other damage to your TV.

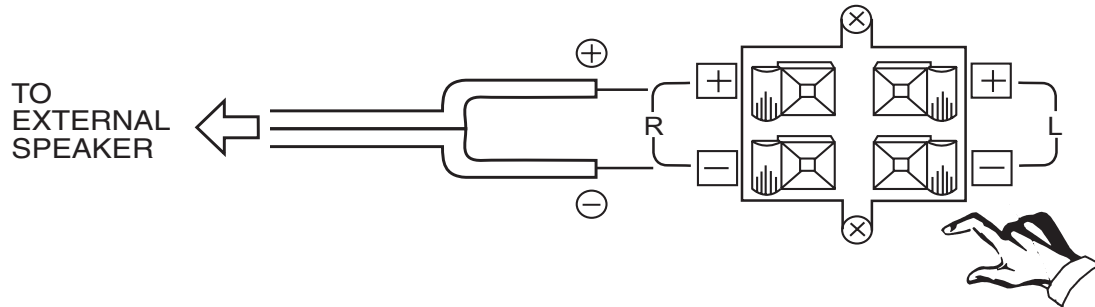

CAUTION: Do not connect speakers simultaneously to the REAR SPEAKER terminal of the Projection TV and an external amplifier. This could damage both the TV and the speakers. your TV was designed to use 8-Ohm speakers only. Any other type may degrade the audio performance of your entertainment system.

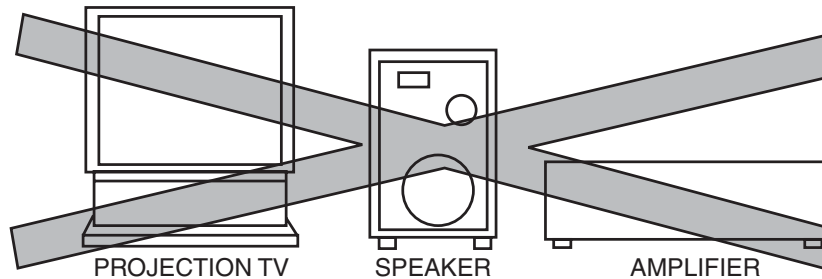

TIPS ON REAR PANEL CONNECTIONS



TIPS ON REAR PANEL CONNECTIONS

S-Video connections are provided for high performance laserdisc players, VCRs etc. that have this feature. Use these connections in place of the standard video connection if your device has this feature.

If your device has only one audio output (mono sound), connect it to the left audio jack on the television.

Refer to the operating guide of your other electronic equipment for additional information on connecting your hook-up cables.

A single VCR can be used for VCR#1 and VCR#2, but note that a VCR cannot record its own video or line output. (INPUT:1 in example on page 11.) Refer to your VCR operating guide for more information on line input-output connection.

You may use VIDEO, S-VIDEO, or COMPONENT: Y-C_BC_R inputs to connect to Input 2, but note that only one of these may be used at a time.

Connect only 1 component to each input jack.

COMPONENT: Y-C_BC_R connections are provided for high performance components, such as DVD players. Use these connections in place of the standard video connection if your device has this feature.

When using the Y-C_BC_R input jacks, connect your components audio output to the TV's Input 2 Left and Right Audio input jacks.

Your component outputs may be labeled Y, B-Y, and R-Y. In this case, connect the components B-Y output to the TV's C_B input and the components R-Y output to the TV's C_R input.

It may be necessary to adjust TINT or turn AUTO COLOR-ON to obtain optimum picture quality when using the Y-C_BC_R inputs. (See pages 53 and 54.)

To ensure no copyright infringement, the MONITOR OUT output will be abnormal, when using the Y-C_BC_R jacks.

When using the Y-C_BC_R jacks, Input 2 will be viewed as a blank PIP sub-picture. (See page 27.)



EXTERNAL CONNECTIONS

CONNECTING EXTERNAL AUDIO AMPLIFIER

To control the audio level of an external audio amplifier with the remote control, connect the system as shown below.

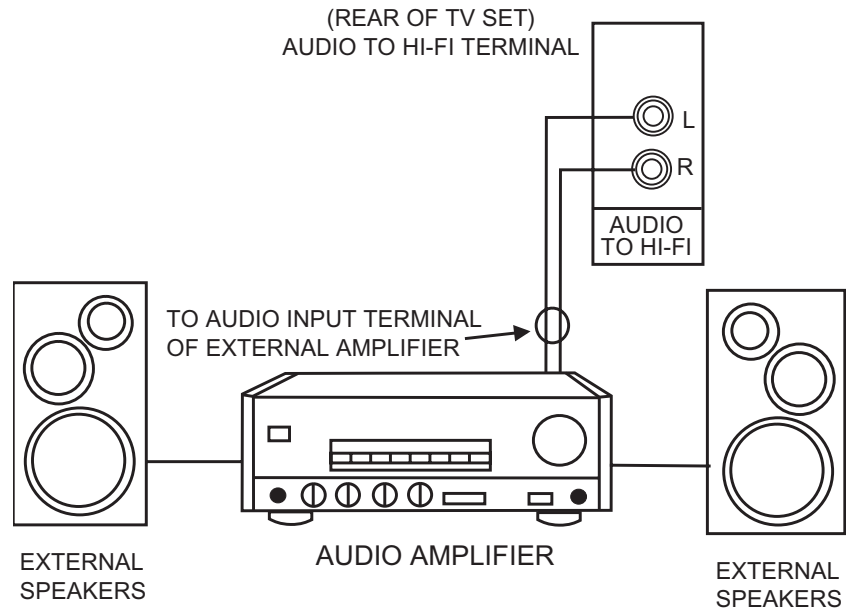

NOTES: To prevent damage to the speaker and distorted sound, set the volume control of the audio amplifier lower and adjust the sound using the remote control of the TV set.

Do not connect speakers simultaneously to the REAR SPEAKER terminal of the Projection TV and an external amplifier.

CONNECTING EXTERNAL VIDEO SOURCES



The exact arrangement you use to connect the VCR, camcorder, laserdisc player, and DVD player to your TV set is dependent on the model and features of each component. Check the owner's manual of each component for the location of video and audio inputs and outputs.

The following connection diagrams are offered as suggestions. However, you may need to modify them to accommodate your particular assortment of components and features. For best performance, video and audio cables should be made from coaxial shielded wire.

Before Operating External Video Source

The input mode is changed every time the INPUT button is pressed as shown below. Connect an external source to the INPUT terminal, then press the INPUT button as necessary to view the input source. (See page 26.)

INPUT MODE SELECTION ORDER

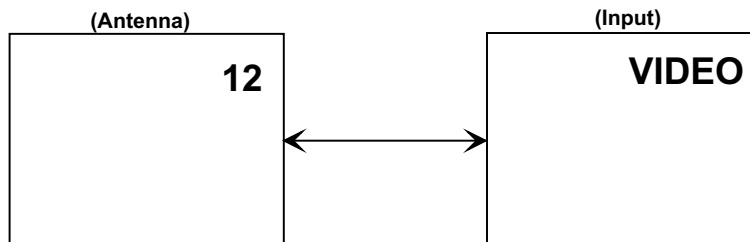

NOTE: When the TV is set to VIDEO and a video signal is not received from the VIDEO INPUT JACK on the jack panel of the TV (i.e., VCR/laserdisc player, etc. is not connected or the video device is OFF), the set will appear to be OFF.

CONNECTING A MONAURAL AUDIO VCR OR LASERDISC PLAYER

1. Connect the cable from the VIDEO OUT of the VCR or the laserdisc player to the INPUT (VIDEO) jack on the TV set below.
2. Connect the cable from the AUDIO OUT of the VCR or the laserdisc player to the INPUT (MONO)/L(AUDIO) jack.
3. Press the INPUT button to view the program from the VCR or the laserdisc player. The VIDEO mode disappears automatically after approximately eight seconds.
4. Press the INPUT button to return to the previous channel.

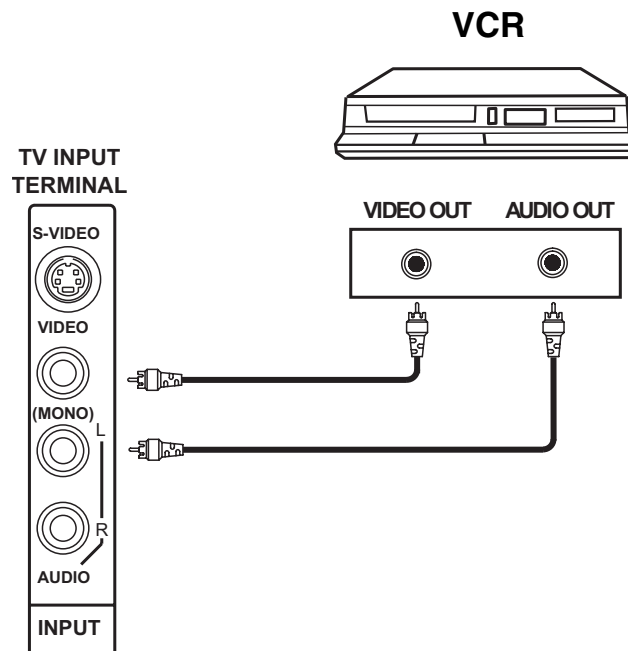



CONNECTING EXTERNAL VIDEO SOURCES

CONNECTING A STEREO VCR OR STEREO LASERDISC PLAYER

1. Connect the cable from the VIDEO OUT of the VCR or the laserdisc player to the INPUT (VIDEO) jack on the TV set below.
2. Connect the cable from the AUDIO OUT R of the VCR or the laserdisc player to the INPUT(AUDIO/R) jack.
3. Connect the cable from the AUDIO OUT L of the VCR or the laserdisc player to the INPUT(AUDIO/L) jack.
4. Press the INPUT button to view the program from the VCR or laserdisc player. The mode VIDEO disappears automatically after approximately eight seconds.
5. Press the INPUT button to return to the previous channel.

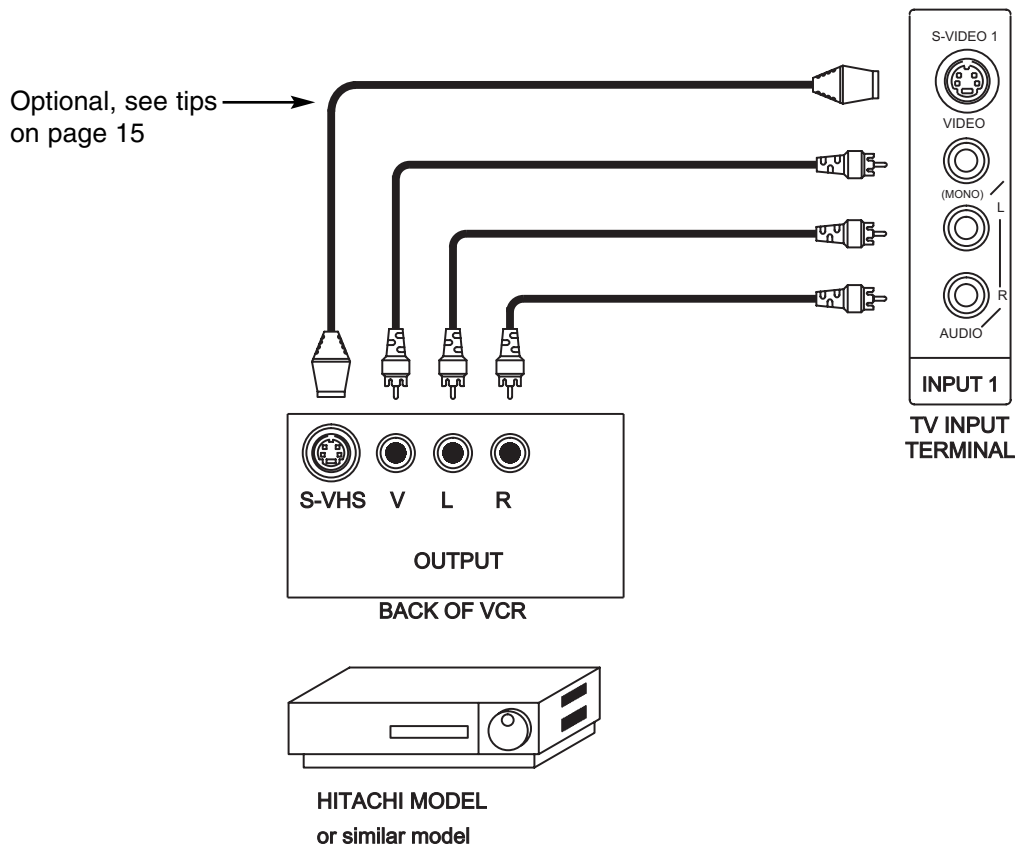

NOTES: Completely insert the connection cord plugs when connecting to rear panel jacks. The picture that is played back will be abnormal if the connection is loose.

If you have an S-VHS VCR, use the S-INPUT cable in place of the standard video cable.

CONNECTING EXTERNAL VIDEO SOURCES



CONNECTING A STEREO LASERDISC PLAYER OR DVD PLAYER TO INPUT 2.

1. Connect the cable from the Y OUT of the Laserdisc or the DVD player to the INPUT 2 (Y) jack as shown on the TV set below.
2. Connect the cable from the C_B OUT or B-Y OUT of the Laserdisc or the DVD player to the INPUT 2 (C_B) jack, as shown on the TV set below.
3. Connect the cable from the C_R OUT or R-Y OUT of the Laserdisc or the DVD player to the INPUT 2 (C_R) jack, as shown on the TV set below.
4. Connect the cable from the AUDIO OUT R of the Laserdisc or DVD player to the INPUT 2 (AUDIO/R) jack.
5. Connect the cable from the AUDIO OUT L of the Laserdisc or DVD player to the INPUT 2 (AUDIO/L) jack.
6. Press the INPUT button until VIDEO:2 appears, to view the program from the Laserdisc or DVD player. The mode VIDEO:2 disappears automatically after approximately eight seconds.
7. Press the INPUT button to return to the previous channel.

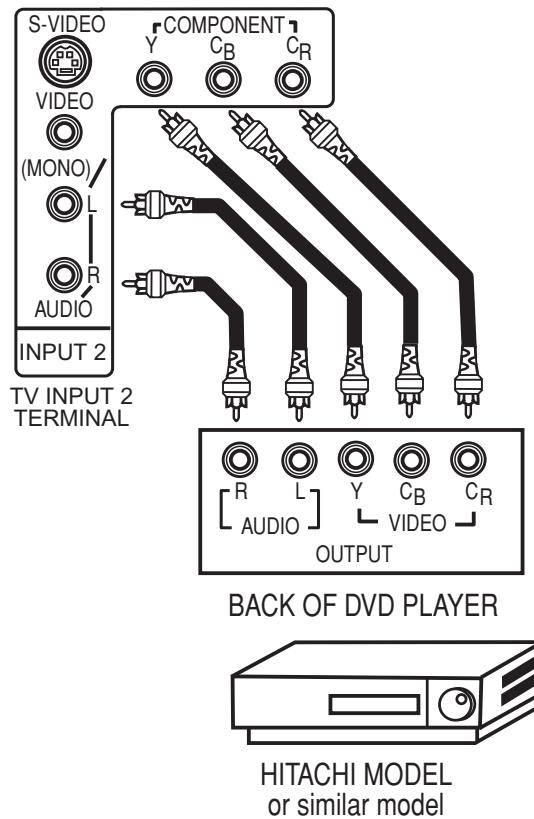

NOTES: Completely insert the connection cord plugs when connecting to rear panel jacks. The picture that is played back will be abnormal if the connection is loose.

See page 15 for tips on REAR PANEL CONNECTIONS.



AUDIO SYSTEM SETUP

Match the numbers below to the diagrams for speaker placement and refer to the table on page 21 for the different surround sound requirements. (See page 58 for SURROUND functions.)

- ① The television's internal speakers.
- ② The television's internal center channel speakers, which are on only when the television is in SURROUND-DOLBY PRO LOGIC or SURROUND-DOLBY 3 STEREO mode.
- ③ These speakers are connected to a separate audio amplifier. Use the AUDIO TO HI-FI output on the TV.
- ④ These speakers are connected to a rear speaker 8-Ohm output on the TV.
- ⑤ These speakers are controlled by a wireless speaker transmitter. Use the WIRELESS OUT output on the TV.
- ⑥ This sub woofer is connected to the SUB WOOFER output on the TV.

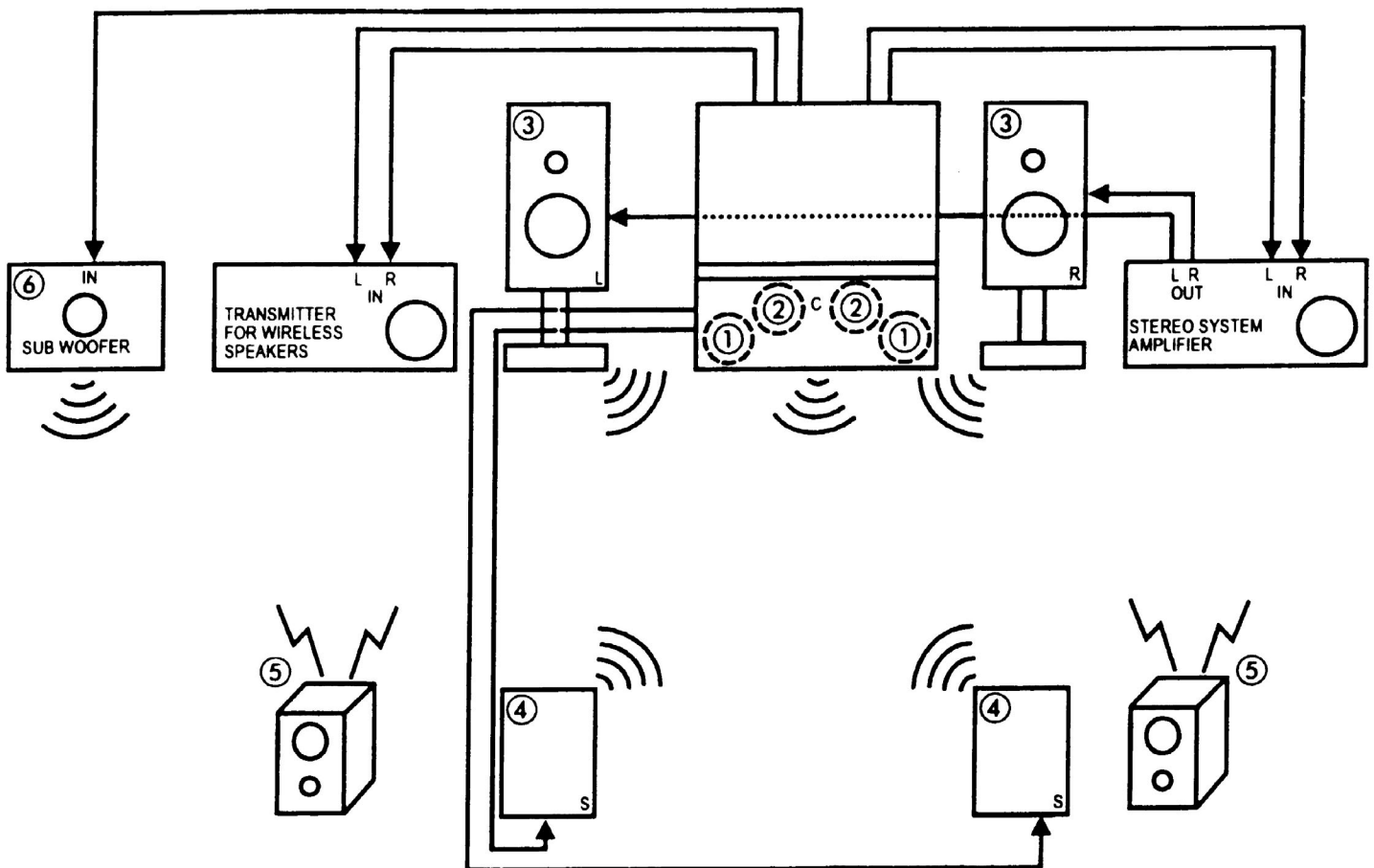

AUDIO SYSTEM SETUP



SURROUND FEATURE	REQUIRED CONNECTION	OPTIONAL CONNECTION	EFFECT
OFF	①	③ ⑤ ⑥	Receive mono and stereo sound.
HALL	① ④	③ ⑤ ⑥	Gives the listener concert hall sound.
MATRIX	① ④	③ ⑤ ⑥	Listener has feeling of being at a stadium.
DOLBY PRO LOGIC (NORMAL)	① ② ④	③ ⑤ ⑥	Movie theater reproduction, with separate left, center, right, and surround speakers.
DOLBY PRO LOGIC* (TV AS CENTER)	② ③ ④	⑤ ⑥	Movie theater reproduction, with separate left, center, right, and surround channels, with left and right channels added to audio amplifier speakers to improve sound clarity and spatial positioning.
DOLBY 3 STEREO (NORMAL)	① ②	③ ⑤ ⑥	Movie theater reproduction, surround channel added to left and right audio amplifier speakers.
DOLBY 3 STEREO* (TV AS CENTER)	② ③	⑤ ⑥	Movie theater reproduction, surround channel added to left and right audio amplifier speakers.

*Left and right speakers are connected (③), and the internal speakers (①) are disabled, creating better separation between left, center and right channels. The center channel audio will be heard from (②).



THE GENIUS REMOTE CONTROL (CLU-615MP)

In addition to controlling all the functions on your HITACHI Projection TV, the remote control is designed to operate different types of VCRs, CATV (cable TV)/satellite converters, and audio equipment with one touch. Basic operation keys are grouped together in one area. All other controls are separated from them and arranged in MULTI-PAGE sections, with a display that can be switched to cover any of the three pages. Functions are arranged and properly categorized into windows, making operation simple when multiple functions are to be controlled.

To operate your TV, slide the MULTI-PAGE select switch on the side of the remote to TV/CABLE/SAT mode. Press the TV button and the remote will now control your television.

To operate your cable box, slide the MULTI-PAGE select switch on the side of the remote to TV/CABLE/SAT mode. Press the CABLE button and the remote will now control your cable box. (See page 31 for instructions on how to program the remote to control your cable box.)

To operate your satellite box, slide the MULTI-PAGE select switch on the side of the remote to TV/CABLE/SAT mode. Press the SAT button and the remote will now control your satellite box. (See page 31 for instructions on how to program the remote to control your satellite box.)

To operate your VCR, slide the MULTI-PAGE select switch on the side of the remote to VCR mode. The remote will now control your VCR. (See page 30 for instructions on how to program the remote to control your VCR.)

To operate your audio equipment, slide the MULTI-PAGE select switch on the side of the remote to AUDIO mode. Press the button which corresponds to the component you would like to control (AMP, CD, TAPE). The remote will now control your audio equipment. (See page 32 for instructions on how to program the remote to control your audio equipment.)

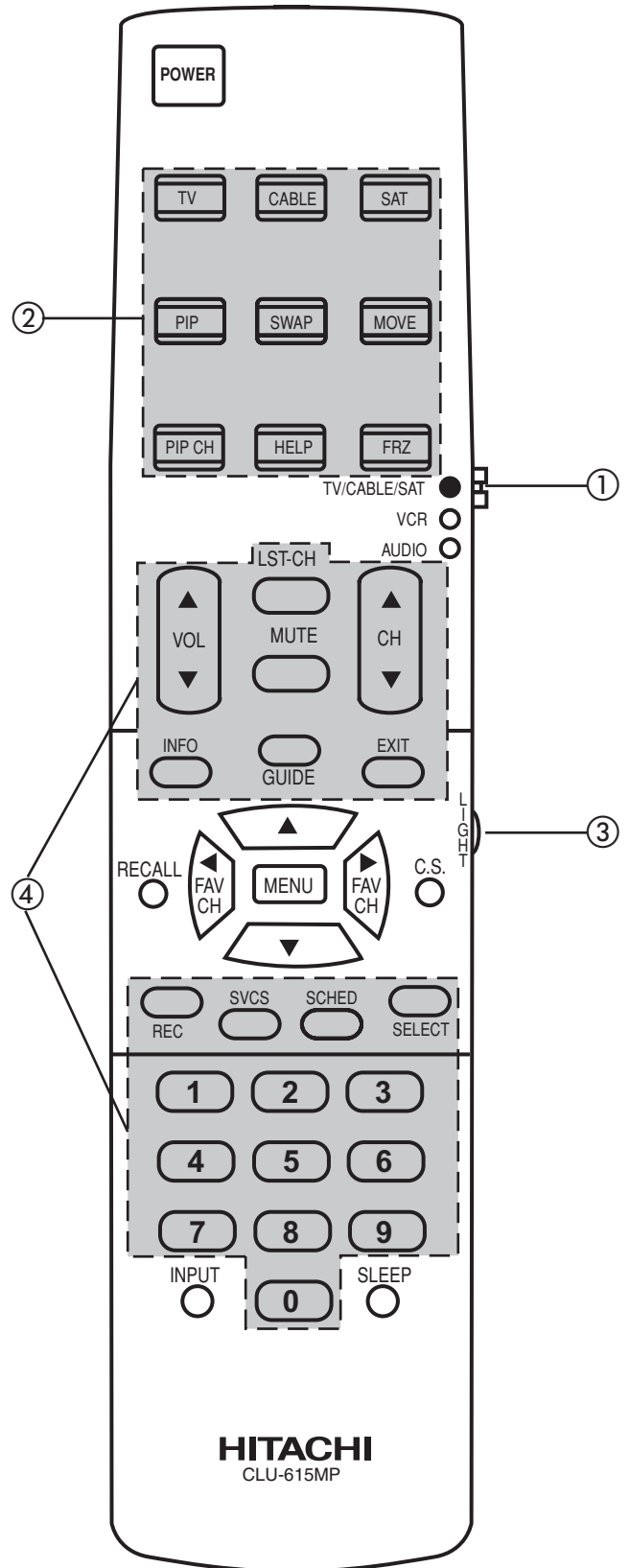

- ① **MULTI-PAGE select switch**
This selects the button layout of the multi-page section of the remote control.
- ② **MULTI-PAGE buttons**
These buttons change functions as shown on page 23.
- ③ **LIGHT button**
When you are in a dark room, press this button on the side of the remote to light up the buttons shown in ④. The light will stay on for about eight seconds if the light button is not pressed again. These buttons will not appear to light if the room is too bright.

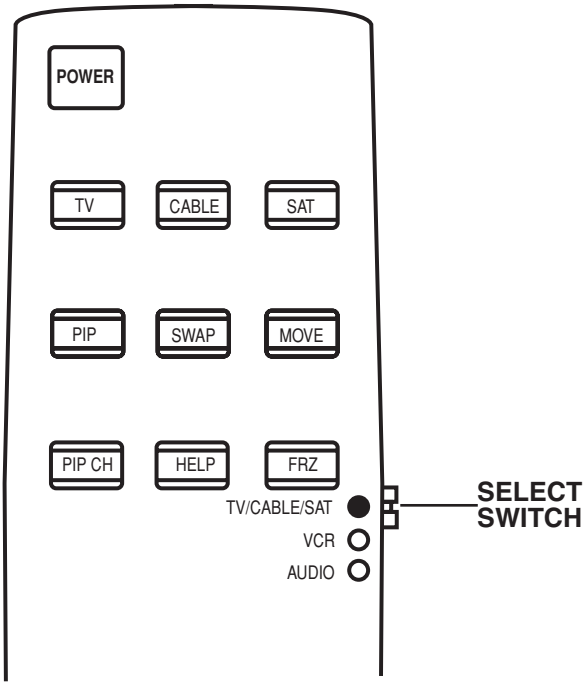

When TV/CABLE/SAT is set.

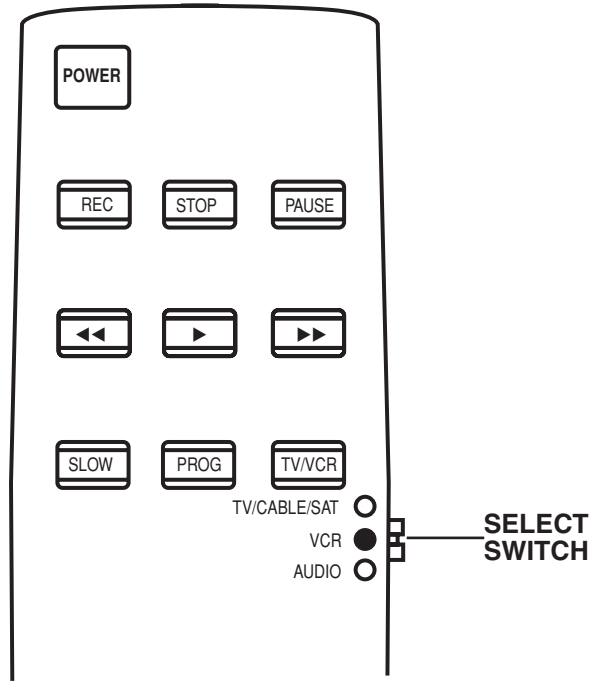

When VCR is set.

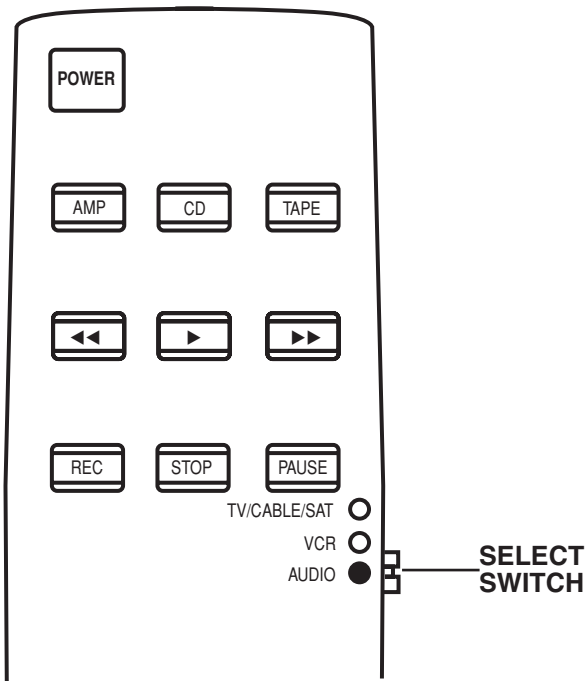

When AUDIO is set.



HOW TO USE THE GENIUS REMOTE TO CONTROL YOUR TV

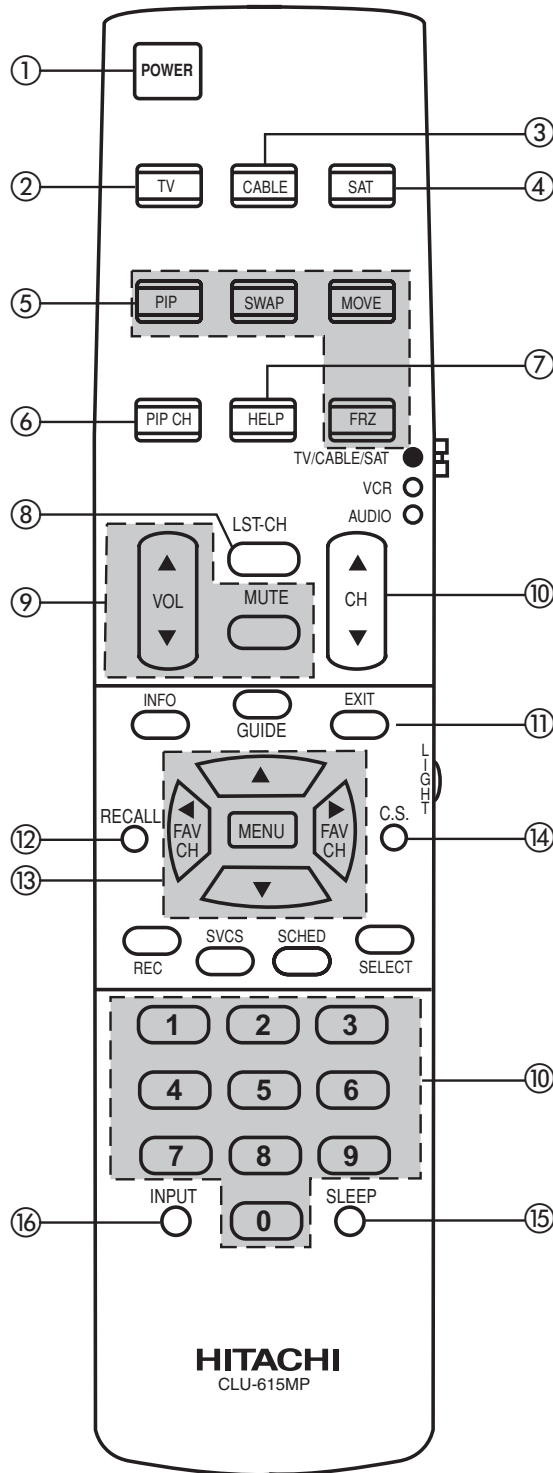

- ① **POWER button**
Press this button to turn the TV set on or off when the remote is in TV mode. (See page 22 for instructions on how to set the remote control to TV mode.) If a Special Event Reminder is set, it will be displayed when the TV is first turned on. (See page 63.)
- ② **TV button**
Press this button to allow the remote to control your TV.
- ③ **CABLE button**
Press this button to allow the remote to control your cable box. (See page 31.)
- ④ **SAT button**
Press this button to allow the remote to control your satellite box. (See page 31.)

HOW TO USE THE GENIUS REMOTE TO CONTROL YOUR TV



⑤ **PICTURE-IN-PICTURE buttons**
See separate section on page 27 for a description.

⑥ **PIP CH button**
Use the PIP CH button to select between main picture and sub-picture tuning. The channel number which is highlighted indicates which channel is being controlled.

⑦ **HELP button**
Press this button when a menu is displayed to view HELP text, which gives a description of the displayed menu. The HELP text will be displayed every time a MENU is displayed, until this button is pressed again.

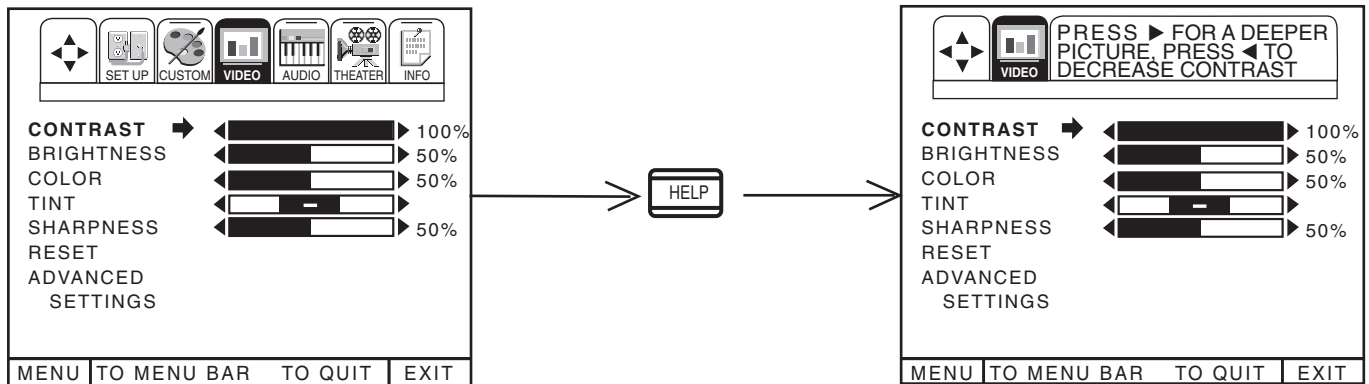

⑧ **LAST CHANNEL (LST-CH) button**
Use this button to select between the last two channels viewed. (Good for watching two sporting events, etc.)

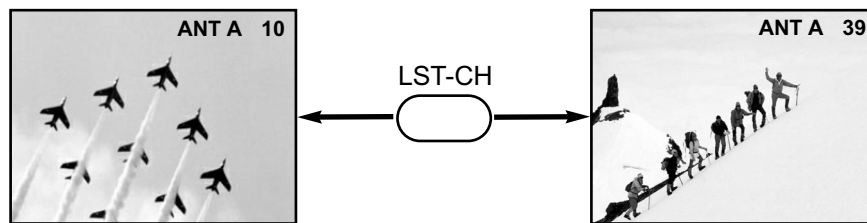

⑨ **VOLUME, MUTE buttons**
Press the VOLUME up (▲) or down (▼) button until you obtain the desired sound level.

To reduce the sound to one half of normal volume (SOFT MUTE) to answer the telephone, etc., press the MUTE button. Press the MUTE button again to turn the sound off completely (MUTE). To restore the sound, press the MUTE button one more time, or press the VOLUME Up (▲) button.



⑩ **CHANNEL SELECTOR buttons**
CHANNEL SELECTOR buttons are used to set Family Favorites, Channel Memory, etc.
Enter two or three numbers to select channels. Enter 0 first for channels 1 to 9. For channels 100 and above, press the 1 button, wait until two dashes appear next to the channel display on your TV, then enter the remaining two numbers using the number buttons.
Channel selection may also be performed by pressing CH up (▲) or down (▼).

NOTE: The TV may not receive some channels if you are not in the correct SIGNAL SOURCE mode. (See page 38.)



HOW TO USE THE GENIUS REMOTE TO CONTROL YOUR TV

11 EXIT button
When in MENU mode, this button will exit all On-Screen Displays.

12 RECALL button
Press this button when no menu is displayed when you want to check the channel being received, the picture source, if the channel has stereo (ST) or second audio program (SAP), the time, CHANNEL ID, if the Channel Skip (C.S.) function is activated, if SPECIAL EVENT REMINDER is set, and if the SLEEP timer is set.

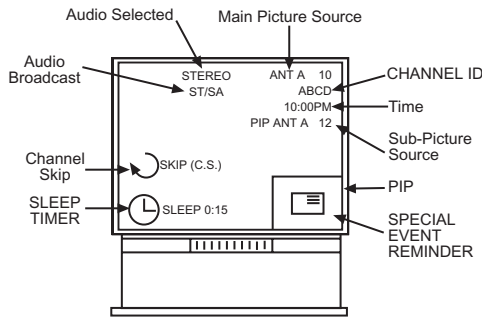

When an S-Video Input is connected to Video: 1.

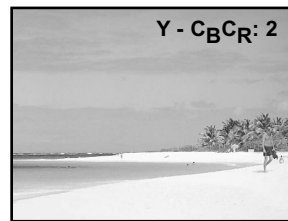

When a COMPONENT: Y-C_BC_R Input is connected to Video: 2.

13 MENU, CURSOR buttons
All the On-Screen Display features can be set or adjusted by using these buttons. The MENU button will start the On-Screen Display. The CURSOR buttons will highlight functions or adjust and set different features.

14 CHANNEL SKIP button
Press this button repeatedly to select channel skip time (30~180 seconds) when no menu is displayed and the TV will tune to the last channel viewed when the selected time is up. The user can change stations SURF to any station they wish, and after selected time seconds, TV will tune back to the original channel.

15 SLEEP button
Press this button to display the sleep timer in the lower left corner of the screen. Every subsequent press of this button will add 15 minutes to this timer, up to a maximum of three hours. Once set, use RECALL when you want to view time remaining. If the SLEEP button is pressed while the timer is set, it will reset to the original condition.

16 INPUT button
The INPUT button will select between both antenna signals and the three sets of video input jacks each time the button is pressed. If the Picture-in-Picture is on, the INPUT button will select between the three sets of video input jacks and both antenna sources when main channel is chosen with the PIP CH button. If the sub-picture is chosen, the INPUT button will select between the three sets of video input jacks and the ANT A antenna source (ANT B source cannot be displayed as a PIP sub-picture and COMPONENT: Y-C_BC_R Input 2 source will be displayed as a blank PIP Sub picture.)

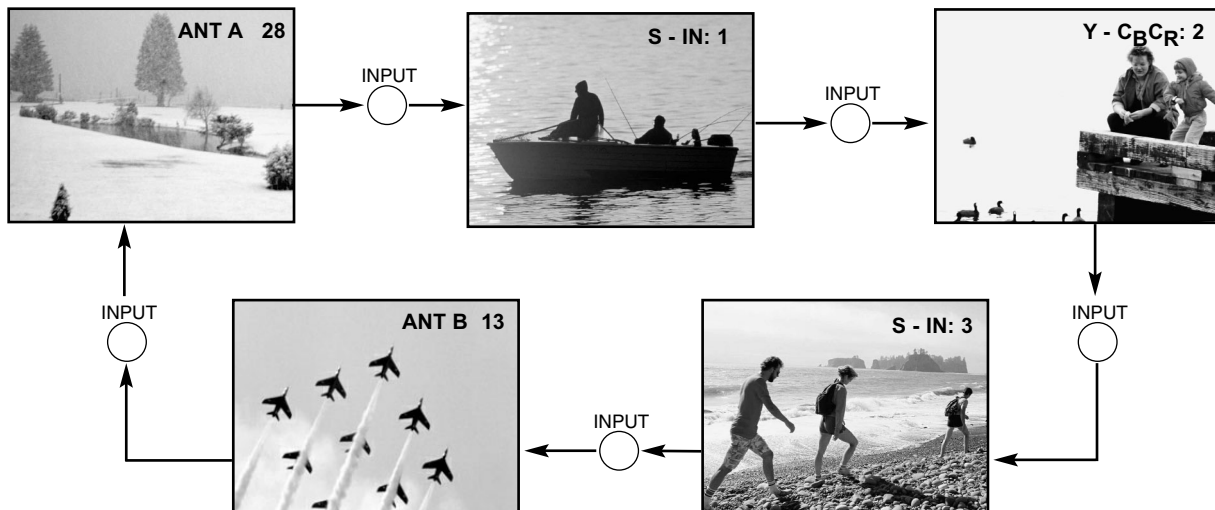



PICTURE-IN-PICTURE (PIP)

Your HITACHI Projection TV incorporates Dual Tuner technology designed for improved viewing enjoyment. This Dual Tuner feature allows you to view antenna inputs on both the main picture and sub-picture simultaneously, with separate tuning control for each. The Dual Tuner can operate with only one input (ANT A only) or two inputs (ANT A and ANT B).

ANT A input can be viewed as both the main picture and the sub-picture simultaneously. ANT B and COMPONENT: Y-C_BC_R input 2 sources can only be viewed as a main picture. To select between main picture and PIP sub-picture tuning, press the PIP CH button on the remote. The highlighted channel display will move with every press of the PIP CH button. When the top channel display is highlighted, channel tuning is for the main picture. When the lower channel display is highlighted, channel tuning is for the PIP sub-picture. This method of picture tuning is the same for one antenna input (ANT A only) and two antenna inputs (ANT A and ANT B).

The Picture-in-Picture feature is convenient when you want to watch more than one program at the same time. You can watch a TV program while viewing other programs from the ANT A source or any of the video inputs.

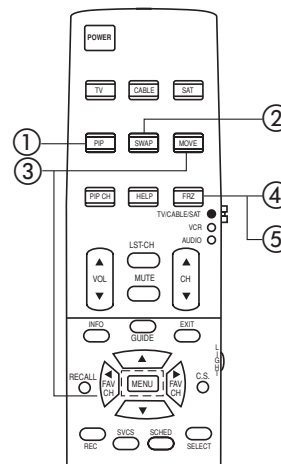
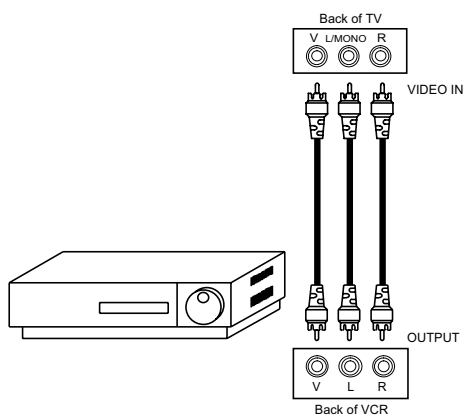

1 PIP button

Press the PIP button and a sub-picture will appear in one of the three different modes (SINGLE, SPLIT or SURF), depending on the last selection of the PIP mode. To change the PIP mode use the CURSOR ▲ or ▼ buttons and the new selection will appear the next time the PIP function is used.

SINGLE MODE PIP

Press the PIP button and a sub-picture appears in one corner of the screen. Press the button again to reduce the size of the sub-picture. Press the PIP button a third time to remove the sub-picture from the screen. Use the PIP CH button to select between main and sub-picture tuning control (indicated by highlighted channel display.) Press the INPUT button when sub-picture channel tuning is being controlled, to change between VIDEO: 1, VIDEO: 2, VIDEO: 3, and ANT A antenna source. (ANT B source cannot be viewed as a sub-picture and COMPONENT: Y-C_BC_R Input 2 source will be displayed as a blank sub-picture).

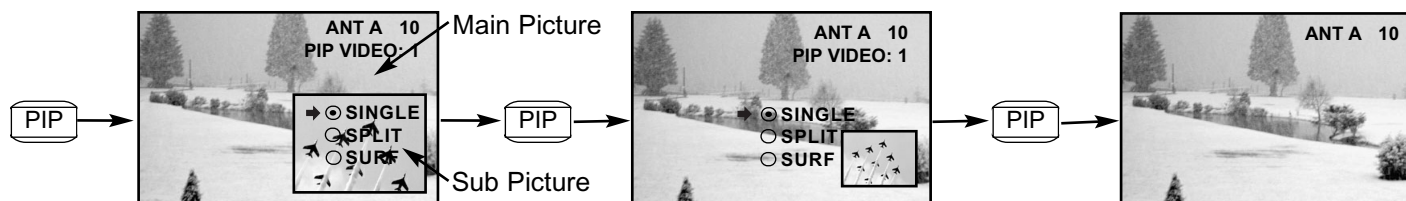

SPLIT MODE PIP

When you press the PIP button, the main channel and the PIP sub-picture will appear at the center of the screen (main channel on right side and sub-picture on left side). Press the PIP button a second time to return to normal viewing. Use the PIP CH button to select between main and sub-picture tuning control (indicated by highlighted channel display). Press the INPUT button when sub-picture channel tuning is being controlled, to change between VIDEO:1, VIDEO:2, VIDEO:3, and ANT A antenna source. (ANT B source cannot be viewed as a sub-picture and COMPONENT: Y-C_BC_R/Y-P_BP_R INPUT 2 source will be displayed as a blank sub-picture).

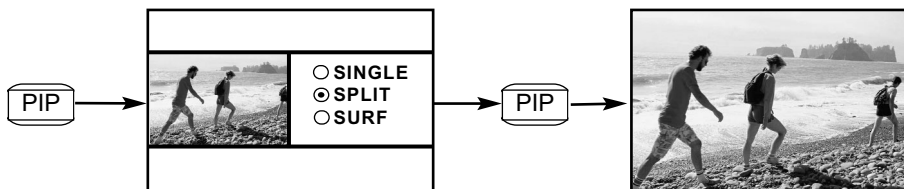

- NOTES:**
- 1) Since ANT B source cannot be viewed as a sub-picture, only SPLIT mode PIP is possible when ANT B is selected as the main channel.
 - 2) When ANT B is selected as the main channel, the SWAP feature is disabled.
 - 3) When the COMPONENT: Y-C_BC_R/Y-P_BP_R Input 2 is selected as PIP, it will appear as a blank sub-picture.
 - 4) When tuned to Video:2 with component input (Y-C_BC_R/Y-P_BP_R) you will not be able to access the PIP functions.
 - 5) Only sound from main picture can be heard, unless you choose sub-picture audio from the THEATER wireless sound mode and use the wireless out outputs on the rear panel.



PICTURE-IN-PICTURE (PIP)

PICTURE-IN-PICTURE CONT. SURF MODE PIP

This feature will automatically scan all active channel numbers (those set in memory) and display them as PIP sub-pictures, along the left and bottom edge of the screen. Press the PIP button a second time to remove the sub-pictures from the screen.

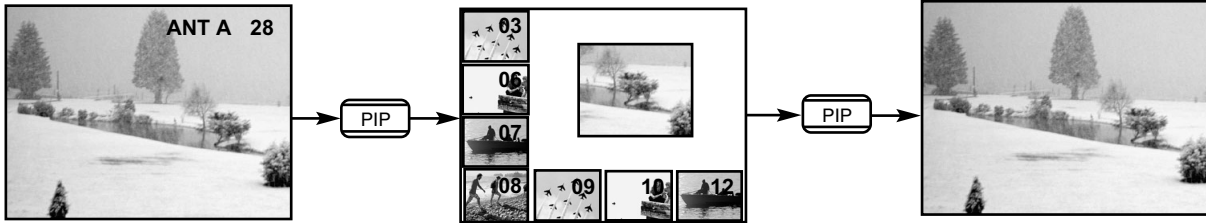

- NOTES:**
1. If no buttons are pressed when in SURF mode, auto-scanning will continuously scan.
 2. If a channel is tuned during this SURF scanning, sub-pictures will be removed from the screen.
 3. SURF mode PIP is allowed only when ANT A is selected as the main channel.

② SWAP button

If you wish to switch what is being shown on the main picture to the sub-picture, press the SWAP button.

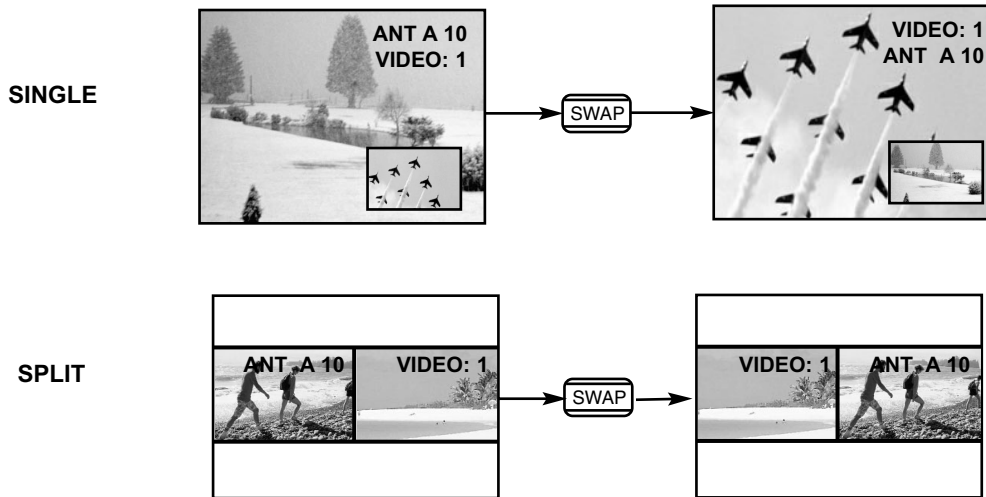

- NOTES:**
1. The SWAP button will only operate when SINGLE PIP mode or split mode PIP is chosen.
 2. The SWAP function will not operate if ANT B input is set as the main channel (ANT B input cannot be displayed as a sub-picture.)

③ MOVE button

To move the sub-picture to another corner, press the MOVE button. The sub-picture moves one step counterclockwise every time the MOVE button is pressed.

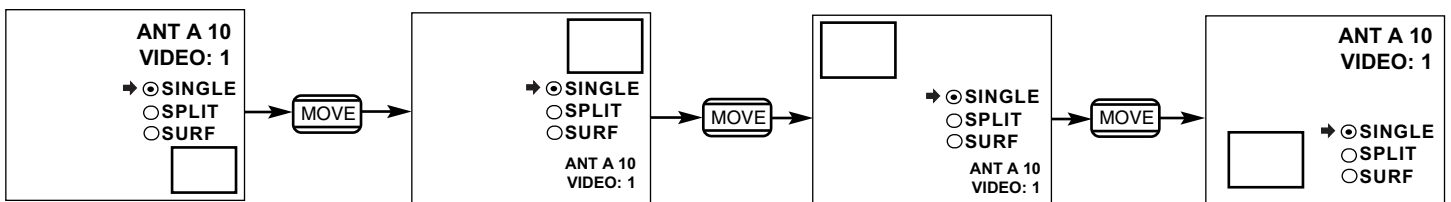

PICTURE-IN-PICTURE (PIP)



④ FREEZE (FRZ) button (With PIP ON)

If you wish to freeze the sub-picture, press the FRZ button. This is convenient when trying to write down the address for a mail order company, recording statistics for a sporting event, etc. To return the picture to motion, press the FRZ button again.

NOTE: The FREEZE function will only operate when SINGLE PIP or SPLIT PIP mode is chosen.

⑤ FREEZE (FRZ) button (With PIP OFF)

Press the FRZ button to freeze the picture, depending on the mode previously selected (SINGLE, SPLIT or STROBE). To change FREEZE modes, use cursor ▲ or ▼ to select which type of FREEZE mode you wish to view. The new selection will appear the next time the FREEZE function is used.

SINGLE FREEZE

Press the FRZ button to freeze one frame of the picture you are currently viewing. Press this button again or PIP to return to normal viewing.



SPLIT FREEZE

Press the FRZ button to freeze the picture you are currently viewing. (Only the left Sub-picture will freeze). Press this button again or PIP to return to normal viewing.

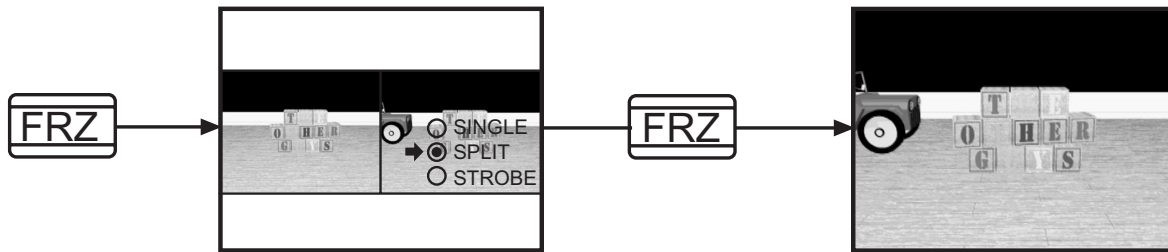

STROBE FREEZE

Press the FRZ button to freeze seven frames of the picture you are currently viewing. Press this button again or PIP to return to normal viewing. This feature is useful for viewing a moving picture that has many details, for example, a close play in a sporting event or golf swing.

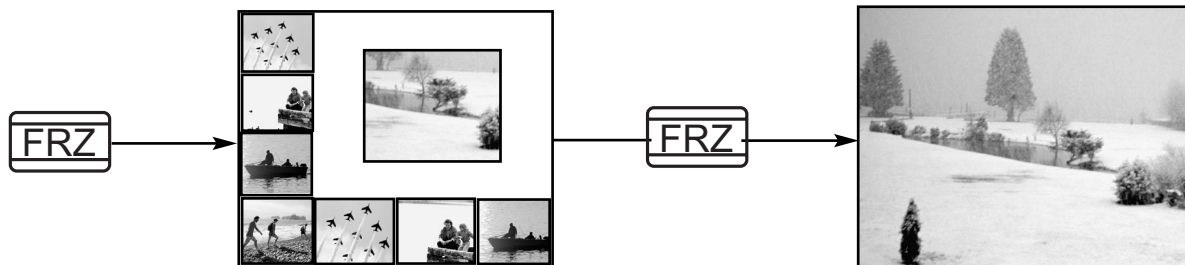

NOTE: Each freeze frame is delayed about 0.1 (1/10) second.

CAUTION: A pattern burn may develop if the sub-picture is left in the same corner permanently. If the PIP feature is used frequently, occasionally MOVE the sub-picture to a different corner. You may also vary its position using the CURSOR ◀, ▶, ▲, or ▼ buttons.

NOTES: Only sound from the main picture can be heard, unless you choose sub-picture audio from THEATER-WIRELESS SOUND mode and use the WIRELESS OUT outputs on the rear panel. (See page 61.)

Each freeze frame is delayed about 0.1 (1/10) second.

The FREEZE function will display blank sub-pictures when the COMPONENT: Y-C_BC_R Input 2 source is set as main channel.



USING THE REMOTE TO CONTROL VCR FUNCTIONS

Operating the precoded function for your VCR.

This remote is designed to operate different types of VCRs. You must first program the remote to match the remote system of your VCR. (Refer to page 33.)

1. Set the MULTI-PAGE select switch to VCR.
2. Turn ON your VCR.
3. Aim the remote control at the front of your VCR.
4. Hold down the PROG. button on the remote, enter the two digit preset code that matches your VCR as shown on page 33. The remote will turn off your VCR when the correct two digit preset code is entered. When this occurs, the remote control is programmed for your VCR. If the VCR does not turn off after five seconds, try a different two digit preset code.
5. The remote will now control your VCR.

NOTES:

1. If your VCR cannot be operated after performing the above procedures, your VCR's code has not been precoded into the remote.
2. In the unlikely event that your VCR cannot be operated after performing the above procedures, please consult your VCR operating guide.
3. The remote control will remember the codes you have programmed until the batteries are removed from the remote control. After replacing the batteries repeat the entire programming procedure as stated above.
4. If your VCR does not have a power function, the remote will issue the CHANNEL UP function.
5. The MENU button will act as the VCR MENU button for HITACHI VCRs.
6. The LST-CH button will act as your VCR ENTER button if required.
7. The SLEEP button will act as your VCR 100 button if required.
8. The REC button must be pressed two times to begin VCR recording. This button will also act as the VCR record button when the remote is in CABLE or SAT mode.

- ① **PRECODED VCR buttons**
These buttons transmit the chosen precoded VCR codes.
- ② **EXCLUSIVE TV buttons**
These buttons are for operating the TV.

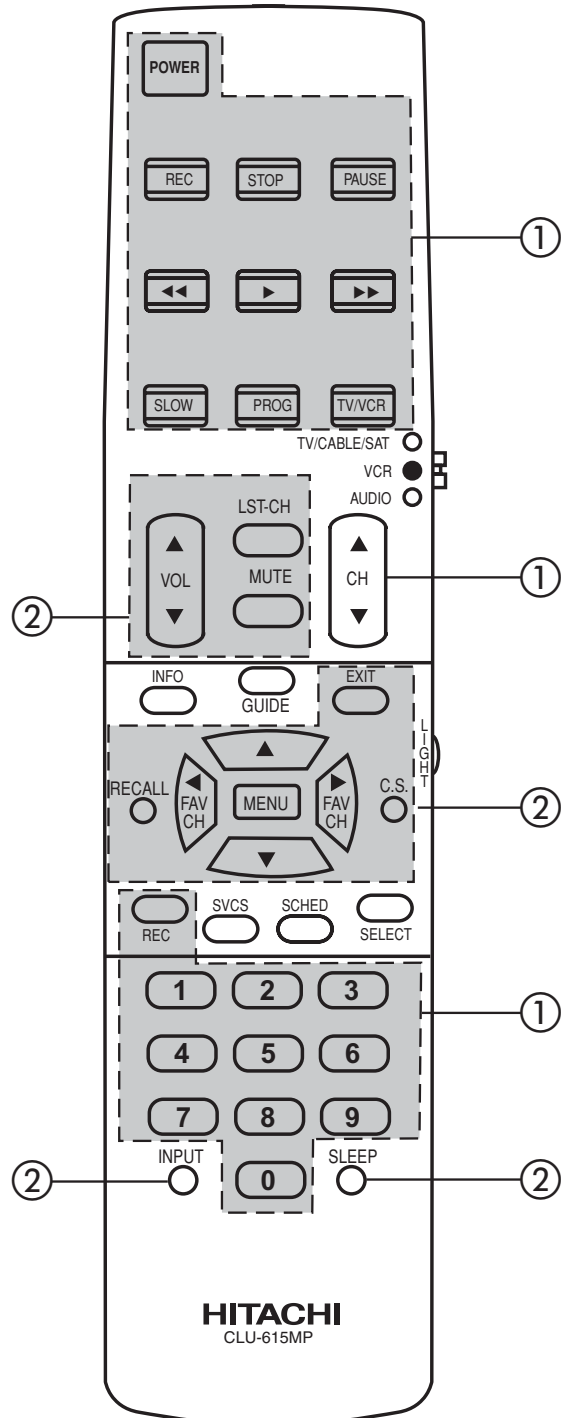

USING THE REMOTE TO CONTROL CABLE/SATELLITE BOX FUNCTIONS



Operating the precoded function for your cable/satellite box.

This remote is designed to operate different types of cable boxes and satellite systems. You must first program the remote to match the remote system of your cable/satellite box. (Refer to page 33.)

1. Set the MULTI-PAGE select switch to TV/CABLE/SAT.
2. Turn ON your cable/satellite box.
3. Press the CABLE button on the remote to switch to CABLE mode, or the SAT button to switch to SAT mode.
4. Aim the remote control at the front of your cable/satellite box.
5. Hold down the CABLE/SAT button on the remote, enter the two digit preset code that matches your cable/satellite box as shown on page 33. The remote will turn off your cable/satellite box when the correct two digit preset code is entered. When this occurs, the remote control is programmed for your cable/satellite box. If the cable/satellite box does not turn off after five seconds, try another two digit preset code.
6. The remote will now control your cable/satellite box.

NOTES:

1. If your cable/satellite box cannot be operated after performing the above procedures, your cable/satellite box code has not been precoded into the remote.
2. In the unlikely event that your cable/satellite box cannot be operated after performing the above procedures, please consult your cable/satellite box operating guide.
3. The remote control will remember the codes you have programmed until the batteries are removed from the remote control. After replacing the batteries repeat the entire programming procedure as stated above.
4. If your cable/satellite box does not have a power function, the remote will issue the CHANNEL UP function.
5. The LST-CH button will act as the cable box ENTER button if required.
6. The SLEEP button will act as your cable box 100 button if required.
7. The INPUT button will act as the TV/SAT button when in SAT mode.

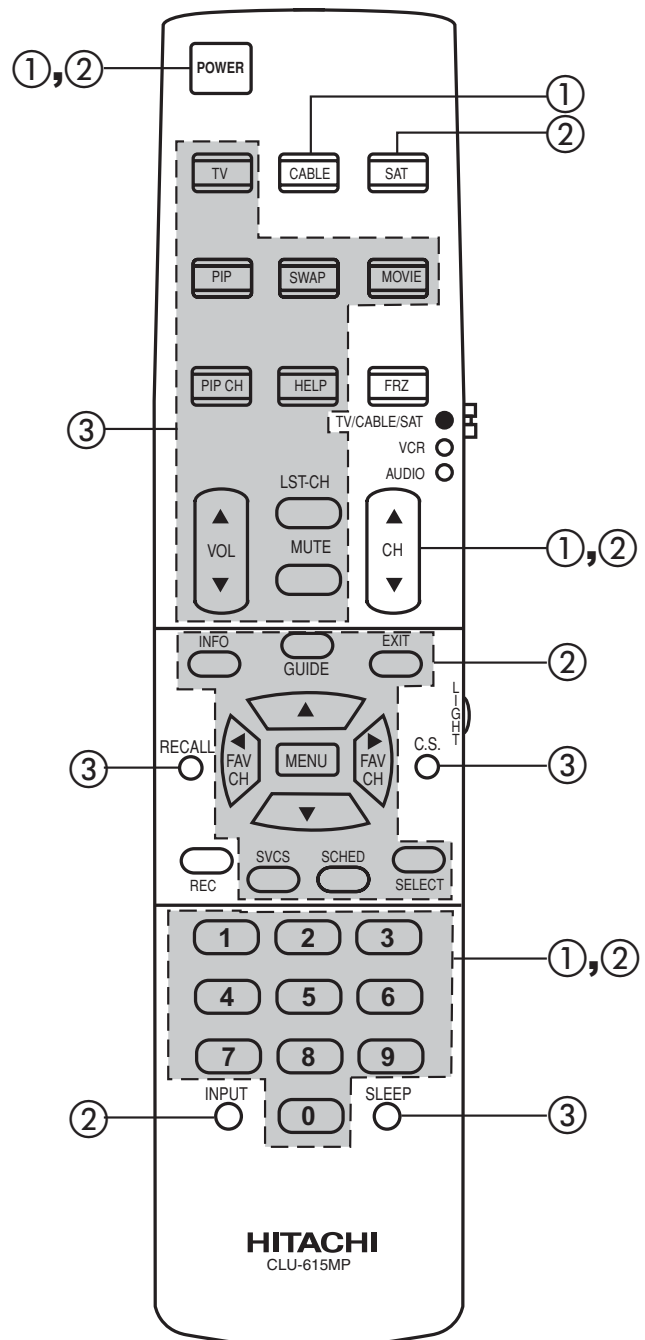

- ① **PRECODED CABLE BOX buttons**
These buttons transmit the chosen precoded cable codes.
- ② **PRECODED SATELLITE BOX buttons**
These buttons transmit the chosen precoded satellite codes.
- ③ **EXCLUSIVE TV buttons**
These buttons are for operating the TV.



USING THE REMOTE TO CONTROL AUDIO EQUIPMENT FUNCTIONS

Operating the precoded function for your audio equipment.

This remote is designed to operate certain types of audio equipment. You must first program the remote to match the remote system of your audio equipment. (Refer to page 33.)

1. Set the MULTI-PAGE select switch to AUDIO.
2. Turn ON the audio component you wish to control with your remote control (AMP, CD, or TAPE).
3. Aim the remote control at the front of your audio equipment.
4. Hold down the button on the remote which corresponds with the component you wish to control (AMP, CD, or TAPE), enter the two digit preset code that matches your audio component as shown on page 33. The remote will turn off your audio component when the correct two digit preset code is entered. When this occurs, the remote control is programmed for your audio component. If the audio component does not turn off after five seconds, try a different two digit preset code.
5. The remote will now control your audio component.
6. Repeat steps 2-5 until all audio equipment preset codes are programmed into the remote.

NOTES:

1. If your audio equipment cannot be operated after performing the above procedures, your audio component code has not been precoded into the remote.
2. In the unlikely event that your audio component cannot be operated after performing the above procedures, please consult your audio components operating guide.
3. The remote control will remember the codes you have programmed until the batteries are removed from the remote control. After replacing the batteries repeat the entire programming procedure as stated above.
4. If your audio component does not have a power function, the remote will issue another obvious function that the audio component will respond to, such as CD open /close.
5. The default for AUDIO mode is AMP.
6. If you wish to control your receiver or miscellaneous audio equipment, you must follow the remote programming procedure shown above. You may use only the AMP button to program these codes, but note that this button may not be used for more than one component.
7. The LST-CH button will act as your audio component's ENTER button if required.
8. The SLEEP button will act as your audio components 100 button if required.

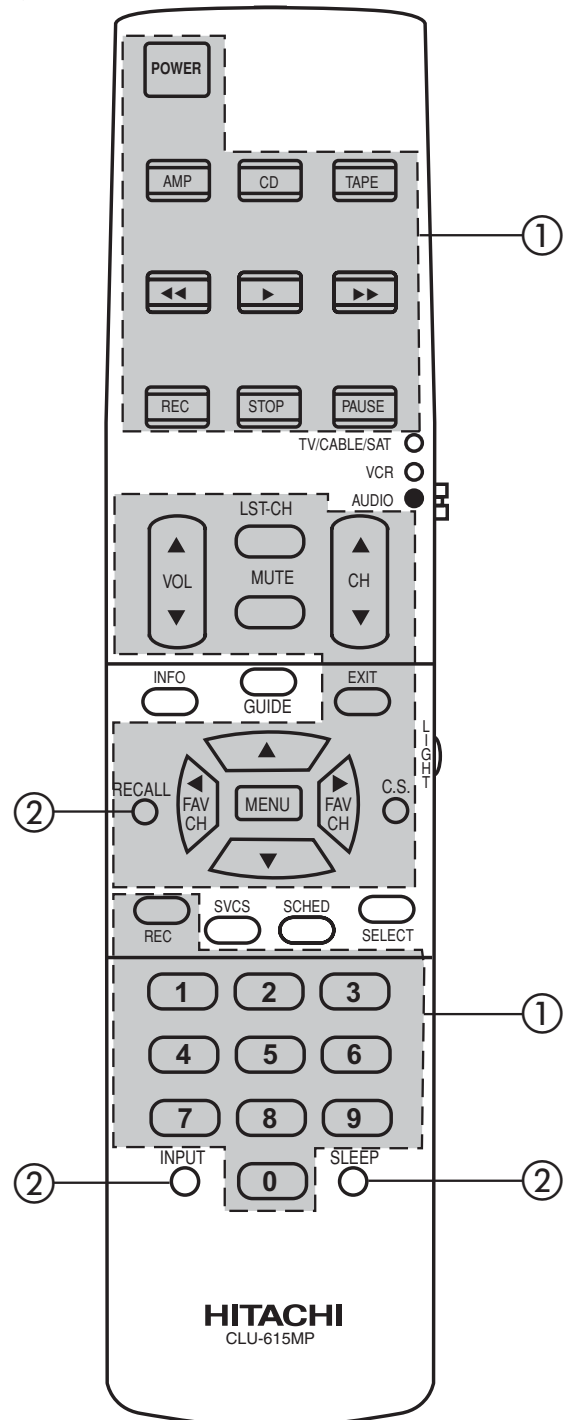

- ① **PRECODED AMP, CD, or TAPE buttons**
These buttons transmit the chosen precoded audio component codes.
- ② **EXCLUSIVE TV buttons**
These buttons are for operating the TV.

AUDIO, CABLE/SATELLITE, AND VCR CODES



AMPLIFIER BRAND	CODE	Signature	00	RECEIVER BRAND	CODE	KEC	08, 23
Aiwa	04, 05	SL Marx	26	Aiwa	04, 05	Kenwood	01, 24, 26
Carver	00, 05, 06, 07	Sprucer	01, 49	Carver	05, 06, 07	KLH	30
Casio	08	Starcom	38, 53, 56	Casio	08	Kodak	22, 23
Clarinet	08	Stargate	26, 56	Clarinet	08	Lloyd s	00
Denon	09	Starquest	56	Denon	09	Lloyd s	27
Fisher	07, 10	Starsight	58, 59	Fisher	07, 10	Logik	30
Hitachi	11	Sylvania	19	Hitachi	11	LXI	23
JVC	12	Televue	26	JVC	12	Magnavox	14, 22, 29, 31, 35
Kenwood	13, 14, 16, 17	Texscan	19	Kenwood	13, 14, 16, 17	Magnin	45
Lloyd s	08	Tocom	07, 28, 55	Lloyd s	08	Marantz	22, 31
Magnavox	00, 05, 08	Toshiba	02	Magnavox	05, 08	Marta	23
Marantz	00, 05, 15	Tusa	56	Marantz	05, 15	Matsushita	22
MCS	15	TV 86	30	MCS	15	MEI	22
Modulaire	08	Unika	12, 40	Modulaire	08	Memorex	00, 14, 17, 18, 19, 22, 23, 32, 45
Onkyo	18	United Artists	37	Onkyo	18	MGA	15, 48
Optimus	02, 03, 10, 14, 19	United Cable	53	Optimus	10, 14, 19	MGN Technology	45
Panasonic	15	Universal	12, 25, 32, 33, 35, 40	Panasonic	15	Minolta	02, 04
Penney	08	Videoway	51	Penney	08	Mitsubishi	15, 26, 40, 48, 49
Philips	00, 05	Viewstar	16, 29, 30, 41	Philips	05	Motorola	19, 22
Pioneer	02, 03, 19, 20, 21	Zenith	02, 52, 60	Pioneer	02, 19, 20, 21	MTC	00, 45
Quasar	15	Zentek	57	Quasar	15	Multitech	00, 30
Realistic	08			Realistic	08	NEC	01, 05, 24, 26, 32
Sansui	05	TAPE BRAND	CODE	Sansui	05	Nikko	23
Sanyo	10	Aiwa	58, 59	Sanyo	10	Noblex	45
Sharp	14	Hitachi	47, 48, 49, 50	Sharp	14	Olympus	11, 22
Sony	04	Jerrold	60, 61	Sony	04	Optimus	19, 23, 32
Technics	01, 15, 22, 23, 24	JVC	51	Technics	15, 22, 23, 24	Orion	51
Victor	12	Kenwood	52	Victor	12	Panasonic	10, 11, 22, 39, 53
Wards	02, 04, 05, 07, 19, 20	Optimus	53	Wards	04, 05, 07, 19, 20	Penney	02, 05, 22, 23, 24, 45, 46
Yamaha	14, 25	Panasonic	54	Yamaha	14, 25	Pentax	02, 03, 04
Yorx	08	Pioneer	53	Yorx	08	Philco	22
		Scientific Atlanta	62	SAT BRAND	CODE	Philips	22, 29, 31
CABLE BRAND	CODE	Sony	55, 56, 58, 59	Hitachi	61	Pilot	23
ABC	00, 07, 08, 18, 19, 21, 37, 38, 53	Starcom	60	RCA	62	Pioneer	26
Antronix	40	Wards	53	Sony	63	Portland	06
Archer	12, 25, 40			VCR BRAND	CODE	Protac	30
Belcor	33	CD BRAND	CODE	Adventura	00	Pulsar	14
Cable Star	33	Adcom	26	Aiwa	00	Quarter	17
Century	12	Aiwa	27	Aiko	08	Quartz	17
Citizen	12	California Audio Lab	28	Aiwa	00	Quasar	22
Colour Voice	31, 45	Carver	27	Akai	01, 48, 49	Radio Shack	00, 23
Comtronics	26, 29	Denon	29	American High	22	Radix	23
Contec	22	DKK	30	Asha	45	Randex	23
Dae Ryung	21	Emerson	26	Audiovox	23	RCA	02, 03, 04, 35, 41, 47
Eastern	15	Fisher	31	Beaumarck	45	Realistic	00, 17, 18, 19, 20, 22, 23, 32, 45
Electricord	32	Genexa	32	Bell & Howell	32	Ricoh	21
Everquest	56	Hitachi	26, 32, 33, 34, 35, 36, 37	Brandt	43	Runco	14
Focus	57	JVC	38	Broksonic	33, 34, 42, 51, 52	Samsung	16, 45
Garrard	12	Kenwood	31, 39, 40	Calix	23	Sanky	14, 19
GC Electronics	33, 40	Krell	27	Canon	22	Sansui	01, 26
Gemini	04, 39, 44, 56	Magnavox	27	Capehart	06	Sanyo	17, 18, 32, 45
General Instrument	00, 13	Marantz	27, 28	Carver	31	Scott	15, 16, 33, 34, 37, 42
Gold Star	11, 26	MCS	28	CCE	08, 30	Sears	02, 04, 17, 18, 20, 22, 23, 32, 46
Hamlin	03, 09, 14, 23, 24	Mission	28	Citizen	08, 23	Sharp	19
Hitachi	00	NSM	27	Colt	30	Shintom	30
Hytex	37	Onkyo	41	Craig	18, 23, 30, 45	Shogun	45
Jasco	12	Optimus	30, 32, 42	Curtis Mathes	01, 22, 47	Singer	30
Jerrold	00, 08, 13, 38, 53, 55, 56	Panasonic	28	Cybernex	45	Sony	07, 09, 21, 22
Macom	36	Philips	27	Daewoo	06, 08, 16, 38, 50	STS	02
Magnavox	16	Pioneer	32, 42	Daytron	06	Sylvania	00, 15, 22, 29, 31
Memorex	02	Proton	27	Dynatech	00	Symphonic	00
Movie Time	30, 32, 34	QED	27	Electrohome	23	Tatung	01
NSC	30, 34, 39	Quasar	28	Electrohome	23	Teac	00, 01
Oak	22, 37, 50	RCA	26, 33	Emerex	07	Technics	22, 39
Panasonic	02, 10, 49	Realistic	26	Emerson	00, 08, 12, 15, 23, 27, 28, 33, 34, 37, 42, 48, 51, 52	Teknika	00, 22, 23
Paragon	02	Rotel	27	Fisher	18, 20, 32, 46	Telefunken	43
Philips	12, 16, 17, 27, 31, 43, 44, 45, 47	SAE	27	Fuji	09, 22	TMK	27, 45
Pioneer	06, 11, 20	Sansui	27	Funai	00	Toshiba	15, 16, 20, 37
Popular Mechanics	57	Scott	26	Garrard	00	Television	23, 45
Pulsar	02	Sony	30, 44	GE	03, 22, 41, 47	Unitech	45
RCA	49	Technics	28, 45, 46	Goldstar	23, 24, 44	Vector	16
Realistic	40	Victor	38	Gradiente	00	Vector Research	05, 24
Recoton	57	MISC BRAND	CODE	Harley Davidson	00	Video Concepts	05, 16, 48
Regal	03, 09, 23, 35	Aiwa	58, 59	Harman/Kardon	24	Videosonic	45
Regency	15	Jerrold	60, 61	Harwood	30	Wards	00, 02, 18, 19, 22, 30, 35, 37, 45, 47
Rembrandt	00, 39	Scientific Atlanta	62	Headquarter	17	XR-1000	00, 22, 30
Runco	02	Sony	58, 59	Hi-Q	18	Yamaha	24
Samsung	11, 26	Starcom	60	Hitachi	01, 02, 03, 04	Zenith	09, 14, 21
Scientific Atlanta	18, 21, 42, 48			Jensen	01		
Signal	26, 56			JVC	01, 13, 26		



1. Press MENU on the remote control to display the different features on your HITACHI Projection TV.
2. Press the CURSOR buttons to highlight a different feature.
3. Press EXIT on the remote control to quickly exit from a menu.
4. Press HELP on the remote control when a menu is displayed, and text will appear giving a description of that menu.

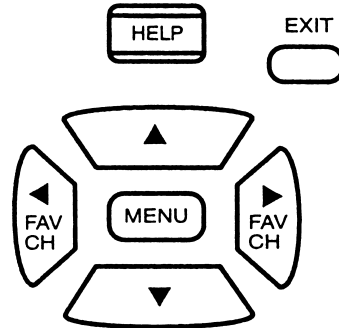

This part of the screen shows what selections are available.

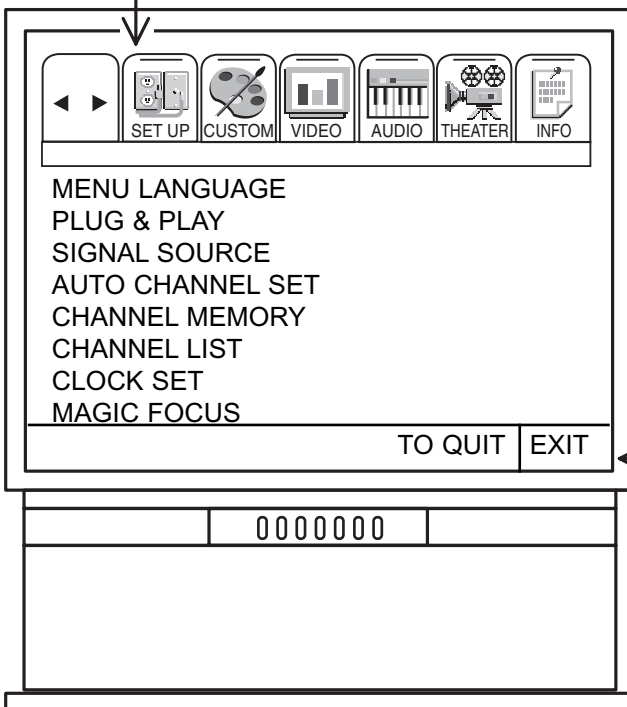

This part of the screen shows which remote control buttons to use.

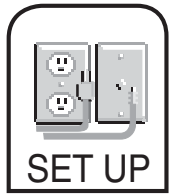

MENU LANGUAGE
PLUG & PLAY
SIGNAL SOURCE
AUTO CHANNEL SET
CHANNEL MEMORY
CHANNEL LIST
CLOCK SET
MAGIC FOCUS

Choose English, French, or Spanish text.
 Optimum hook up for your system.
 Select Antenna or Cable TV.
 First time set up for channel buttons.
 Channel buttons, add, skip.
 Check channel name, scan, and child lock.
 Set before using timer features.
 Automatically match red, green, and blue colors to make white.



CHANNEL ID.
VIDEO ID.
FAMILY FAVORITES
PARENTAL CONTROL
4 EVENT PROGRAM
AUTO LINK
CLOSED CAPTION
MENU BACKGROUND
FIRST TIME TOUR

Label channels PAY1, ABC, etc.
 Label video inputs VCR1, DVD1, etc.
 Allows you to set and view favorite channels.
 Block channel picture and sound.
 Turn TV on and off once, daily, or weekly.
 Automatically turn TV on with any VIDEO input.
 Feature to display dialogue/text.
 Select from three types of backgrounds.
 Introduces you to basic TV functions.



CONTRAST
BRIGHTNESS
COLOR
TINT
SHARPNESS
RESET
ADVANCED SETTINGS

Adjust contrast.
 Adjust brightness.
 Adjust color.
 Adjust tint.
 Adjust sharpness.
 Set VIDEO settings to factory preset.
 Improve picture performance.



BASS
TREBLE
BALANCE
RESET
ADVANCED SETTINGS

Adjust bass.
 Adjust treble.
 Adjust balance.
 Set AUDIO settings to factory preset.
 Improve sound performance.



THEATER MODES
SURROUND
GRAPHIC EQ.
WIRELESS SOUND
SUB WOOFER

Picture and sound are automatically set.
 Special sound effects, including Dolby Pro Logic.
 More precise audio control.
 Select from three types of audio for wireless output.
 Adjust Sub-Woofer volume.

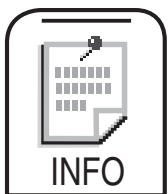

SPECIAL EVENT REMINDER
CALENDAR

Set TV to remind you of birthdays, etc..
 Check day, month, year, and special events.

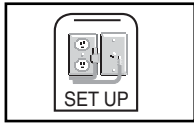

Select INITIAL SETUP when setting your TV up for the first time. Use the CURSOR ▲ or ▼ on the remote to highlight the function desired.

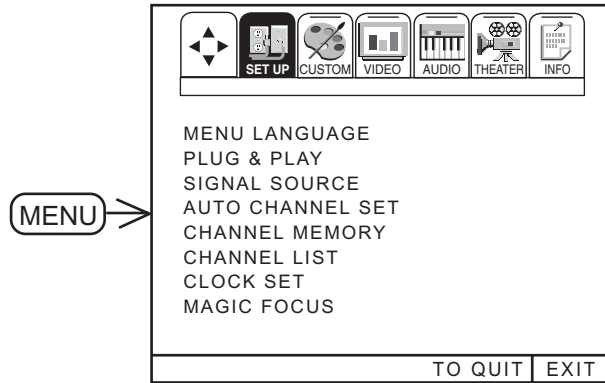

NOTE: To see an auto-demonstration of the on-screen displays with HELP text displayed, press and hold the POWER button on the TV set for approximately five seconds. Press the POWER button on the TV again to end the auto-demonstration.

MENU LANGUAGE

This feature will allow you to select any one of three different languages for all on-screen displays.

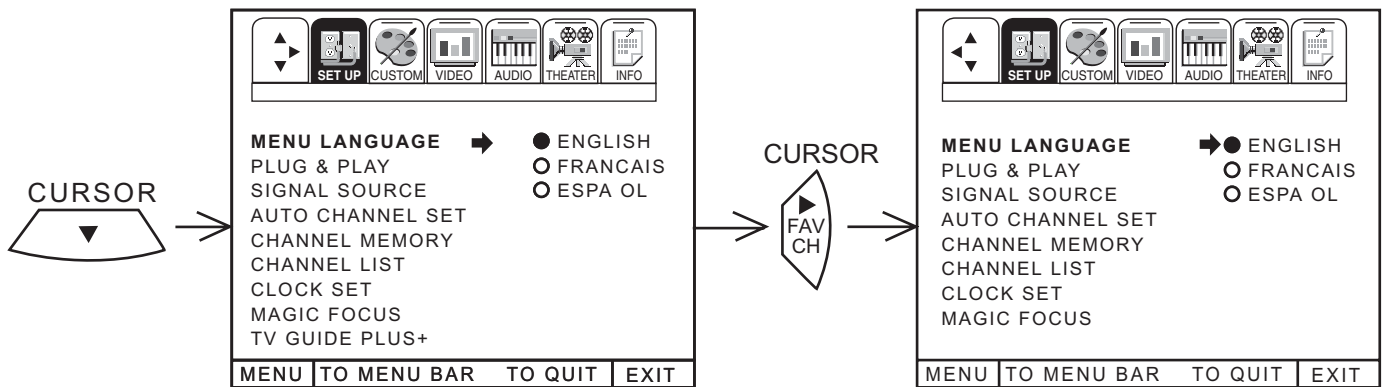

Use CURSOR ▲ or ▼ to select the MENU LANGUAGE of your choice.

Press EXIT to quit menu or CURSOR ◀ to return to previous menu.

SET UP



PLUG & PLAY

This graphic guide function will help you to properly set up your TV or Home Theater System. Simply answer two questions and a graphic will be displayed, showing you the optimum setup for your personalized system.

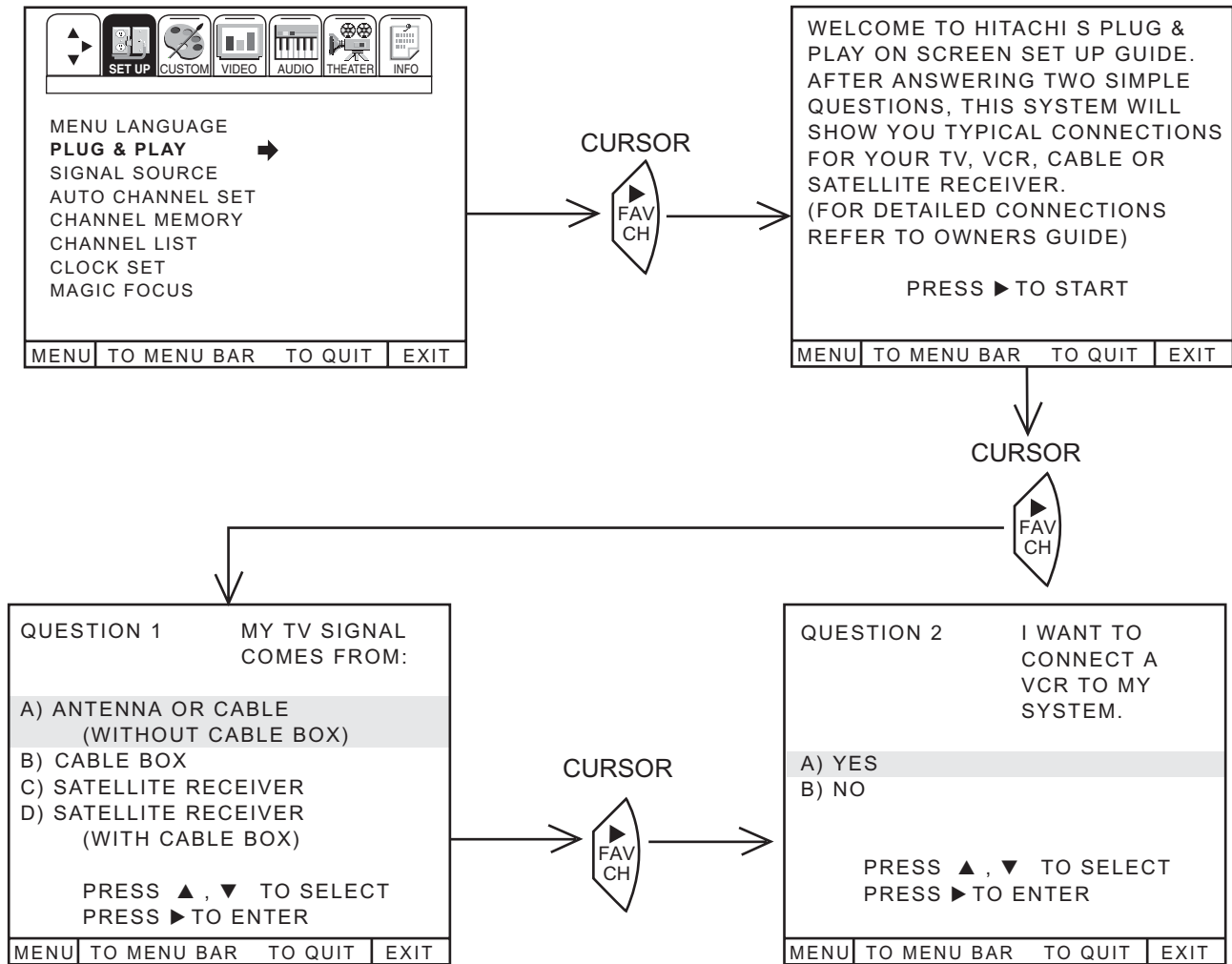

Press CURSOR ▲ or ▼ to highlight the correct answers to both questions.
Press CURSOR ► to display the graphic guide.
Press EXIT to quit menu or CURSOR ► to begin AUTO CHANNEL SET. (See page 39.)

SIGNAL SOURCE

Select ANTENNA if you are using an indoor or outdoor antenna. Select CATV if you have cable TV.

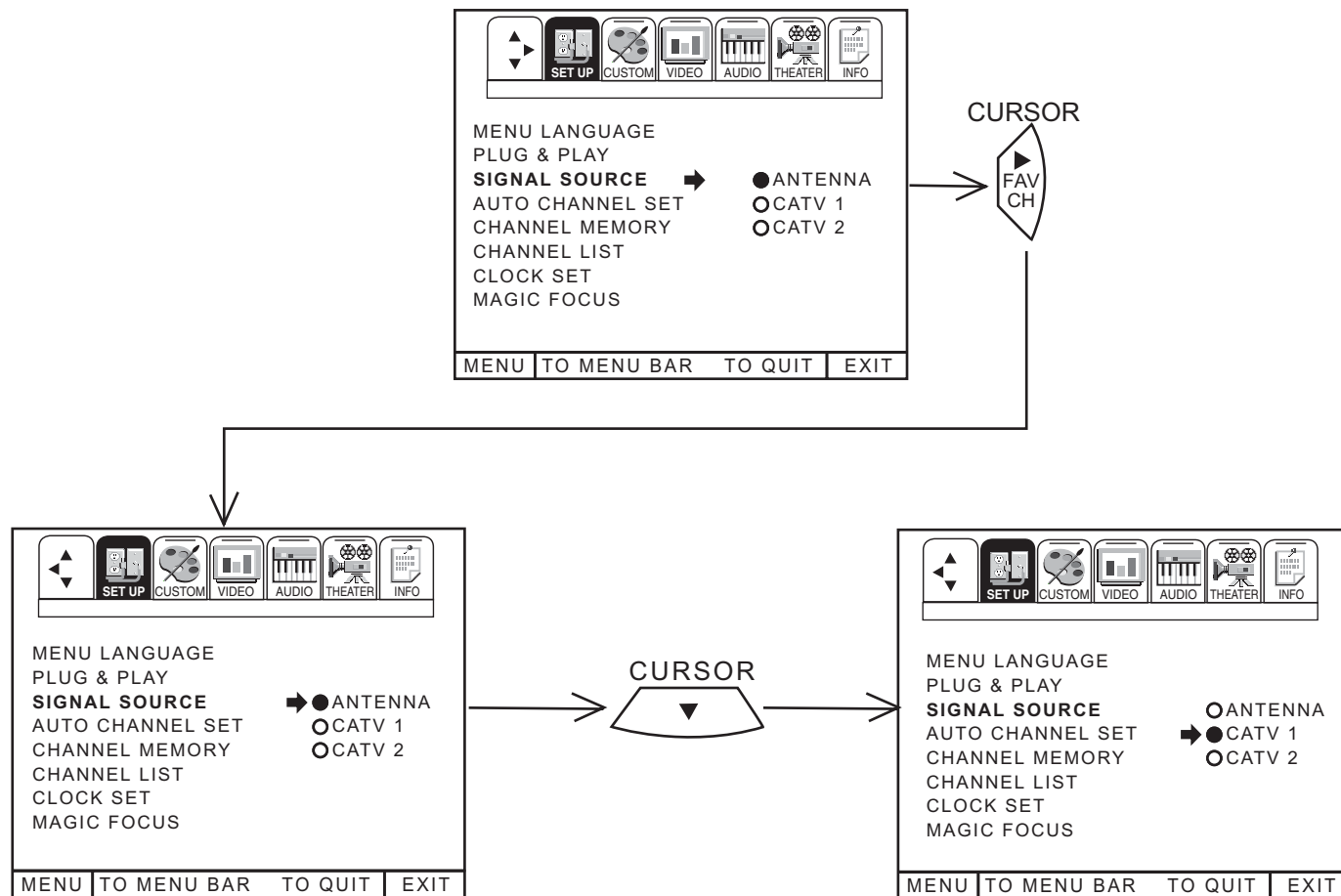

Press CURSOR ▲ or ▼ to highlight and select the correct SIGNAL SOURCE mode.
Press EXIT to quit MENU or CURSOR ◀ to return to previous menu.

RECEPTION BAND		
AIR	CATV 1 OR CATV 2	
	CATV CHANNEL	Indicated on the screen
VHF 2 ~ 13ch UHF 14 ~ 69ch	VHF 2~13	2 ~ 13
	Mid band A~1	14 ~ 22
	A-5 ~ A-1	95 ~ 99
	Super band J~W	23 ~ 36
	Hyper band W + 1 ~ W + 28	37 ~ 64
	Ultraband W + 29 ~ W + 84	65 ~ 125

Reception channels for each mode are shown at the left.

Refer to your cable or TV guide for channel identification standards.

If certain CATV channels are poor or not possible in CATV1 mode, set SIGNAL SOURCE to CATV2.

SET UP



AUTO CHANNEL SET

This feature will automatically store active TV channels in CHANNEL MEMORY. This will allow you to skip unused channels when using CHANNEL UP (▲) or DOWN (▼).

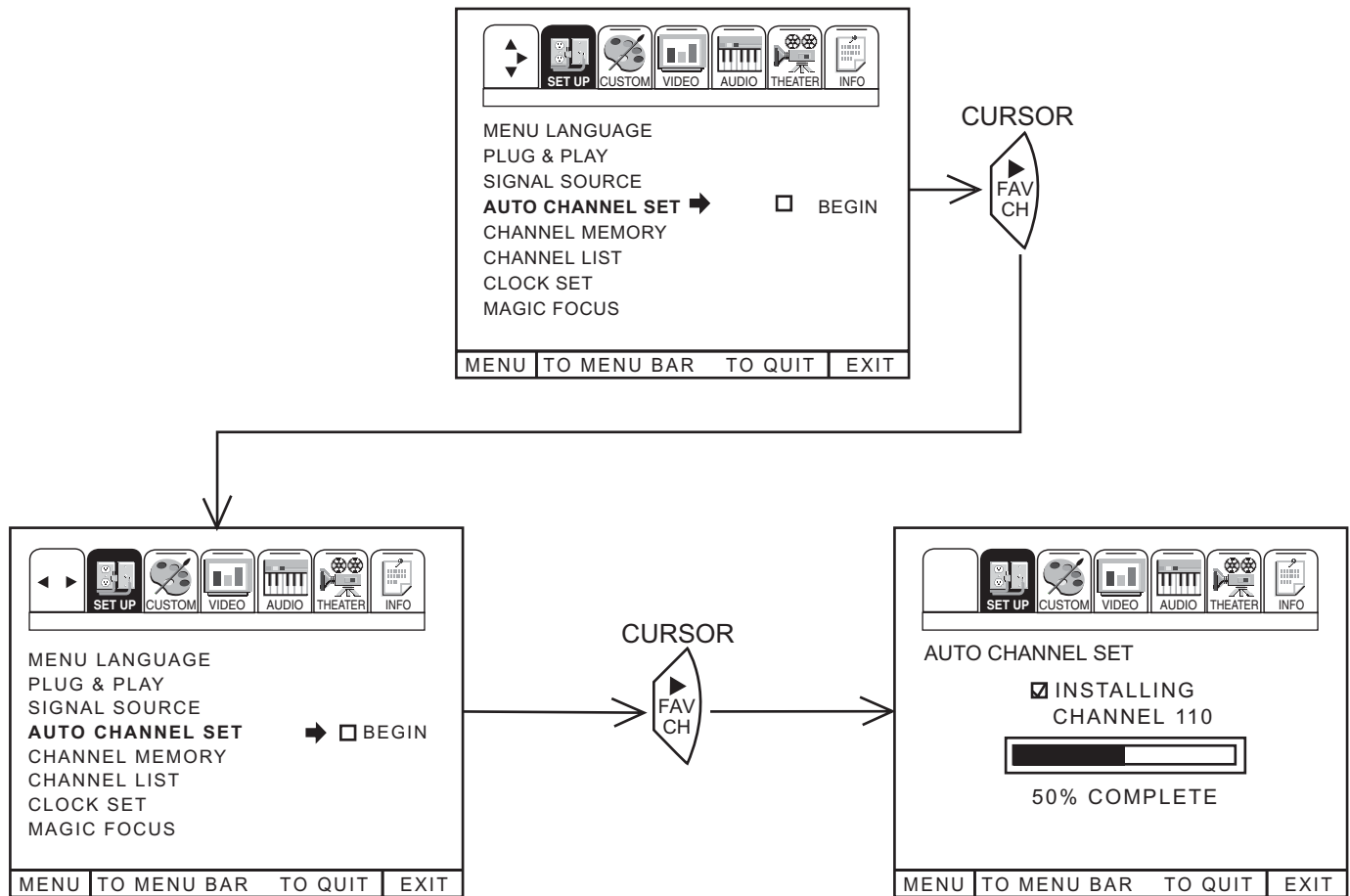

If the EXIT button is pressed while the AUTO CHANNEL SET function is engaged, programming will stop. If two antennas are connected, switch antenna inputs with the INPUT button and repeat AUTO CHANNEL SET for the second antenna input.

Remember to select the correct SIGNAL SOURCE mode before using AUTO CHANNEL SET for the second antenna input. See CHANNEL MEMORY to add or erase additional channels.



CHANNEL MEMORY

Use this function after AUTO CHANNEL SET to add or erase additional channels to the remote control CHANNEL ▲ or ▼ buttons.

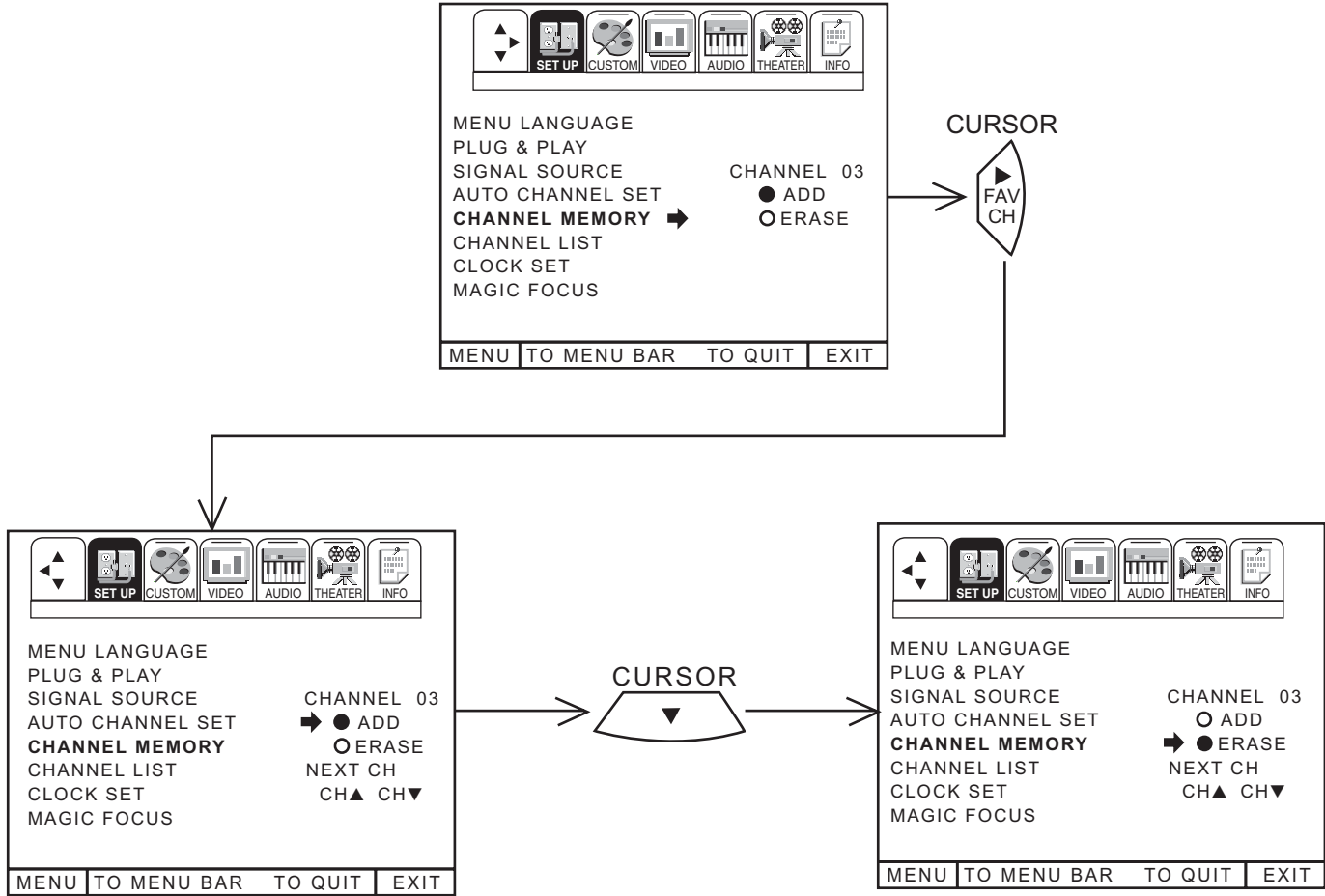

Add or erase additional channels while still in CHANNEL MEMORY using CHANNEL ▲ or ▼ or the number buttons to change the channel.

Press EXIT to quit menu or CURSOR ◀ to return to previous menu.

SET UP

CHANNEL LIST

This function allows you to review which channels are labeled in CHANNEL ID (ID.), which have been added to CHANNEL MEMORY (SCAN), and which are protected by PARENTAL CONTROL.

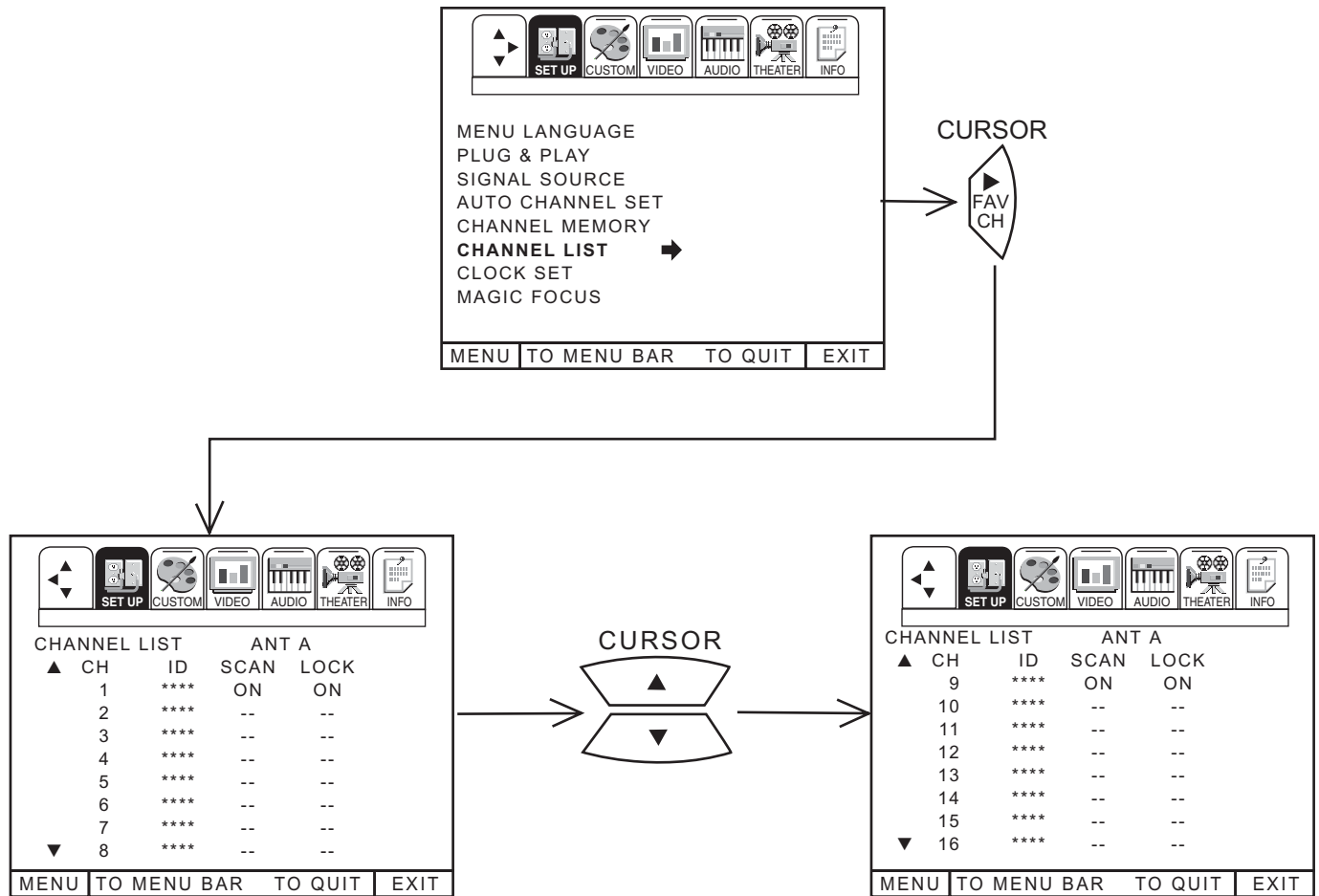

Press CURSOR ▲ or ▼ to review more channels.
Press EXIT to quit menu or CURSOR ◀ to return to previous menu.

NOTE: Each touch of CURSOR ▲ or ▼ will display the next eight channels.



CLOCK SET

The time must be set before you can use the CALENDAR, 4 EVENT PROGRAM, SPECIAL EVENT REMINDER, or TV TIME OUT.

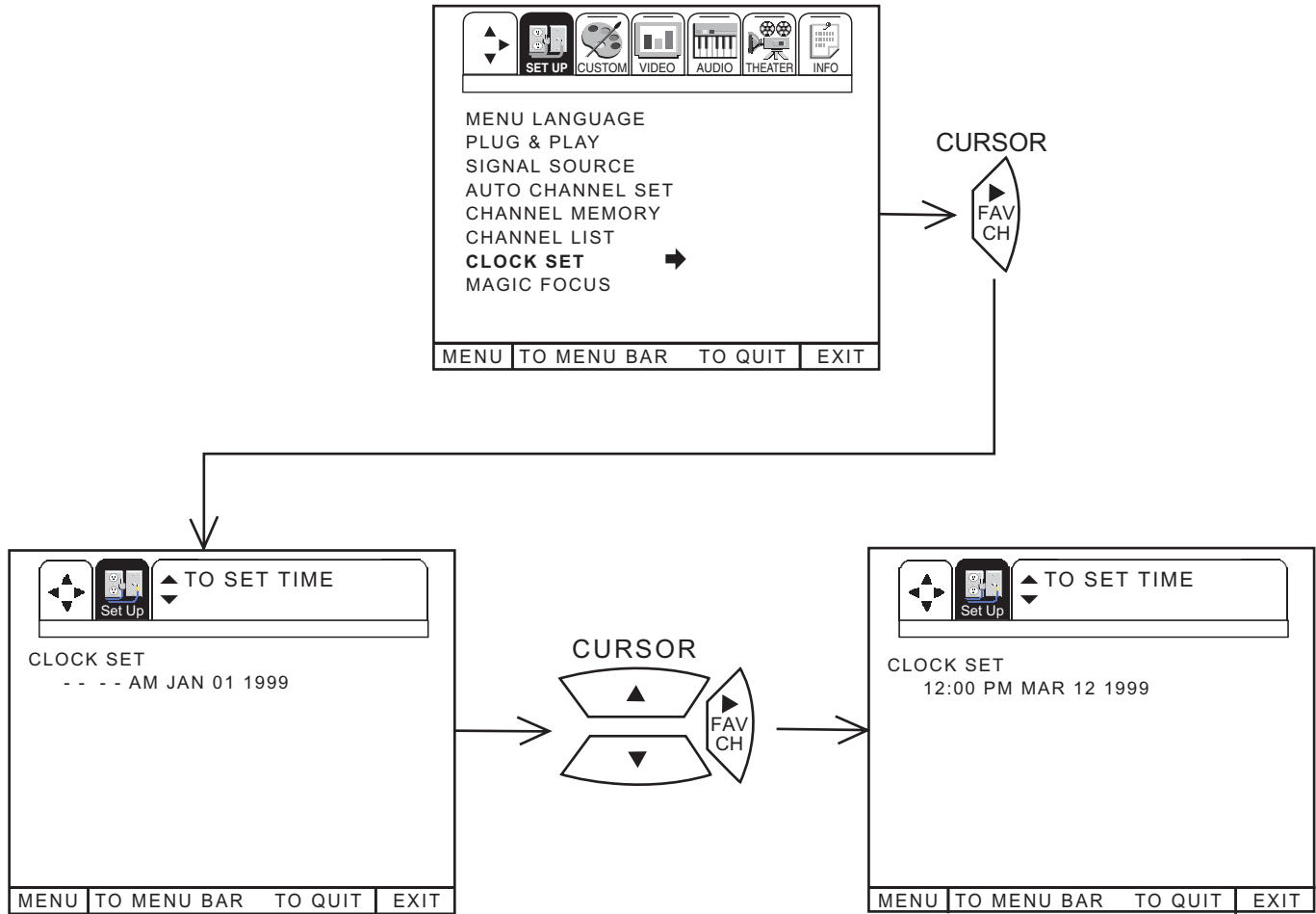

Use CURSOR ▲ or ▼ to set the time, date, and year.
 Press CURSOR ◀ or ▶ to change position.
 Press EXIT to quit menu or CURSOR ◀ to return to previous menu when the CURSOR is in the first position.

MAGIC FOCUS

Your HITACHI Projection TV has three color projection tubes: one for red, one for green, one for blue. When mixed together in the proper proportion, the output of these three color tubes can produce any color. To produce these colors, however, the beams must be precisely aligned over each other so that the colors can be mixed. The process of aligning these picture beams is called convergence.

Over a period of time, the picture tubes can drift out of alignment due to normal bumps and vibrations or moving the TV. If you move your TV, or if, after a time, you notice color rings or halos around objects in the picture, you may want to converge (align) the colors.

Properly converged, the lines appear white, which is actually a combination of the outputs of the three color tubes. The output of the green tube is stationary. The outputs of the red and blue tubes can be adjusted. When properly aligned, the outputs of all three tubes should be directly over each other to produce the white lines.

To simplify convergence, HITACHI incorporates a function called MAGIC FOCUS, which allows the TV to self-adjust. This process will take approximately 90 seconds. If this button is pressed during this 90 second period, no change in picture quality will occur. After this 90 second self-adjust period, picture quality will be optimum. (Do not move the TV during self-adjust.)

To enter this self-adjust mode, you may also select MAGIC FOCUS from the SETUP Menu. However, this will display a message prompting you to press the front panel MAGIC FOCUS button.

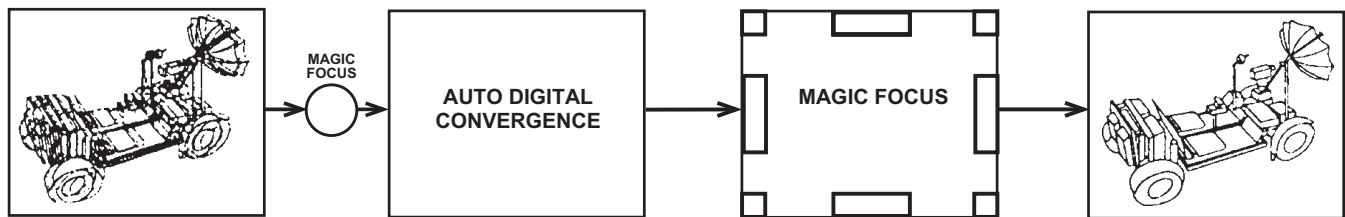

NOTES: Only a momentary press of the MAGIC FOCUS button is necessary to start AUTO DIGITAL CONVERGENCE. At anytime during this convergence correction process, you may press the MAGIC FOCUS button to exit the MAGIC FOCUS mode.

Do not press the MAGIC FOCUS button for more than three seconds. This is only for extreme cases of misconvergence and requires assistance from service. If one of the pictures shown below appears on the television screen, press the MAGIC FOCUS button a second time to exit this manual set up mode.

CENTER MODE

STATIC MODE



This selection contains advanced features which will make TV viewing easier and more enjoyable.

CHANNEL ID.

Use this feature to give up to 20 channels a name when ANTENNA signal source is selected and up to 60 channels a name when CATV1 signal source is selected.

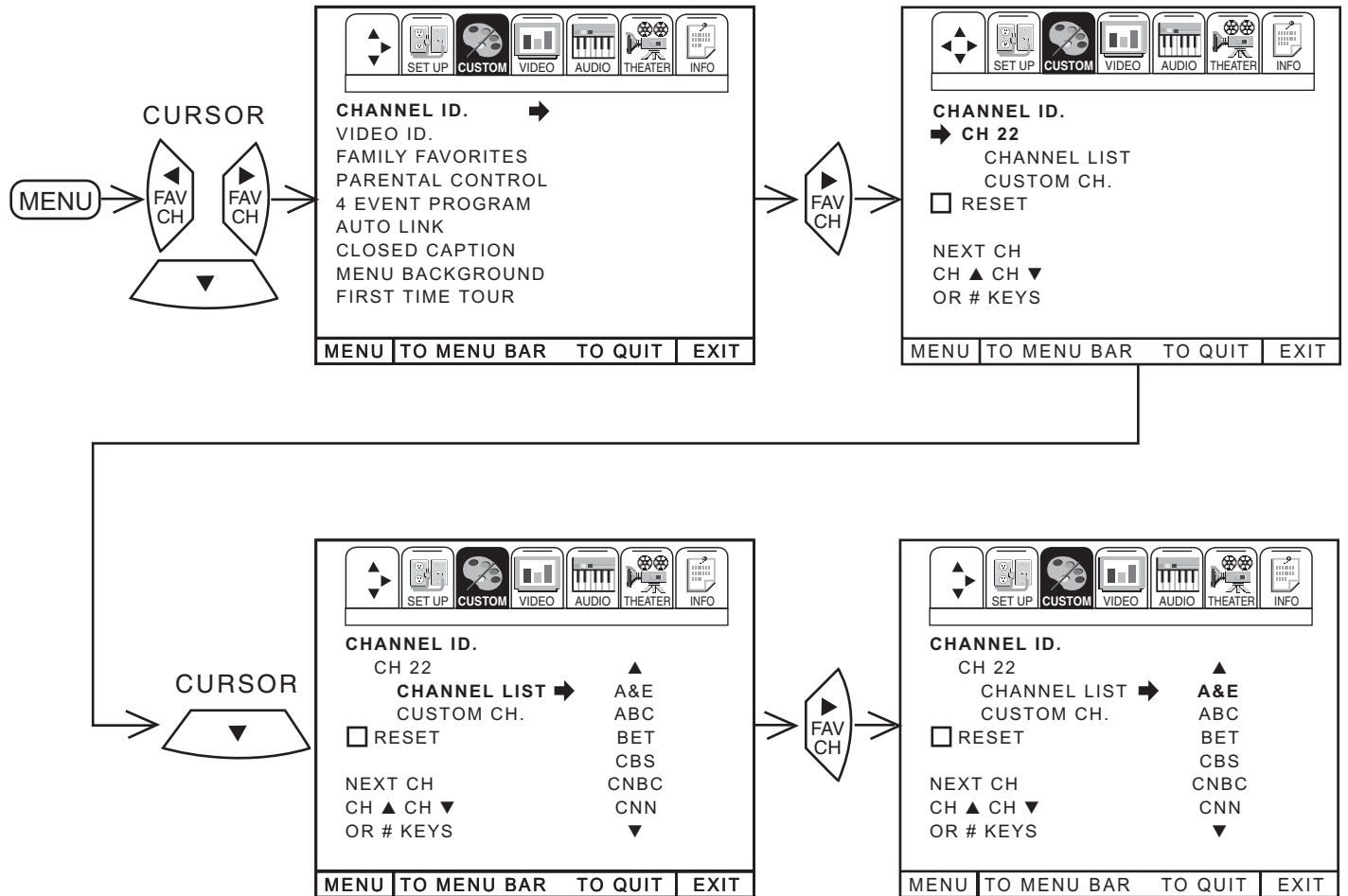

- Press **CURSOR ▼** to select **CHANNEL LIST**.
- Press **CURSOR ►** to select preset **CHANNEL LIST**.
- Press **CURSOR ▼** to scroll through the preset **CHANNEL LIST**.
- Press **CURSOR ►** to select desired **CHANNEL ID**.

To customize **CHANNEL ID**, select **CUSTOM CH**.

Press **CURSOR ▲** or **▼** to select letter.

Press **CURSOR ◀** or **▶** to change character position.

(*) represents a blank space.

Press **CHANNEL ▲** or **▼** and the number buttons to label additional channels.

Press **EXIT** to quit menu or **CURSOR ◀** to return to previous menu when the **CURSOR** is in the first position.

Select **RESET** to erase a **CHANNEL ID**.

NOTE: If **ANT A** and **ANT B** are in the same **SIGNAL SOURCE** mode (see page 38), the **CHANNEL ID** for both antenna inputs will be the same. **CHANNEL ID** will be displayed only when channel is displayed as main picture.

CUSTOM

VIDEO ID.

Use this feature to give a name to any of the three video inputs.

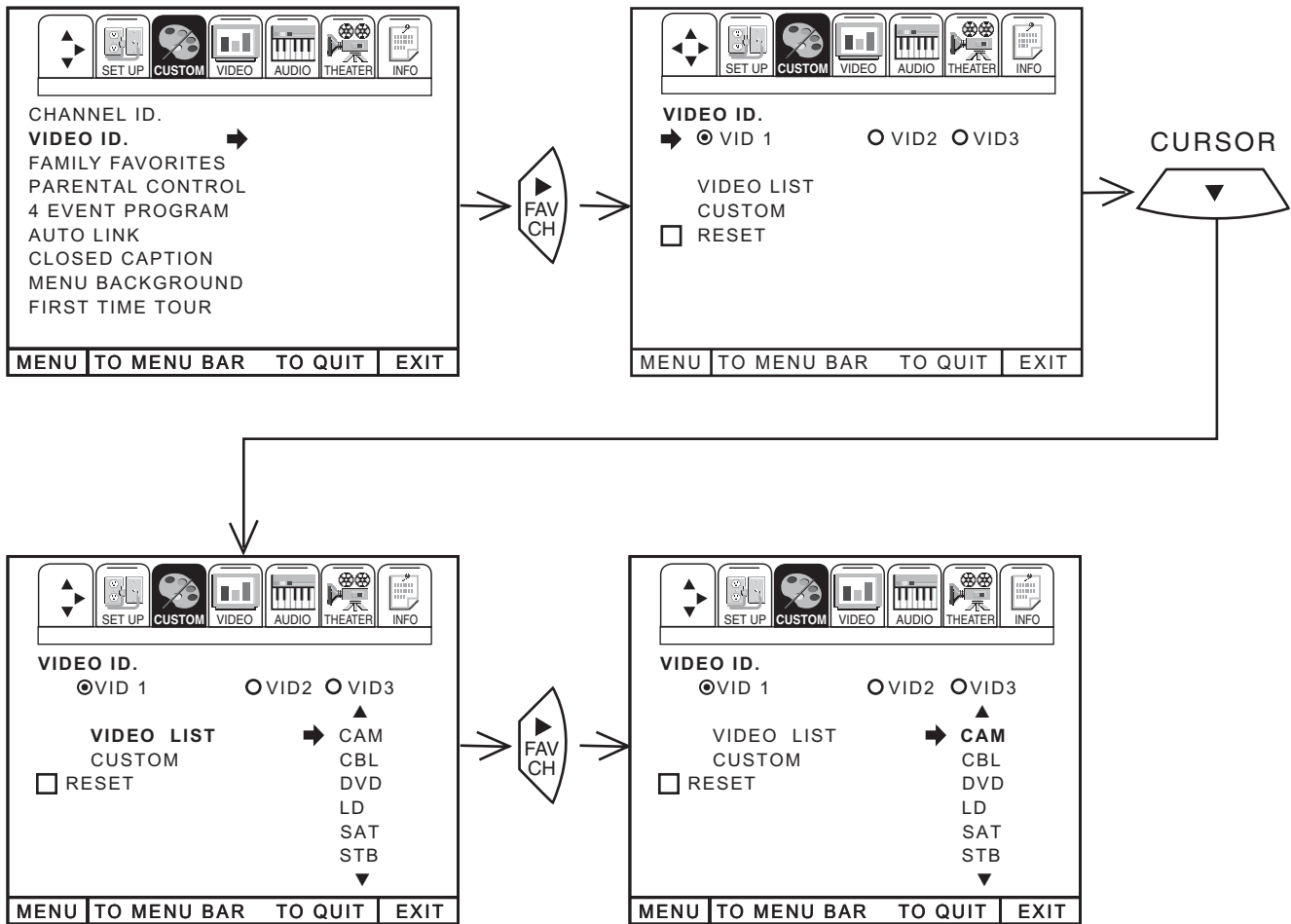

- Press CURSOR ▼ to select VIDEO LIST.
- Press CURSOR ► to select preset VIDEO LIST.
- Press CURSOR ▲ or ▼ to scroll through the preset VIDEO LIST.
- Press CURSOR ► to select desired VIDEO ID.
- To customize VIDEO ID, select CUSTOM.
- Press CURSOR ► (twice) to select the video input to be named.
- Press CURSOR ▲ or ▼ to select letters.
- Press CURSOR ► or ◀ to change position.
- Press EXIT to quit menu or CURSOR ◀ to return to previous menu when the CURSOR is in the first position.

(*) represents a blank space.
 Select RESET to set VIDEO ID to original condition.

NOTE: VIDEO ID will be displayed only when VIDEO input is displayed as main picture.

FAMILY FAVORITES (MENU)

This function allows you to group your favorite channels into six personalized categories that you can rename. A total of 42 channels can be stored in the FAMILY FAVORITES function.

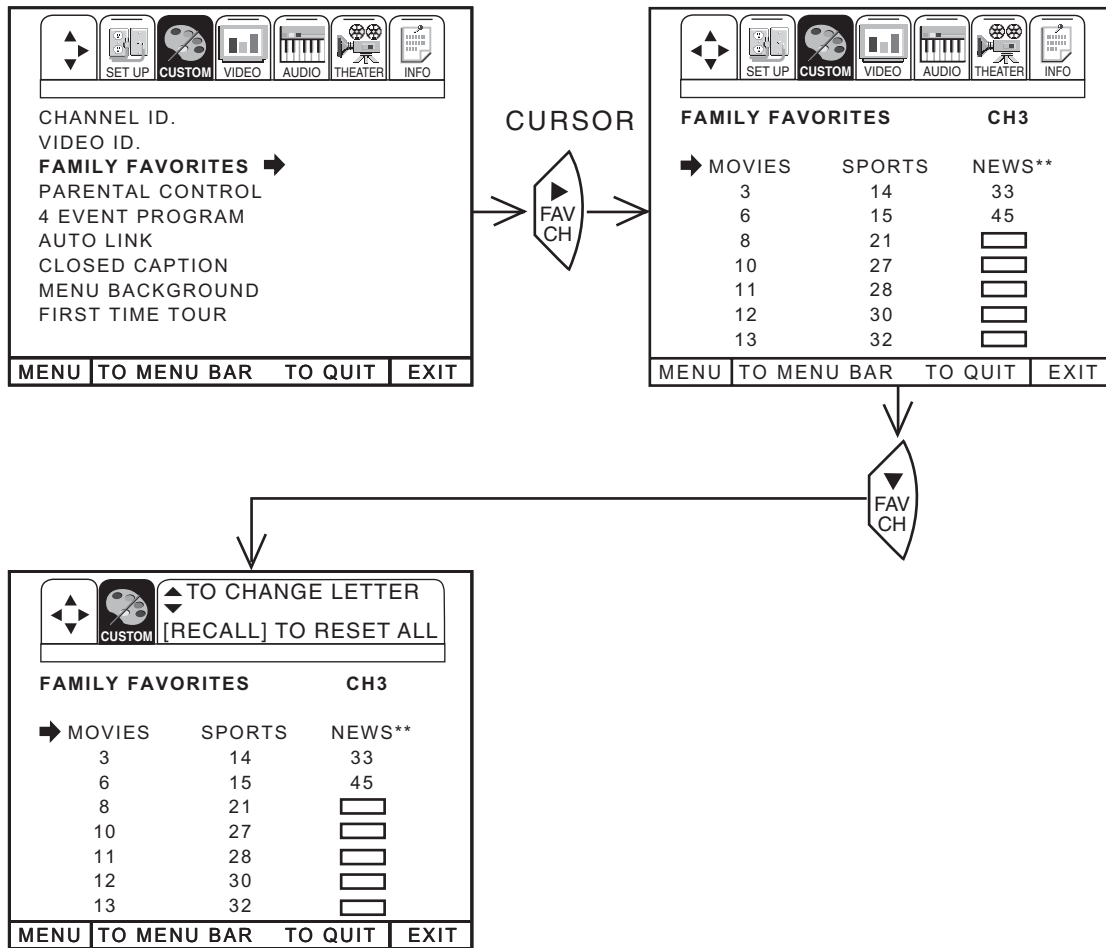

Channel stored with AUTO CHANNEL SET will automatically be stored in FAMILY FAVORITES.

To rename the categories, use the CURSOR buttons to highlight the category you would like to rename. Use CURSOR ▲ or ▼ to change a letter and CURSOR ► to select the next character to change.

To enter a channel into a category, highlight the channel location to be stored.

Press CHANNEL ▲ or ▼ or the number buttons to enter the desired channel. Repeat until category has been set with your favorite channels. The channel to be added is displayed in the top right corner of the screen.

Enter channel 00 to erase a favorite channel.

To reset categories and channels back to original factory preset, press RECALL while you are renaming a category.

NOTE: This function cannot be accessed when ANT B is the main channel. When the set is in a SIGNAL SOURCE different from ANT A, the message PLEASE SWITCH TO ANT A will appear.

FAMILY FAVORITES (OPERATION)

Use this function to display FAMILY FAVORITES selections as sub-pictures or to tune the main picture to a desired favorite channel.

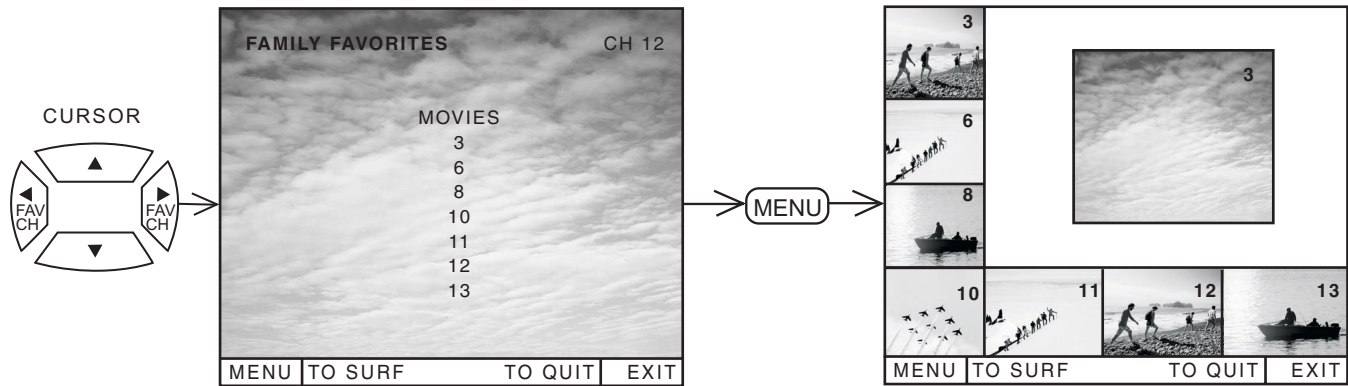

Select a category using CURSOR ◀ or ▶ buttons.

Press MENU and the category will be displayed as sub-pictures at the left and bottom edge of the screen. This is useful for previewing a category.

Use CURSOR ◀, ▶, ▲ or ▼ buttons to highlight a favorite channel and the TV will automatically tune to that channel.

Press EXIT to remove FAMILY FAVORITES OSD from the screen.

NOTE: If a category has some blank channel entries, these channels will appear as black sub-pictures.

PARENTAL CONTROL

This function will block out the picture and sound of the selected channel or video input. It can also be used to keep the TV from being viewed for a scheduled amount of time that you set.

The code to enter PARENTAL CONTROL is a four digit secret code number. The factory preset code is 0000. Use the number buttons to select secret code.

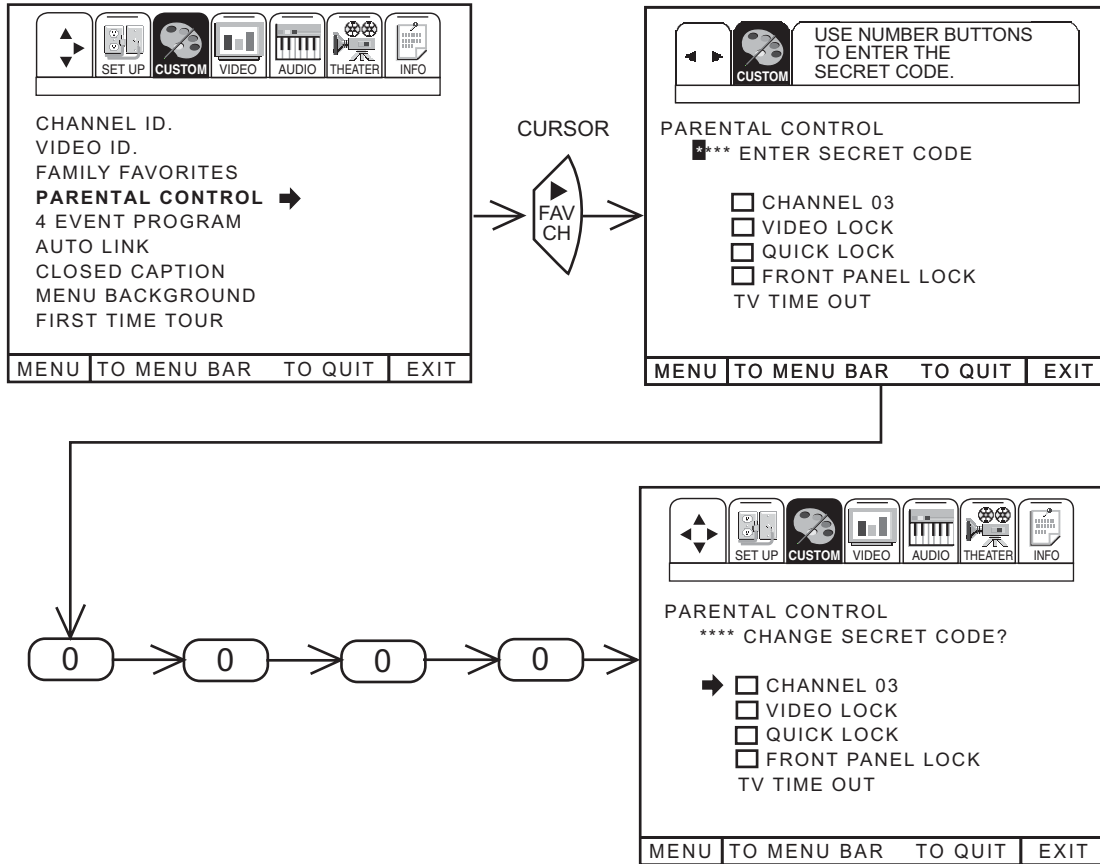

Use CURSOR ▲ or ▼ to highlight function and the CURSOR ► button to set ON or OFF.

When CHANNEL is turned on, the picture and sound for the chosen channel will be blocked out.

When VIDEO LOCK is turned on, the picture and sound for all video inputs will be blocked out. To lock the video inputs, you must be tuned to any video input.

When QUICK LOCK is turned on, the picture and sound for channels 3, 4 on both ANT A/B and all video inputs will be blocked out.

When FRONT PANEL LOCK is turned on, all buttons on the Front Panel will be deactivated, except the Power button.

When TV TIME OUT is turned on, you can set the BEGIN and END times and the TV cannot be viewed during that time period. (Set clock first.) Use CURSOR ▲ or ▼ to highlight ONCE (TV will time out one time only), DAILY (TV will time out every day), WEEKLY (TV will time out one time a week) or OFF (to disable this function) and then press cursor ► to select your choice.

To change the secret code number, select CHANGE SECRET CODE. Enter a new four digit key number you prefer.

If you forget your secret code, use the factory code 7777 to erase your key number. This will reset the secret code number back to the factory preset 0000.

Press EXIT to quit menu or cursor ◀ to return to previous menu.

- NOTES:**
1. If ANT A and ANT B are in the same SIGNAL SOURCE mode (see page 38), when a channel is locked, it is locked on both antenna inputs.
 2. When using TV TIME OUT make sure the clock is set (see page 42).

CUSTOM



4 EVENT PROG.

This function will automatically turn the TV on and off, one time only, every day or once a week.

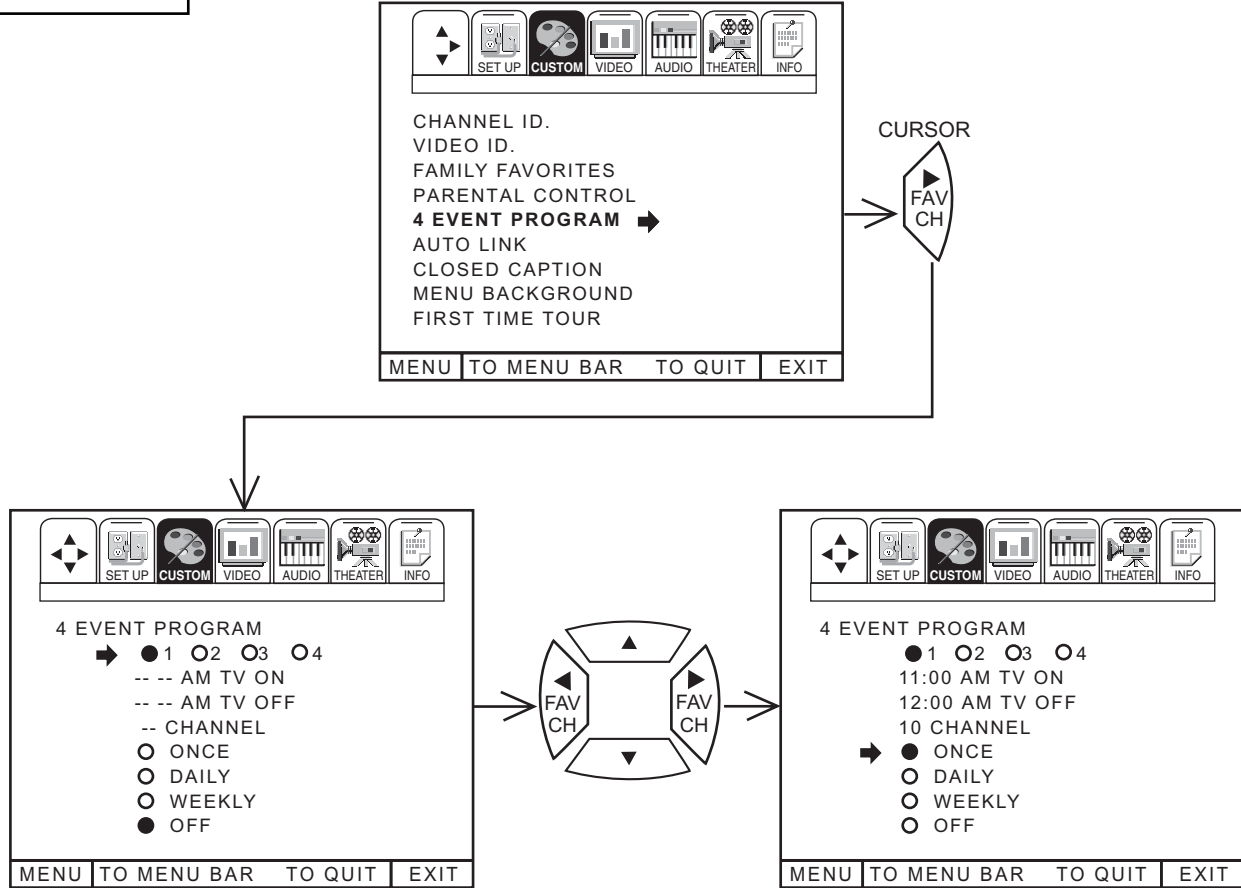

Press CURSOR ► to select PROGRAM 1, 2, 3, or 4.
 Press CURSOR ▲ or ▼ to select the time the TV will turn on and off.
 Use CURSOR ► to change position.
 Press CURSOR ▲ or ▼ to highlight then CURSOR ► to select MODE: ONCE (TV will turn on/off one time only) or MODE: DAILY (TV will turn on/off at the same time every day), or MODE: WEEKLY (TV will turn on/off at same time every week) and MODE: OFF (to disable this function).
 Press CURSOR ▲ or ▼, CHANNEL (▲) or (▼), or number buttons to set the channel the TV will tune to when it automatically turns on.
 Press EXIT to quit menu or cursor ◀ to return to previous menu.
 If the clock is not set, you can not use this function and the screen below will appear.



- NOTES:**
1. The OFF Timer will only activate if the TV was turned on or tuned with the ON Timer and no channel selection was made after this time. If you change the channel after the ON Timer has been activated, the OFF Timer will deactivate.
 2. If no remote control button is pressed after ON Timer is activated, the TV will automatically turn off after three hours.

CAUTION: Do not use your TV as a deterrent when away from home by using the ON and OFF TIMERS. For safety, the TV should be turned off when you are away from home.



AUTO LINK

Use this function to automatically turn the TV on and tune to VIDEO: 1, 2, or 3, when it detects a VIDEO input.

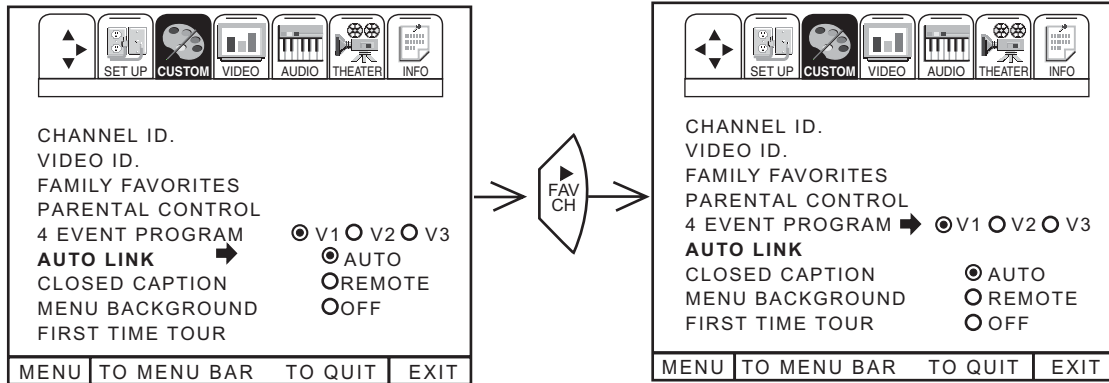

Use CURSOR ► to select Video Input.
 Use CURSOR ▲ or ▼, then CURSOR ►, to change AUTO LINK setting.

When AUTO is selected, the TV will turn on and tune to VIDEO: 1, 2, or 3 automatically, when a VIDEO: 1, 2, or 3 input is detected. This is convenient when you want to watch a movie with your VCR, laserdisc player, or DVD player.

When REMOTE is selected, the TV will turn on and tune to VIDEO: 1, 2, or 3 automatically, when a VIDEO: 1, 2, or 3 input is detected and the VCR, laserdisc, or DVD play button on your remote control is pressed. This is convenient when you want to record a movie with your VCR and watch it later.

Select OFF to disable this function.
 Press EXIT to quit menu or CURSOR ◀ to return to previous menu.

- NOTES:**
- Once the TV has been turned on using the AUTO LINK feature, it must be reset before AUTO LINK is used again. To do this, turn your VCR, laserdisc, or DVD player OFF. This feature is now reset and will turn on your TV as described above.
 - When using REMOTE mode, any remote control button will substitute for your video input device play button. However, intended operation is for use with your VCR, laserdisc, or DVD play button.

CUSTOM



CLOSED CAPTION

Closed captions are the dialogue, narration, and/or sound effects of a television program or home video which are displayed on the TV screen. Your local TV program guide denotes these programs as **CC** or .

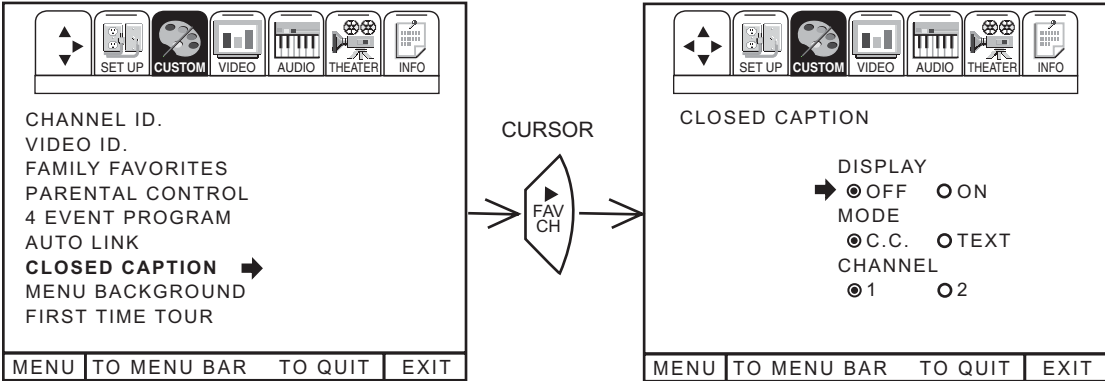

DISPLAY: ON/OFF will turn the **CC** display on or off.

MODE: C.C. (Closed Caption) is for the program you are viewing.

TEXT is for additional information such as news reports or a TV program guide. This information covers the entire screen and viewing the TV program is not possible. TEXT may not be available with every **CC** program.

CHANNEL: 1 is used for the primary language (usually English).
2 is sometimes used for a second language (may vary by region).

Use CURSOR ▲ or ▼ to highlight the function to change then press CURSOR ► to change the function. Press EXIT to quit menu or CURSOR ◀ to return to previous menu.

NOTE: If you do not have sound, make sure MUTE is not set.

MENU BACKGROUND

This function allows you to choose from three menu backgrounds.

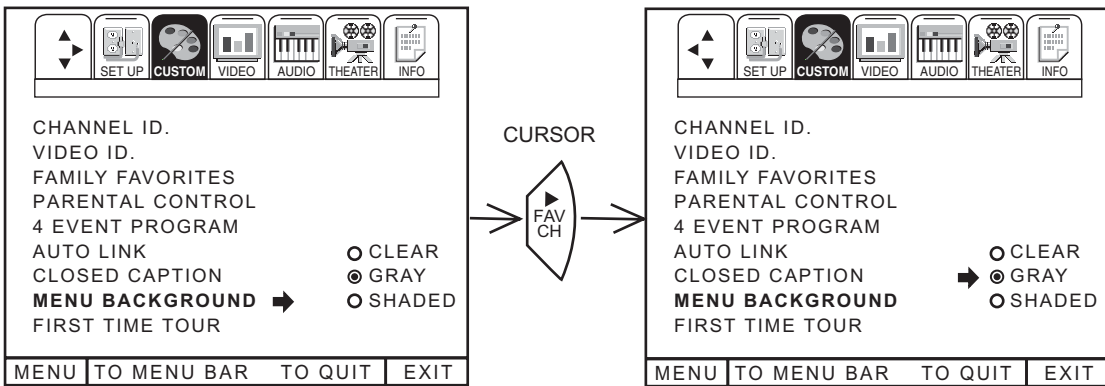

Use CURSOR ▲ or ▼ to change MENU BACKGROUND setting. Press EXIT to quit menu or CURSOR ◀ to return to previous menu. Select CLEAR and no background is visible, select GRAY and a gray background is visible (no picture can be seen behind menu screen), select SHADED and a light background is visible.

FIRST TIME TOUR

This function introduces you to the First Time Tour Setup Feature, showing you basic TV functions as well as helping you set up your TV or Home Theater System. This feature will be displayed every time your TV is turned on, unless you set FIRST TIME TOUR to OFF.

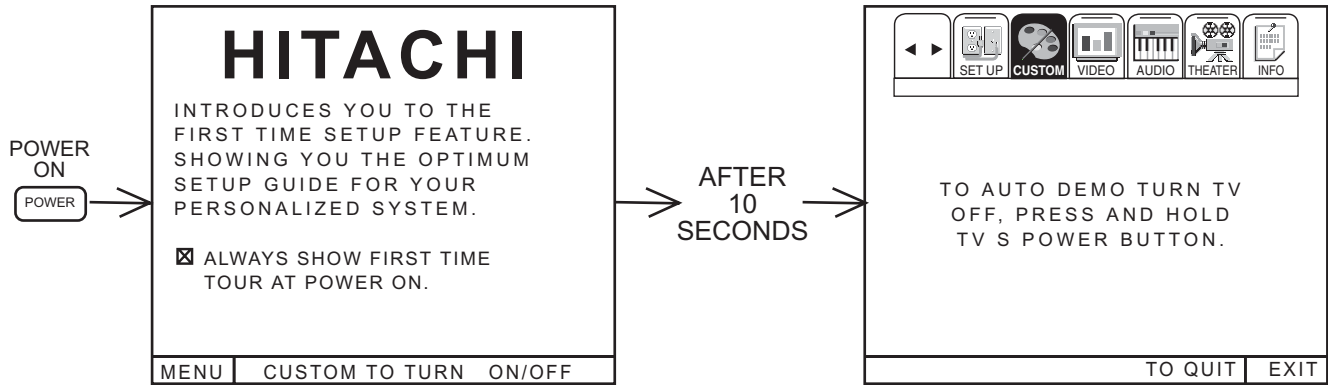

To disable this function, press the MENU button at any time during the tour, and the following screen will appear.

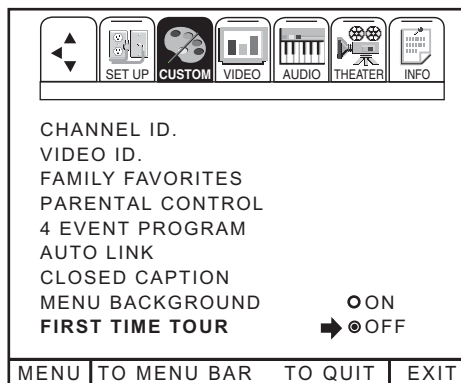

Use CURSOR ▲ or ▼ then CURSOR ► to select ON or OFF.
 Press EXIT to quit Menu or CURSOR ◀ to return to previous menu.

- NOTE:**
1. When TV set is turned on, the First Time Tour will always appear if it is set to ON.
 2. To exit during the First Time Tour, press the MENU button.

VIDEO



Select VIDEO to adjust picture settings and improve picture quality.

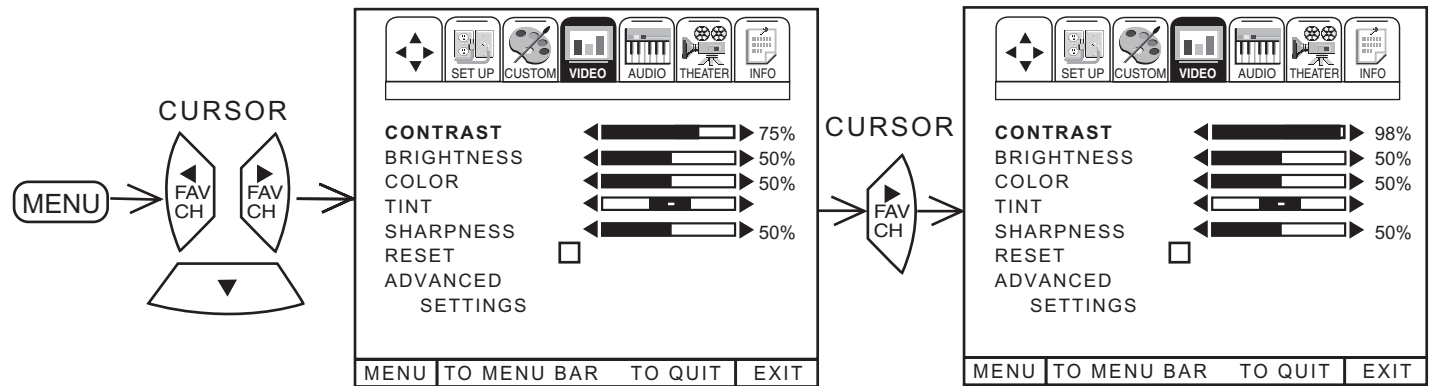

Use the CURSOR ▲ or ▼ buttons to highlight the function to be adjusted.
 Press the CURSOR ◀ or ▶ buttons to adjust the function.
 Press EXIT to quit menu.

- NOTE:**
1. If CONTRAST is selected, you are adjusting CONTRAST. The additional menu items BRIGHTNESS, COLOR, TINT, and SHARPNESS can be selected and adjusted in the same manner.
 2. Contrast and Brightness adjustments will affect only the main picture. These adjustments will not affect the sub-picture.

- | | |
|-------------------|---|
| CONTRAST | Use this function to change the contrast between black and white levels in the picture. This adjustment will only affect the picture when ADVANCED SETTINGS ULTRA AI is OFF. (See page 54.) |
| BRIGHTNESS | Use this function to adjust overall picture brightness. |
| COLOR | Use this function to adjust the level of color in the picture. |
| TINT | Use this function to adjust flesh tones so they appear natural. (It may be necessary to adjust TINT to obtain optimum picture quality when using the COMPONENT: Y-C _B C _R Input 2 jacks). |
| SHARPNESS | Use this function to adjust the amount of fine detail in the picture. |
| RESET | When RESET is selected, press CURSOR ▶ to return video adjustments to factory preset conditions. |

ADVANCED SETTINGS

Your HITACHI Projection TV has an Ultra AI (Artificial Intelligence) function which will automatically adjust picture settings to produce the highest quality picture possible. When AI is highlighted, use CURSOR ► to turn the AI on or off.

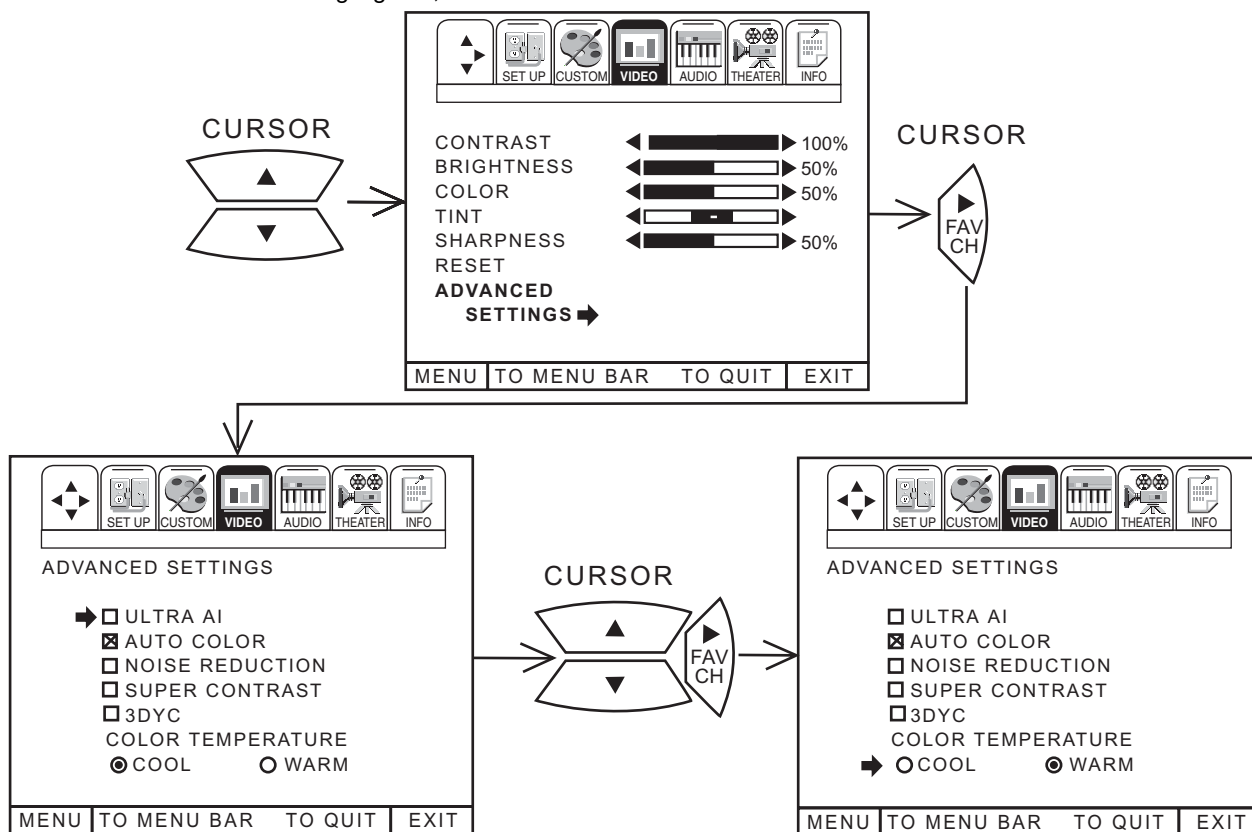

Use CURSOR ▲ or ▼ to select function.

Use CURSOR ► to change the function setting. When the function has an X in the box, it is ON.

Press EXIT to quit menu or CURSOR ◀ to return to previous menu.

ULTRA AI (ARTIFICIAL INTELLIGENCE)

When the AI function is on, the TVs internal computer will perform the following:

1. Automatically monitor and adjust contrast depending on room lighting (sensor is located in the front panel) to produce a more natural picture.
2. Automatically monitor and adjust color levels and maintain natural flesh tones.
3. Automatically compensate for weak or strong TV signals to produce a clear picture.

Turn the AI function off to control other PREFERENCE SETTINGS.

AUTO COLOR

The AUTO COLOR function automatically monitors and adjusts the color to maintain constant color levels even after a program or channel changes. It also maintains natural flesh tones while preserving fidelity of background colors. (This function will automatically set to on and cannot be turned off when the ULTRA AI function is ON.)

NOTE: It may be necessary to set AUTO COLOR-ON to obtain optimum picture quality when using the COMPONENT: Y-C_BC_R Input 2 jacks.

NOISE REDUCTION

The NOISE REDUCTION function automatically reduces conspicuous noise in the picture without degrading picture quality. (This function will automatically set to on and cannot be turned off when the ULTRA AI function is ON.)

SUPER CONTRAST

Turn on SUPER CONTRAST to improve picture detail in areas of high brightness.

3DYC

Turn on 3DYC to eliminate flickering, or picture artifacts, that a detailed pattern or scene would normally cause.

COLOR TEMPERATURE

Set this to WARM for hotter colors with more red, or set to COOL for less intense colors with more blue.

AUDIO



Select AUDIO SETTINGS to adjust the TV to your preference and to improve the sound quality.

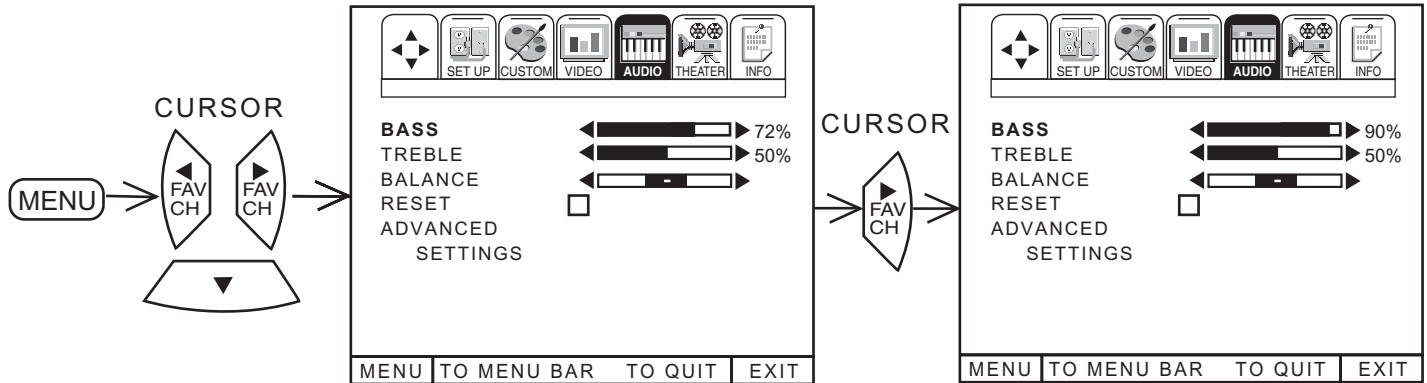

Use CURSOR ▲ or ▼ to highlight the function to be adjusted.
 Press CURSOR ◀ or ▶ to adjust the function.
 Press EXIT to quit menu.

NOTE: If BASS is selected you are adjusting BASS. The additional menu items TREBLE and BALANCE can be selected and adjusted in the same manner.

BASS

This function controls the low frequency audio to all speakers.

TREBLE

This function controls the high frequency audio to all speakers.

BALANCE

This function will control the left to right balance of the TV internal speakers, the AUDIO TO HI FI output, and WIRELESS OUT output.

RESET

When RESET is selected, press CURSOR ▶ to return audio adjustments to factory preset conditions.

NOTE: If BASS or TREBLE are adjusted, the GRAPHIC EQUALIZER will automatically be disabled. The BALANCE function is disabled when SURROUND-DOLBY PRO LOGIC or SURROUND-DOLBY 3 STEREO are selected. (See page 59.)

ADVANCED SETTINGS

Use ADVANCED SETTINGS to improve the sound performance of your TV, depending on listening conditions.

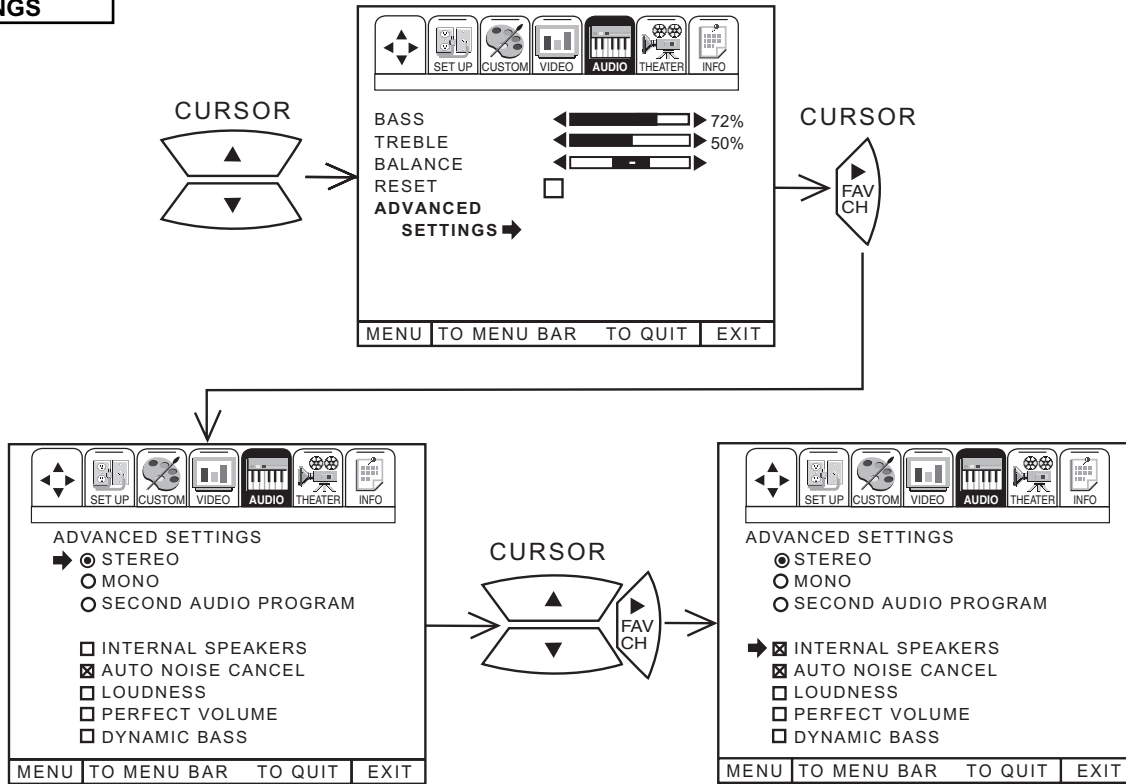

Press CURSOR ▲ or ▼ to highlight a function. Press CURSOR ► to change the function setting. When the function has an X in the box, it is ON.

MTS MODE

Multi-Channel Television Sound will allow you to select STEREO (a stereo broadcast), MONO (monaural sound) used when receiving a weak stereo broadcast or SAP (second audio program) which may be a secondary language, weather report, etc.

The sources received will be displayed at the top center edge of the TV. The source you select will be displayed above the sources received. See example below for each selection when both stereo and second audio are received (monaural is always received).

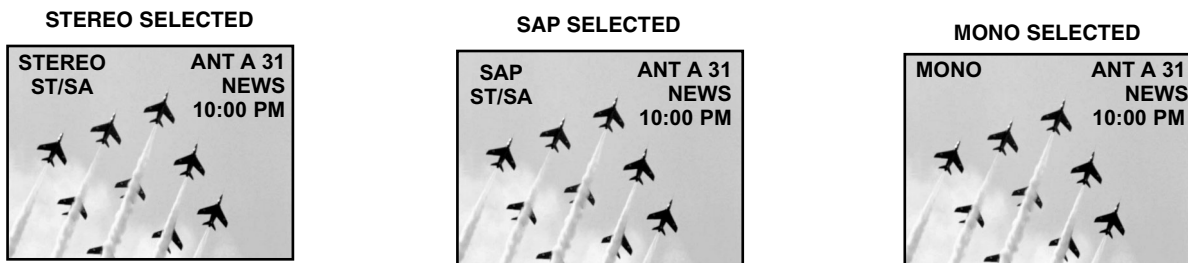

INTERNAL SPEAKERS

This function is useful when first setting up the external speakers, or if you prefer to use only speakers from a separate stereo system.

AUTO NOISE CANCEL

This function eliminates the noise between stations. If a channel is tuned and is noisy, this function will automatically eliminate the audio for that channel.

LOUDNESS

This function will improve the quality of both low and high frequency sounds when listening at low volume levels. (Enabling this function will automatically disable the GRAPHIC EQUALIZER.)

PERFECT VOLUME

This function will automatically adjust volume so each channel has the same average volume level. (This function will automatically be disabled when SURROUND-DOLBY PRO LOGIC or SURROUND DOLBY 3 STEREO are selected, to ensure correct DOLBY SURROUND sound decoding.) See page 59.

DYNAMIC BASS

This function allows you to enjoy spectacular bass sound that would normally be heard only with expensive home speaker systems.

NOTE: If optional left and right speakers are connected while in SURROUND-DOLBY PRO LOGIC (Normal mode) or SURROUND-DOLBY 3 STEREO (Normal mode), the internal speakers may be turned off for better separation between left, center, and right channels (see page 59). The center channel audio will still be heard from the television's center speakers.



THEATER



Use this function to choose picture settings for a true home THEATER experience.

THEATER MODES

Use this function to choose from automatic picture settings to optimize your TV's performance.

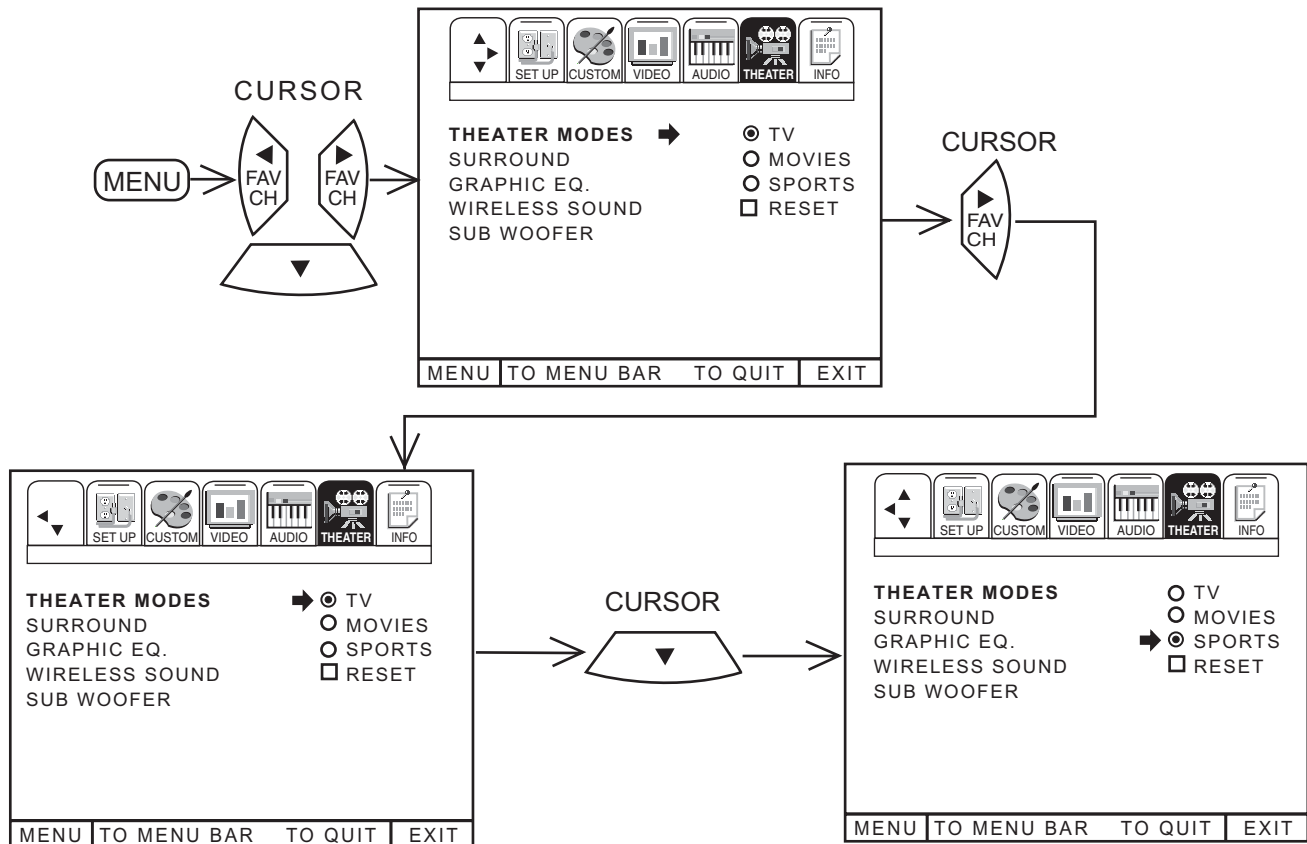

Use CURSOR ▲ or ▼ to change THEATER MODES settings.

When TV mode is chosen, the following are automatically set: Contrast almost maximum, Super Contrast-OFF, Color Temp.-Cool, Loudness-ON, Perfect Volume-ON, Dynamic Bass-ON.

When MOVIE mode is chosen, the following are automatically set: Contrast almost center, Super Contrast-OFF, Color Temp.-Warm, Loudness-OFF, Perfect Volume-OFF, Dynamic Bass-OFF.

When SPORTS mode is chosen, the following are automatically set: Contrast-Maximum, Super Contrast-ON, Color Temp.-Cool, Loudness-OFF, Perfect Volume-OFF, Dynamic Bass-OFF.

You can customize each of the above modes (TV, MOVIE, and SPORTS) to your preference to increase viewing performance and pleasure, depending upon the video program being viewed. However, if RESET is selected, all modes will reset to the initial conditions as explained above.

When RESET is selected, it will take approximately two seconds to return to factory conditions (SPORTS mode).

Press EXIT to quit menu or CURSOR ◀ to return to previous menu.

SURROUND

The following surround settings will reproduce the live sound you would hear in concert halls, sports stadiums, movie theaters, etc. when you set up your speaker system as shown in the section on audio system setup on pages 20-21. The surround system is most effective with movie and other stereo material that is Dolby Surround encoded, and played on a stereo VCR.

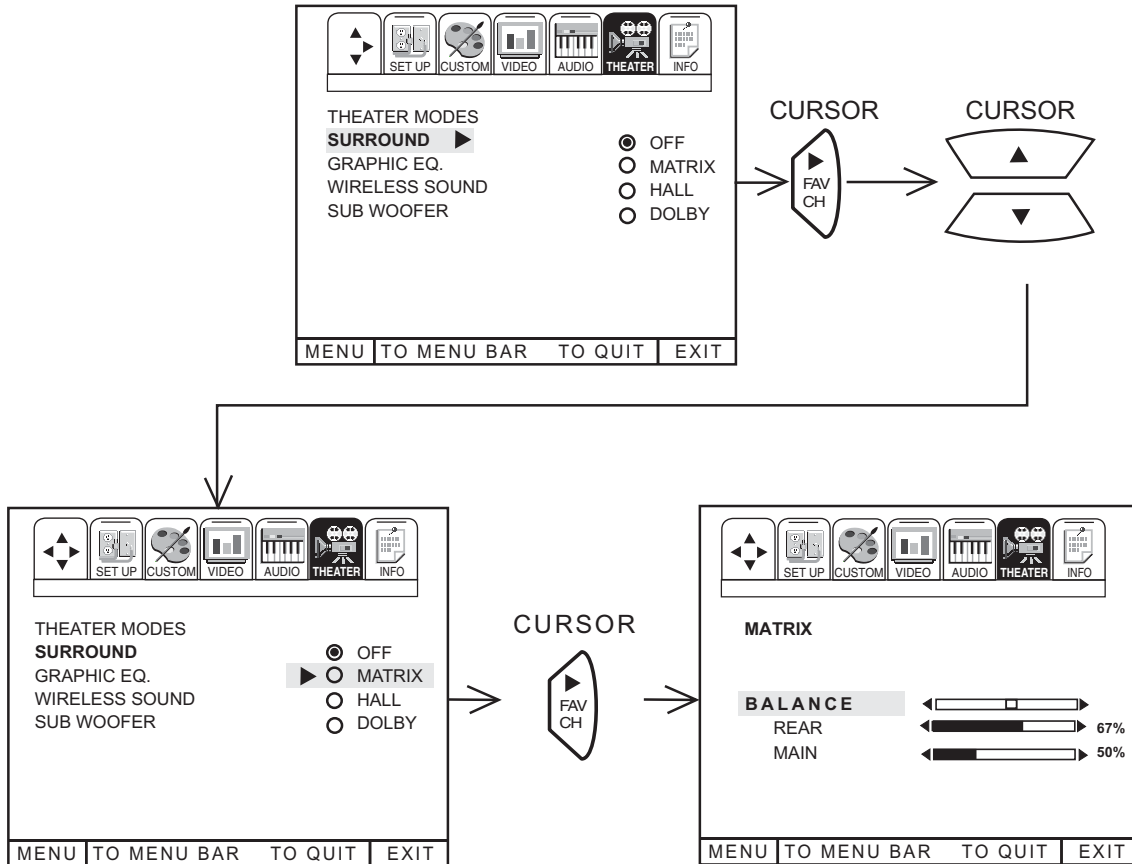

When using WIRELESS SOUND, REAR SPEAKERS mode must be chosen to receive the Surround audio program.

To enter the SURROUND MODE, use CURSOR ▲ or ▼ to highlight then press CURSOR ► to select SURROUND MODE of your choice.

Now press CURSOR ▲ or ▼ to highlight, then press CURSOR ► to select function to be adjusted.

Use CURSOR ◀ or ▶ to adjust the volume of rear and main speakers. Main volume also controls AUDIO TO HI-FI output level. Adjust main volume first.

Each surround setting has separate main and rear volume controls, except OFF and DOLBY 3 STEREO which have no rear volume controls. DOLBY PRO LOGIC and DOLBY 3 STEREO also have center volume controls, while MATRIX and HALL have balance controls. (Balance while in DOLBY PRO LOGIC and DOLBY 3 STEREO modes is adjusted by using the TEST TONE volume controls.) The center and rear volume will increase or decrease when main is adjusted, keeping an equal balance between the surround channels.

The maximum volume allowed for the center and rear will depend on how loud the main volume is set.

SURROUND OFF

Use this for normal stereo/mono broadcasts.

MATRIX SURROUND

Listener is surrounded by many sound sources such as a sporting event, etc.

NOTE: Some TV systems do not transmit optimum audio channel separation which can reduce the effectiveness of the MATRIX SURROUND function.

HALL SURROUND

Resonant sound-Listener has the feeling of being in a concert hall.

DOLBY PRO LOGIC

Dolby Pro Logic provides four separate sound channels: left, center, right, and surround. For properly encoded programs marked the center sound channel contains the dialogue for the program viewed. The left and right channels produce sound effects that will match the action on the TV screen. For example, Dolby Pro Logic will enhance the effect of a car viewed driving from the left side of the TV screen to the right side. The surround channel (speakers) are placed behind the viewing area to add additional spatial sound effects.

To fully benefit from Dolby Pro Logic Surround, it is recommended that the surround speaker system be complete as shown on page 20.

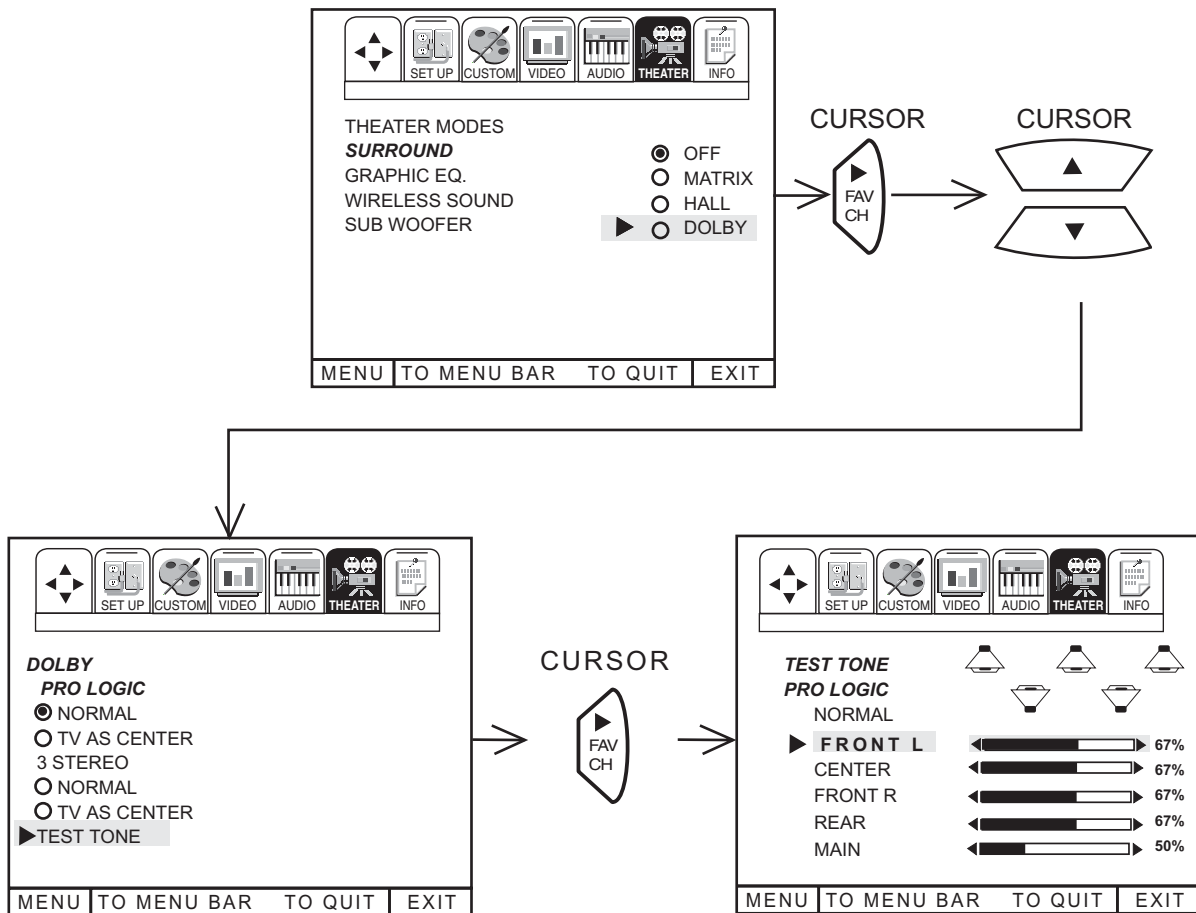

Press CURSOR ▲ or ▼ to highlight a surround function.
Use CURSOR ► to change the surround function.

The function can be set to DOLBY 3 STEREO or DOLBY PRO LOGIC. When DOLBY 3 STEREO is set, the surround channel sound is split equally between the left and right speakers of the separate audio amplifier. When DOLBY PRO LOGIC is set, separate surround sound speakers must be used.

Also, the function can be set to NORMAL or TV AS CENTER. When NORMAL is set, center channel sound is sent to the TV center speakers, while left and right audio is sent to the TV's left and right speakers. When TV AS CENTER is set, center channel sound is sent to the TV center speakers while left and right audio is sent to the left and right speakers of a separate audio amplifier (TV's left and right speakers are automatically turned off).

TEST TONE

A test sound is generated allowing the listener to balance volume from each channel. Adjust the volume levels until all channels are equal.

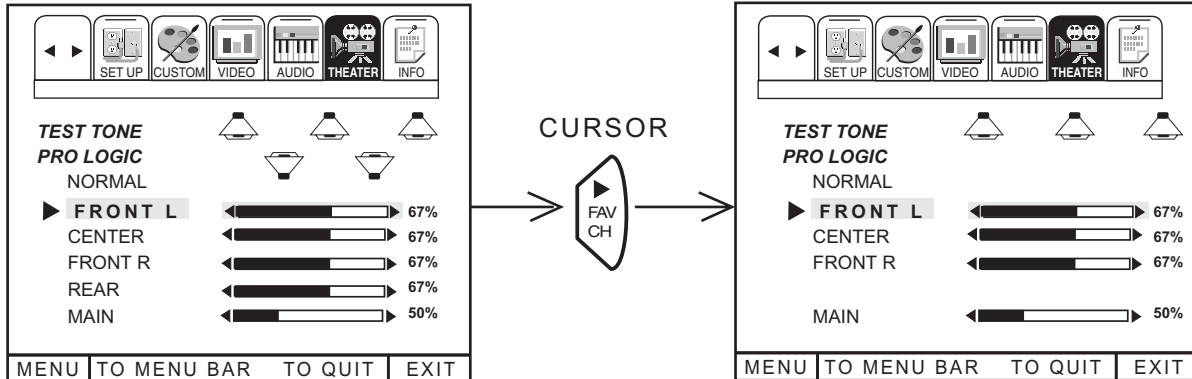

DOLBY PRO LOGIC

DOLBY 3 STEREO

Press CURSOR ▲ or ▼ to highlight, then press CURSOR ► to select TEST TONE.

Automatic scanning of applicable speakers for your chosen Surround mode will occur. Simply wait until the speaker you wish to adjust is highlighted (static noise will be heard from this speaker), then use CURSOR ◀ or ▶ to adjust VOLUME. (Adjust balance by adjusting Front L and Front R volume control.)

Press EXIT to quit menu or MENU to return to previous menu.

NOTE: When in Dolby Surround Mode, the Audio-Advanced Settings-Perfect Volume feature will automatically be disabled to ensure correct DOLBY SURROUND sound decoding.

GRAPHIC EQUALIZER

Use this function to precisely control tonal quality by using seven different frequency controls.

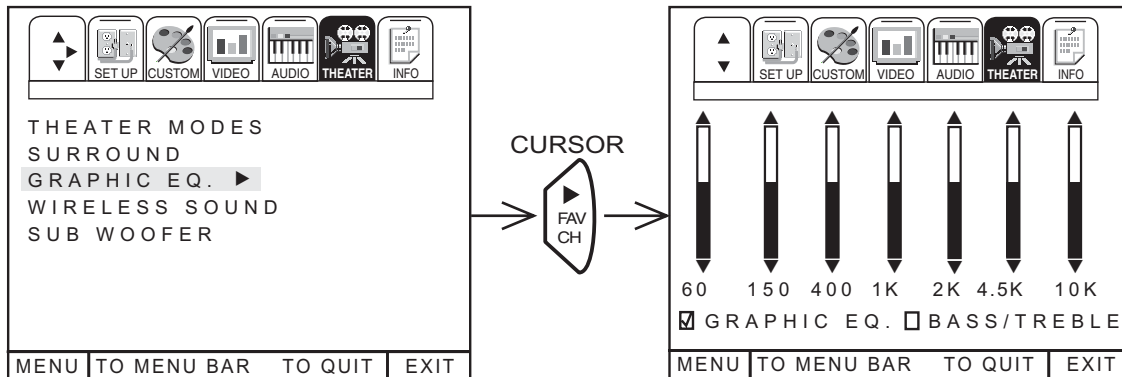

Press CURSOR ► to select the frequency you wish to adjust.

To increase the amount of frequency audio to all speakers, use CURSOR ▲.

To decrease the amount of frequency audio to all speakers, use CURSOR ▼.

Press EXIT to quit menu or CURSOR ◀ to return to previous menu when the CURSOR is in the first position.

NOTE: When this function is used or adjusted, the AUDIO SETTINGS functions BASS and TREBLE will be disabled and LOUDNESS will be set to off.

WIRELESS SOUND

This feature allows you to choose between two possible variable audio outputs for a separate set of wireless speakers or another stereo amplifier. The audio output may be either MAIN TV AUDIO or PIP AUDIO.

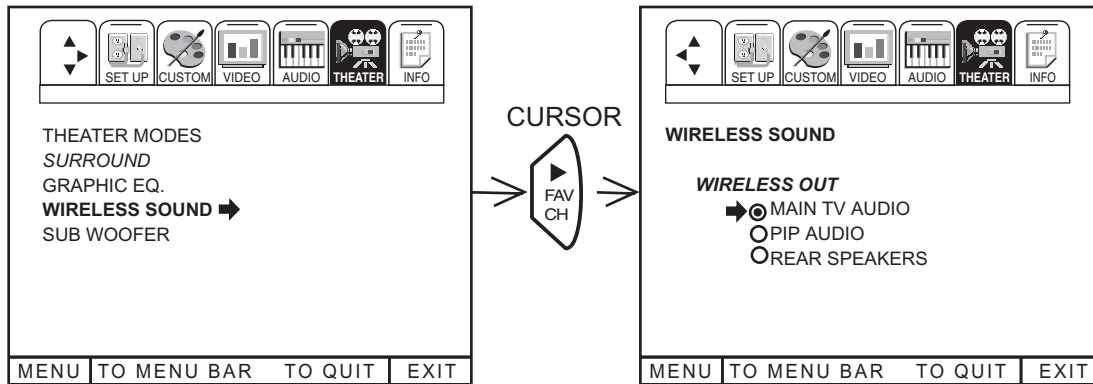

Press CURSOR ▲ or ▼ to highlight a function.
 Press CURSOR ► to select the function.
 Press EXIT to quit menu or CURSOR ◀ to return to previous menu.

MAIN TV AUDIO

When set to MAIN TV AUDIO mode, your wireless speakers will play the same audio program as played on your TV. The volume of your wireless speakers will be controlled by the TV volume control.

PIP AUDIO

When set to PIP AUDIO mode, your wireless speakers will play the PIP sub-picture audio program. The volume of your wireless speakers will now be controlled by the PIP VOLUME control, which may be varied from 0 (min.) to 100 (max.). If no sub-picture is displayed, the wireless speakers will play the main channel audio program with the volume being controlled by the TV volume control.

REAR SPEAKERS

When set to REAR SPEAKERS mode, your wireless speakers will play the surround audio program. The volume of your wireless speakers will be controlled by the TV volume control, dependent upon the amount of REAR selected from SURROUND mode. (See pages 58 and 59.)

SUB WOOFER

Use this feature to provide variable audio output to an optional sub woofer.

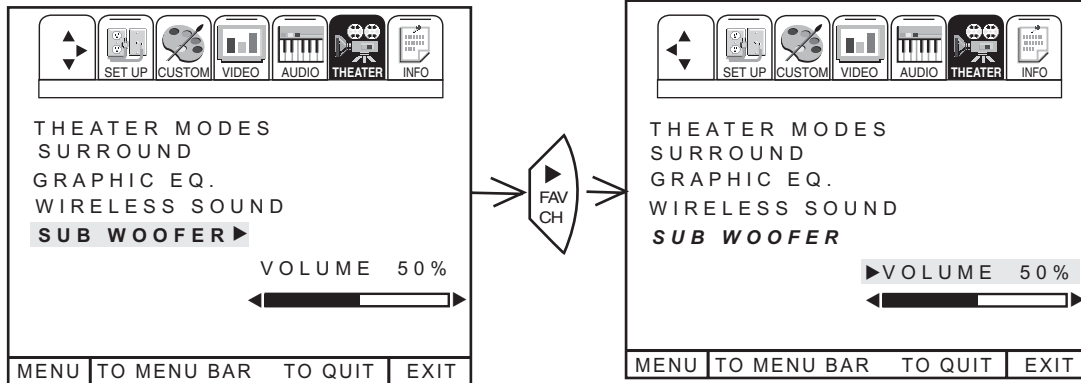

Press CURSOR ▼ to select volume adjustment bar.

Press CURSOR ◀ or ▶ to adjust SUB WOOFER volume.

Press EXIT to quit menu or CURSOR ▲ to highlight VOLUME, then CURSOR ◀ to return to previous menu.

NOTE: The Sub Woofer volume will increase or decrease when main volume is adjusted.



This function allows your TV to assist you with your busy day-to-day schedule.

SPECIAL EVENT REMINDER

Use this function to set up to six special events into memory. These events can then be viewed in CALENDAR mode.

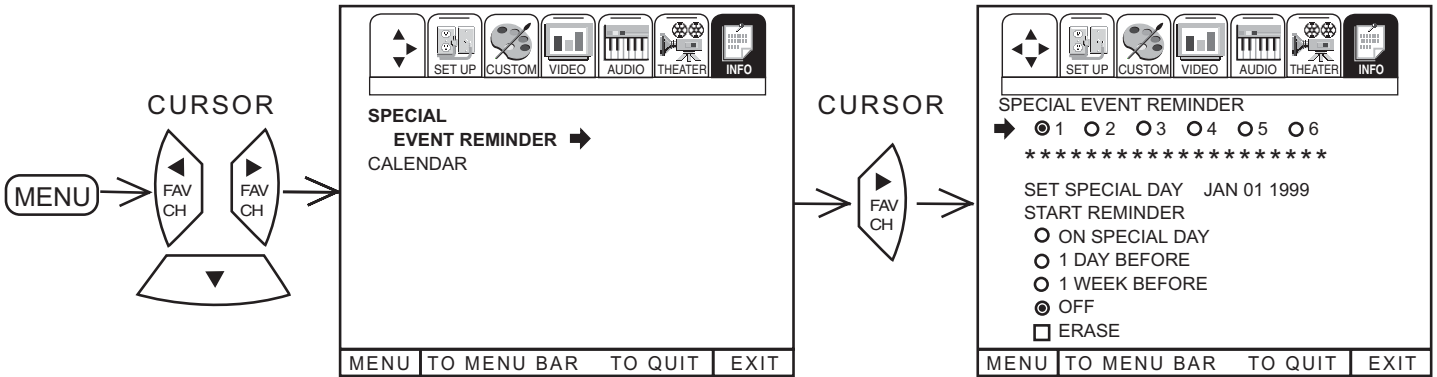

Press CURSOR ► to select EVENT 1 to 6.
 Press CURSOR ▲ or ▼ to select a letter.
 Press CURSOR ► to change position.
 Set Special Day of reminder using cursor buttons.

Highlight the day of Start Reminder using CURSOR buttons, then press CURSOR ► to select.
 To erase SPECIAL EVENT, select ERASE EVENT then press CURSOR ►.
 Press EXIT to quit menu or CURSOR ◀ to return to previous menu.

If the clock is not set, you can not use this function and the next screen will appear.



NOTE: 1. When the TV is turned on, the SPECIAL EVENT REMINDER message will automatically appear at the selected time.
 2. Each special event message can be a maximum of 20 characters.
 3. When the RECALL button is pressed, a special icon appears on the right bottom side of the screen and indicates a SPECIAL EVENT REMINDER message. Press the RECALL button again to display the SPECIAL EVENT REMINDER message.

CALENDAR

Use this function to check the day, month, and year.

Dates programmed in SPECIAL EVENT REMINDER will appear blinking and special event message will be displayed.

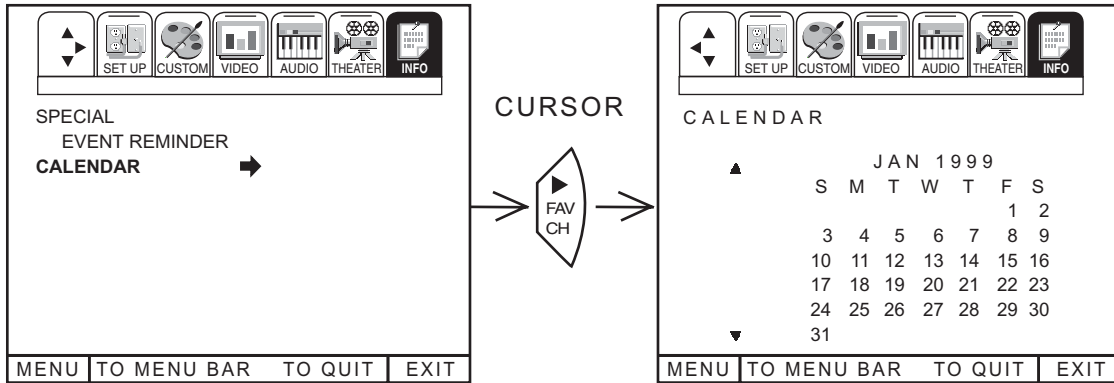

Press CURSOR ▲ or ▼ to change the month.

Press EXIT to quit menu or CURSOR ◀ to return to previous menu.

If the clock is not set, you can not use this function and the next screen will appear.

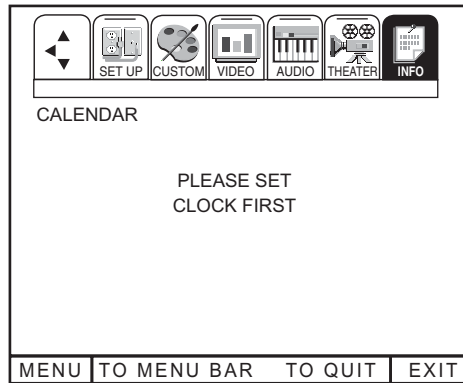

- NOTES:**
1. When the TV is turned on, the SPECIAL EVENT REMINDER message will automatically appear at the selected time.
 2. Each special event message can be a maximum of 20 characters.
 3. When RECALL button is pressed, a special icon appears on the right bottom side of the screen and indicates a SPECIAL EVENT REMINDER message. Press the RECALL button again to display the SPECIAL EVENT REMINDER message.

CARE OF YOUR HITACHI PROJECTION TV AND YOUR REMOTE CONTROL



DO

Dust the screen and cabinet with a soft cloth.

Clean the screen with a soft cloth moistened in warm water and dry with a soft cloth. A mild soap may be used if the screen is extremely dirty.

Place your television away from extreme heat, humidity, and extremely dusty places.

Remove the plug from the wall outlet if your television will not be used for a long period of time, for instances, when you go on vacation.

DO NOT

Do not clean your screen or cabinet with strong cleaners, polishes or a chemically treated cloth.

Do not place rubber or vinyl products or cellophane tape on your television.

Do not touch the screen too often.

Do not subject the remote control to shocks such as dropping it on the floor, etc. Physical damage to the precision parts may result.





Avoid placing the remote control in a high humidity place or getting it wet. Do not leave it on or near a heater. Excessive heat or moisture may cause the unit to cease operation.

When the batteries run down, remote control operation will become erratic or possibly stop altogether. Replace the old batteries with two new AA size batteries.

Exposure of the viewing screen to prolonged direct sunlight or heat may cause the screen to permanently warp, resulting in a distorted picture.



RECEPTION PROBLEMS

	<p>¥ IGNITION NOISE: Black spots or horizontal streaks may appear, picture may flutter or drift. Usually caused by interference from automobile ignition systems, neon lamps, electrical drills, and other electrical appliances.</p>
	<p>¥ GHOSTS: Ghosts are caused by the television signal following two paths. One is the direct path and the other is reflected from tall buildings, hills or some other objects. Changing the direction or position of the antenna may improve reception. Ghosting may also be caused by defects in the antenna system such as unshielded leads or connecting several sets to the same antenna without using multiple antenna couplers.</p>
	<p>¥ SNOW: If your receiver is located in the fringe area of a television station where the signal is weak, your picture may be marred by the appearance of small dots. When the signal is extremely weak, it may be necessary to install a special antenna to improve the picture.</p>
	<p>¥ RADIO FREQUENCY INTERFERENCE: The interference produces moving ripples or diagonal streaks, and in some cases, causes loss of contrast in the picture.</p>

NOTE: The TV set can generate sound distortion in external devices such as a radio. Please separate radio equipment from the TV set to a considerable distance.

USEFUL INFO



SYMPTOMS	CHECK THESE ITEMS AND TRY THESE ADJUSTMENTS											
	Be sure external connection is correct	Be sure power cord is plugged in	Be sure TV is switched "ON"	Try another channel (station trouble)	Check antenna connections (back of TV)	Check antenna for broken lead-in wire	Check for local interference	Adjust Contrast control	Adjust Brightness control	Adjust Color control	Adjust Tint control	Adjust Volume control
No Picture, no sound	●	●	●	●	●	●	●					
Sound OK, picture poor	●			●	●	●	●	●	●			
Picture OK, sound poor	●			●	●	●	●	●				●
Picture blurred	●			●	●	●	●	●				
Lines or streaks in picture				●	●	●	●	●				
Poor reception on some channels				●	●	●	●	●				
Picture rolls vertically				●				●				
No color	●			●	●	●	●			●		
Poor color	●			●	●	●	●			●	●	

HITACHI Projection Television incorporates advanced power surge protection technology designed to protect against component or circuit damage due to external or internal voltage power surges.

IF YOUR TELEVISION SHOULD APPEAR TO HAVE A LOSS OF POWER, PLEASE FOLLOW THIS PROCEDURE:

1. Press the power switch (ON/OFF switch) once.
2. If there is still no power, wait 30 seconds and press the power switch again.
3. If there is still no power, unplug the power cord from the wall. Wait 30 seconds and plug the power cord back in. Press the power switch again.

This protective technology should provide for years of lasting entertainment from your HITACHI Projection Television.



Features:

- ¥ Superfine Picture Quality
 - 1000 Line Horizontal Resolution
- ¥ Pure Green and Red Filter Lenses
- ¥ Artificial Intelligence System
- ¥ Remote (Controls many VCR brands, cable boxes, satellite boxes, and other audio equipment.)
- ¥ High Definition On-Screen Display (UltraTEC BIT-MAP)
- ¥ ON SCREEN PLUG and PLAY guide
- ¥ Full Set of Input Jacks, including S-Video
- ¥ COMPONENT: Y/C_B/C_R Input Jacks
- ¥ Closed Caption Decoder
- ¥ High Resolution Picture-In-Picture with Freeze
- ¥ Tuned Port Bass Reflex Speakers
- ¥ Magic Focus (Auto Digital Convergence)
- ¥ Dual Antenna Inputs
- ¥ Auto Link
- ¥ 3 Dimensional Y/C Comb Filter
- ¥ Dolby Pro Logic */Hall/Matrix 3 Stereo Surround Sound
 - * Dolby , the double-D symbol, and (where applicable) Pro Logic are trademarks of Dolby Laboratories Licensing Corporation. Manufactured under license from Dolby Laboratories Licensing Corporation. Additionally licensed under one or more of the following patents: U.S. number 3,959,590; Canada numbers 1,004,603 and 1,037,877. Dolby , Pro Logic , and the double-D symbol are trademarks of Dolby Laboratories Corporation.
- ¥ 3 Dimensional Y/C Comb Filter

Inputs:

- ¥ Power InputAC 120V, 60Hz
- ¥ Power Consumption (operating)
 - 53SBX59B161W
 - 61SBX59B161W
- ¥ Power Consumption (maximum)
 - 53SBX59B210W
 - 61SBX59B210W
- ¥ Antenna input impedance75 Ohm
- ¥ Channel coverage181ch.
 - VHF-Band2 ~ 13
 - UHF-Band14 ~ 69
 - CATV Mid BandA-5 ~ A-1
 -A-I
 - Super BandJ-W
 - Hyper BandW+1 - W+28
 - Ultra BandW+29 - W+84
- ¥ Video1.0Vp-p, 75 Ohm
- ¥ S-Video
 - Luminance (Y)1.0Vp-p, 75 Ohm
 - Chrominance (C)0.286Vp-p, 75 Ohm
- ¥ Component Video
 - Luminance (Y)1.0Vp-p, 75 Ohm
 - Chrominance (Cb,Cr)0.7Vp-p, 75 Ohm
- ¥ Audio input level47k Ohm
- ¥ Average input level470mVrms

Outputs:

- ¥ Video1.0Vp-p, 75 Ohm
- ¥ Audio470mVrms, 1k Ohm

Dimensions:

53SBX59B

- ¥ Height (in.) 55 3/4
- ¥ Width (in.) 46
- ¥ Depth (in.) 26 1/4
- ¥ Weight (lbs.) 200

61SBX59B

- ¥ Height (in.) 61 1/2
- ¥ Width (in.) 52 1/2
- ¥ Depth (in.) 29
- ¥ Weight (lbs.) 320

NOTE: Due to improvements, specifications in this operating guide are subject to change without notice.



HITACHI

*Service
hotline*

To locate an authorized
HITACHI service facility
in the continental U.S.A.
and Canada,

DIAL TOLL FREE

7 days a week, 24 hours a day

800 HITACHI

(1-800-448-2244)

Hitachi America, LTD. Home Electronics Division

Hitachi has made every effort to assure you hours of trouble free operation from your unit. However, should you require service, a network of Hitachi Authorized Service Facilities has been established in all 50 states and Puerto Rico. Each facility will provide you with convenient and expedient assistance. Our service hotline operator will direct you to the Hitachi Authorized Service Facility nearest you. Just present proof of purchase and/or delivery receipts to the Hitachi Authorized Service Facility, and service will be rendered in accordance with the terms of the limited warranty as stated on your warranty card or operating guide.

Should you have any questions regarding warranty, service, operation, or technical assistance, please contact:

**Hitachi America, LTD.
Home Electronics Division
1855 Dornoch Court
San Diego, CA 92154**

***In Canada, please contact: 1-800-HITACHI
(1-800-448-2244)***

**HITACHI (HSC) Canada Inc.
6740 Campobello Road
Mississauga, Ont. L5N 2L8**





HITACHI

Free Manuals Download Website

<http://myh66.com>

<http://usermanuals.us>

<http://www.somanuals.com>

<http://www.4manuals.cc>

<http://www.manual-lib.com>

<http://www.404manual.com>

<http://www.luxmanual.com>

<http://aubethermostatmanual.com>

Golf course search by state

<http://golfingnear.com>

Email search by domain

<http://emailbydomain.com>

Auto manuals search

<http://auto.somanuals.com>

TV manuals search

<http://tv.somanuals.com>