

# HITACHI

## Inspire the Next

**CH1** Added notes about Optical Audio Output only available when viewing a Digital Channel via the Digital Tuner.  
Page 10, Page 11, Page 13, and Page 39

## PROJECTION COLOR TELEVISION

### Operating Guide for 51F59, 51F59A 51F59J, 57F59, 57F59A, 57F59J 65F59, 65F59A, 65F59J.

IMPORTANT SAFETY INSTRUCTIONS.....	2-3
FIRST TIME USE .....	4-17
THE REMOTE CONTROL.....	18-31
ON-SCREEN DISPLAY .....	32-60
USEFUL INFORMATION.....	61-71
END USER LICENSE AGREEMENT FOR HITACHI DTV SOFTWARE.....	71
INDEX.....	72



*As an Energy Star® Partner,  
Hitachi, Ltd. has determined  
that this product meets the  
Energy Star® guidelines for  
energy efficiency.*

# Important Safety Instructions



## SAFETY POINTS YOU SHOULD KNOW ABOUT YOUR HITACHI TELEVISION

Our reputation has been built on the quality, performance, and ease of service of **HITACHI** televisions.

Safety is also foremost in our minds in the design of these units. To help you operate these products properly, this section illustrates safety tips which will be of benefit to you. Please read it carefully and apply the knowledge you obtain from it to the proper operation of your **HITACHI** television.

Please fill out your warranty card and mail it to **HITACHI**. This will enable **HITACHI** to notify you promptly in the improbable event that a safety problem should be discovered in your product model.

**Follow all warnings and instructions marked on this television.**



 The lightning flash with arrowhead symbol, within an equilateral triangle, is intended to alert the user to the presence of uninsulated "dangerous voltage" within the product's enclosure that may be of a sufficient magnitude to constitute a risk of electric shock to a person.

 The exclamation point within an equilateral triangle, is intended to alert the user to the presence of important operating and maintenance (servicing) instructions in the literature accompanying the appliance.

## READ BEFORE OPERATING EQUIPMENT

Follow all warnings and instructions marked on this television.

1. Read these instructions.
2. Keep these instructions.
3. Heed all warnings.
4. Follow all instructions.
5. Do not use this apparatus near water.
6. Clean only with a dry cloth.
7. Do not block any ventilation openings. Install in accordance with the manufacturer's instructions.
8. Do not install near any heat sources such as radiators, heat registers, stoves, or other apparatus (including amplifiers) that produce heat.
9. Do not defeat the safety purpose of the polarized or grounding-type plug. A polarized plug has two blades with one wider than the other. A grounding type plug has two blades and a third grounding

prong. The wide blade or the third prong are provided for your safety. If the provided plug does not fit into your outlet, consult an electrician for replacement of the obsolete outlet.

10. Protect the power cord from being walked on or pinched particularly at plugs, convenience receptacles, and the point where they exit from the apparatus.
11. Only use the attachments/accessories specified by the manufacturer.
12.  Use only with the cart, stand, tripod, bracket, or table specified by the manufacturer, or sold with the apparatus. When a cart is used, use caution when moving the cart/apparatus combination to avoid injury from tip-over.
13. Unplug this apparatus during lightning storms or when unused for long periods of time.
14. Refer all servicing to qualified service personnel. Servicing is required when the apparatus has been damaged in any way, such as power-supply cord or plug is damaged, liquid has been spilled or objects have fallen into apparatus, the apparatus has been exposed to rain or moisture, does not operate normally, or has been dropped.
15. Televisions are designed to comply with the recommended safety standards for tilt and stability. Do not apply excessive pulling force to the front, or top, of the cabinet which could cause the product to overturn resulting in product damage and/or personal injury.
16. Follow instructions for wall, shelf or ceiling mounting as recommended by the manufacturer.
17. An outdoor antenna should not be located in the vicinity of overhead power lines or other electrical circuits.
18. If an outside antenna is connected to the receiver be sure the antenna system is grounded so as to provide some protection against voltage surges and built up static charges. Section 810 of the National Electric Code, ANSI/NFPA No. 70-1984, provides information with respect to proper grounding for the mast and supporting structure, grounding of the lead-in wire to an antenna discharge unit, size of grounding connectors, location of antenna-discharge unit, connection to grounding electrodes and requirements for the grounding electrode.

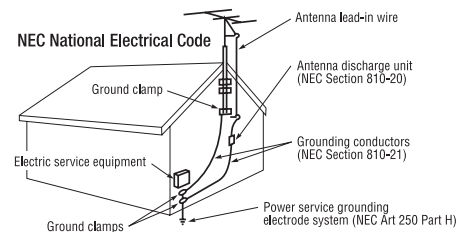

Note to the CATV system installer: This reminder is provided to call the CATV system installer's attention to Article 820-44 of the NEC that provides guidelines for proper grounding and, in particular, specifies that the cable ground shall be connected to the grounding system of the building, as close to the point of cable entry as practical.

# Important Safety Instructions



## Power source

This television is designed to operate on 120 volts 60 Hz, ac current. Insert the power cord into a 120 volt 60 Hz outlet. The power cord is used as the disconnect device and shall remain readily operable.

To prevent electric shock, do not use the television's (polarized) plug with an extension cord, receptacle, or other outlet unless the blades and ground terminal can be fully inserted to prevent blade exposure.

Never connect the television to 50 Hz, direct current, or anything other than the specified voltage.

## Caution



Never remove the back cover of the television as this can expose you to very high voltages and other hazards. If the television does not operate properly, unplug the television and call your authorized dealer or service center.

## Caution

Adjust only those controls that are covered in the instructions, as improper changes or modifications not expressly approved by **HITACHI** could void the user's warranty.

## Warning

- To reduce the risk of fire or electric shock, do not expose this apparatus to rain or moisture.
- The television should not be exposed to dripping or splashing and objects filled with liquids, such as vases, should not be placed on the television.

## Warning

- Do not place any objects on the top of the television which may fall or cause a child to climb to retrieve the objects.
- Projection TV's are heavy and can mark or damage floor surfaces (especially wood flooring) if moved improperly. Do not slide or force TV into position. Always roll TV allowing casters at bottom of unit to help steer and position the TV.

## FCC Information

This device complies with part 15 of the FCC Rules. Operation is subject to the following two conditions (1) This device may not cause harmful interference, and (2) This device must accept any interference received, including interference that may cause undesired operation.

## Modifications

The FCC requires the user to be notified that any changes or modifications made to this device that are not expressly approved by Hitachi America, Ltd. Home Electronics Division may void the user's authority to operate the equipment.

## Note

This television receiver will display television closed captioning, (CC or □), in accordance with paragraph 15.119 and 15.122 of the FCC rules.

## Public viewing of copyrighted material

Public viewing of programs broadcast by TV stations and cable companies, as well as programs from other sources, may require prior authorization from the broadcaster or owner of the video program material.

This product incorporates copyright protection technology that is protected by U.S. patents and other intellectual property rights. Use of this copyright protection technology must be authorized by Macrovision Corporation, and is intended for home and other limited consumer uses only unless otherwise authorized by Macrovision. Reverse engineering or disassembly is prohibited.

## Note

This digital television is capable of receiving analog basic, digital basic cable television programming by direct connection to a cable system providing such programming. Certain advanced and interactive digital cable services such as video-on-demand, a cable operator's enhanced program guide and data-enhanced television services may require the use of a set-top box. For more information call your local cable company.

## Note

- There are no user serviceable parts inside the television.
- Model and serial numbers are indicated on back side of the television.

## Prevention of screen burn

This Wide Screen TV is designed to display wide screen pictures. Images should be viewed mostly in wide screen format or zoomed to fit the screen with moving pictures. Use of side panels, top and bottom panels of standard picture formats should only be 15% of your total viewing time to prevent uneven aging of the phosphors. Phosphors in the lighted area of the picture will age more rapidly than the gray areas. Continuous on-screen displays such as video games, stock market quotations, computer generated graphics, and other fixed (non-moving) patterns can cause permanent damage to television receivers. Such "SCREEN BURNS" constitute misuse and are **NOT COVERED** by your **HITACHI** Factory Warranty.

## Lead Notice

This product contains lead. Dispose of this product in accordance with applicable environmental laws. For product recycling and disposal information, contact your local government agency or the Electronic Industries Alliance at [www.eiae.org](http://www.eiae.org) (in the US) or the Electronic Product Stewardship Canada at [www.epsc.ca](http://www.epsc.ca) (in Canada).

**FOR MORE INFORMATION, CALL 1-800-HITACHI.**

# Accessories

Check to make sure you have the following accessories before disposing of the packing material.

- ❶ Remote Control

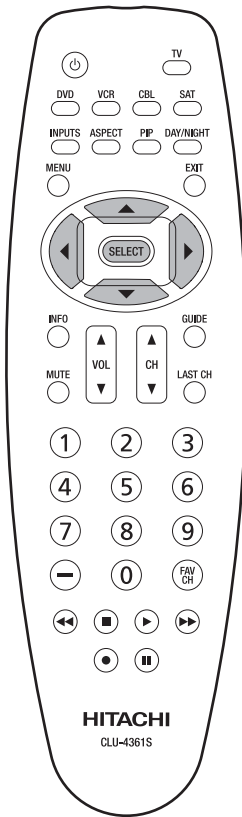

- ❷ Two "AA" size, 1.5V batteries

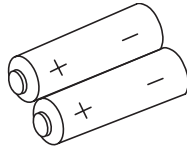

- ❸ "Z" Allen Key (65" Models Only)

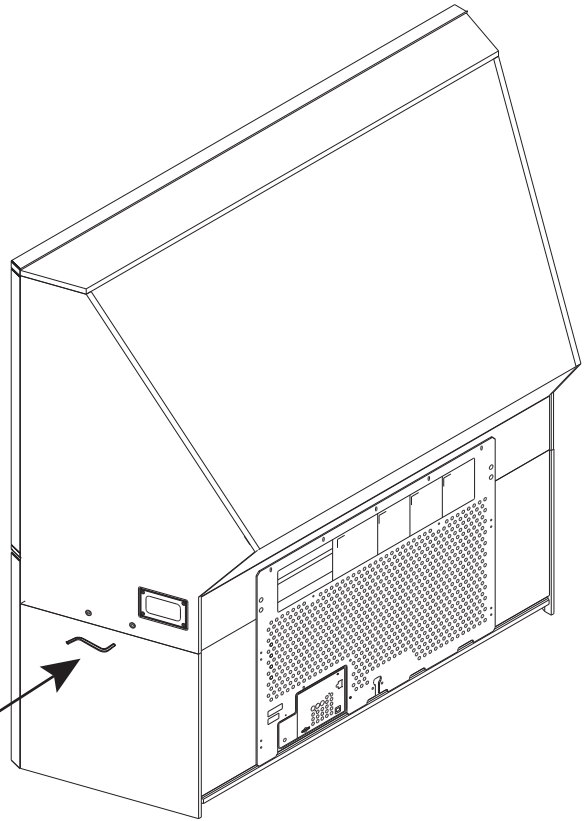

- ❶ Remote Control Unit CLU-4361S (Part No. HL02291).
- ❷ Two "AA" size, 1.5V batteries (For Remote Control Unit).
- ❸ "Z" Allen Key (Part No. 61010122). Provided only when Allen Screws are used.

## REMOTE CONTROL BATTERY INSTALLATION AND REPLACEMENT

1. Open the battery compartment cover of the remote control by pulling back the TAB and lifting up to remove the cover.
2. Insert two new "AA" size batteries into the remote control. When replacing old batteries, push them back towards the springs and lift out.
3. Match the batteries to the (+) and (-) marks in the battery compartment.
4. Insert the (-) side, into the battery compartment, the slide the battery inwards and insert the second battery. Do not force the battery into the battery compartment.
5. Replace the battery compartment cover.

Bottom View (Remote Control)

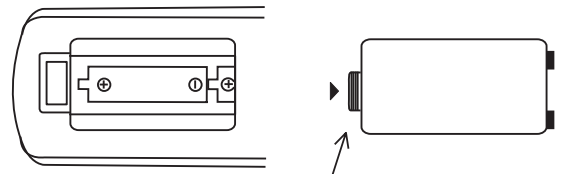

Pull up tab to remove back cover.



**CAUTION:** Do not insert batteries with '+' and '-' polarities reversed as this may cause the batteries to swell or rupture resulting in leakage.

# How to set up your new HITACHI Projection Television

## ANTENNA

Unless your TV is connected to a cable TV system or to a centralized antenna system, a good outdoor TV antenna is recommended for best performance. However, if you are located in an exceptionally good signal area that is free from interference and multiple image ghosts, an indoor antenna may be sufficient.

## LOCATION

Select an area where sunlight or bright indoor illumination will not fall directly on the picture screen. Also, be sure that the location selected allows a free flow of air to and from the perforated back cover of the set. To avoid cabinet warping, cabinet color changes, and increased chance of set failure, do not place the TV where temperatures can become excessively hot, for example, in direct sunlight or near a heating appliance, etc.

## VIEWING

The major benefit of the **HITACHI** Projection Television is its large viewing screen. To see this large screen at its best, test various locations in the room to find the optimum spot for viewing.

The best picture is seen by sitting directly in front of the TV and about 10 to 18 feet from the screen. Picture brightness decreases as the viewer moves to the left and right of the receiver.

During daylight hours, reflections from outside light may appear on the screen. If so, drapes or screens can be used to reduce the reflection or the TV can be located in a different section of the room.

If the TV's audio output will be connected to a Hi-Fi system's external speakers, the best audio performance will be obtained by placing the speakers equidistant from each side of the receiver cabinet and as close as possible to the height of the picture screen center. For best stereo separation, place the external speakers at least four feet from the side of the TV, place the surround speakers to the side or behind the viewing area. Differences in room sizes and acoustical environments will require some experimentation with speaker placement for best performance.

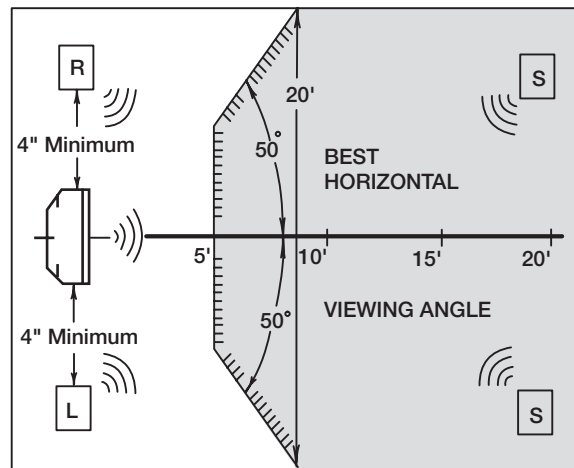
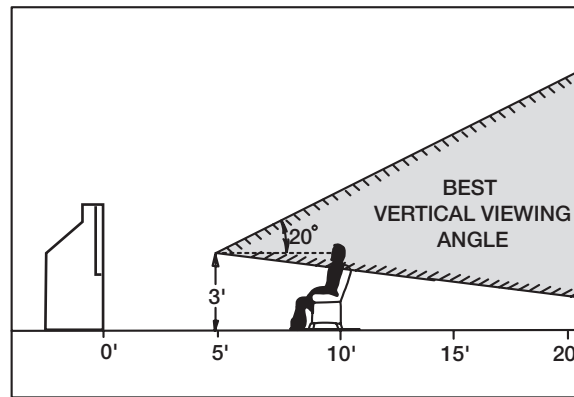

**CAUTION:** Magnetic fields, such as those of external speakers, may cause the picture to distort if they are placed too close to the television. Move the magnetic field source away from the television until there is no picture distortion.

# Hook-up Cables and Connectors

First time use

Most video/audio connections between components can be made with shielded video and audio cables that have phono connectors. For best performance, video cables should use 75-Ohm coaxial shielded wire. Cables can be purchased from most stores that sell audio/video products. Below are illustrations and names of common connectors. Before purchasing any cables, be sure of the output and input connector types required by the various components and the length of each cable.

### 300-Ohm Twin Lead Cable

This outdoor antenna cable must be connected to an antenna adapter (300-Ohm to 75-Ohm).

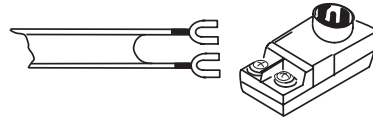

### Phono Cable

Used on all standard video and audio cables which connect to inputs and outputs located on the television's rear jack panel and front control panel.

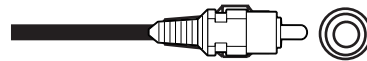

### "F" Type 75-Ohm Coaxial Antenna Cable

For connecting RF signals (antenna or cable TV) to the antenna jack on the television.



### S-Video (Super Video) Cable

This connector is used on camcorders, VCRs and laser-disc players with an S-Video feature in place of the standard video cable to produce a high quality picture.

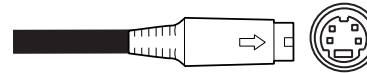

### Optical Cable

This cable is used to connect to an audio amplifier with an Optical Audio In jack. Use this cable for the best sound quality.

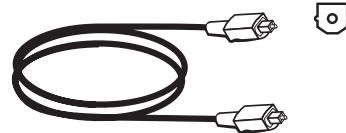

### HDMI Cable

This cable is used to connect your external devices such as Set-Top-Boxes or DVD players equipped with an HDMI output connection to the TV's HDMI input.

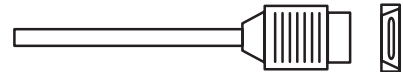

## ANTENNA CONNECTIONS TO REAR JACK PANEL

### (75-Ohm) antenna/CATV (Cable TV)

When using a 75-Ohm coaxial cable system, connect **Antenna** or **CATV** coaxial cable to the **AIR/CABLE** (75-Ohm) terminal .

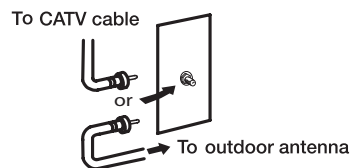

### VHF (300-Ohm) antenna/UHF antenna

When using a 300-Ohm twin lead from an outdoor antenna, connect the **VHF** or **UHF** antenna leads to screws of the **VHF** or **UHF** adapter. Plug the adapter into the **AIR/CABLE** terminal on the TV.

To outdoor VHF or UHF antenna



### When both VHF and UHF antennas are connected

Attach an optional antenna cable mixer to the TV **AIR/CABLE** terminal, and connect the cables to the antenna mixer. Consult your dealer or service store for the antenna mixer.

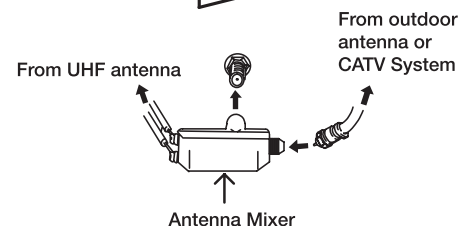

# Quick Reference Remote Control Buttons and Functions

In addition to controlling all of the functions on your HITACHI Projection TV, the new remote control is designed to operate different types of devices, such as, DVD Players, CBL (Cable Boxes), set-top-boxes, satellite receivers, and VCRs. The remote control must be programmed to control the chosen device. Please see page 18-31 for a complete description of all features and programming of the Remote Control.

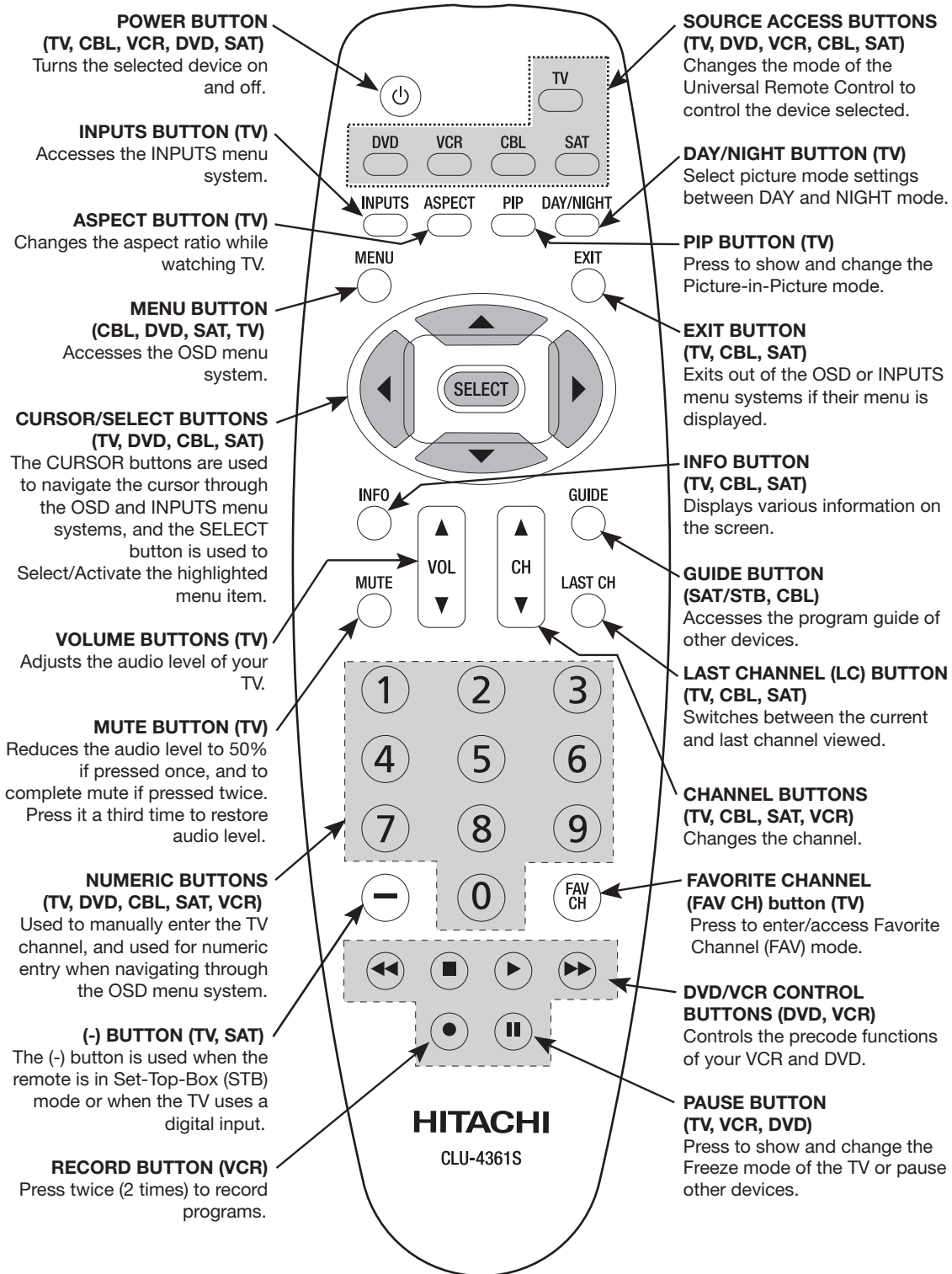

## LEGEND

**TV** - Television  
**CBL** - Cable Box  
**STB** - Set-Top-Box  
**VCR** - Video Cassette Recorder/Player  
**DVD** - Digital Video Disc Player  
**SAT** - Satellite Receiver

**NOTE:** STB precode is included in the SAT mode.

# Front Panel Controls

First time use

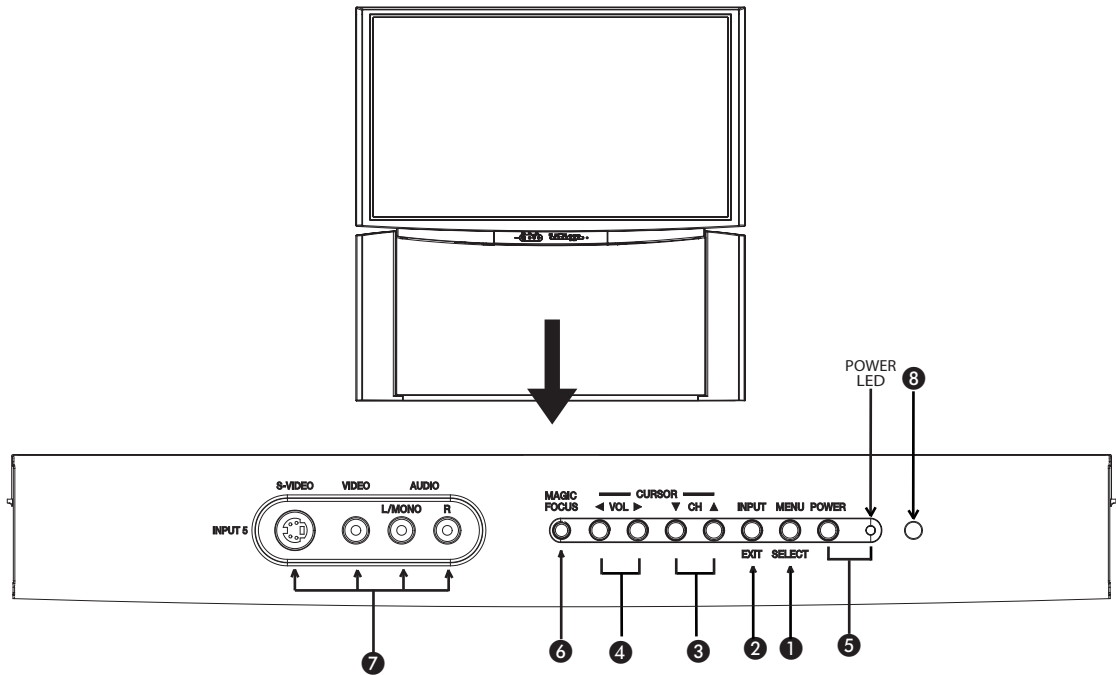

**1 MENU/SELECT button**

This button allows you to enter the **MENU**, making it possible to set TV features to your preference without using the remote. This button also serves as the **SELECT** button when in **MENU** mode.

**2 INPUT/EXIT button**

Press this button to display the input menu, **CABLE**, **AIR**, **INPUT: 1, 2, 3, 4 and 5**. This button also serves as the **EXIT** button when in **MENU** mode.

**3 CHANNEL selector**

Press these buttons until the desired channel appears in the top right corner of the TV screen. These buttons also serve as the cursor down (▼) and up (▲) buttons when in **MENU** mode.

**4 VOLUME level**

Press these buttons for your desired sound level. The volume level will be displayed on the TV screen. These buttons also serve as the cursor left (◀) and right (▶) buttons when in **MENU** mode. When the TV power is turned OFF at a volume level 31 or greater, the volume level will default to 30 when the TV is turned ON. However, if it is set to a level 30 or less, the volume level will be at the level it was set when the TV is turned ON.

**5 POWER button/ POWER LED**

Press this button to turn the TV on or off. This LED light is on during normal operation. At initial TV turn on, the TV cannot receive any button or Remote Control signals for approximately five seconds while the internal programming is loading. This is a normal default operation of this television and is an energy saving feature.

**6 MAGIC FOCUS button**

Use this button to automatically adjust your picture quality to optimum performance (see page 53).

**7 FRONT INPUT JACKS (INPUT 5)**

Use these audio/video jacks for a quick hook-up from a camcorder or VCR to instantly view your favorite show or new recording. Press the **INPUT** button and select **INPUT 5**. If you have mono sound, insert the audio cable into the left audio jack.

**8 IR RECEIVER Sensor**

Point the remote control at this area when selecting channels, adjusting volume, etc.



# Front Panel Jacks and Connections

The front panel jacks are provided as a convenience to allow you to easily connect a camcorder or VCR as shown in the following examples:

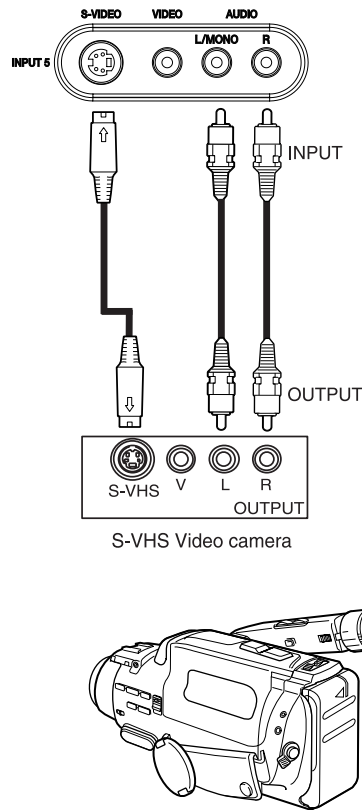
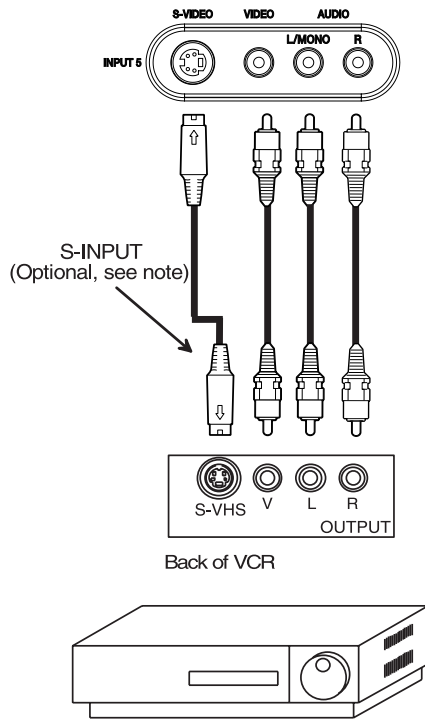

- NOTE:** 1. Completely insert connection cord plugs when connecting to front panel jacks. If you do not, the played back picture may be abnormal.  
2. If you have a S-VHS VCR, use the S-INPUT cable in place of the standard video cable.  
3. If you have a mono VCR, insert the audio cable into the left audio jack of your TV.

# Rear Panel Connections

First time use

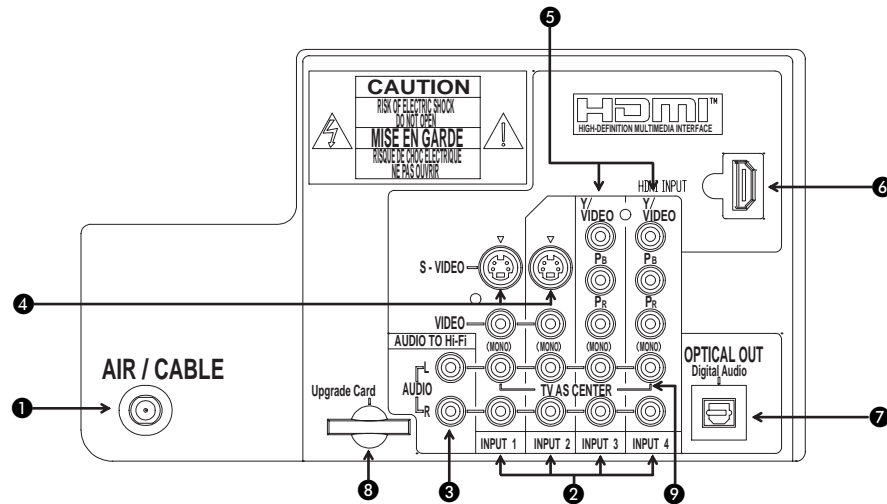

- 1 AIR /CABLE Input**  
A 75-Ohm RF Antenna or **CATV** (Cable TV) input.

**NOTE:** You may ask your local cable company whether DTV services are available.

- 2 Audio/Video INPUTS 1, 2, 3 and 4**  
By using the **INPUTS** button, **CURSOR** buttons and **SELECT** button of the remote control you can select each video source. Use the audio and video inputs to connect external devices, such as VCRs, camcorders, laserdisc players, DVD players etc. (If you have mono sound, insert the audio cable into the left audio jack.)

**NOTE:** You may use **VIDEO** or **S-VIDEO** inputs to connect to **INPUT 1** and **2**, but only one of these inputs may be used at a time.

- 3 Audio Out**  
These jacks provide fixed or variable audio signals which are used for recording.

- 4 S-Video INPUTS 1 and 2**  
**INPUTS 1** and **2** provide S-Video (Super Video) jacks for connecting equipment with S-Video output capability.

- 5 Component: Y-PbPr INPUTS**  
**INPUTS 3** and **4** provide Y-PbPr jacks for connecting equipment with this capability, such as a DVD player or Set Top Box. You may use composite video signal for both inputs.

CH1

**NOTE 1:** Optical Audio Out "Only" available using Digital Tuner on Digital Channels. No other input's Audio is output via Optical Audio Out. This includes HDMI audio. It is not output.

BACK TO COVER

- NOTE:**
1. Do not connect composite **VIDEO** and **S-VIDEO** to **INPUT 1, 2** or **5** at the same time. **S-VIDEO** has priority over **VIDEO** input.
  2. Your component outputs may be labeled **Y, B-Y, and R-Y**. In this case, connect the components **B-Y** output to the TV's **P<sub>B</sub>** input and the components **R-Y** output to the TV's **P<sub>R</sub>** input.
  3. Your component outputs may be labeled **Y-CbCr**. In this case, connect the component **C<sub>B</sub>** output to the TV's **P<sub>B</sub>** input and the component **C<sub>R</sub>** output to the TV's **P<sub>R</sub>** input.
  4. It may be necessary to adjust **TINT** to obtain optimum picture quality when using the **Y-PbPr** inputs (see page 34).
  5. To ensure no copyright infringement, the **MONITOR OUT** output will be abnormal, when using the **Y-PbPr** jacks.
  6. **INPUT 3** and **INPUT 4** (**Y/VIDEO**) can be used for composite video and component video input.

**6 HDMI1 (High Definition Multimedia Interface) (INPUT 1)**

**ABOUT HDMI – HDMI** is the  next-generation all digital interface for consumer electronics. **HDMI** enables the secure distribution of high-definition video and multi-channel audio in a single cable. Because digital television (DTV) signals remain in digital format, **HDMI** assures that pristine high-definition images retain the highest video quality from the source all the way to your television screen.

Use the **HDMI** input for your external devices such as Set-Top-Boxes or DVD players equipped with an **HDMI** output connection.

**HDMI**, the **HDMI** logo and High-Definition Multimedia Interface are trademarks or registered trademarks of **HDMI** Licensing LLC.

- NOTE:**
1. The **HDMI** input is not intended for use with personal computers.
  2. Only DTV formats such as **1080i, 720p, 480i** and **480p** are available for **HDMI** input.

# Rear Panel Connections

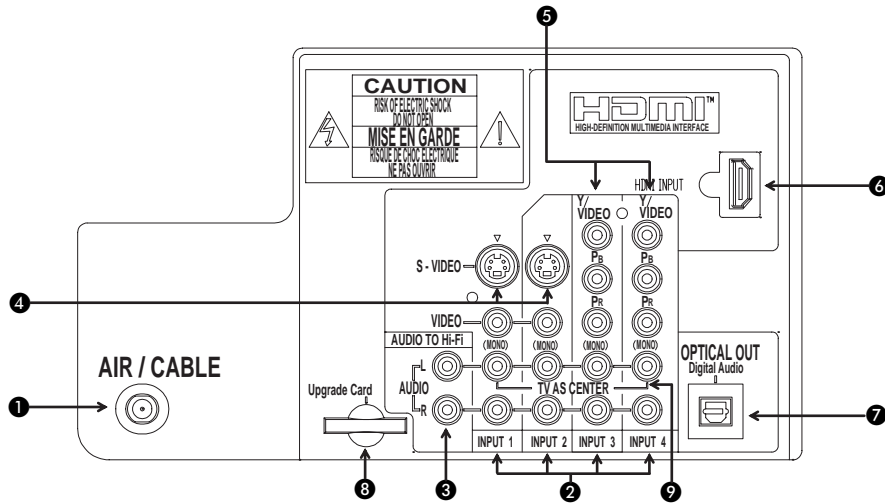

First time use

## 7 Optical Out (Digital Audio)

This jack provides Digital Audio Output for your audio device that is Dolby® Digital compatible, such as an audio amplifier.

Manufactured under license from Dolby Laboratories. "DOLBY" and the **DOUBLE-D** symbol are trademarks of Dolby Laboratories.

**NOTE :** This OUTPUT is for DIGITAL channels only.

CH1

**NOTE 1:** Optical Audio Out "Only" available using Digital Tuner on Digital Channels.  
 No other input's Audio is output via Optical Audio Out. This includes HDMI audio. It is not output.

## 8 Upgrade Card

This card slot is for future software upgrades. Hitachi will notify you if a software upgrade is required for your TV. In order to receive written notification, please complete and return your warranty card.

## 9 TV AS CENTER (INPUTS 1-4)

These jacks are for stereo amplifiers with center signal output capability. This feature allows the TV speakers to be used as a center speaker. The TV must be set as a center channel by selecting **TV AS CENTER** on the Internal Speakers Settings of the Audio Menu (see page 38).

BACK TO COVER

# Rear Panel Connections

## TIPS ON REAR PANEL CONNECTIONS

- **S-VIDEO, Y-PbPr** and **HDMI** connections are provided for high performance laserdisc players, VCRs etc. that have this feature. Use these connections in place of the standard video connection if your device has this feature.

- If your device has only one audio output (mono sound), connect it to the left audio jack on the television.
- Refer to the operating guide of your other electronic equipment for additional information on connecting your hook-up cables.

- An **AUDIO** system can be used by connecting the **AUDIO TO HI-FI** output of the TV. This can be used when you like to control the volume output by changing the volume of the TV.

See Note 1 about Optical Audio Output jack.

- You may use **VIDEO** or **S-VIDEO** inputs to connect to **INPUT 1**, **INPUT 2** or **INPUT 5**, but only one of these may be used at a time.
- Connect only one component (VCR, DVD player, camcorder, etc.) to each input jack.
- **COMPONENT: Y-PbPr (INPUT 3 and INPUT 4)** connections are provided for high performance components, such as DVD players and set-top-boxes. Use these connections in place of the standard video connection if your device has this feature. **INPUT 3** and **INPUT 4** accepts both composite and component video signals.
- Your component outputs may be labeled **Y, B-Y**, and **R-Y**. In this case, connect the components **B-Y** output to the TV's **Pb** input and the components **R-Y** output to the TV's **Pr** input.
- Your component outputs may be labeled **Y-CbCr**. In this case, connect the components **Cb** output to the TV's **Pb** input and the components **Cr** output to the TV's **Pr** input.
- You may use composite and component video signals for **INPUT 3** and **INPUT 4**.
- It may be necessary to adjust **TINT** to obtain optimum picture quality when using the **Y-PbPr** inputs (see page 34).

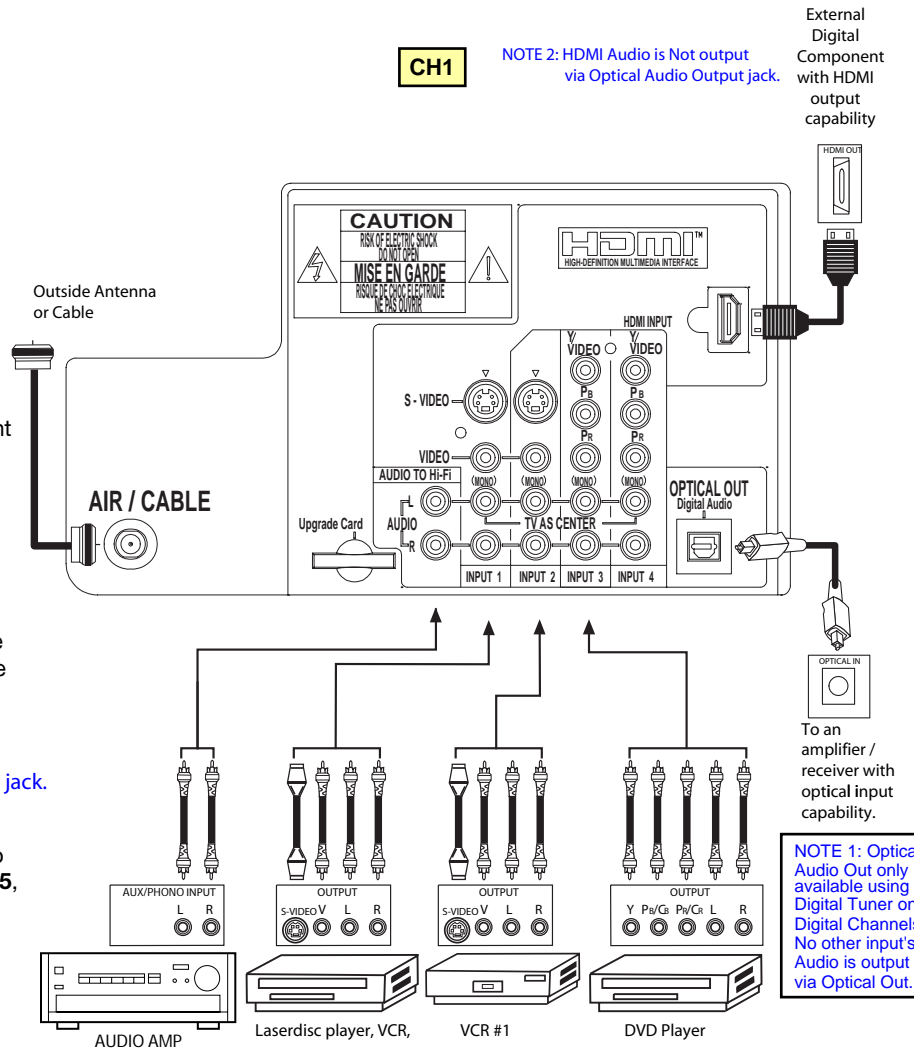

External Digital Component with HDMI output capability

To an amplifier / receiver with optical input capability.

**NOTE 1:** Optical Audio Out only available using Digital Tuner on Digital Channels. No other input's Audio is output via Optical Out.

- When using an **HDMI** input from a Set-Top-Box, it is recommended that a **1080i** or **720p** input signal is used.

**NOTE 2:** HDMI Audio is Not output via Optical Audio Output jack.

- NOTE:**
1. Connect only one component to each input jack.
  2. Follow connections that pertain to your personal entertainment system.
  3. **INPUT 3** and **INPUT 4** can accommodate Composite and Component video signals.
  4. Cables are not included with the purchase of this TV, except when noted as "provided".

### MACROVISION NOTES:

1. Video signals fed through a VCR may be affected by copyright protection systems and the picture will be distorted on the television.
2. Connecting the television directly to the Audio /Video output of a Set-Top-Box will assure a more normal picture.

# Connecting External Audio Sources

Match the numbers below to the diagram for speaker placement.

- ❶ The television's internal speakers will act as center speaker (select **AUDIO - INTERNAL SPEAKERS - TV AS CENTER**).
- ❷ These FRONT left and right speakers are connected to the FRONT output of a separate audio amplifier.
- ❸ These REAR left and right speakers are connected to the Rear output of a separate audio amplifier.
- ❹ This subwoofer is connected to the LFE/SUB Out output of a separate audio amplifier.

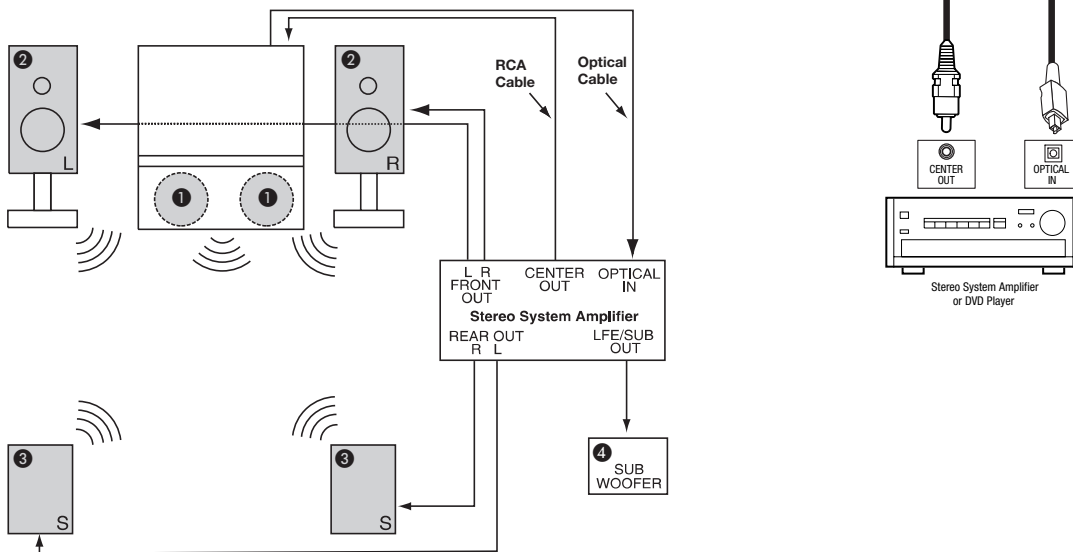
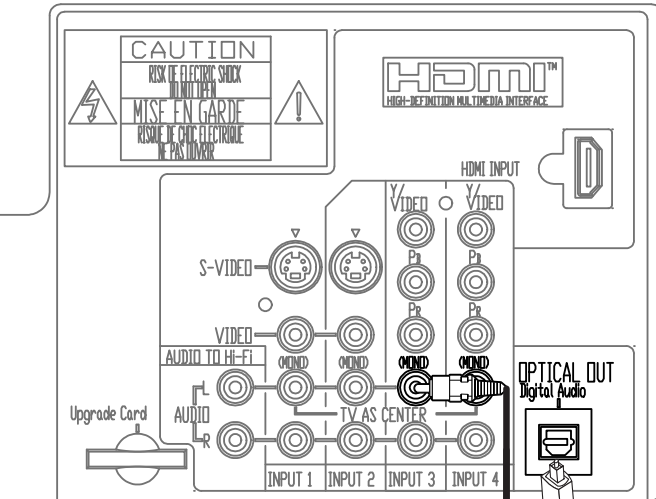

**NOTE:** 1. The Optical Out (Digital Audio) provides a fixed digital audio output to your external component such as an A/V receiver with optical input capability. The audio level can only be controlled through the volume control of the external audio amplifier.  
 2. See page 39 for AUDIO-Digital Output.

**CH1**

**NOTE 1:** Optical Audio Out "Only" available using Digital Tuner on Digital Channels. No other input's Audio is output via Optical Audio Out. This includes HDMI audio. It is not output.

First time use

**BACK TO COVER**

# Connecting External Video Sources

The exact arrangement you use to connect the VCR, camcorder, laserdisc player, DVD player, or HDTV Set Top Box to your TV set is dependent on the model and features of each component. Check the owner's manual of each component for the location of video and audio inputs and outputs.

The following connection diagrams are offered as suggestions. However, you may need to modify them to accommodate your particular assortment of components and features. For best performance, video and audio cables should be made from coaxial shielded wire.

## BEFORE OPERATING EXTERNAL VIDEO SOURCE

Connect an external source to the INPUT terminal, then press the **INPUTS** button to show the **INPUTS** menu. Use the **CURSOR PAD** to select the **CABLE, AIR** or **INPUT** of your choice. Then press the **SELECT** button to confirm your choice (see page 21).

**NOTE:** When the TV is set to **VIDEO** and a video signal is not received from the **VIDEO INPUT JACK** on the back panel of the TV (i.e., VCR/laserdisc player, etc. is not connected or the video device is OFF), the set will appear to be OFF.

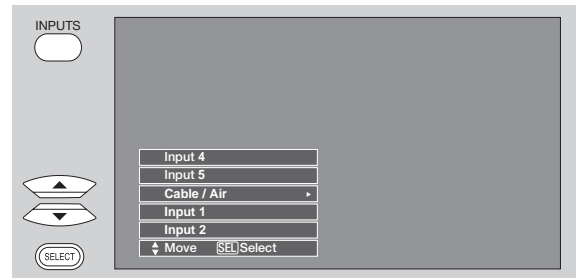

## CONNECTING A COMPOSITE VIDEO AND A MONAURAL AUDIO SOURCE TO INPUT1 - INPUT5

1. Connect the cable from the VIDEO OUT of the VCR or the laserdisc player to the INPUT (VIDEO) jack, as shown on the TV to the right.
2. Connect the cable from the AUDIO OUT of the VCR or the laserdisc player to the INPUT (MONO)/L(AUDIO) jack.
3. Press the **INPUTS** button, then select **INPUT 4** from the **INPUTS** menu to view the program from the VCR or the laserdisc player. The VIDEO OSD label disappears automatically after approximately four seconds.
4. Select **CABLE/AIR** from the **INPUTS** menu to return to the last channel tuned.

**NOTE:** 1) **INPUT 3** can be used in the same manner as **INPUT 4**.

2) **AIR** signal will change to **CABLE** signal when the Antenna Source is select as Cable(1) or Cable(2) in the Channel Manager menu. See page (42)

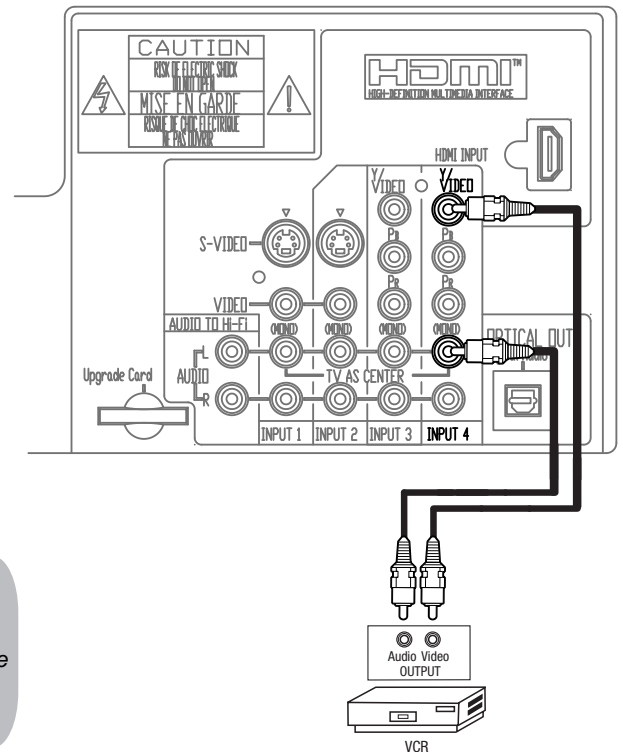

# Connecting External Video Sources

## CONNECTING A COMPOSITE VIDEO AND A STEREO AUDIO SOURCE TO INPUT 1 - INPUTS

1. Connect the cable from the VIDEO OUT of the VCR or the laserdisc player to the INPUT (VIDEO) jack, as shown on the TV to the right.
2. Connect the cable from the AUDIO OUT R of the VCR or the laserdisc player to the INPUT (AUDIO/R) jack.
3. Connect the cable from the AUDIO OUT L of the VCR or the laserdisc player to the INPUT (AUDIO/L) jack.
4. Press the **INPUTS** button, then select **INPUT 2** from the **INPUTS** menu to view the program from the VCR or laserdisc player. The VIDEO OSD label disappears automatically after approximately four seconds.
5. Select **CABLE/AIR** from the **INPUTS** menu to return to the last channel tuned.

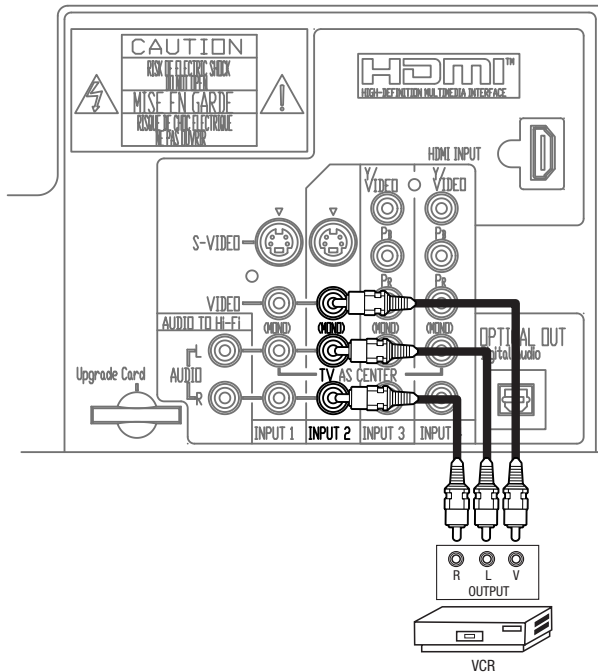

First time use

### NOTE:

1. Completely insert the connection cord plugs when connecting to rear panel jacks. The picture and sound that is played back will be abnormal if the connection is loose.
2. When **INPUT 3** or **4** are used, it is necessary to connect the video output from the device to the **Y-VIDEO INPUT** jack of the TV.

## CONNECTING AN S-VIDEO SOURCE TO INPUT 1, 2 AND 5

1. Connect the cable from the S-VIDEO OUT of the VCR or the laserdisc player to the INPUT (S-VIDEO) jack, as shown on the TV to the right.
2. Connect the cable from the AUDIO OUT R of the VCR or the laserdisc player to the INPUT (AUDIO/R) jack.
3. Connect the cable from the AUDIO OUT L of the VCR or the laserdisc player to the INPUT (AUDIO/L) jack.
4. Press the **INPUTS** button, then select **INPUT 2** from the **INPUTS** menu to view the program from the VCR or laserdisc player. The VIDEO OSD label disappears automatically after approximately four seconds.
5. Select **CABLE/AIR** from the **INPUTS** menu to return to the last channel tuned.

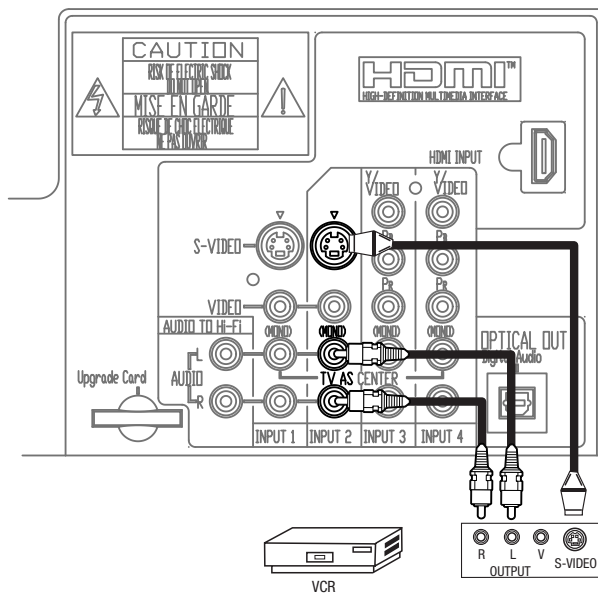

- NOTE:** 1. Completely insert the connection cord plugs when connecting to rear panel jacks. The picture and sound that is played back will be abnormal if the connection is loose.

# Connecting External Video Sources

First time use

## CONNECTING A COMPONENT SOURCE WITH HDMI OR DVI CAPABILITY TO INPUT 1

1. Connect the HDMI or DVI to HDMI connection cable from the output of the HDTV set top box or DVD player to the HDMI input as shown on the TV to the right. When using a component with DVI output, you also have to connect the AUDIO OUT (R/L) of the component to the AUDIO IN (R/L) of INPUT 1.
2. Press the **INPUTS** button, then select **INPUT 1** from the **INPUTS** menu to view the program from the HDTV set top box or DVD player. The VIDEO OSD label disappears automatically after approximately four seconds.
3. Select **CABLE/AIR** from the **INPUTS** menu to return to the last channel tuned.

- NOTE:**
1. Completely insert the connection cord plugs when connecting to rear panel jacks. The picture and sound that is played back will be abnormal if the connection is loose.
  2. The HDMI input on INPUT 1 contains the copy protection system called High-bandwidth Digital Content Protection (HDCP). HDCP is a cryptographic system that encrypts video signals when using HDMI connections to prevent illegal copying of video contents.
  3. HDMI is not a "NETWORK" technology. It establishes a one-way point-to-point connection for delivery of uncompressed video to a display.
  4. The connected digital output device controls the HDMI interface so proper set-up of device user settings determines final video appearance.

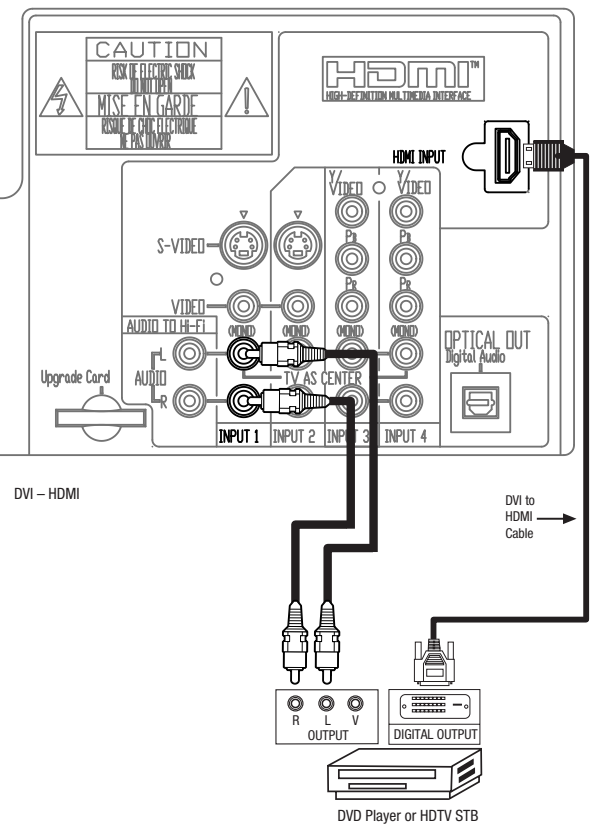
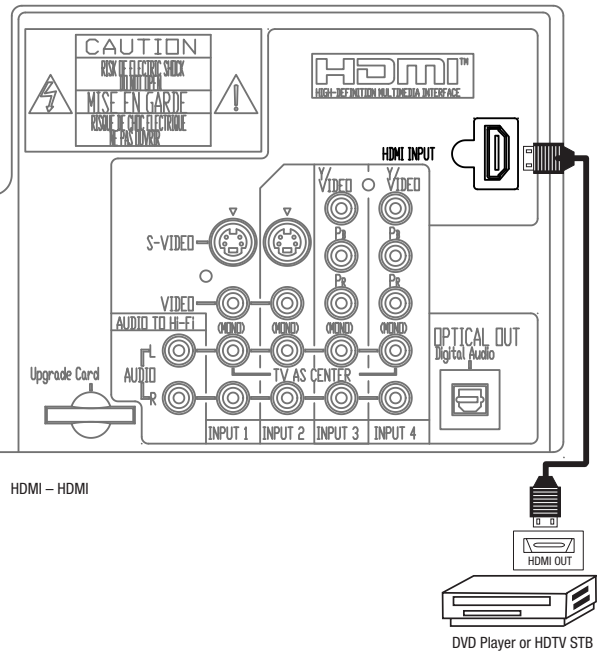



# Connecting External Video Sources

## CONNECTING A COMPONENT AND AN AUDIO SOURCE TO INPUT 3 OR 4: Y-PbPr.

1. Connect the cable from the Y OUT of the Laserdisc/DVD player or HDTV set top box to the INPUT (Y) jack, as shown on the TV to the right.
2. Connect the cable from the C<sub>B</sub>/P<sub>B</sub> OUT or B-Y OUT of the Laserdisc/DVD player or HDTV set top box to the INPUT (P<sub>B</sub>) jack.
3. Connect the cable from the C<sub>R</sub>/P<sub>R</sub> OUT or R-Y OUT of the laserdisc/DVD player or HDTV set top box to the INPUT (P<sub>R</sub>) jack.
4. Connect the cable from the AUDIO OUT R of the Laserdisc/DVD player or HDTV set top box to the INPUT (AUDIO/R) jack.
5. Connect the cable from the AUDIO OUT L of the Laserdisc/DVD player or HDTV set top box to the INPUT (AUDIO/L) jack.
6. Press the the **INPUTS** button, then select **INPUT 3** from the **INPUTS** menu to view the program from the Laserdisc/DVD player or HDTV set top box. The VIDEO OSD label disappears automatically after approximately four seconds.
7. Select **CABLE/AIR** from the **INPUTS** menu to return to the last channel tuned.

**NOTE:** 1. Completely insert the connection cord plugs when connecting to rear panel jacks. The picture and sound that is played back will be abnormal if the connection is loose.  
2. See page 12 for tips on REAR PANEL CONNECTIONS.

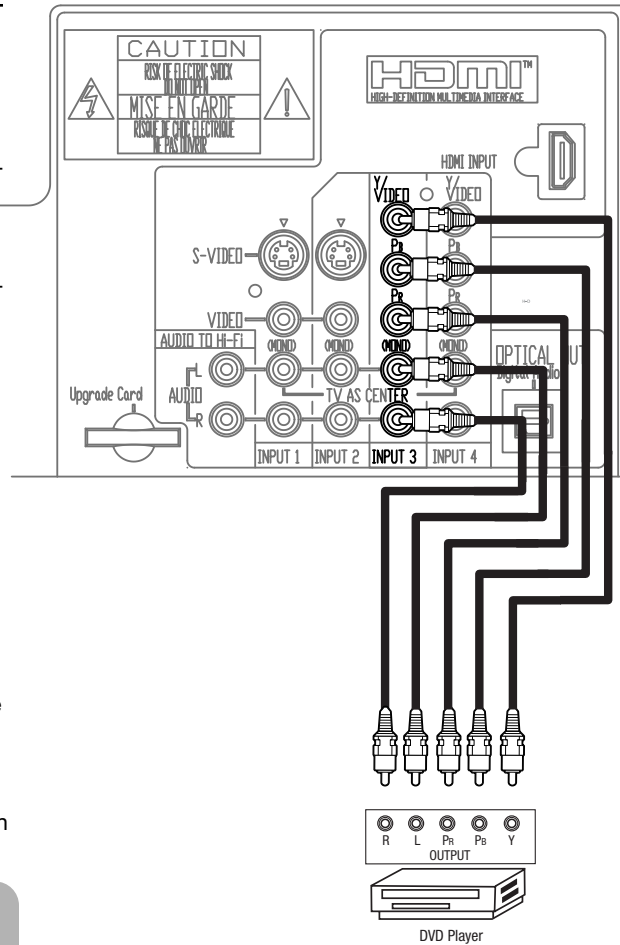

First time use

## The Remote Control

In addition to controlling all the functions on your **HITACHI** Projection TV, the new remote control is designed to operate different types of VCRs, CATV (Cable TV) converters, set-top-boxes, satellite receivers (SAT) and DVD players with one touch. Basic operation keys are grouped together in one area.

To operate your TV, point the remote control at the screen of the TV and press the **TV** button. The remote will now control your television.

To operate your VCR, point the remote at the remote sensor of the VCR and press the **VCR** button. The remote will now control your VCR (see page 31 for instructions on how to program the remote to control your VCR).

To operate your cable box, point the remote at the remote sensor of the cable box and press the **CABLE** (CBL) button. The remote will now control your cable box (see page 28 for instructions on how to program the remote to control your cable box).

To operate your set-top-box or satellite receiver, point the remote at the remote sensor of the set-top-box or satellite receiver and press the **SAT** button. The remote will now control your set-top-box or satellite receiver. If you have a satellite receiver, use this button to program your satellite receiver (see page 29 for instructions on how to program the remote to control your SAT).

To operate your DVD player, point the remote at the remote sensor of the DVD player and press the **DVD** button. The remote will now control your DVD player (see page 30 for instruction on how to program the remote to control your DVD player).

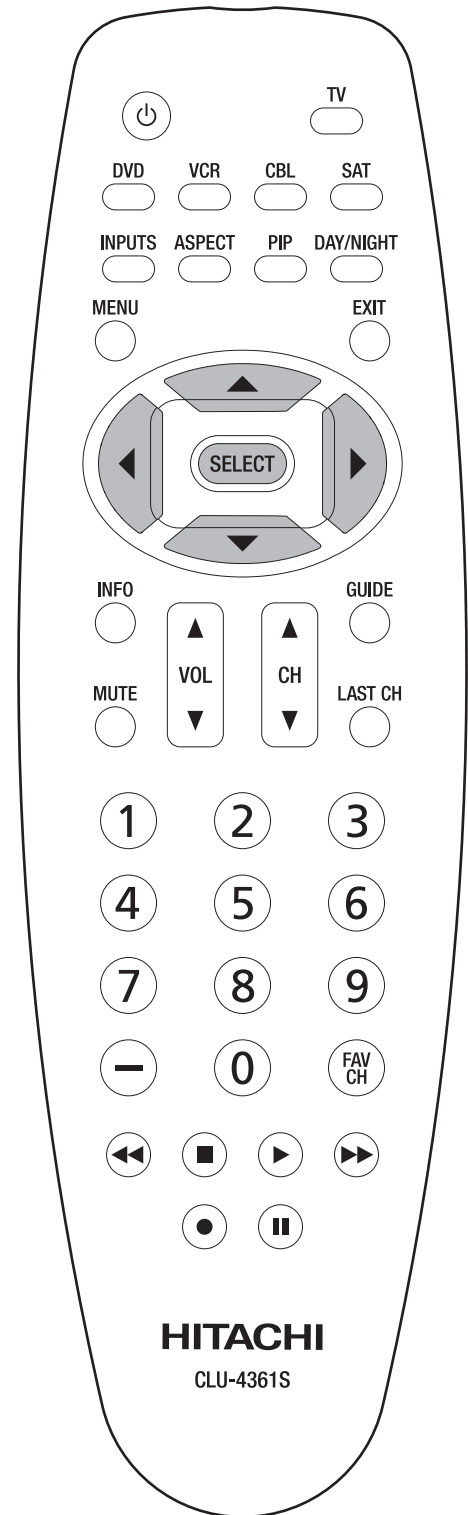

# How to Use the Remote to Control Your TV

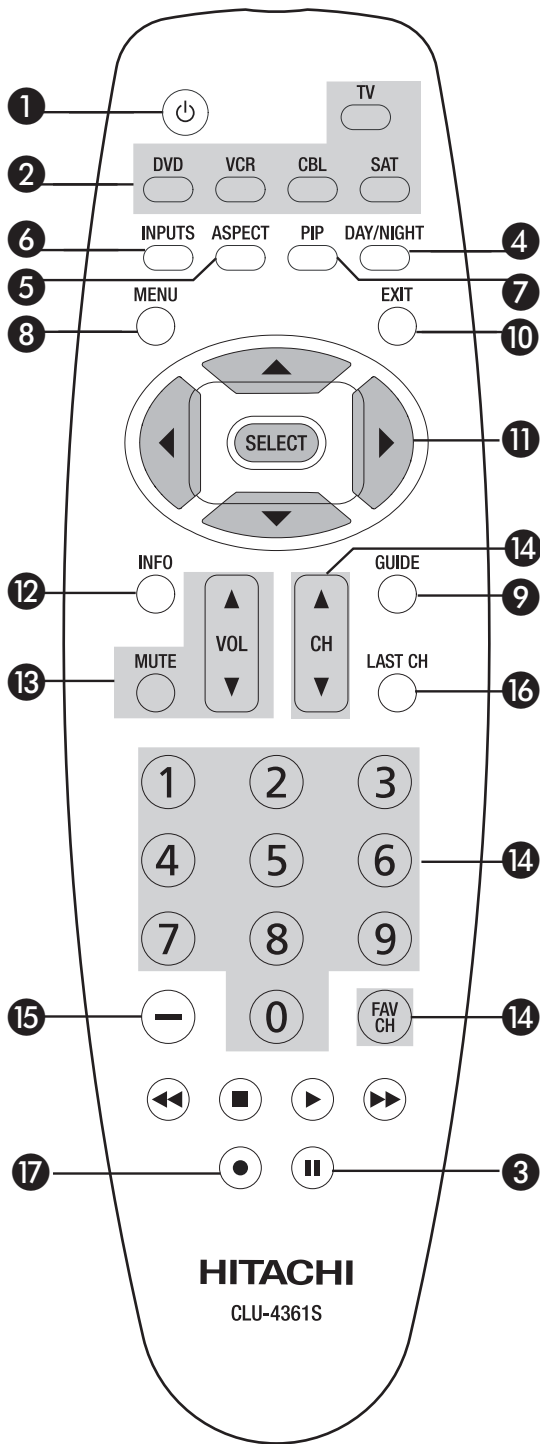

## 1 POWER button

Press this button to turn the TV set on or off when the remote is in TV mode. (See page 20 for instructions on how to set the remote control to TV mode.)

## 2 MODE buttons

These buttons allow the remote to control your TV, VCR, DVD, Cable box/Satellite box depending on which button is pressed.

## 3 PAUSE button

Press the **PAUSE** button to freeze the picture. Press the **EXIT** button to return the picture to motion. Press the **PAUSE** button repeatedly to cycle through the three different freeze modes (see page 24).

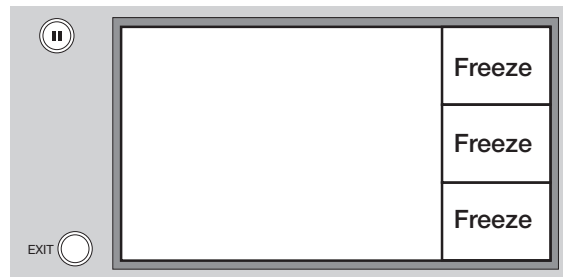
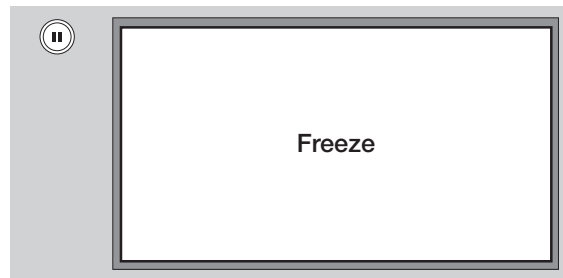

## 4 DAY/NIGHT button

Press this button to toggle between Day and Night picture mode settings. Select **DAY** for day time viewing with more brightness and contrast to compete with room light. Select **NIGHT** for night time viewing with less brightness and contrast for a more detailed picture (see page 34 for settings changes).

# How to Use the Remote to Control Your TV

## 5 ASPECT button

Press this button to quickly change the picture format ASPECT ratio. Depending on the input signal format received, the picture format ratio allows you to adjust the images through the following options.

### 4:3 STANDARD

Use this aspect mode to display conventional (4:3) images. Side panels (gray areas) are placed to the left and right of the image to preserve the original aspect ratio of the source. Note: Use this mode for only 15% of your total viewing time to prevent uneven aging of the phosphors. Phosphors in the lighted area of the picture will age more rapidly than the gray areas.

### 4:3 EXPANDED

Use this aspect mode to display conventional (4:3) sources by linearly increasing image expansion from the center towards the edges of the display area in order to fill it.

### 4:3 ZOOM1/ZOOM2

Use these aspect modes to zoom in on conventional (4:3) sources.

### 16:9 STANDARD

Use this aspect mode to display 16:9 sources like HDTV and DVD's preserving the original 16:9 aspect ratio.

### 16:9 ZOOM

Use this aspect to Zoom-in once while in 16:9 aspect.

- Antenna-Analog CH
- S-Video/Video Input (Auto Aspect: Off)
- HDMI-480i/480p Input (Auto Aspect: Off)
- Component-480i/480p Input (Auto Aspect: Off)

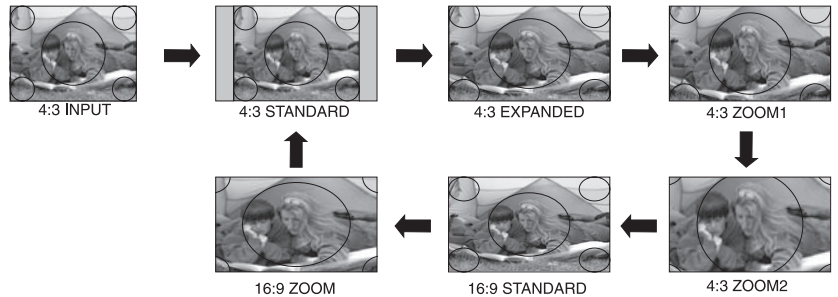

- Antenna-Digital CH (4:3)
- S-Video/Video 4:3 Letter Input (Auto Aspect: On)
- HDMI-480i/480p 4:3/ Letter Input (Auto Aspect: On)
- Component-480i/480p 4:3 Letter Input (Auto Aspect: On)

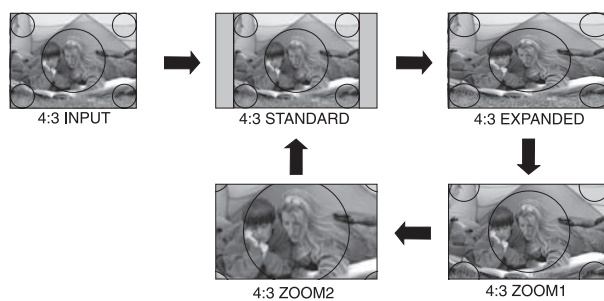

- S-Video/Video 16:9 Input (Auto Aspect: On)
- HDMI-480i/480p 16:9 Input (Auto Aspect: On)
- Component-480i/480p 16:9 Input (Auto Aspect: On)

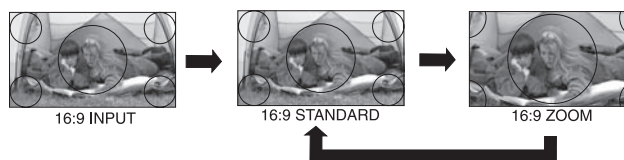

- Antenna-Digital CH (16:9)
- HDMI-720p/1080i (16:9) Input
- Component-720p/1080i (16:9) Input

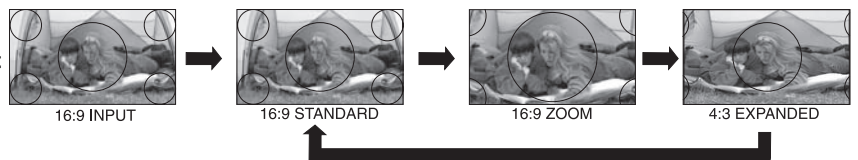

### NOTE:

1. All five video inputs have independent Aspect Style settings.
2. Vertical position adjustments are directly available when you choose 4:3 EXPANDED/ZOOM1/ZOOM2 or 16:9 ZOOM aspect style (see also page 40).

# How to Use the Remote to Control Your TV

## 6 INPUTS button

When the remote control is in TV mode, press this button to access the **INPUTS** menu. Use the **CURSOR** and **SELECT** buttons to scroll and select the inputs that are being used. Pressing the **INPUTS** button repeatedly will also cycle through the Inputs menu items. Then press the **SELECT** button to select.

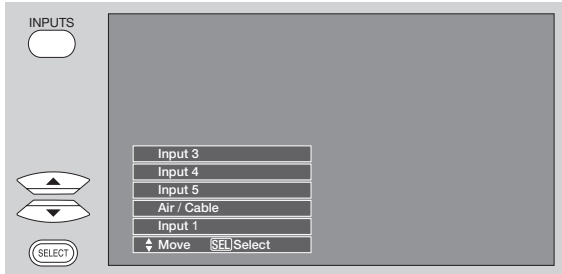

**INPUT 1** Select to choose Input 1.

**INPUT 2** Select to choose Input 2.

**INPUT 3** Select to choose Input 3.

**INPUT 4** Select to choose Input 4.

**INPUT 5** Select to choose Input 5.

**AIR/CABLE** Select to choose Air or Cable signal.

## 7 PICTURE-IN-PICTURE button

See separate section on pages 23-27 for a description.

## 8 MENU button

The **MENU** button will start the On-Screen Display.

## 9 GUIDE button

**[Cable Box (CBL), Satellite Receiver (SAT)/Set-Top-Box (STB) mode only]**

The use of this button is only applicable when the remote control is in (CBL) and (SAT/STB) mode. Press this button to access the Channel Guide of the (CBL), and (SAT/STB).

## 10 EXIT button

This button will exit all On-Screen Displays.

## 11 CURSOR buttons/SELECT button

All the On-Screen Display features can be set or adjusted by using the **CURSOR** buttons and the **SELECT** button, except for numeric entries. Press the **CURSOR** buttons toward desired direction and press the **SELECT** button to select.

## 12 INFO button

Press this button when you want to check the channel being received, the picture source, if the channel has stereo (ST) or second audio program (SA), the time, CHANNEL ID and if the TIMER is set.

**NOTE:** When the **INFO** button is pressed twice in a 4:3 Digital Channel the **ASPECT** mode will change, but it will return to normal view when the **INFO** OSD disappears.

## INFO button display for Analog Channels



## INFO button display for Digital Channels

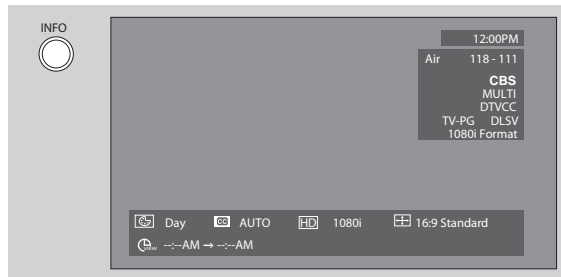

## INFO button display when an S-VIDEO Input is connected to INPUT 1

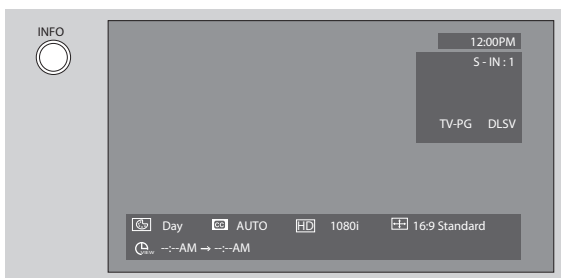

## INFO button display for when a COMPONENT VIDEO: Y-PbPr Input is connected to INPUT 3

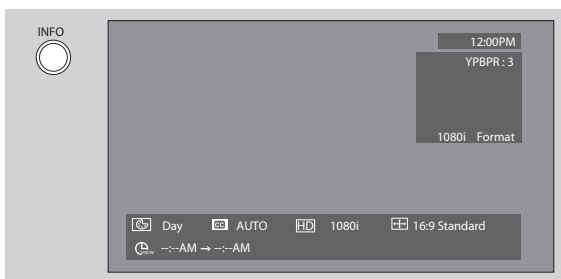

**NOTE:** 1. Press the **INFO** button again or the **EXIT** button to return to normal viewing.  
2. The **ASPECT INFORMATION** will show the aspect condition of a channel before it is blocked.

## How to Use the Remote to Control Your TV

### 13 VOLUME (VOL), MUTE button

Press the **VOLUME** button (▲ or ▼) until you obtain the desired sound level.

To reduce the sound to one half of normal volume (SOFT MUTE) to answer the telephone, etc., press the **MUTE** button. Press the **MUTE** button again to turn the sound off completely (MUTE). To restore the sound, press the **MUTE** button one more time, or **VOL UP** (▲).



Closed Captioning will display automatically when MUTE/SOFT MUTE is on and Closed Caption is set to **AUTO** (see page 59).

When the TV power is turned off at a volume level 31 or greater, the volume level will default to 30 when the TV is turned on. However, if it is set to a level 30 or less, the volume level will be at the level it was set when the TV is turned on.

### 14 CHANNEL SELECTOR/FAVORITE CHANNEL (FAV CH) buttons

The **CHANNEL SELECTOR** buttons are used to select channels, lock access code, etc. Use the **CHANNEL SELECTOR** buttons to enter one, two, or three numbers to select channels. Enter **0** first for channels **1** to **9**, or simply press the single digit channel you wish to tune then wait a few seconds for the TV to tune. Channel selection may also be performed by **CHANNEL (CH) UP** (▲) or **CHANNEL (CH) DOWN** (▼).

Press the **FAV CH** button to switch to Favorite (FAV) channel mode. You will know you are in Favorite Channel mode when (FAV) is displayed and the displayed channel indication is **GREEN**. Press it again to return to your regular tuned channels. You can add any channel to your Favorite channel list by pressing and holding down the **FAV CH** button until the displayed channel indication turns from **WHITE** to highlighted **GREEN**. You can also delete a channel from your favorite channel list by pressing and holding down the **FAV CH** button until the displayed channel indication turns highlighted **GREEN** to **WHITE**.

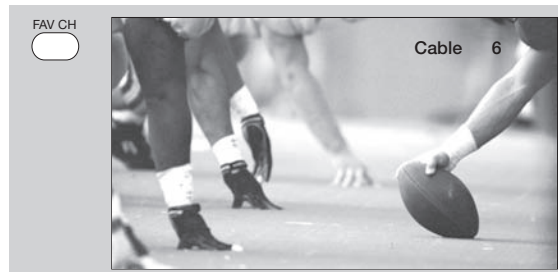
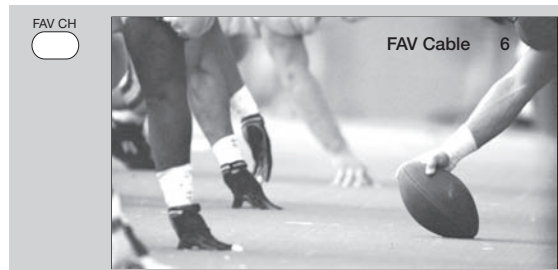

### 15 (-) DASH button

The **(-) DASH** button can only be used when the remote control is in Satellite (SAT) mode.

### 16 LAST CHANNEL (LC) button

Press this button to toggle between the current and last channel viewed.

### 17 RECORD button

Press twice (two times) to record programs when the remote is in VCR mode.

# Picture-in-Picture (PIP)

Your **HITACHI** Projection TV incorporates one Tuner technology designed for improved viewing enjoyment. This Tuner feature allows you to view antenna input on the main picture and a Video Input on sub-picture simultaneously.

When an **ANALOG** channel or **INPUT** is viewed as the main picture, an **ANALOG** channel or **INPUT** can not be viewed as a sub picture.

To select between main picture and PIP sub-picture use the **CURSOR** buttons on the remote. The green highlighted channel display will move with every press of the **CURSOR** buttons (◀ or ▶).

The Picture-in-Picture feature is convenient when you want to watch more than one program at the same time. You can watch a TV program while viewing other programs from any of the video inputs.

Use the connection diagram to the right to view VCR program as a sub-picture while viewing another program as main picture (**CABLE or AIR**). You may also view the VCR program as a main picture while viewing another program as a sub-picture (**CABLE or AIR**).

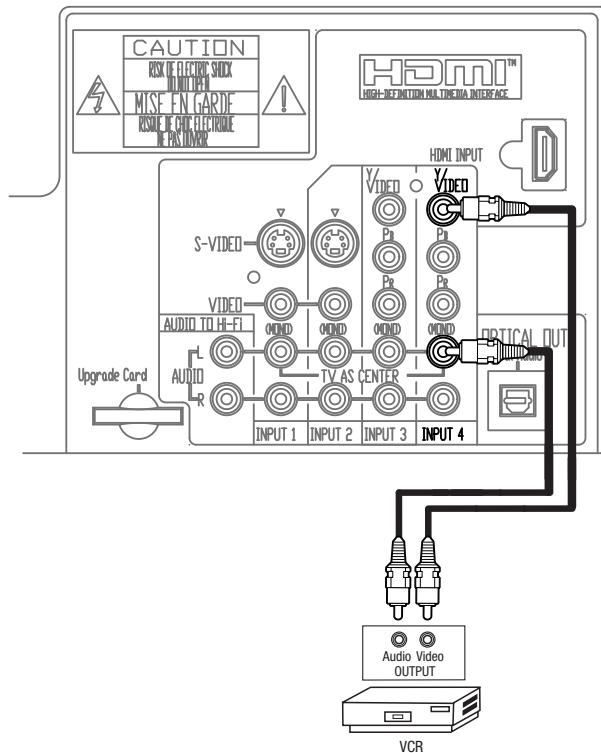

## 1 PIP button

Press the **PIP** button and a sub-picture will appear in one of the four different modes (**POP, PIP or SPLIT**), depending on the **INPUT** signal. To change the PIP mode, use the **PIP** button to cycle through the four different modes.

### POP Mode Picture-in-Picture

**POP MODE PIP** displays the sub-picture outside of the main picture. Use the **CURSOR** buttons (▲ or ▼) to move the sub-picture. This feature is not available with a 480p, 720p and 1080i signal. Please refer to the Picture-in-Picture Modes Table (see page 26 & 27).

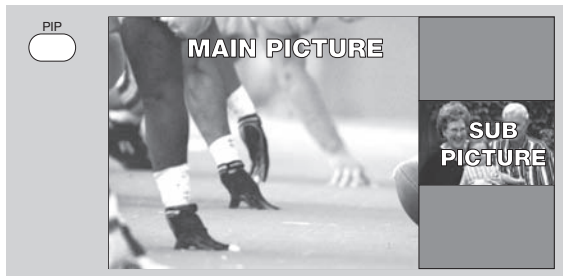

- NOTE:**
1. Press the **CURSOR** buttons (◀ or ▶) to enable the sub-picture sound.
  2. Two **INPUTS** cannot be viewed simultaneously in **PIP MODE**. Only one **INPUT** (1-5) and one antenna (**CABLE OR AIR**).

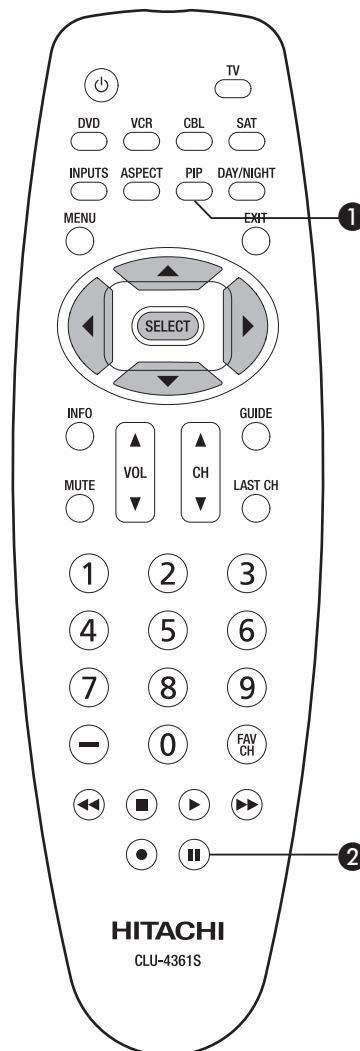

# Picture-in-Picture (PIP)

## PIP Mode Picture-in-Picture

This feature is only available with a 1080i signal. To prevent a pattern burn, occasionally move the sub-picture using the **CURSOR** buttons.



## SPLIT Mode Picture-in-Picture

Split Mode PIP displays the main picture and sub-picture evenly on the screen.



## 2 PAUSE button

If you wish to freeze the sub-picture, press the **PAUSE** button. This is convenient when trying to write down the address for a mail order company, recording statistics for a sporting event, etc. To return the picture to motion, press the **EXIT** button. Press the **PAUSE** button repeatedly to toggle between **FREEZE** modes (Main Freeze, SPLIT and STROBE).

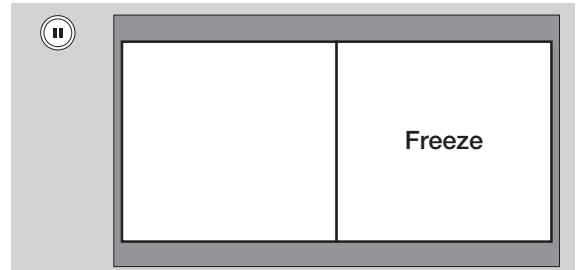
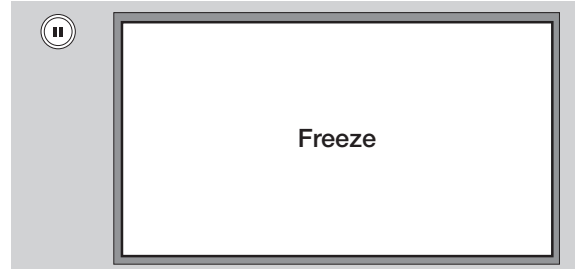

EXIT

**Note :** PIP Specifications in the following pages 26 & 27.



# Picture-in-Picture (PIP)

## MAIN FREEZE

Press the **PAUSE** button to freeze one frame of the picture you are currently viewing and the frozen frame will show in the Main Picture. Press the **EXIT** button to return to normal viewing. This feature is useful for freezing a picture frame with addresses.

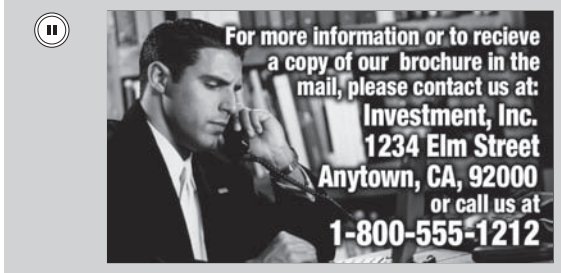

## SPLIT FREEZE

Press the **PAUSE** button to freeze the picture you are currently viewing (only the right sub-picture will freeze). Press the **EXIT** button to return to normal viewing. Please refer to page 27 for detailed spec.

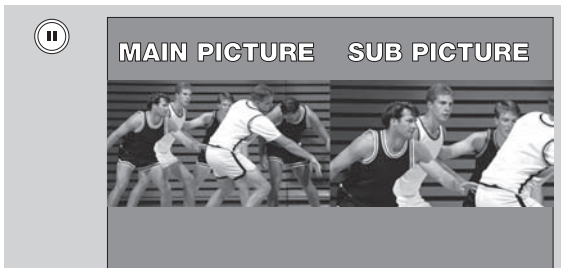

## STROBE FREEZE

Press the **PAUSE** button to freeze three frames of the picture you are currently viewing (only the 3 sub-pictures will freeze). Press the **EXIT** button to return to normal viewing. This feature is useful for viewing a moving picture that has many details, for example, a close play in a sporting event or a golf swing. Please refer to page 27 for detailed spec.

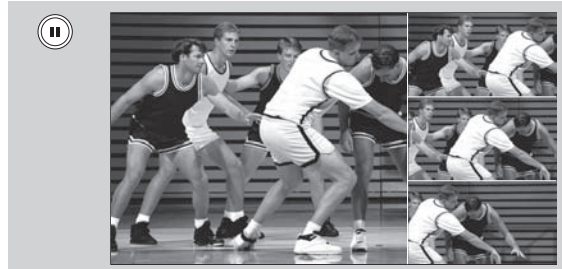

- NOTE:**
1. The default **FREEZE** mode is the **MAIN** freeze followed by the **SPLIT** freeze and then the **STROBE** freeze. The last Freeze mode you selected before you pressed the **EXIT** button will be the one that comes up after pressing the **PAUSE** button again.
  2. Each freeze frame is delayed about 0.1 (1/10) second.
  3. When the input is HDMI signal, the **FREEZE** mode is the **MAIN** picture **FREEZE**.

Note : PIP Specifications in the following pages 26 & 27.

# Picture-in-Picture (PIP)

## PIP Specifications

### PIP Input Mode

Main Picture \ Sub Picture		Air	Cable	Input1		Input2	Input3	Input4	Input5
		Digital CH Analog CH	Digital CH Analog CH	HDMI	S/Video	S/Video	Ypbpr Video	Ypbpr Video	S/Video
Air	Digital CH Analog CH	-	-	-	Yes	Yes	Yes	Yes	Yes
Cable	Digital CH Analog CH	-	-	-	Yes	Yes	Yes	Yes	Yes
Input1	HDMI S/Video	Yes	Yes	-	-	Yes	Yes	Yes	Yes
Input2	S/Video	Yes	Yes	-	Yes	-	Yes	Yes	Yes
Input3	Ypbpr Video	Yes	Yes	-	Yes	Yes	-	Yes	Yes
Input4	Ypbpr Video	Yes	Yes	-	Yes	Yes	Yes	-	Yes
Input5	S/Video	Yes	Yes	-	Yes	Yes	Yes	Yes	-

- (a) There is no combination between same input.
- (b) There is no combination between TV and TV , because of one tuner system. And the digital CH format is only 480i.
- (c) HDMI input is only for Main picture.
- (d) User can only select available combination by Input Menu.

### POP Mode

Scan Mode	Sub Pic.	Aspect	Digital CH 480i		Analog CH	1080i	720p	480p	480i		S/Video	
			16x9	4x3	4x3	16x9	16x9	16x9 4x3	16x9	4x3	16x9	4x3
540p	Digital CH (480i)	16x9/4x3	-	-	-	Yes	-	-	Yes	Yes	Yes	Yes
	Analog CH	4x3	-	-	-	Yes	-	-	Yes	Yes	Yes	Yes
	1080i	16x9	-	-	-	-	-	-	-	-	-	-
	720p	16x9	-	-	-	-	-	-	-	-	-	-
	480p	16x9/4x3	-	-	-	-	-	-	-	-	-	-
	480i	16x9/4x3	Yes	Yes	Yes	Yes	-	-	Yes	Yes	Yes	Yes
	S/Video	16x9/4x3	Yes	Yes	Yes	Yes	-	-	Yes	Yes	Yes	Yes

### PIP Mode : Sub picture 16x9

Scan Mode	Sub Pic.	Aspect	Digital CH 480i		Analog CH	1080i	720p	480p	480i		S/Video	
			16x9	4x3	4x3	16x9	16x9	16x9 4x3	16x9	4x3	16x9	4x3
1080i	1080i	16x9	Yes	-	-	Yes	-	-	Yes1	-	Yes1	-

Yes1: Auto Aspect ON

### PIP Mode : Sub picture 4x3

Scan Mode	Sub Pic.	Aspect	Digital CH 480i		Analog CH	1080i	720p	480p	480i		S/Video	
			16x9	4x3	4x3	16x9	16x9	16x9 4x3	16x9	4x3	16x9	4x3
1080i	1080i	16x9	-	Yes	Yes	-	-	-	Yes2	Yes	Yes2	Yes

Yes2: Auto Aspect OFF

# Picture-in-Picture (PIP)

## PIP Specifications (cont.)

### SPLIT Mode

Scan Mode	Sub	Aspect	Digital CH 480i		Analog CH 4x3	1080i 16x9	720p 16x9	480p 16x9 4x3	480i		S/Video	
			16x9	4x3					16x9	4x3	16x9	4x3
540p	Main											
	Digital CH (480i)	16x9 4x3	-	-	-	Yes	Yes	Yes	Yes	Yes	Yes	Yes
	Analog CH	4x3	-	-	-	Yes	Yes	Yes	Yes	Yes	Yes	Yes
	1080i	16x9	Yes	Yes	Yes	Yes	Yes	Yes	Yes	Yes	Yes	Yes
	720p	16x9	Yes	Yes	Yes	Yes	Yes	Yes	Yes	Yes	Yes	Yes
	480p	16x9/4x3	Yes	Yes	Yes	Yes	Yes	Yes	Yes	Yes	Yes	Yes
	480i	16x9/4x3	Yes	Yes	Yes	Yes	Yes	Yes	Yes	Yes	Yes	Yes
S/Video	16x9/4x3	Yes	Yes	Yes	Yes	Yes	Yes	Yes	Yes	Yes	Yes	

### STROBE Mode

Scan Mode	Sub	Aspect	Digital CH 480i		Analog CH 4x3	1080i 16x9	720p 16x9	480p 16x9 4x3	480i		S/Video	
			16x9	4x3					16x9	4x3	16x9	4x3
540p	Main											
	Digital CH (480i)	16x9 4x3	Yes	Yes	-	-	-	-	-	-	-	-
	Analog CH	4x3	-	-	Yes	-	-	-	-	-	-	-
	1080i	16x9	-	-	-	-	-	-	-	-	-	-
	720p	16x9	-	-	-	-	-	-	-	-	-	-
	480p	16x9/4x3	-	-	-	-	-	-	-	-	-	-
	480i	16x9/4x3	-	-	-	-	-	-	Yes	Yes	Yes	Yes
S/Video	16x9/4x3	-	-	-	-	-	-	Yes	Yes	Yes	Yes	

# The Remote Control for Cable Box Functions

## OPERATING THE PRECODED FUNCTION FOR YOUR DIGITAL/ANALOG CABLE BOX.

This remote is designed to operate different types of cable boxes. You must first program the remote to match the remote system of your DIGITAL or ANALOG Cable Box (refer below for pre-codes).

1. Turn **ON** your cable box.
2. Aim the remote control at the front of your cable box.
3. To switch to Cable (CBL) pre-coded mode, press and release the **CABLE (CBL)** button.
4. Hold down the **CBL** button on the remote and enter the two digit preset code that matches your cable box, as shown below. Release the **CBL** button.
5. Aim the remote at the cable box and press the **POWER** button. The remote will turn off your cable box when the correct two digit preset code is entered. When this occurs, the remote control is programmed for your cable box. If the cable box does not turn off, try a different two digit preset code.
6. The remote will now control your Cable box.

**NOTE:** 1. If your cable box cannot be operated after performing the above procedures, your cable box code has not been precoded into the remote.  
 2. In the unlikely event that your cable box cannot be operated after performing the above procedures, please consult your cable box operating guide.  
 3. The remote control will remember the codes you have programmed until the batteries are removed from the remote control. After replacing the batteries repeat the entire programming procedure as stated above.

- ❶ **CABLE (CBL) button**  
This button allows the remote to control your cable box by setting it to CABLE mode.
- ❷ **PRECODED CABLE BOX buttons**  
These buttons transmit the chosen precoded cable codes.
- ❸ **EXCLUSIVE TV buttons**  
These buttons are for operating the TV.

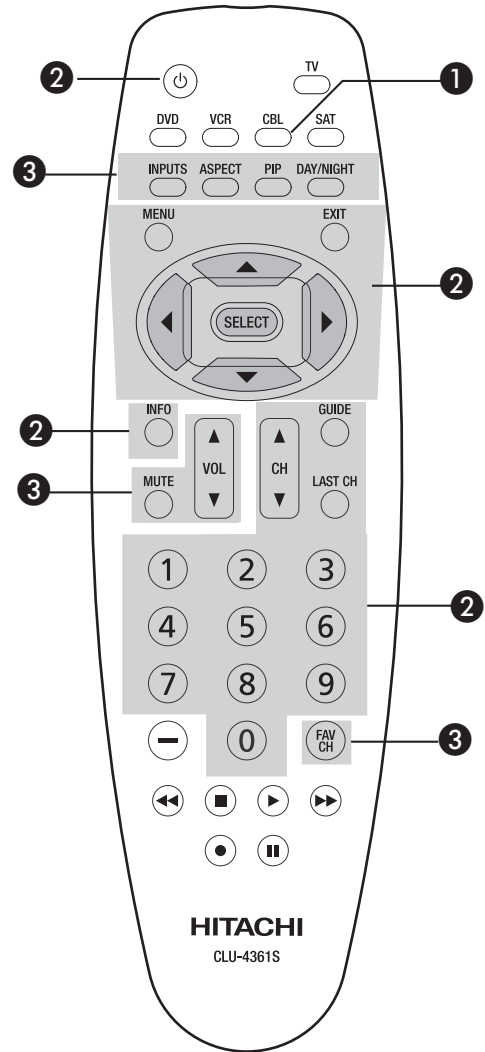

CABLE BRAND ANALOG TYPE	CODES
HAMLIN.....	11,12
JERROLD .....	00, 01, 02
OAK.....	13,14
PANASONIC.....	10
PIONEER.....	08,09
SCIENTIFIC ATLANTA.....	03,04,05
ZENITH.....	06,07

CABLE BRAND DIGITAL TYPE	CODES
ADELPHIA.....	18
CABLEVISION .....	19
COMCAST.....	20
COX.....	21
MOTOROLA.....	17,22,24
PIONEER.....	15
SCIENTIFIC ATLANTA .....	16
TIMEWARNER.....	23

**MY CABLE BOX CODE IS:** \_\_\_\_\_

**NOTE:** Refer to instruction manual of the Cable Box for operation of the buttons exclusively for the Cable Box.

# The Remote Control for Set-Top Box/Satellite Receiver Functions

## OPERATING THE PRECODED FUNCTION FOR YOUR SET-TOP-BOX/SATELLITE RECEIVER.

This remote is designed to operate different types of set-top-box/satellite systems. You must first program the remote to match the remote system of your set-top-box/satellite systems (refer below for pre-codes).

1. Turn **ON** your set-top-box/satellite systems.
2. Aim the remote control at the front of your set-top-box/satellite systems.
3. To switch to set-top-box/satellite (STB) pre-coded mode, press and release the **SAT** button.
4. Hold down the **SAT** button on the remote and enter the two digit preset code that matches your set-top-box/satellite receiver, as shown below. Release the **SAT** button.
5. Aim the remote at the set-top-box/satellite receiver and press the **POWER** button. The remote will turn off your set-top-box/satellite receiver when the correct two digit preset code is entered. When this occurs, the remote control is programmed for your set-top-box/satellite receiver. If the set-top-box/satellite receiver does not turn off, try a different two digit preset code.
6. The remote will now control your set-top-box/satellite receiver.

**NOTE:**

1. If your set-top-box/satellite receiver cannot be operated after performing the above procedures, your set-top-box/satellite receiver code has not been precoded into the remote.
2. In the unlikely event that your set-top-box/satellite receiver cannot be operated after performing the above procedures, please consult your set-top-box/satellite receiver operating guide.
3. The remote control will remember the codes you have programmed until the batteries are removed from the remote control. After replacing the batteries repeat the entire programming procedure as stated above.

### ① SAT (Set-Top-Box/Satellite) button

This button allows the remote to control your set-top-box/satellite receiver by setting it to SET-TOP-BOX/SATELLITE mode.

### ② PRE-CODED SET-TOP-BOX/SATELLITE RECEIVER buttons

These buttons transmit the chosen pre-coded set-top-box/satellite codes.

### ③ EXCLUSIVE TV buttons

These buttons are for operating the TV.

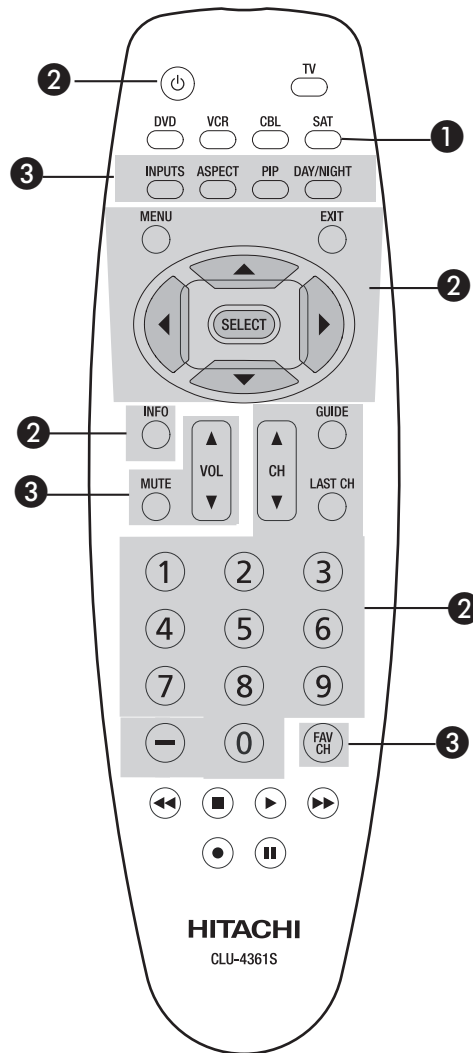

### SATELLITE BRAND

### CODES

ECOSTAR .....	03
HITACHI.....	00
HUGHES .....	04
RCA .....	01
SONY .....	02

### SET TOP BOX BRAND

### CODES

PANASONIC .....	05
RCA .....	06
SAMSUNG .....	07
ZENITH .....	08

### MY SATELLITE RECEIVER/ SET TOP BOX CODE IS:

\_\_\_\_\_

**NOTE:** Refer to instruction manual of the set-top-box/satellite receiver for operation of the buttons exclusively for the set-top-box/satellite receiver.

# The Remote Control for DVD Functions

## OPERATING THE PRECODED FUNCTION FOR YOUR DVD PLAYER.

This remote is designed to operate different types of DVD players. You must first program the remote to match the remote system of your DVD player (refer below for pre-codes).

1. Turn **ON** your DVD player.
2. Aim the remote control at the front of your DVD player.
3. To switch to DVD pre-coded mode, press and release the **DVD** button.
4. Hold down the **DVD** button on the remote and enter the two digit preset code that matches your DVD player, as shown below. Release the **DVD** button.
5. Aim the remote at the DVD player and press the **POWER** button. The remote will turn off your DVD player when the correct two digit preset code is entered. When this occurs, the remote control is programmed for your DVD player. If the DVD player does not turn off, try a different two digit preset code.
6. The remote will now control your DVD player.
7. You will need to set the display type of your DVD player to **16:9 WIDESCREEN**.

**NOTE:** 1. If your DVD player cannot be operated after performing the above procedures, your DVD player's code has not been precoded into the remote.  
 2. In the unlikely event that your DVD player cannot be operated after performing the above procedures, please consult your DVD player operating guide.  
 3. The remote control will remember the codes you have programmed until the batteries are removed from the remote control. After replacing the batteries repeat the entire programming procedure as stated above.

- ❶ **DVD button**  
This button allows the remote to control your DVD player by setting it to DVD mode.
- ❷ **PRECODED DVD Buttons**  
These buttons transmit the chosen precoded DVD codes.
- ❸ **EXCLUSIVE TV Buttons**  
These buttons are for operating the TV.

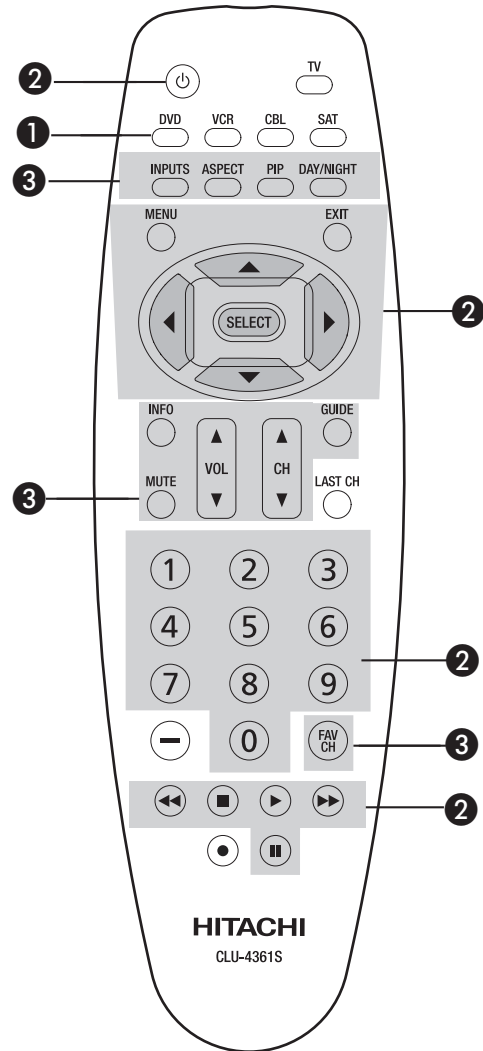

DVD BRAND	CODES
APEX .....	09
GO VIDEO .....	08
HITACHI .....	00
KENWOOD .....	10
PANASONIC .....	02
PIONEER .....	03
RCA .....	04
SAMSUNG .....	06
SANYO .....	07
SONY .....	01
TOSHIBA .....	05

**MY DVD PLAYER CODE IS:** \_\_\_\_\_

**NOTE:** Refer to instruction manual of the DVD player for operation of the buttons exclusively for the DVD player.

# The Remote Control for VCR Functions

## OPERATING THE PRECODED FUNCTION FOR YOUR VCR.

This remote is designed to operate different types of VCRs. You must first program the remote to match the remote system of your VCR (refer below for pre-codes).

1. Turn **ON** your VCR.
2. Aim the remote control at the front of your VCR.
3. To switch to VCR pre-coded mode, press and release the **VCR** button.
4. Hold down the **VCR** button on the remote and enter the two digit preset code that matches your VCR, as shown below. Release the **VCR** button.
5. Aim the remote at the VCR and press the **POWER** button. The remote will turn off your VCR when the correct two digit preset code is entered. When this occurs, the remote control is programmed for your VCR. If the VCR does not turn off, try a different two digit preset code.
6. The remote will now control your VCR.

**NOTE:** 1. If your VCR cannot be operated after performing the above procedures, your VCR's code has not been precoded into the remote.  
 2. In the unlikely event that your VCR cannot be operated after performing the above procedures, please consult your VCR operating guide.  
 3. The remote control will remember the codes you have programmed until the batteries are removed from the remote control. After replacing the batteries repeat the entire programming procedure as stated above.  
 4. Press the Record button twice to record.

- ❶ **VCR button**  
This button allows the remote to control your VCR player by setting it to VCR mode.
- ❷ **PRECODED VCR Buttons**  
These buttons transmit the chosen precoded VCR codes.
- ❸ **EXCLUSIVE TV Buttons**  
These buttons are for operating the TV.

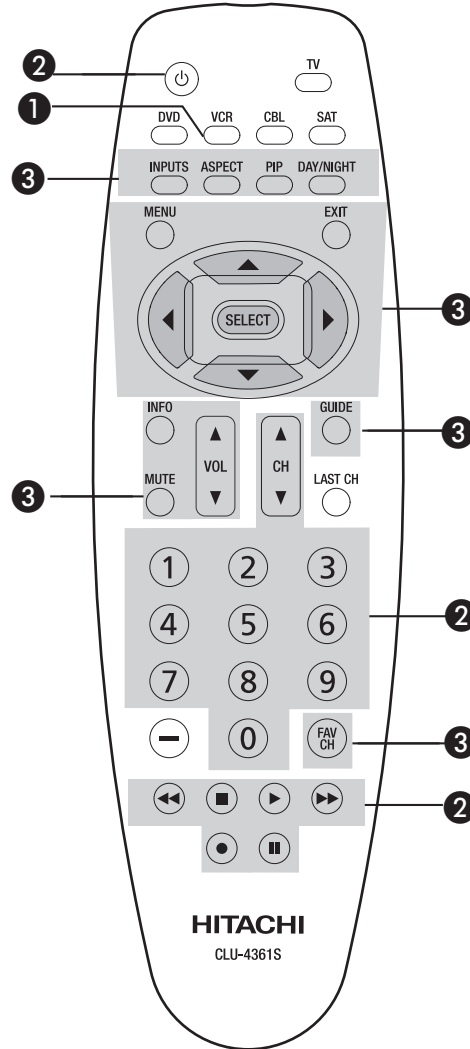

VCR BRAND	CODES
AIWA.....	20
FUNAI.....	21
HITACHI.....	.00, 01, 02, 03, 04, 05, 06
JVC.....	13
MITSUBISHI.....	16,17
PANASONIC.....	10, 11
SAMSUNG.....	14,15
ZENITH.....	19
SHARP.....	18
SONY.....	.07, 08, 09
TOSHIBA.....	12

**MY VCR PLAYER CODE IS:** \_\_\_\_\_

**NOTE:** Refer to instruction manual of the VCR for operation of the buttons exclusively for the VCR.

# On-Screen Display

1. Press **MENU** on the remote control to display the different features on your **HITACHI** Projection TV.
2. Press the **CURSOR** buttons to navigate and highlight a different feature of the On-Screen Display menu. Press the **SELECT** button to select.
3. Press **EXIT** on the remote control to quickly exit from a menu.

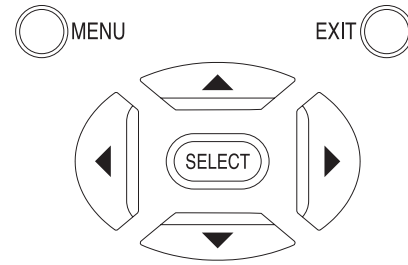

This part of the screen shows which selections are available.

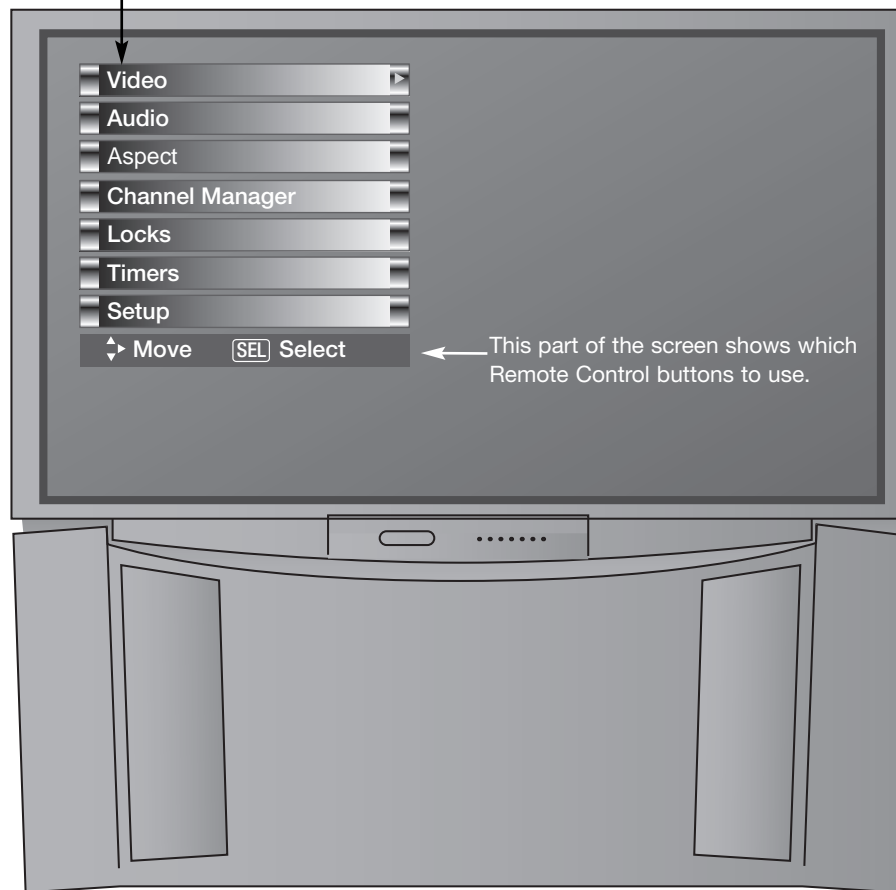

This part of the screen shows which Remote Control buttons to use.



## On-Screen Display

### Video

Picture Mode	Select between the two picture modes; Day and Night.
Contrast	Adjust contrast.
Brightness	Adjust brightness.
Color	Adjust color.
Tint	Adjust tint.
Sharpness	Adjust sharpness.
Color Temperature	Set this to High for less intense color with more blue, set to Medium for natural color, set to Standard for standard colors.
Black Enhancement	Enhance picture brightness in light scenes.
Edge Enhancement	Automatically enhances the edges between light and dark areas.
Reset Video Settings	Choose the Reset Video settings.
Auto Color	Adjusts the color to maintain constant color levels
Noise Reduction	Reduces conspicuous noise in the picture.
Auto Movie Mode	Turn ON/OFF the 3:2 Pulldown detection feature.

### Audio

Treble	Adjust the treble.
Bass	Adjust the bass.
Balance	Adjust the balance.
Surround	Select Surround settings (Off, Wide, Normal)
Audio Source	Select between three Audio Sources.
Internal Speakers	Select internal or external speakers.
Auto Noise Cancel	Eliminates the noise between stations.
Perfect Volume	Adjust volume in fixed setting.
Loudness	Adjust Loudness.
Language	Select Language options if available.
DRC	Select Dynamic Range Compression to ON or OFF.

### Aspect

Mode	Choose the picture format aspect ratio.
Auto Aspect	Auto adjust the Aspect Ratio
Vertical Position	Adjust the position of the picture

### Channel Manager

Signal Meter	Access Signal Meter.
Auto Channel Scan	Set Auto Channel Scan.
Channel List	Set Channel List.

### Locks

Change Access Code	Change Lock access code.
Engage Lock	Choose to lock channel or front panel.
Movie Ratings	Block various types of movies and video types based on motion picture ratings.
TV Ratings	Block various types of movies and television programming based on a parental guide ratings.
Canadian Ratings (ENG)	Block various types of movies and television programming based on the Canadian ratings system.
Canadian Ratings (FRN)	Block various types of movies and television programming based on the Canadian French ratings system.
Alternate Ratings	Ratings system for DTV Signal to block various types of programs

### Timers

Set the Clock	Set Clock Settings.
Set Sleep Timer	Set Sleep Timer intervals (30 min. intervals, 00:30-3:00).
Set Day/Night Timer	Set Day/Night picture mode settings.
Set Event Timer	Set viewing reservation for TV programs.

### Setup

Magic Focus Tune Up	Automatic and manual alignment of the red, green and blue colors to make white.
Menu Preference	Choose English, French, or Spanish text.
Set The Inputs	Label Video Inputs, VCR, DVD, etc.
Virtual HD	Select between 1080i and 540p Scan mode.
Black Side Panel	Set the gray side bars on/off when watching 4:3 signals in standard mode.
Set Closed Captions	Feature to display dialogue/text.
Set Audio Out	Set Audio Out source.
Upgrades	Select to upgrade TV software.

**NOTE:** 1. The Language and the Dynamic Range Compression feature of the Audio OSD are only available for Digital channels.

2. The Signal Meter feature of the Channel Manager OSD is only available for Digital signals.

## Video

Select VIDEO to adjust picture settings and improve picture quality. You can independently customize each of the Video Inputs to your preference to increase viewing performance and pleasure depending upon the video program being viewed. If RESET is selected, only the selected input will reset to initial conditions.

### Picture Mode

Use this function to choose from automatic picture settings to optimize your TV's performance.

1. Use the **CURSOR** buttons ◀ or ▶ to highlight and select **PICTURE MODE** settings.
2. Press **EXIT** to quit menu or select **PICTURE MODE** to return to previous menu.

Function	Day	Night
Contrast	100%	70%
Brightness	50%	55%
Color	50%	50%
Tint	50%	50%
Sharpness	50%	40%
Color Temperature	High	Standard
Black Enhancement	Middle	Low
Edge Enhancement	High	Low
Noise Reduction	Off	Off

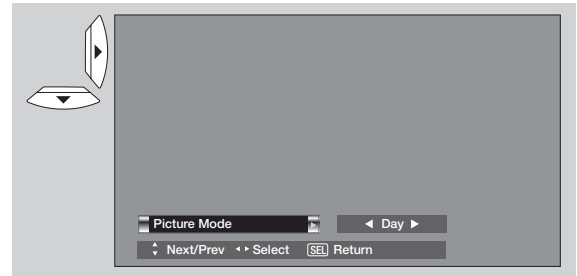
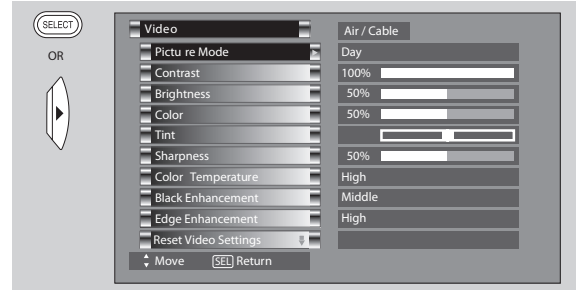

1. Use the **CURSOR** buttons ▲ or ▼ to highlight the function to be adjusted.
2. Press the **CURSOR** buttons ◀ or ▶ to adjust the function. Press the **SELECT** button to select the function settings.
3. Press **MENU** to return to main menu or select **PICTURE MODE** to return to previous menu.
4. Press **EXIT** to quit menu.

### Contrast

Use this function to change the contrast between black and white levels in the picture.

### Brightness

Use this function to adjust overall picture brightness.

### Color

Use this function to adjust the level of color in the picture.

### Tint

Use this function to adjust flesh tones so they appear natural.

### Sharpness

Use this function to adjust the amount of fine detail in the picture. Sharpness function will be disabled when Noise Reduction is set to High.

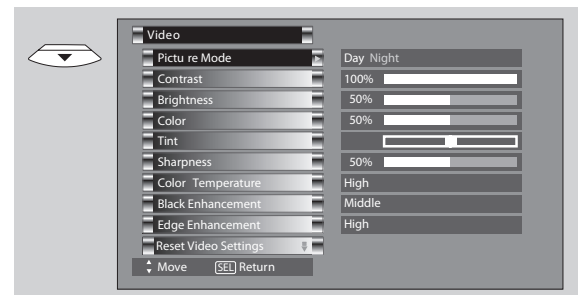

# Video

## Color Temperature

Set this to High for cooler color with more blue, set to Medium for more natural color, set to Standard for accurate color.

## Black Enhancement

Use this function to enhance Picture brightness in light scenes using the settings off, low, middle and high.

## Edge Enhancement

Use this function to automatically enhance the edges between light and dark areas using the settings Off, Low, Middle and High.

- NOTE:**
1. If **CONTRAST** is selected, you are adjusting **CONTRAST**. The additional menu items **BRIGHTNESS**, **COLOR**, **TINT**, and **SHARPNESS** can be selected and adjusted in the same manner.
  2. It may be necessary to adjust **TINT** to obtain optimum picture quality when using the **COMPONENT VIDEO Y-PbPr** input jacks.
  3. **CABLE** and **AIR** share a Video setting. Also, each of the video inputs have their own independent settings.

## Reset Video Settings

This function allows you to Reset the Video Menu Settings of the present input and return it to the Day VIDEO mode.

1. Use the **CURSOR** buttons ▲ or ▼ to highlight the function to be adjusted.
2. Press the **SELECT** button to select **RESET VIDEO SETTINGS**.
3. Use the **CURSOR** button ▼ to access other video settings.

You can customize each of the Video Inputs to your preference to increase viewing performance and pleasure, depending upon the video program being viewed. If **RESET** is selected, only the selected Input will reset to the initial conditions as explained above.

If **RESET** is selected in Input 1, only Input 1 will return to factory conditions.

## Auto Color

The **AUTO COLOR** function automatically monitors and adjusts the color to maintain natural flesh tones while preserving fidelity of background colors.

**NOTE:** When using Component, HDMI input, Auto Color will not be available (grayed out).

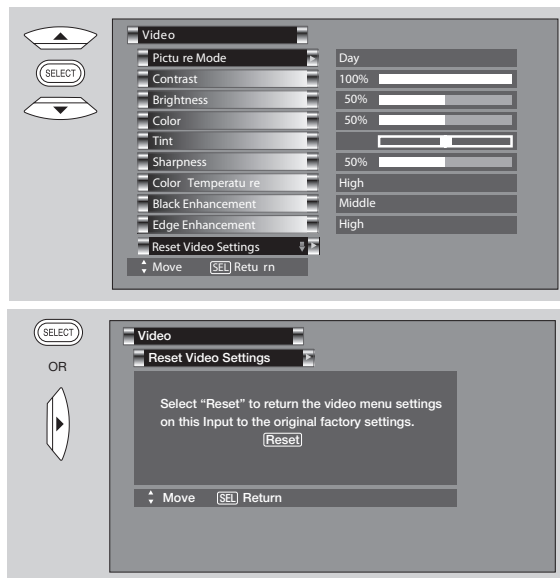

## Noise Reduction

The **NOISE REDUCTION** function automatically reduces conspicuous noise in the picture without degrading picture quality. Set **NOISE REDUCTION** to **OFF** if the TV experiences picture blocking. When Noise Reduction is set to High, Sharpness function is disabled (grayed out).

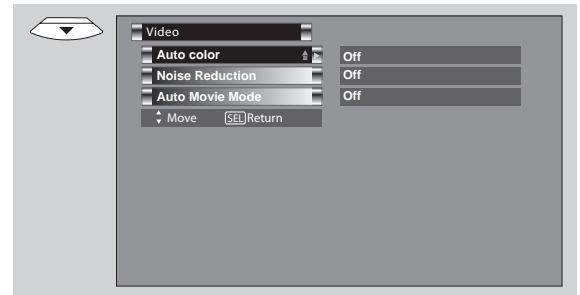

## Auto Movie Mode

The Auto Movie Mode function turns ON or OFF the 3:2 PULLDOWN DETECTION SPECIAL FEATURE. Theatrical movies are shot on film at 24 frames or still pictures per second, instead of 30 frames or 60 fields like video. When film is transferred to video for television viewing, the disparity between the two frame rates must be reconciled. This involves a process known as 3:2 pull-down.

When Auto Movie Mode is turned ON from the VIDEO menu, your Hitachi Projection Television will activate the circuitry for this special feature to improve video performance when watching film based sources.

- NOTES:**
1. When using Progressive Scan Component or HDMI input (Ex. 480p, 720p, 1080i), Auto Movie Mode will not be available (grayed out).
  2. All Video settings are independent of each other based on it's input (Air/Cable, Input 1~5).

# Audio

## Audio

Select **AUDIO** to adjust the TV to your preference and to improve the sound quality.

1. Use the **CURSOR** buttons ▲ or ▼ to highlight the function to be adjusted.
2. Press the **CURSOR** buttons ◀ or ▶ to adjust the function.
3. Press **EXIT** to quit the menu or select **AUDIO** to return to the main menu.

*NOTE: If TREBLE is selected you are adjusting TREBLE. The additional menu items BASS and BALANCE can be selected and adjusted in the same manner.*

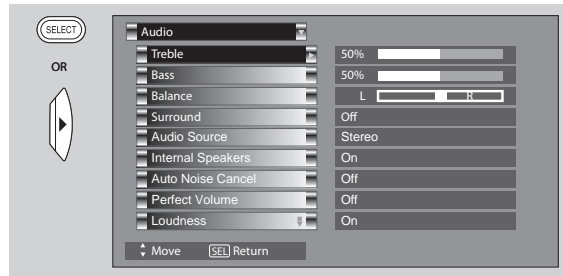

### Treble

This function controls the high frequency audio to all speakers.

### Bass

This function controls the low frequency audio to all speakers.

### Balance

This function will control the left to right balance of the Projection TV internal speakers.

### Surround

Surround sound is the concept of expanding the spatial imaging of audio from one dimension ( Mono/Left-Right) to two or three dimensions. This is often done to create a more realistic audio environment.

- 1.- Use cursor ▲ or ▼ to highlight surround option.
- 2.- Use cursor ◀ or ▶ to select Off, Normal or Wide.

Off : turns off the surround sound effect.

Normal Surround : Provides the surround effect by locating two or more speakers to the rear of the listener.

Wide Surround : Reproduce much better quality 5 channel sound signals from ordinary stereo contents comparing with normal surround technology. Wide surround enable users to enjoy sound playback in wide surround virtual area like 5 channel contents with ordinary stereo contents.

# Audio

## Audio Source

Multi-Channel Television Sound will allow you to select **STEREO** (a stereo broadcast), **MONO** (monaural sound) used when receiving a weak stereo broadcast or **SECOND AUDIO PROG (SAP)** which may be a secondary language, weather report, etc.

The sources received will be displayed at the top left edge of the TV. See example to the right for each source received.

1. Press the **INFO** button to display the source received.

**NOTE:** 1. When a monaural (MONO) audio broadcast source is received, no indication will be displayed.  
2. When a ST/SA indication is displayed, the audio being received will be both **STEREO** and **SECOND AUDIO**.

## STEREO



## MONO

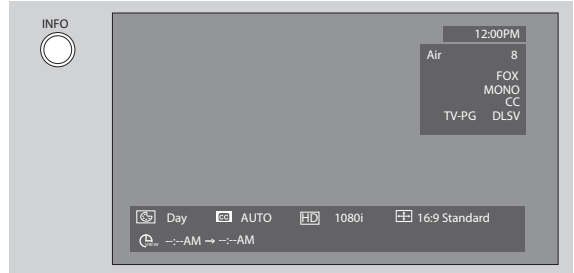

## ST/SA



## Internal Speakers

This function is useful when setting up the external speakers.

ON	Select this feature if using the internal speakers only.
TV as Center	Select this feature when setting up external speakers from a separate stereo system. The TV's speakers will work as the center speaker.
OFF	Select this feature if you prefer to use only speakers from a separate stereo system.

## Auto Noise Cancel

This function eliminates the noise between stations. If a channel is tuned and is noisy, this function will automatically eliminate the audio for that channel.

## Perfect Volume

This function will automatically adjust volume so each channel and input has the same average volume level.

## Loudness

This function turns loudness **ON** or **OFF**. It will improve the quality of both low and high frequency sounds when listening at low volume levels.

# Audio

Use the functions below if your TV is connected to an amplifier/receiver with **OPTICAL DIGITAL INPUT** with Dolby Digital decoder capabilities.

1. Use the **CURSOR** buttons ▲ or ▼ to highlight the function to be adjusted.
2. Press the **CURSOR** buttons ◀ or ▶ to adjust the function.
3. Press **EXIT** to quit the menu or select **AUDIO** to return to the main menu.

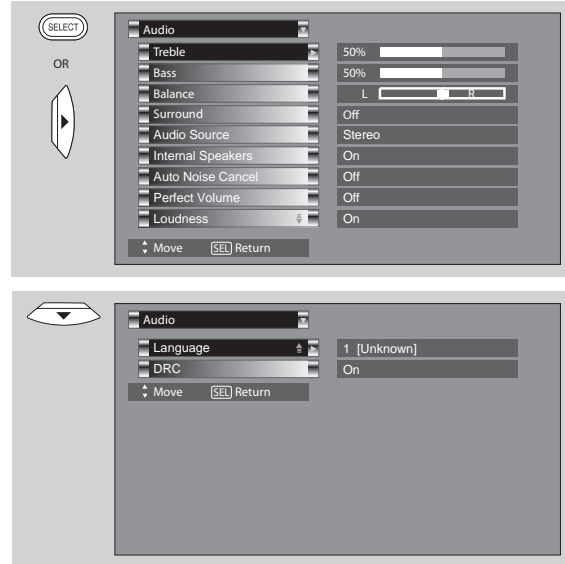

## Language

Some programs transmit more than one DTV language option. Most will have English as a default language. The language function will allow you to select up to 4 language options (if available).

## DRC

Dynamic Range Compression - Use this function to compress the range of sound volume. By compressing the range of sound volume, it is possible not only to suppress the output of loud sound at night but also to raise the volume of low sound. This is only effective when the TV is connected via the optical out (digital audio) to an amplifier/receiver with a Dolby® Digital decoder. The default setting is ON. Use the **CURSOR** buttons ◀ or ▶ to select the chosen options.

**NOTE:** These functions are only available when viewing digital channels. (Digital Tuner)

NOTE 1: Optical Audio Out "Only" available using Digital Tuner on Digital Channels.  
No other input's Audio is output via Optical Audio Out.  
This includes HDMI audio. It is not output.

CH1

BACK TO COVER

# Aspect

## Aspect

Use this function to select the Picture Format Aspect Ratio.

1. Use the **CURSOR** buttons ▲ or ▼ to highlight the **ASPECT MODE**.
2. Press the **SELECT** button to select **ON** or **OFF**.

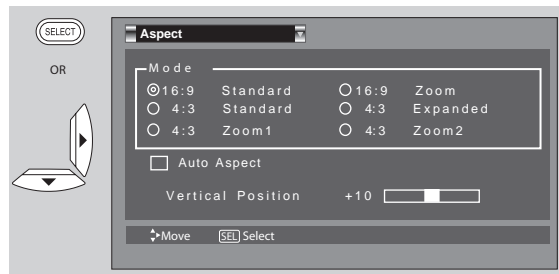

### Auto Aspect

Automatically adjust the Aspect Ratio depending on the input signal to fill the screen.

**NOTE:** 1. The Auto Aspect function is recommended on an input signal with **VIDEO ID**.  
2. The Auto Aspect function is best used on **COMPOSITE VIDEO, S-VIDEO, 480i and 480p COMPONENT/HDMI signals**.

3. Press the **CURSOR** buttons ◀ or ▶ to select **VERTICAL POSITION**.

### Vertical Position

This function allows you to select when aspect style is either **4:3 EXPANDED/ZOOM1/ZOOM2** or **16:9 ZOOM**. Vertical position can be changed with these modes. For example, it will be useful for centering the picture area at both the top and bottom of the picture with 480i/480P signal. Adjustable range is -10 (video center is toward bottom of screen) to +10 (video center is toward top of screen).

**NOTE:** Vertical Position will not be available in **4:3 STANDARD and 16:9 STANDARD MODES**.

4. Press **MENU** to return to main menu or select **ASPECT** to return to previous menu.
5. Press **EXIT** to quit menu.



# Channel Manager

## Channel Manager

Select **CHANNEL MANAGER** to set your Antenna options, run Auto Channel Scan, Check Signal Meter and Set Channel List.

1. Use the **CURSOR** buttons ▲ or ▼ to highlight the function to be adjusted.
2. Press the **SELECT** button or **CURSOR** button ► to select.

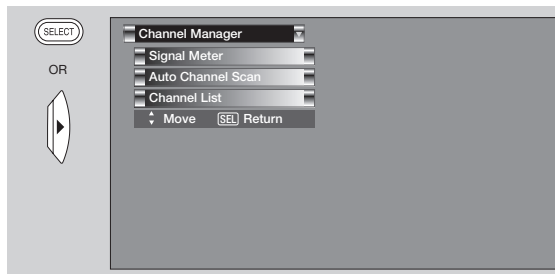

## Signal Meter

Select **SIGNAL METER** when using an indoor or outdoor antenna. This feature will show the signal strength and peak values of the Antenna signal to help you adjust your antenna to optimize signal reception.

1. Use the **CURSOR** buttons ▲ or ▼ to highlight **SIGNAL METER**.
2. Press the **SELECT** button to select.

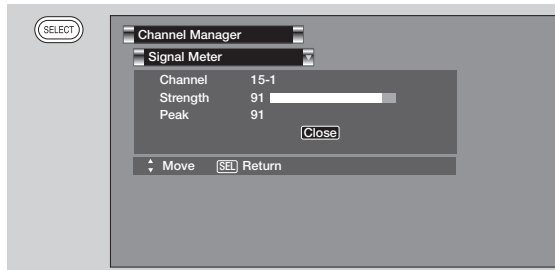
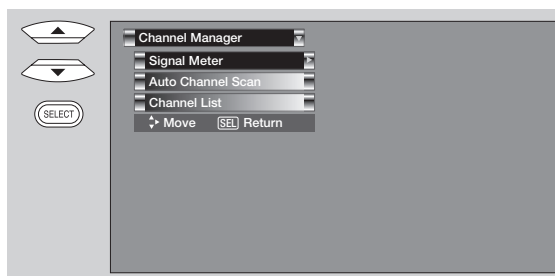

**NOTE:** The Signal Meter will not be available (grayed out) when watching analog channels.

# Channel Manager

## Auto Channel Scan

This feature will automatically store active TV channels in Auto Channel Scan memory.

1. Use the **CURSOR** buttons ◀ or ▶ to highlight AIR, CABLE (1) or CABLE(2) source.
2. Press the **CURSOR** buttons ◀ or ▶ to highlight the **START** or **RESET** option.
3. Press the **SELECT** button to select.

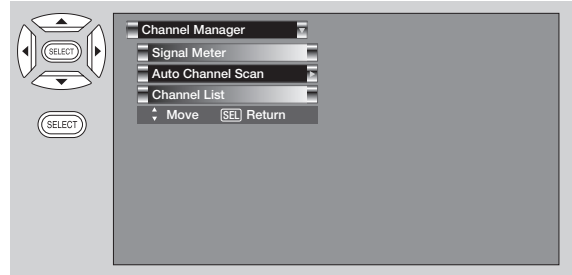

## Channel List

This function allows you to review which channels are labeled (**CH ID**), which have been added to **CHANNEL MEMORY (SCAN)**, which are protected by **LOCK** and which are your **FAVORITE (FAV) CHANNELS**.

1. Use the **CURSOR** buttons navigate the Channel List.
2. Press the **SELECT** button to select **ON** or **OFF** on the **SCAN** and **LOCK** Columns.
3. To select the **LOCK** column, input the access code. (Default access code: 0000)
4. Press the **FAV** button to set or remove the **FAVORITES** settings.
5. Press the **EXIT** button to return to normal viewing.

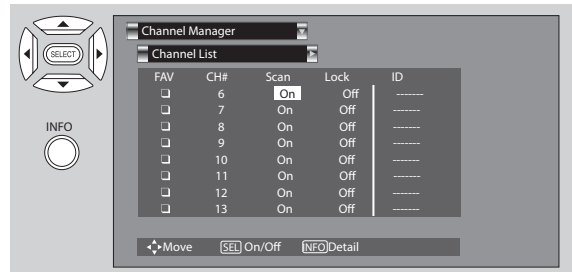
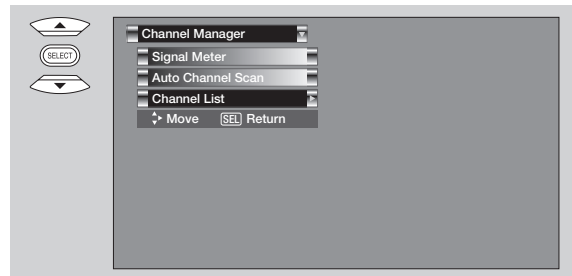
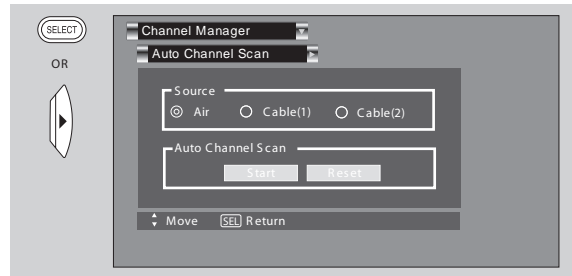

**NOTE:** 1. When changing cable sources from CABLE (1) to CABLE (2), the AUTO CHANNEL SCAN needs to be repeated for the Channel List to be updated.

# Locks

## Locks

This function will block out the picture and sound of the selected channel or video input.

The code to enter the Locks feature is a four digit access code number. The factory preset code is 0000. Use the **NUMBER** buttons to enter the access code.

1. Use the **CURSOR** buttons ◀ or ▶ to highlight function.
2. Press the **SELECT** button to select.

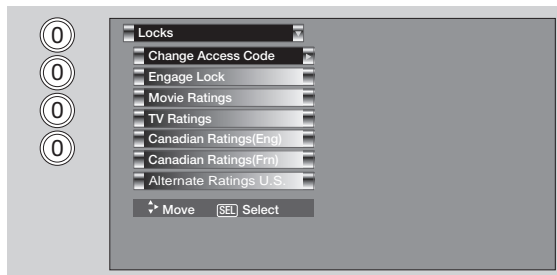
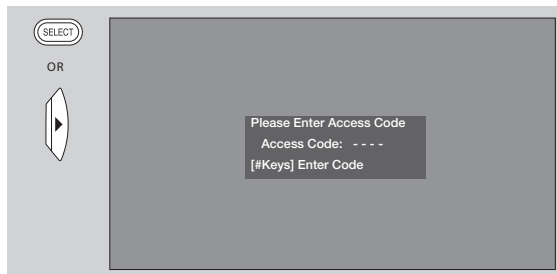

### Change Access Code

1. To change the **ACCESS CODE NUMBER**, select **CHANGE ACCESS CODE** to change the factory pr eset code (0000) to your preference.

If you forget your **ACCESS CODE NUMBER**, use the factory code **7777** to erase your key number. This will reset the access code number back to the factory pr eset (**0000**).

2. Enter a new four digit number.
3. Press **EXIT** to quit the menu or select **CHANGE ACCESS CODE** to return to the previous menu.

### Engage Lock

When **ENGAGE LOCK** is selected, **SET CHANNEL LOCK** and **SET FRONT PANEL LOCK** can be set individually.

When **SET CHANNEL LOCK** is turned on, the picture and sound for the chosen channel will be blocked out.

When **SET FRONT PANEL LOCK** is turned on, all buttons on the Front Panel will be deactivated, except the **POWER** button.

When **MOVIE RATINGS** is selected, you can block various types of movies and video tapes based on motion picture ratings. Picture-in-Picture will also be blocked automatically (see page 44).

When **TV RATINGS** is selected, various types of television programming based on a parental guide ratings will be blocked. Picture-in-Picture will also be blocked automatically (see page 45).

Use **CANADIAN RATINGS** to block various types of movies and television programs based on the two rating systems used in Canada that you feel may be inappropriate due to its content (see pages 46-47).

Use **ALTERNATE RATINGS (U.S.)** to block various types of movies and television pograms based on ratings systems used in U.S. that you feel may be inappropriate due to its content (see page 48).

**NOTE: The ALTERNATE RATINGS (US) option is available for Digital Channels only.**

# Locks

## Movie Ratings

Use Movie Ratings to prevent viewing of any movie that you feel may be inappropriate due to its content.

1. Use the CURSOR buttons ▲ or ▼ to select the **MOVIE RATING** category that you want to block.
2. Press **SELECT** to block the **MOVIE RATING** that you have selected. Once rating is selected, for example PG-13, all movies rated PG-13 and higher (R, NC-17, and X) will be blocked.
3. Press **EXIT** to quit the menu or select **MOVIE RATING** to return to the previous menu.

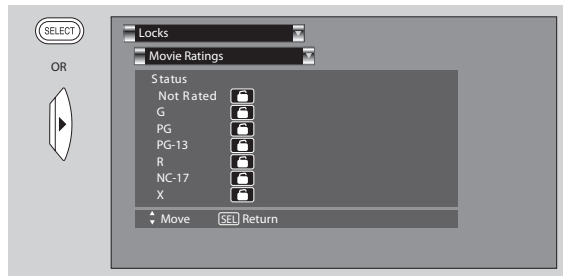
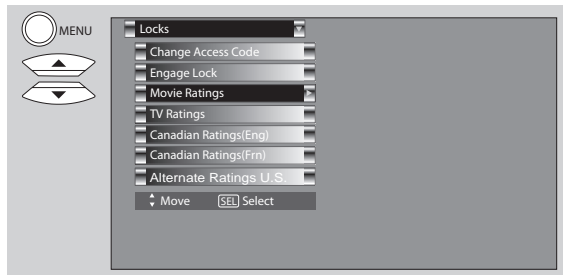

## Motion Picture Ratings Table

NOT RATED	Contains no rating. Not Rated (NR) and Not Applicable (NA) programs. Movie has not been rated or ratings do not apply.
G	General audiences. All ages admitted.
PG	Parental guidance suggested. Some material may not be suitable for children.
PG-13	Parents strongly cautioned. Some material may be inappropriate for children under 13.
R	Restricted. Under 17 requires accompanying parent or adult guardian.
NC-17	No one 17 and under admitted.
X	Adults only

**NOTE:** 1. A movie rating is dependent upon the movie that is viewed. If the movie does not carry a rating, the TV will not block it.  
 2. Blocking **NOT RATED** programs may block emergency programming, sports, news, public service announcements, religious programs and weather.

# Locks

## TV Ratings

Use **TV RATINGS** to prevent the viewing of any TV program that you feel may be inappropriate due to its content.

1. Use the **CURSOR** buttons ▲ or ▼ to select the **TV RATING** category that you want to block.
2. Press **SELECT** to block the **TV RATING** that you have selected.
3. Press **EXIT** to quit the menu or select **TV RATING** to return to the previous menu.

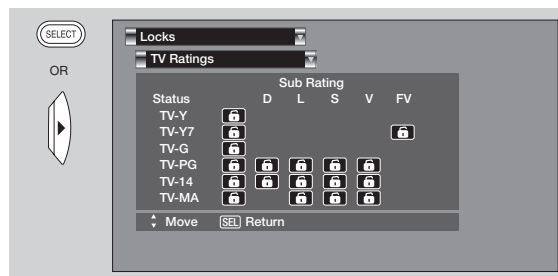

## TV Parental Guide Ratings Table

TV-Y	All children. The themes and elements in this program are specifically designed for a very young audience, including children from ages 2-6.
TV-Y7	Directed to older children. Themes and elements in this program may include mild physical or comedic violence, or may frighten children under the age of 7.
TV-G	General audience. It contains little or no violence, no strong language, and little or no sexual dialogue or situations.
TV-PG	Parental guidance suggested. The program may contain infrequent coarse language, limited violence, some suggestive sexual dialogue and situations.
TV-14	Parents strongly cautioned. This program may contain sophisticated themes, intense sexual situation, more intense violence and intensely suggestive dialogue.
TV-MA	Mature audiences only. This program may contain mature themes, indecent language, graphic violence, and explicit sexual content.
FV	Fantasy Violence
V	Violence
S	Sexual Situation
L	Adult Language
D	Sexually Suggestive Dialogue

- NOTE:** 1. If you Block **TV-14D**, you will still permit **TV-MA** programs; If you block **TV-14V**, you will automatically block **TV-MAV** programs, but you will still permit **TV-MALS** programs. This means that the TV will block violence in **TV-14** and higher (**TV-MA**), but not language and sex.
2. TV program ratings are dependent on the broadcaster. If the program is not rated, the TV will not block it.

# Locks

## Canadian Ratings (Eng)

Use **CANADIAN RATINGS (ENG)** to block any type of movie and television program in Canada that you feel might be inappropriate in its content.

1. Use the CURSOR buttons ▲ or ▼ to select the **CANADIAN RATINGS (ENG)** category that you want to block.
2. Press **SELECT** to block the **CANADIAN RATINGS (ENG)** that you have selected. Once rating is selected, for example **C8+**, all movies and television programs rated **C8+** and higher (**G**, **PG**, **14+** and **18+**) will be blocked automatically.
3. Press **EXIT** to quit the menu or select **CANADIAN RATINGS (ENG)** to return to the previous menu.

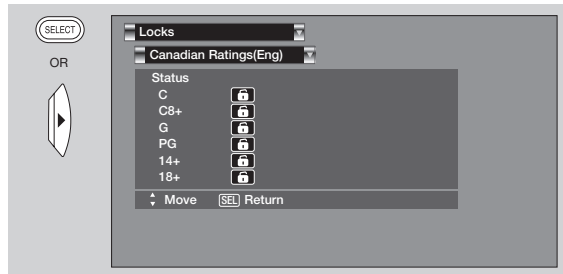

## Canadian Ratings English Table

C	Programming intended for children under age 8 - Violence Guidelines: Careful attention is paid to themes, which could threaten children's sense of security and well-being. There will be no realistic scenes of violence. Depictions of aggressive behaviour will be infrequent and limited to portrayals that are clearly imaginary, comedic or unrealistic in nature. Other Content Guidelines: There will be no offensive language, nudity or sexual content.
C8+	Programming generally considered acceptable for children 8 years and over to watch on their own - Violence Guidelines: Violence will not be portrayed as the preferred, acceptable, or only way to resolve conflict; or encourage children to imitate dangerous acts which they may see on television. Any realistic depictions of violence will be infrequent, discreet, of low intensity and will show the consequences of the acts. Other Content Guidelines: There will be no profanity, nudity or sexual content.
G	General Audience - Violence Guidelines: Will contain very little violence, either physical or verbal or emotional. Will be sensitive to themes which could frighten a younger child, will not depict realistic scenes of violence which minimize or gloss over the effects of violent acts. Other Content Guidelines: There may be some inoffensive slang, no profanity and no nudity.
PG	Parental Guidance - Programming intended for a general audience but which may not be suitable for younger children. Parents may consider some content inappropriate for unsupervised viewing by children ages 8-13. Violence Guidelines: Depictions of conflict and/or aggression will be limited and moderate; may include physical, fantasy, or supernatural violence. Other Content Guidelines: May contain infrequent mild profanity, or mildly suggestive language. Could also contain brief scenes of nudity.
14+	Programming contains themes or content which may not be suitable for viewers under the age of 14 - Parents are strongly cautioned to exercise discretion in permitting viewing by pre-teens and early teens. Violence Guidelines: May contain intense scenes of violence. Could deal with mature themes and societal issues in a realistic fashion. Other Content Guidelines: May contain scenes of nudity and/or sexual activity. There could be frequent use of profanity.
18+	Adult - Violence Guidelines: May contain violence integral to the development of the plot, character or theme, intended for adult audiences. Other Content Guidelines: May contain graphic language and explicit portrayals of nudity and/or sex.

# Locks

## Canadian Ratings (Frn)

Use **CANADIAN RATINGS (FRN)** to block Canadian French programs according to various program ratings that you feel might be inappropriate in its content.

1. Use the CURSOR buttons ▲ or ▼ to select the **CANADIAN RATINGS (FRN)** category that you want to block.
2. Press **SELECT** to block the **CANADIAN RATINGS (FRN)** that you have selected. Once rating is selected, for example **8 ANS+**, all movies and television programs rated **8 ANS+** and higher will be blocked automatically.
3. Press **EXIT** to quit the menu or select **CANADIAN RATINGS (FRN)** to return to the previous menu.

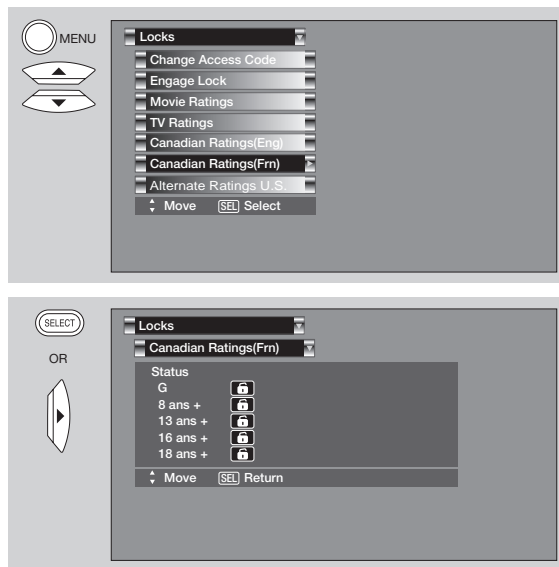

## Canadian Ratings French Chart

G	General - Programming intended for audiences of all ages. Contains no violence, or the violence content is minimal or is depicted appropriately with humor or caricature or in an unrealistic manner.
8 ans +	8 + General - Not recommended for young children - Programming intended for a broad audience but contains light or occasional violence that could disturb young children. Viewing with an adult is therefore recommended for young children (under the age of 8) who cannot differentiate between real and imaginary portrayals.
13 ans +	Programming may not be suitable for children under the age of 13 - Contains either a few violent scenes or one or more sufficiently violent scenes to affect them. Viewing with an adult is therefore strongly recommended for children under 13.
16 ans +	Programming is not suitable for children under the age of 16 - Contains frequent scenes of violence or intense violence.
18 ans +	Programming restricted to adults - Contains constant violence or scenes of extreme violence.

# Locks

## Alternate Ratings U.S.

Use Alternate Ratings to prevent viewing of any movie or program that you feel may be inappropriate due to its content. This feature will be available only for ATSC Digital signal. In case only NTSC analog signal is received this feature will be unavailable (grayed out).

In order to set the Alternate Ratings the ATSC Digital channel received must include Alternate Ratings data. To see if the channel has Alternate Ratings, press the INFO key on the R/C. See fig. (1) for reference.

Once the TV has received Alternate Ratings data, the Alternate Ratings US in the lock menu will become available.

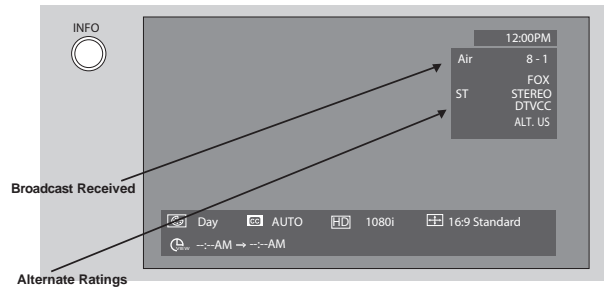
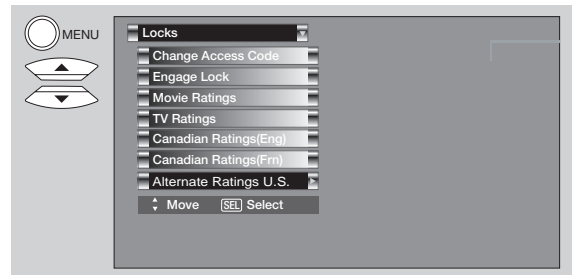
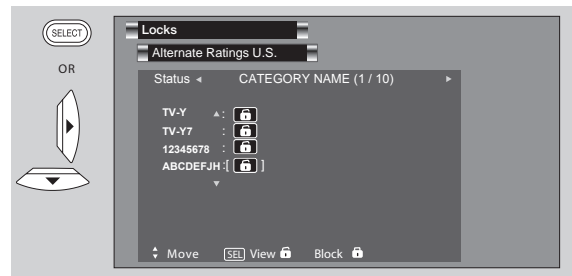

Fig. (1)

1. Use the CURSOR buttons ▼ or ▲ to select the **ALTERNATE RATING** category that you want to block.



2. Press **SELECT** to block the **ALTERNATE RATING** that you have selected. Once rating is selected, for example PG-13, all movies rated PG-13 and higher (R, NC-17 and X) will be blocked.



3. Press **EXIT** to quit the menu or select **ALTERNATE RATINGS** to return to the previous menu.

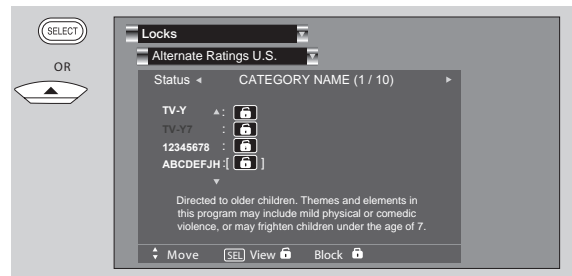

## Alternate Ratings (Example Only) :

G	General audiences. All ages admitted.
PG	Parental guidance suggested. Some material may not be suitable for children.
PG-13	Parents strongly cautioned. Some material may be inappropriate for children under 13.
R	Restricted. Under 17 requires accompanying parent or adult guardian.
NC-17	No one 17 and under admitted.
X	Adults only
Y	Adults only



**This page is left blank intentionally**

# Timers

## Timers

Select **TIMERS** to set your Clock, Sleep Timer, Event Timer and Day/Night Timer Recordings.

1. Use the **CURSOR** buttons ▲ or ▼ to highlight the function to be adjusted.
2. Press the **SELECT** button or **CURSOR** button ► to select.

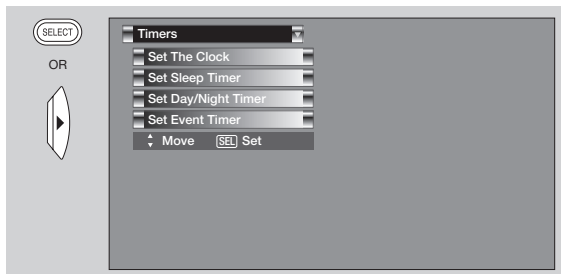

### Set The Clock

The Clock must be set before you can use the **SET EVENT TIMER** or **DAY/NIGHT TIMER** feature.

1. Use the **CURSOR** buttons ◀, ▶, ▲ or ▼ to highlight the chosen **TIME ZONE** settings.
2. Press the **SELECT** button to select. If you observe daylight savings, use **CURSOR** buttons to highlight **DAYLIGHT SAVING CORRECTION** and press the **SELECT** button to select.
3. Use the **CURSOR** buttons ◀, ▶, ▲ or ▼ to highlight the **CURRENT TIME** (hour and minute), **AM** or **PM**, **MONTH**, **DAY**, and **YEAR**.
4. Use the **CURSOR** buttons ▲ and ▼ to adjust settings.
5. Press the **SELECT** button to set the **TIME AND DATE**.
6. Press **EXIT** to quit the menu or select **SET THE CLOCK** to return to the previous menu.

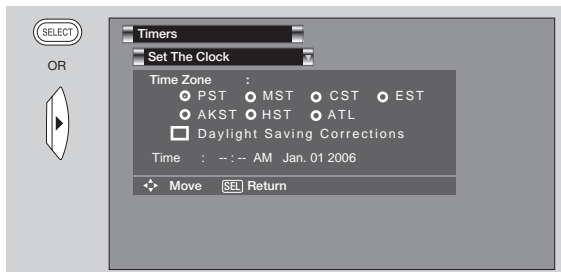

**NOTE:** 1. When **AUTOMATICALLY ADJUST CLOCK FOR DAYLIGHT SAVING CHANGES** is checked , the TV will automatically calculate the clock adjustment for Daylight Saving.  
2. The TV counts electrical pulses for regulating the **TIMERS**. When the power cord is unplugged then plugged in quickly, the clock is stopped momentarily and the **TIME** indication will become slow.

# Timers

## Set Sleep Timer

Select this feature to set your **SLEEP TIMER** from 30 minutes to 3 hours (30 minute increments).

1. Press the **CURSOR** buttons ◀ or ▶ repeatedly to set your Timer from **0:00**, **0:30**, **1:00**, **1:30**, **2:00**, **2:30** and **3:00**.

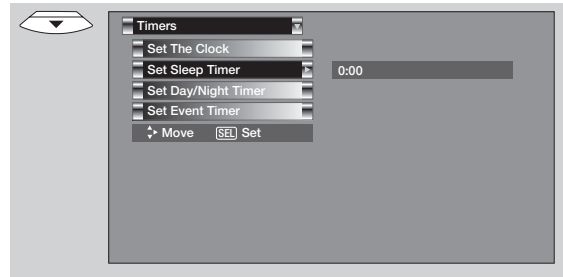

## Set Day/Night Timer

Select this feature to activate and set your TV's **DAY/NIGHT PICTURE MODE** automatically.

1. Use the **CURSOR** buttons ▲ or ▼ to highlight **SET DAY/NIGHT TIMER** settings.
2. Press the **SELECT** button or **CURSOR** button ▶ to select.
3. Use the **CURSOR** buttons ◀, ▶, ▲ or ▼ to select **DAY MODE ON** and to set its **TIMER**.
4. Use the **CURSOR** buttons ◀, ▶, ▲ or ▼ to select **DAY MODE OFF** and to set its **TIMER**.
5. Press **EXIT** to quit the menu or select **SET DAY/NIGHT TIMER** to return to the previous menu.

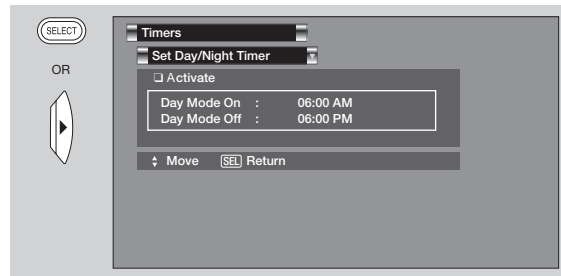
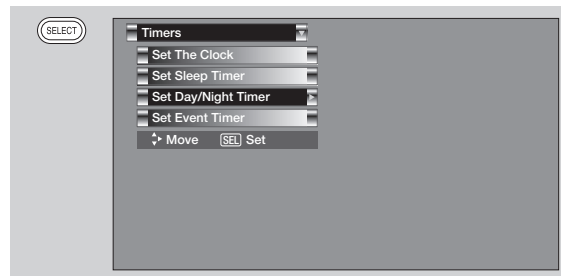

**NOTE:** When the clock is changed in the **SET THE CLOCK** function, this feature is disabled.

# Timers

## Set Event Timer

This function will automatically operate the Projection TV viewing reservation of a program. If the clock is not set, you can not use this function and the screen below will appear. The message on the screen will disappear after 3 seconds, then the screen automatically goes to the clock setup mode (see page 45).

1. Use the **CURSOR** buttons ▲ or ▼ to highlight **EVENT 1, EVENT 2, EVENT 3, EVENT 4** and then press the **SELECT** button to select.
2. Use the **CURSOR** buttons ►, ▲ or ▼ to highlight and select **START TIME HOUR/MINUTE**.
3. Use the **CURSOR** buttons ►, ▲ or ▼ to highlight and select **START TIME AM/PM**.
4. Use the **CURSOR** buttons ►, ▲ or ▼ to highlight and select **FINISH TIME HOUR/MINUTE**.
5. Use the **CURSOR** buttons ►, ▲ or ▼ to highlight and select **FINISH TIME AM/PM**.
6. Use the **CURSOR** button ► to highlight the **MONTH**.
7. Use the **CURSOR** button ▲ to select a **MONTH** or **CURSOR** button ▼ to select **DAILY, WEEKLY - SUNDAY TO MONDAY**. Use the **CURSOR** button ▲ to return to **MONTH**.
8. Use the **CURSOR** buttons ►, ▲ or ▼ to highlight and select the **DAY** of the **MONTH**.
9. Use the **CURSOR** buttons ►, ▲ or ▼ to highlight and select the **YEAR**.
10. Use the **CURSOR** buttons ►, ▲ or ▼ to highlight and select **CABLE** or **AIR**.
11. Use the **CURSOR** buttons ►, ▲ or ▼ to set the channel the TV will tune into.
12. Use the **SELECT** button to enable **EVENT SETTINGS**. A  in the box means it is enabled.

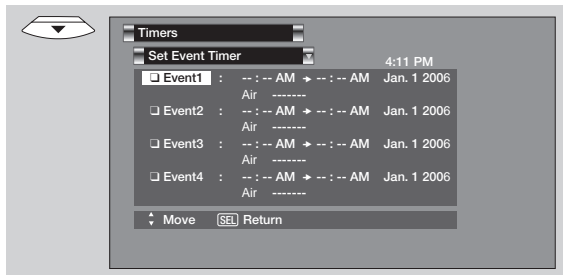
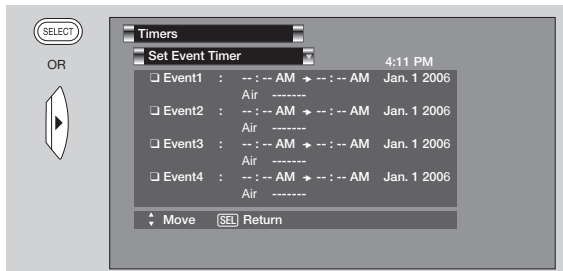
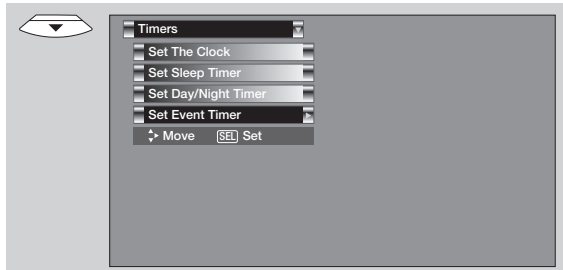

**NOTE:**

1. When the **INFO** button is pressed, the Event Timer Icon will only display the current date **ON/OFF** timer.
2. The **OFF TIMER** will only activate if the TV was turned on by the **ON TIMER** and no channel selection was made after this time. If you change the channel after the **ON TIMER** has been activated, the **OFF TIMER** will deactivate.
3. If no remote control button is pressed after viewing reservation is activated, the TV will automatically turn off after three hours. Therefore, do not **SET EVENT TIMER** for more than three hours if you do not plan to control your television with the remote control.
4. When the **CLOCK** is changed in the **SET THE CLOCK** function, events are disabled and the check mark is removed



**CAUTION:** Do not use your TV as a deterrent when away from home by using the **ON** and **OFF TIMERS**. For safety, the TV should be turned off when you are away from home.

# Setup

## Setup

Select **SETUP** when setting your TV up for the first time.

1. Use the **CURSOR** buttons ▲ or ▼ to highlight the function to be adjusted.
2. Press the **SELECT** button or **CURSOR** button ► to select.



### Magic Focus Tune Up

#### Auto Digital Convergence Adjustment

Please turn **ON** your television for at least 20 minutes before using this feature.

The **MAGIC FOCUS** button on control panel will not work when adjustment mode is set to **MANUAL** (see page 55 or 56).

Your **HITACHI** Projection TV has three color projection tubes: one for red, one for green, one for blue. When mixed together in the proper proportion, the output of these three color tubes can produce any color. To produce these colors, however, the beams must be precisely aligned over each other so that the colors can be mixed. The process of aligning these picture beams is called "convergence".

Over a period of time, the picture tubes can drift out of alignment due to normal bumps and vibrations or moving the TV. If you move your TV, or if, after a time, you notice color rings or halos around objects in the picture, you may want to converge (align) the colors.

Properly converged, the lines appear white, which is actually a combination of the outputs of the three color tubes. The output of the green tube is stationary. The outputs of the red and blue tubes can be adjusted. When properly aligned, the outputs of all three tubes should be directly over each other to produce the white lines.

To simplify convergence, **HITACHI** incorporates a function called **MAGIC FOCUS** located on the front control panel, which allows the TV to self-adjust. Press this **MAGIC FOCUS** button and the convergence self adjustment will start and this process will take approximately 20 seconds. If this button is pressed during this process, no change in picture quality will occur. After this 20 second self-adjust period, picture quality will be optimum (do not move the TV during self-adjust).

You may also select **MAGIC FOCUS TUNE UP** from the Setup Menu.



# Setup

- NOTE:** 1. Only a momentary press of the **MAGIC FOCUS** button is necessary to start **AUTO DIGITAL CONVERGENCE**. At any time during this convergence correction process, you may press the **MAGIC FOCUS** button to exit the **MAGIC FOCUS** mode. However, the convergence correction process needs to be completed to **SAVE** the new corrected convergence data.
2. When Auto  **AT TURN OFF** is selected, the TV will adjust itself after 90 days.

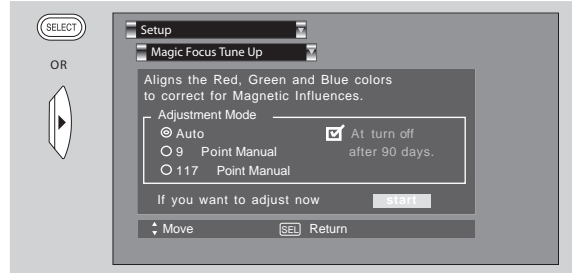
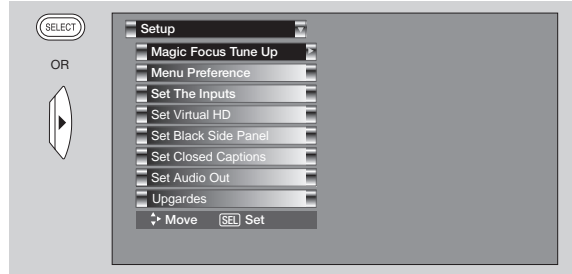
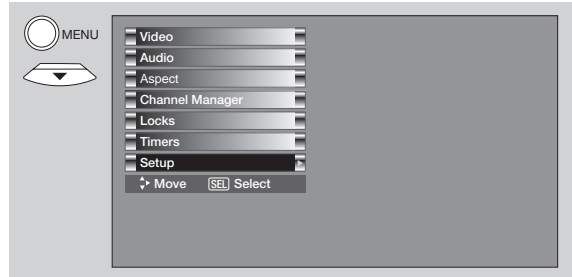

# Setup

## Manual Convergence Adjustment Mode (9 Point Manual Adjustment)

- NOTE:**
1. Please turn **ON** your television for at least 20 minutes before using this feature.
  2. **AUTO ADJUSTMENT MODE** is recommended. If convergence is still not acceptable, use the **MANUAL ADJUSTMENT MODE**.
  3. If **AUTO ADJUSTMENT MODE** is selected or the **MAGIC FOCUS** button is pressed, all manual adjust mode settings will be erased.

Using the Remote Control, select **SETUP, MAGIC FOCUS TUNE UP, MANUAL ADJUSTMENT MODE, 9 POINT MANUAL, START** to access convergence 9 point pattern. The adjustment point is indicated by the Adjustment Point Cursor.

### To Move Adjustment Point

To move the Adjustment Point Cursor using the **CURSOR** buttons, the Adjustment Point Cursor must be **WHITE**. Another way to move the Adjustment Point Cursor is to press the following buttons: **[2]** up, **[4]** left, **[5]** down, **[6]** right. If you use the number buttons while the adjustment point is **WHITE**, it will change to **RED**.

### To Change the Color of Adjustment Point

Press the **SELECT** button repeatedly (**WHITE-RED-BLUE-WHITE...**). **GREEN** color is fixed and cannot be adjusted.

### To Adjust the Convergence

Move the Adjustment Point Cursor to the point to be adjusted. Use the **CURSOR** buttons to match the **RED** and **BLUE** colors to **GREEN** (reference color). Properly aligned, all three colors should appear white.

If convergence is acceptable after **MANUAL CONVERGENCE** adjustment, press **EXIT** button to access menu mode.

1. Use the **CURSOR** buttons to highlight your chosen option.
2. Press the **SELECT** button to select.
3. Select **CANCEL** to cancel adjusted data and return to main picture.
4. Select **DONE** to save your adjustments and return to main picture.
5. Select **BACK** to return to the manual convergence adjustment mode.
6. Select **RESET** to recall the factory pre-set convergence data.

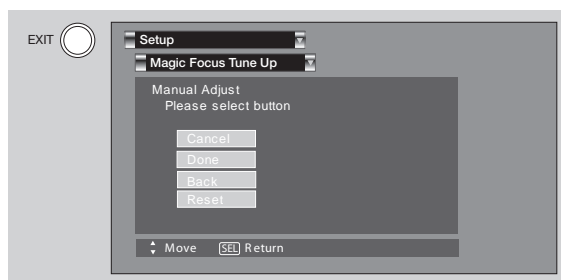
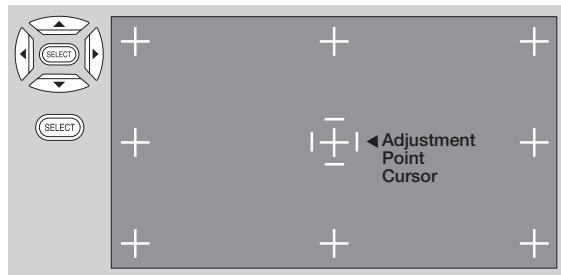
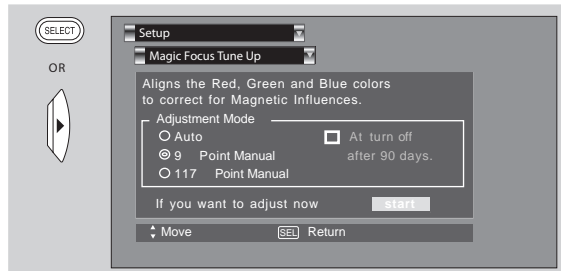
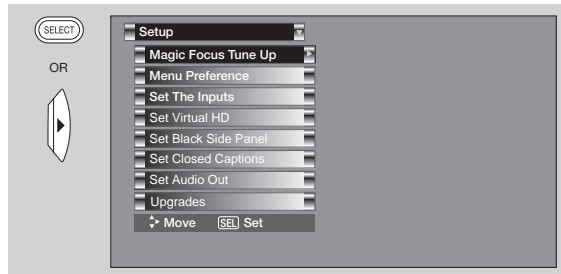
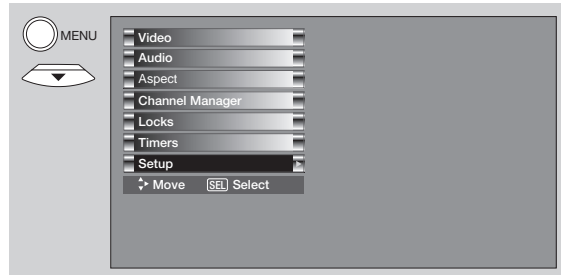

# Setup

## Manual Convergence Adjustment Mode (117 Point Manual Adjustment)

**NOTE:** 1. Please turn **ON** your television for at least 20 minutes before using this feature.  
2. **AUTO ADJUSTMENT MODE** is recommended. If convergence is still not acceptable, use the **MANUAL ADJUSTMENT MODE**.  
3. If **AUTO ADJUSTMENT MODE** is selected or the **MAGIC FOCUS** button is pressed, all manual adjust mode settings will be erased.

Using the Remote Control, select **SETUP**, **MAGIC FOCUS TUNE UP**, **MANUAL ADJUSTMENT MODE**, **117 POINT MANUAL**, **START** to access convergence 117 point pattern. The adjustment point is indicated by the Adjustment Point Cursor.

### To Move Adjustment Point

To move the Adjustment Point Cursor using the **CURSOR** buttons, the Adjustment Point Cursor must be **WHITE**. Another way to move the Adjustment Point Cursor is to press the following buttons: **[2]** up, **[4]** left, **[5]** down, **[6]** right. If you use the number buttons while the adjustment point is **WHITE**, it will change to **RED**.

### To Change the Color of Adjustment Point

Press the **SELECT** button repeatedly (**WHITE-RED-BLUE-WHITE...**). **GREEN** color is fixed and cannot be adjusted.

### To Adjust the Convergence

Move the Adjustment Point Cursor to the point to be adjusted. Use the **CURSOR** buttons to match the **RED** and **BLUE** colors to **GREEN** (reference color). Properly aligned, all three colors should appear white.

If convergence is acceptable after **MANUAL CONVERGENCE** adjustment, press **EXIT** button to access menu mode.

1. Use the **CURSOR** buttons to highlight your chosen option.
2. Press the **SELECT** button to select.
3. Select **CANCEL** to cancel adjusted data and return to main picture.
4. Select **DONE** to save your adjustments and return to main picture.
5. Select **BACK** to return to the manual convergence adjustment mode.
6. Select **RESET** to recall the factory pre-set convergence data.

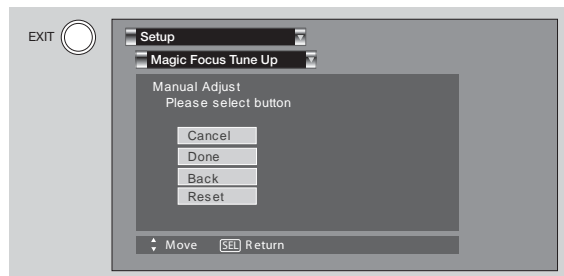
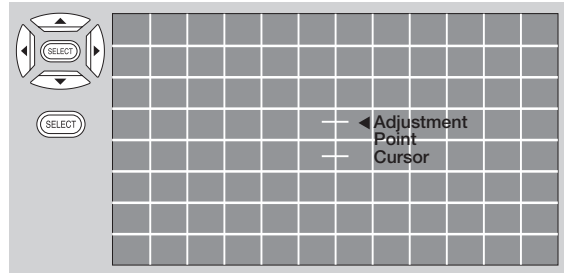
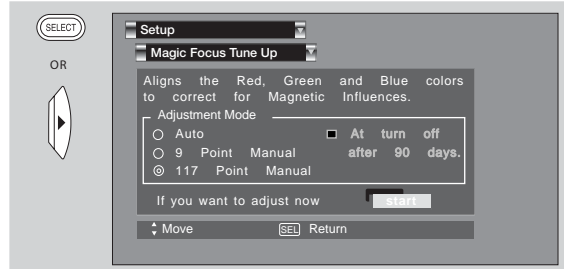



# Setup

## Menu Preference

This feature will allow you to select any one of three different languages for all on-screen displays.

## Set the Language

This function allows you to choose from three menu languages.

1. Use the **CURSOR** buttons ◀ or ▶ to highlight the language of your choice.
2. Press **EXIT** to quit menu or select **MENU PREFERENCE** to return to previous menu.

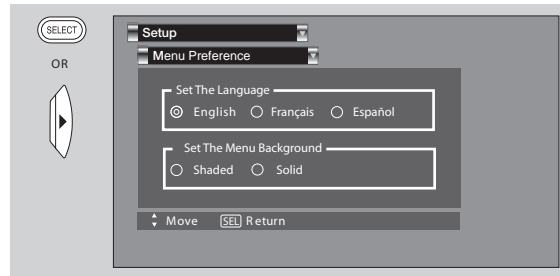
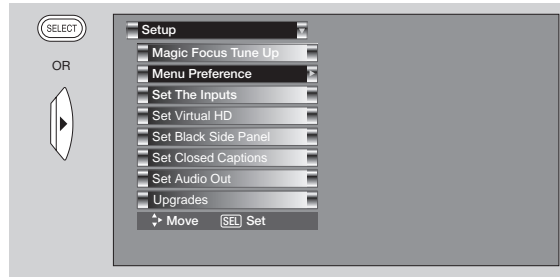

## Set the Menu Background

This function allows you to choose from two menu backgrounds.

1. Use the **CURSOR** buttons ◀ or ▶ to highlight **SET THE MENU BACKGROUND (SHADED OR SOLID)**.
2. Press **EXIT** to quit menu or **CURSOR** button ◀ to return to previous menu.
3. Select **SOLID** for a black background (no picture can be seen behind menu screen), or select **SHADED** for a light background.

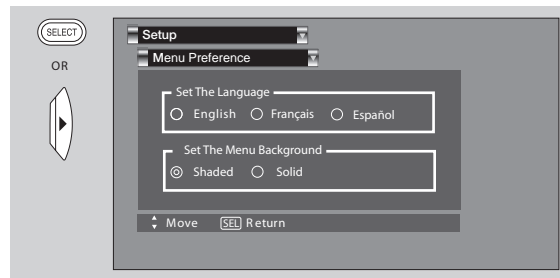

## Set The Inputs

Use this feature to give a name to any of the five video inputs. A named input is shown in the **INPUTS** menu.

1. Press the **CURSOR** buttons ◀, ▶, ▲ or ▼ to highlight the name of the video inputs.
2. Select from one of the following choices to set an input name:  
AVR,CAM,CBL,CBL2, DVD, DVD2, DVD3,LD  
VCR,VCR2,VCR3,PVR,PVR2,SAT,STB,STB2.

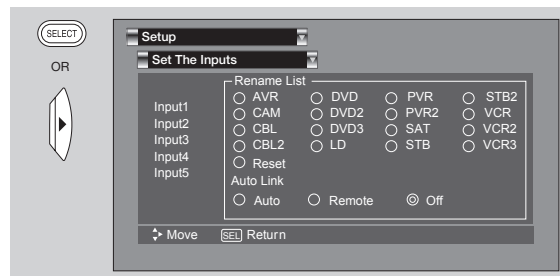
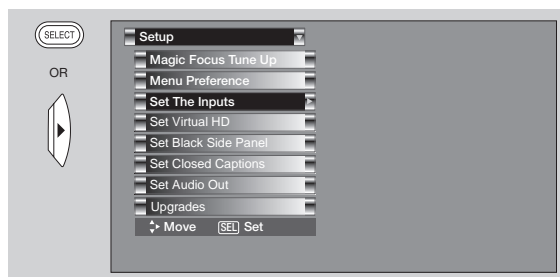

# Setup

## INPUT 3 Auto Link

Use this function to automatically turn the TV on and tune to **INPUT 3** when it detects a video signal to **INPUT 3**.

1. Use the **CURSOR** buttons ◀ or ▶ to highlight the **AUTO LINK** setting of your choice.
2. When **AUTO** is selected, the TV will turn on and tune to **INPUT 3** automatically, when the **INPUT 3** input device is turned on. This is convenient when you want to watch a movie with your VCR, laserdisc player or DVD player.
3. When **REMOTE** is selected, the TV will turn on and switch to **INPUT 3** automatically when the **INPUT 3** input device is turned on and the VCR, laserdisc, or DVD play button on your remote control is pressed. This is convenient when you want to record a movie with your VCR and watch it later.
4. Select **OFF** to disable this function.
5. Press **EXIT** to quit menu or select **AUTO LINK** to return to previous menu.

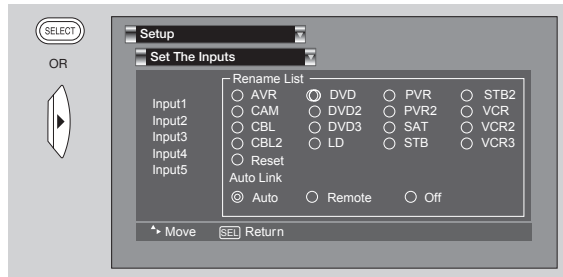

**NOTE:** 1. Once the TV has been turned on using the **AUTO LINK** feature, it must be reset before **AUTO LINK** is used again. To do this, turn your VCR, laserdisc or DVD player OFF. This feature is now reset and will turn on your TV as described above.  
2. When using **REMOTE** mode, any remote control button will substitute for your video input device play button. However, intended operation is for use with your VCR, laserdisc, or DVD play button.  
3. If no remote control button is pressed after the TV is turned on by **AUTO LINK**, the TV will automatically turn off after three hours.

## Set Virtual HD

Use this feature to select between 1080i and 540p scan mode.



When content from film is sent to your home it requires processing that can cause picture noise or distortion. Virtual HD technology reduces this noise to a minimum, recreating the smooth curves and high fidelity image of the original film source.

**NOTE:** VIRTUAL HD is not available (grayed out) in Digital Channels, 1080i input, HDMI and components.

## Set Black Side Panel

The **BLACK SIDE PANEL** function turns the gray side bars on/off when watching 4:3 signals in Standard mode. The top/bottom gray bar will appear in **SPLIT MODE PIP** and **SPLIT FREEZE**. The TV set will always return to "Set Black Side Panel -OFF" setting every time the TV is powered "OFF".

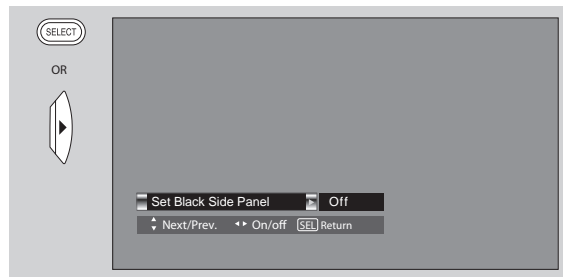

**NOTE:** To maximize operating life of the TV's picture tubes when watching 4:3 signal, Black Side Panel is cancelled at Power OFF. It is recommended to watch 4:3 signal with gray side bar.

# Setup

## Set Closed Captions

Closed Captions are the dialogue, narration, and/or sound effects of a television program or home video which are displayed on the TV screen. Your local TV program guide denotes these programs as **CC** or **□**.

1. Use the **CURSOR** buttons ◀, ▶, ▲ or ▼ to highlight and select the function to change.
2. Press **EXIT** to quit menu or **CURSOR** button ◀ to return to previous menu.

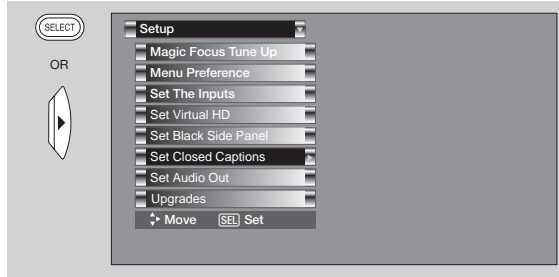

## Caption Display:

**ON/OFF** will turn the **CC** display on or off.  
**AUTO** will turn the **CC** display on when Mute/Soft Mute is on.

## Analog Caption:

Sets **CAPTIONS** for analog programs. This function will help choose available mode and channel.

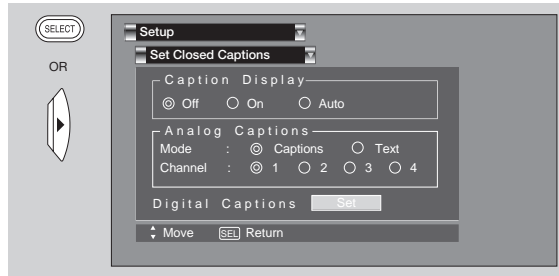

## Caption Mode:

**CAPTIONS** is for the program you are viewing. **TEXT** is for additional information such as news reports or a TV program guide. This information covers the entire screen and viewing the TV program is not possible. Text may not be available with every **CC** program.

## Channel:

- 1 is used for the primary language (usually English).
- 2 is sometimes used for a second language (may vary by region).
- 3 is sometimes used for a third language (may vary by region).
- 4 is sometimes used for a fourth language (may vary by region).

## Digital Captions

Set captions for digital programs. This function will help choose and set available language, font, size and style of digital captions.

1. Use the **CURSOR** buttons ◀, ▶, ▲ or ▼ to highlight and select **DIGITAL CAPTIONS** feature.
2. Press **EXIT** to quit menu or **CURSOR** button ◀ to return to previous menu.

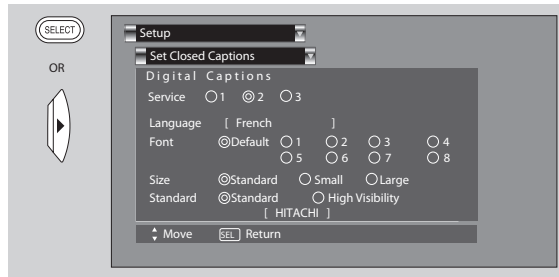

- NOTE:**
1. Some types of digital closed captions will not work with this TV.
  2. Caption Display will not work when viewing a 480p, 720p or 1080i input via the **COMPONENT: Y-PbPr** inputs.
  3. There are 2 types of Closed Captions in a Digital channel Analog & Digital captions
  4. Digital Captions Font Style are sometimes different from the Font Style of Analog Captions.
  5. Closed Caption and Digital Captions availability and content depends on the broadcaster. Closed Caption is available when Closed Caption icon is displayed on screen.
  6. Digital Captions Options will not be available (grayed out) when using analog channels.
  7. When ANALOG captions in a Digital channel are displayed and the ASPECT mode is changed; it will not change position of the captions in the picture.
  8. When DIGITAL captions in a Digital channel are displayed and the ASPECT mode is changed; it will change position of the picture and the captions ; so it may require to change the ASPECT mode in order to display the captions correctly.

## Set Audio Out

This feature will select the source of the Audio Output.

### Fixed:

Select **AUDIO OUT FIXED** to have the Audio at fixed volume.

### Variable :

Select **AUDIO OUT VARIABLE** to have Audio settings that can be controlled.

1. Use **CURSOR** buttons ▲ or ▼ to highlight the function to change.
2. Use the **SELECT** button to select the function.
3. Press **EXIT** to quit menu or **CURSOR** button ◀ to return to previous menu.

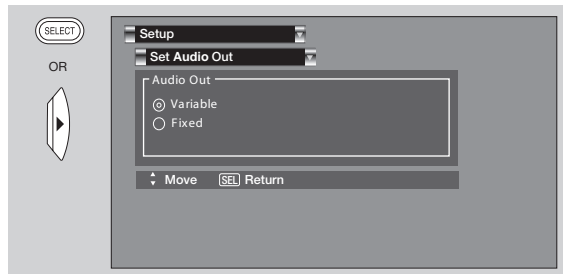
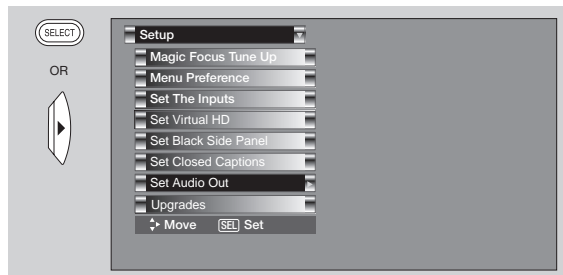

## Upgrades

It shows software information and easy upgrade procedure. This function allows the TV software to be upgraded by using a flash card (**MMC CARD**). If a future software upgrade is required for your TV, **HITACHI** will notify and provide you with a flash card. In order to receive written notification and the flash card, please complete and return the warranty card.

1. Insert **MMC CARD**
2. Press the **CURSOR** buttons ▲ or ▼ to highlight **UPGRADE NOW**.
3. Press the **SELECT** button to select and start upgrading.
4. Unplug the power cord when the upgrade is complete.

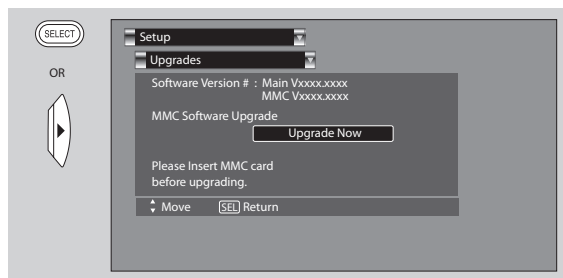
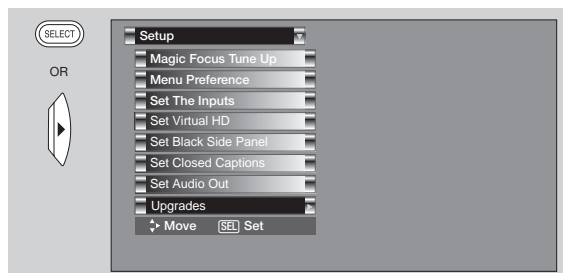

**NOTE:** 1. Any power interruption during the upgrade process will cancel the upgrade. When this happens, repeat the upgrade procedure.

2. The name of MMC Vxxx.xxxx upgrade will only appears when a MMC or SD card is inserted on the back of the TV ; then it will show the MMC Vxxx.xxxx file number.

# 57" Disassembly/Assembly Instructions

## IMPORTANT POINTS:

- (a) Do not attempt to perform this work by yourself.
- (b) Request an installation specialist to install this unit.
- (c) **HITACHI** assumes no responsibility or liability for injury/damage as a result of consumer installation and handling. Be advised that improper consumer installation/handling is not covered by manufacturer's warranty.
- (d) This Projection Television weighs 205 pounds and has many sensitive components.

## CAUTION: DISCONNECT UNIT FROM POWER SOURCE BEFORE DISASSEMBLY/ASSEMBLY

## DISASSEMBLY PROCEDURE

**NOTE:** Read all instructions and understand how to properly and safely disassemble and assemble unit

### STEP 1

Before disassembling this projection TV set, you must first remove the two screws that hold the speaker grille on each side of the TV(a)(b). Then by pulling outwards remove the speaker grille (c)(d). Remove the front decoration panels by unscrewing the 2 screws from each panel (left & right), see (e), then remove from the original position, see (f)(g).

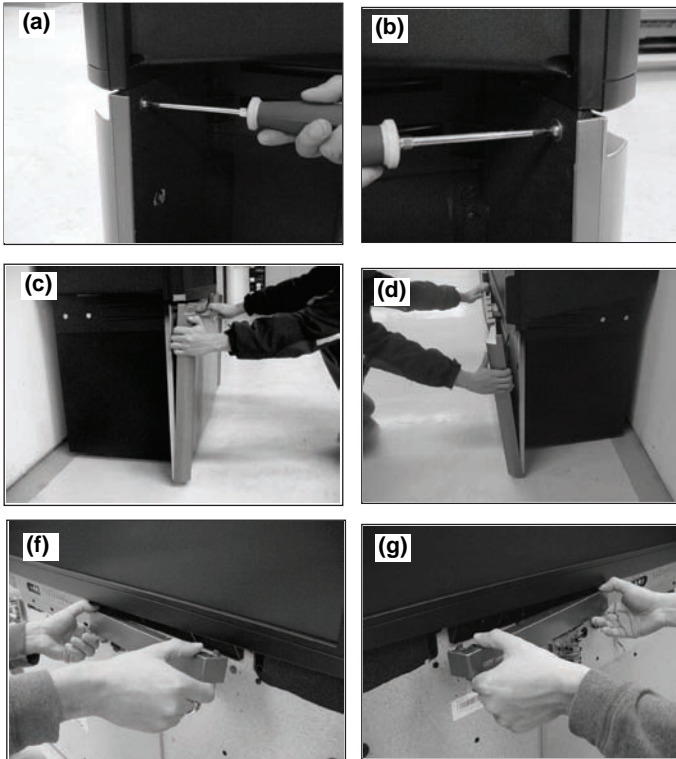

### STEP 2

Remove 4 screws (1, 2, 3, 4) that hold the screen frame to the cabinet on the Right side, see (a) and (b). Repeat to remove 4 screws on the Left side.

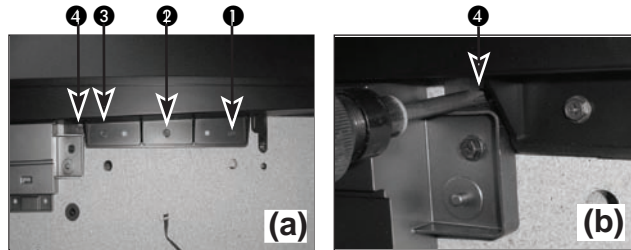

### STEP 3

Please remove the screw (1) below screen frame that hold the back cover to the cabinet as the arrow shows, see (a).

Please remove the screw (2) below screen frame that hold the back cover to the cabinet as the arrow shows, see (b).

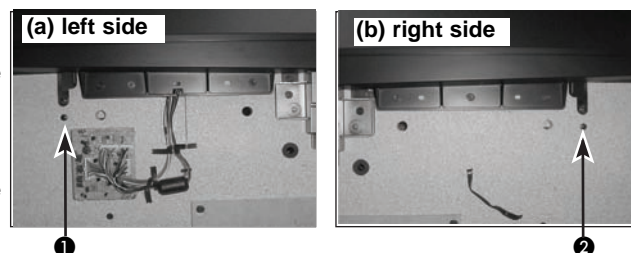

## 57" Disassembly/Assembly Instructions

### STEP 4

Locate the SENSOR PWB attached to the cabinet (a). Loosen the sensor wires from the plastic holders in order to remove the 3 wires that come from the screen, see (b). Disconnect the 3 connector wires as it shows on picture (c) & (d).

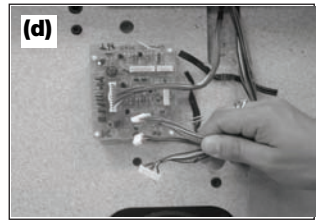
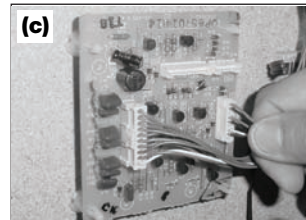
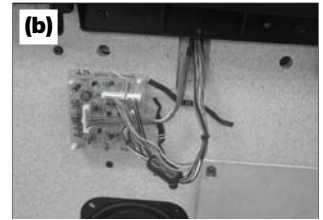
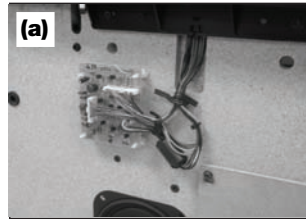

### STEP 5

Remove the joint connector bolts from each side of the back cover using the allen wrench that is provided inside of the instruction bag, see (a) and (b). In case that the screw is different type use the proper screwdriver to remove the screws.



### STEP 6

Remove from the back side of the TV set only the top 4 screws of the lower rear cover, see (b), as shown by the arrows on the rear cabinet label, see (a). Do not remove the rear cover board. Remove the (4) four side screws that hold the back cover to the cabinet, see (c) as shown on the label (a). Total of 8 screws will be removed.

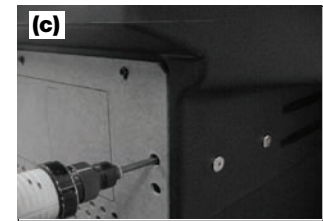
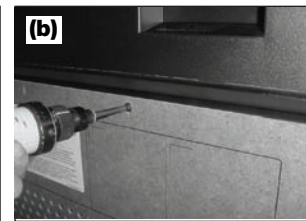
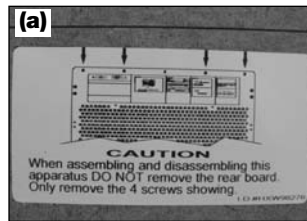

### STEP 7

**CAUTION:** When the TV is separated, the top portion weights 45 lbs. This task should be done by two persons when separating this TV.

This assembly contains fragile parts, such as glass and the viewing screen. Avoid any type of impact that could cause breakage of these components.

Remove top portion by grabbing the bottom corner of frame and the back cover, see (a)(b). Lift upwards, see (c)(d), gently place the top portion on the floor, see (e).



# 57" Disassembly/Assembly Instructions

## ASSEMBLY PROCEDURE

### STEP 8

To re-assemble the set, lift the top portion and align onto the bottom cabinet. Gently lower the top portion until it sits flush on the bottom.



### STEP 9

Re-install the joint connector bolts (2 pcs.) that were removed in step 5 of the disassembly.



### STEP 10

Re-install the top (4) four screws into the lower rear cover, see (a). Re-install the (4) four side screws that hold the back cover to the cabinet, see (b).

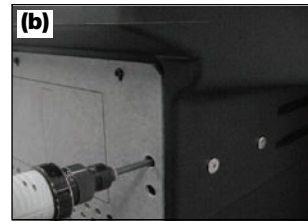

### STEP 11

Re-connect the sensor wires connector to the sensor sensor board, see (a). Hold the wires with the plastic holders ; so the wires do not become loose(b).

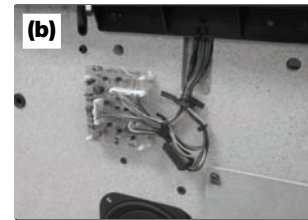
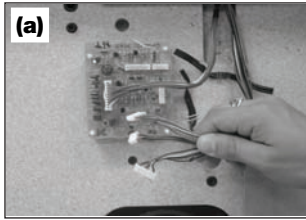

### STEP 12

Re-install 4 screws (1, 2, 3, 4) that hold the screen frame to the cabinet on the Right side, see (a) and (b). Repeat to re-install 4 screws on the Left side.

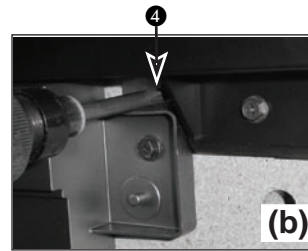
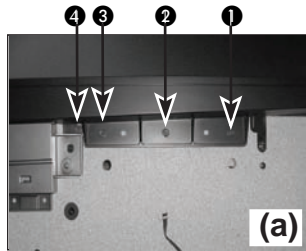

### STEP 13

Please re-install screw (1) below screen frame that hold the back cover to the cabinet as the arrows shows.

Please re-install screw (2) below screen frame that hold the back cover to the cabinet as the arrows shows.

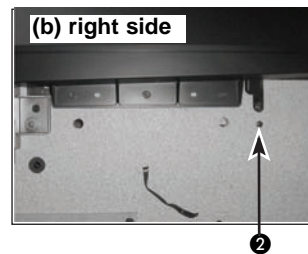
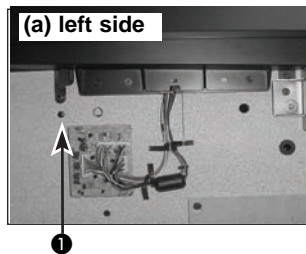

### STEP 14

Re-install both of the front decoration panels see (a) and reinstall the speaker grille by aligning it with the bottom cabinet (b), finally put the two screws of the speaker grille as seen on (c).

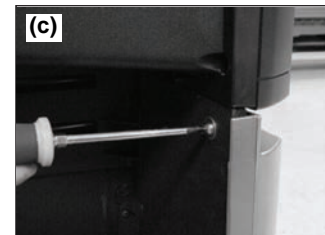

This completes the Disassembly and Assembly instructions.

**NOTE :** On step 5 and 8 it might be a different type of screw , so the Allen Key to remove the screws will not be included in the accessories.

# 65" Disassembly/Assembly Instructions

## IMPORTANT POINTS:

- (a) Do not attempt to perform this work by yourself.
- (b) Request an installation specialist to install this unit.
- (c) **HITACHI** assumes no responsibility or liability for injury/damage as a result of consumer installation and handling. Be advised that improper consumer installation/handling is not covered by manufacturer's warranty.
- (d) This Projection Television weighs 309 pounds and has many sensitive components.

## CAUTION: DISCONNECT UNIT FROM POWER SOURCE BEFORE DISASSEMBLY/ASSEMBLY

## DISASSEMBLY PROCEDURE

**NOTE:** Read all instructions and understand how to properly and safely disassemble and assemble unit

### STEP 1

Before disassembling this projection TV set, you must first remove the speaker grille by grabbing the sides and pulling left and right side see (a)(b). Remove the front decoration panels by unscrewing the 2 screws from each panel (left & right), see (c), then remove from the original position, see (d)(e).

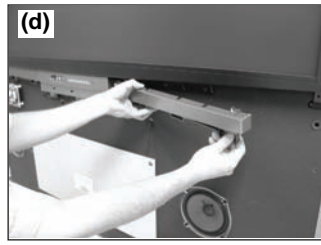
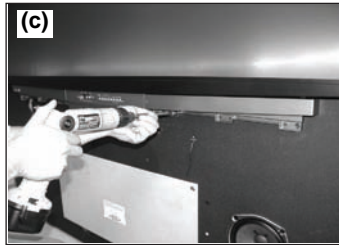

### STEP 2

Remove the 8 screws that hold the screen frame to the cabinet on the front side. DO NOT remove the right and left edge screen frame screws (c).

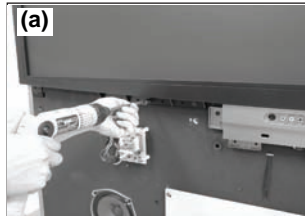

### STEP 3

Locate the SENSOR PWB attached to the cabinet (a). Loosen the sensor wires from the plastic holders in order to remove the 3 wires that comes from the screen, see (b). Disconnect the 3 connector wires as it shows on picture (c) & (d).

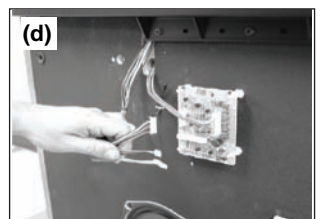
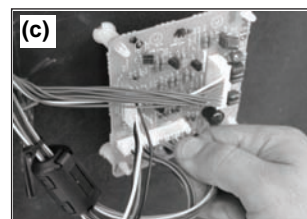
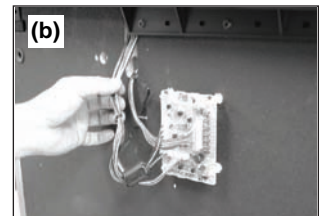
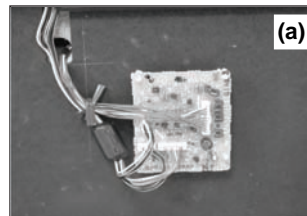



## 65" Disassembly/Assembly Instructions

### STEP 4

Remove the joint connector bolts from each side of the TV set using the allen wrench that is provided inside of the instruction bag, see (a) and (b).



### STEP 5

Remove from the back side of the TV set only the top 4 screws of the lower rear cover, see (b), as shown by the arrows on the rear cabinet label, see (a). Do not remove the rear cover board.

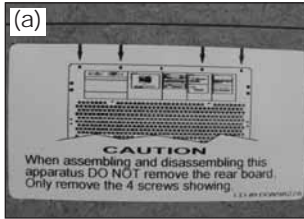

### STEP 6

**CAUTION:** When the TV is separated, the top portion weighs 112 lbs. This task should be done by two persons to carry top portion when separating this TV.

This assembly contains fragile parts, such as glass and the viewing screen. Avoid any type of impact that could cause breakage of these components. Remove top portion by grabbing the bottom corner of frame and the side of the TV, see (a)(b). Lift upwards, see (c)(d), gently place the top portion on the floor, see (e).

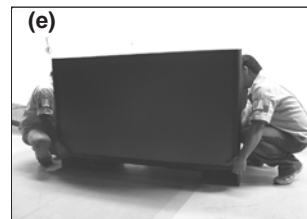

# 65" Disassembly/Assembly Instructions

## ASSEMBLY PROCEDURE

### STEP 7

To re-assemble the set, lift the top portion and align onto the bottom cabinet. Gently lower the top portion until it sits flush on the bottom.



### STEP 8

Re-install the joint connector bolts (4 pcs.) that were removed in step 4 of the disassembly.



### STEP 9

Re-install the top (4) four screws into the lower rear cover.



### STEP 10

Re-connect the sensor connector to the sensor board, see (a). Re-install the sensor box, see (b).

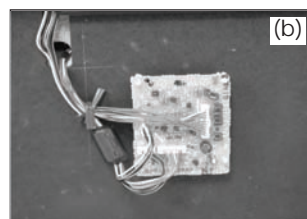
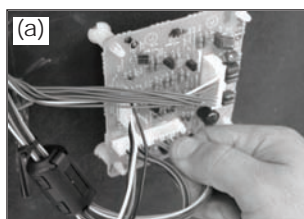

### STEP 11

Re-install the 8 screws that hold the frame to the cabinet on the front side of the TV.



### STEP 12

Re-install both of the front decoration panels, see (a) and (b). Re-install the speaker grille, aligning it with the bottom cabinet, see (c).



This completes the Disassembly and Assembly instructions.

# Equipment Care and Troubleshooting

## DO

- Dust the screen and cabinet with a soft cloth.
- Clean the screen with a soft cloth moistened in warm water and dry with a soft cloth. A mild soap may be used if the screen is extremely dirty.
- Place your Television away from extreme heat, humidity, and extremely dusty places.
- Remove the plug from the wall outlet if your Television will not be used for a long period of time, for instances, when you go on vacation.

## DO NOT

- Do not clean your screen or cabinet with strong cleaners, polishes or a chemically treated cloth.
- Do not place rubber or vinyl products or cellophane tape on your Television.
- Do not touch the screen too often.
- Do not subject the remote control to shocks such as dropping it on the floor, etc. Physical damage to the precision parts may result.
- Avoid placing the remote control or the Simple Remote Control in a high humidity place or getting it wet. Do not leave it on or near a heater. Excessive heat or moisture may cause the unit to cease operation.
- When the batteries run down, remote control operation will become erratic or possibly stop altogether. Replace the old batteries with two new "AA" size batteries as soon as possible to preserve the remote control precodes that were set for the devices. Pressing a remote control button with a "DEAD" battery might erase all precodes in memory. Do not use an old battery with a new battery.
- Exposure of the viewing screen to prolonged direct sunlight or heat may cause the screen to permanently warp, resulting in a distorted picture..

## TROUBLESHOOTING

HITACHI Projection Television incorporates advanced power surge protection technology designed to protect against component or circuit damage due to external or internal voltage power surges.

### IF YOUR TELEVISION SHOULD APPEAR TO HAVE A LOSS OF POWER, PLEASE FOLLOW THIS PROCEDURE:

1. Press the **POWER SWITCH (ON/OFF SWITCH)** once.
2. If there is still no power, wait 30 seconds and press the **POWER SWITCH** again.
3. If there is still no power, unplug the power cord from the wall. Wait 30 seconds and plug the power cord back in. Press the **POWER SWITCH** again.

This protective technology should provide for years of lasting entertainment from your **HITACHI** Projection Television.

SYMPTOMS	CHECK THESE ITEMS AND TRY THESE ADJUSTMENTS										
	Be sure external connection is correct	Be sure power cord is plugged in	Be sure TV is switched "ON"	Try another channel (station trouble)	Check antenna connections (back of TV)	Check antenna for broken lead-in wire	Adjust Contrast control	Adjust Brightness control	Adjust Color control	Adjust Tint control	Adjust Volume control
No Picture, no sound	●	●	●	●	●	●					
Sound OK, picture poor	●			●	●	●	●	●	●		
Picture OK, sound poor	●			●	●	●	●				●
Picture blurred	●			●	●	●	●				
Lines or streaks in picture				●	●	●	●				
Poor reception on some channels				●	●	●	●				
Picture rolls vertically				●			●				
No color	●			●	●	●	●			●	
Poor color	●			●	●	●	●			●	●

## Reception Problems

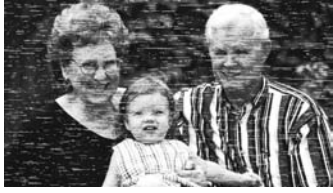

### **IGNITION NOISE:**

Black spots or horizontal streaks may appear, picture may flutter or drift. Usually caused by interference from automobile ignition systems, neon lamps, electrical drills, and other electrical appliances.



### **GHOSTS:**

Ghosts are caused by the television signal following two paths. One is the direct path and the other is reflected from tall buildings, hills or some other objects. Changing the direction or position of the antenna may improve reception. Ghosting may also be caused by defects in the antenna system such as unshielded leads or connecting several sets to the same antenna without using multiple antenna couplers.



### **SNOW:**

If your receiver is located in the fringe area of a television station where the signal is weak, your picture may be marred by the appearance of small dots. When the signal is extremely weak, it may be necessary to install a special antenna to improve the picture.

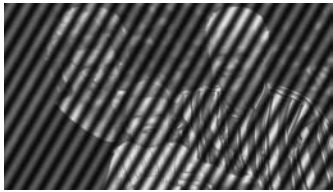

### **RADIO FREQUENCY INTERFERENCE:**

The interference produces moving ripples or diagonal streaks, and in some cases, causes loss of contrast in the picture.



### **BLOCK NOISE (DIGITAL INPUT):**

Fuzzy blocks may appear in some area or the whole area of the screen. This is usually caused by interference from automobile ignition systems, neon lamps, electrical drills, ghosting of the image and weak signals.

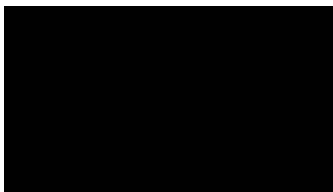



### **BLACK SCREEN:**

When using an antenna, weak signals will display a black screen. It may be necessary to upgrade your antenna.

**NOTE:** The TV set can generate sound distortion in external devices such as a radio. Please separate radio equipment from the TV set to a considerable distance.

# Features and Specifications

## FEATURES:

- Superfine Picture Quality; 1280 Line Horizontal Resolution
- Remote (Controls many PVR/VCR brands, cable boxes, satellite boxes, and other audio equipment).
- New Easy-to-Use (3-Language) On-Screen Menu
- Full Set of Input Jacks, including S-Video
- COMPONENT VIDEO: Y-P<sub>B</sub>/P<sub>R</sub>
- Velocity Modulation
- Six Aspect Modes
- Closed Caption Decoder
- 1-Tuner Picture in Picture
- Magic Focus (Auto Digital Convergence and 9-point/117-point Manual Adjustment)
- 1 Antenna Input (Either for Analog/Digital)
- Video Input Sensor
- HDMI (High Definition Multimedia Interface) (High Bandwidth Digital Content Protection V1.1 compatible).
- Digital Audio Output (Dolby® Digital)
- 3 Dimensional Y/C Comb Filter
- Compatible with 1080i, 720p, 480p and 480i input signals.
-  Technology.  
*Manufactured under license from Dolby Laboratories. "Dolby" and the double-D symbol are trademarks of Dolby Laboratories.*
-  Technology  
*HDMI, the HDMI logo and High-Definition Multimedia Interface are trademarks or registered trademarks of HDMI Licensing LLC.*

## INPUTS:

- Power Input.....AC 120V, 60Hz
- Stand-by Power.....0.4W
- Power Consumption - Refer to rear panel at the back of the TV.
- Antenna input impedance.....75 Ohm
- Channel coverage
  - VHF-Band .....2 – 13
  - UHF-Band.....14 – 69
  - CATV Band .....1 – 135
- Television System
  - NTSC Standard
  - ATSC Standard (8VSB)
- Video .....1.0Vp-p, 75 Ohm
- S-Video
  - Luminance (Y) .....1.0Vp-p, 75 Ohm
  - Chrominance (C) .....0.286Vp-p, 75 Ohm
- Component Video
  - Luminance (Y) .....1.0Vp-p, 75 Ohm
  - Chrominance (P<sub>B</sub>/P<sub>R</sub>) .....0.7Vp-p, 75 Ohm
- Audio input Impedance .....47k Ohm
- Average input level .....470mVrms
- HDMI.....HDMI 19 PIN

## OUTPUTS:

- Audio (Fixed) .....470mVrms, 1k Ohm
- S-Video
  - Luminance (Y) .....1.0Vp-p, 75 Ohm
  - Chrominance (C) .....0.286Vp-p, 75 Ohm
- Optical Out (Digital Audio) .....1 optical connector

## DIMENSIONS:

	51F59/A/J	57F59/A/J	65F59/A/J
Height (in.)	50-3/8	54-9/16	59-15/16
(mm)	1,279.0	1,385.6	1,521.0
Width (in.)	48-3/4	54	61
(mm)	1,239.0	1,372.0	1,549.0
Depth (in.)	21-7/8	23-5/16	25-3/8
(mm)	557	592.5	644
Weight (lbs.)	187.4	205	309
(kg.)	85	93	140

**NOTE:** Due to improvements, specifications in this operating guide are subject to change without notice.

### Lip Sync. Notice

The on-screen motion of an actor's lips or other moving object may not be in sync with the associated audio heard from the TV's speakers. This is caused by timing differences in the broadcast signal or DVD content and is not caused by a defect in the television.

# HITACHI

## Inspire the Next

### Service Hotline

To locate an authorized **HITACHI** service facility in the continental U.S.A. and Canada,

**DIAL TOLL FREE**

7 days a week, 24 hours a day

**1-800-HITACHI**

(1-800-448-2244)



**HITACHI AMERICA, LTD.**  
**HOME ELECTRONICS DIVISION**

**HITACHI** has made every effort to assure you hours of trouble free operation from your unit. However, should you require service, a network of **HITACHI** Authorized Service Facilities has been established in all 50 states and Puerto Rico. Each facility will provide you with convenient and expedient assistance. Our service hotline operator will direct you to the **HITACHI** Authorized Service Facility nearest you. Just present proof of purchase and/or delivery receipts to the Hitachi Authorized Service Facility, and service will be rendered in accordance with the terms of the limited warranty as stated on your warranty card or operating guide.

Should you have any questions regarding warranty, service, operation, or technical assistance, please contact:

**Hitachi America, LTD.**  
**Home Electronics Division**  
**900 Hitachi Way**  
**Chula Vista, CA 91914-3556**

**HITACHI CANADA, LTD.**  
**DIGITAL MEDIA DIVISION**

Should you have any questions regarding warranty, service, operation, or technical assistance, please contact:

**In Canada: 1-800-HITACHI (1-800-448-2244)**

Monday – Friday (EST).....9:00am – 7:00pm  
Saturday (EST) .....9:00am – 5:00pm

Look for your French Manual on the outside of the box. If the manual is missing, call **1-800-HITACHI (1-800-448-2244)** for a copy.

Pour de plus amples renseignements sur le service durant la période couverte par la garantie, sur le fonctionnement ou pour de l'assistance technique communiquez avec:

**Au Canada: 1-800-HITACHI (1-800-448-2244)**

Lundi - Vendredi L'EST .....9:00am – 7:00pm  
Samedi L'EST.....9:00am – 5:00pm

La version français de votre manual se trouve a l'exterieur de la boîte. Si le manuel est manquant, coposez le **1-800-HITACHI (1-800-448-2244)** pour obenir votre copie.

**HITACHI CANADA, LTD.**  
**2495 Meadowpine Blvd.**  
**Mississauga, Ontario L5N 6C3**

# End User Licence Agreement for HITACHI DTV Software

## END USER LICENSE AGREEMENT FOR HITACHI DTV SOFTWARE

**IMPORTANT – READ CAREFULLY:** This End User License Agreement for **HITACHI** DTV Software (this “Agreement”) is a legal agreement between you (“you” or “your”), in your capacity as the owner of a **HITACHI** brand digital television (the “DTV”), and **HITACHI** America, Ltd., Home Electronics Division (“**HITACHI**”). By using the DTV or the operating system software installed on the DTV (the “System Software”) or any Upgrade (as defined below, and together with the System Software, the “Software”), you agree to be bound by the terms and conditions of this Agreement. **IF YOU DO NOT AGREE TO BE BOUND BY THIS LICENSE AGREEMENT, DO NOT USE THE DTV OR THE SOFTWARE.**

1. **LICENSE GRANT. HITACHI** grants to you, for the life of the DTV, a non-exclusive, non-transferable, revocable license to install and use one copy of the Software on the DTV, subject to the following limitations and restrictions:
  - a. You may not share, duplicate, republish or redistribute the Software;
  - b. You may not resell, rent, lease, sublicense, gift, loan, assign or otherwise transfer the Software or any of your rights under this Agreement;
  - c. You may not modify, adapt, translate, reverse engineer, decompile, disassemble or make derivative works from the Software or use the Software in combination with any non-Hitachi software; and
  - d. You may not use the Software for any commercial purpose.
2. **VIOLATIONS; INDEMNITY.** You understand and agree that your use of the Software in any manner except as permitted under this Agreement could constitute a serious crime and could subject you to damages and an award to **HITACHI** of attorneys’ fees in connection with your violation of this Agreement. You further understand that you may be held legally responsible for any copyright infringement or other violation of intellectual property rights caused or facilitated by your failure to abide by the terms of this Agreement. You agree to defend, indemnify and hold **HITACHI** and its parent and affiliate companies harmless from and against any and all liability resulting from any breach by you of this Agreement.
3. **INTELLECTUAL PROPERTY.** The Software is protected by federal copyright laws, international copyright treaties and other intellectual property laws and treaties. The Software is licensed, not sold, to you. All right, title and interest in and to the Software and any intellectual property associated therewith, including any accompanying printed materials, shall belong to **HITACHI** and its licensors and suppliers. Except as expressly provided herein, neither **HITACHI** nor any of its licensors or suppliers grants to you under this Agreement any express or implied right in or to any patents, copyrights, trademarks, trade secrets or other intellectual property. All right, title and interest in and to the intellectual property rights associated with any content that is accessible through use of the Software shall belong to the applicable content owners and may be protected by copyright or other intellectual property laws and treaties. This Agreement grants you no rights to use such content. Any rights of **HITACHI** not expressly granted to you hereunder are reserved expressly by Hitachi.
4. **SOFTWARE UPGRADES.** In the future, **HITACHI** may release or make available one or more upgrades to the System Software (each, an “Upgrade”). You understand and agree that if you decide to install or use any Upgrade, your installation and use of such Upgrade and/or any other software or intellectual property **HITACHI** may provide in connection therewith shall be governed by the terms and conditions of this Agreement, except to the extent that **HITACHI** provides different or supplementary license terms or conditions that accompany such Upgrade or other software or intellectual property. In the event **HITACHI** provides you with a “flash card” or other media to effect or facilitate an Upgrade, you understand and acknowledge that your failure to return such flash card or other media to **HITACHI** as **HITACHI** may require could result in **HITACHI** placing your name and your DTV’s serial number on a “No Further Upgrades” list, which will prohibit you from receiving any subsequent Upgrades **HITACHI** may later release or make available. **IF YOU DO NOT AGREE WITH ALL THE TERMS AND CONDITIONS OF THIS AGREEMENT OR ALL THE TERMS AND CONDITIONS OF ANY DIFFERENT OR SUPPLEMENTARY LICENSE THAT MAY ACCOMPANY SUCH UPGRADE, (A) DO NOT USE ANY HITACHI-PROVIDED FLASH CARD OR OTHER MEDIA, (B) DO NOT PERFORM INSTALL ANY HITACHI-PROVIDED UPGRADE SOFTWARE ON YOUR DTV, AND (C) PROMPTLY RETURN SUCH FLASH CARD OR OTHER MEDIA TO HITACHI.**
5. **EXPORT RESTRICTIONS. HITACHI** is licensing the Software for use within North America only. You agree that you will not export or re-export the Software. You specifically agree not to export or re-export the Software: (i) to any country to which the U.S. has embargoed or restricted the export of goods or services, which currently include, but are not necessarily limited to Cuba, Iran, Libya, North Korea, Sudan and Syria, or to any national of any such country, wherever located, who intends to transmit or transport the Software back to such country; (ii) to any person or entity who you know or have reason to know will utilize the Software in the design, development, or production of nuclear, chemical, or biological weapons; or (iii) to any person or entity who has been prohibited from participating in U.S. export transactions by any federal agency of the U.S. government. You warrant and represent that neither the U.S. Bureau of Industry and Security nor any other U.S federal Agency has suspended, revoked, or denied your export privileges.
6. **NO WARRANTIES.** The software is provided to you in “as is” condition and **HITACHI** makes no warranties of any kind whatsoever regarding the software and, to the maximum extent permitted by law, hereby expressly disclaims all warranties of any kind whatsoever, express or implied, with respect to the software. All implied warranties, including without limitation, the implied warranties of non-infringement, merchantability and fitness for a particular purpose are hereby expressly disclaimed by **hitachi** to the maximum extent permitted by law.
7. **LIMITATION OF LIABILITY.** To the maximum extent permitted by applicable law, **HITACHI**, its licensors, suppliers, parent companies, affiliates, subsidiaries, employees and agents shall not under any circumstances be liable to you or any third parties for any damages of any nature arising in any way from this agreement, your use of the software or otherwise, whether indirect, special, incidental, consequential or otherwise, including, without limitation, any claims for lost profits, lost good will, lost data, business interruption, procurement of substitute goods or services, or expenditures made or committed for in reliance on the continuation of this agreement, even if advised in advance of the possibility of such damages.
8. **NO FAILURE OF ESSENTIAL PURPOSE.** You agree that neither **HITACHI’S** breach of this agreement nor its failure to repair a defect, error or bug in the software shall constitute a failure of the essential purpose of this agreement.
9. **CRYPTOGRAPHIC SOFTWARE.** The software contains software developed by the openssl project, including cryptographic software written by eric young (the “cryptographic software”). The cryptographic software is provided by the openssl project in “as is” condition and any express or implied warranties, including but not limited to, the implied warranties of merchantability and fitness for a particular purpose are hereby expressly disclaimed to the maximum extent permitted by law. In no event shall the openssl project, its contributors, **HITACHI** or any of its parent or affiliate companies be liable for any direct, indirect, incidental, special, exemplary, or consequential damages (including, but not limited to, procurement of substitute goods or services; loss of use, data, or profits; or business interruption) however caused and on any theory of liability, whether in contract, strict liability, or tort (including negligence or otherwise) arising in any way out of the use of the software or the cryptographic software, even if advised in advance of the possibility of such damages.
10. **TERMINATION. HITACHI** may terminate this Agreement immediately at any time by providing notice to you.
11. **GOVERNING LAW; SEVERABILITY.** This Agreement will be governed by the laws of the State of New York, and you consent to the exclusive jurisdiction and venue in the federal courts sitting in the Southern District of New York, unless no federal subject matter jurisdiction exists, in which case you consent to the exclusive jurisdiction and venue in the Borough of Manhattan, New York, USA.

<b>A</b>			
Accessories .....	4	Closed Captions	
Antennas (Connecting).....	5	Analog Captions .....	59
Aspect Ratio.....	20	Digital Captions.....	59
Audio		Color Temperature.....	35
Languages .....	39	Color.....	34
Dolby Digital.....	39	Contrast.....	34
DRC (Dynamic Range		Convergence (see Magic Focus)	
Compression).....	39	<b>D</b>	
Audio Settings.....	37	Date.....	50
Audio Source.....	38	Daylight Saving Correction ...	50
Auto Noise Cancel .....	38	Disassembly/Assembly	
		Instructions (57") .....	61-63
		Disassembly/Assembly	
		Instructions (65") .....	64-66
<b>B</b>		<b>E</b>	
Balance .....	37	Event Timer .....	52
Bass .....	37	<b>G</b>	
Black Enhancement .....	35	Guide Button.....	7, 21
Brightness .....	34	<b>H</b>	
<b>C</b>		HDMI .....	10, 12, 16
Channel Manager.....	41	<b>I</b>	
Auto Channel Scan .....	42	Input button.....	7, 21
Channel List .....	42	<b>L</b>	
Signal Meter.....	41	Language	
Channel Manager.....	41	Menu Language .....	57
Auto Channel Scan .....	42	Audio Language.....	39
Channel List .....	42	Locks	
Signal Meter.....	41	Change Access Code.....	43
Clock		Channel Lock.....	43
Time .....	50	Front Panel Lock.....	43
Time Zone .....	50	Movie Ratings .....	44
Date.....	50	TV Ratings.....	45
		TV Ratings	
		(Canadian - English) .....	46
		TV Ratings	
		(Canadian - French).....	47
		Loudness.....	38
		<b>M</b>	
		Magic Focus	
		Auto Convergence .....	53
		Manual Convergence ...	55-56
		Menu Preference	
		Language .....	57
		Background.....	57
		Monitor Out.....	60
		<b>P</b>	
		Pause	
		(Freeze) Button .....	7, 19, 24
		Perfect Volume .....	38
		Picture Mode.....	34
		Picture-in-Picture (PIP) ...	23-25
		Picture-outside-Picture (POP)..	23
		<b>R</b>	
		Remote Control	
		Functions .....	18-31
		Programming Codes ...	28-31
		Installing Batteries .....	4
		<b>S</b>	
		Sharpness .....	34
		Speakers .....	13
		<b>T</b>	
		Timers .....	50-52
		Time.....	50
		Tint .....	34
		Treble.....	37
		<b>U</b>	
		Upgrades.....	60
		<b>V</b>	
		Video Settings.....	34-36
		Volume .....	7, 22





## Notes

# HITACHI

Inspire the Next

## Free Manuals Download Website

<http://myh66.com>

<http://usermanuals.us>

<http://www.somanuals.com>

<http://www.4manuals.cc>

<http://www.manual-lib.com>

<http://www.404manual.com>

<http://www.luxmanual.com>

<http://aubethermostatmanual.com>

Golf course search by state

<http://golfingnear.com>

Email search by domain

<http://emailbydomain.com>

Auto manuals search

<http://auto.somanuals.com>

TV manuals search

<http://tv.somanuals.com>