

# HITACHI

## PROJECTION COLOR TV

**57T500**  
**65T500**

**57X500**  
**65X500**

## OPERATING GUIDE



**IMPORTANT SAFETY INSTRUCTIONS** 2-3

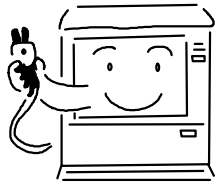

**FIRST TIME USE** 4-22



**THE REMOTE CONTROL** 23-44



**ON-SCREEN DISPLAY** 45-71

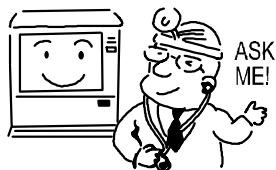

**USEFUL INFORMATION INDEX** 72-78

As an ENERGY STAR® Partner, Hitachi, Ltd. has determined that this product meets the ENERGY STAR® guidelines for energy efficiency.





## SAFETY POINTS YOU SHOULD KNOW ABOUT YOUR HITACHI TELEVISION

Our reputation has been built on the quality, performance, and ease of service of HITACHI televisions.

Safety is also foremost in our minds in the design of these units. To help you operate these products properly, this section illustrates safety tips which will be of benefit to you. Please read it carefully and apply the knowledge you obtain from it to the proper operation of your HITACHI television.

Please fill out your warranty card and mail it to HITACHI. This will enable HITACHI to notify you promptly in the improbable event that a safety problem should be discovered in your product model.

Follow all warnings and instructions marked on this television.

	<p><b>CAUTION</b></p> <p>RISK OF ELECTRIC SHOCK DO NOT OPEN</p>			<p>The lightning flash with arrowhead symbol, within an equilateral triangle, is intended to alert the user to the presence of uninsulated "dangerous voltage" within the product's enclosure that may be of a sufficient magnitude to constitute a risk of electric shock to persons.</p>
<p>CAUTION: TO REDUCE THE RISK OF ELECTRIC SHOCK, DO NOT REMOVE COVER (OR BACK). NO USER SERVICEABLE PARTS INSIDE. REFER SERVICING TO QUALIFIED SERVICE PERSONNEL.</p>				<p>The exclamation point within an equilateral triangle, is intended to alert the user to the presence of important operating and maintenance (servicing) instructions in the literature accompanying the appliance.</p>

**WARNING:**  
TO PREVENT FIRE OR SHOCK HAZARD, DO NOT EXPOSE THIS TELEVISION TO RAIN OR MOISTURE.

**NOTE:**

- There are no user serviceable parts inside the television.
- Model and serial numbers are indicated on back side of the television.

**CAUTION:** Adjust only those controls that are covered in the instructions, as improper changes or modifications not expressly approved by HITACHI could void the user's authority to operate the television.



**MODIFICATIONS:** The FCC requires the user to be notified that any changes or modifications made to this device that are not expressly approved by Hitachi America, Ltd. Home Electronics Division may void the user's authority to operate the equipment.

**POWER SOURCE**

**THIS TELEVISION IS DESIGNED TO OPERATE ON 120 VOLTS 60Hz, AC CURRENT. INSERT THE POWER CORD INTO A 120 VOLT 60Hz OUTLET.**

**TO PREVENT ELECTRIC SHOCK, DO NOT USE THE TELEVISION'S (POLARIZED) PLUG WITH AN EXTENSION CORD, RECEPTACLE, OR OTHER OUTLET UNLESS THE BLADES AND GROUND TERMINAL CAN BE FULLY INSERTED TO PREVENT BLADE EXPOSURE.**

**NEVER CONNECT THE TELEVISION TO 50Hz, DIRECT CURRENT, OR ANYTHING OTHER THAN THE SPECIFIED VOLTAGE.**

**NOTE:** This television receiver will display television closed captioning, ( or ) in accordance with paragraph 15.119 of the FCC rules.

 **CAUTION:** Never remove the back cover of the television as this can expose you to very high voltages and other hazards. If the television does not operate properly, unplug the television and call your authorized dealer or service center.

# IMPORTANT



## Read before operating equipment

Follow all warnings and instructions marked on this television.

1. Read these instructions.
2. Keep these instructions.
3. Heed all warnings.
4. Follow all instructions.
5. Do not use this apparatus near water.
6. Clean only with a dry cloth.
7. Do not block any ventilation openings. Install in accordance with the manufacturer's instructions.
8. Do not install near any heat sources such as radiators, heat registers, stoves, or other apparatus (including amplifiers) that produce heat.
9. Do not defeat the safety purpose of the polarized or grounding-type plug. A polarized plug has two blades with one wider than the other. A grounding type plug has two blades and a third grounding prong. The wide blade or the third prong are provided for your safety. If the provided plug does not fit into your outlet, consult an electrician for replacement of the obsolete outlet.
10. Protect the power cord from being walked on or pinched particularly at plugs, convenience receptacles, and the point where they exit from the apparatus.
11. Only use the attachments/accessories specified by the manufacturer.

12.  Use only with the cart, stand, tripod, bracket, or table specified by the manufacturer, or sold with the apparatus. When a cart is used, use caution when moving the cart/apparatus combination to avoid injury from tip-over.

13. Unplug this apparatus during lightning storms or when unused for long periods of time.
14. Refer all servicing to qualified service personnel. Servicing is required when the apparatus has been damaged in any way, such as power-supply cord or plug is damaged, liquid has been spilled or objects have fallen into apparatus, the apparatus has been exposed to rain or moisture, does not operate normally, or has been dropped.

**Do not place any objects on the top of the television which may fall or cause a child to climb to retrieve the objects.**

**Projection TV's are heavy and can mark or damage floor surfaces (especially wood flooring) if moved improperly. Do not slide or force TV into position. Always roll TV allowing casters at bottom of unit to help steer and position the TV.**

### PREVENTION OF SCREEN BURN

This Wide Screen TV is designed to display wide screen pictures. Images should be viewed mostly in wide screen format or zoomed to fill the screen with moving pictures. Use of side panels, top and bottom panels of standard picture formats should only be 15% of your total viewing time to prevent uneven aging of the phosphors. Phosphors in the lighted area of the picture will age more rapidly than the gray areas. Continuous on-screen displays such as video games, stock market quotations, computer generated graphics, and other fixed (non-moving) patterns can cause permanent damage to television receivers. Such "SCREEN BURNS" constitute misuse and are **NOT COVERED** by your HITACHI Factory Warranty.

### PUBLIC VIEWING OF COPYRIGHTED MATERIAL

Public viewing of programs broadcast by TV stations and cable companies, as well as programs from other sources, may require prior authorization from the broadcaster or owner of the video program material.

15. Televisions are designed to comply with the recommended safety standards for tilt and stability. Do not apply excessive pulling force to the front, or top, of the cabinet which could cause the product to overturn resulting in product damage and/or personal injury.
16. Follow instructions for wall, shelf or ceiling mounting as recommended by the manufacturer.
17. An outdoor antenna should not be located in the vicinity of overhead power lines or other electrical circuits.
18. If an outside antenna is connected to the receiver be sure the antenna system is grounded so as to provide some protection against voltage surges and built up static charges. Section 810 of the National Electric Code, ANSI/NFPA No. 70-1984, provides information with respect to proper grounding for the mast and supporting structure, grounding of the lead-in wire to an antenna discharge unit, size of grounding connectors, location of antenna-discharge unit, connection to grounding electrodes and requirements for the grounding electrode.

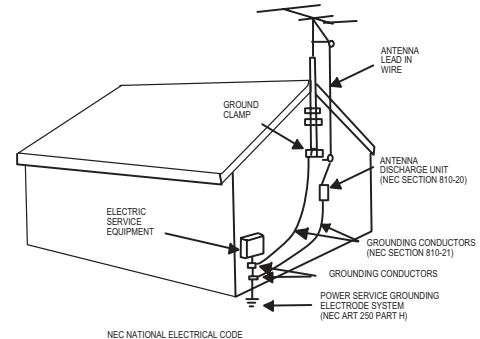

Note to the CATV system installer: This reminder is provided to call the CATV system installer's attention to Article 820-40 of the NEC that provides guidelines for proper grounding and, in particular, specifies that the cable ground shall be connected to the grounding system of the building, as close to the point of cable entry as practical.

**Disposal of this product may require specific instructions pertaining to your resident state. For disposal or recycling information, please contact your local authorities or the Electronic Industries Alliance: [www.eiae.org](http://www.eiae.org).**



Check to make sure you have the following accessories before disposing of the packing material.

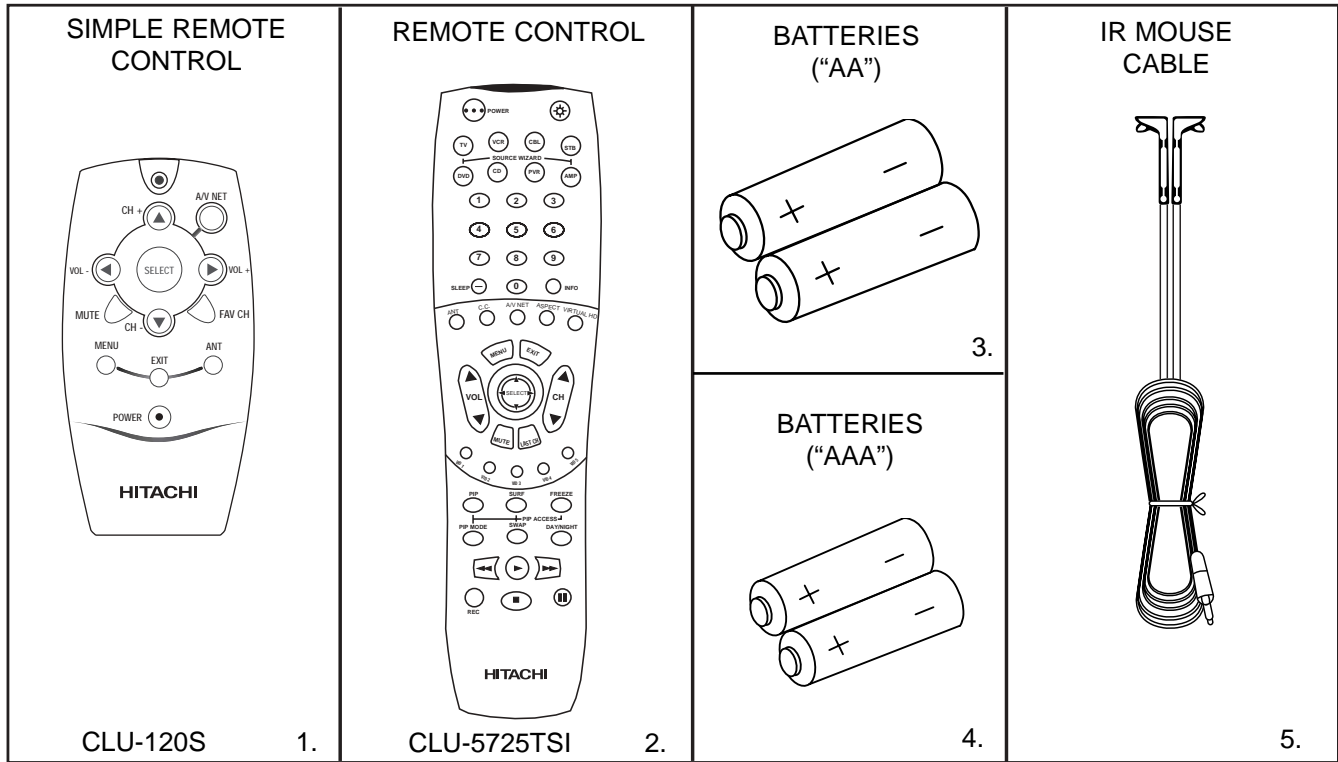

1. Simple Remote Control Unit CLU-120S (Part No. HL01861).
2. Remote Control Unit CLU-5725TSI (Part No. HL01825).
3. Two "AA" size, 1.5V batteries (For Remote Control Unit).
4. Two "AAA" size, 1.5V batteries (for Simple Remote Control Unit).
5. Two IR Mouse Cables (Part No. EY01641).

## REMOTE CONTROL BATTERY INSTALLATION AND REPLACEMENT

1. Open the battery cover of the remote control by pushing the notched part of the cover with your fingers and pulling the cover off.
2. Insert two new "AA" size batteries for the remote control, and two new "AAA" size batteries for the simple remote control. When replacing old batteries, push them towards the springs and lift them out.
3. Match the batteries to the (+) and (-) marks in the battery compartment.

4. Replace the cover.

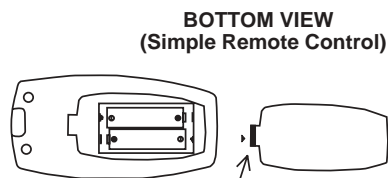

Lift up on tab to remove back cover.

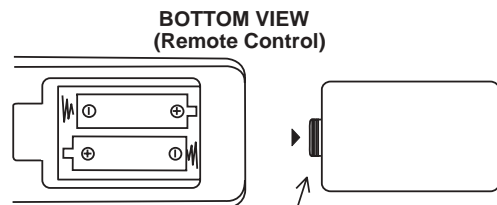

Lift up on tab to remove back cover.



**CAUTION:** Danger of explosion if battery is incorrectly replaced. Replace with the same or equivalent type.



# HOW TO SET UP YOUR NEW HITACHI PROJECTION TV

## ANTENNA

Unless your TV is connected to a cable TV system or to a centralized antenna system, a good outdoor TV antenna is recommended for best performance. However, if you are located in an exceptionally good signal area that is free from interference and multiple image ghosts, an indoor antenna may be sufficient.

## LOCATION

Select an area where sunlight or bright indoor illumination will not fall directly on the picture screen. Also, be sure that the location selected allows a free flow of air to and from the perforated back cover of the set.

To avoid cabinet warping, cabinet color changes, and increased chance of set failure, do not place the TV where temperatures can become excessively hot, for example, in direct sunlight or near a heating appliance, etc.

## VIEWING

The major benefit of the HITACHI Projection Television is its large viewing screen. To see this large screen at its best, test various locations in the room to find the optimum spot for viewing.

The best picture is seen by sitting directly in front of the TV and about 10 to 18 feet from the screen. Picture brightness decreases as the viewer moves to the left and right of the receiver.

During daylight hours, reflections from outside light may appear on the screen. If so, drapes or screens can be used to reduce the reflection or the TV can be located in a different section of the room.

If the TV's audio output will be connected to a Hi-Fi system's external speakers, the best audio performance will be obtained by placing the speakers equidistant from each side of the receiver cabinet and as close as possible to the height of the picture screen center. For best stereo separation, place the external speakers at least four feet from the side of the TV, place the surround speakers to the side or behind the viewing area. Differences in room sizes and acoustical environments will require some experimentation with speaker placement for best performance.

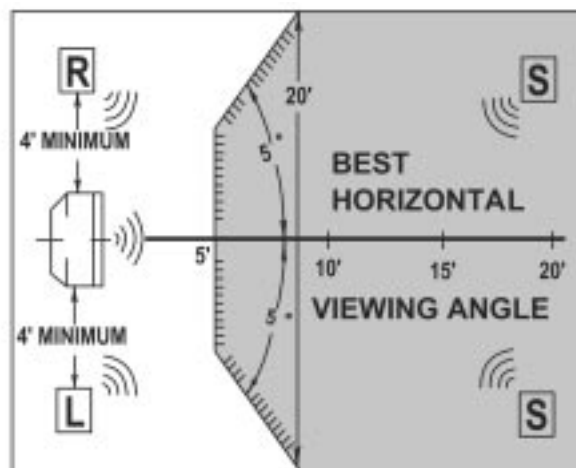
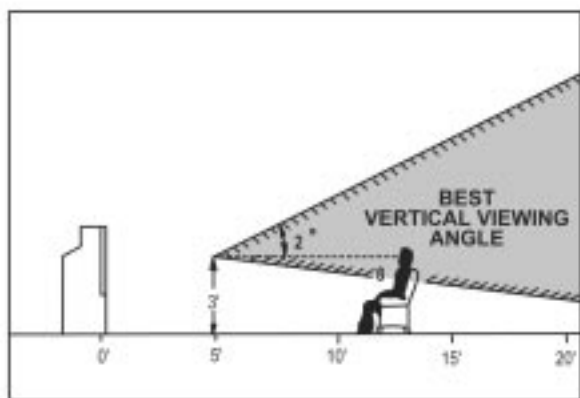

**CAUTION:** Magnetic fields, such as those of external speakers, may cause the picture to distort if they are placed too close to the television. Move the magnetic field source away from the television until there is no picture distortion.



# HOOK-UP CABLES AND CONNECTORS

FIRST TIME USE

Most video/audio connections between components can be made with shielded video and audio cables that have phono connectors. For best performance, video cables should use 75-Ohm coaxial shielded wire. Cables can be purchased from most stores that sell audio/video products. Below are illustrations and names of common connectors. Before purchasing any cables, be sure of the output and input connector types required by the various components and the length of each cable.

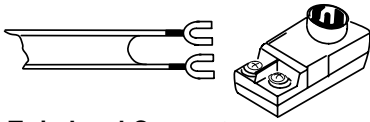

### 300-Ohm Twin Lead Connector

This outdoor antenna cable must be connected to an antenna adapter (300-Ohm to 75-Ohm).



### Phono Connector

Used on all standard video and audio cables which connect to inputs and outputs located on the television's rear jack panel and front control panel.

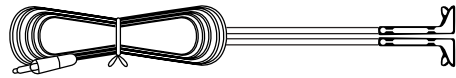

### IR Mouse Cable (Provided)

Connect the IR Mouse Cable to the IR BLASTER output of your TV when using the A/V Network feature. You must place the IR mouse transmitter in front of the IR sensor of your external components. This connection allows your TV to control your external components without using your external component's remote control.



### "F" Type 75-Ohm Coaxial Antenna Connector

For connecting RF signals (antenna or cable TV) to the antenna jack on the television.



### S-Video (Super Video) Connector

This connector is used on camcorders, VCRs and laser-disc players with an S-Video feature in place of the standard video cable to produce a high quality picture.

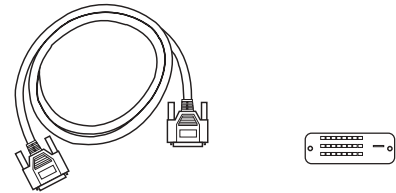

### Digital Visual Interface (DVI) Connection Cable

This cable is used to connect external devices with DVI-HDTV output capability.

## ANTENNA CONNECTIONS TO REAR JACK PANEL

### VHF (75-Ohm) antenna/CATV (Cable TV)

When using a 75-Ohm coaxial cable system, connect the outdoor antenna or CATV coaxial cable to the ANT A (75-Ohm) terminal. If you have a second antenna or cable TV system, connect the coaxial cable to the ANT B terminal.

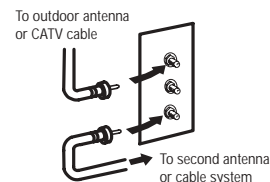

### VHF (300-Ohm) antenna/UHF antenna

When using a 300-Ohm twin lead from an outdoor antenna, connect the VHF or UHF antenna leads to screws of the VHF or UHF adapter. Plug the adapter into the antenna terminal on the TV.

To outdoor VHF or UHF antenna



### When both VHF and UHF antennas are connected

Attach an optional antenna cable mixer to the TV antenna terminal, and connect the cables to the antenna mixer. Consult your dealer or service store for the antenna mixer.

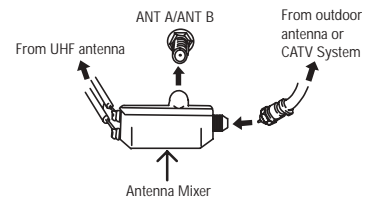



# FRONT PANEL CONTROLS

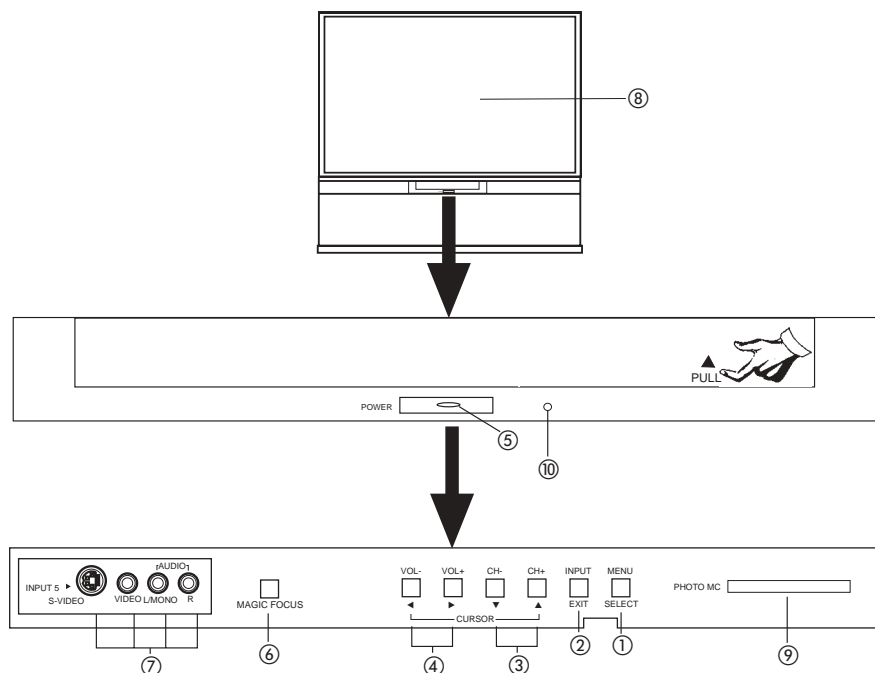

## ① MENU/SELECT button

This button allows you to enter the MENU, making it possible to set TV features to your preference without using the remote. This button also serves as the SELECT button when in MENU mode.

## ② INPUT/EXIT button

Press this button to select the current antenna source, VIDEO: 1, 2, 3, 4, 5 or alternate antenna source. Your selection is shown in the top right corner of the screen. This button also serves as the EXIT button when in MENU mode.

**NOTES:** Your remote control does not have an INPUT button. To change to video inputs, press VID1~VID5 buttons depending on your choice (see page 33).

## ③ CHANNEL selector

Press these buttons until the desired channel appears in the top right corner of the TV screen. These buttons also serve as the cursor down (▼) and up (▲) buttons when in MENU mode.

## ④ VOLUME level

Press these buttons for your desired sound level. The volume level will be displayed on the TV screen. These buttons also serve as the cursor left (◀) and right (▶) buttons when in MENU mode. When the TV power is turned OFF at a volume level 31 or greater, the volume level will default to 30 when the TV is turned ON. However, if it is set to a level 30 or less, the volume level will be at the level it was set when the TV is turned ON.

## ⑤ POWER button

Press this button to turn the TV on or off.

## ⑥ MAGIC FOCUS

Use this button to automatically adjust your picture quality to optimum performance (see page 64).

## ⑦ FRONT INPUT JACKS (INPUT 5)

Use these audio/video jacks for a quick hook-up from a camcorder or VCR to instantly view your favorite show or new recording. Press the INPUT/EXIT button on the front control panel until VIDEO: 5 appears in the top right corner of the TV screen. If you have mono sound, insert the audio cable into the left audio jack.

## ⑧ IR RECEIVER / LEARNING AV NET sensor

The screen area acts as the IR receiver (remote sensor) and the LEARNING AV NET sensor of the TV. When using the remote control, point it towards the screen for best response.

## ⑨ PHOTO MC

Insert Photo memory card to view your digital still pictures (see page 27).

## ⑩ PHOTO MC LED Light Indicator

Shows the status of the memory card (see page 27).



# FRONT PANEL JACKS AND CONNECTORS

FIRST TIME USE

The front panel jacks are provided as a convenience to allow you to easily connect a camcorder or VCR as shown in the following examples:

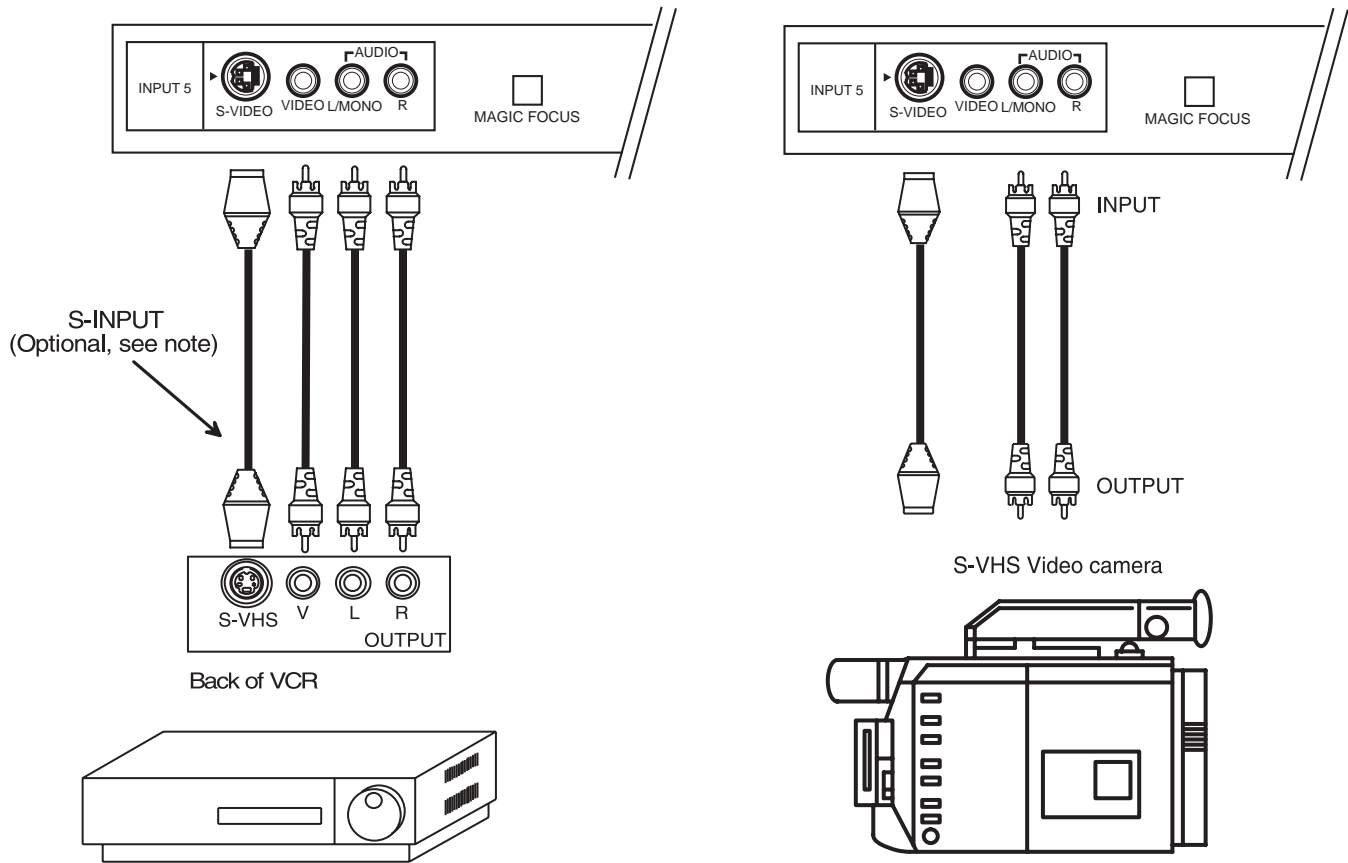

- NOTE:**
1. Completely insert connection cord plugs when connecting to front panel jacks. If you do not, the played back picture may be abnormal.
  2. If you have a S-VHS VCR, use the S-INPUT cable in place of the standard video cable.
  3. If you have a mono VCR, insert the audio cable into the left audio jack of your TV.



# REAR PANEL JACKS



FIRST TIME USE

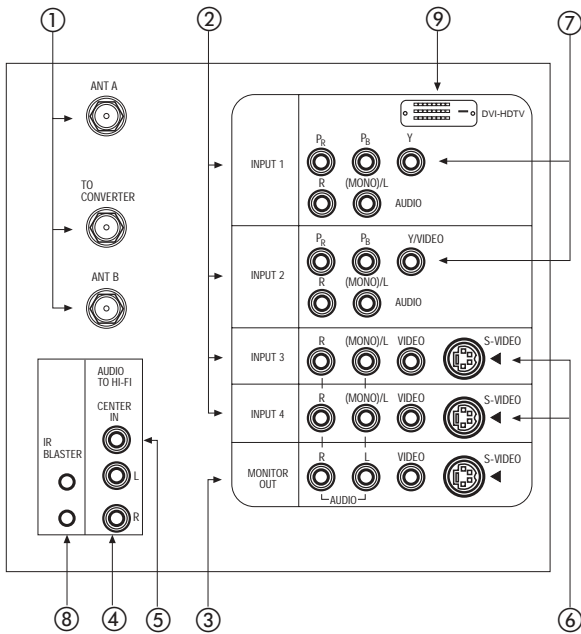

Models: 57T500 and 65T500

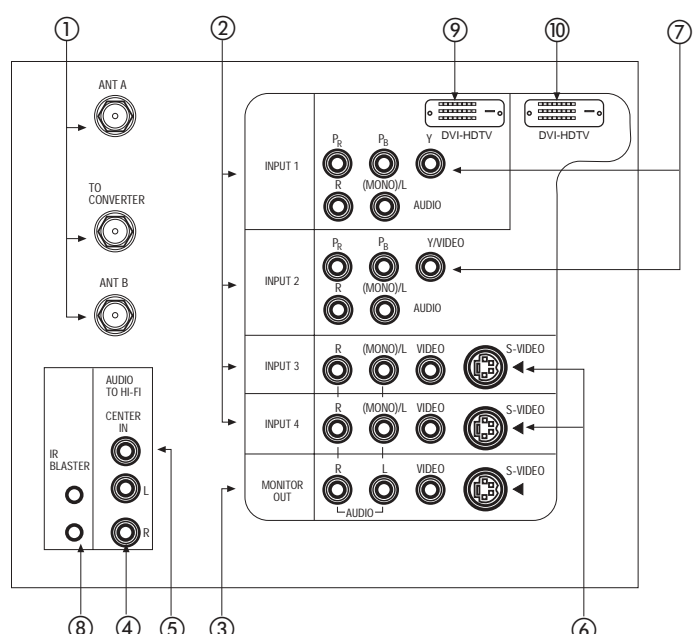

Models: 57X500 and 65X500

## ① Antenna Input/Output

The remote control allows you to switch between two separate 75-Ohm RF antenna inputs, ANT A and ANT B. ANT A input can be displayed as a main picture or sub-picture. ANT B can only be displayed as a main picture. (ANT B cannot be displayed as a sub-picture.) The antenna output labeled "TO CONVERTER" allows the ANT A connection to pass directly to a different source such as a cable box, only when ANT B is displayed as a main picture.

## ② Audio/Video Inputs 1, 2, 3 and 4

The VID1~VID4 buttons will select each video source each time they are pressed. Use the audio and video inputs to connect external devices, such as VCRs, camcorders, laserdisc players, DVD players etc. (if you have mono sound, insert the audio cable into the left audio jack.)

**NOTE:** You may use VIDEO or S-VIDEO inputs to connect to INPUT 3 and 4, but only one of these inputs may be used at a time.

## ③ MONITOR OUT

These jacks provide fixed audio and video signals which are used for recording. Use the S-VIDEO Output for high quality video output.

**NOTE:** S-VIDEO Output may be used for recording, only when the input is of S-VIDEO type.

## ④ AUDIO TO HI-FI Output

These jacks provide variable audio output to a separate stereo amplifier. With this connection, the audio to the stereo can be controlled by the television's main volume.

## ⑤ CENTER IN (Input)

These jacks are for center signals such as Dolby. This feature allows the TV speakers to be used as a center speaker. The TV must be set as a center channel by selecting "TV as Center" on the Internal Speakers Settings of the Audio Menu (see page 51).

## ⑥ S-VIDEO Inputs 3 and 4

Inputs 3 and 4 provide S-VIDEO (Super Video) jacks for connecting equipment with S-VIDEO output capability.



### ⑦ Component: Y-P<sub>B</sub>P<sub>R</sub> Inputs

Inputs 1 and 2 provide Y-P<sub>B</sub>P<sub>R</sub> jacks for connecting equipment with this capability, such as a DVD player or Set Top Box. You may use composite video signal for INPUT:2.

- NOTES:**
1. Do not connect composite VIDEO and S-VIDEO to Input 3, 4 or 5 at the same time. S-VIDEO has priority over VIDEO input.
  2. Your component outputs may be labeled Y, B-Y, and R-Y. In this case, connect the components B-Y output to the TV's P<sub>B</sub> input and the components R-Y output to the TV's P<sub>R</sub> input.
  3. Your component outputs may be labeled Y-C<sub>B</sub>C<sub>R</sub>. In this case, connect the component C<sub>B</sub> output to the TV's P<sub>B</sub> input and the component C<sub>R</sub> output to the TV's P<sub>R</sub> input.
  4. It may be necessary to adjust TINT to obtain optimum picture quality when using the Y-P<sub>B</sub>P<sub>R</sub> inputs (see page 48).
  5. To ensure no copyright infringement, the MONITOR OUT output will be abnormal, when using the Y-P<sub>B</sub>P<sub>R</sub> jacks.
  6. Input 2 (Y/VIDEO) can be used for composite video and component video input.

### ⑧ IR Blaster

This jack provides IR output to your external components (VCR, Cable box, DVD player, etc.). With this connection, your external components can automatically be controlled by the AV net feature. This connection will allow you to control the external components with your television's remote control (see page 20).

### ⑨ DVI-HDTV Input (INPUT 1)

Use this DVI-HDTV Input for your external devices with DVI-HDTV output such as a Set-Top-Box, high-band DTV decoders, DVD players and D-VHS with Digital Content Protection.

### ⑩ DVI-HDTV Input (INPUT 2)

This input is an extra DVI-HDTV Input for any additional external devices.

- NOTES:**
1. Only DTV format such as 1080i, 720p, 480i and 480p are available for DVI-HDTV input.
  2. The DVI-HDTV input is NOT compatible when used with a DVD player from a personal computer.
  3. When connecting a Set-Top-Box with a copy-protect digital out terminal, a high definition picture can be displayed on the screen in its digital form.

# REAR PANEL CONNECTIONS



## TYPICAL FULL-FEATURE SETUP Models: 57T500 and 65T500

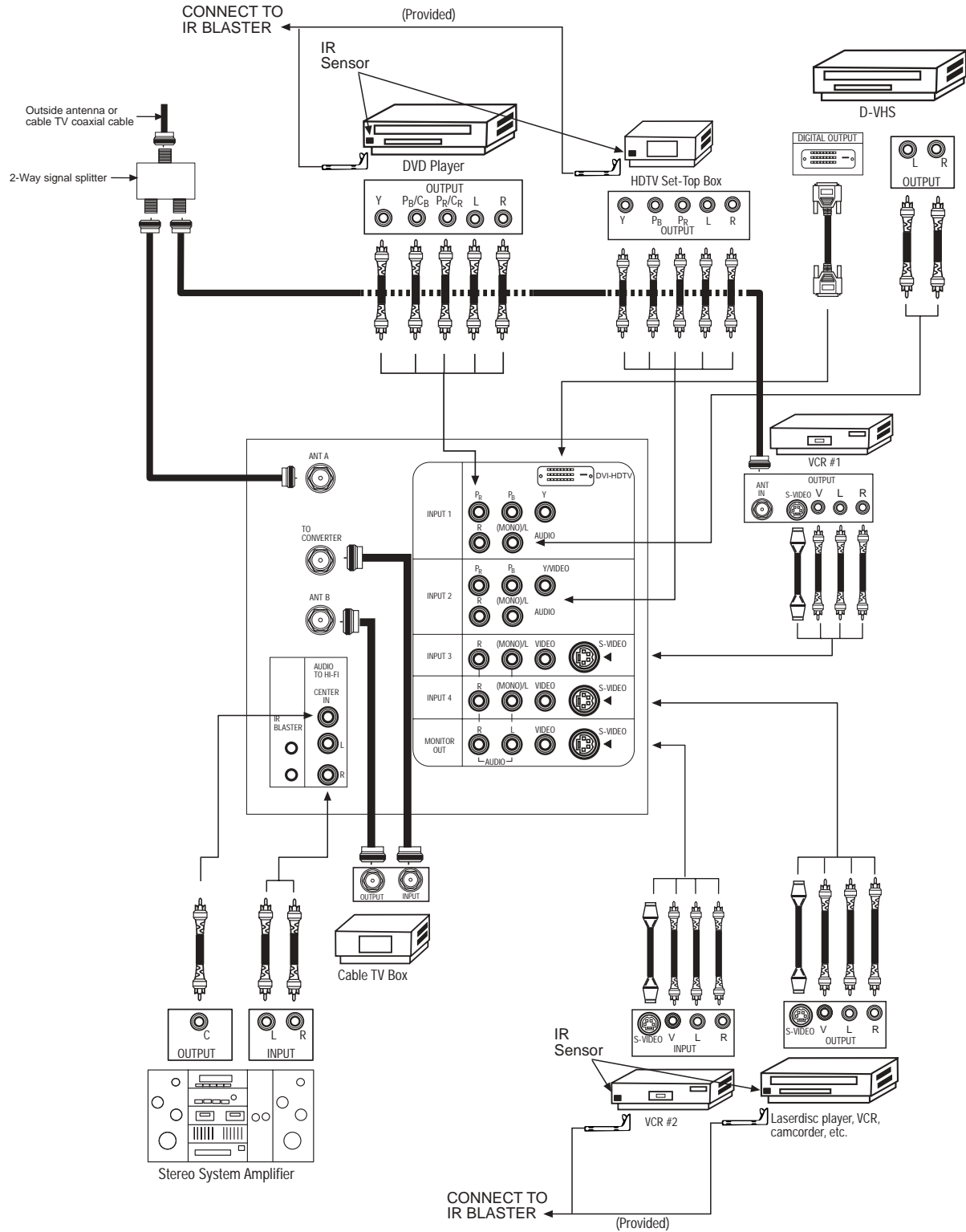

FIRST TIME USE

- NOTE:**
1. Connect only 1 component to each input jack.
  2. Follow connections that pertain to your personal entertainment system.
  3. Composite video signal can be input to Input2-Input5.
  4. Cables are optional except when noted as provided.



# REAR PANEL CONNECTIONS

## TYPICAL FULL-FEATURE SETUP

Models: 57X500 and 65X500

FIRST TIME USE

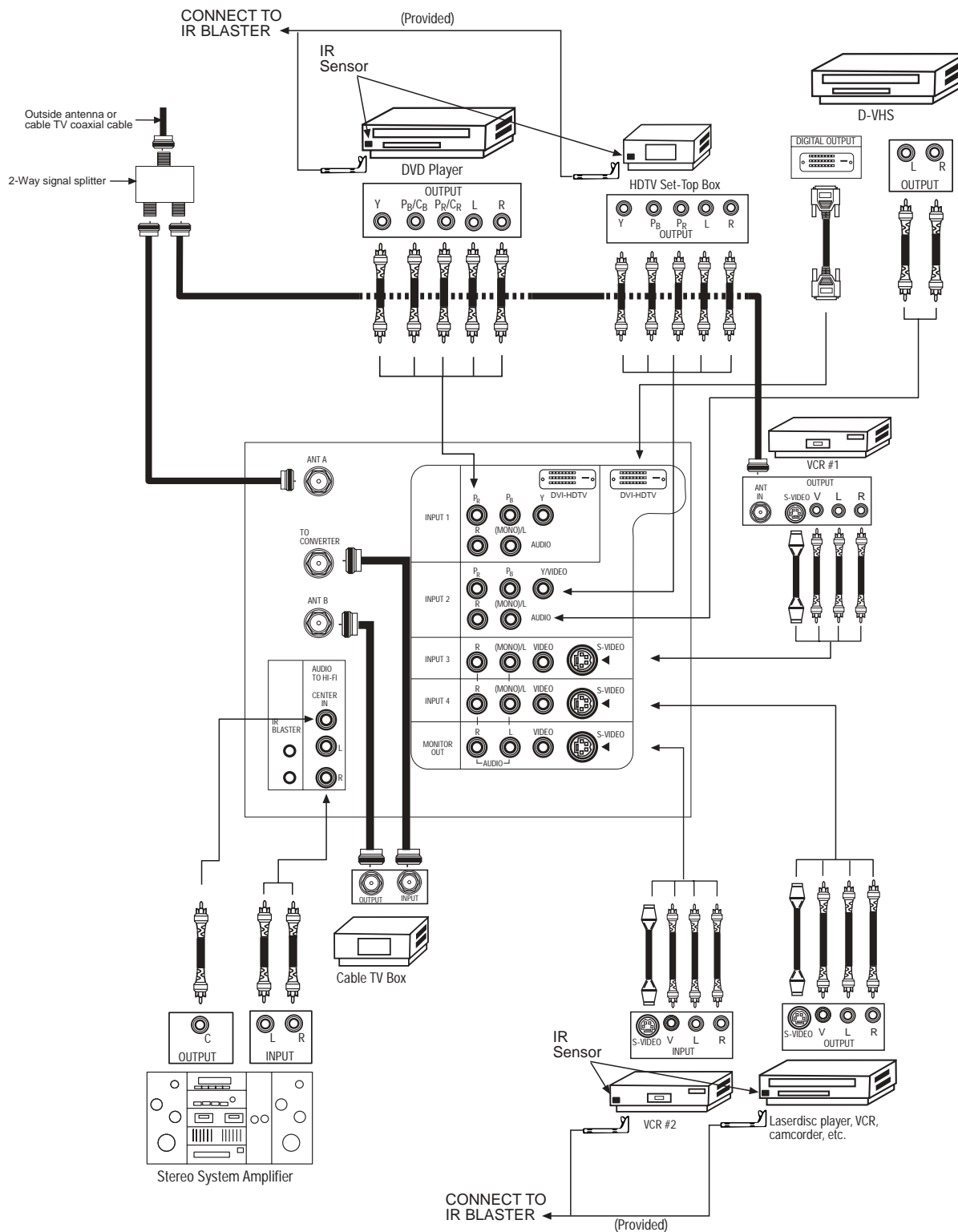

**NOTE:**

1. Connect only 1 component to each input jack.
2. Follow connections that pertain to your personal entertainment system.
3. Composite video signal can be input to Input2-Input5.
4. Cables are optional except when noted as provided.



## TIPS ON REAR PANEL CONNECTIONS

- S-VIDEO connections are provided for high performance laserdisc players, VCRs etc. that have this feature. Use these connections in place of the standard video connection if your device has this feature.
- If your device has only one audio output (mono sound), connect it to the left audio jack on the television.
- Refer to the operating guide of your other electronic equipment for additional information on connecting your hook-up cables.
- A single VCR can be used for VCR #1 and VCR #2, but note that a VCR cannot record its own video or line output (INPUT: 3 in the example on page 11 or page 12). Refer to your VCR operating guide for more information on line input-output connections.
- You may use VIDEO or S-VIDEO inputs to connect to Input 3, Input 4 or Input 5, but only one of these may be used at a time.
- Connect only 1 component (VCR, DVD player, camcorder, etc.) to each input jack.
- COMPONENT: Y-P<sub>B</sub>P<sub>R</sub> (Input 1 & 2) connections are provided for high performance components, such as DVD players and set-top-boxes. Use these connections in place of the standard video connection if your device has this feature. Input 2 accepts both composite and component video signals.
- Your component outputs may be labeled Y, B-Y, and R-Y. In this case, connect the components B-Y output to the TV's P<sub>B</sub> input and the components R-Y output to the TV's P<sub>R</sub> input.
- Your component outputs may be labeled Y-C<sub>B</sub>C<sub>R</sub>. In this case, connect the components C<sub>B</sub> output to the TV's P<sub>B</sub> input and the components C<sub>R</sub> output to the TV's P<sub>R</sub> input.
- You may use composite video signal for Input 2~Input 5.
- It may be necessary to adjust TINT to obtain optimum picture quality when using the Y-P<sub>B</sub>P<sub>R</sub> inputs (see page 48).
- To ensure no copyright infringement, the MONITOR OUT output will be abnormal, when using the Y-P<sub>B</sub>P<sub>R</sub> jacks.
- When using a DVI input from a Set-Top-Box, it is recommended to use a 1080i or 720p input signal.



# CONNECTING EXTERNAL AUDIO DEVICES

FIRST TIME USE

To control the audio level of an external audio amplifier with the remote control, connect the system as shown below.

## REAR PANEL OF TELEVISION

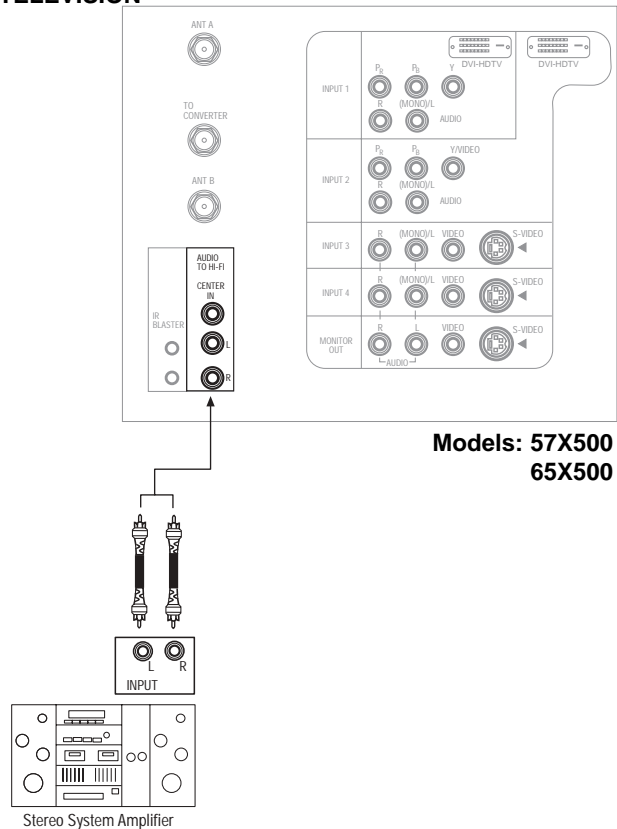
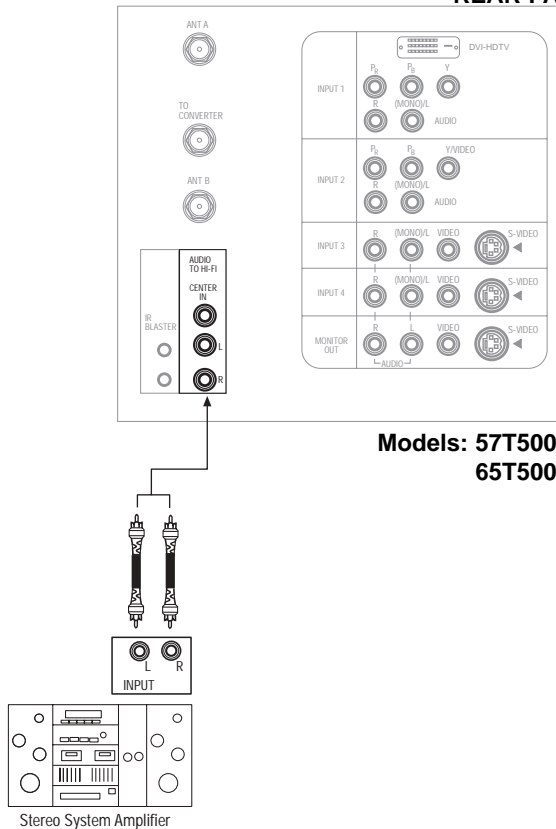

- NOTE:**
1. To prevent damage to the speaker and distorted sound, set the volume control of the audio amplifier lower and adjust the sound using the remote control of the TV set.
  2. See page 51 for AUDIO Settings.

# CONNECTING EXTERNAL VIDEO SOURCES

The exact arrangement you use to connect the VCR, camcorder, laserdisc player, DVD player, or HDTV Set Top Box to your TV set is dependent on the model and features of each component. Check the owner's manual of each component for the location of video and audio inputs and outputs.

The following connection diagrams are offered as suggestions. However, you may need to modify them to accommodate your particular assortment of components and features. For best performance, video and audio cables should be made from coaxial shielded wire.

### Before Operating External Video Source

The input mode is changed every time the VID1~VID5 button is pressed as shown below. Connect an external source to the INPUT terminal, then press the VID1~VID5 button as necessary to view the input source (see page 33).

### INPUT MODE SELECTION ORDER

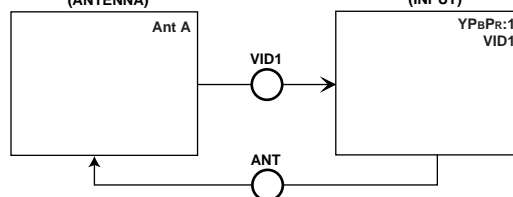

- NOTE:** When the TV is set to VIDEO and a video signal is not received from the VIDEO INPUT JACK on the back panel of the TV (i.e., VCR/laserdisc player, etc. is not connected or the video device is OFF), the set will appear to be OFF.



# CONNECTING EXTERNAL VIDEO SOURCES

## CONNECTING A MONAURAL AUDIO SOURCE TO INPUT2~INPUT5

1. Connect the cable from the VIDEO OUT of the VCR or the laserdisc player to the INPUT (VIDEO) jack, as shown on the TV set below.
2. Connect the cable from the AUDIO OUT of the VCR or the laserdisc player to the INPUT (MONO)/L(AUDIO) jack.
3. Press the VID2~VID5 button to view the program from the VCR or the laserdisc player. The VIDEO label disappears automatically after approximately four seconds.
4. Press the ANT button to return to the previous channel.

FIRST TIME USE

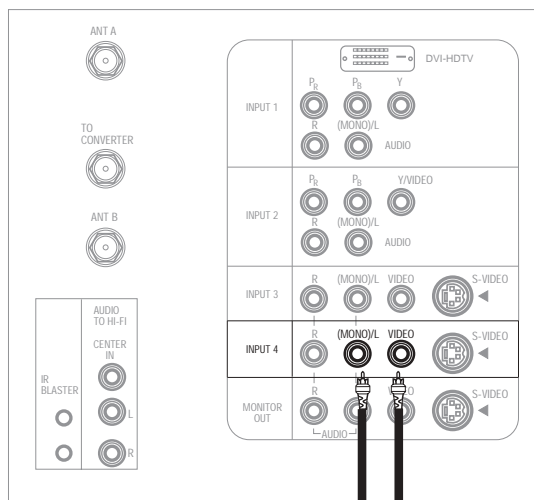

Models: 57T500  
65T500

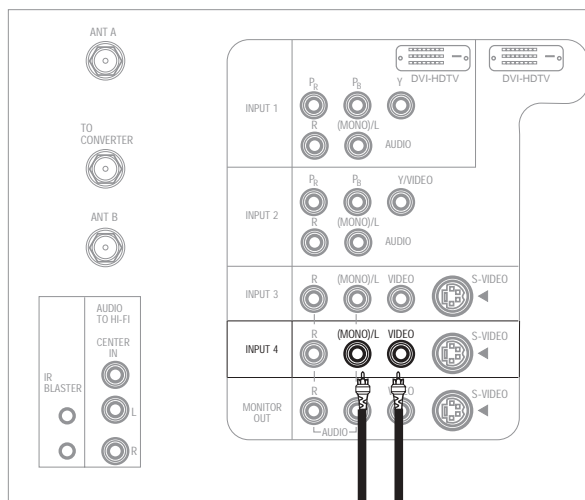
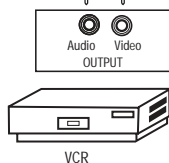

Models: 57X500  
65X500

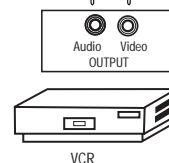



# CONNECTING EXTERNAL VIDEO SOURCES

FIRST TIME USE

## CONNECTING A STEREO SOURCE TO INPUT2-INPUT5

1. Connect the cable from the VIDEO OUT of the VCR or the laserdisc player to the INPUT (VIDEO) jack, as shown on the TV set below.
2. Connect the cable from the AUDIO OUT R of the VCR or the laserdisc player to the INPUT (AUDIO/R) jack.
3. Connect the cable from the AUDIO OUT L of the VCR or the laserdisc player to the INPUT (AUDIO/L) jack.
4. Press the VID2~VID5 button to view the program from the VCR or laserdisc player. The VIDEO label disappears automatically after approximately four seconds.
5. Press the ANT button to return to the previous channel.

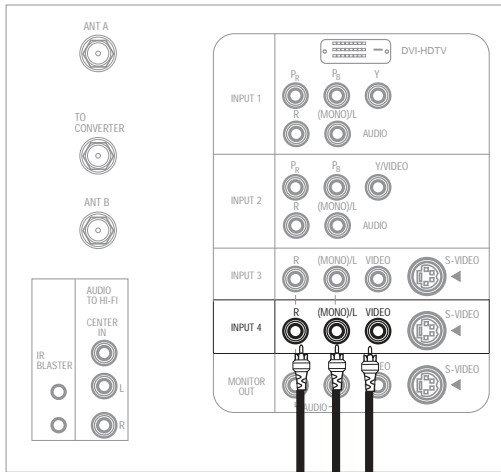

Models: 57T500  
65T500

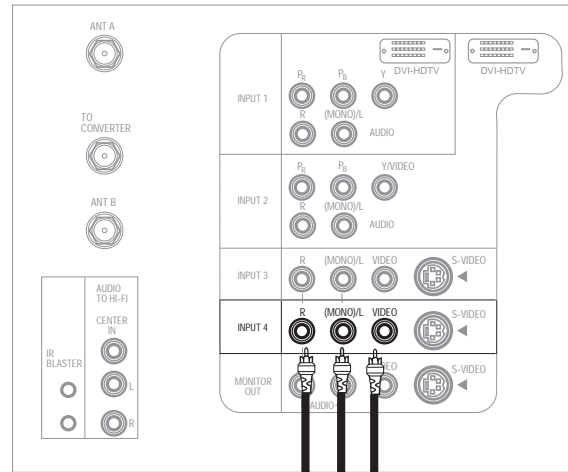

Models: 57X500  
65X500

- NOTES:**
1. Completely insert the connection cord plugs when connecting to rear panel jacks. The picture and sound that is played back will be abnormal if the connection is loose.
  2. A single VCR can be used for VCR #1 and VCR #2, but note that a VCR cannot record its own video or line output. (INPUT: 1 in example on page 11 or page 12) Refer to your VCR operating guide for more information on line input-output connections.





# CONNECTING EXTERNAL VIDEO SOURCES

FIRST TIME USE

## CONNECTING AN S-VIDEO SOURCE TO INPUT 3, 4 AND 5

1. Connect the cable from the S-VIDEO OUT of the VCR or the laserdisc player to the INPUT (S-VIDEO) jack, as shown on the TV set below.
2. Connect the cable from the AUDIO OUT R of the VCR or the laserdisc player to the INPUT (AUDIO/R) jack.
3. Connect the cable from the AUDIO OUT L of the VCR or the laserdisc player to the INPUT (AUDIO/L) jack.
4. Press the VID3~VID5 button to view the program from the VCR or laserdisc player. The VIDEO label disappears automatically after approximately four seconds.
5. Press the ANT button to return to the previous channel.

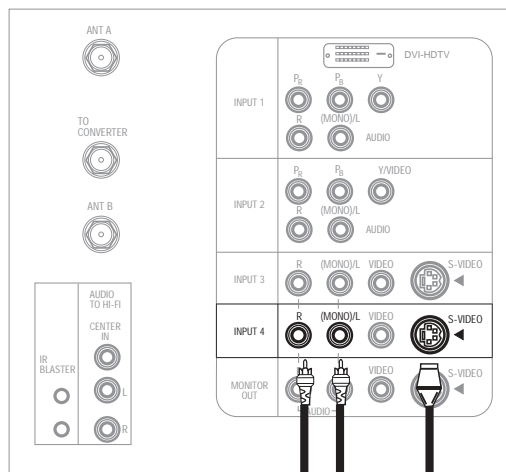

Models: 57T500  
65T500

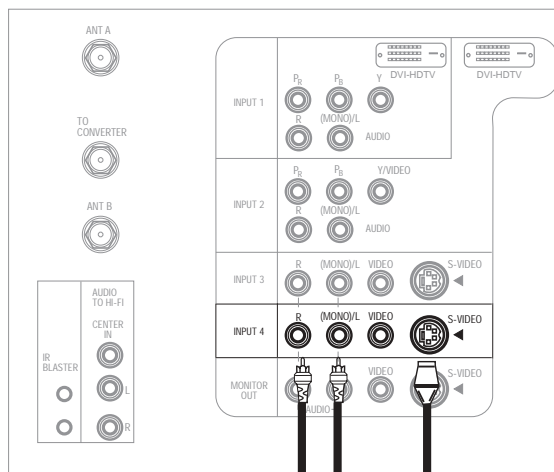

Models: 57X500  
65X500

- NOTES:**
1. Completely insert the connection cord plugs when connecting to rear panel jacks. The picture and sound that is played back will be abnormal if the connection is loose.
  2. A single VCR can be used for VCR #1 and VCR #2, but note that a VCR cannot record its own video or line output. (INPUT: 1 in example on page 11 or page 12) Refer to your VCR operating guide for more information on line input-output connections.



# CONNECTING EXTERNAL VIDEO SOURCES

FIRST TIME USE

## CONNECTING A COMPONENT SOURCE WITH DVI-HDTV CAPABILITY TO INPUT 1 OR INPUT 2 (Models: 57/65X500)

1. Connect the DVI connection cable from the output of the HDTV set top box or DVD player to the DVI-HDTV input as shown on the TV set below.
2. Connect the cable from the AUDIO OUT R of the HDTV set top box or DVD player to the INPUT (AUDIO/R) jack.
3. Connect the cable from the AUDIO OUT L of the HDTV set top box or DVD player to the INPUT (AUDIO/L) jack.
4. Press the VID1 or VID2 (Models: 57/65X500) button to view the program from the HDTV set top box or DVD player. The VIDEO label disappears automatically after approximately four seconds.
5. Press the ANT button to return to the previous channel.

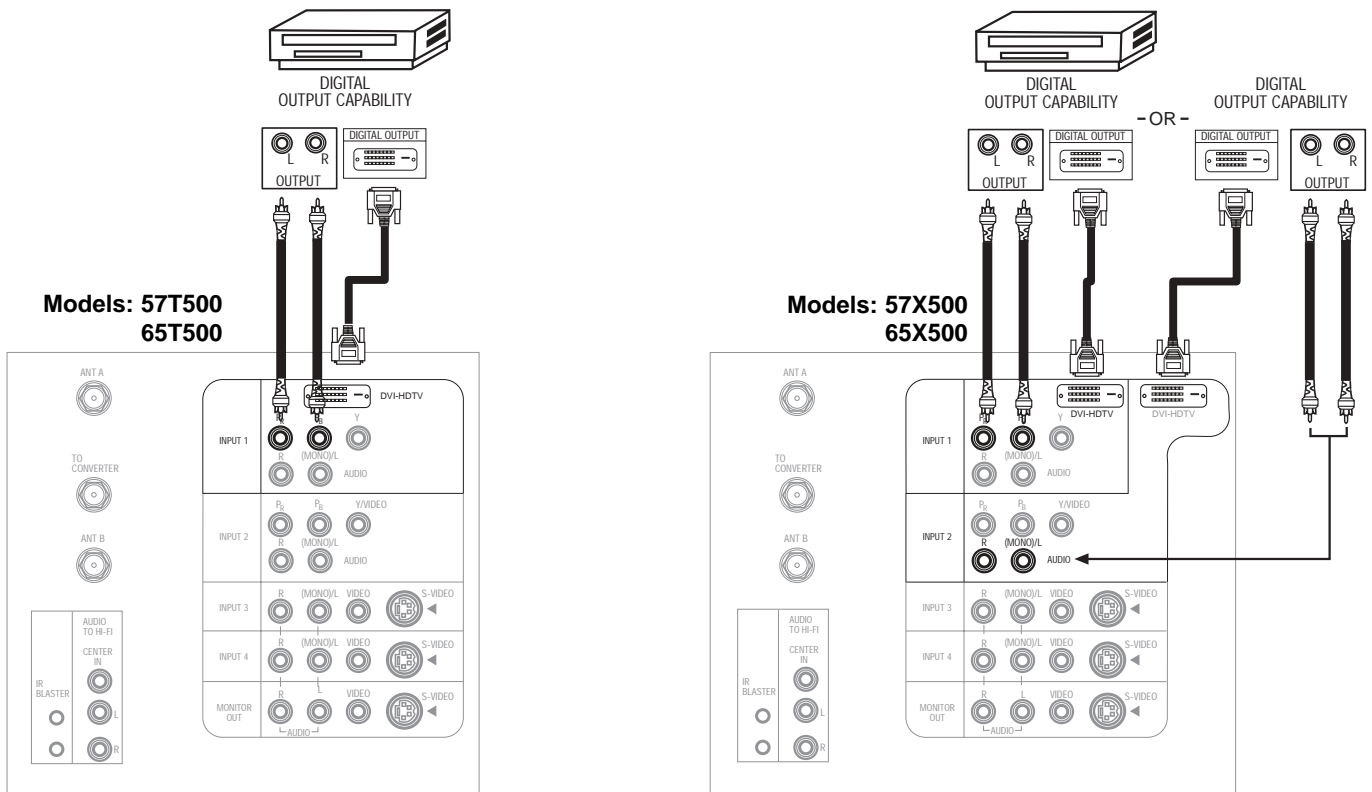

- NOTES:**
1. Completely insert the connection cord plugs when connecting to rear panel jacks. The picture and sound that is played back will be abnormal if the connection is loose.
  2. The DVI-HDTV input on INPUT 1 or INPUT 2 (Models: 57/65X500) contains the copy protection system called High-bandwidth Digital Content Protection (HDCP). HDCP is a cryptographic system that encrypts video signals when using DVI connections to prevent illegal copying of video contents.
  3. DVI is not a "NETWORK" technology. It establishes a one-way point-to-point connection for delivery of uncompressed video to a display.
  4. The connected digital output device controls the DVI interface so proper set-up of device user settings determines final video appearance.



# FIRST TIME USE

## CONNECTING A COMPONENT SOURCE TO INPUT 1 OR 2: Y-P<sub>B</sub>P<sub>R</sub>.

1. Connect the cable from the Y OUT of the Laserdisc/DVD player or HDTV set top box to the INPUT (Y) jack, as shown on the TV set below.
2. Connect the cable from the C<sub>B</sub>/P<sub>B</sub> OUT or B-Y OUT of the Laserdisc/DVD player or HDTV set top box to the INPUT (P<sub>B</sub>) jack.
3. Connect the cable from the C<sub>R</sub>/P<sub>R</sub> OUT or R-Y OUT of the Laserdisc/DVD player or HDTV set top box to the INPUT (P<sub>R</sub>) jack.
4. Connect the cable from the AUDIO OUT R of the Laserdisc/DVD player or HDTV set top box to the INPUT (AUDIO/R) jack.
5. Connect the cable from the AUDIO OUT L of the Laserdisc/DVD player or HDTV set top box to the INPUT (AUDIO/L) jack.
6. Press the VID1~VID2 button, to view the program from the Laserdisc/DVD player or HDTV set top box. The VIDEO label disappears automatically after approximately four seconds.
7. Press the ANT button to return to the previous channel.

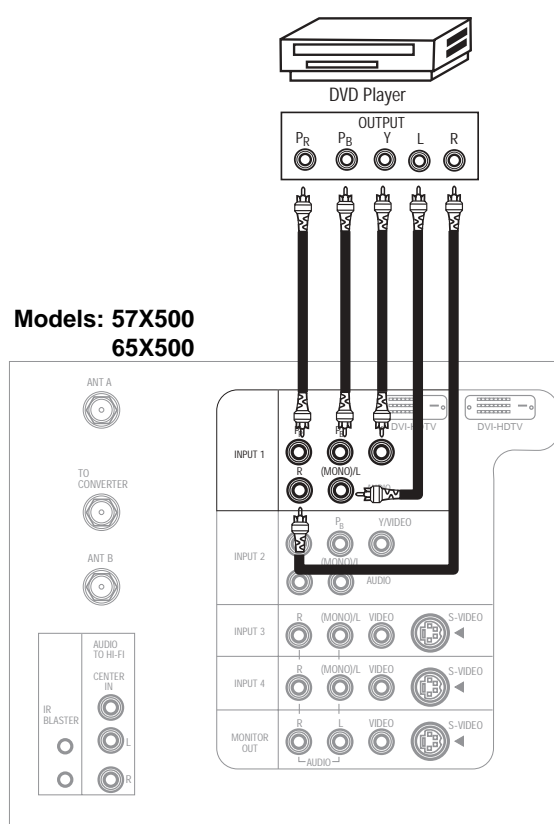
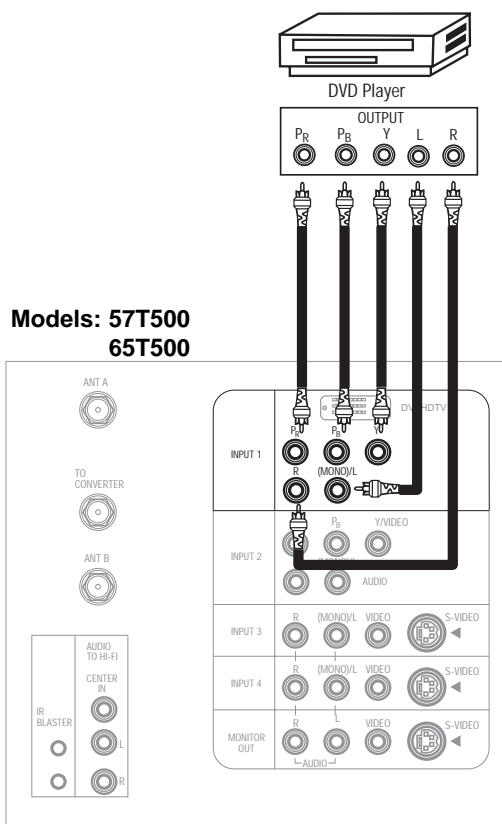

**NOTE:**

1. Completely insert the connection cord plugs when connecting to rear panel jacks. The picture and sound that is played back will be abnormal if the connection is loose.
2. See page 13 for tips on REAR PANEL CONNECTIONS.



# CONNECTING AV NETWORK

FIRST TIME USE

Your Hitachi Television is equipped with an AV Network feature. This feature helps to control your external Audio/Video equipment (VCR, Set Top Box, DVD, etc.). Once this is setup, it allows your IR Mouse connector to control your equipment using your Hitachi TV Remote Control. You can use your Hitachi remote control to control the Audio/Video equipment command without the equipment's remote control.

The Television rear panel has 2 IR BLASTER jacks. Each IR Mouse cable can connect up to 2 external Audio/Video components. Therefore, you can connect the Television with up to four components. Please see the following example of an AV Network setup between your Hitachi Television and external Audio/Video equipment (VCR and DVD Player).

## CONNECTING EXTERNAL AUDIO/VIDEO COMPONENTS TO IR BLASTER FOR AV NETWORK

1. Connect your external Audio/Video components to the Rear Panel jacks as shown on pages 15~19.
2. Connect the IR Mouse cable to the IR BLASTER input of the Television's rear panel.
3. Place the IR mouse in front of the infrared sensor of the external components you wish to control.

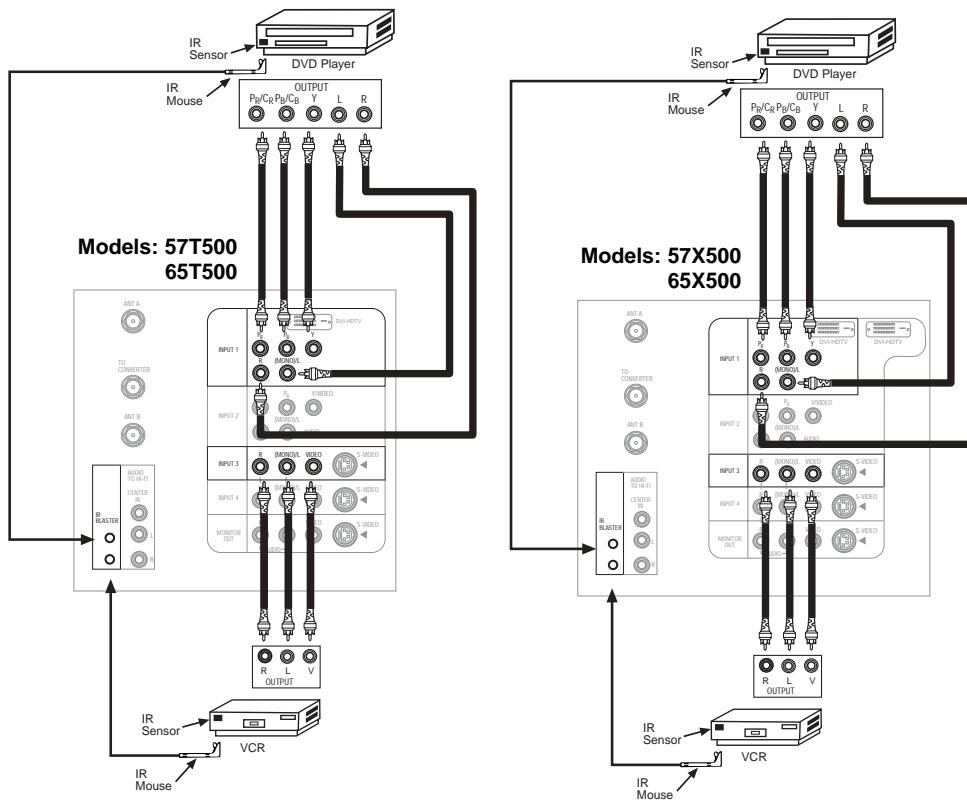

**NOTES:**

1. The Rear Panel has two IR BLASTER inputs which can control up to a total of four external components.
2. The IR Mouse must be placed in front of the external components IR sensor for the AV Network to work.
3. The correct codes must be entered for each of the Audio/Video components for the AV Network to function properly (see page 22).

4. Press the A/V NET button on the remote control. Use THUMB STICK ▲ or ▼ to highlight the component you wish to set up. Use THUMB STICK ► to enter component's "SOFT KEY" control button. The AV Network Setup Wizard will automatically start upon the very first use. You can access the Setup Menu Wizard again in the future by pressing the INFO button.

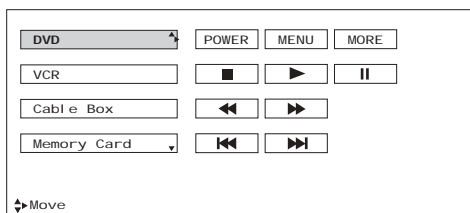



# AV NETWORK SETUP WIZARD

5. Follow the steps below to setup your AV network (See page 22 for AV Network Codes). There are six steps in the setup procedure (DVD setup example below).

FIRST TIME USE

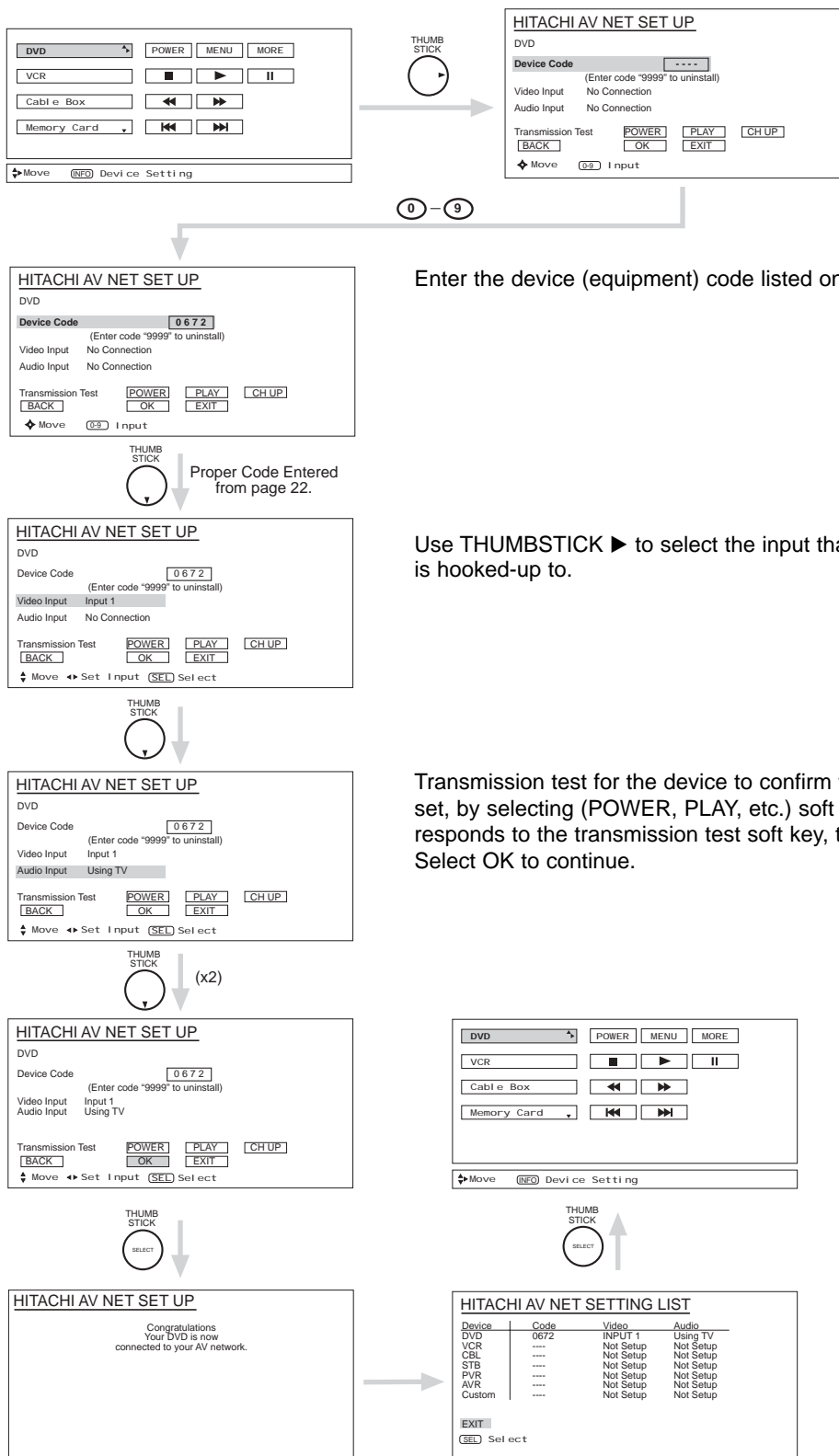

Enter the device (equipment) code listed on page 22.

Use THUMBSTICK ► to select the input that the device (equipment) is hooked-up to.

Transmission test for the device to confirm that the proper code was set, by selecting (POWER, PLAY, etc.) soft keys shown. If the device responds to the transmission test soft key, then it is properly set up. Select OK to continue.

6. Enter "9999" to uninstall the equipment from your AV Network.
7. See Remote Control AV NET button usage on page 26.

**NOTES:**

1. If your equipment cannot be operated after performing the above procedures, your equipment code has not been pre-coded into the AV Net.
2. In the unlikely event that your equipment receiver cannot be operated after performing the above procedures, please consult your equipment receiver operating guide.



# AUDIO/VIDEO NETWORK (A/V NET) CODES

**FIRST TIME USE**

VCR BRAND	CODE
Admiral	0048, 0209
Adventura	0000
Aiko	0278
Aiwa	0000, 0037
Akai	0041
America Action	0278
American High	0035
Asha	0240
Audiovox	0037, 0278
Beaurnark	0240
Bell & Howell	0104
Broksonic	0121, 0184, 0002, 0209, 0479, 1479, 0278
CCE	0072, 0278
Calix	0037
Canon	0035
Carver	0081
Cineral	0278
Citizen	0278, 0037, 1278
Colt	0072
Craig	0037, 0072, 0047, 0240
Curtis Mathes	0035, 0041, 0060, 0162, 0760, 1035
Cybernex	0240
Daewoo	0278, 1278, 0045
Denon	0042
Dynatech	0000
Electrohome	0037
Electrohome	0037
Emerex	0032
Emerson	0184, 0002, 0209, 0121, 0000, 0037, 0043
Fisher	0104, 0047
Fuji	0033, 0035
Funai	0000
GE	0035, 0060, 0240, 0760, 0807, 1035, 1060
Garrard	0000
Go Video	0432
GoldStar	0037, 0038, 1237
Gradiente	0000
HI-Q	0047
Harley Davidson	0000
Harman/Kardon	0038, 0081
Harwood	0072
Hitachi	0000, 0041, 0042
Hughes Network Systems	0042
JVC	0067, 0041
Jensen	0041
KEC	0037, 0278
KLH	0072
Kenwood	0041, 0067, 0038
Kodak	0035, 0037
LXI	0037
Lloyd's	0000
Logik	0072
MEI	0035
MGA	0043, 0240
MGN Technology	0240
MTC	0000, 0240
Magnasonic	1278
Magnavox	0035, 0081, 0563, 0000, 0039, 0149, 1781
Magnintz	0081, 0035
Marta	0037
Matsushita	0035, 0162, 0454
Memorex	0047, 0037, 0104, 0209, 0454, 0048, 0039, 0240, 0000, 0479, 1037, 1162, 1237, 1262
Minolta	0042
Mitsubishi	0807, 0043, 0067
Motorola	0035, 0048
Multitech	0000, 0072
NEC	0038, 0041, 0067, 0104
Nikko	0037
Noblex	0240
Olympus	0035
Optimus	1062, 0162, 0037, 0048, 0104, 0432, 0454, 1048, 1162, 1262
Orion	0184, 0209, 0002, 0479, 1479
Panasonic	1062, 0035, 01625, 0225, 0454, 0616, 1035, 1162, 1262
Penney	0035, 0037, 0240, 0042, 0038, 1035, 1237
Pentax	0042
Philco	0035, 0209, 0479
Philips	0081, 0035, 0618, 1081, 1181
Pilot	0037
Pioneer	0067
Polk Audio	0081
Profitronic	0240
Proscan	0060, 0760, 1060
Protec	0072
Pulsar	0039
Quasar	0035, 0162, 0454, 1035, 1162
RCA	0060, 0240, 0042, 0149, 0760, 0807, 1035, 1060
Radio Shack	0000, 1037
Radix	0037
Randex	0037
Realistic	0035, 0037, 0048, 0047, 0000, 0104
ReplayTV	0614, 0616
Runco	0039
STS	0042
Samsung	0045, 0240
Sanky	0039, 0048
Sansui	0000, 0067, 0209, 0041, 0479, 1479
Sanyo	0047, 0240, 0104
Scott	0184, 0045, 0121, 0043
Sears	0035, 0037, 0047, 0000, 0042, 0104, 1237
Semp	0045
Sharp	0048, 0807, 0848
Shintom	0072

Shogun	0240
Singer	0072
Sonic Blue	0614, 0616
Sony	0035, 0032, 0000, 0033, 0636, 1032, 1232
Sylvania	0035, 0081, 0000, 0043, 1781
Symphonic	0000
TMK	0240
Tatung	0041
Teac	0000, 0041
Technics	0035, 0162
Teknika	0000, 0035, 0037
Thomas	0000
Tivo	0618, 0636
Toshiba	0045, 0043, 845
Totevision	0037, 0240
Unitech	0240
Vector	0045
Vector Research	0038
Video Concepts	0045
Videomagic	0037
Videosonic	0240
Wards	0060, 0035, 0048, 0047, 0081, 0240, 0000, 0042, 0072, 0149, 0760
White Westinghouse	0072, 1278, 0209
XR-1000	0072, 0000, 0035
Yamaha	0038
Zenith	0039, 0000, 0209, 0033, 0479, 1479, 0033, 0034, 0209, 0479

DVD BRAND	CODE
Aiwa	0641
Apex	0672, 0717, 0755, 0794, 0795, 0796, 0797, 0830
Audiologic	0736
B & K	0655, 0662
Blue Parade	0571
Brooksonic	0695
DVD2000	0521
Daewoo	0784
Denon	0490, 0634
Emerson	0591
Enterprise	0591
Fisher	0670
GE	0522, 0717, 0815
GPX	0699, 0769
Go Video	0715
Gradiente	0651
Greenhill	0717
Harman/Kardon	0582, 0702
Hitachi	0573, 0664
Hiteker	0672
JBL	0702
JVC	0623, 0558, 0867
KLH	0717
Kenwood	0490, 0534, 0682
Konka	0711, 0719, 0721
Koss	0651
Lasonic	0798
Magnavox	0503, 0675
Malata	0782
Marantz	0539
Microsoft	0522
Mintek	0717
Mitsubishi	0521
Nesa	0717
Onkyo	0627, 0503
Oritron	0651
Panasonic	0490, 1362, 0632
Philips	0503, 0539, 0646, 0854
Pioneer	0525, 0571, 0632
Polk Audio	0539
Princeton	0674
Proscan	0522
RCA	0522, 0571, 1022, 0717
Samsung	0573, 0820
Sansui	0695
Sanyo	0670
Sharp	0630
Sherwood	0633
Sony	0533
Sylvania	0675
Technics	0490
Techwood	0692
Theta Digital	0571
Toshiba	0503, 0695
Urban Concepts	0503
Yamaha	0490, 0545, 0539
Zenith	0591, 0503

CABLE BRAND	CODE
ABC	0003, 0008, 0014, 0017
Americast	0899
Bell & Howell	0014
Bell South	0899
Director	0476
General Instrument	0003, 0476, 0276, 0810
GoldStar	0144
Hamlin	0009, 0273
Jerrold	0476, 0003, 0276, 0012, 0014, 0810
Memorex	0000
Motorola	0476, 1106, 0276, 0810
Pace	0237
Panasonic	0107, 0000
Philips	0305, 0317
Pioneer	0144, 0533, 0877, 1877
Pulsar	0000
Quasar	0000
Regal	0273, 0279
Runco	0000
Samsung	0144
Scientific Atlanta	0877, 0008, 0017, 0477, 1877
Sony	1006
Starcom	0003

Supercable	0276
Tocom	0012
Torx	0003
Toshiba	0000
Zenith	0000, 0525, 0899

SATELLITE BRAND (Set-Top-Box)	CODE
AlphaStar	0772
Chapparral	0215
Crossdigital	1109
DishPro	1005, 0775
Echostar	1005, 0775
Expressvu	0775
GE	0566
GOI	0775
General Instrument	0869
HTS	0775
Hitachi	0819
Hughes Network Systems	1142, 0749, 1749
JVC	0775
Magnavox	0724, 0722
Memorex	0724
Mitsubishi	0749
Motorola	0869
Next Level	0869
Panasonic	0247, 0701
Paysat	0724
Philips	1142, 0749, 0724, 1076, 0722, 1749
Proscan	0392
RCA	0392, 0566, 0855, 0143
Radioshack	0869
SKY	0856
Samsung	1109
Sony	0639
Star Choice	0869
Toshiba	0749, 0790, 1749
Uniden	0724, 0722
Zenith	0856, 1856

AMPLIFIER BRAND	CODE
Aiwa	0406
Bose	0674
Carver	0269
Curtis Mathes	0300
Denon	0160
GE	0078
Harman/Kardon	0892
JVC	0331
Left Coast	0892
Linn	0269
Luxman	0165
Magnavox	0269
Marantz	0269, 0321, 0892
NEC	0264
Nakamichi	0321
Optimus	0395, 0300
Panasonic	0308, 0521
Parasound	0246
Philips	0269, 0892
Pioneer	0013, 0300
Polk Audio	0269, 0892
RCA	0300
Realistic	0395
Sansui	0321
Shure	0264
Sony	0689, 0220
Soundesign	0078, 0211
Technics	0308, 0521
Victor	0331
Wards	0013, 0078, 0211
Yamaha	0354, 0133

RECEIVER BRAND (Amplifier)	CODE
ADC	0531
Adcom	0616
Aiwa	1089, 1405, 0121, 0158, 0189, 0405, 1321, 1388
Akai	0076, 0224
Alco	1390
Anam	1074, 1609
Apex Digital	1257
Arcam	1120
Audiotronic	1189
Audiovox	1390
Bose	1229
Capetronic	0531
Carver	1089, 1189, 0008, 0042, 0189, 0360
Casio	0195
Celestion	1264
Clarinet	0195
Compaq	1136
Curtis Mathes	0080
Denon	1104, 0004, 0273, 0771, 1311, 1360
Emerson	0424
Fisher	0042, 0219, 0360
GPX	1299
Garrard	0424, 0463
Glory Horse	1263
Harman/Kardon	0891, 0110, 0189
Hewlett Packard	1181
Inkel	0062
JBL	0110, 1306
JVC	0074, 1263, 1374
Kenwood	1313, 1027, 1570, 1569, 0027, 0042, 0077, 0186, 0313, 0314, 0569, 1051, 1052
Koss	0424, 1366
LXI	0181
Lexicon	1076
Linn	0189
Lloyd's	0195
MCS	0039, 0346
Magnavox	1089, 1189, 0128, 0189, 1189, 0039, 0128, 0189

Marantz	1089, 1189, 0039, 0128, 0189
Modulaire	0195
Musimagic	1089
NAD	0320
NEC	0235
Nakamichi	0097, 0347
Onkyo	0100, 0135, 0380, 0842, 1298
Optimus	1023, 0042, 0080, 0177, 0181, 0186, 0219, 0531, 0670, 0738, 0801, 1074
Panasonic	1518, 0039, 0309, 0367, 0518, 1288, 1350
Penney	0195
Philips	1089, 1189, 1269, 0189, 0391, 1120, 1268, 1283
Pioneer	1023, 0014, 0080, 0150, 0244, 0531, 0630, 1343, 1384
Polk Audio	0189
Proscan	1254
Quasar	0039
RCA	1023, 1254, 0054, 0080, 0346, 0360, 0530, 0531, 1074, 1154, 1390, 1609
Radio Shack	1263
Realistic	0163, 0181, 0195
Samsung	1295
Sansui	0189, 1089, 0193, 0346
Sanyo	0219, 0801, 1251
Scott	0163, 0322
Sharp	0186
Sherwood	0062, 0491, 0502, 1653
Sony	1058, 1258, 1158, 0158, 0168, 0474, 1042, 1458, 1758
Soundesign	0670
Stereophonics	1023
Sunfire	1313, 0313, 0314, 1052
Teac	0463, 0163, 1074
Technics	1308, 1309, 1518, 0039, 0208, 0309, 0518
Thorens	1189
Victor	0074
Wards	0014, 0054, 0080, 0158, 0189
Yamaha	0176, 0186, 1176
Yorx	0195
Zenith	0857

AUDIO BRAND	CODE
Aiwa	0010, 0159
AudioSource	0351
Cambridge Soundworks	0351
Carver	0351
Fisher	0052
Fosgate	0259
Harman/Kardon	0477
JBL	0477
JVC	0073
KLH	0351
Magnavox	0325
Nikko	0376
Paramount Pictures	0317, 0351
RCA	0056
SSI	0317
Sansui	0325
Schneider	0376
Sony	0010, 0576
Soundesign	0376
Yorx	0376

SET TOP BOX BRAND	CODE
Panasonic	1120
Pioneer	1010
Princeton	0113, 0295
Samsung	1190
Sensory Science	1126
Sharp	1010
Sony	0639

PERSONAL VIDEO RECORDER BRAND	CODE
Panasonic	0616
Philips	0618
ReplayTV	0614, 0616
SonicBlue	0614, 0616
Sony	0636
Tivo	0618, 0636



# THE REMOTE CONTROL

In addition to controlling all the functions on your HITACHI Projection TV, the new remote control is designed to operate different types of VCRs, CATV (Cable TV) converters, set-top-box, satellite receiver, DVD players, and other audio/video equipment with one touch. Basic operation keys are grouped together in one area.

To operate your TV, point the remote control at the screen of the TV and press the TV button. The TV button will blink, indicating that the remote will now control your television.

To operate your VCR, point the remote at the remote sensor of the VCR and press the VCR button. The VCR button will blink, indicating that the remote will now control your VCR (see page 37 for instructions on how to program the remote to control your VCR).

To operate your cable box, point the remote at the remote sensor of the cable box and press the CABLE (CBL) button. The CBL button will blink, indicating that the remote will now control your cable box (see page 38 for instructions on how to program the remote to control your cable box).

To operate your set-top-box or satellite receiver point the remote at the remote sensor of the set-top-box and press the SET-TOP-BOX (STB) button. The STB button will blink, indicating that the remote will now control your set-top-box. If you have a satellite receiver, use this button to program your satellite receiver (see page 39 for instructions on how to program the remote to control your set-top-box).

To operate your DVD player, point the remote at the remote sensor of the DVD player and press the DVD button. The DVD button will blink, indicating that the remote will now control your DVD player (see page 40 for instruction on how to program the remote to control your DVD player).

To operate your PVR (Personal Video Recorder), point the remote at the remote sensor of the PVR and press the PVR button. The PVR button will blink, indicating that the remote will now control your PVR (see page 41 for instruction on how to program the remote to control your PVR).

To operate additional audio equipment, point the remote at the remote sensor of the component you wish to control and press the CD or AMP button. This button will blink, indicating that the remote will now control the desired component (see page 42 for instructions on how to program the remote to control additional Audio/Video equipment).

THE REMOTE CONTROL

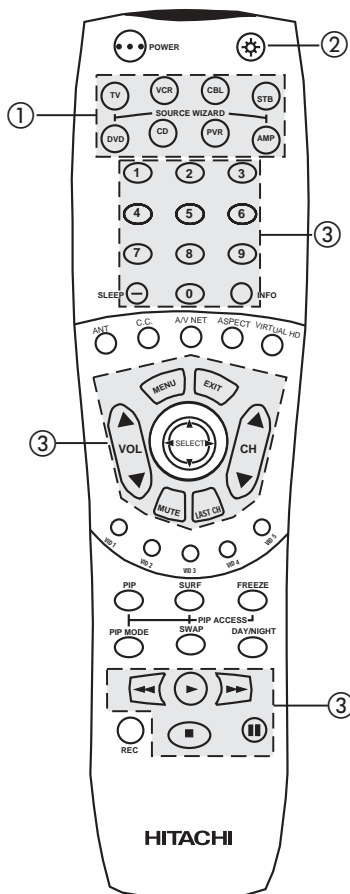

① These buttons allow the remote to control your TV, VCR, cable box, satellite receiver, DVD player, or other Audio/Video equipment depending on which mode is chosen, as explained above.

②,③ **LIGHT BUTTON**  
When you are in a dark room, press the light button ② on the remote to light up the buttons shown in ③ and the source button will blink. The light will stay on for about 8 seconds if the light button is not pressed again. These buttons will not appear to light if the room is too bright.





# HOW TO USE THE REMOTE TO CONTROL YOUR TV

## THE REMOTE CONTROL

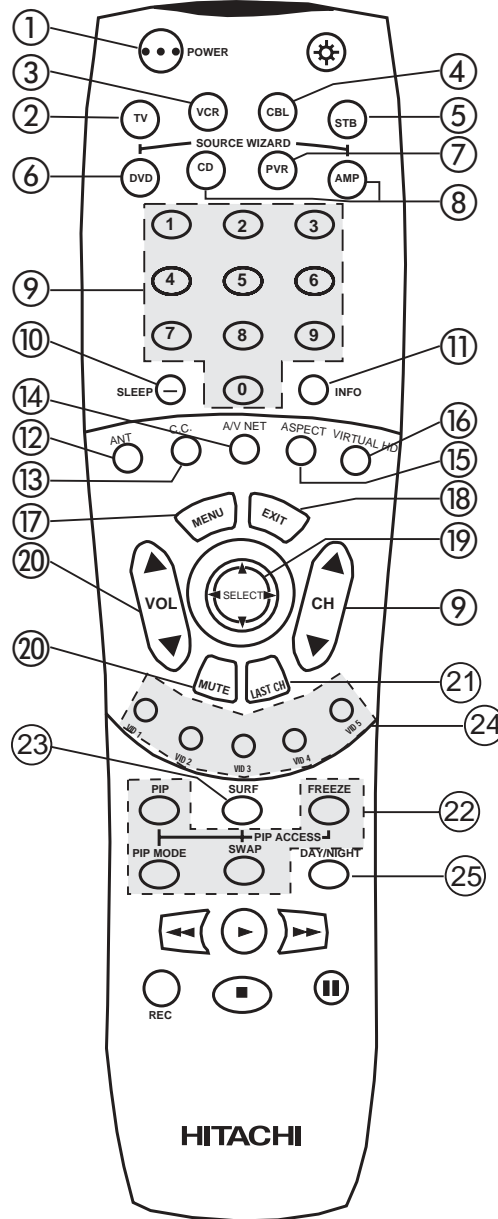

- ① **POWER button**  
Press this button to turn the TV set on or off when the remote is in TV mode (see page 23 for instructions on how to set the remote control to TV mode).
- ② **TV button**  
When the TV button is pressed, it will blink, to indicate the remote is in TV mode.
- ③ **VCR button**  
When the VCR button is pressed, it will blink to indicate the remote is in VCR mode (see page 37).
- ④ **CABLE (CBL)**  
When the CABLE button is pressed, it will blink to indicate the remote is in CABLE mode (see page 38).
- ⑤ **SET-TOP-BOX (STB)**  
When the STB button is pressed, it will blink to indicate the remote is in STB mode (see page 39).  
If you have a Satellite receiver, use this button to program your Satellite receiver (see page 39).
- ⑥ **DVD button**  
When the DVD button is pressed, it will blink to indicate the remote is in DVD mode (see page 40).



# HOW TO USE THE REMOTE TO CONTROL YOUR TV



## 7 PVR (Personal Video Recorder) button

When pressed, this button will blink to indicate the remote is in PVR mode (see page 41).

## 8 CD and AMP buttons

When pressed, each of these buttons will blink to indicate the remote is in Audio mode (see page 42).

## 9 CHANNEL selector buttons

CHANNEL selector buttons are used to select channels, lock access code, etc.

Enter one, two, or three numbers to select channels. Enter "0" first for channels 1 to 9, or simply press the single digit channel you wish to tune then wait a few seconds for the TV to tune. For channels 100 and above, press the "1" button, wait until two dashes appear next to the channel display on your TV, then enter the remaining two numbers using the number buttons.

Channel selection may also be performed by pressing CH up (▲) or down (▼).

**NOTE:** The TV may not receive some channels if you are not in the correct ANTENNA/CABLE mode (see page 54).

## 10 SLEEP and (-) DASH button

Press this button to display the sleep timer in the lower left corner of the screen. Every subsequent press of this button will add 15 minutes to this timer, up to a maximum of three hours. Once set, use INFO when you want to view time remaining. If the SLEEP button is pressed while the timer is set, it will reset to the original condition. The DASH (-) button can only be used when the remote control is in Set-Top-Box (STB) mode.

## 11 INFO button

Press this button when you want to check the channel being received, the picture source, if the channel has stereo (ST) or second audio program (SAP), the time, CHANNEL ID and if the SLEEP timer is set.

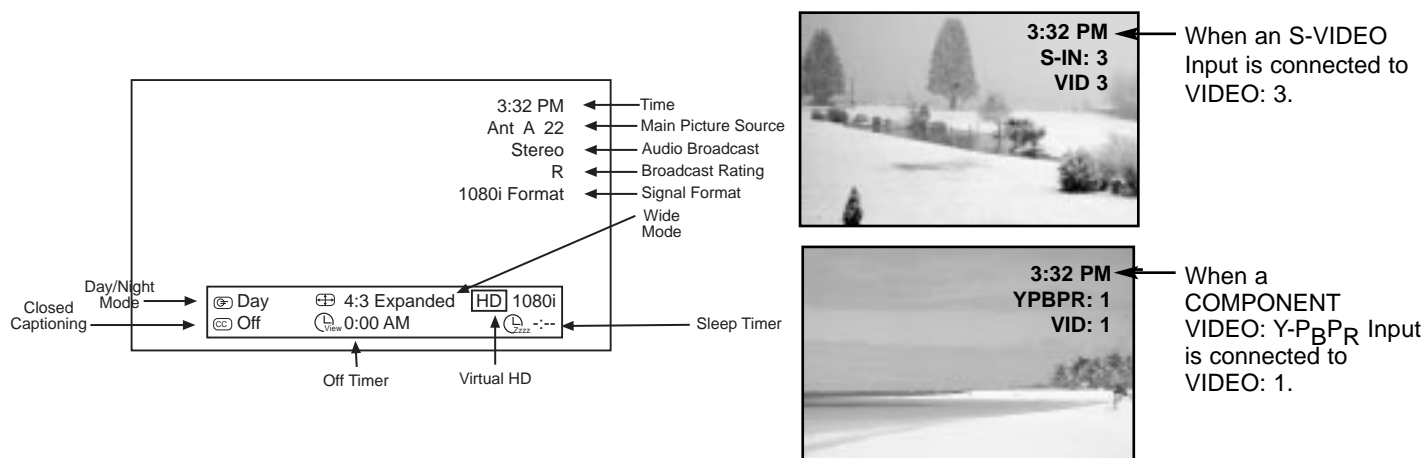

THE REMOTE CONTROL

## 12 ANTENNA button

The ANT button will select between Antenna A and Antenna B each time the button is pressed.

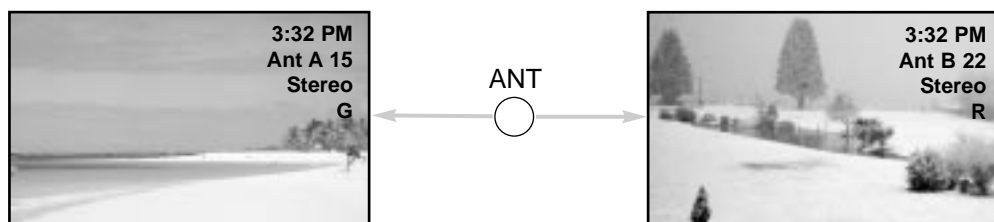

## 13 C.C. button

Press this button to quickly turn the Closed Caption feature on, off and auto. You can also access this feature on the Setup menu (See page 71).



# HOW TO USE THE REMOTE TO CONTROL YOUR TV

## 14 AV NET button

Press this button to access the Audio/Video network (AV Net) menu. The AV Net allows the user to control external components with the Projection TV's remote control. When you press the AV NET button, the following window will pop up within the Display Monitor screen. The window will disappear after 30 seconds if you don't press any buttons.

The AV Net Setup Wizard will automatically start upon the very first use. (see page 20-22).

THUMBSTICK ▲ or ▼ to highlight the equipment you wish to control or setup and then press THUMBSTICK ►.

Use THUMBSTICK ▲, ▼, ◀, ▶ to navigate and SELECT to select button. The command on the button is passed through the IR mouse and onto the AUDIO/VIDEO equipment. These on-screen buttons are called "Soft Keys".

Customize your Audio/Video equipment list and soft keys by selecting the "Custom" icon and following the instructions of the AV NET learning wizard (see page 30).

This window shows the available Audio/Video equipment soft keys. The equipment list will scroll up or down.

THE REMOTE CONTROL

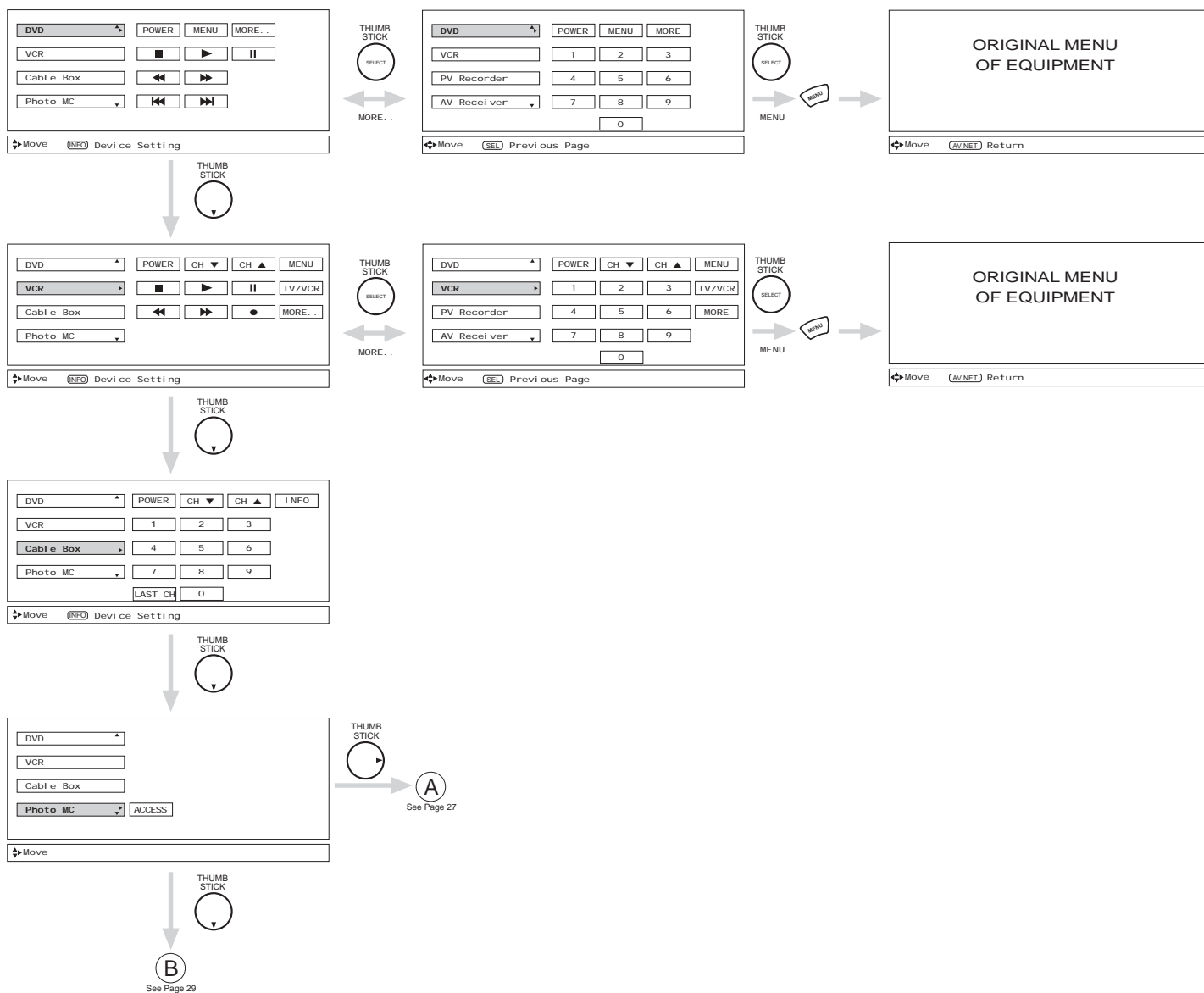

**NOTE:** To access the cursor function of a specific equipment (Ex. DVD, VCR), select the "MENU" soft key on OSD, and press the MENU button of the Projection TV remote control. Then THUMBSTICK and EXIT button of the Projection TV remote control is available to control the cursor of the equipment.

# HOW TO USE THE REMOTE TO CONTROL YOUR TV



## Photo MC

The Photo MC feature is useful for viewing digital still pictures from your digital camera using a memory card and displaying them on the TV screen. Insert Photo MC (memory card) to be viewed to a PC Card adapter. Insert the loaded PC Card adapter to the Photo MC slot of the control panel in the front of the TV.

Press THUMBSTICK **▶** to view the digital photos in THUMBNAIL view.  
 Use THUMBSTICK **◀, ▶, ▲, ▼** to select individual photos.  
 Press SELECT to view and enlarge individual photos.  
 Press SELECT once again to switch enlarged photo back to THUMBNAIL view.  
 Press MENU to access the PHOTO MC menu.  
 Press THUMBSTICK **▲, ▼** to highlight menu item.  
 Press SELECT to choose the menu item.  
 Press EXIT to quit menu.

### LED Light and OSD Indicator

Memory Card	Detail Information (OSD and LED)
Accessing	LED Blinking
Normal	LED always On
Card not inserted	"No Memory Card"
FAT32	"Memory Card is not available"
Not available format	"Memory Card is not available"
Abnormal	"Memory Card is not available"
No File	"No File"

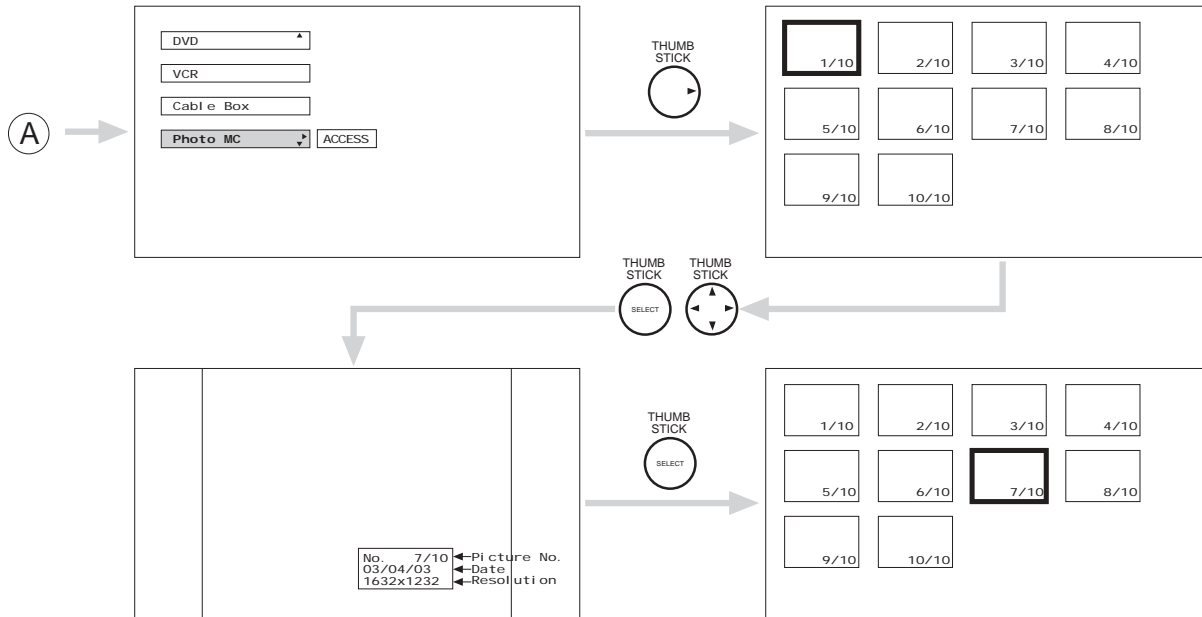

### JUMP

Select this menu item to view the chosen picture number.

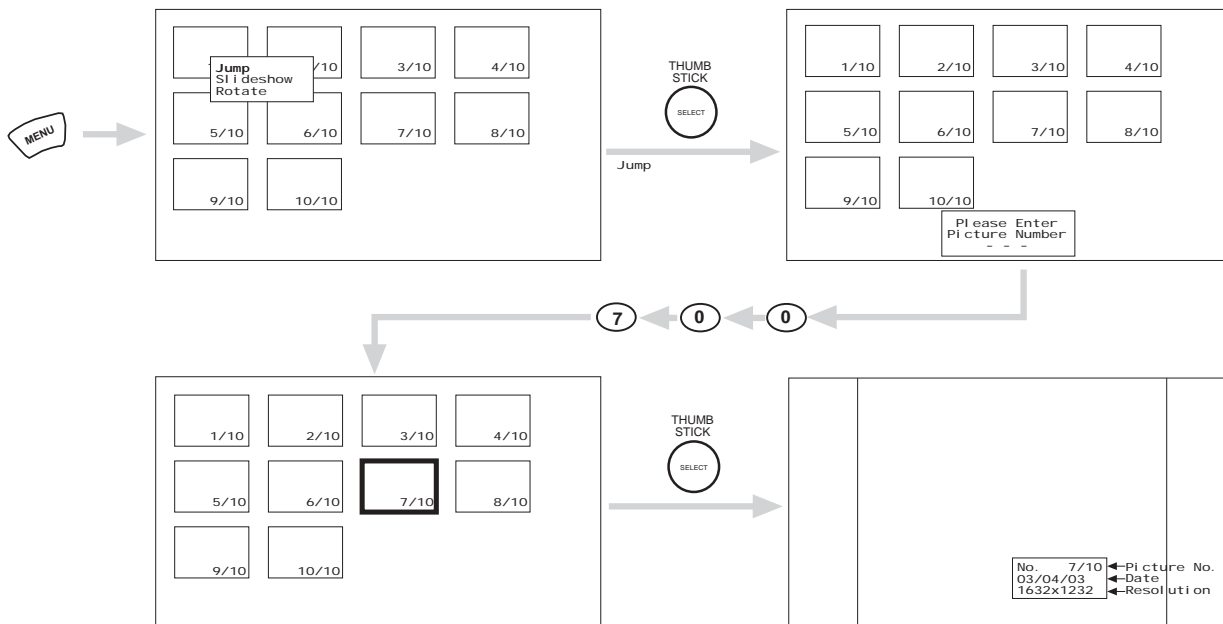

- NOTE:**
1. Contrast will decrease automatically if stationary images such as digital still photos are left on the screen for more than 3 minutes.
  2. The maximum number of digital Photos that can be displayed is 500.



# HOW TO USE THE REMOTE TO CONTROL YOUR TV

## SLIDESHOW

Select this menu item to start a slideshow of the Photos in the memory card. Time interval selections can be set from 5, 10 and 30 seconds.

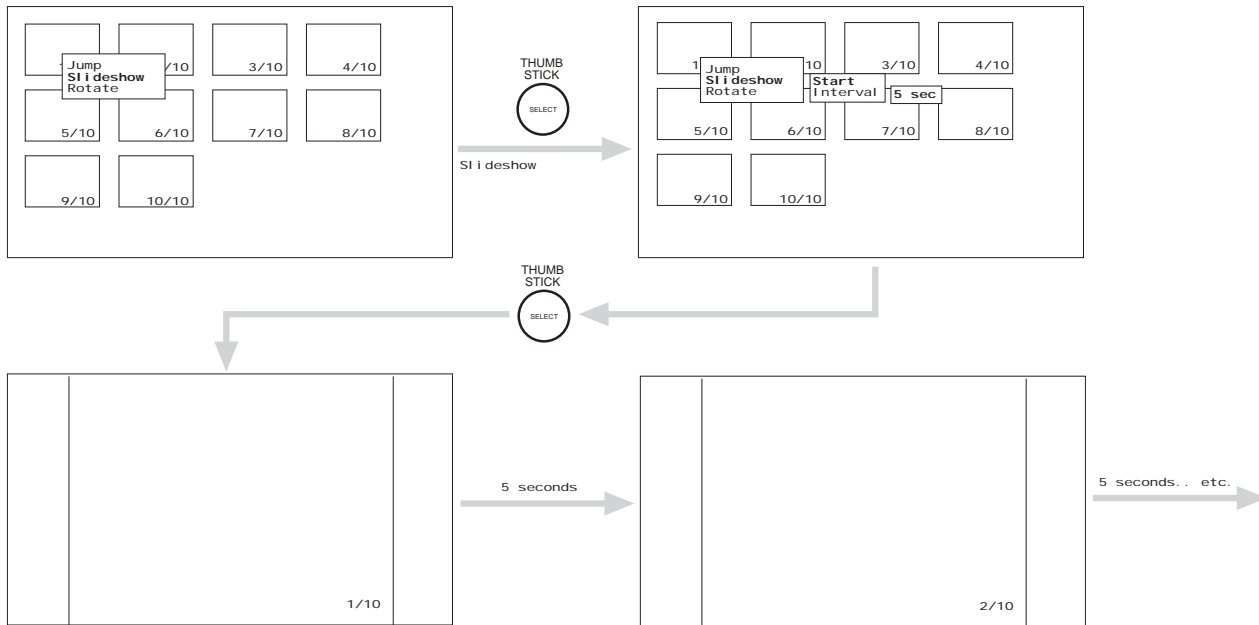

Use THUMBSTICK ▲, ▼ to highlight Slideshow item.

While interval is highlighted, press SELECT to change interval time from 5, 10 and 30 seconds. Each press will change interval time from the three mentioned choices.

Press SELECT to stop on a chosen picture of the slideshow. After 30 seconds, the slideshow will resume or press SELECT again to continue the slideshow.

Press EXIT to exit the slideshow.

## ROTATE

Select this menu item to rotate selected photos either clockwise (THUMBSTICK ►) and counterclockwise (THUMBSTICK ◀).

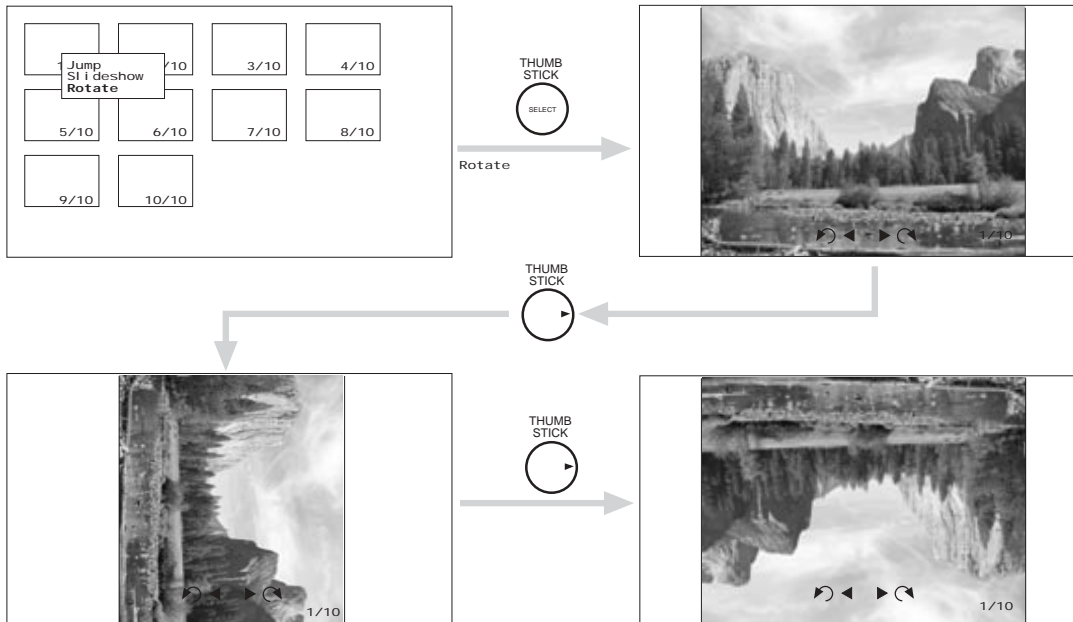

- NOTES:**
1. Photo file names modified on a computer should be 8 characters (Ex. ABCD1234.jpg). 1st character: letters; 2nd to 4th: letters or numbers; 5th to 8th: numbers. Photo files should be first placed on a sub directory name with 8 characters (Ex. 123ABCDE). 1st to 3rd: number; 4th to 8th: letters. The sub directory then should be placed on a main directory with a "dcim" file name format.
  2. Supported image types are from VGA (640 x 480) up to UXGA (1600 x 1200); JPEG format should conform with DCF Standard (Design rule for Camera File System).
  3. This TV set displays only digital pictures from digital cameras which meet DCF Standard. Pictures that were copied, edited or modified on a computer may not be displayed on the TV set.

# HOW TO USE THE REMOTE TO CONTROL YOUR TV



(B)

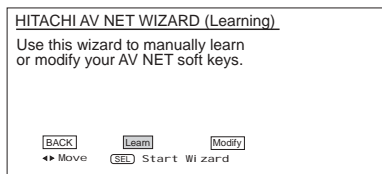
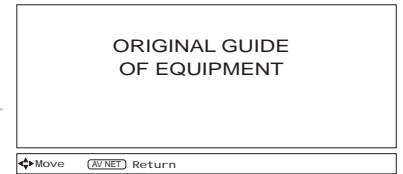
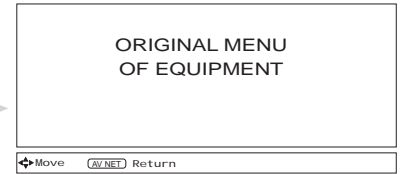
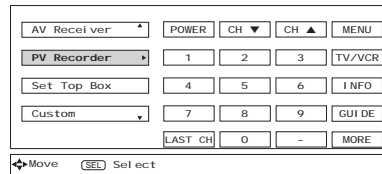
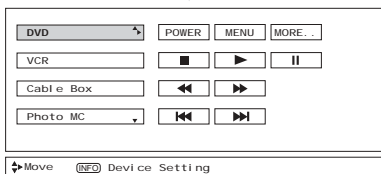
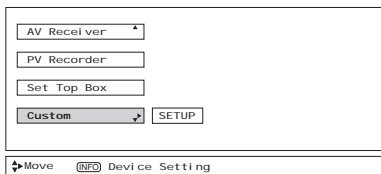
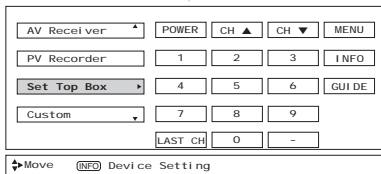
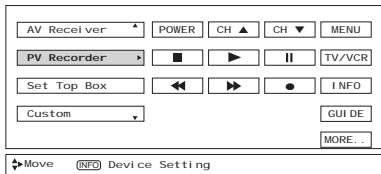
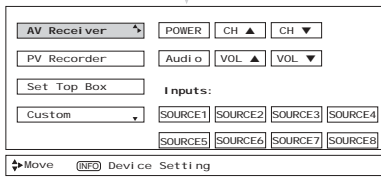

See Page 30

THE REMOTE CONTROL

**NOTE:** To access the cursor function of a specific equipment (Ex. PV Recorder), select the "MENU" soft key on OSD, and press the MENU button of the Projection TV remote control. Then THUMBSTICK and EXIT button of the Projection TV remote control is available to control the cursor of the equipment.



# HOW TO USE THE REMOTE CONTROL TO CONTROL YOUR TV

## AV NET LEARNING WIZARD

This function of the AV NET makes it more expandable because it allows the user to use equipment that is not supported by the pre-code library, listed on page 22. For example, after programming your equipment to the AV NET and the soft keys do not work, the user just has to follow the steps below. The AV NET Learning Wizard will transfer any remote button IR code of your equipment to the soft keys of your AV NET. If all remote button transfers are successful, the user can now control their equipment by using the TV remote control.

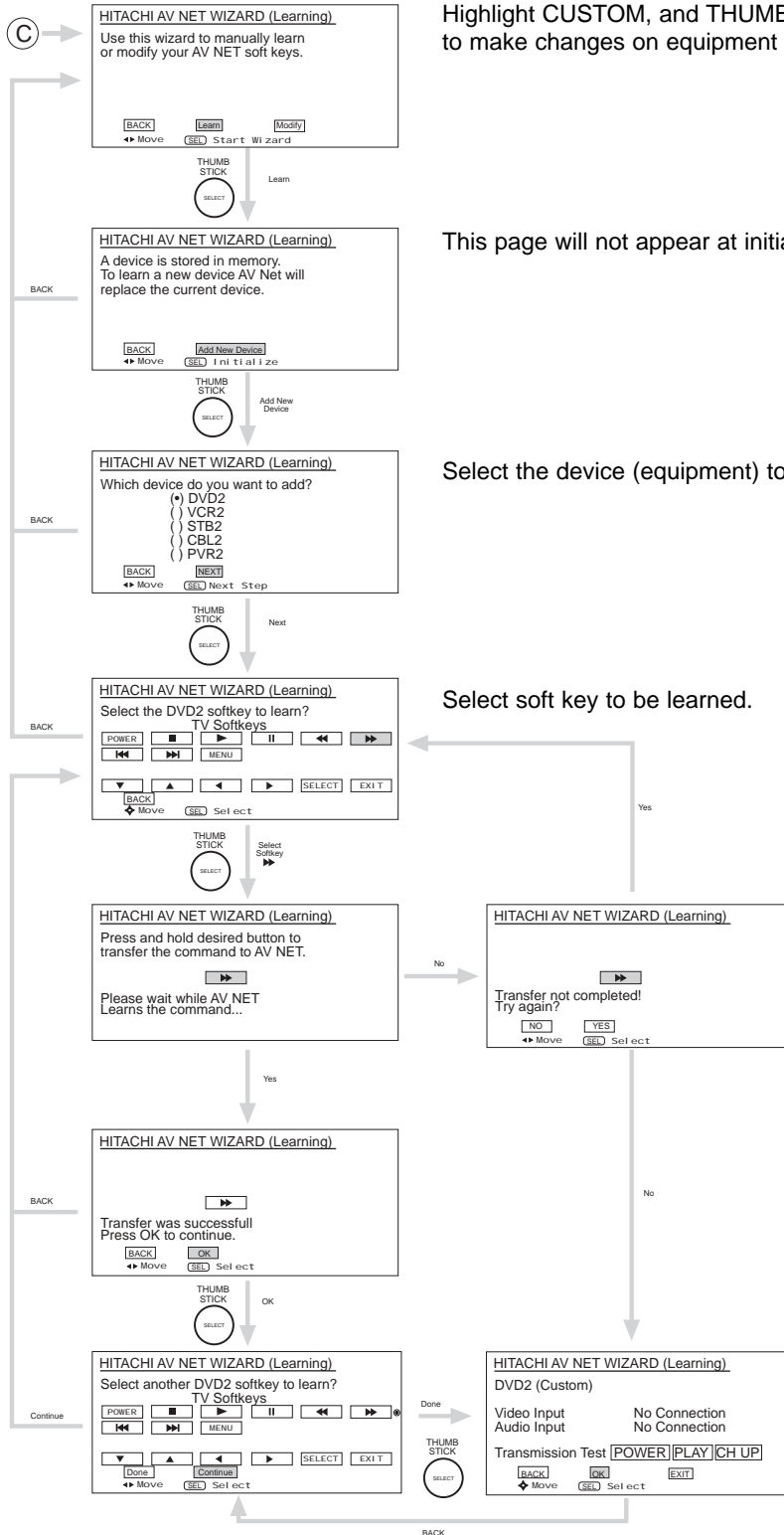

Highlight CUSTOM, and THUMBSTICK ► to enter AV NET WIZARD. Select MODIFY to make changes on equipment already stored in the CUSTOM memory.

This page will not appear at initial set up.

Select the device (equipment) to be added for soft key learning.

Select soft key to be learned.

**NOTE:** To access the cursor function of a specific equipment (Ex. DVD), select the "MENU" soft key on OSD, and press the MENU button of the Projection TV remote control. In order to use THUMBSTICK and EXIT button of the Projection TV remote control, "arrows, select, and EXIT" button must be learned. Then the menu of the programmed equipment can be controlled with the Projection TV remote control.

Device	Code	Video	Audio
DVD	0672	INPUT 1	Using TV
VCR	----	Not Setup	Not Setup
CBL	----	Not Setup	Not Setup
STB	----	Not Setup	Not Setup
PVR	----	Not Setup	Not Setup
AVR	----	Not Setup	Not Setup
DVD2	----	Not Setup	Not Setup

**NOTE:** It is very important to point the equipment's remote control directly to the LEARNING AV NET sensor located on the TV screen (see page 7) while trying to transfer the desired remote control button to the AV NET.

# HOW TO USE THE REMOTE CONTROL TO CONTROL YOUR TV



## 15 ASPECT button

Press this button to quickly change the picture format ASPECT ratio.

Depending on the input signal, the picture format ratio allows you to adjust the images through the following options.

- 4:3 Standard Use this aspect mode to display conventional (4:3) images. Side panels (gray areas) are placed to the left and right of the image to preserve the original aspect ratio of the source. Note: Use this mode for only 15% of your total viewing time to prevent uneven aging of the phosphors. Phosphors in the lighted area of the picture will age more rapidly than the black areas.
- 4:3 Expanded use this aspect mode to display conventional (4:3) sources by expanding the outer edges of the image to fill the 16:9 screen. The center of the image remains unaltered.
- 4:3 Zoom1/Zoom2 Use these aspect modes to zoom in on conventional (4:3) sources.
- 16:9 Standard Use this aspect mode to display 16:9 sources like HDTV and DVD's preserving the original 16:9 aspect ratio.
- 16:9 Zoom Use this aspect mode to zoom 16:9 images.

### (1) NTSC/480i/480p Input

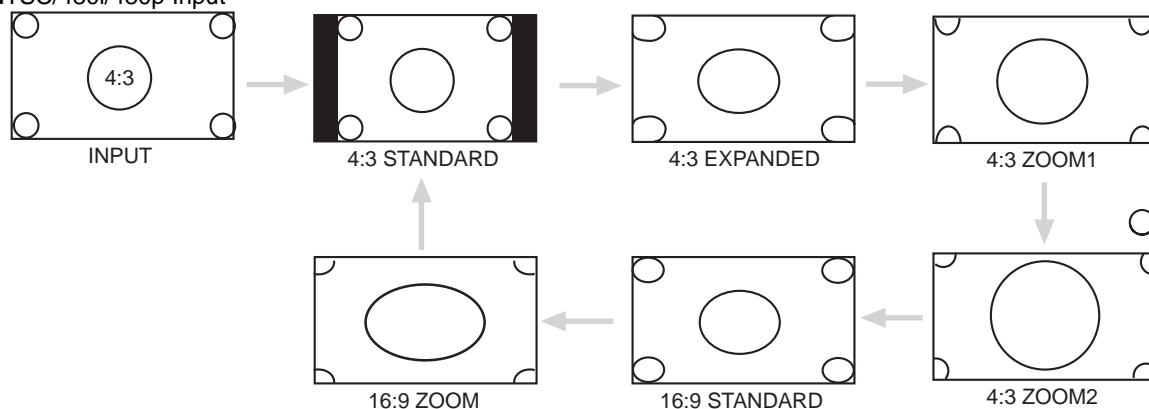

### (2) 480i/480p INPUT

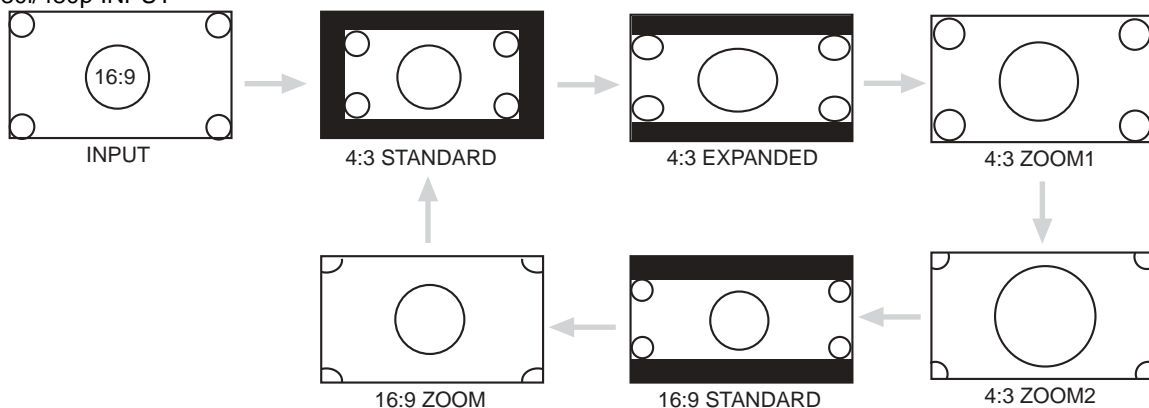

### (3) 720p/1080i INPUT

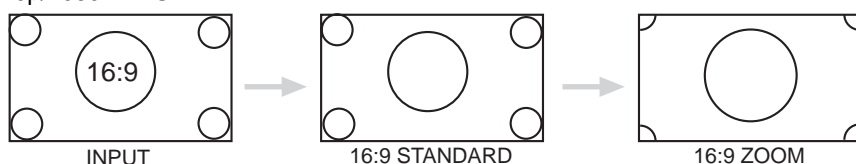

**NOTE:** The Aspect Style setting you select for an ANT input will automatically be set for the other ANT inputs. However, all five video inputs have independent Aspect Style settings.

THE REMOTE CONTROL



# HOW TO USE THE REMOTE TO CONTROL YOUR TV

## 16 VIRTUAL HD button

Press this button to toggle between 1080i and 540p.

540p and 1080i represent two ways to display the TV signal.

- Progressive: The “p” in 540p tells you that the display is showing you the picture in the progressive format. With the progressive format the complete picture is created by drawing lines across the screen from left to right which fill the screen from the top to the bottom. If you look very closely at the screen there will be a very small space between each line. The progressive format is good for displaying fast moving programs such as a sporting event.
- Interlaced: The “i” in 1080i tells you that the display is showing you the picture in the interlaced format. With the interlaced format the picture is created by drawing lines across the screen from left to right which fill the screen from top to bottom, and then returning to the top and drawing another set of lines in between the first set. The TV draws the lines so fast that our eyes can’t see them. If you look very closely at the screen you will notice a smoother image than with the progressive format. The interlaced format is good for displaying detailed images like feature films.
- You can compare the progressive and interlaced formats by toggling the “VIRTUAL HD” button on the remote control. Some people like the crisp picture from 540p and some people like the smooth and detailed 1080i. Hitachi offers you the choice.

**NOTE:** The VIRTUAL HD button will not change the picture with a 1080i HDTV input. HDTV signals bypass the VIRTUAL HD circuitry and are shown in their native 1080i format.

## 17 MENU button

The MENU button will start the On-Screen Display.

## 18 EXIT button

When in MENU mode, this button will exit all On-Screen Displays.

## 19 THUMB STICK/SELECT button

All the On-Screen Display features can be set or adjusted by using the THUMB STICK, except for numeric entries.

The THUMB STICK will highlight functions or adjust and set different features. Press the THUMB STICK toward desired direction and press down to SELECT.

THE REMOTE CONTROL

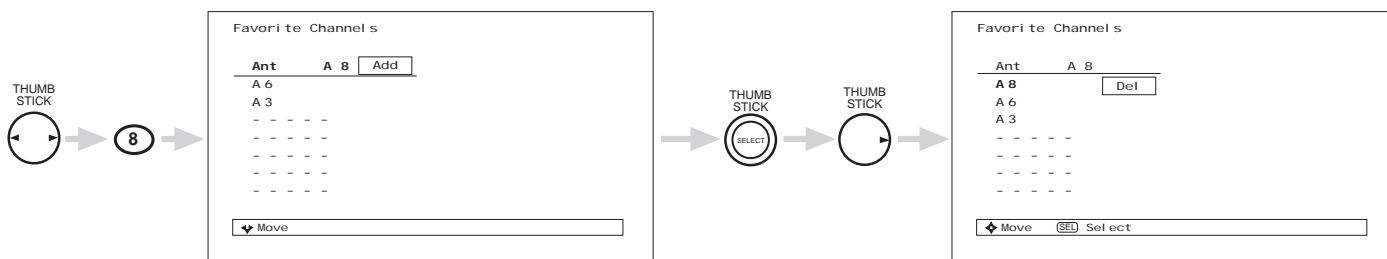

When no on-screen displays are on the TV screen, use THUMB STICK ◀ or ▶ to access the Favorite Channels feature.

To add channels to Favorite Channels, use the number keys to enter the channel number. Use THUMB STICK ▶ to highlight “Add”, then press SELECT to store the channel to the Favorite Channel feature.

To delete (Del) the channel from the Favorite Channel, use THUMB STICK ▲ , ▼ to highlight the channel, then THUMB STICK ▶ to highlight Delete (Del) and press SELECT to delete.

To view a Favorite Channel use THUMB STICK ▲ , ▼ to highlight the channel and press SELECT to view.

## 20 VOLUME, MUTE button

Press the VOLUME up (▲) or down (▼) button until you obtain the desired sound level.

To reduce the sound to one half of normal volume (SOFT MUTE) to answer the telephone, etc., press the MUTE button. Press the MUTE button again to turn the sound off completely (MUTE). To restore the sound, press the MUTE button one more time, or press the VOLUME Up (▲) button.



Closed Captioning will display when MUTE/SOFT MUTE is on and Closed Caption is set to AUTO (see page 71).



# HOW TO USE THE REMOTE TO CONTROL YOUR TV



## 21 LAST CHANNEL (LAST CH) button

Use this button to select between the last two channels viewed (Good for watching two sporting events, etc.).

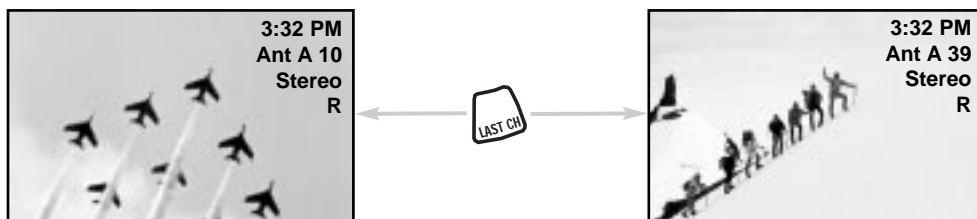

## 22 PICTURE-IN-PICTURE buttons

See separate section on pages 34-36 for a description.

## 23 SURF button

Press the SURF button to automatically scan all active channel numbers (those set in memory) and display them as PIP sub-pictures. Press the SURF button a second time to remove the sub-pictures from the screen.

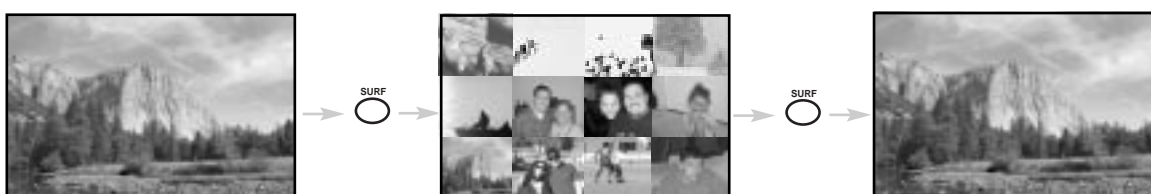

- NOTES:**
1. If no buttons are pressed when in SURF mode, auto-scanning will continuously scan channels in memory (see page 55).
  2. If a channel is changed during this SURF scanning, sub-pictures will be removed from the screen.
  3. If MOVIE/TV RATINGS LOCK setting is ON, PIP SURF mode will be deactivated.
  4. CLOSED CAPTION will not appear when PIP SURF mode is on.
  5. The SURF button will only work in ANT A and ANT B.
  6. While in SURF scanning mode, press SELECT on the remote control to stop on a chosen channel. Press SELECT again to resume SURF scanning.

## 24 VID1 ~ VID5

When the remote control is in TV mode, press these buttons to directly select the video input sources between the five video inputs.

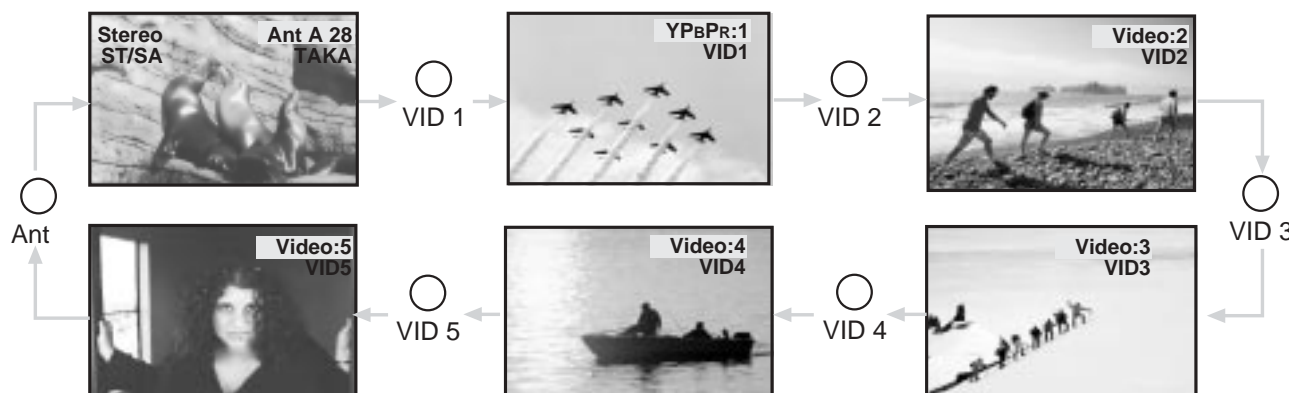

## 25 DAY/NIGHT button

Press this button to toggle between Day and Night picture mode settings. Select Day for day time viewing with more brightness and contrast to compete with room light. Select Night for night time viewing with less brightness and contrast for a more detailed picture (see page 47 for settings changes).



# PICTURE-IN-PICTURE (PIP)

Your HITACHI Projection TV incorporates Dual Tuner technology designed for improved viewing enjoyment. This Dual Tuner feature allows you to view antenna inputs on both the main picture and sub-picture simultaneously, with separate tuning control for each. The Dual Tuner can operate with only one input (ANT A only) or two inputs (ANT A and ANT B).

ANT A input can be viewed as both the main picture and the sub-picture simultaneously. ANT B can only be viewed as a main picture. To select between main picture and PIP sub-picture tuning, press the SWAP button on the remote. The green highlighted channel display will move with every press of the SWAP button. When the top channel display is highlighted, channel tuning is for the main picture. When the lower channel display is highlighted, channel tuning is for the PIP sub-picture.

The Picture-in-Picture feature is convenient when you want to watch more than one program at the same time. You can watch a TV program while viewing other programs from the ANT A source or any of the video inputs.

THE REMOTE CONTROL

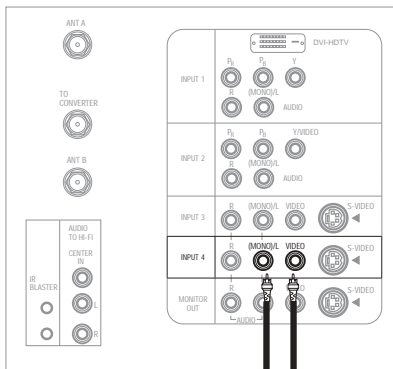

Models: 57T500  
65T500

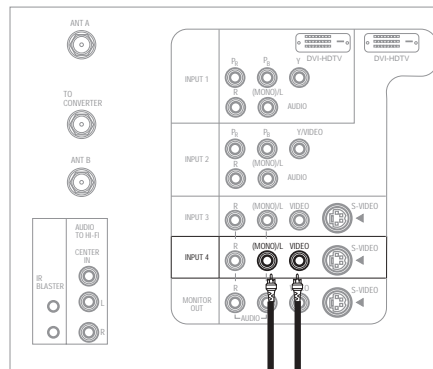

Models: 57X500  
65X500

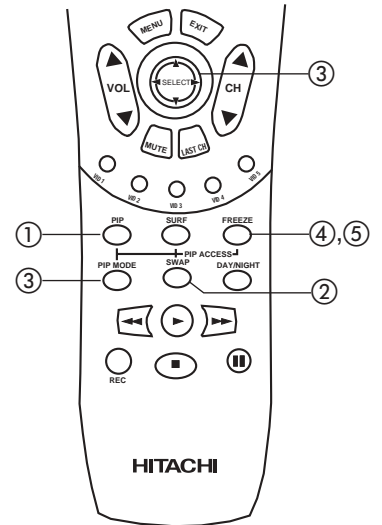

Use above connection to view VCR program as a sub-picture while viewing another program as main picture (ANT A, ANT B, V:1, V:2, V:3, or V:5). You may also view the VCR program as a main picture while viewing another program as a sub-picture (ANT A, V:1, V:2, V:3, or V:5).

## ① PIP button

Press the PIP button and a sub-picture will appear in one of the three different modes (POP, PIP and SPLIT), depending on the last selection of the PIP mode. To change the PIP mode, use the PIP MODE button to cycle through the three different modes.

### POP MODE PICTURE-IN-PICTURE

Press the PIP button and a sub-picture appears in one of the three different modes (POP, PIP and SPLIT), depending on the last selection of the PIP mode. Press the PIP button again to remove the sub-picture from the screen. Use the SWAP button to select between main and sub-picture tuning control (indicated by green highlighted channel display.) Press the VID1, VID2, VID3, VID4 or VID5 button when sub-picture channel tuning is being controlled, to change between VIDEO: 1, VIDEO: 2, VIDEO: 3, VIDEO:4, VIDEO:5 and ANT:A sources, (ANT B source cannot be viewed as a sub-picture.)

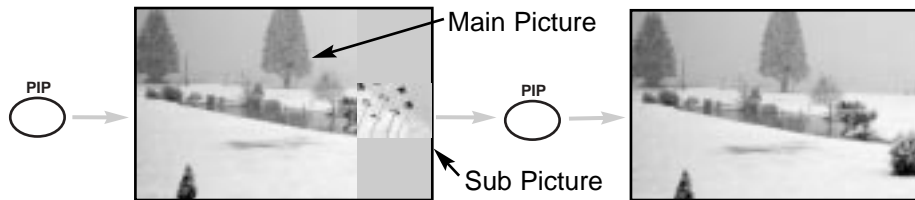

- NOTES:**
1. In POP mode, thumb stick CURSOR ▲, ▼ will move the sub-picture up/down.
  2. Only sound from the main picture can be heard.

### PIP MODE PICTURE-IN-PICTURE

This feature is only available with a 1080i input signal (Component and DVI-HDTV).

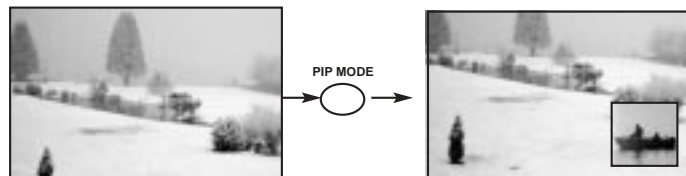



# PICTURE-IN-PICTURE (PIP)

## SPLIT MODE PICTURE-IN-PICTURE

Split Mode PIP displays the main picture and sub-picture evenly on the screen.

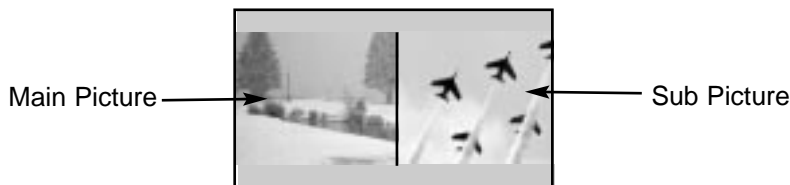

### ② SWAP button (with PIP ON)

Press this button to toggle between the Main and Sub picture which is highlighted with a green border around the picture. Picture sound and channel can be controlled when it is highlighted.

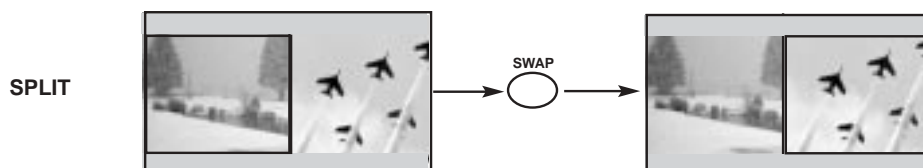

**NOTE:** The SWAP button will only operate in POP/PIP/SPLIT PIP mode.

### ③ PIP MODE button

To change between the available PIP modes (moving picture - SPLIT, POP or PIP; freeze picture - SPLIT, STROBE, MAIN and SUB) press the PIP MODE button when PIP is ON. Each press of this button will change PIP to a different mode. Pressing this button two times will cycle through both PIP modes.

#### a) Moving Picture

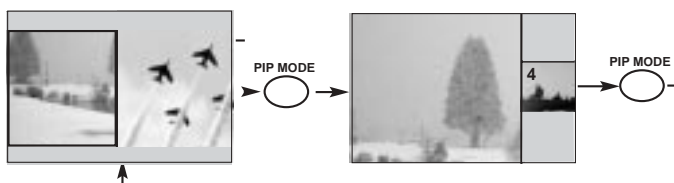

PICTURE-IN-PICTURE (PIP) MODES

	POP	PIP	SPLIT
NTSC (ANT A/B)	YES	x	YES
480i	YES	x	YES
480p	x	x	YES
720p	x	x	YES
1080i	x	YES	YES

**NOTE:** PIP modes will depend on the type of signal format received.

#### b) Freeze Picture

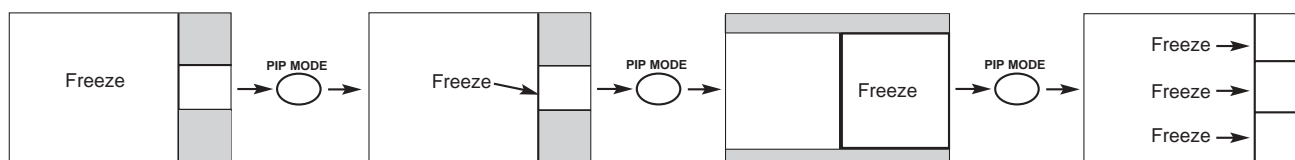

FREEZE MODES

	POP	PIP	SPLIT	STROBE
NTSC (ANT A/B)	YES	x	YES	YES
480i	YES	x	YES	YES
480p	x	x	YES	X
720p	x	x	YES	X
1080i	x	YES	YES	X

**NOTE:** Freeze modes will depend on the type of signal format received.



# PICTURE-IN-PICTURE (PIP)

## ④ FREEZE button (With PIP ON)

If you wish to freeze the sub-picture, press the FREEZE button. This is convenient when trying to write down the address for a mail order company, recording statistics for a sporting event, etc. To return the picture to motion, press the FREEZE button again.

**NOTE:** When PIP is on, the FREEZE function will only operate when POP/PIP/SPLIT mode is chosen.

## ⑤ FREEZE button (with PIP OFF)

Press the FREEZE button to freeze the picture, depending on the PIP mode selected (POP Main Freeze, POP Sub Freeze, SPLIT or STROBE).

To change FREEZE modes, use the PIP MODE button to cycle through the four different modes.

### POP MAIN FREEZE (with PIP OFF)

PIP FREEZE should be in POP Main mode. Press the FREEZE button to freeze one frame of the picture you are currently viewing and the frozen frame will show in the Main Picture. Press this button again or PIP to return to normal viewing. This feature is useful for freezing a picture frame with addresses.



### POP SUB FREEZE (with PIP OFF)

PIP FREEZE should be in POP Sub mode. Press the FREEZE button to freeze the sub-picture. Press the FREEZE button again or the PIP button to return to normal viewing.



### SPLIT FREEZE(with PIP OFF)

PIP FREEZE should be in SPLIT mode. Press the FREEZE button to freeze the picture you are currently viewing (only the right sub-picture will freeze). Press the FREEZE button again or the PIP button to return to normal viewing.

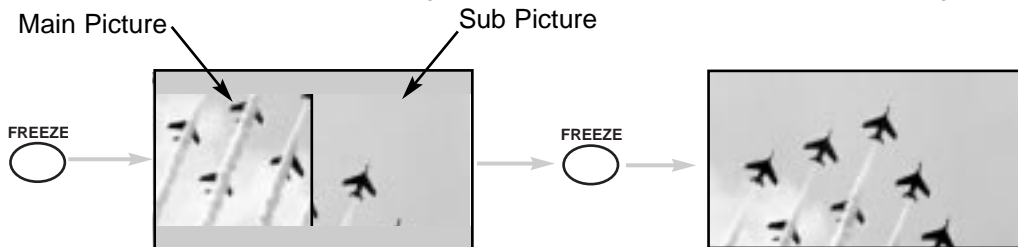

### STROBE FREEZE(with PIP OFF)

PIP FREEZE should be in STROBE mode. Press the FREEZE button to freeze three frames of the picture you are currently viewing. Press this button again or PIP to return to normal viewing. This feature is useful for viewing a moving picture that has many details, for example, a close play in a sporting event or a golf swing.

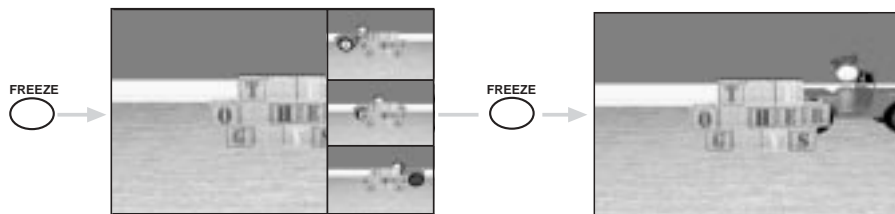

**NOTES:** Each freeze frame is delayed about 0.1 (1/10) second.

# USING THE REMOTE TO CONTROL VCR FUNCTIONS



## Operating the precoded function for your VCR.

This remote is designed to operate different types of VCRs. You must first program the remote to match the remote system of your VCR (refer to page 44 for pre-codes).

1. Turn ON your VCR.
2. Aim the remote control at the front of your VCR.
3. Press and release the VCR button to switch to VCR pre-coded mode.
4. Hold down the VCR button on the remote and enter the two digit preset code that matches your VCR, as shown on page 44. The indicator light will flash 3 times if the code was accepted.
5. Aim the remote at the VCR and press the POWER button. The remote will turn off your VCR when the correct two digit preset code is entered. When this occurs, the remote control is programmed for your VCR. If the VCR does not turn off, try a different two digit preset code.
6. The remote will now control your VCR.

### NOTES:

1. If your VCR cannot be operated after performing the above procedures, your VCR's code has not been precoded into the remote.
2. In the unlikely event that your VCR cannot be operated after performing the above procedures, please consult your VCR operating guide.
3. The remote control will remember the codes you have programmed until the batteries are removed from the remote control. After replacing the batteries repeat the entire programming procedure as stated above.
4. The MENU button will act as the VCR MENU button for HITACHI VCRs.
5. The LAST CH button will act as your VCR ENTER button if required.
6. The SLEEP button will act as your VCR '100' button if required.

### ① VCR Button

This button allows the remote to control your VCR by setting it to VCR mode.

### ② PRECODED VCR Buttons

These buttons transmit the chosen precoded VCR codes. For some VCRs, you must press the RECORD button twice to record a program.

### ③ EXCLUSIVE TV Buttons

These buttons are for operating the TV.

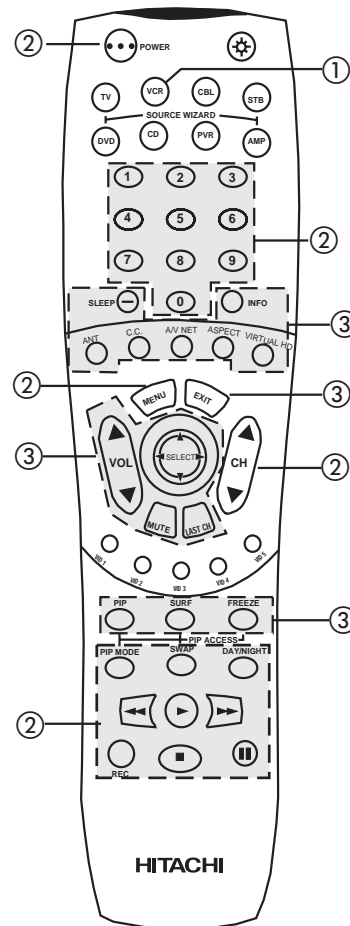

THE REMOTE CONTROL

MY VCR CODE IS: \_\_\_\_\_

**NOTE:** Refer to instruction manual of the VCR for operation of the buttons exclusively for the VCR.



# USING THE REMOTE TO CONTROL CABLE BOX FUNCTIONS

## Operating the precoded function for your cable box.

This remote is designed to operate different types of cable boxes. You must first program the remote to match the remote system of your cable box (refer to page 44).

1. Turn ON your cable box.
2. Aim the remote control at the front of your cable box.
3. Press and release the Cable (CBL) button to switch to Cable pre-coded mode.
4. Hold down the CBL button on the remote and enter the two digit preset code that matches your cable box as shown on page 44. The indicator light will flash 3 times if the code was accepted.
5. Aim the remote at the cable box and press the POWER button. The remote will turn off your cable box when the correct two digit preset code is entered. When this occurs, the remote control is programmed for your cable box. If the cable box does not turn off, try a different two digit preset code.
6. The remote will now control your Cable box.

### NOTES:

1. If your cable box cannot be operated after performing the above procedures, your cable box code has not been precoded into the remote.
2. In the unlikely event that your cable box cannot be operated after performing the above procedures, please consult your cable box operating guide.
3. The remote control will remember the codes you have programmed until the batteries are removed from the remote control. After replacing the batteries repeat the entire programming procedure as stated above.
4. The LAST CH button will act as the cable box ENTER button if required.
5. The SLEEP button will act as your cable box '100' button if required.
6. The ANT button will act as the TV/STB button when in STB mode.

THE REMOTE CONTROL

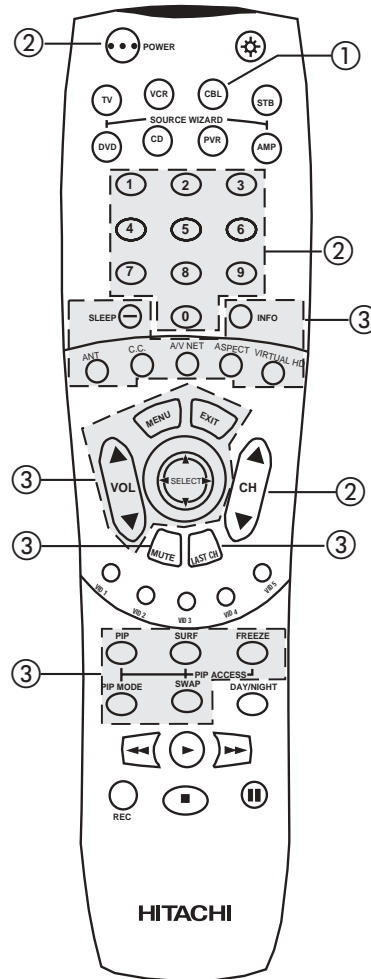

- ① **CABLE (CBL) button**  
This button allows the remote to control your cable box by setting it to CABLE mode.
- ② **PRECODED CABLE BOX buttons**  
These buttons transmit the chosen precoded cable codes.
- ③ **EXCLUSIVE TV buttons**  
These buttons are for operating the TV.

MY CABLE BOX CODE IS: \_\_\_\_\_

**NOTE:** Refer to instruction manual of the Cable Box for operation of the buttons exclusively for the Cable Box.



# USING THE REMOTE TO CONTROL SET-TOP-BOX/SATELLITE RECEIVER FUNCTIONS



## Operating the precoded function for your set-top-box/satellite receiver.

This remote is designed to operate different types of set-top-box/satellite systems. You must first program the remote to match the remote system of your set-top-box/satellite systems (refer to page 44).

1. Turn ON your set-top-box/satellite systems.
2. Aim the remote control at the front of your set-top-box/satellite systems.
3. Press and release the SET-TOP-BOX (STB) button to switch to set-top-box/satellite pre-coded mode.
4. Hold down the STB button on the remote and enter the two digit preset code that matches your set-top-box/satellite receiver as shown on page 44. The indicator light will flash 3 times if the code was accepted.
5. Aim the remote at the set-top-box/satellite receiver and press the POWER button. The remote will turn off your set-top-box/satellite receiver when the correct two digit preset code is entered. When this occurs, the remote control is programmed for your set-top-box/satellite receiver. If the set-top-box/satellite receiver does not turn off, try a different two digit preset code.
6. The remote will now control your set-top-box/satellite receiver.

### NOTES:

1. If your set-top-box/satellite receiver cannot be operated after performing the above procedures, your set-top-box/satellite receiver code has not been precoded into the remote.
2. In the unlikely event that your set-top-box/satellite receiver cannot be operated after performing the above procedures, please consult your set-top-box/satellite receiver operating guide.
3. The remote control will remember the codes you have programmed until the batteries are removed from the remote control. After replacing the batteries repeat the entire programming procedure as stated above.
4. The ANT button will act as the TV/STB button when in STB mode.

- ① **SET-TOP-BOX (STB) button**  
This button allows the remote to control your satellite receiver by setting it to SET-TOP-BOX/SATELLITE mode.
- ② **PRECODED SET-TOP-BOX/SATELLITE RECEIVER buttons**  
These buttons transmit the chosen precoded set-top-box/satellite codes.
- ③ **EXCLUSIVE TV buttons**  
These buttons are for operating the TV.

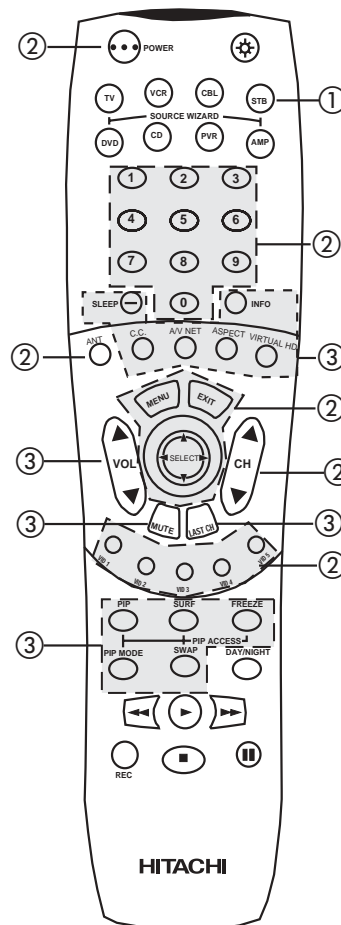

THE REMOTE CONTROL

**MY SATELLITE RECEIVER/STB CODE IS: \_\_\_\_\_**

**NOTE:** Refer to instruction manual of the set-top-box/satellite receiver for operation of the buttons exclusively for the set-top-box/satellite receiver.



# USING THE REMOTE TO CONTROL DVD FUNCTIONS

## Operating the precoded function for your DVD player.

This remote is designed to operate different types of DVD players. You must first program the remote to match the remote system of your DVD player (refer to page 44 for pre-codes).

1. Turn ON your DVD player.
2. Aim the remote control at the front of your DVD player.
3. Press and release the DVD button to switch to DVD pre-coded mode.
4. Hold down the DVD button on the remote and enter the two digit preset code that matches your DVD player, as shown on page 44. The indicator light will flash 3 times if the code was accepted.
5. Aim the remote at the DVD player and press the POWER button. The remote will turn off your DVD player when the correct two digit preset code is entered. When this occurs, the remote control is programmed for your DVD player. If the DVD player does not turn off, try a different two digit preset code.
6. The remote will now control your DVD player.
7. You will need to set the display type of your DVD player to 16:9 widescreen.

THE REMOTE CONTROL

### NOTES:

1. If your DVD player cannot be operated after performing the above procedures, your DVD player's code has not been precoded into the remote.
2. In the unlikely event that your DVD player cannot be operated after performing the above procedures, please consult your DVD player operating guide.
3. The remote control will remember the codes you have programmed until the batteries are removed from the remote control. After replacing the batteries repeat the entire programming procedure as stated above.

#### ① DVD Button

This button allows the remote to control your DVD player by setting it to DVD mode.

#### ② PRECODED DVD Buttons

These buttons transmit the chosen precoded DVD codes.

#### ③ EXCLUSIVE TV Buttons except number buttons

These buttons are for operating the TV. The number buttons can also be used for operating your DVD.

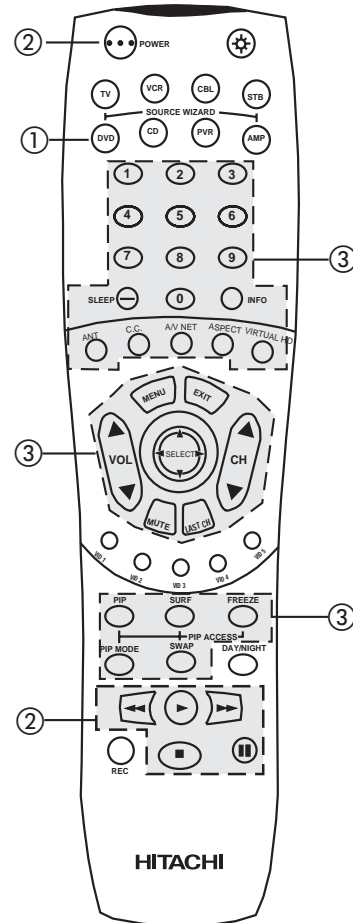

MY DVD PLAYER CODE IS: \_\_\_\_\_

**NOTE:** Refer to instruction manual of the DVD player for operation of the buttons exclusively for the DVD player.



# USING THE REMOTE TO CONTROL PVR FUNCTIONS



## Operating the precoded function for your PVR (Personal Video Recorder).

This remote is designed to operate different types of PVRs. You must first program the remote to match the remote system of your PVR (refer to page 44 for pre-codes).

1. Turn ON your PVR.
2. Aim the remote control at the front of your PVR.
3. Press and release the PVR button to switch to PVR pre-coded mode.
4. Hold down the PVR button on the remote and enter the two digit preset code that matches your PVR, as shown on page 44. The indicator light will flash 3 times if the code was accepted.
5. Aim the remote at the PVR and press the POWER button. The remote will turn off your PVR when the correct two digit preset code is entered. When this occurs, the remote control is programmed for your PVR. If the PVR does not turn off, try a different two digit preset code.
6. The remote will now control your PVR.

### NOTES:

1. If your PVR cannot be operated after performing the above procedures, your PVR's code has not been precoded into the remote.
2. In the unlikely event that your PVR cannot be operated after performing the above procedures, please consult your PVR operating guide.
3. The remote control will remember the codes you have programmed until the batteries are removed from the remote control. After replacing the batteries repeat the entire programming procedure as stated above.

### ① PVR Button

This button allows the remote to control your PVR by setting it to PVR mode.

### ② PRECODED PVR Buttons

These buttons transmit the chosen precoded PVR codes.

**NOTE:** The C.C. button functions as "replay".

### ③ EXCLUSIVE TV Buttons

These buttons are for operating the TV.

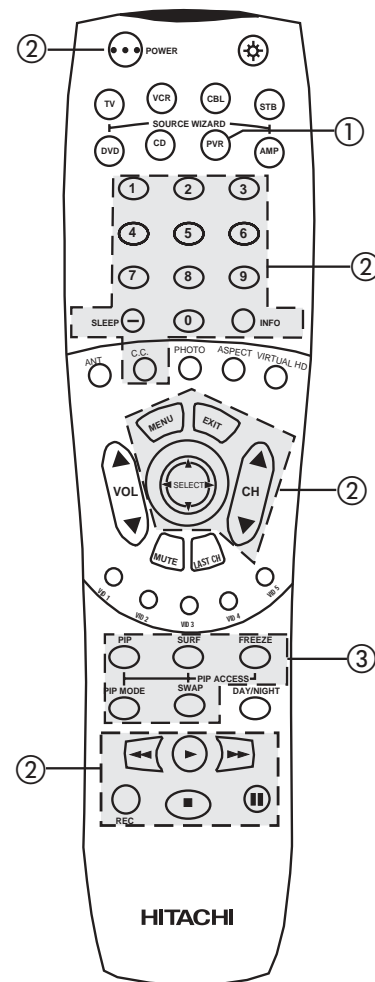

THE REMOTE CONTROL

MY PVR CODE IS: \_\_\_\_\_

**NOTE:** Refer to instruction manual of the PVR for operation of the buttons exclusively for the PVR.



# USING YOUR REMOTE TO CONTROL ADDITIONAL AUDIO EQUIPMENT

## Operating the precoded function for your Audio component.

This remote is designed to operate different types of Audio component. You must first program the remote to match the remote system of your Audio component (refer to page 44 for pre-codes).

1. Turn ON your Audio component you wish to control with the Remote.
2. Aim the remote control at the front of your Audio component.
3. Press and release the CD or AMP button (Audio buttons) to switch to Audio component pre-coded mode.
4. Hold down the CD or AMP button on the remote and enter the two digit preset code that matches your Audio component, as shown on page 44. The indicator light will flash 3 times if the code was accepted.
5. Aim the remote at the Audio component and press the POWER button. The remote will turn off your Audio component when the correct two digit preset code is entered. When this occurs, the remote control is programmed for your Audio component. If the Audio component does not turn off, try a different two digit preset code.
6. The remote will now control your Audio component.
7. Repeat steps 1 - 6 if you wish to program the remote to control another Audio component. Be sure to use a different Audio button on the remote, since only one component can be programmed per button.

THE REMOTE CONTROL

### NOTES:

1. If your Audio component cannot be operated after performing the above procedures, your Audio component's code has not been precoded into the remote.
2. In the unlikely event that your Audio component cannot be operated after performing the above procedures, please consult your Audio equipment operating guide.
3. The remote control will remember the codes you have programmed until the batteries are removed from the remote control. After replacing the batteries repeat the entire programming procedure as stated above.

- ① **CD and AMP Buttons**  
These buttons allow the remote to control your Audio equipment by setting it to Audio mode.
- ② **PRECODED AUDIO Buttons**  
These buttons transmit the chosen precoded Audio component codes.
- ③ **EXCLUSIVE TV Buttons**  
These buttons are for operating the TV.

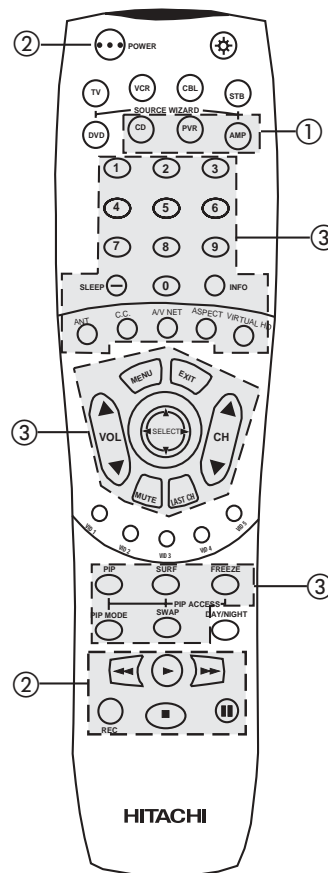

MY AUDIO EQUIPMENT CODE IS:

CD \_\_\_\_\_  
AMP/RCVR \_\_\_\_\_

**NOTE:** Refer to instruction manual of the Audio equipment for operation of the buttons exclusively for the Audio equipment.

# THE SIMPLE REMOTE CONTROL



HITACHI has provided a second remote control for your convenience. The Simple Remote Control has the basic features that are most often used.

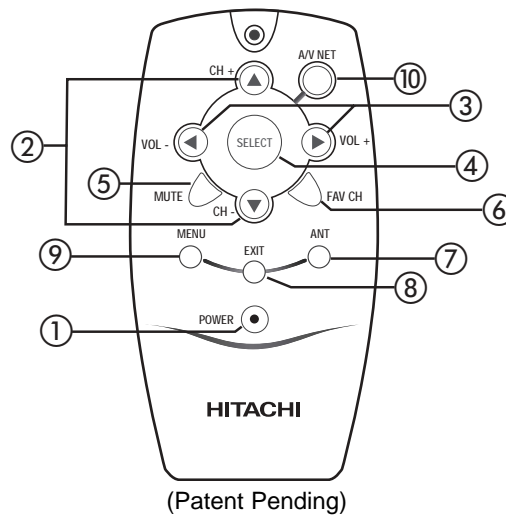

- ① **POWER button**  
Press Power button to turn the Projection TV ON or OFF.
- ② **CH+ (▲), CH- (▼)**  
Press the CH+ (▲) up or CH- (▼) down buttons to select desired channel or to navigate the on screen display features when in AV NET mode.
- ③ **VOL- (◀), VOL+ (▶)**  
Press the VOL- (◀) down or VOL+ (▶) up buttons to select desired sound level or to navigate the on screen display features when in AV NET mode.
- ④ **SELECT button**  
Press SELECT button to Select when in MENU and AV NET mode.
- ⑤ **MUTE button**  
To reduce the sound to one half of normal volume (SOFT MUTE) to answer the telephone, etc., press the MUTE button. Press the MUTE button again to turn the sound off completely (MUTE). To restore the sound, press the MUTE button one more time, or press the VOLUME Up (▶) button. (See complete explanation and example on page 32, Item ⑩.)
- ⑥ **FAV CH button**  
Press FAV CH button to access your favorite channels.
- ⑦ **ANT button**  
The ANT button will select between Antenna A and Antenna B each time the button is pressed. (See example on page 25, item ⑫.)
- ⑧ **EXIT button**  
When in MENU mode, this button will exit all On-Screen Displays.
- ⑨ **MENU button**  
Press the MENU button to start the On-Screen Display.
- ⑩ **AV NET**  
Press this button to access the Audio/Video network (AV Net) menu. The AV Net allows the user to control external components with the TV's remote control. (See complete explanation and example on page 26, item ⑭.)

**NOTE:** The Simple Remote cannot be programmed to control external components.



# VCR, CABLE, SATELLITE, DVD and AUDIO/VIDEO CODES FOR REMOTE CONTROL

THE REMOTE CONTROL

VCR BRAND.....	CODE
Adventura .....	01
Aiko .....	09
Aiwa .....	01
Akai .....	02, 47, 48
American High.....	23
Asha .....	44
Audiovox .....	24
Beaumarck .....	44
Bell & Howell.....	32
Broksonic.....	33, 34, 41
Calix .....	24
Canon .....	23
Carver .....	31
CCE .....	09
Citizen .....	09, 24
Craig .....	19, 24, 44
Curtis Mathes .....	02, 23, 46
Cybernex .....	44
Daewoo .....	09, 17
Dynatech .....	01
Electrohome .....	24
Electrophonic.....	24
Emerex .....	08
Emerson .....	01, 09, 13, 16, 24, 27, 28, 33, 34, 36, 41, 47
Fisher .....	19, 21, 32
Fuji .....	10, 23
Funai .....	01
Garrard .....	01
GE .....	04, 23, 40, 46
Goldstar .....	24, 25, 43
Gradiente .....	01
Harley Davidson .....	01
Harmon/Kardon .....	25
Headquarter .....	18
Hi-Q .....	19
Hitachi .....	01, 02, 03, 04, 05
Jensen .....	02
JVC .....	02, 14, 26
KEC .....	09, 24
Kenwood .....	02, 25, 26
KLH .....	30
Kodak .....	23, 24
Lloyd .....	01
Lloyd's .....	27
LXI .....	24
Magnavox .....	15, 23, 31, 35
Magnin .....	44
Marantz .....	23, 31
Marta .....	24
Matsushita .....	23
MEI .....	23
Memorex .....	01, 15, 18, 19, 20, 23, 24, 32, 44
MGA .....	16, 47
MGN Technology .....	44
Minolta .....	03, 05
Mitsubishi .....	16, 26, 39, 47, 48
Motorola .....	20, 23
MTC .....	01, 44
Multitech .....	01
NEC .....	02, 25, 26, 32
Nikko .....	24
Noblex .....	44
Olympus .....	12, 23
Optimus .....	20, 24, 32
Panasonic .....	11, 12, 23, 38
Penney .....	03, 23, 24, 25, 44
Pentax .....	03, 04, 05
Philco .....	23
Phillips .....	23, 31
Pilot .....	24
Pioneer .....	26
Pulsar .....	15

Quarter .....	18
Quartz .....	18
Quasar .....	23
Radio Shack .....	01, 24
Radix .....	24
Randex .....	24
RCA .....	03, 04, 05, 35, 40, 46
Realistic .....	01, 18, 19, 20, 21, 23, 24, 32, 44
Ricoh .....	22
Runco .....	15
Samsung .....	17, 44
Sanky .....	15, 20
Sansui .....	02, 26
Sanyo .....	18, 19, 32, 44
Scott .....	16, 17, 33, 34, 36, 41
Sears .....	03, 05, 18, 19, 21, 23, 24, 32
Sharp .....	20
Shintom .....	30
Shogun .....	44
Sony .....	08, 10, 22, 23
STS .....	03
Sylvania .....	01, 16, 23, 31
Symphonic .....	01
Tatung .....	02
Teac .....	01, 02
Technics .....	23, 38
Teknika .....	01, 23, 24
TMK .....	27, 44
Toshiba .....	16, 17, 21, 36
Totvision .....	24, 44
Unitech .....	44
Vector .....	17
Vector Research .....	25
Video Concepts .....	17, 47
Videosonic .....	44
Wards .....	01, 03, 19, 20, 23, 35, 36, 44, 46
XR-1000 .....	01, 23
Yamaha .....	25
Zenith .....	10, 15, 22

DVD BRAND.....	CODE
APEX .....	15
Denon .....	04
Go Video .....	14
Hitachi .....	07, 12, 13
JVC .....	01
Kenwood .....	04, 16
Magnavox .....	05
Mitsubishi .....	10
Panasonic .....	04
Phillips .....	06
Pioneer .....	03
RCA (Proscan).....	09, 17
Samsung .....	12
Sanyo .....	13
Sony .....	02
Toshiba .....	05
Yamaha .....	08
Zenith .....	05, 11

CABLE BRAND .....	CODE
ABC .....	01, 07, 08, 17, 18, 20, 36, 37, 49
Antronix .....	39
Archer .....	11, 24, 39
Belcor .....	32
Cable Star .....	32
Century .....	11
Citizen .....	11
Colour Voice .....	30, 42
Comtronics .....	25, 28
Contec .....	21

Dae Ryung .....	20
Eastern .....	14
Electricord .....	31
Everquest .....	51
Focus .....	52
Garrard .....	11
GC Electronics.....	32, 39
Gemini .....	05, 38, 43, 51
General Instrument .....	01, 12
Goldstar .....	10, 25
Hamlin .....	04, 13, 22, 23
Hitachi .....	01
Hytex .....	36
Jasco .....	11
Jerrold .....	01, 08, 12, 37, 49, 50, 51
Macom .....	35
Magnavox .....	15
Memorex .....	03
Movie Time .....	29, 31, 33
NSC .....	29, 33, 38
Oak .....	21, 36, 46
Panasonic .....	02, 03, 09
Paragon .....	03
Phillips .....	11, 15, 16, 26, 30, 42, 43, 44
Pioneer .....	06, 10, 19, 55
Popular Mechanics .....	52
Pulsar .....	03
RCA .....	02
Realistic .....	39
Recoton .....	52
Regal .....	04, 22, 34
Regency .....	14
Rembrandt.....	01, 38
Runco .....	03
Samsung .....	10, 25
Scientific Atlanta .....	17, 20, 41, 45, 55
Signal .....	25, 51
Signature .....	01
SL Marx .....	25
Sprucer .....	02
Starcom .....	37, 49, 51
Stargate .....	25, 51
Starquest .....	51
Starsight .....	53, 54
Sylvania .....	18
Televue .....	25
Texscan .....	18
Tocom .....	07, 27, 50
Toshiba .....	03
Tusa .....	51
TV 86 .....	29
Unika .....	11, 39
United Artists .....	36
United Cable .....	49
Universal .....	11, 24, 31, 32, 34, 39
Videoway .....	47
Viewstar .....	15, 28, 29, 40
Zenith .....	03, 48
Zentek .....	52

SATELLITE BRAND .....	CODE
Echostar .....	04
Hitachi .....	01
Hughes .....	05
RCA .....	02
Sony .....	03

SET-TOP-BOX .....	CODE
Panasonic .....	06
RCA .....	07
Samsung .....	08
Zenith .....	09

AMPLIFIER BRAND .....	CODE
Aiwa .....	05, 06
Carver .....	01, 06, 08
Denon .....	10
Fisher .....	08, 11
Hitachi .....	12
JVC .....	13
Kenwood .....	14, 15, 17, 18
Magnavox .....	01, 06
Marantz .....	01, 06, 16
MCS .....	16
Optimus .....	03, 04, 11, 15, 20
Panasonic .....	16
Philips .....	01, 06
Pioneer .....	03, 04, 20, 21, 22
Quasar .....	16
Sansui .....	06
Sanyo .....	11
Sharp .....	15
Sony .....	05
Technics .....	02, 16, 23, 24, 25
Victor .....	13
Wards .....	03, 05, 06, 08, 20, 21
Yamaha .....	15, 26

CD BRAND.....	CODE
Adcom .....	01
Aiwa .....	02
California Audio Lab .....	03
Carver .....	02
Denon .....	04
DKK .....	05
Emerson .....	01
Fisher .....	06
Genexxa .....	07
Hitachi .....	01, 07, 08, 09, 10, 11, 12
JVC .....	13
Kenwood .....	06, 14, 15
Krell .....	02
Magnavox .....	02
DKK .....	02, 03
MCS .....	03
Mission .....	03
NSM .....	02
Onkyo .....	16
Optimus .....	05, 07, 17
Panasonic .....	03
Philips .....	02
Pioneer .....	07, 17
Proton .....	02
QED .....	02
Quasar .....	03
RCA .....	01, 21
Realistic .....	01
Rotel .....	02
SAE .....	02
Sansui .....	02
Scott .....	01
Sony .....	05, 18
Technics .....	03, 19, 20
Victor .....	13

PERSONAL VIDEO RECORDER BRAND .....	CODE
Tivo .....	01
Replay .....	02

# OSD

1. Press MENU on the remote control to display the different features on your HITACHI Projection TV.
2. Press the THUMB STICK to highlight a different feature.
3. Press EXIT on the remote control to quickly exit from a menu.
4. Press A/V Net on the remote control to access the A/V Net menu to control external components.
5. Press THUMB STICK ◀ or ▶ to access Favorite Channels menu.

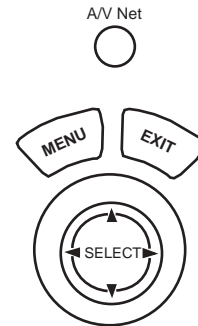

This part of the screen shows which selections are available.

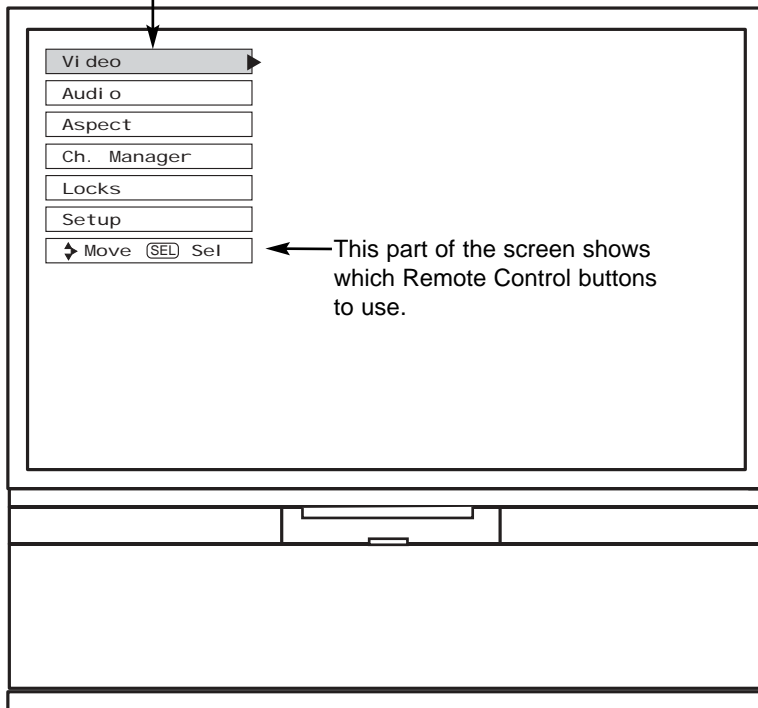

This part of the screen shows which Remote Control buttons to use.

Video	Picture Mode	Select between the two picture modes; Day and Night.
	Contrast	Adjust contrast.
	Brightness	Adjust brightness.
	Color	Adjust color.
	Tint	Adjust tint.
	Sharpness	Adjust sharpness.
	Color Temperature	Set this to High for less intense color with more blue, set to Medium for natural color, set to Standard for standard colors or Black and White for more reddish color.
	Black Enhancement	Adjust shadow detail in dark screens.
	Edge Enhancement	Automatically enhances the edges between light and dark areas.
	Reset Video Settings	Choose the Reset Video settings.
	Color Management	Adjust and balance individual colors to make either deeper or more pure according to preference.
	Color Decoding	Adjust the percentage of Red, Green and Color according to preference.
	Auto Color	The AUTO COLOR function automatically monitors and adjusts the color to maintain constant color levels even after a program or channel changes. It also maintains natural flesh tones while preserving fidelity of background colors.
	Noise Reduction	Reduces conspicuous noise in the picture.
Auto Movie Mode	Turn ON/OFF the 3:2 Pull-down detection feature.	
Audio	Treble	Adjust the treble.
	Bass	Adjust the bass.
	Balance	Adjust the balance.
	Sound Enhancement	Select SRS and BBE settings.
	Audio Source	Select between three Audio Sources.
	Internal Speakers	Select internal or external speakers.
	Auto Noise Cancel	Eliminates the noise between stations.
	Perfect Volume	Adjust volume in fixed setting.
	Loudness	Adjust Loudness.
Aspect	Mode	Choose the picture format aspect ratio.
Channel Manager	Ant A	View/edit Channel ID, Scan, and Lock settings in antenna A.
	Ant B	View/edit Channel ID, Scan, and Lock settings in antenna B.
Locks	Change Access Code	Change Lock access code.
	Engage Lock	Choose to lock channel, video input, and front panel.
	TV Time Lock	Set specific time to Lock TV.
	Movie Ratings	Block various types of movies and video types based on motion picture ratings.
	TV Ratings	Block various types of movies and television programming based on a parental guide ratings.
	Canadian Ratings (ENG)	Block various types of movies and television programming based on the Canadian ratings system.
Canadian Ratings (FRN)	Block various types of movies and television programming based on the Canadian French ratings system.	
Setup	Magic Focus Tune Up	Automatic and manual alignment of the red, green and blue colors to make white.
	Menu Preference	Choose English, French, or Spanish text.
	Set The Clock	Set the TV clock. It must be set before using the Lock feature.
	Set The Inputs	Label Video Inputs, VCR, DVD, etc.
	Set The Color System	Set tint and color coordinates for DTV programs.
	Set Virtual HD	Select between 1080i and 540p signal.
	Set Black Side Panel	Set the gray side bars on/off when watching 4:3 signals in standard mode.
	Set Event Timer	Turn TV on and off once, daily, or weekly.
	Set Closed Captions	Feature to display dialogue/text.
	About Your TV	Information display for this TV.

# VIDEO

## Video

Select VIDEO to adjust picture settings and improve picture quality. You can customize each of the Video Inputs to your preference to increase viewing performance and pleasure depending upon the video program being viewed. If RESET is selected, only the selected mode will reset to initial conditions.

## Picture Mode

Use this function to choose from automatic picture settings to optimize your TV's performance.

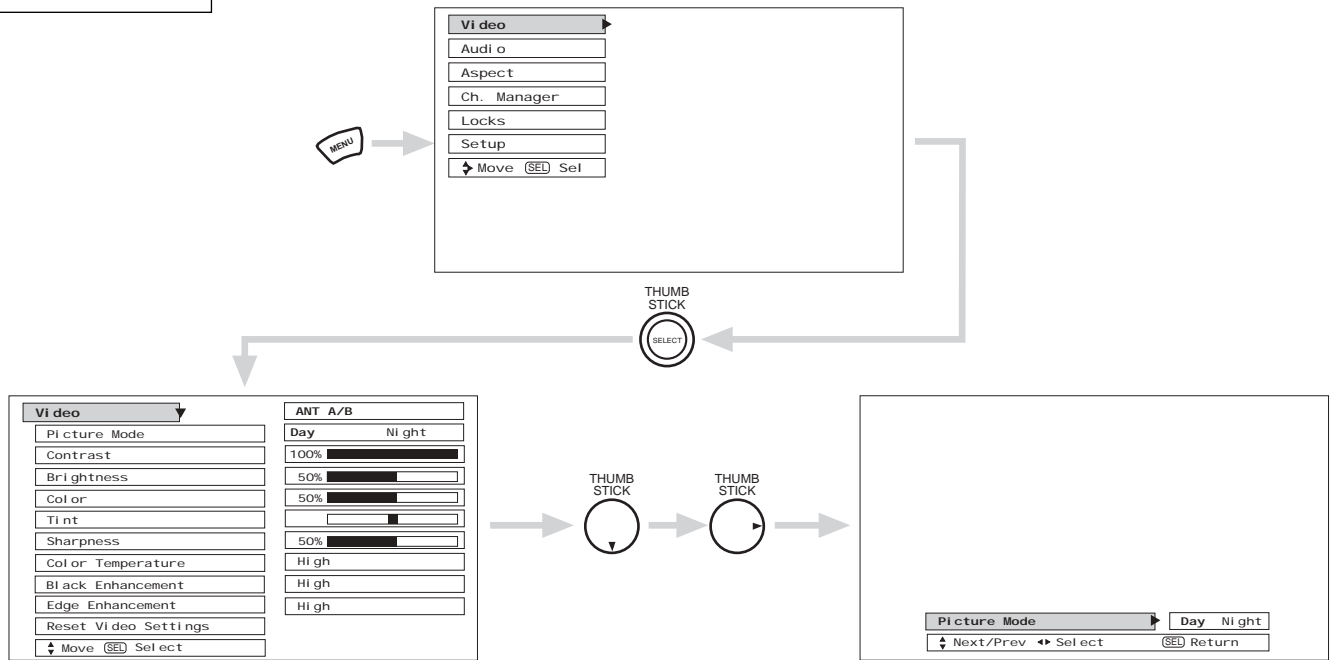

Use THUMB STICK ▲ or ▼ to highlight Picture Mode settings.

Function	Day	Night	Reset
Contrast	100%	50%	Reset the video menu settings on current input to the Day or Night conditions depending on the selected VIDEO mode.
Brightness	50%	50%	
Color	50%	45%	
Tint	Center	Center	
Sharpness	50%	50%	
Color Temperature	High	Standard	
Black Enhancement	High	Low	
Edge Enhancement	High	Low	
Auto Color	Off	Off	
Noise Reduction	Off	Off	
Color Management (Set User Colors)	Off	Off	
Auto Movie Mode (TV/Cinema Detection)	Off	Off	

Press EXIT to quit menu or select PICTURE MODE to return to previous menu.

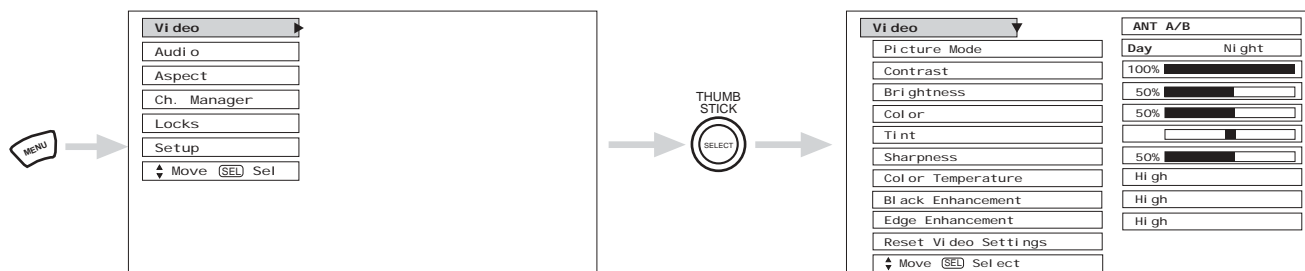

Use the THUMB STICK ▲ or ▼ to highlight the function to be adjusted.  
 Press down on THUMB STICK to select the function settings.  
 Press the THUMB STICK ◀ or ▶ to adjust the function.  
 Press MENU to return to main menu.  
 Press EXIT to quit menu.

- |                          |  |
|--------------------------|--|
| <b>Contrast</b>          | Use this function to change the contrast between black and white levels in the picture.  |
| <b>Brightness</b>        | Use this function to adjust overall picture brightness.  |
| <b>Color</b>             | Use this function to adjust the level of color in the picture.   |
| <b>Tint</b>              | Use this function to adjust flesh tones so they appear natural.  |
| <b>Sharpness</b>         | Use this function to adjust the amount of fine detail in the picture. Sharpness function will be disabled when Noise Reduction is ON.                                    |
| <b>Color Temperature</b> | Set this to High for cooler color with more blue, set to Medium for more natural color, set to Standard for accurate color or set to Black/White for more reddish color. |
| <b>Black Enhancement</b> | Use this function to enhance the shadow detail in dark scenes using the settings off, low, middle and high.  |
- NOTES:**

  1. If CONTRAST is selected, you are adjusting CONTRAST. The additional menu items BRIGHTNESS, COLOR, TINT, and SHARPNESS can be selected and adjusted in the same manner.
  2. It may be necessary to adjust TINT to obtain optimum picture quality when using the COMPONENT VIDEO Y-P<sub>B</sub>P<sub>R</sub> input jacks.
- |                         |   |
|-------------------------|---|
| <b>Edge Enhancement</b> | Use this function to automatically enhance the edges between light and dark areas using the settings Off, Low, Middle and High. |
|-------------------------|---|



# VIDEO

## Reset Video Settings

This function allows you to Reset the Video Menu Settings of the present input and return it to the Day or Night conditions depending on the selected VIDEO mode.

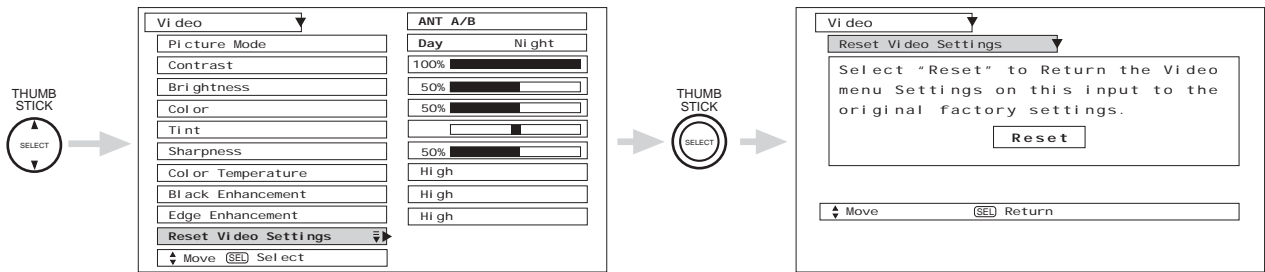

Use THUMB STICK to highlight functions.  
Press down on THUMB STICK to select Reset Video Settings.

Use THUMBSTICK ▼ to access other video settings.

You can customize each of the Video Inputs to your preference to increase viewing performance and pleasure, depending upon the video program being viewed. If RESET is selected, only the selected mode will reset to the initial conditions as explained above.

If RESET is selected in Video:1 mode, only Video:1 mode will return to factory conditions.

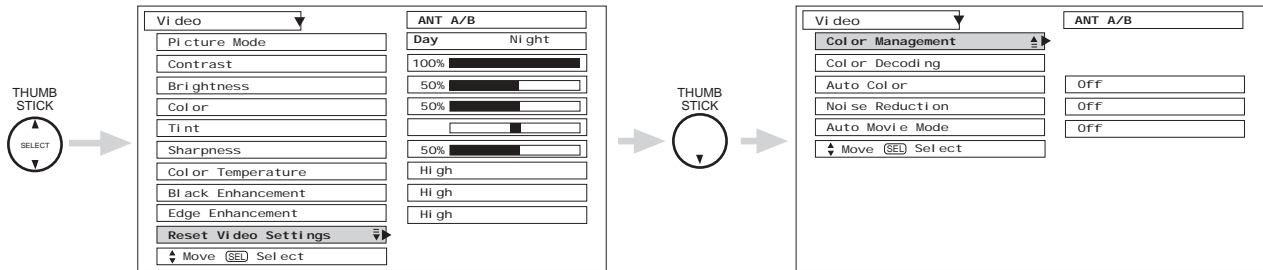

## Color Management

Use this function to adjust and balance the listed individual colors to make them either deeper or more pure depending on the user's preference.

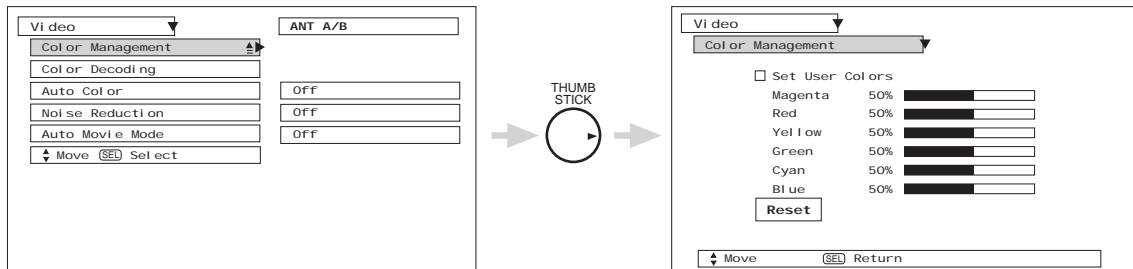

Use THUMBSTICK to highlight function.  
Press down to select the User Colors setting. When the function has a "✓" in the box, it is ON.  
Press THUMBSTICK ◀, ▶, ▼, ▲, to highlight and adjust individual colors.  
Use THUMBSTICK to highlight and select "Reset" to return all colors to default settings.

**NOTE:** When the Set User Colors box is not checked off, the listed colors will be grayed out.

## Color Decoding

Use this function to adjust the percentage of Red, Green and Color according to the user's preference. Use TINT to adjust flesh tones so they appear natural.

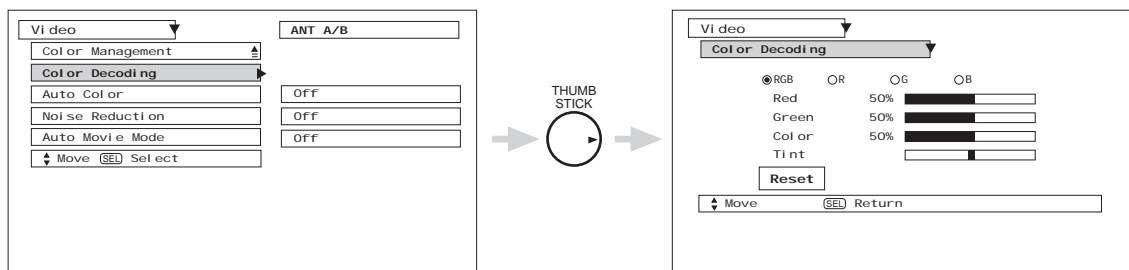

Use THUMBSTICK to highlight function.

Press down to select from 4 menu items.

Press THUMBSTICK ◀, ▶, ▼, ▲, to highlight and adjust Red, Green, Color and Tint.

Use THUMBSTICK to highlight and select "Reset" to return all settings to default.

**NOTE:** Color Decoding settings are independently stored in each of the 4 Color Temperature settings.

## Auto Color

The AUTO COLOR function automatically monitors and adjusts the color to maintain constant color levels even after a program or channel changes. It also maintains natural flesh tones while preserving fidelity of background colors.

**NOTE:** When using Component or DVI-HDTV input, Auto Color will not be available (grayed out).

## Noise Reduction

The NOISE REDUCTION function automatically reduces conspicuous noise in the picture without degrading picture quality. Set NOISE REDUCTION to OFF if the TV experiences picture blocking. When Noise Reduction is ON, Sharpness function is disabled (grayed out).

## Auto Movie Mode

The Auto Movie Mode function turns ON or OFF the 3:2 PULLDOWN DETECTION SPECIAL FEATURE. Theatrical movies are shot on film at 24 frames or still pictures per second, instead of 30 frames or 60 fields like video. When film is transferred to video for television viewing, the disparity between the two frame rates must be reconciled. This involves a process known as 3:2 pulldown.

When Auto Movie Mode is turned ON from the VIDEO menu, your Hitachi Projection Television will activate the circuitry for this special feature to improve video performance when watching film based sources.

**NOTES:** 1. When using Progressive Scan Component or DVI-HDTV input (Ex. 480p, 720p), Auto Movie Mode will not be available (grayed out).

2. All Video settings are independent of each other based on it's input (ANT A/B, Input 1~5).

## Audi o

Select AUDIO to adjust the TV to your preference and to improve the sound quality.

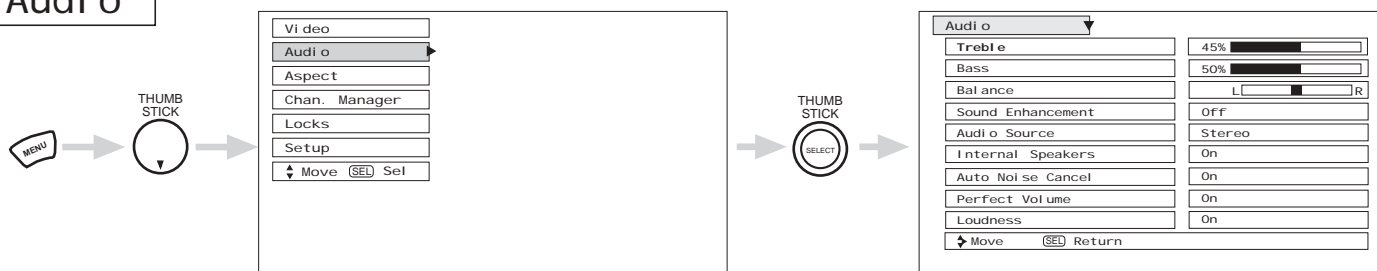

Press THUMB STICK ▲, ▼, to select menu item.  
 Press THUMB STICK ◀ or ▶ to adjust the function.  
 Press EXIT to quit the MENU, or select Audio to return to the main menu.

**NOTE:** If TREBLE is selected you are adjusting treble. The additional menu items Bass and Balance can be selected and adjusted in the same manner.

### Treble

This function controls the high frequency audio to all speakers.

### Bass

This function controls the low frequency audio to all speakers.

### Sound Enhancement

See page 52.

### Balance

This function will control the left to right balance of the Projection TV internal speakers.

### Audio Source

Multi-Channel Television Sound will allow you to select STEREO (a stereo broadcast), MONO (monaural sound) used when receiving a weak stereo broadcast or 2nd Audio Prog (SAP) which may be a secondary language, weather report, etc.  
 The sources received will be displayed at the top right edge of the TV. The source you select will be displayed above the sources received. See example below for each selection when both stereo and second audio are received (monaural is always received).

STEREO SELECTED

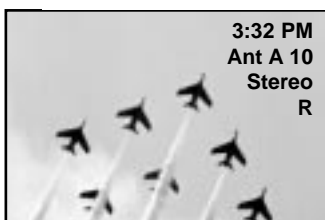

SAP SELECTED



MONO SELECTED

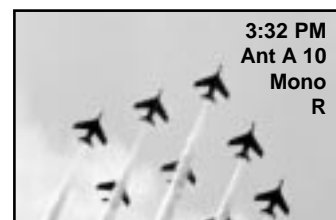

### Internal Speakers

This function is useful when setting up the external speakers.  
 ON - Select this feature if using the internal speakers only.  
 TV as Center - Select this feature when setting up external speakers from a separate stereo system. The TV's speakers will work as the center speaker.  
 OFF - Select this feature if you prefer to use only speakers from a separate stereo system.

### Auto Noise Cancel

This function eliminates the noise between stations. If a channel is tuned and is noisy, this function will automatically eliminate the audio for that channel.

### Perfect Volume

This function will automatically adjust volume so each channel and input has the same average volume level.

### Loudness

This function turns loudness ON or OFF. It will improve the quality of both low and high frequency sounds when listening at low volume levels.

## Sound Enhancement

The following surround settings will reproduce the “live” sound you would hear in concert halls, sports stadiums, movie theaters, etc. with only two speakers.

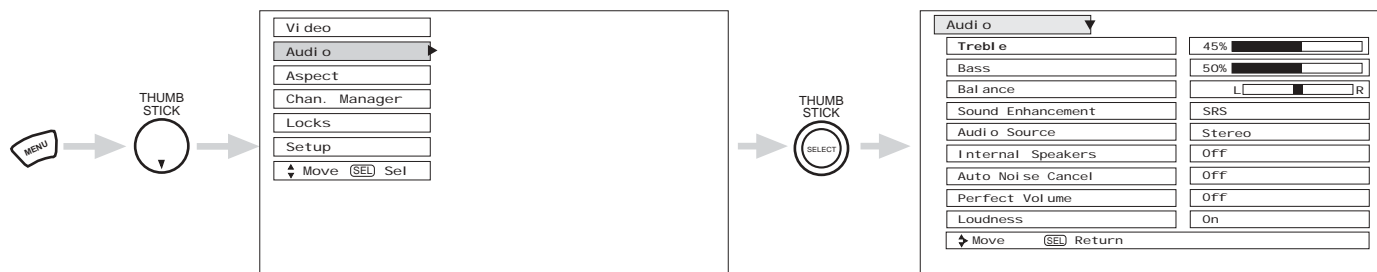

To enter SOUND ENHANCEMENT, use THUMB STICK ▲ or ▼ to highlight then press THUMB STICK ► to select SOUND ENHANCEMENT of your choice (Off, SRS, BBE and SRS and BBE).

Use the THUMB STICK to highlight your sound enhancement choice, and press SELECT to select your choice.



Based on the principles of the human hearing system, SRS technology delivers an exciting and realistic 3D Sound experience from just two external speakers (or) the two internal speakers of your HITACHI Television. If your HITACHI Television is connected to an external audio system, SRS will also create an incredible 3D sound experience from two speakers and even enhance a complete multi-speaker surround sound system.

**NOTES:** \*SRS and the  symbol are registered trademarks of SRS Labs, Inc. SRS technology is incorporated under license from SRS Labs, Inc.

## BBE Technology

Sound reproduction quality enhancement system. The BBE technology produces sound that is natural and crisp from just two speakers (or) the two internal speakers of your HITACHI television. If your HITACHI television is connected to an external audio system, BBE will also create an incredible crisp sound experience from two speakers and even more complete and accurate reproduction of the original performance. BBE brings to the listener's ear a more complete and accurate reproduction of the original performance. Each voice, speaking or singing, each instrument or sound effect is presented with its attendant harmonics or partials more clearly audible. The ear can then more easily recognize the unique tonal colors of each sound as though the sound was being produced live.

**NOTES:** Licensed by BBE Sound, Inc. under USP4638258 and 4482866. BBE and BBE symbol are registered trademarks of BBE Sound, Inc. Manufactured under license from BBE Sound, Inc.

## Aspect Mode

Use this function to select the Picture Format Aspect Ratio.

### Auto Aspect

Automatically adjust the Aspect Ratio depending on the input signal to fill the screen.

Press THUMB STICK ▲, ▼, to select menu item.

Press down on THUMBSTICK to select. A “√” in the box indicates that the feature is ON.

- NOTES:**
1. The Auto Aspect function is recommended on an input signal with VIDEO ID.
  2. The Auto Aspect function is best used on component video, S-Video, and 480i component signals.
  3. See page 31 for Aspect Mode availability.

### Vertical Position

This function allows you to select when aspect style is either 4:3 EXPANDED/ZOOM1/ZOOM2 or 16:9 ZOOM. Vertical position can be changed with these modes. For example, it will be useful for centering the picture area at both the top and bottom of the picture with 480i/480P signal. Adjustable range is -10 (video center is toward bottom of screen) to +10 (video center is toward top of screen).

Press THUMB STICK ▲, ▼, to select menu item.

Press THUMB STICK ◀ or ▶ to adjust the function.

Press EXIT to quit the MENU, or select Aspect to return to the main menu.

**NOTE:** Vertical Position will not be available in 4:3 Standard and 16:9 Standard modes.

# CHANNEL MANAGER

Chan. Manager

Select ANTENNA if you are using an indoor or outdoor antenna. Select Cable if you have cable TV.

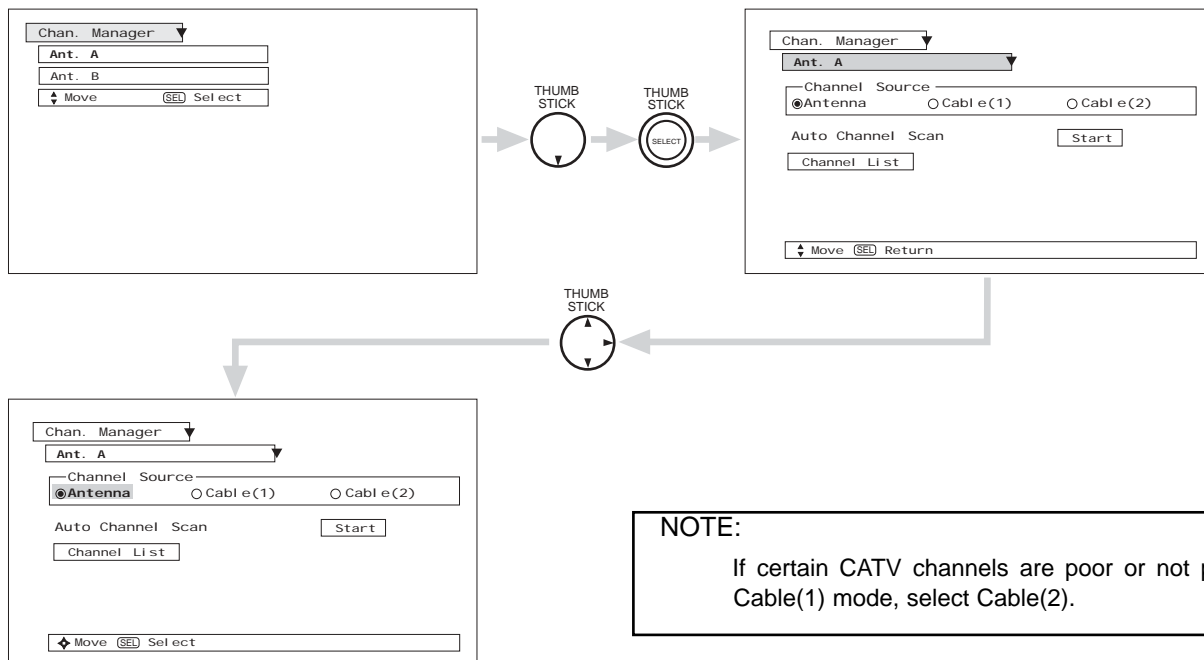

**NOTE:**  
If certain CATV channels are poor or not possible in Cable(1) mode, select Cable(2).

Use THUMB STICK ◀, ▶ to highlight the correct Channel Source.  
Press the THUMB STICK to select highlighted source.  
Press EXIT to quit the menu.

ON-SCREEN DISPLAY

RECEPTION BAND		
AIR	CATV 1 OR CATV 2	
	CATV CHANNEL	Indicated on the screen
VHF 2 ~ 13ch UHF 14 ~ 69ch	VHF 2~13	2 ~ 13
	Mid band A~1	14 ~ 22
	A-5 ~ A-1	95 ~ 99
	Super band J~W	23 ~ 36
	Hyper band W + 1 ~ W + 28	37 ~ 64
	Ultraband W + 29 ~ W + 84	65 ~ 125

Reception channels for each mode are shown at the left.

Refer to your cable or TV guide for channel identification standards.

# CHANNEL MANAGER

## Auto Channel Scan

This feature will automatically store active TV channels in Auto Channel Scan. This will allow you to skip unused channels when using CHANNEL UP (▲) or DOWN (▼).

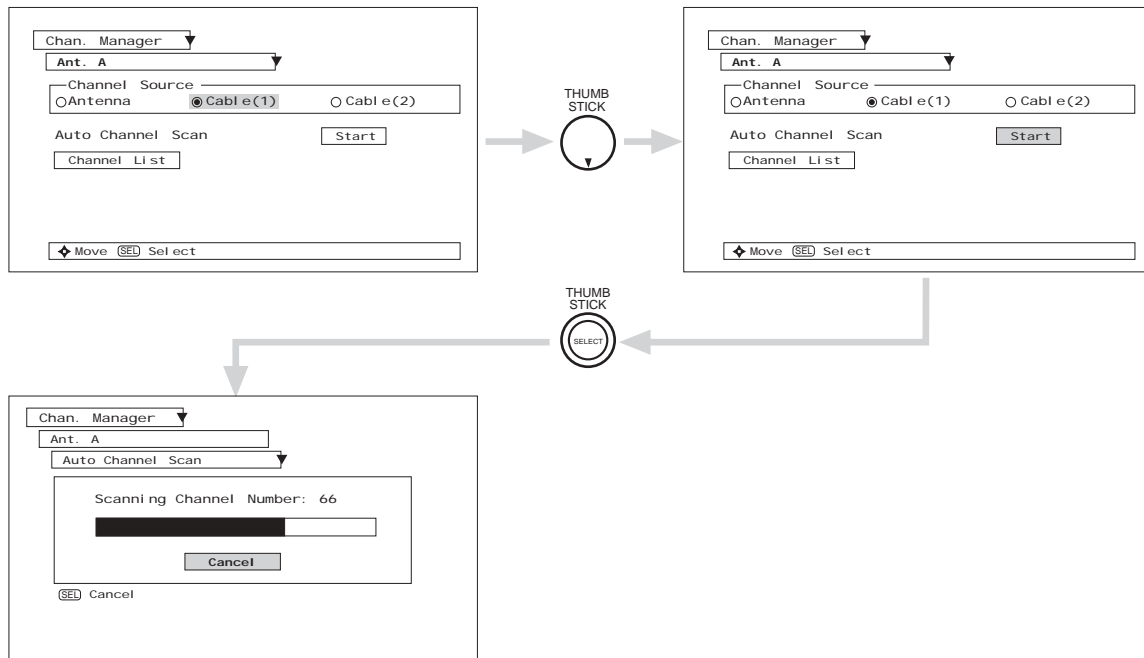

If the EXIT button is pressed while AUTO CHANNEL SCAN function is engaged, programming will stop. If two antennas are connected, switch antenna inputs and repeat AUTO CHANNEL SCAN for the second antenna input.

Remember to select the correct ANTENNA/CABLE mode before using AUTO CHANNEL SCAN. See CHANNEL MANAGER - SCAN to add or to erase additional channels.

## Channel List

This function allows you to review which channels are labeled (CH ID), which have been added to Channel Memory (SCAN), and which are protected by LOCK.

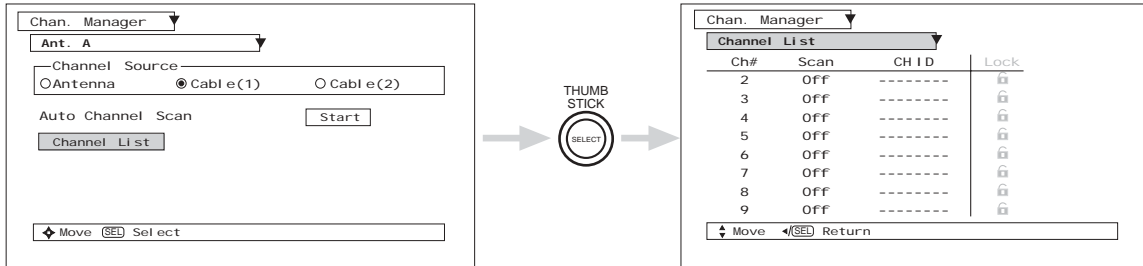

Press THUMB STICK ▲ or ▼ to review more channels.  
Press EXIT to quit the menu.

## Scan

Use this feature after Auto Channel Scan is completed to add (On) or skip (Off) additional channels to the remote control channel ▲ or ▼ buttons.

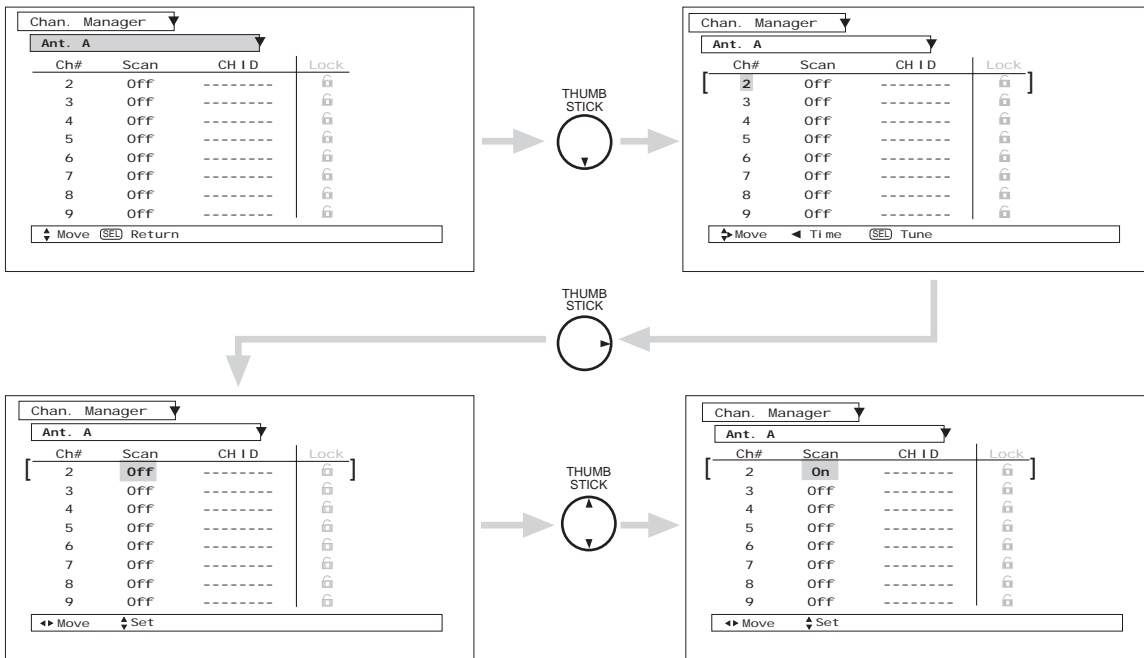

ON-SCREEN DISPLAY

To add (Scan-On) or skip (Scan-Off) additional channels while in Channel Manager, THUMB STICK ◀ to highlight the channel number, then THUMB STICK ▲ or ▼ to highlight other channels. Once the desired channel is highlighted, THUMB STICK ▶ to scan column, then THUMB STICK ▲ or ▼ to select ON or OFF.

**NOTE:** Lock feature cannot be selected or set in CHANNEL MANAGER.



# CHANNEL MANAGER

## Channel ID

This section contains advanced features which will make TV viewing easier and more enjoyable. Use this feature to give up to 20 channels a name when ANTENNA signal source is selected and up to 60 channels a name when CATV signal source is selected.

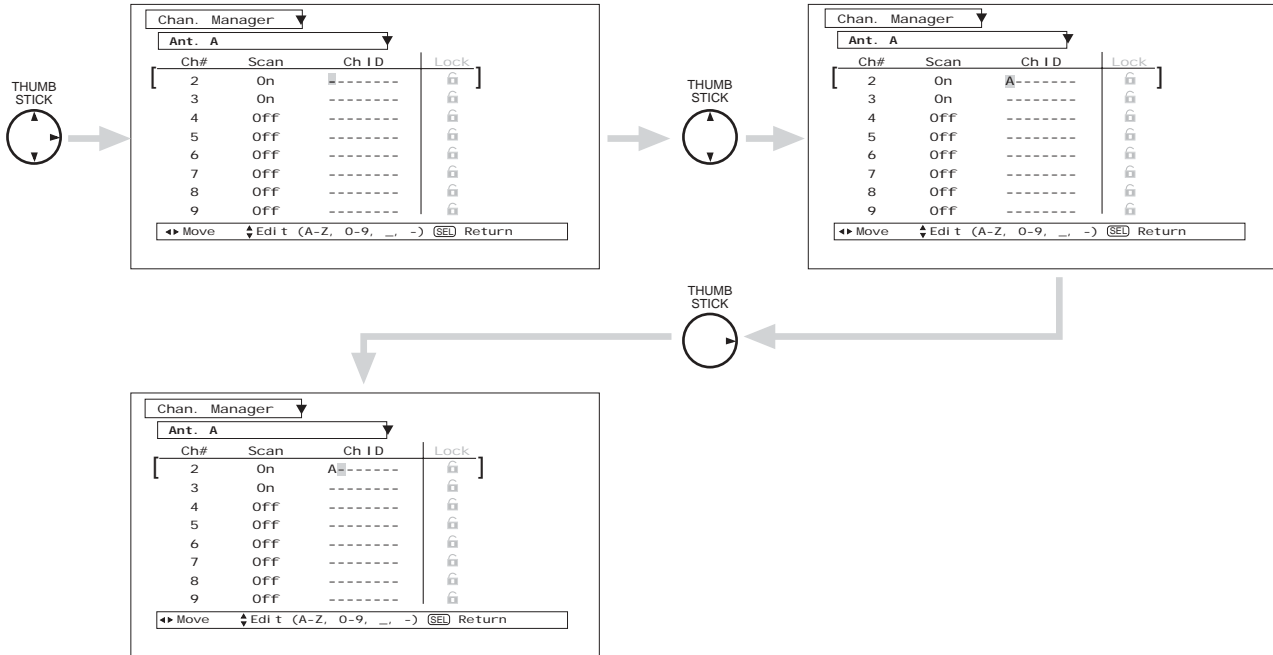

- NOTES:**
1. If ANT A and ANT B are in the same ANTENNA/CABLE mode, the CHANNEL ID for both antenna inputs will be the same.
  2. CHANNEL ID will not be displayed when PIP is ON.

## Locks

This function will block out the picture and sound of the selected channel or video input. It can also be used to keep the TV from being viewed for a scheduled time period that you set.

The code to enter the Locks feature is a four digit secret code number. The factory preset code is 0000. Use the number buttons to select secret code.

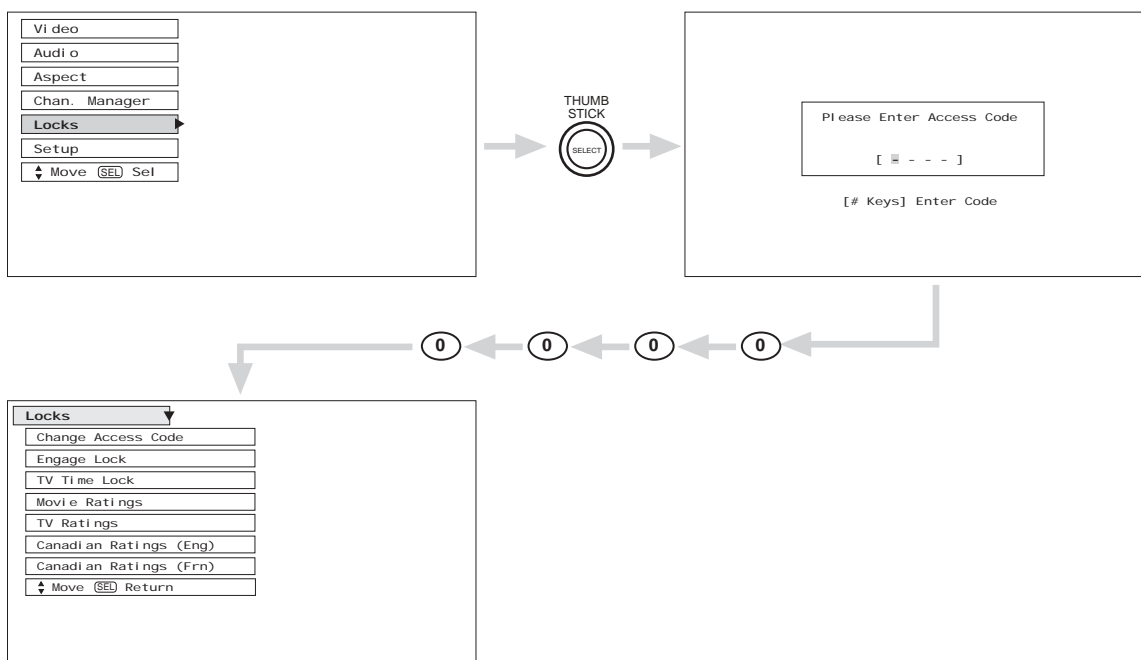

Use THUMB STICK ▲ or ▼ to highlight function and then press SELECT button. To change the secret code number, select Change Access Code. Enter a new four digit key number you prefer.

Select CHANGE ACCESS CODE to change the factory preset code (0000) to your preference.

When ENGAGE LOCK is selected, SET CHANNEL LOCK, SET INPUT LOCK, and SET FRONT PANEL LOCK can be set individually.

When SET CHANNEL LOCK is turned on, the picture and sound for the chosen channel will be blocked out.

When SET INPUT LOCK is turned on, the picture and sound for all video inputs and the picture and sound for channels 3, 4 will be blocked out.

When FRONT PANEL LOCK is turned on, all buttons on the Front Panel will be deactivated, except the Power button.

When TV TIME LOCK is turned on (☑ TIME LOCK) you can set the BEGIN and END times (THUMB STICK ►) and the TV cannot be viewed during that time period (Set clock first). Use CURSOR ▲ or ▼ to highlight ONCE (TV will time out one time only), DAILY (TV will time out every day), WEEKLY (TV will time out one time a week).

When MOVIE RATINGS is selected, you can block various types of movies and video tapes based on motion picture ratings. Picture-in-Picture will also be blocked automatically (see page 59).

When TV RATINGS is selected, various types of television programming based on a parental guide ratings will be blocked. Picture-in-Picture will also be blocked automatically (see page 60).

Use CANADIAN RATINGS to block various types of movies and television programs based on the two rating systems used in Canada that you feel may be inappropriate due to its content (see pages 61-62).

If you forget your secret code, use the factory code 7777 to erase your key number. This will reset the secret code number back to the factory preset 0000.

Press EXIT to quit the menu.

- NOTE:**
1. If ANT A and ANT B are in the same signal source mode (see page 54), when a channel is locked, it is locked on both antenna inputs.
  2. When using TV TIME LOCK make sure the clock is set (see page 67).
  3. Text appears on the screen to indicate that TV TIME LOCK is activated.
  4. If MOVIE/TV Ratings Lock function settings are ON, SURF will be deactivated.

# LOCKS

## Movie Ratings

Use MOVIE RATINGS to prevent viewing of any movie that you feel may be inappropriate due to its content.

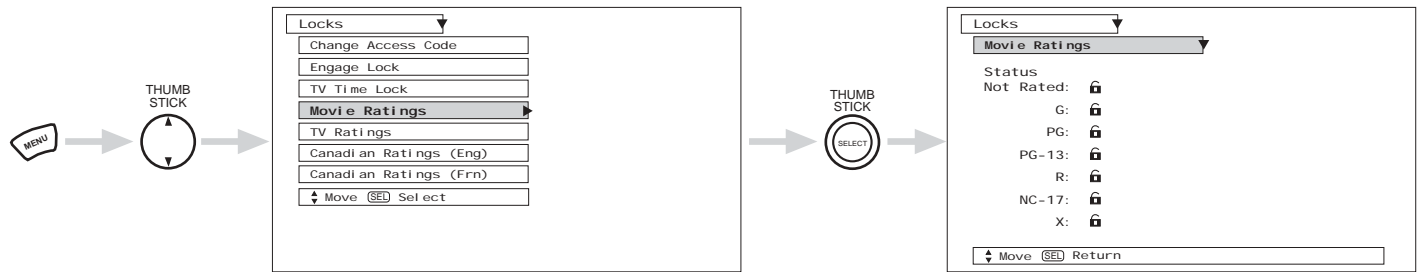

Use THUMB STICK ▲ or ▼ to select the MOVIE RATING category that you want to block.

Press SELECT to block the MOVIE RATING that you have selected. Once rating is selected, for example PG-13, all movies rated PG-13 and higher (R, NC-17, and X) will be blocked.

Press EXIT to quit the menu or select MOVIE RATING to return to the previous menu.

## Motion Picture Ratings Chart

G	<b>General audiences.</b> All ages admitted.
PG	<b>Parental guidance suggested.</b> Some material may not be suitable for children.
PG-13	<b>Parents strongly cautioned.</b> Some material may be inappropriate for children under 13.
R	<b>Restricted.</b> Under 17 requires accompanying parent or adult guardian.
NC-17	<b>No one 17 and under admitted.</b>
X	<b>Adults only</b>
NOT RATED (NR)	<b>Contains no rating. Not Rated (NR) and Not Applicable (NA) programs.</b> Movie has not been rated or ratings do not apply.

## TV Ratings

Use TV RATINGS to prevent the viewing of any TV program that you feel may be inappropriate due to its content.

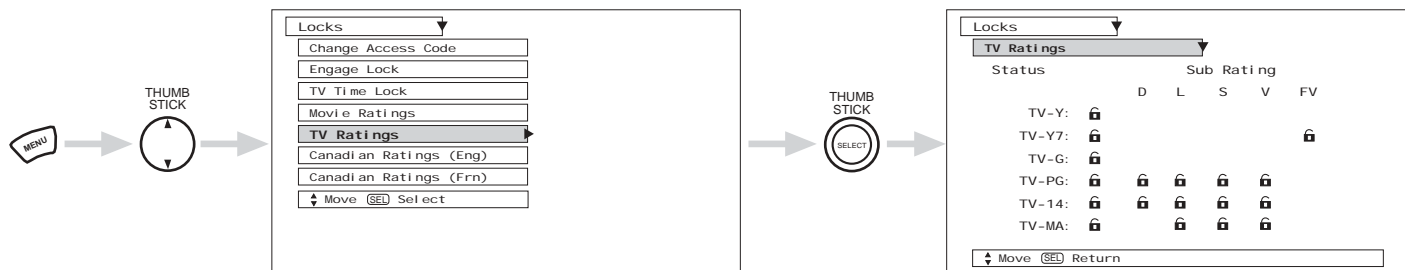

Use THUMB STICK ▲ or ▼ to highlight the category that you want to block. Press select to block the TV RATINGS that you have selected. Press EXIT to quit the menu or select TV RATINGS to return to the previous menu.

## TV Parental Guide Ratings Chart

N/A	<b>None.</b>
TV-Y	<b>All children.</b> The themes and elements in this program are specifically designed for a very young audience, including children from ages 2-6.
TV-Y7	<b>Directed to older children.</b> Themes and elements in this program may include mild physical or comedic violence, or may frighten children under the age of 7.
TV-G	<b>General audience.</b> It contains little or no violence, no strong language, and little or no sexual dialogue or situations.
TV-PG	<b>Parental guidance suggested.</b> The program may contain infrequent coarse language, limited violence, some suggestive sexual dialogue and situations.
TV-14	<b>Parents strongly cautioned.</b> This program may contain sophisticated themes, intense sexual situation, more intense violence and intensely suggestive dialogue.
TV-MA	<b>Mature audiences only.</b> This program may contain mature themes, indecent language, graphic violence, and explicit sexual content.
FV	<b>Fantasy Violence</b>
V	<b>Violence</b>
S	<b>Sexual Situation</b>
L	<b>Adult Language</b>
D	<b>Sexually Suggestive Dialogue.</b>

### NOTE:

If you Block TV-14D, you will still permit TV MA programs; If you block TV-14DV, you will automatically block TV-MAV programs, but you will still permit TV-MALS programs. This means that the TV will block violence in TV-14 and higher (TV-MA), but not language and sex.

# LOCKS

## Canadian Ratings (Eng)

Use Canadian Ratings (Eng) to block any type of movie and television program in Canada that you feel might be inappropriate in its content.

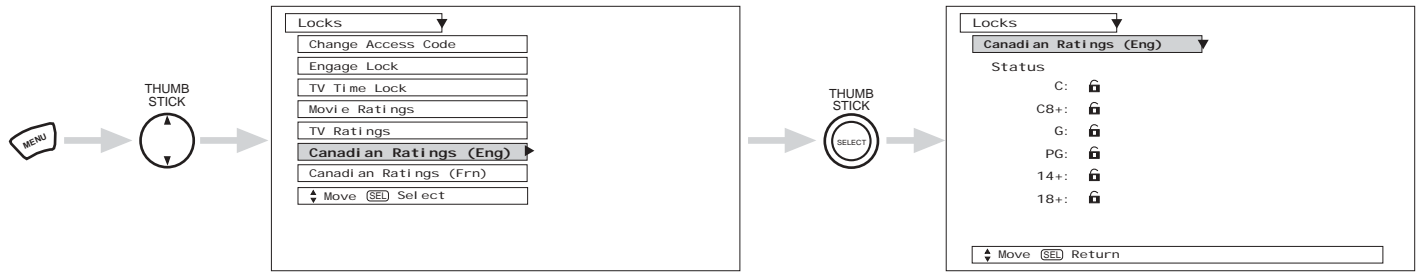

Use THUMB STICK ▲ or ▼ to select the CANADIAN RATINGS (Eng) category that you want to block. Press SELECT to set the CANADIAN RATINGS (Eng) that you have selected. Once rating is selected, for example C8+, all movies and television programs rated C8+ and higher (G, PG, 14+ and 18+) will be blocked automatically. Press EXIT to quit menu.

## Canadian Ratings English Chart

C	<b>Programming intended for children under age 8</b> - Violence Guidelines: Careful attention is paid to themes, which could threaten children's sense of security and well-being. There will be no realistic scenes of violence. Depictions of aggressive behaviour will be infrequent and limited to portrayals that are clearly imaginary, comedic or unrealistic in nature. Other Content Guidelines: There will be no offensive language, nudity or sexual content.
C8+	<b>Programming generally considered acceptable for children 8 years and over to watch on their own</b> - Violence Guidelines: Violence will not be portrayed as the preferred, acceptable, or only way to resolve conflict; or encourage children to imitate dangerous acts which they may see on television. Any realistic depictions of violence will be infrequent, discreet, of low intensity and will show the consequences of the acts. Other Content Guidelines: There will be no profanity, nudity or sexual content.
G	<b>General Audience</b> - Violence Guidelines: Will contain very little violence, either physical or verbal or emotional. Will be sensitive to themes which could frighten a younger child, will not depict realistic scenes of violence which minimize or gloss over the effects of violent acts. Other Content Guidelines: There may be some inoffensive slang, no profanity and no nudity.
PG	<b>Parental Guidance</b> - Programming intended for a general audience but which may not be suitable for younger children. Parents may consider some content inappropriate for unsupervised viewing by children ages 8-13. Violence Guidelines: Depictions of conflict and/or aggression will be limited and moderate; may include physical, fantasy, or supernatural violence. Other Content Guidelines: May contain infrequent mild profanity, or mildly suggestive language. Could also contain brief scenes of nudity.
14+	<b>Programming contains themes or content which may not be suitable for viewers under the age of 14</b> - Parents are strongly cautioned to exercise discretion in permitting viewing by pre-teens and early teens. Violence Guidelines: May contain intense scenes of violence. Could deal with mature themes and societal issues in a realistic fashion. Other Content Guidelines: May contain scenes of nudity and/or sexual activity. There could be frequent use of profanity.
18+	<b>Adult</b> - Violence Guidelines: May contain violence integral to the development of the plot, character or theme, intended for adult audiences. Other Content Guidelines: May contain graphic language and explicit portrayals of nudity and/or sex.

# LOCKS

## Canadian Ratings (Frn)

Use CANADIAN RATINGS (FRN) to block Canadian French programs according to various program ratings that you feel might be inappropriate in its content.

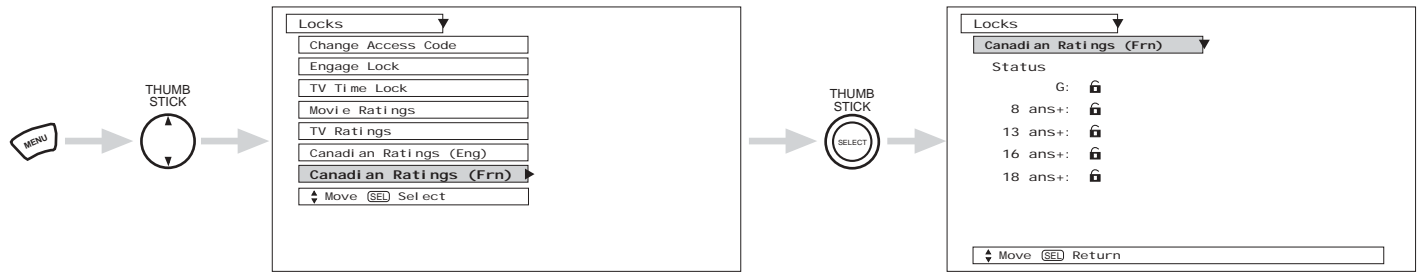

Use THUMB STICK ▲ or ▼ to highlight the category that you want to block. Press SELECT to set the CANADIAN RATINGS (FRN) that you have selected. Once rating is selected, for example 8 ans+, all movies and television programs rated 8 ans+ and higher will be automatically blocked. Press EXIT to quit menu or select THUMB STICK ◀ to return to the previous menu.

## Canadian Ratings French Chart

G	<b>General</b> - Programming intended for audiences of all ages. Contains no violence, or the violence content is minimal or is depicted appropriately with humor or caricature or in an unrealistic manner.
8 ans +	<b>8 + General - Not recommended for young children</b> - Programming intended for a broad audience but contains light or occasional violence that could disturb young children. Viewing with an adult is therefore recommended for young children (under the age of 8) who cannot differentiate between real and imaginary portrayals.
13 ans +	<b>Programming may not be suitable for children under the age of 13</b> - Contains either a few violent scenes or one or more sufficiently violent scenes to affect them. Viewing with an adult is therefore strongly recommended for children under 13.
16 ans +	<b>Programming is not suitable for children under the age of 16</b> - Contains frequent scenes of violence or intense violence.
18 ans +	<b>Programming restricted to adults</b> - Contains constant violence or scenes of extreme violence.

# SETUP

## Setup

Select SETUP when setting your TV up for the first time. Use the THUMB STICK ▲ or ▼ on the remote to highlight the function desired.

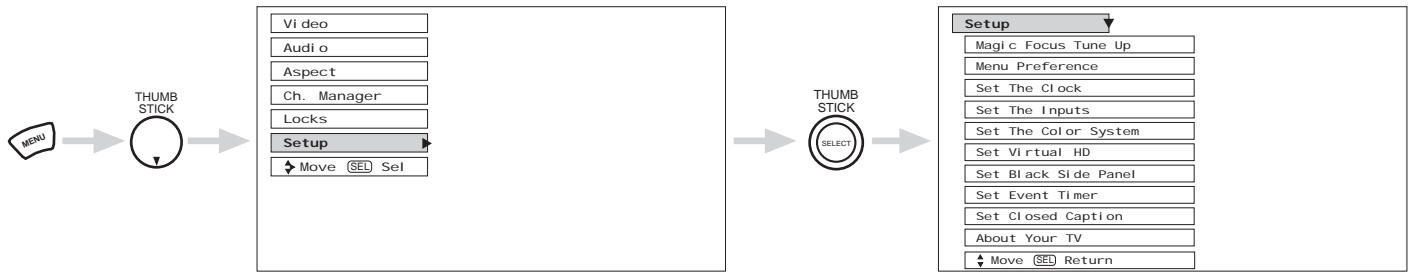

Use THUMB STICK ▲ or ▼ to select the sub-menu of your choice.

## Magic Focus Tune Up

### Auto Digital Convergence Adjustment

Please turn ON your television for at least 20 minutes before using this feature.

The Magic Focus button on control panel will not work when adjustment mode is set to Manual (see page 65).

Your HITACHI Projection TV has three color projection tubes: one for red, one for green, one for blue. When mixed together in the proper proportion, the output of these three color tubes can produce any color. To produce these colors, however, the beams must be precisely aligned over each other so that the colors can be mixed. The process of aligning these picture beams is called "convergence".

Over a period of time, the picture tubes can drift out of alignment due to normal bumps and vibrations or moving the TV. If you move your TV, or if, after a time, you notice color rings or halos around objects in the picture, you may want to converge (align) the colors.

Properly converged, the lines appear white, which is actually a combination of the outputs of the three color tubes. The output of the green tube is stationary. The outputs of the red and blue tubes can be adjusted. When properly aligned, the outputs of all three tubes should be directly over each other to produce the white lines.

To simplify convergence, HITACHI incorporates a function called MAGIC FOCUS located on the front control panel, which allows the TV to self-adjust. Press this MAGIC FOCUS button and the convergence self adjustment will start and this process will take approximately 20 seconds. If this button is pressed during this process, no change in picture quality will occur. After this 20 second self-adjust period, picture quality will be optimum. (Do not move the TV during self-adjust.)

You may also select MAGIC FOCUS TUNE UP from the Setup Menu.

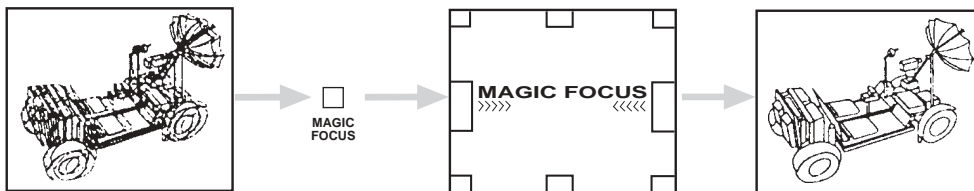

**NOTES:** Only a momentary press of the MAGIC FOCUS button is necessary to start AUTO DIGITAL CONVERGENCE. At any time during this convergence correction process, you may press the MAGIC FOCUS button to exit the MAGIC FOCUS mode. However, the convergence correction process needs to be completed to SAVE the new corrected convergence data.

ON-SCREEN DISPLAY

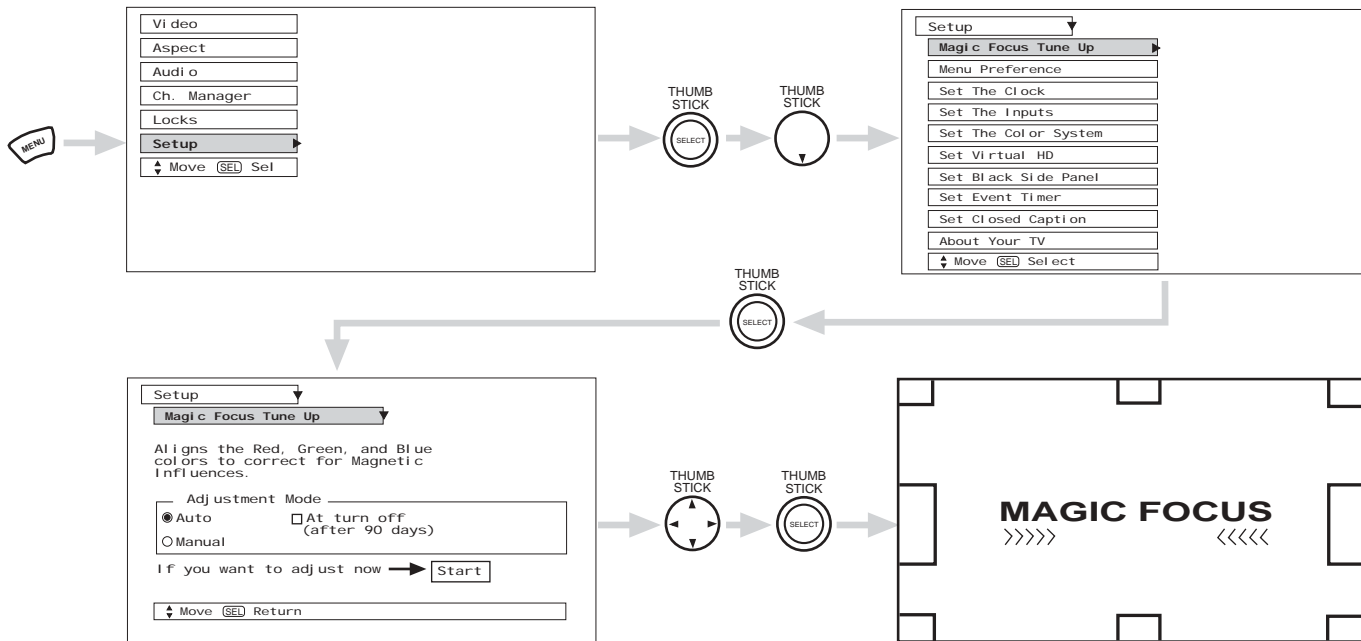



# SETUP

## Manual Convergence Adjustment Mode

- NOTES:**
1. Please turn ON your television for at least 20 minutes before using this feature.
  2. Auto Adjustment Mode is recommended. If convergence is still not acceptable, use the Manual Adjustment Mode. DO NOT press MAGIC FOCUS or use Auto Adjustment Mode after using Manual Adjustment Mode.

Using the Remote Control, select SETUP-MAGIC FOCUS TUNE UP-MANUAL ADJUSTMENT MODE-START to access convergence crosshatch pattern. The adjustment point is indicated by the Adjustment Point Cursor.

### To Move Adjustment Point

To move the adjustment point cursor using the THUMBSTICK, the Adjustment Cursor must be WHITE. Another way to move the Adjustment Point Cursor is to press the following buttons: [2] up, [4] left, [5] down, [6] right. If you use the number buttons while the adjustment point is WHITE, it will change to RED.

### To Change the Color of Adjustment Point

Press the SELECT button repeatedly (WHITE-RED-BLUE-WHITE...). Green color is fixed and cannot be adjusted.

### To Adjust the Convergence

Move the Adjustment Cursor to the point to be adjusted. Use the THUMB STICK to match the RED and BLUE colors to GREEN (reference color). Properly aligned, all three colors should appear white.

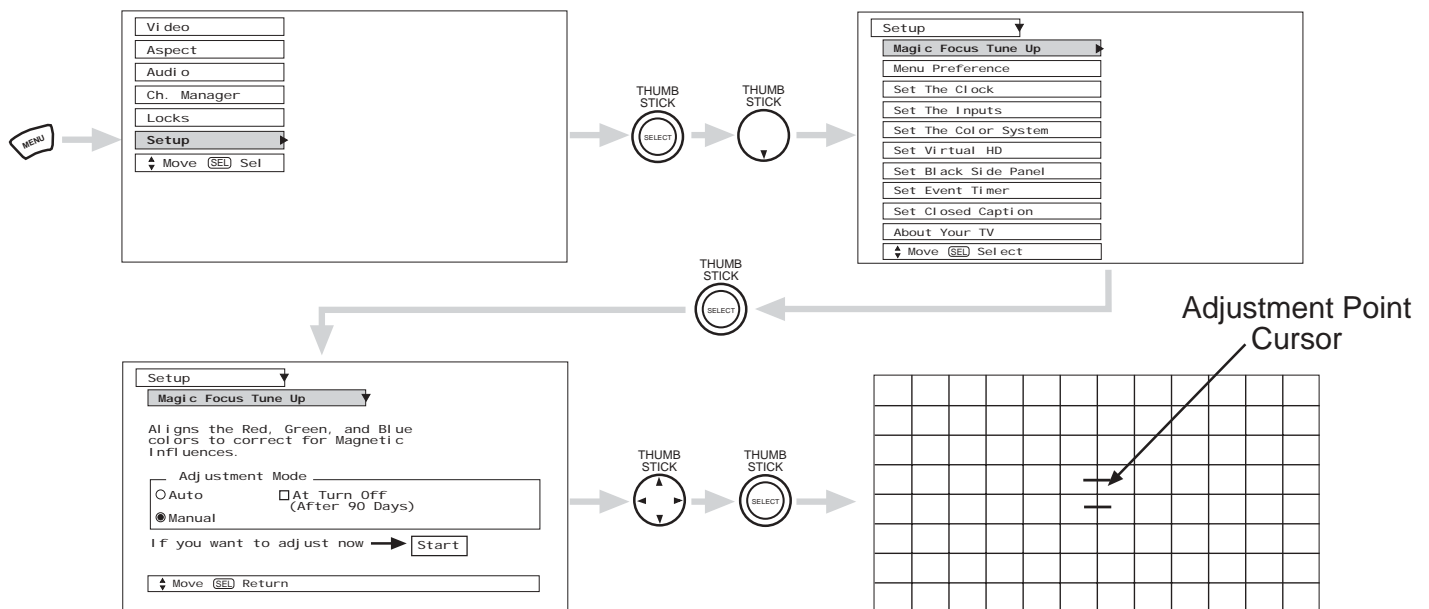

If convergence is acceptable after Manual Convergence adjustment, press EXIT button to access menu mode.

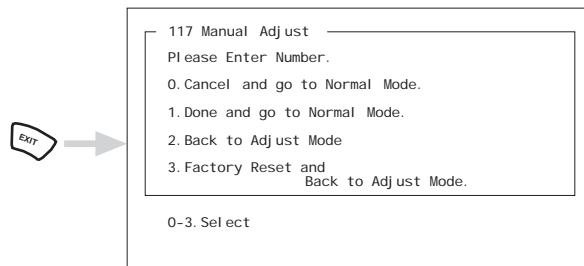

Press the [0] button on the remote control to CANCEL adjusted data and return to main picture.

Press the [1] button on the remote control to SAVE adjusted data and return to main picture.

Press the [2] button on the remote control to return to the manual convergence adjustment mode (crosshatch pattern).

Press the [3] button on the remote control to recall the factory pre-set convergence data.

Press the [9] button on the remote control to read the SAVED adjusted data. If there is no saved data, pressing the [9] button will recall the factory pre-set data.

## Menu Preference

This feature will allow you to select any one of three different languages for all on-screen displays.

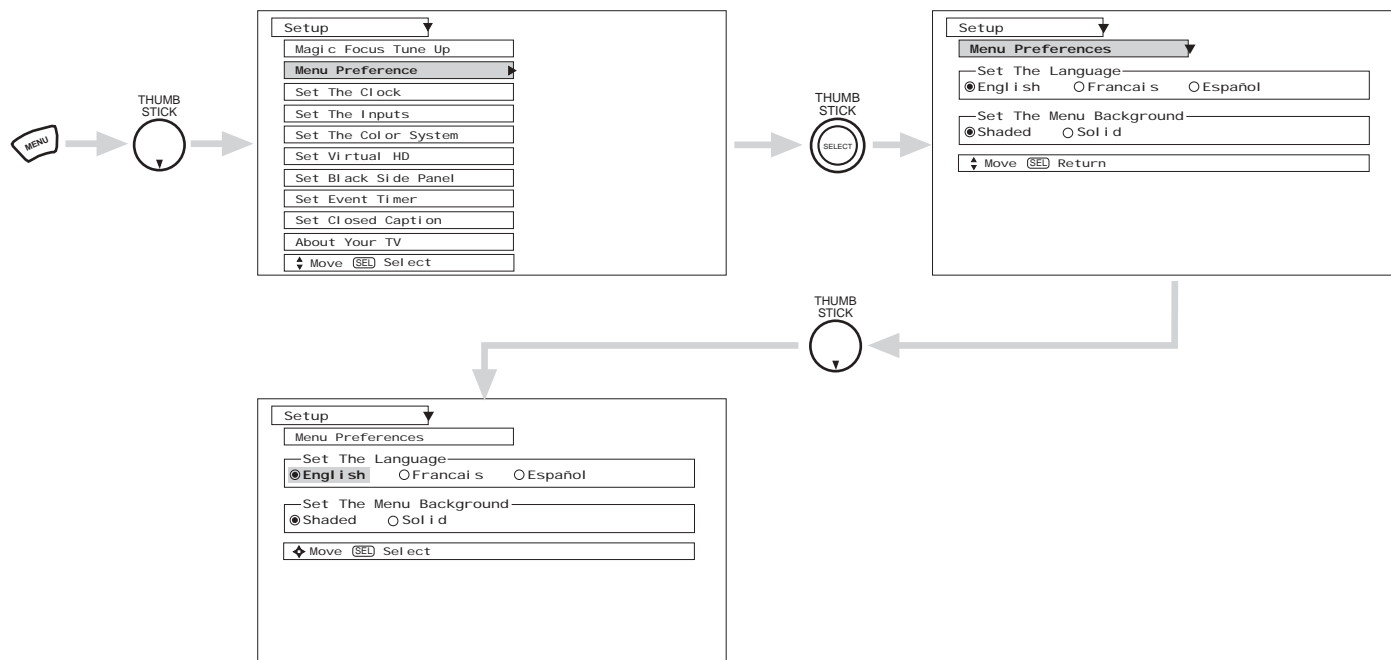

Use THUMB STICK ◀, ▶ to highlight the language of your choice.  
 Press SELECT to select the highlighted language.  
 Press EXIT to quit menu or select MENU PREFERENCE to return to previous menu.

# SETUP

## Menu Background

This function allows you to choose from two menu backgrounds.

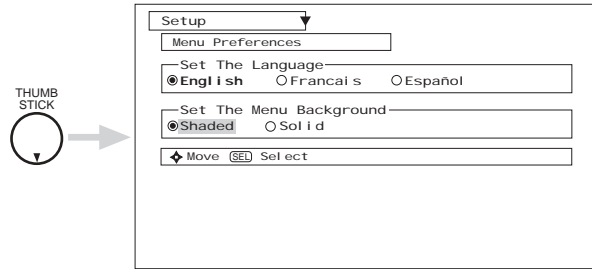

Use THUMB STICK ◀, ▶ to highlight SET THE MENU BACKGROUND (shaded or solid), and press down on THUMB STICK to select setting.

Press EXIT to quit menu or THUMB STICK ◀ to return to previous menu.

Select SOLID for a black background (no picture can be seen behind menu screen), or select SHADED for a light background.

## Set The Clock

The clock must be adjusted before you can use the “Set Event Timer” or “TV Time Out” features.

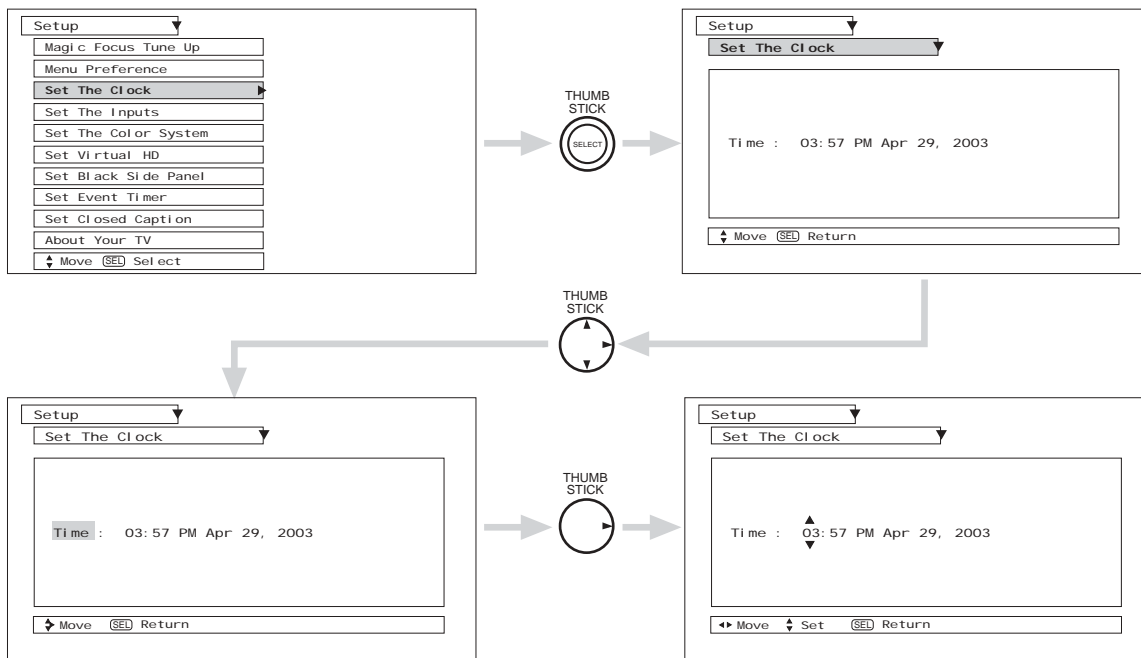

ON-SCREEN DISPLAY

Use THUMB STICK ▲ or ▼ to set the time and date.

Press THUMB STICK ◀ or ▶ to change position.

Press EXIT to quit menu.

## Set The Inputs

Use this feature to give a name to any of the five video inputs.

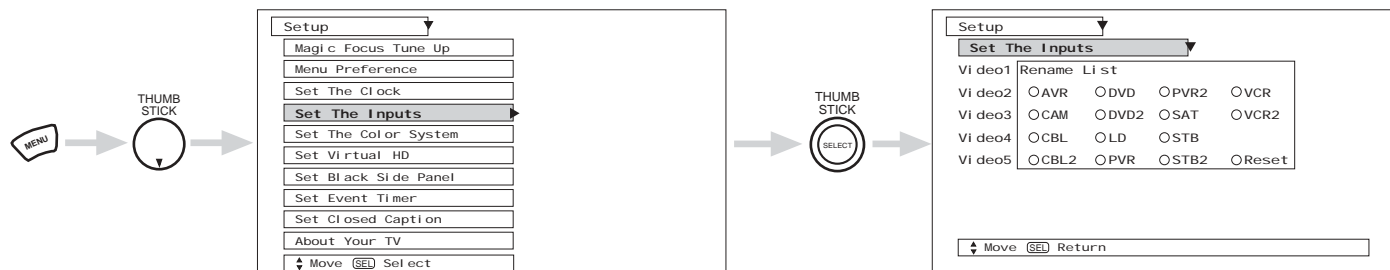

Press THUMB STICK ▲, ▼, ◀, ▶, to highlight the name of the video inputs.  
Press down on THUMB STICK to select desired input name.

Select RESET to set video names to original factory preset condition.

## Video 2 Auto Link

Use this function to automatically turn the TV on and tune to Video2 when it detects a video signal to input 2.

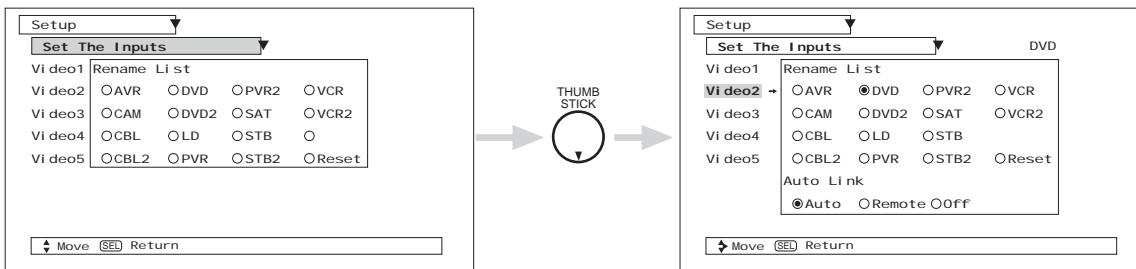

Use THUMB STICK ◀, ▶, ▲ or ▼, then press down on THUMB STICK to change AUTO LINK setting.

When AUTO is selected, the TV will turn on and tune to Video2 automatically, when the Video2 input device is turned on. This is convenient when you want to watch a movie with your VCR, laserdisc player, or DVD player.

When REMOTE is selected, the TV will turn on and switch to Video2 automatically when the Video2 input device is turned on and the VCR, laserdisc, or DVD play button on your remote control is pressed.

This is convenient when you want to record a movie with your VCR and watch it later.

Select Off to disable this function.

Press EXIT to quit menu.

- NOTES:**
1. Once the TV has been turned on using the AUTO LINK feature, it must be reset before AUTO LINK is used again. To do this, turn your VCR, laserdisc, or DVD player OFF. This feature is now reset and will turn on your TV as described above.
  2. When using REMOTE mode, any remote control button will substitute for your video input device play button. However, intended operation is for use with your VCR, laserdisc, or DVD play button.
  3. If no remote control button is pressed after the TV is turned on by AUTO LINK, the TV will automatically turn off after three hours.

# SETUP

---

## Set The Color System

This function allows you to automatically change tint and color coordinates for DTV programs.  
HDTV - High Definition Television - Use for High Vision Signal Y-P<sub>B</sub>P<sub>R</sub> from HDTV Set-Top Box.  
SDTV/DVD - Standard Definition Television or DVD (Digital Versatile Disc Player) Y-C<sub>B</sub>C<sub>R</sub>.

- NOTES:**
1. If Color System is set improperly (does not match actual input signal), the color and tint of the main picture will be abnormal.
  2. You must be tuned to VIDEO: 1 or 2 inputs and have a component hooked up to the Y-P<sub>B</sub>P<sub>R</sub> input jacks to access this color system.
  3. All component color type settings will affect only color component input you are currently viewing. If you are using both sets of component input jacks, be sure to set the color system feature for both inputs.

## Set Virtual HD

Use this feature to select between 1080i and 540p (see page 32).

## Set Black Side Panel

The BLACK SIDE PANEL function turns the gray side bars on/off when watching 4:3 signals in Standard mode. The top/bottom gray bar will appear in SPLIT MODE PIP and SPLIT FREEZE.

- NOTE:** To maximize operating life of the TV's picture tubes when watching 4:3 signal, Black Side Panel is cancelled at Power OFF. It is recommended to watch 4:3 signal with gray side bar.

## Set Event Timer

This function will automatically turn the Projection TV on and off, one time only, every day, or once a week.

If the clock is not set, you can not use this function and the screen below will appear. The message on the screen will disappear after 3 seconds, then the screen automatically goes to the clock setup mode (see page 67).

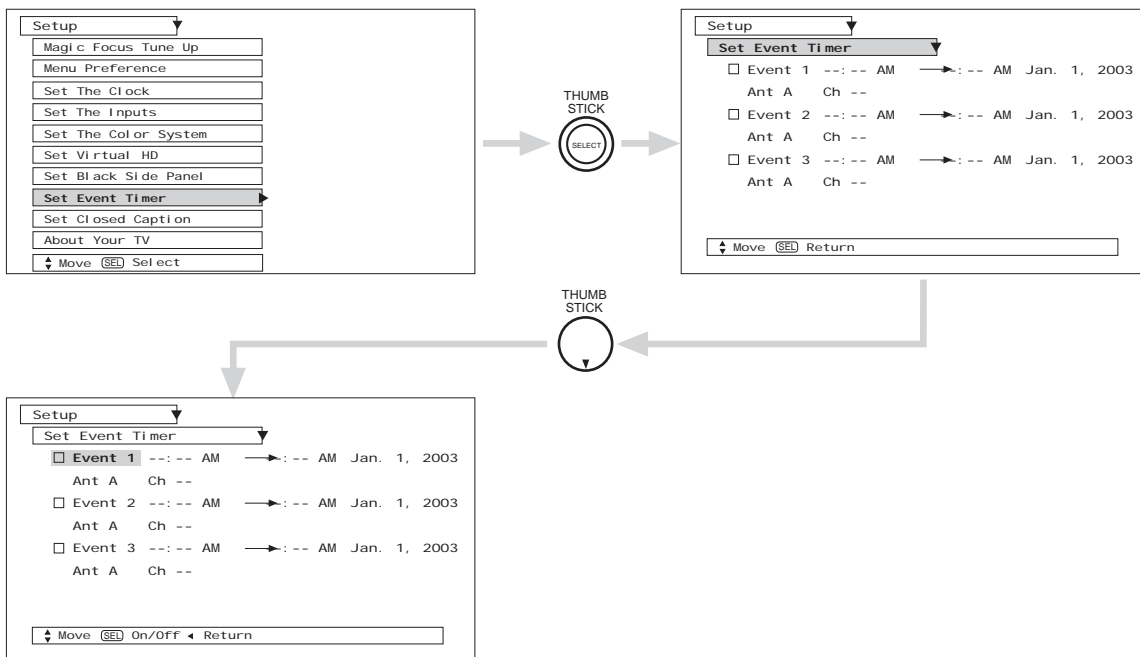
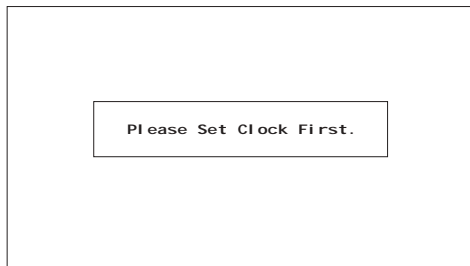

ON-SCREEN DISPLAY

Use THUMB STICK ▼, ▲ to highlight Event 1, 2 or 3 and then press THUMBSTICK to select.  
 Use THUMB STICK ► to change position of On time, Off time, Antenna, Channel, and On/Off Frequency.  
 Use THUMB STICK ▲ or ▼ to select the time the TV will turn on and off.  
 Use THUMB STICK ▲ or ▼ to select the day of the week you want the timer to turn on TV.  
 Use number buttons to set the channel the TV will tune to when it automatically turns on.  
 Use THUMB STICK ▲ or ▼ to select mode Once (TV will turn on/off one time only), Daily (TV will turn on/off at the same time every day), or Weekly-SUN (TV will turn on/off at same time every week).  
 Press EXIT to quit the menu.

- NOTE:**
1. The Event Timer will be disabled if the clock setting is changed.
  2. When the INFO button is pressed, the Event Timer Icon will only display the current date ON/OFF timer.
  3. The Off Timer will only activate if the TV was turned on by the On Timer and no channel selection was made after this time. If you change the channel after the On Timer has been activated, the Off Timer will deactivate.
  4. If no remote control button is pressed after Event Timer is activated, the TV will automatically turn off after three hours. Therefore, do not Set Event Timer for more than three hours if you do not plan to control your television with the remote control.



**CAUTION:** Do not use your TV as a deterrent when away from home by using the On and Off Timers. For safety, the TV should be turned off when you are away from home.

# SETUP

## Set Closed Caption

Closed Captions are the dialogue, narration, and/or sound effects of a television program or home video which are displayed on the TV screen. Your local TV program guide denotes these programs as **CC** or .

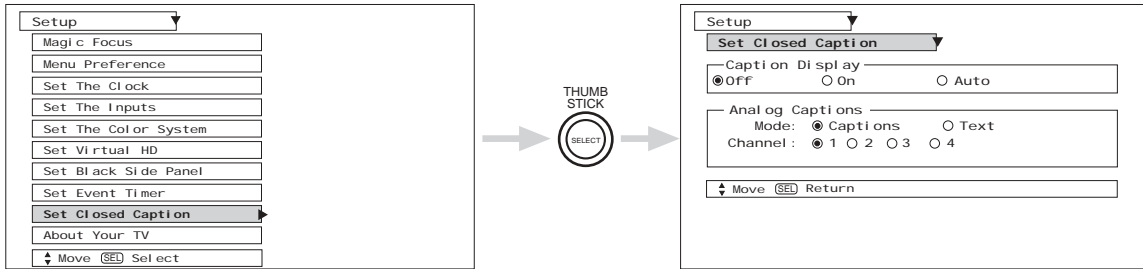

**Caption Display: On/Off** will turn the **CC** display on or off.

**Auto** will turn the **CC** display on when Mute/Soft Mute is on.

**Caption Mode: Captions** is for the program you are viewing.

**Text** is for additional information such as news reports or a TV program guide. This information covers the entire screen and viewing the TV program is not possible. Text may not be available with every **CC** program.

- CHANNEL:**
- 1 is used for the primary language (usually English).
  - 2 is sometimes used for a second language (may vary by region).
  - 3 is sometimes used for a third language (may vary by region).
  - 4 is sometimes used for a fourth language (may vary by region).

Use THUMB STICK ▲, ▼ to highlight the function to change then press THUMB STICK to change the function. Press EXIT to quit menu or THUMB STICK ◀ to return to previous menu.

- NOTE:**
1. CAPTION DISPLAY will not work when viewing a 480p, 720p, or 1080i input via the COMPONENT: Y-P<sub>B</sub>P<sub>R</sub> inputs.
  2. When PIP Surf is on, Closed Caption will not work.

## About Your TV

The TV model name and set dimensions will be displayed on the TV screen. The set dimensions of each TV model are listed on page 75.

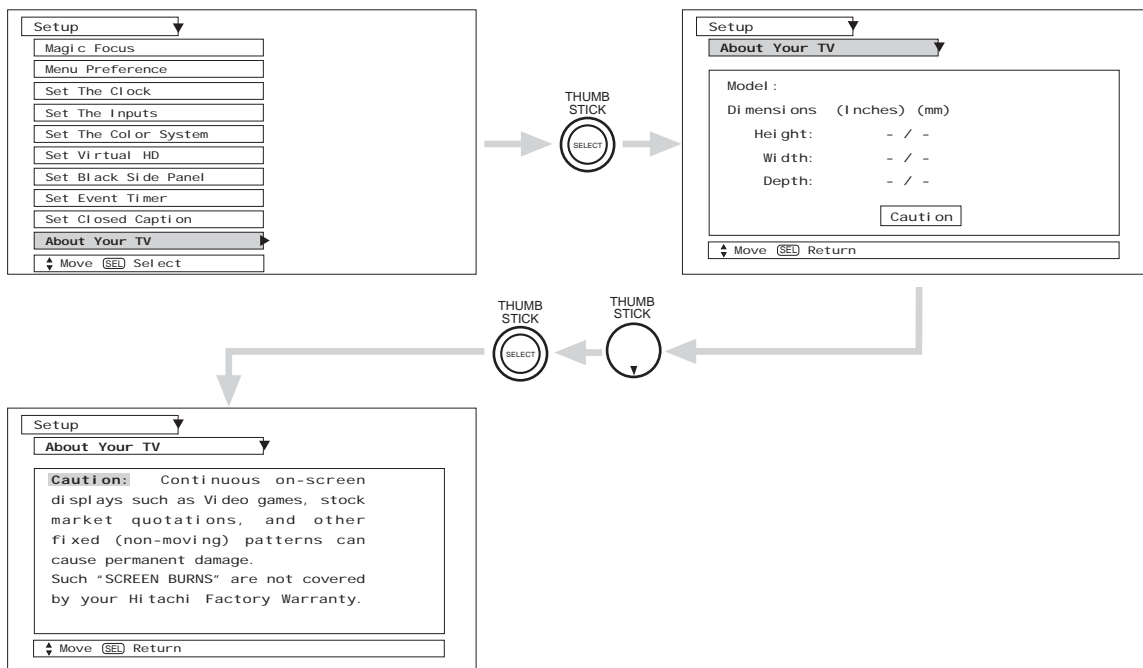

ON-SCREEN DISPLAY



# CARE OF YOUR HITACHI TELEVISION AND YOUR REMOTE CONTROL

## DO

Dust the screen and cabinet with a soft cloth.

Clean the screen with a soft cloth moistened in warm water and dry with a soft cloth. A mild soap may be used if the screen is extremely dirty.

Place your Television away from extreme heat, humidity, and extremely dusty places.

Remove the plug from the wall outlet if your Television will not be used for a long period of time, for instances, when you go on vacation.

## DO NOT

Do not clean your screen or cabinet with strong cleaners, polishes or a chemically treated cloth.

Do not place rubber or vinyl products or cellophane tape on your Television.

Do not touch the screen too often.

Do not subject the remote control to shocks such as dropping it on the floor, etc. Physical damage to the precision parts may result.

Avoid placing the remote control or the Simple Remote Control in a high humidity place or getting it wet. Do not leave it on or near a heater. Excessive heat or moisture may cause the unit to cease operation.





When the batteries run down, remote control operation will become erratic or possibly stop altogether. Replace the old batteries with two new "AA" or "AAA" size batteries. Do not use an old battery with a new battery.

Exposure of the viewing screen to prolonged direct sunlight or heat may cause the screen to permanently warp, resulting in a distorted picture.



# RECEPTION PROBLEMS



	<ul style="list-style-type: none"><li>• <b>IGNITION NOISE:</b> Black spots or horizontal streaks may appear, picture may flutter or drift. Usually caused by interference from automobile ignition systems, neon lamps, electrical drills, and other electrical appliances.</li></ul>
	<ul style="list-style-type: none"><li>• <b>GHOSTS:</b> Ghosts are caused by the television signal following two paths. One is the direct path and the other is reflected from tall buildings, hills or some other objects. Changing the direction or position of the antenna may improve reception. Ghosting may also be caused by defects in the antenna system such as unshielded leads or connecting several sets to the same antenna without using multiple antenna couplers.</li></ul>
	<ul style="list-style-type: none"><li>• <b>SNOW:</b> If your receiver is located in the fringe area of a television station where the signal is weak, your picture may be marred by the appearance of small dots. When the signal is extremely weak, it may be necessary to install a special antenna to improve the picture.</li></ul>
	<ul style="list-style-type: none"><li>• <b>RADIO FREQUENCY INTERFERENCE:</b> The interference produces moving ripples or diagonal streaks, and in some cases, causes loss of contrast in the picture.</li></ul>

**NOTE:** The TV set can generate sound distortion in external devices such as a radio. Please separate radio equipment from the TV set to a considerable distance.



SYMPTOMS	CHECK THESE ITEMS AND TRY THESE ADJUSTMENTS												
	Be sure external connection is correct	Be sure power cord is plugged in	Be sure TV is switched "ON"	Try another channel (station trouble)	Check antenna connections (station trouble)	Check antenna connections (back of TV)	Check outside antenna	Check for local interference	Adjust Contrast control	Adjust Brightness control	Adjust Color control	Adjust Tint control	Adjust Volume control
No Picture, no sound	●	●	●	●	●	●	●						
Sound OK, picture poor	●			●	●	●	●	●	●				
Picture OK, sound poor	●			●	●	●	●	●					●
Picture blurred	●			●	●	●	●	●					
Lines or streaks in picture				●	●	●	●	●					
Poor reception on some channels				●	●	●	●	●					
Picture rolls vertically				●				●					
No color	●			●	●	●	●			●			
Poor color	●			●	●	●	●			●	●		

HITACHI Projection Television incorporates advanced power surge protection technology designed to protect against component or circuit damage due to external or internal voltage power surges.

IF YOUR TELEVISION SHOULD APPEAR TO HAVE A LOSS OF POWER, PLEASE FOLLOW THIS PROCEDURE:

1. Press the power switch (ON/OFF switch) once.
2. If there is still no power, wait 30 seconds and press the power switch again.
3. If there is still no power, unplug the power cord from the wall. Wait 30 seconds and plug the power cord back in. Press the power switch again.

This protective technology should provide for years of lasting entertainment from your HITACHI Projection Television.



# USEFUL INFO

## Features:

- Superfine Picture Quality  
1280 Line Horizontal Resolution
- Remote (Controls many VCR brands, cable boxes, satellite boxes, and other audio equipment.)
- Extra Simple Remote for easy basic operations.
- New Easy-to-Use (3-Language) On-Screen Menu
- New AV Network Infra-Red (IR) System  
Control up to 4 components with one remote. (2 IR Mouse cables included.)
- Full Set of Input Jacks, including S-VIDEO
- COMPONENT VIDEO: Y-P<sub>B</sub>/P<sub>R</sub>
- Velocity Modulation
- Six Aspect Modes
- Closed Caption Decoder
- 2-Tuner Picture in Picture
- Magic Focus (Auto Digital Convergence and Manual Adjustment)
- Dual Antenna Inputs
- Video Input Sensor
- 3 Dimensional Y/C Comb Filter
- Full 1080i HDTV capable when used with a Set-Top Box.
- High bandwidth Digital Content Protection V1.0 compatible.
- Photo MC(View digital still pictures from a memory card).
- **BBE** Technology.
- **SRS** Technology.

\*SRS and the  symbol are registered trademarks of SRS Labs, Inc. SRS technology is incorporated under license from SRS Labs, Inc.

\*Licensed by BBE Sound, Inc. under USP4638258 and 4482866. BBE and BBE symbol are registered trademarks of BBE Sound, Inc. Manufactured under license from BBE Sound, Inc.

## Inputs:

- Power Input . . . . .AC 120V, 60Hz
- Stand-by Power . . . . .1.3W
- Power Consumption  
- Refer to rear panel at the back of the T.V.
- Antenna input impedance . . . . .75 Ohm
- Channel coverage . . . . .181ch.  
VHF-Band . . . . .2 ~ 13  
UHF-Band . . . . .14 ~ 69  
CATV Mid Band . . . . .A-5 ~ A-1  
. . . . .A-I  
Super Band . . . . .J-W  
Hyper Band . . . . .W+1 - W+28  
Ultra Band . . . . .W+29 - W+84
- Video . . . . .1.0Vp-p, 75 Ohm
- S-Video  
Luminance (Y) . . . . .1.0Vp-p, 75 Ohm  
Chrominance (C) . . . . .0.286Vp-p, 75 Ohm
- Component Video  
Luminance (Y) . . . . .1.0Vp-p, 75 Ohm  
Chrominance (P<sub>B</sub>/P<sub>R</sub>) . . . . .0.7Vp-p, 75 Ohm
- Audio input Impedance . . . . .47k Ohm
- Average input level . . . . .470mVrms
- DVI - HDTV . . . . .DVI 25pin

## Outputs:

- Video . . . . .1.0Vp-p. 75 Ohm
- Audio (Fixed) . . . . .470mVrms, 1k Ohm

## Dimensions:

	<b>57T500</b>	<b>57X500</b>	<b>65T500</b> <b>65X500</b>
• Height (in.) (mm)	54 3/16 1,376.2	54 3/16 1,376.2	59 7/8 1,520.7
• Width (in.) (mm)	54 1,372.0	54 1,372.0	61 1,549.0
• Depth (in.) (mm)	25 1/2 647.9	25 9/16 648.7	28 3/16 716.0
• Weight (lbs.)	265	265	324

**NOTE:** Due to improvements, specifications in this operating guide are subject to change without notice.



# HITACHI

*Service  
hotline*

To locate an authorized  
HITACHI service facility  
in the continental U.S.A.  
and Canada,

**DIAL TOLL FREE**

7 days a week, 24 hours a day

**800 HITACHI**

**(1-800-448-2244)**

## **Hitachi America, LTD. Home Electronics Division**

Hitachi has made every effort to assure you hours of trouble free operation from your unit. However, should you require service, a network of Hitachi Authorized Service Facilities has been established in all 50 states and Puerto Rico. Each facility will provide you with convenient and expedient assistance. Our service hotline operator will direct you to the Hitachi Authorized Service Facility nearest you. Just present proof of purchase and/or delivery receipts to the Hitachi Authorized Service Facility, and service will be rendered in accordance with the terms of the limited warranty as stated on your warranty card or operating guide.

***Should you have any questions regarding warranty, service, operation, or technical assistance, please contact:***

**Hitachi America, LTD.  
Home Electronics Division**  
900 Hitachi Way  
Chula Vista, CA 91914-3556



## USEFUL INFO

---

### Hitachi Canada, LTD. Digital Media Division

---

*Should you have any questions regarding warranty, service, operation, or technical assistance, please contact:*

**In Canada:  
1-800-HITACHI  
(1-800-448-2244)**

**Monday - Friday EST 9:00am - 7:00pm  
Saturday EST 9:00am - 5:00pm**

*Look for your French Manual on the outside of the box.  
If the manual is missing, call*

**1-800-HITACHI  
(1-800-448-2244)**

*for a copy.*

---

*Pour de plus amples renseignements sur le service durant la période couverte par la garantie, sur le fonctionnement ou pour de l'assistance technique communiquez avec:*

**Au Canada:  
1-800-HITACHI  
(1-800-448-2244)**

**Lundi - Vendredi L'EST 9:00am - 7:00pm  
Samedi L'EST 9:00am - 5:00pm**

*La version français de votre manual se trouve a l'exterieur de la boîte.  
Si le manuel est manquant, coposez le*

**1-800-HITACHI  
(1-800-448-2244)**

*pour obenir votre copie.*

**HITACHI CANADA, LTD.  
6740 Campobello Road  
Mississauga, ON L5N 2L8**



<b>A</b>	
Accessories, .....	4
Antennas (Connecting), .....	5, 6
Aspect Ratio, .....	31, 53
Audio (Sound Enhancement)	
SRS .....	52
BBE .....	52
Audio Settings .....	51-52
Audio Source .....	51
Auto Color .....	50
Auto Noise Cancel .....	51
AV Network .....	20-22
<b>B</b>	
Balance .....	51
Bass .....	51
Black Enhancement .....	48
Brightness .....	48
<b>C</b>	
Channel Manager .....	54-57
Channel Source .....	54
Auto Channel Scan .....	55
Clock	
Time .....	67
Closed Captions	
Captions .....	71
Color System .....	69
Color Temperature .....	48
Color .....	48
Contrast .....	48
Convergence (see Magic Focus)	
<b>D</b>	
DVI-HDTV .....	10, 18
<b>E</b>	
Edge Enhancement .....	48
Event Timer ANT A/B .....	70
<b>I</b>	
Input Setup .....	68
IR Blaster .....	10, 20
<b>L</b>	
Language	
Menu Language .....	66
Locks	
Change Access Code .....	58
Channel Lock .....	58
Input Lock .....	58
Locks (Continued)	
Front Panel Lock .....	58
TV Time Lock .....	58
Movie Ratings .....	59
TV Ratings .....	60
TV Ratings (Canadian - English) .....	61
TV Ratings (Canadian - French) .....	62
Loudness .....	51
<b>M</b>	
Magic Focus	
Auto Convergence .....	7, 64
Manual Convergence .....	65
Menu Preference	
Language .....	66
Background .....	67
Monitor Out .....	9
<b>N</b>	
Noise Reduction .....	50
<b>P</b>	
Perfect Volume .....	51
Photo MC .....	7, 27-28
Picture Mode .....	47
Picture-in-Picture (PIP) .....	34-36
Picture-outside-Picture (POP) .....	34
<b>R</b>	
Remote Control	
Functions .....	23-44
Installing Batteries .....	4
Programming Codes .....	37-42, 44
Simple Remote .....	43
<b>S</b>	
Sharpness .....	48
Sound Enhancement .....	51-52
Speakers .....	51
Connecting External Speakers .....	5, 14
<b>T</b>	
Time .....	67
Tint .....	48
Treble .....	51
<b>V</b>	
Video Settings .....	47-50
Virtual HD .....	32

# NOTES

---



**HITACHI**



## Free Manuals Download Website

<http://myh66.com>

<http://usermanuals.us>

<http://www.somanuals.com>

<http://www.4manuals.cc>

<http://www.manual-lib.com>

<http://www.404manual.com>

<http://www.luxmanual.com>

<http://aubethermostatmanual.com>

Golf course search by state

<http://golfingnear.com>

Email search by domain

<http://emailbydomain.com>

Auto manuals search

<http://auto.somanuals.com>

TV manuals search

<http://tv.somanuals.com>