

HITACHI

PROJECTION COLOR TV

65XWX20B
57XWX20B
51XWX20B

OPERATING GUIDE



IMPORTANT SAFETY INSTRUCTIONS 2-3

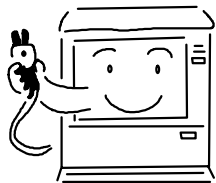

FIRST TIME USE 4-23

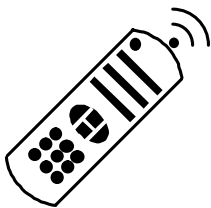

THE REMOTE CONTROL 24-42

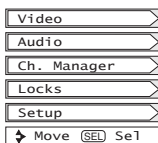

ON-SCREEN DISPLAY 43-71

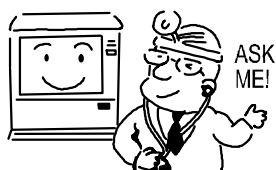

USEFUL INFORMATION INDEX 72-79



SAFETY POINTS YOU SHOULD KNOW ABOUT YOUR HITACHI TELEVISION

Our reputation has been built on the quality, performance, and ease of service of HITACHI televisions.

Safety is also foremost in our minds in the design of these units. To help you operate these products properly, this section illustrates safety tips which will be of benefit to you. Please read it carefully and apply the knowledge you obtain from it to the proper operation of your HITACHI television.

Please fill out your warranty card and mail it to HITACHI. This will enable HITACHI to notify you promptly in the improbable event that a safety problem should be discovered in your product model.

Follow all warnings and instructions marked on this television.

	<p>CAUTION</p> <p>RISK OF ELECTRIC SHOCK DO NOT OPEN</p>			<p>The lightning flash with arrowhead symbol, within an equilateral triangle, is intended to alert the user to the presence of uninsulated "dangerous voltage" within the product's enclosure that may be of a sufficient magnitude to constitute a risk of electric shock to persons.</p>
<p>CAUTION: TO REDUCE THE RISK OF ELECTRIC SHOCK, DO NOT REMOVE COVER (OR BACK). NO USER SERVICEABLE PARTS INSIDE. REFER SERVICING TO QUALIFIED SERVICE PERSONNEL.</p>				<p>The exclamation point within an equilateral triangle, is intended to alert the user to the presence of important operating and maintenance (servicing) instructions in the literature accompanying the appliance.</p>

WARNING:
TO PREVENT FIRE OR SHOCK HAZARD, DO NOT EXPOSE THIS TELEVISION TO RAIN OR MOISTURE.

NOTE:

- There are no user serviceable parts inside the television.
- Model and serial numbers are indicated on back side of the television.

CAUTION: Adjust only those controls that are covered in the instructions, as improper changes or modifications not expressly approved by HITACHI could void the user's authority to operate the television.



MODIFICATIONS: The FCC requires the user to be notified that any changes or modifications made to this device that are not expressly approved by Hitachi America, Ltd. Home Electronics Division may void the user's authority to operate the equipment.

POWER SOURCE

THIS TELEVISION IS DESIGNED TO OPERATE ON 120 VOLTS 60Hz, AC CURRENT. INSERT THE POWER CORD INTO A 120 VOLT 60Hz OUTLET.

TO PREVENT ELECTRIC SHOCK, DO NOT USE THE TELEVISION'S (POLARIZED) PLUG WITH AN EXTENSION CORD, RECEPTACLE, OR OTHER OUTLET UNLESS THE BLADES AND GROUND TERMINAL CAN BE FULLY INSERTED TO PREVENT BLADE EXPOSURE.

NEVER CONNECT THE TELEVISION TO 50Hz, DIRECT CURRENT, OR ANYTHING OTHER THAN THE SPECIFIED VOLTAGE.

NOTE: This television receiver will display television closed captioning, ( or ) in accordance with paragraph 15.119 and 15.122 of the FCC rules.

 **CAUTION:** Never remove the back cover of the television as this can expose you to very high voltages and other hazards. If the television does not operate properly, unplug the television and call your authorized dealer or service center.

IMPORTANT



Read before operating equipment

Follow all warnings and instructions marked on this television.

1. Read these instructions.
2. Keep these instructions.
3. Heed all warnings.
4. Follow all instructions.
5. Do not use this apparatus near water.
6. Clean only with a dry cloth.
7. Do not block any ventilation openings. Install in accordance with the manufacturer's instructions.
8. Do not install near any heat sources such as radiators, heat registers, stoves, or other apparatus (including amplifiers) that produce heat.
9. Do not defeat the safety purpose of the polarized or grounding-type plug. A polarized plug has two blades with one wider than the other. A grounding type plug has two blades and a third grounding prong. The wide blade or the third prong are provided for your safety. If the provided plug does not fit into your outlet, consult an electrician for replacement of the obsolete outlet.
10. Protect the power cord from being walked on or pinched particularly at plugs, convenience receptacles, and the point where they exit from the apparatus.
11. Only use the attachments/accessories specified by the manufacturer.



Use only with the cart, stand, tripod, bracket, or table specified by the manufacturer, or sold with the apparatus. When a cart is used, use caution when moving the cart/apparatus combination to avoid injury from tip-over.

13. Unplug this apparatus during lightning storms or when unused for long periods of time.
14. Refer all servicing to qualified service personnel. Servicing is required when the apparatus has been damaged in any way, such as power-supply cord or plug is damaged, liquid has been spilled or objects have fallen into apparatus, the apparatus has been exposed to rain or moisture, does not operate normally, or has been dropped.

Do not place any objects on the top of the television which may fall or cause a child to climb to retrieve the objects.

Projection TV's are heavy and can mark or damage floor surfaces (especially wood flooring) if moved improperly. Do not slide or force TV into position. Always roll TV allowing casters at bottom of unit to help steer and position the TV.

PREVENTION OF SCREEN BURN

This Wide Screen TV is designed to display wide screen pictures. Images should be viewed mostly in wide screen format or zoomed to fill the screen with moving pictures. Use of side panels, top and bottom panels of standard picture formats should only be 15% of your total viewing time to prevent uneven aging of the phosphors. Phosphors in the lighted area of the picture will age more rapidly than the gray areas. Continuous on-screen displays such as video games, stock market quotations, computer generated graphics, and other fixed (non-moving) patterns can cause permanent damage to television receivers. Such "SCREEN BURNS" constitute misuse and are **NOT COVERED** by your HITACHI Factory Warranty.

PUBLIC VIEWING OF COPYRIGHTED MATERIAL

Public viewing of programs broadcast by TV stations and cable companies, as well as programs from other sources, may require prior authorization from the broadcaster or owner of the video program material.

15. Televisions are designed to comply with the recommended safety standards for tilt and stability. Do not apply excessive pulling force to the front, or top, of the cabinet which could cause the product to overturn resulting in product damage and/or personal injury.
16. Follow instructions for wall, shelf or ceiling mounting as recommended by the manufacturer.
17. An outdoor antenna should not be located in the vicinity of overhead power lines or other electrical circuits.
18. If an outside antenna is connected to the receiver be sure the antenna system is grounded so as to provide some protection against voltage surges and built up static charges. Section 810 of the National Electric Code, ANSI/NFPA No. 70-1984, provides information with respect to proper grounding for the mast and supporting structure, grounding of the lead-in wire to an antenna discharge unit, size of grounding connectors, location of antenna-discharge unit, connection to grounding electrodes and requirements for the grounding electrode.

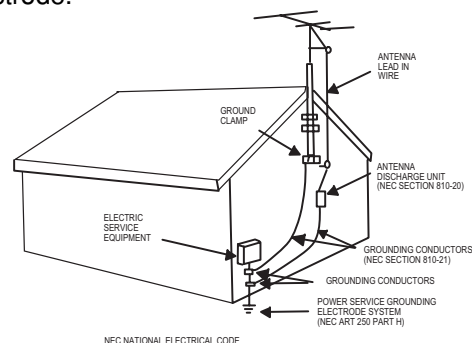

Note to the CATV system installer: This reminder is provided to call the CATV system installer's attention to Article 820-40 of the NEC that provides guidelines for proper grounding and, in particular, specifies that the cable ground shall be connected to the grounding system of the building, as close to the point of cable entry as practical.

Disposal of this product may require specific instructions pertaining to your resident state. For disposal or recycling information, please contact your local authorities or the Electronic Industries Alliance: www.eiae.org.



Check to make sure you have the following accessories before disposing of the packing material.

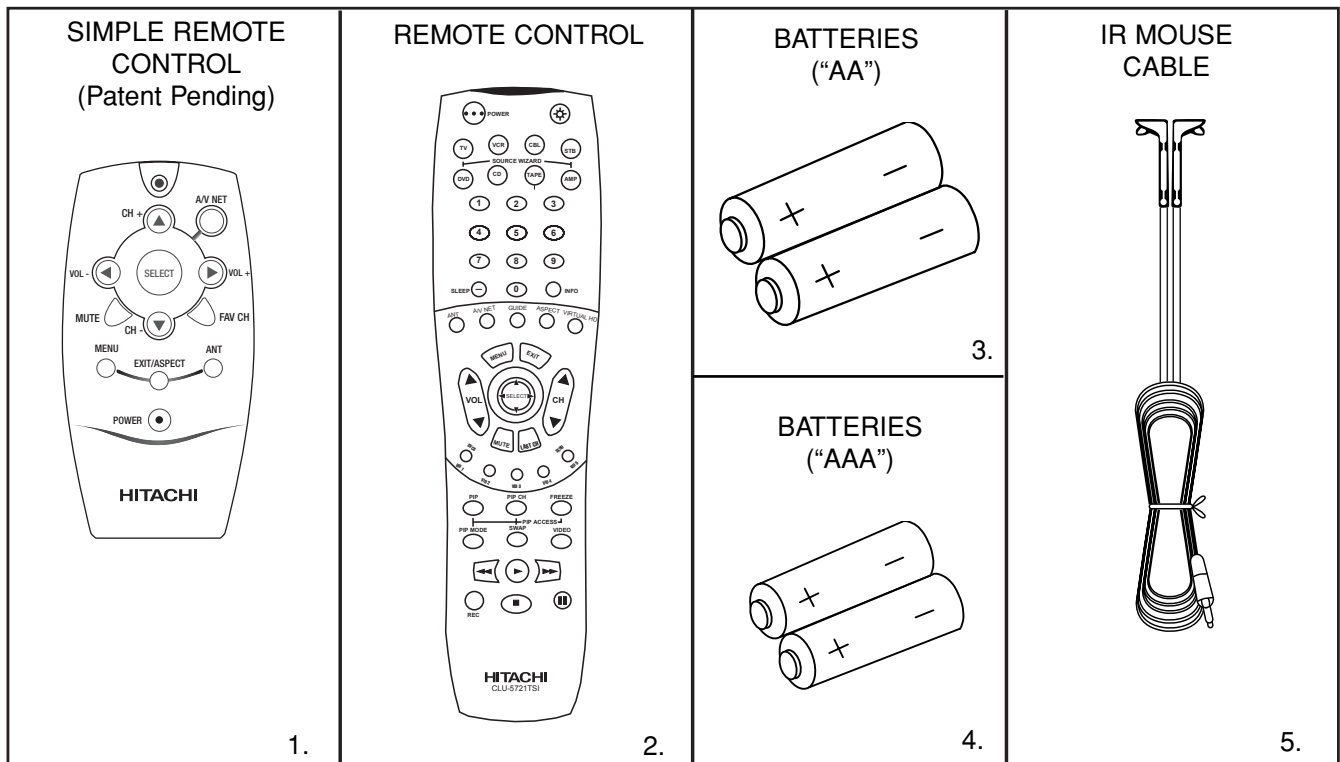

1. Simple Remote Control Unit CLU-121S (Part No. HL01862).
2. Remote Control Unit CLU-5721TSI (Part No. HL01821).
3. Two "AA" size, 1.5V batteries (For Remote Control Unit).
4. Two "AAA" size, 1.5V batteries (for Simple Remote Control Unit).
5. Two IR Mouse Cables (Part No. EY01641).

REMOTE CONTROL BATTERY INSTALLATION AND REPLACEMENT

1. Open the battery cover of the remote control by pushing the notched part of the cover with your fingers and pulling the cover off.
2. Insert two new "AA" size batteries for the remote control, and two new "AAA" size batteries for the simple remote control. When replacing old batteries, push them towards the springs and lift them out.
3. Match the batteries to the (+) and (-) marks in the battery compartment.

4. Replace the cover.

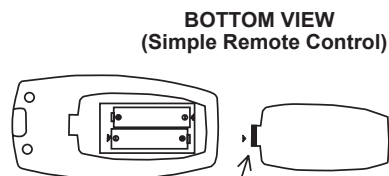

Lift up on tab to remove back cover.

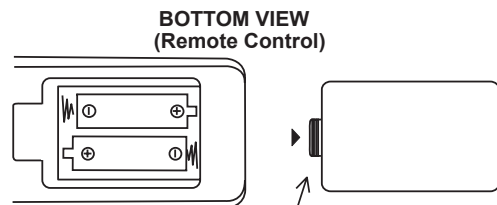

Lift up on tab to remove back cover.



CAUTION: Danger of explosion if battery is incorrectly replaced. Replace with the same or equivalent type.

HOW TO SET UP YOUR NEW HITACHI PROJECTION TV



ANTENNA

Unless your TV is connected to a cable TV system or to a centralized antenna system, a good outdoor TV antenna is recommended for best performance. However, if you are located in an exceptionally good signal area that is free from interference and multiple image ghosts, an indoor antenna may be sufficient.

LOCATION

Select an area where sunlight or bright indoor illumination will not fall directly on the picture screen. Also, be sure that the location selected allows a free flow of air to and from the perforated back cover of the set.

To avoid cabinet warping, cabinet color changes, and increased chance of set failure, do not place the TV where temperatures can become excessively hot, for example, in direct sunlight or near a heating appliance, etc.

VIEWING

The major benefit of the HITACHI Projection Television is its large viewing screen. To see this large screen at its best, test various locations in the room to find the optimum spot for viewing.

The best picture is seen by sitting directly in front of the TV and about 10 to 18 feet from the screen. Picture brightness decreases as the viewer moves to the left and right of the receiver.

During daylight hours, reflections from outside light may appear on the screen. If so, drapes or screens can be used to reduce the reflection or the TV can be located in a different section of the room.

If the TV's audio output will be connected to a Hi-Fi system's external speakers, the best audio performance will be obtained by placing the speakers equidistant from each side of the receiver cabinet and as close as possible to the height of the picture screen center. For best stereo separation, place the external speakers at least four feet from the side of the TV, place the surround speakers to the side or behind the viewing area. Differences in room sizes and acoustical environments will require some experimentation with speaker placement for best performance.

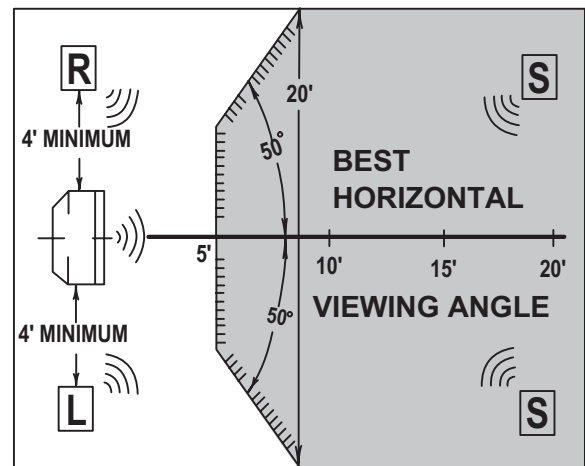
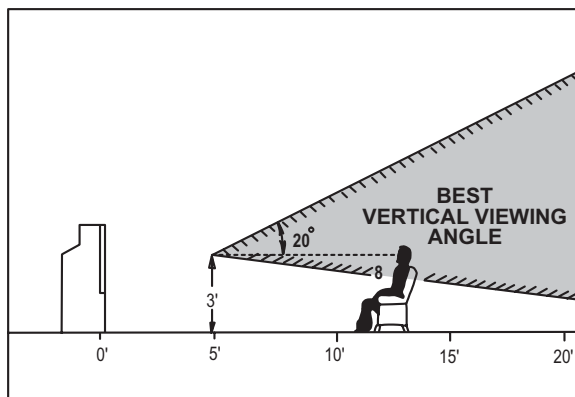

CAUTION: Magnetic fields, such as those of external speakers, may cause the picture to distort if they are placed too close to the television. Move the magnetic field source away from the television until there is no picture distortion.



HOOK-UP CABLES AND CONNECTORS

Most video/audio connections between components can be made with shielded video and audio cables that have phono connectors. For best performance, video cables should use 75-Ohm coaxial shielded wire. Cables can be purchased from most stores that sell audio/video products. Below are illustrations and names of common connectors. Before purchasing any cables, be sure of the output and input connector types required by the various components and the length of each cable.

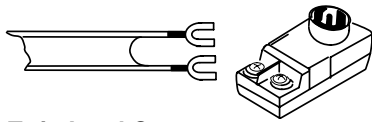

300-Ohm Twin Lead Connector

This outdoor antenna cable must be connected to an antenna adapter (300-Ohm to 75-Ohm).



"F" Type 75-Ohm Coaxial Antenna Connector

For connecting RF signals (antenna or cable TV) to the antenna jack on the television.



Phono Connector

Used on all standard video and audio cables which connect to inputs and outputs located on the television's rear jack panel and front control panel.



S-Video (Super Video) Connector

This connector is used on camcorders, VCRs and laser-disc players with an S-Video feature in place of the standard video cable to produce a high quality picture.

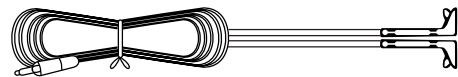

IR Mouse Cable (Provided)

Connect the IR Mouse Cable to the IR BLASTER output of your TV when using the A/V Network feature. You must place the IR mouse transmitter in front of the IR sensor of your external components. This connection allows your TV to control your external components without using your external component's remote control.

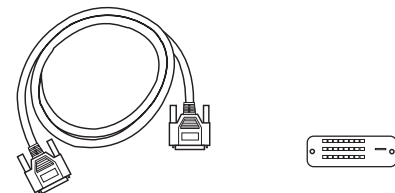

Digital Visual Interface (DVI) Connection Cable

This cable is used to connect external devices with DVI-HDTV output capability.



IEEE1394 Cable

This cable is used to connect your digital television to external digital devices.

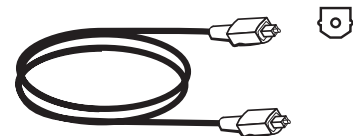

Optical Cable

This cable is used to connect to an audio amplifier with an Optical Audio In jack. Use this cable for the best sound quality.

ANTENNA CONNECTIONS TO REAR JACK PANEL

VHF (75-Ohm) antenna/CATV (Cable TV)

When using a 75-Ohm coaxial cable system, connect the outdoor antenna or CATV coaxial cable to the ANT A (75-Ohm) terminal. If you have a second antenna or cable TV system, connect the coaxial cable to the ANT B terminal.

To receive HDTV programs via the outdoor antenna or an un-encrypted digital Cable connection, connect to ANT C (DTV).

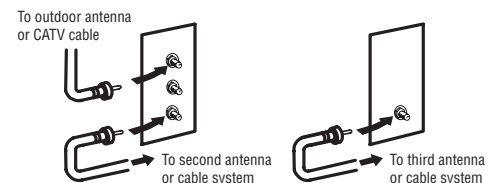

VHF (300-Ohm) antenna/UHF antenna

When using a 300-Ohm twin lead from an outdoor antenna, connect the VHF or UHF antenna leads to screws of the VHF or UHF adapter. Plug the adapter into the antenna terminal on the TV.

To outdoor VHF or UHF antenna

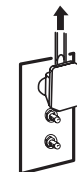

When both VHF and UHF antennas are connected

Attach an optional antenna cable mixer to the TV antenna terminal, and connect the cables to the antenna mixer. Consult your dealer or service store for the antenna mixer.

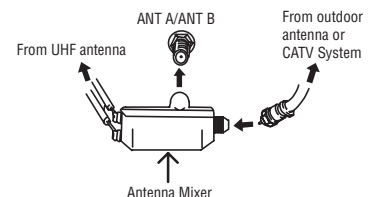



FRONT PANEL CONTROLS

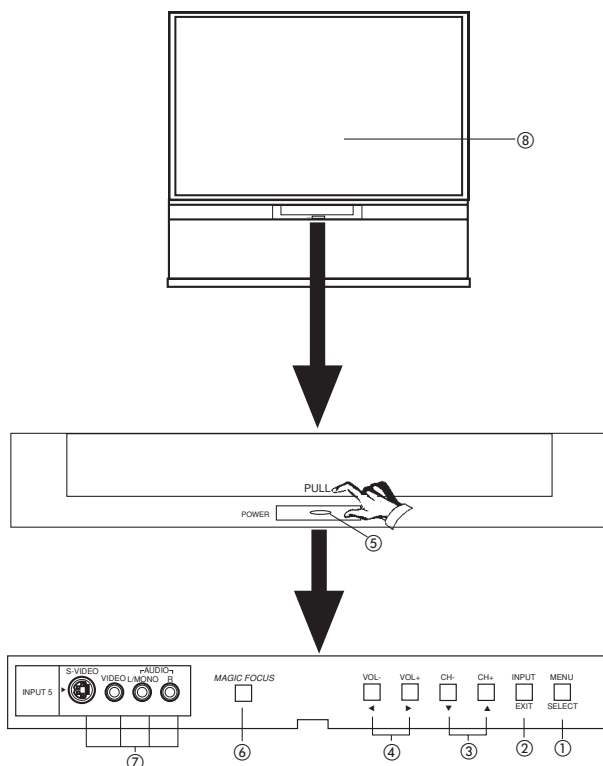

① MENU/SELECT button

This button allows you to enter the MENU, making it possible to set TV features to your preference without using the remote. This button also serves as the SELECT button when in MENU mode.

② INPUT/EXIT button

Press this button to select the current antenna source, VIDEO: 1, 2, 3, 4, 5 or alternate antenna source. Your selection is shown in the top right corner of the screen. This button also serves as the EXIT button when in MENU mode.

NOTES: Your remote control does not have an INPUT button. To change to video inputs, press VID1~VID5 buttons depending on your choice (see page 30). To change antenna source, press the ANT button on your remote control.

③ CHANNEL selector

Press these buttons until the desired channel appears in the top right corner of the TV screen. These buttons also serve as the cursor down (▼) and up (▲) buttons when in MENU mode.

④ VOLUME level

Press these buttons for your desired sound level. The volume level will be displayed on the TV screen. These buttons also serve as the cursor left (◀) and right (▶) buttons when in MENU mode. When the TV power is turned OFF at a volume level 31 or greater, the volume level will default to 30 when the TV is turned ON. However, if it is set to a level 30 or less, the volume level will be at the level it was set when the TV is turned ON.

⑤ POWER button

Press this button to turn the TV on or off.

⑥ MAGIC FOCUS

Use this button to automatically adjust your picture quality to optimum performance (see page 47). The Magic Focus button will not work when the Adjustment Mode is set to Manual (see page 48).

⑦ FRONT INPUT JACKS (INPUT 5)

Use these audio/video jacks for a quick hook-up from a camcorder or VCR to instantly view your favorite show or new recording. Press the INPUT button until VIDEO: 5 appears in the top right corner of the TV screen. If you have mono sound, insert the audio cable into the left audio jack.

⑧ IR RECEIVER

The screen area acts as the IR receiver (remote sensor) of the TV. When using the remote control, point it towards the screen for best response.



FRONT PANEL JACKS AND CONNECTORS

The front panel jacks are provided as a convenience to allow you to easily connect a camcorder or VCR as shown in the following examples:

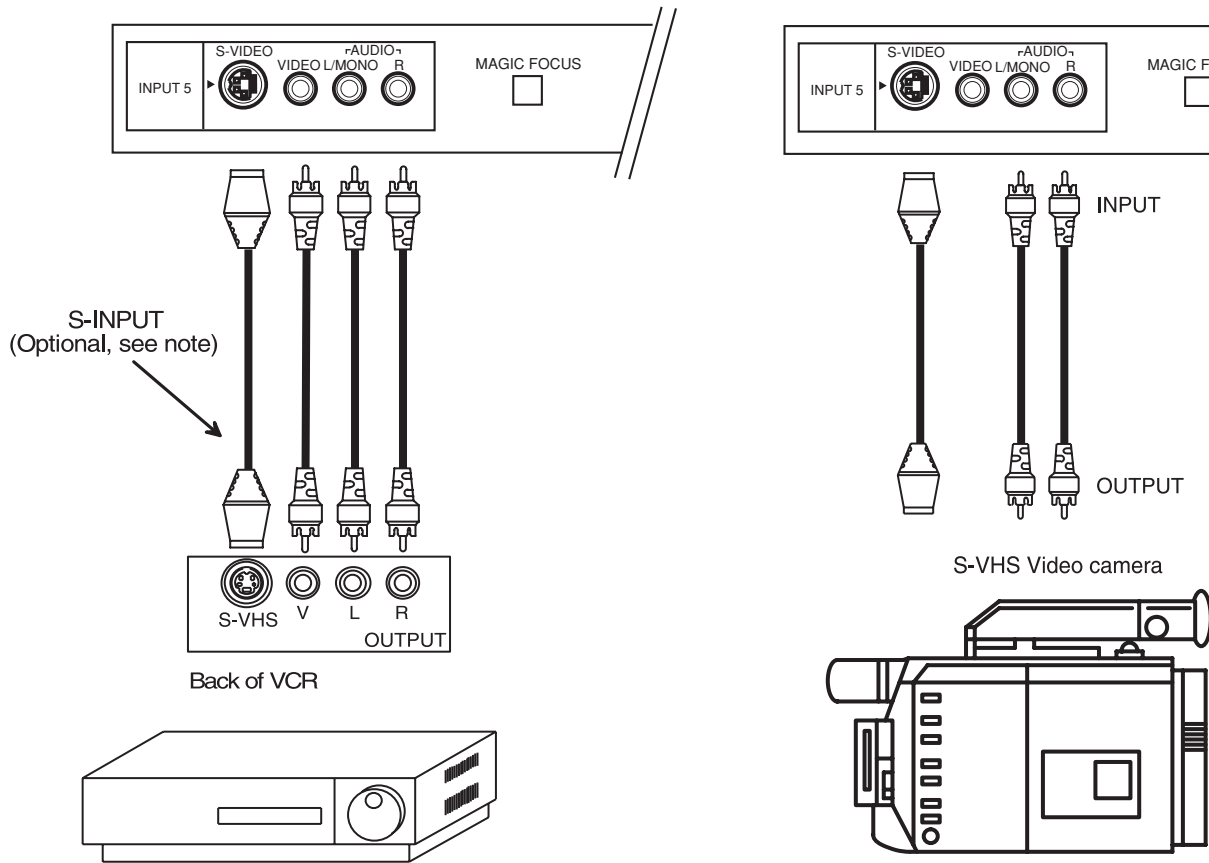

- NOTE:**
1. Completely insert connection cord plugs when connecting to front panel jacks. If you do not, the played back picture may be abnormal.
 2. If you have a S-VHS VCR, use the S-INPUT cable in place of the standard video cable.
 3. If you have a mono VCR, insert the audio cable into the left audio jack of your TV.



REAR PANEL JACKS

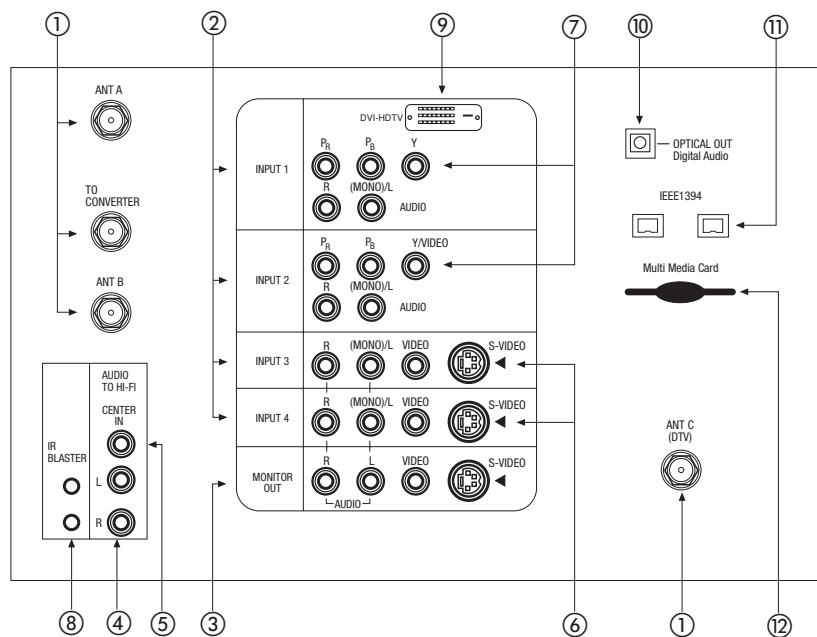

① Antenna Input/Output

ANT A- A 75-Ohm RF antenna or CATV (Cable TV) input. ANT A can be displayed as a main picture or sub-picture.

ANT B- A 75-Ohm RF antenna or CATV (Cable TV) input. ANT B can only be displayed as a main picture. ANT B cannot be displayed as a sub-picture.

TO CONVERTER- This antenna output allows the ANT A connection to pass directly to a different source, such as a cable box, only when ANT B is displayed as a main picture.

ANT C- A 75-Ohm RF antenna or un-encrypted digital CATV (Cable TV) input. ANT C can be displayed as a main picture or sub-picture. ANT C is used to receive digital broadcast signals. To watch any channel from ANT C, run Auto Channel Scan first (see page 65).

- NOTES:**
1. You may ask your local cable company whether DTV services are available.
 2. When in ANT C, only channels stored in Channel Manager during Auto Channel Scan can be tuned using the number buttons on the remote control (see pages 54-55 and 65).

② Audio/Video Inputs 1, 2, 3 and 4

The VID1~VID4 buttons will select each video source each time they are pressed. Use the audio and video inputs to connect external devices, such as VCRs, camcorders, laserdisc players, DVD players etc. (If you have mono sound, insert the audio cable into the left audio jack.)

- NOTE:** You may use VIDEO or S-VIDEO inputs to connect to INPUT 3 and 4, but only one of these inputs may be used at a time.

③ MONITOR OUT

These jacks provide fixed audio and video signals which are used for recording. Use the S-VIDEO Output for high quality video output.

- NOTE:** Only ANT C source and the input of an S-VIDEO signal will output S-VIDEO.

④ AUDIO TO HI-FI Output

These jacks provide variable audio output to a separate stereo amplifier. With this connection, the audio to the stereo can be controlled by the television's main volume.

⑤ CENTER IN (Input)

This jack is for stereo amplifiers with center signal capability. This feature allows the TV speakers to be used as a center speaker. The TV must be set as a center channel by selecting "TV as Center" on the Audio Advanced Settings Menu (see page 52).

⑥ S-VIDEO Inputs 3 and 4

Inputs 3 and 4 provide S-VIDEO (Super Video) jacks for connecting equipment with S-VIDEO output capability.



⑦ Component: Y-P_BP_R Inputs

Inputs 1 and 2 provide Y-P_BP_R jacks for connecting equipment with this capability, such as a DVD player or Set Top Box. You may use composite video signal for INPUT:2.

- NOTES:**
1. Do not connect composite VIDEO and S-VIDEO to Input 3, 4 or 5 at the same time. S-VIDEO has priority over VIDEO input.
 2. Your component outputs may be labeled Y, B-Y, and R-Y. In this case, connect the components B-Y output to the TV's P_B input and the components R-Y output to the TV's P_R input.
 3. Your component outputs may be labeled Y-C_BC_R. In this case, connect the component C_B output to the TV's P_B input and the component C_R output to the TV's P_R input.
 4. It may be necessary to adjust TINT to obtain optimum picture quality when using the Y-P_BP_R inputs. (See page 46)
 5. To ensure no copyright infringement, the MONITOR OUT output will be abnormal, when using the Y-P_BP_R jacks or ANT C.
 6. Input 2 (Y/VIDEO) can be used for composite video and component video input.

⑧ IR Blaster

This jack provides IR output to your external components (VCR, Cable box, DVD player, etc.). With this connection, your external components can automatically be controlled by the A/V net feature. This connection will allow you to control the external components with your television's remote control (see page 21).

⑨ DVI-HDTV Input (Input 1)

Use this DVI-HDTV Input for your external devices with DVI-HDTV output such as a Set-Top-Box, high-band DTV decoders, DVD players with Digital Content Protection.

- NOTES:**
1. Only DTV format such as 1080i, 720p, 480i and 480p are available for DVI-HDTV input.
 2. When connecting a Set-Top-Box with a copy-protect digital out terminal, a high definition picture can be displayed on the screen in its digital form.

⑩ Optical Out (Digital Audio)

This jack provides Digital Audio Output for your audio device that is Dolby® Digital and PCM compatible, such as an audio amplifier. Only ANT C has Optical Output.

⑪ IEEE1394

These jacks provide a digital interface for your external digital devices, such as a Digital VCR (D-VHS or Set-Top-Box) by means of a single cable (see page 68). When using IEEE1394 connections, you enable video and audio digital data exchange between a compatible device. This connection also enables you to control basic equipment functions (such as VCR play, rewind, fast forward, stop, etc.) from your TV On-Screen Display.

⑫ Multi Media Card Slot

This card slot is for future software upgrades. Hitachi will notify you if a software upgrade is required for your TV. In order to receive written notification, please complete and return your warranty card.

NOTE: *Manufactured under license from Dolby Laboratories. "Dolby" and the double-D symbol are trademarks of Dolby Laboratories.



REAR PANEL CONNECTIONS

TYPICAL FULL-FEATURE SETUP

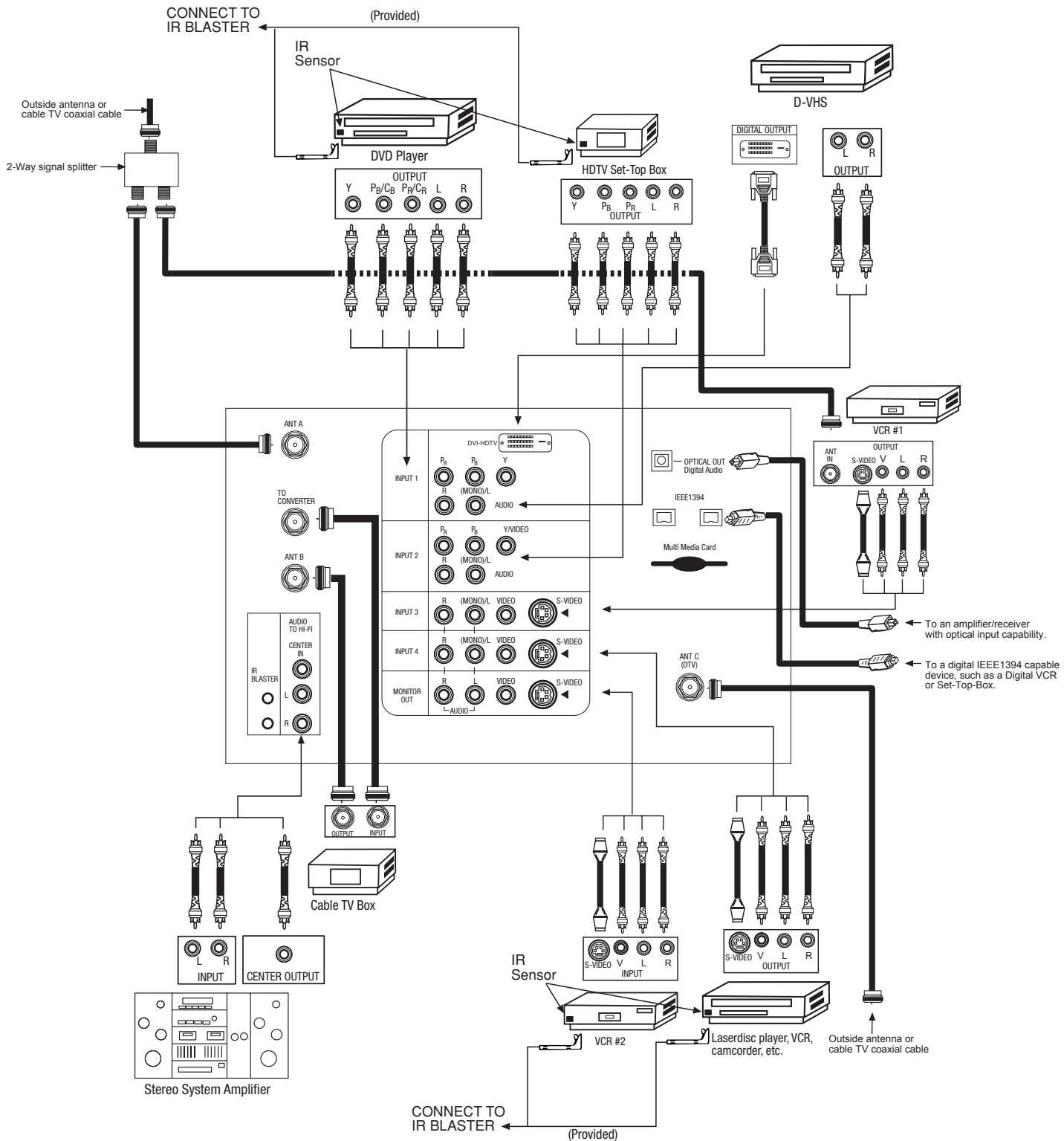

- NOTES:**
1. Connect only 1 component to each input jack.
 2. Follow connections that pertain to your personal entertainment system.
 3. Composite video signal can be input to Input2~Input5.
 4. Cables are not included with the purchase of this TV, except when noted as "provided".



TIPS ON REAR PANEL CONNECTIONS

S-VIDEO connections are provided for high performance laserdisc players, VCRs etc. that have this feature. Use these connections in place of the standard video connection if your device has this feature.

If your device has only one audio output (mono sound), connect it to the left audio jack on the television.

Refer to the operating guide of your other electronic equipment for additional information on connecting your hook-up cables.

A single VCR can be used for VCR #1 and VCR #2, but note that a VCR cannot record its own video or line output (INPUT: 3 in the example on page 11). Refer to your VCR operating guide for more information on line input-output connections.

You may use VIDEO or S-VIDEO inputs to connect to Input 3, Input 4 or Input 5, but only one of these may be used at a time.

Connect only 1 component (VCR, DVD player, camcorder, etc.) to each input jack.

COMPONENT: Y-P_BP_R (Input 1 & 2) connections are provided for high performance components, such as DVD players and set-top-boxes. Use these connections in place of the standard video connection if your device has this feature. Input 2 accepts both composite and component video signals.

Your component outputs may be labeled Y, B-Y, and R-Y. In this case, connect the components B-Y output to the TV's P_B input and the components R-Y output to the TV's P_R input.

Your component outputs may be labeled Y-C_BC_R. In this case, connect the components C_B output to the TV's P_B input and the components C_R output to the TV's P_R input.

You may use composite video signal for Input 2~Input 5.

It may be necessary to adjust TINT to obtain optimum picture quality when using the Y-P_BP_R inputs. (See page 46)

To ensure no copyright infringement, the MONITOR OUT output may be abnormal, when using the Y-P_BP_R jacks and ANT C.

When using IEEE1394 connections, you enable video and audio digital data exchange between a compatible device. This connection also enables you to control basic equipment functions (such as VCR play, rewind, fast forward, stop, etc.) from your TV On-Screen Display.

The TV's IEEE1394 rear panel jacks are not compatible with DV-CAM (Digital Video Camera) IEEE1394 connections.

Not all devices with IEEE1394 capability are compatible with this TV. Any compatibility problems with other manufacturers devices should be brought to the attention of those manufacturers.



CONNECTING EXTERNAL AUDIO SOURCES

To control the audio level of an external audio amplifier with the TV remote control, connect the system as shown below.

REAR PANEL OF TELEVISION

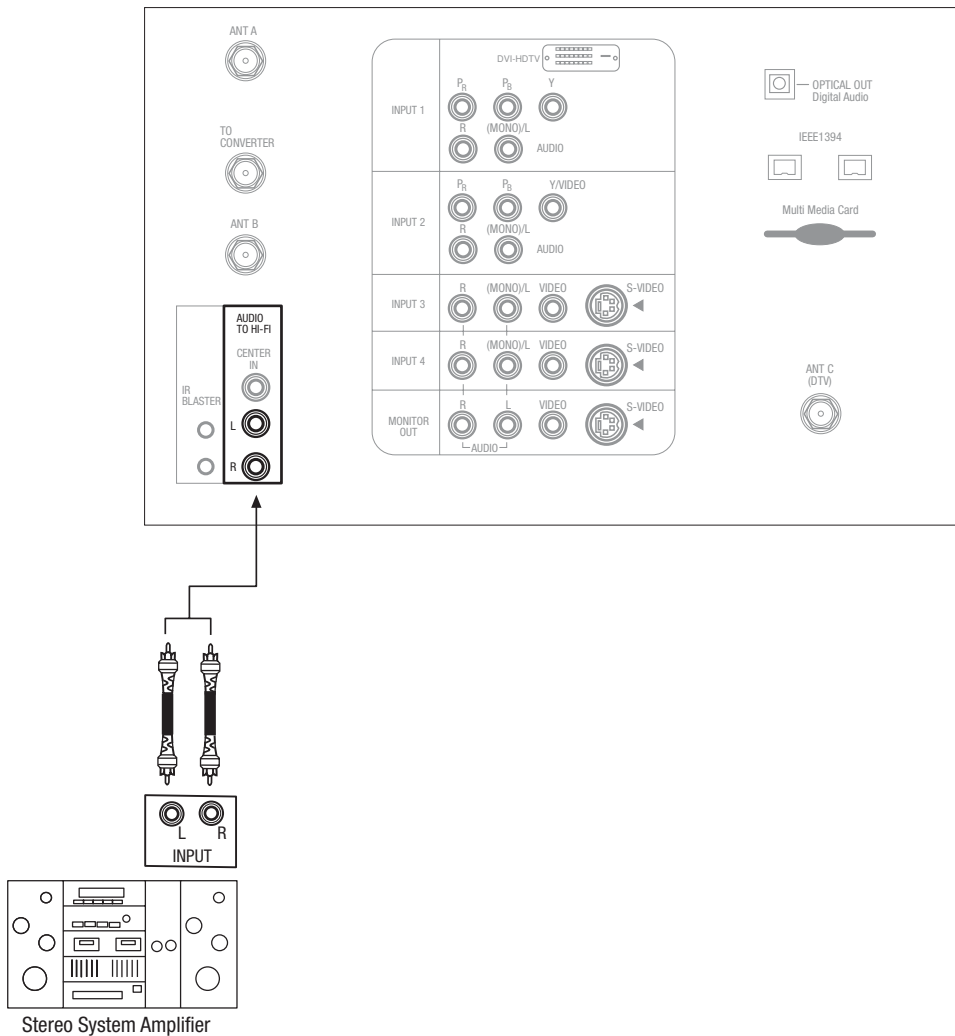

- NOTES:**
1. To prevent damage to the speaker and distorted sound, set the volume control of the audio amplifier lower and adjust the sound using the remote control of the TV set.
 2. Follow connections that pertain to your personal entertainment system.
 3. See page 52 for AUDIO Advanced Settings.



CONNECTING EXTERNAL AUDIO SOURCES

Match the numbers below to the diagram for speaker placement.

- ① The television's internal speakers will act as center speaker (select Audio-Advanced Settings-TV as Center).
- ② These FRONT left and right speakers are connected to the FRONT output of a separate audio amplifier.
- ③ These REAR left and right speakers are connected to the REAR output of a separate audio amplifier.
- ④ This subwoofer is connected to the LFE/Sub Out output of a separate audio amplifier.

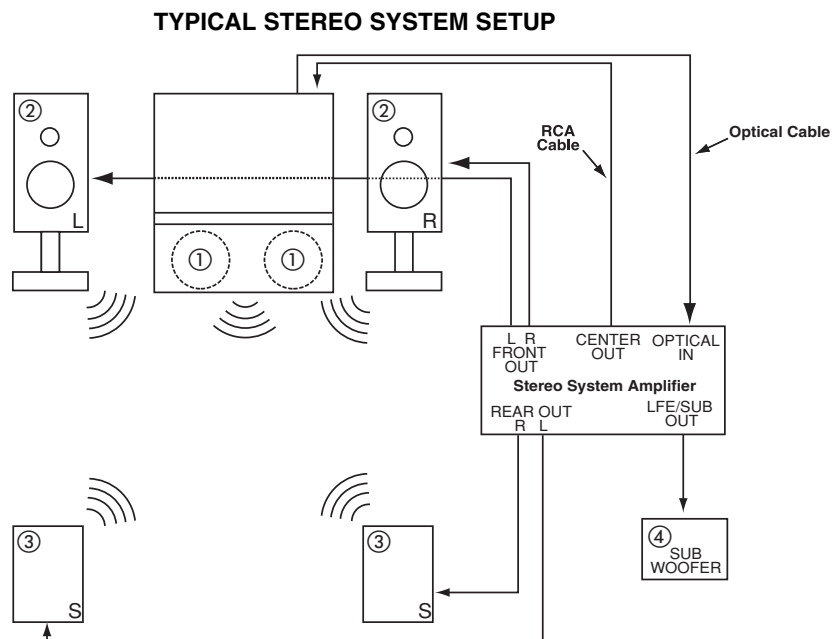
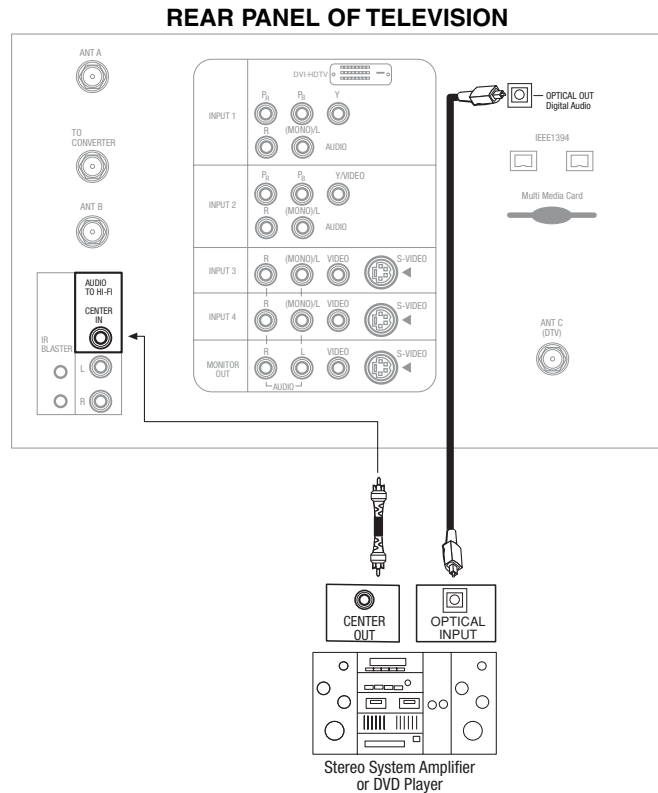

- NOTES:**
1. Only ANT C has optical audio output capability.
 2. The Optical Out (Digital Audio) provides a fixed digital audio output to your external component such as an A/V receiver with optical input capability. The audio level can only be controlled through the volume control of the external audio amplifier. The Optical Out will always output ANT C audio.
 3. See page 53 for AUDIO-Advanced Digital.



CONNECTING EXTERNAL VIDEO SOURCES

The exact arrangement you use to connect the VCR, camcorder, laserdisc player, DVD player, or HDTV Set Top Box to your TV set is dependent on the model and features of each component. Check the owner's manual of each component for the location of video and audio inputs and outputs.

The following connection diagrams are offered as suggestions. However, you may need to modify them to accommodate your particular assortment of components and features. For best performance, video and audio cables should be made from coaxial shielded wire.

Before Operating External Video Source

The input mode is changed every time the VID1~VID5 button is pressed as shown below. Connect an external source to the INPUT terminal, then press the VID1~VID5 button as necessary to view the input source. (See page 30)

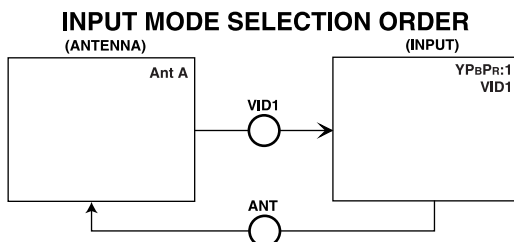

- NOTE:**
1. When the TV is set to VIDEO and a video signal is not received from the VIDEO INPUT JACK on the back panel of the TV (i.e., VCR/laserdisc player, etc. is not connected or the video device is OFF), the set will appear to be OFF.
 2. You may select other Input sources by A/V Net (see page 21) or by IEEE1394 (see page 20).

CONNECTING A MONAURAL AUDIO SOURCE TO INPUT2~INPUT5

1. Connect the cable from the VIDEO OUT of the VCR or the laserdisc player to the INPUT (VIDEO) jack, as shown on the TV set below.
2. Connect the cable from the AUDIO OUT of the VCR or the laserdisc player to the INPUT (MONO)/L(AUDIO) jack.
3. Press the VID2~VID5 button to view the program from the VCR or the laserdisc player. The VIDEO OSD label disappears automatically after approximately four seconds.
4. Press the ANT button to return to the previous channel.

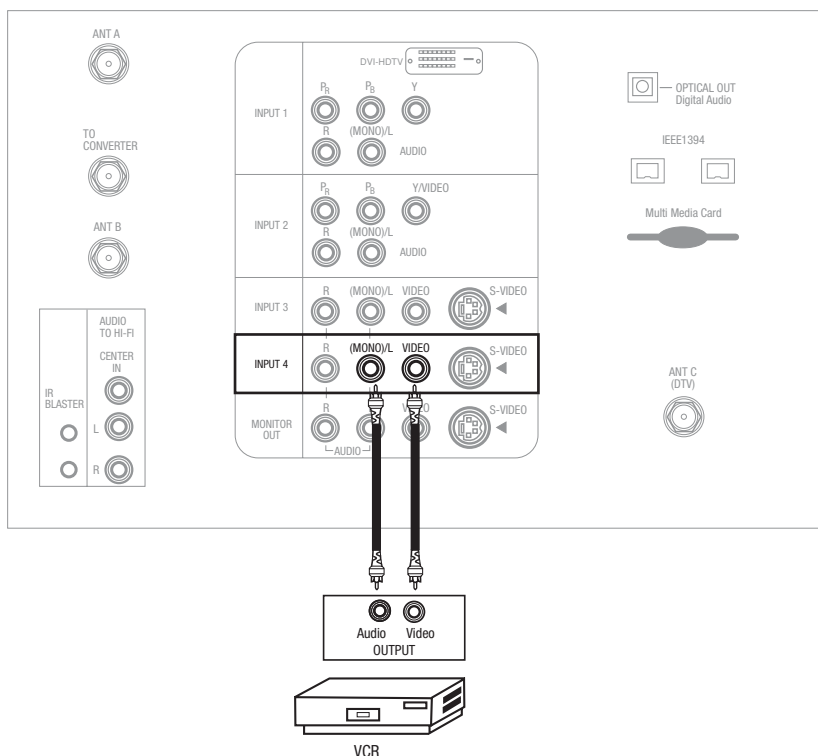



CONNECTING EXTERNAL VIDEO SOURCES

CONNECTING A STEREO SOURCE TO INPUT2~INPUT5

1. Connect the cable from the VIDEO OUT of the VCR or the laserdisc player to the INPUT (VIDEO) jack, as shown on the TV set below.
2. Connect the cable from the AUDIO OUT R of the VCR or the laserdisc player to the INPUT (AUDIO/R) jack.
3. Connect the cable from the AUDIO OUT L of the VCR or the laserdisc player to the INPUT (AUDIO/L) jack.
4. Press the VID2~VID5 button to view the program from the VCR or laserdisc player. The VIDEO OSD label disappears automatically after approximately four seconds.
5. Press the ANT button to return to the previous channel.

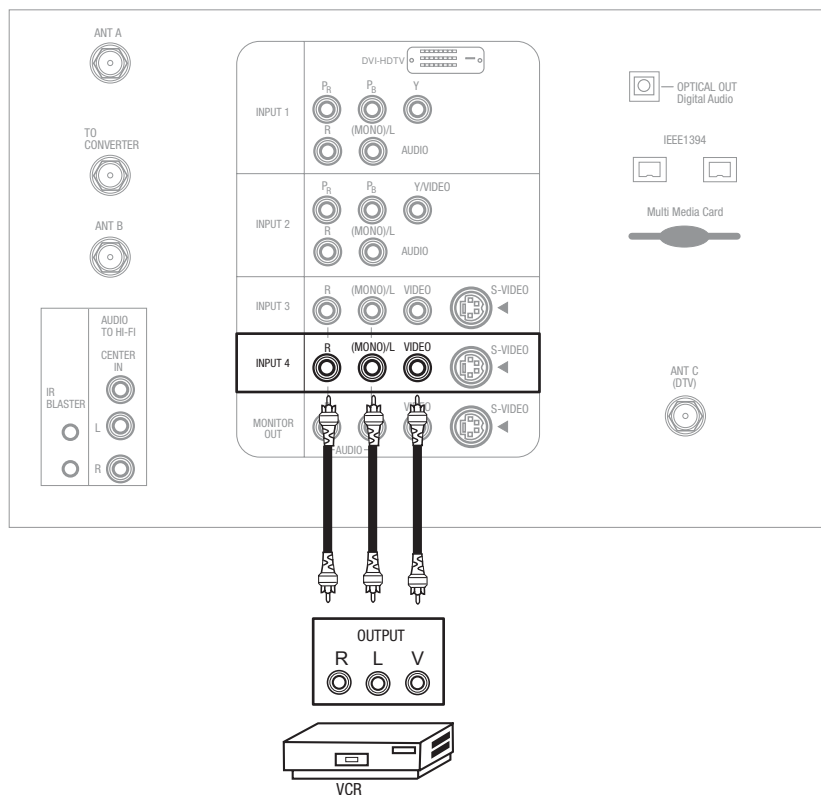

- NOTES:**
1. Completely insert the connection cord plugs when connecting to rear panel jacks. The picture and sound that is played back will be abnormal if the connection is loose.
 2. A single VCR can be used for VCR #1 and VCR #2 (see page 11), but note that a VCR cannot record its own video or line output. Refer to your VCR operating guide for more information on line input-output connections.



CONNECTING EXTERNAL VIDEO SOURCES

CONNECTING AN S-VIDEO SOURCE TO INPUT 3, 4 AND 5

1. Connect the cable from the S-VIDEO OUT of the VCR or the laserdisc player to the INPUT (S-VIDEO) jack, as shown on the TV set below.
2. Connect the cable from the AUDIO OUT R of the VCR or the laserdisc player to the INPUT (AUDIO/R) jack.
3. Connect the cable from the AUDIO OUT L of the VCR or the laserdisc player to the INPUT (AUDIO/L) jack.
4. Press the VID3~VID5 button to view the program from the VCR or laserdisc player. The VIDEO OSD label disappears automatically after approximately four seconds.
5. Press the ANT button to return to the previous channel.

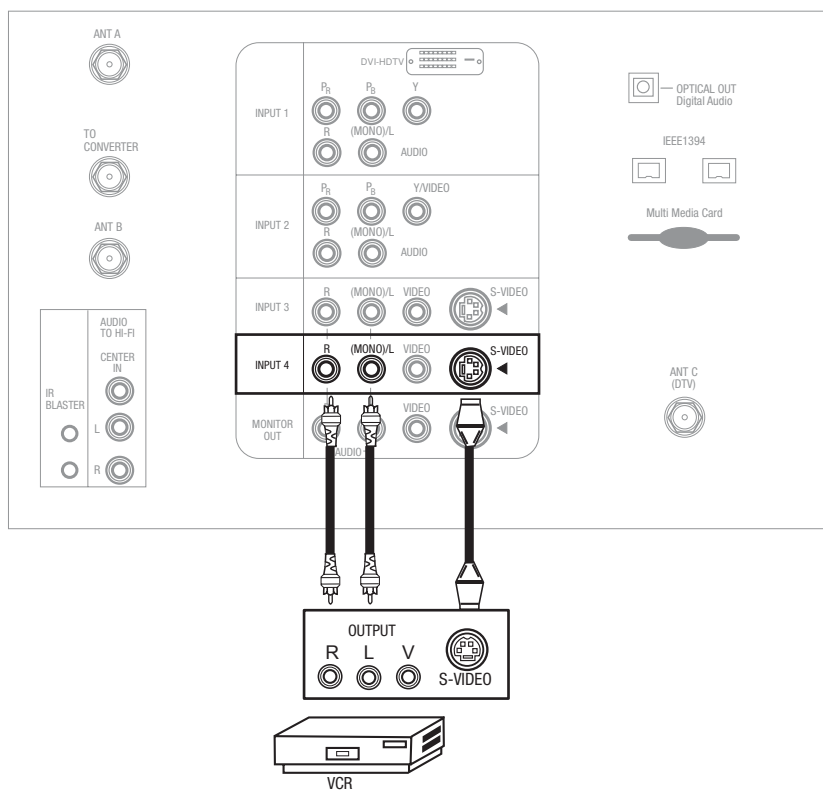

- NOTES:**
1. Completely insert the connection cord plugs when connecting to rear panel jacks. The picture and sound that is played back will be abnormal if the connection is loose.
 2. A single VCR can be used for VCR #1 and VCR #2 (see page 11), but note that a VCR cannot record its own video or line output. Refer to your VCR operating guide for more information on line input-output connections.



CONNECTING EXTERNAL VIDEO SOURCES

CONNECTING A COMPONENT SOURCE WITH DVI-HDTV CAPABILITY TO INPUT 1

1. Connect the DVI connection cable from the output of the HDTV set top box or DVD player to the DVI-HDTV input as shown on the TV set below.
2. Connect the cable from the AUDIO OUT R of the HDTV set top box or DVD player to the INPUT (AUDIO/R) jack.
3. Connect the cable from the AUDIO OUT L of the HDTV set top box or DVD player to the INPUT (AUDIO/L) jack.
4. Press the VID1 button to view the program from the HDTV set top box or DVD player. The VIDEO OSD label disappears automatically after approximately four seconds.
5. Press the ANT button to return to the previous channel.

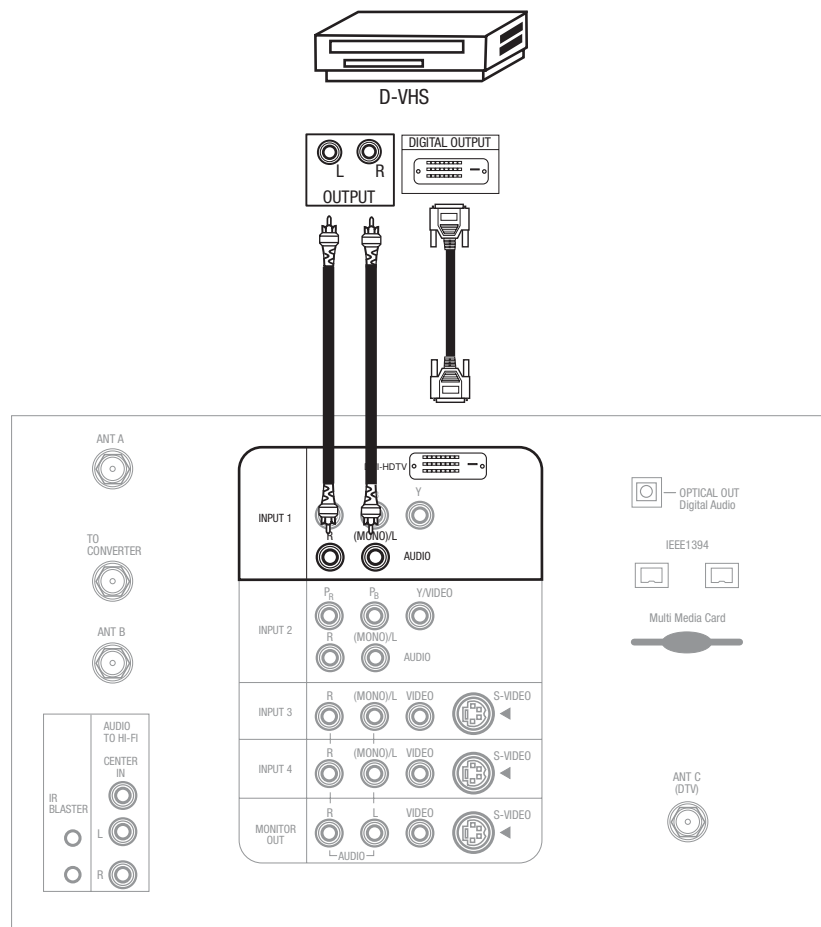

- NOTES:**
1. Completely insert the connection cord plugs when connecting to rear panel jacks. The picture and sound that is played back will be abnormal if the connection is loose.
 2. The DVI-HDTV input on INPUT 1 contains the copy protection system called High-bandwidth Digital Content Protection (HDCP). HDCP is a cryptographic system that encrypts video signals when using DVI connections to prevent illegal copying of video contents.
 3. DVI is not a "NETWORK" technology. It establishes a one-way point-to-point connection for delivery of uncompressed video to a display.
 4. The connected digital output device controls the DVI interface so proper set-up of device user settings determines final video appearance.



CONNECTING EXTERNAL VIDEO SOURCES

CONNECTING A COMPONENT SOURCE TO INPUT 1 OR 2: Y-P_BP_R.

1. Connect the cable from the Y OUT of the Laserdisc/DVD player or HDTV set top box to the INPUT (Y) jack, as shown on the TV set below.
2. Connect the cable from the C_B/P_B OUT or B-Y OUT of the Laserdisc/DVD player or HDTV set top box to the INPUT (P_B) jack.
3. Connect the cable from the C_R/P_R OUT or R-Y OUT of the Laserdisc/DVD player or HDTV set top box to the INPUT (P_R) jack.
4. Connect the cable from the AUDIO OUT R of the Laserdisc/DVD player or HDTV set top box to the INPUT (AUDIO/R) jack.
5. Connect the cable from the AUDIO OUT L of the Laserdisc/DVD player or HDTV set top box to the INPUT (AUDIO/L) jack.
6. Press the VID1 or VID2 button, to view the program from the Laserdisc/DVD player or HDTV set top box. The VIDEO OSD label disappears automatically after approximately four seconds.
7. Press the ANT button to return to the previous channel.

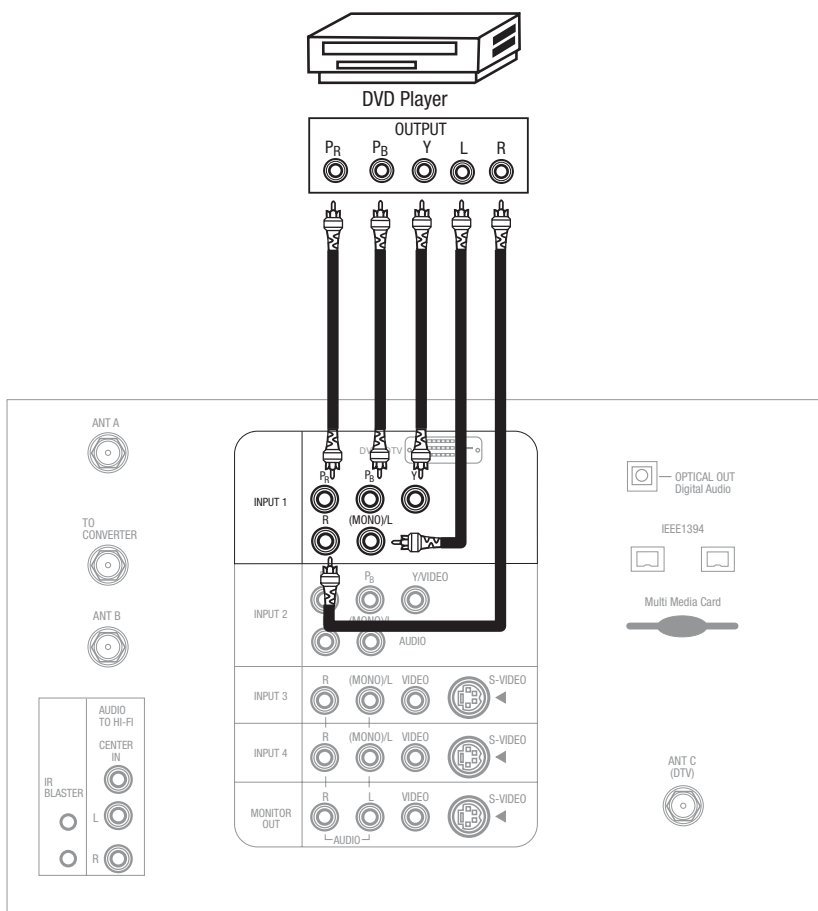

- NOTES:**
1. Completely insert the connection cord plugs when connecting to rear panel jacks. The picture and sound that is played back will be abnormal if the connection is loose.
 2. See page 12 for tips on REAR PANEL CONNECTIONS.



CONNECTING EXTERNAL VIDEO SOURCES

CONNECTING A COMPONENT SOURCE WITH DIGITAL INTERFACE CAPABILITY TO IEEE1394 TERMINALS

1. Connect the IEEE1394 cable from the output of the component with IEEE1394 capability, such as a Set-Top-Box or Digital VCR, to the IEEE1394 input terminals shown on the TV set below. IEEE 1394 allows the television and the external device to communicate with one another. When using IEEE1394 connections, you enable video and audio digital data exchange between a compatible device. This connection also enables you to control basic equipment functions (such as VCR play, rewind, fast forward, stop, etc.) from your TV On-Screen Display. You must be tuned to ANT C to use this function (see pages 64-65).
2. Press the MENU button on the Remote Control and select SETUP.
3. Select Set-up - Set The Inputs - IEEE1394 (or press the A/V Net button twice (2x) when in ANT C mode).
4. Select IEEE1394 to verify that the component is properly connected (see page 68).

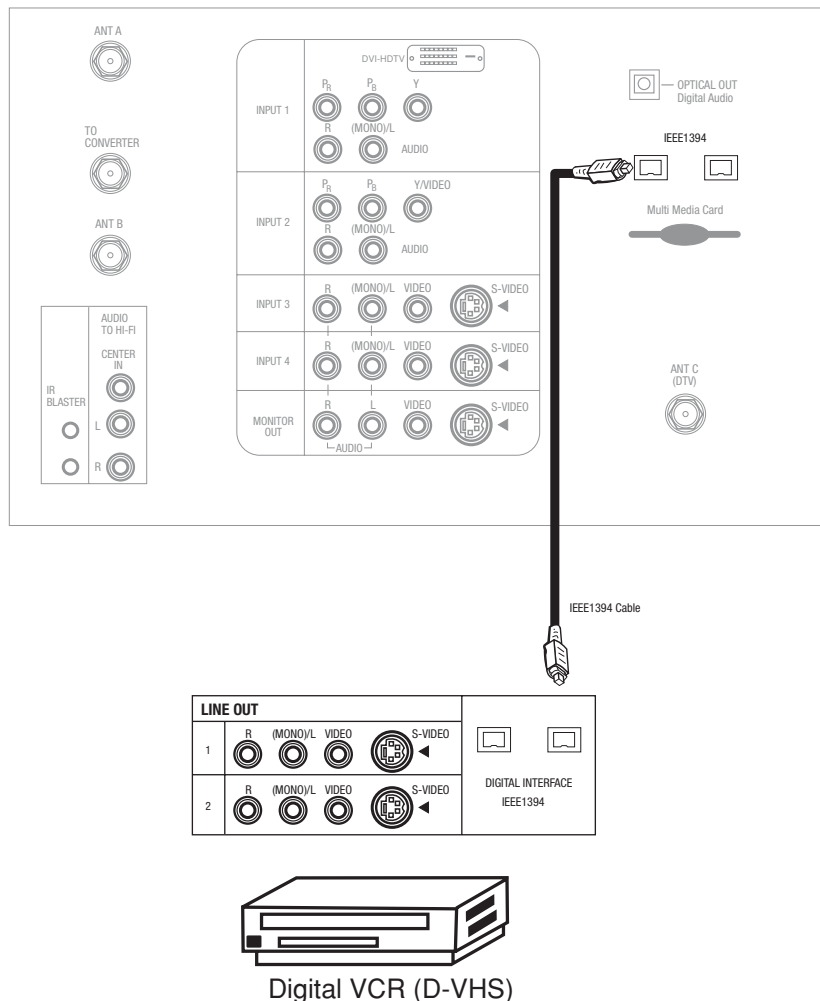

- NOTES:**
1. To quickly enter IEEE1394 menu, press the A/V NET button on the remote control twice when in ANT C mode.
 2. The external device that is connected to the IEEE 1394 terminals will not need the A/V Network feature (see page 21).
 3. This TV's IEEE1394 connection is not compatible with a DV camcorder (Digital Video camcorder) and a PC.
 4. With IEEE1394 connection, video and audio will be received by the TV. It will enable you to control the D-VHS from the TV IEEE1394 menu (see page 68).
 5. The IEEE1394 interface contains the copy protection standard called 5C or Digital Transmission Content Protection (DTCP).
 6. This TV does not support full network control of several IEEE1394 devices simultaneously (the IEEE1394 will disconnect from 1st device when making connection to 2nd device).
 7. See page 12 for tips on Rear Panel Connections.



CONNECTING A/V NETWORK

Your Hitachi Television is equipped with an A/V Network feature. This feature helps to control your external Audio/Video equipment (VCR, Set Top Box, DVD, etc.). Once this is setup, it allows your IR Mouse connector to control your equipment using your Hitachi TV Remote Control. You can use your Hitachi remote control to control the Audio/Video equipment command without the equipment's remote control.

The television rear panel has 2 IR BLASTER jacks. Each IR Mouse cable can connect up to 2 external Audio/Video components. Therefore, you can connect the Television with up to four components and control them with the TV remote control. Please see the following example of an A/V Network setup between your Hitachi Television and external Audio/Video equipment (VCR and DVD Player).

CONNECTING EXTERNAL AUDIO/VIDEO COMPONENTS TO IR BLASTER FOR A/V NETWORK

1. Connect your external Audio/Video components to the Rear Panel jacks as shown on pages 13~19.
2. Connect the IR Mouse cable to the IR BLASTER input of the Television's rear panel.
3. Place the IR mouse in front of the infrared sensor of the external components you wish to control.

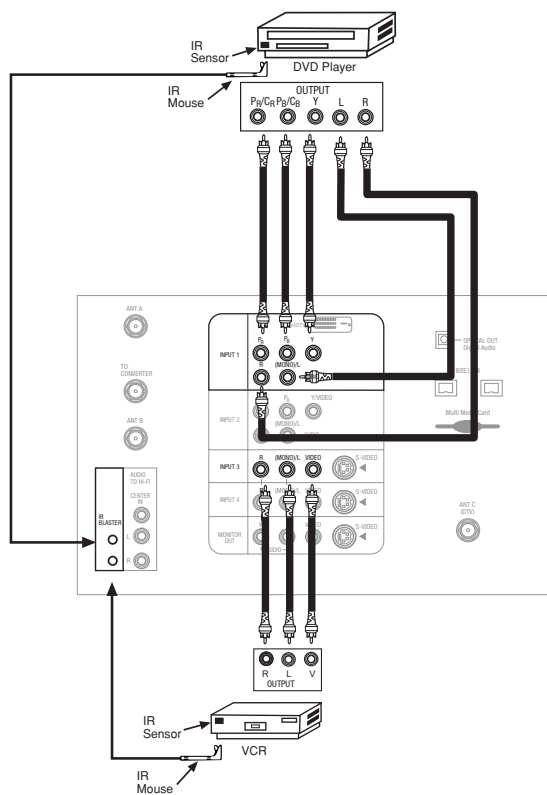

NOTES:

1. The Rear Panel has two IR BLASTER inputs which can control up to a total of four external components.
2. The IR Mouse must be placed in front of the external components IR sensor for the A/V Network to work.
3. The correct codes must be entered for each of the Audio/Video components for the A/V Network to function properly (see page 23).

4. Press the A/V NET button on the remote control. Use THUMB STICK ▲ or ▼ to highlight the component you wish to set up. Use THUMB STICK ► to enter component's "SOFT KEY" control button. The A/V Network Setup Wizard will automatically start upon the very first use. You can access the Setup Menu Wizard again in the future by pressing the A/V net button and selecting SETUP.

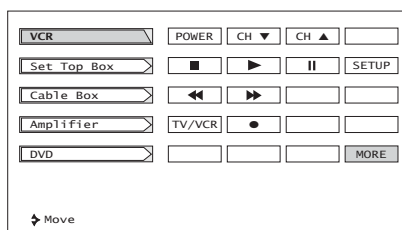



A/V NETWORK SETUP WIZARD

5. Follow the steps below to setup your A/V network (See page 23 for A/V Network Codes).

There are six steps in the setup procedure (VCR setup example below).

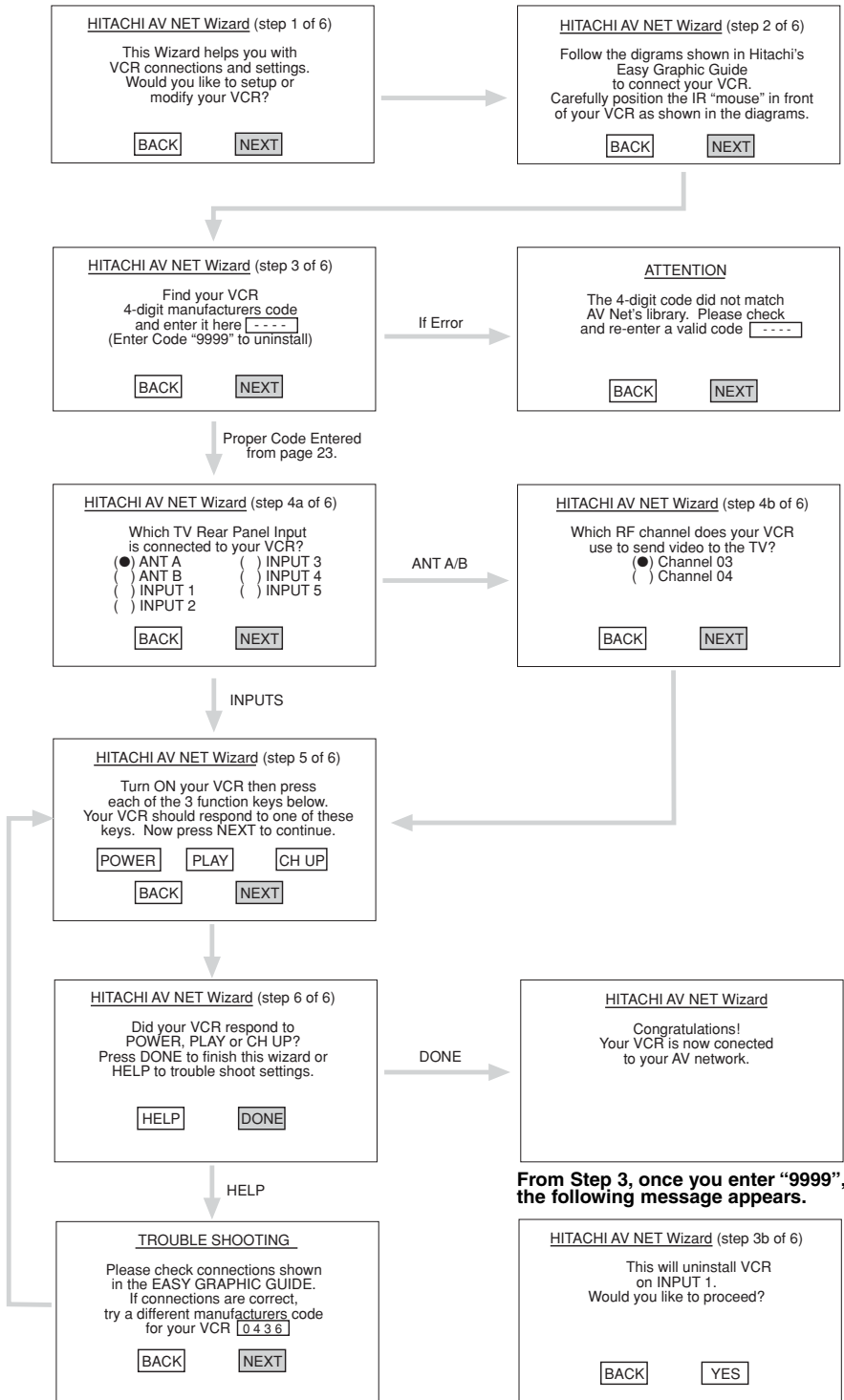

From Step 3, once you enter "9999", the following message appears.

6. Enter "9999" to uninstall the equipment from your A/V Network.
7. See Remote Control A/V NET button usage on page 27.

NOTES:

1. If your equipment cannot be operated after performing the above procedures, your equipment code has not been pre-coded into the A/V Net.
2. In the unlikely event that your equipment receiver cannot be operated after performing the above procedures, please consult your equipment receiver operating guide.



THE REMOTE CONTROL

In addition to controlling all the functions on your HITACHI Projection TV, the new remote control is designed to operate different types of VCRs, CATV (Cable TV) converters, set-top-box, satellite receiver, DVD players, and other audio equipment with one touch. Basic operation keys are grouped together in one area. If you prefer to use the A/V Network feature, switching remote control modes is not needed.

To operate your TV, point the remote control at the screen of the TV and press the TV button. The TV button will blink, indicating that the remote will now control your television.

To operate your VCR, point the remote at the remote sensor of the VCR and press the VCR button. The VCR button will blink, indicating that the remote will now control your VCR. (See page 36 for instructions on how to program the remote to control your VCR.)

To operate your cable box, point the remote at the remote sensor of the cable box and press the CABLE (CBL) button. The CBL button will blink, indicating that the remote will now control your cable box. (See page 37 for instructions on how to program the remote to control your cable box.)

To operate your set-top-box or satellite receiver point the remote at the remote sensor of the set-top-box and press the SET-TOP-BOX (STB) button. The STB button will blink, indicating that the remote will now control your set-top-box. If you have a satellite receiver, use this button to program your satellite receiver. (See page 38 for instructions on how to program the remote to control your set-top-box.)

To operate your DVD player, point the remote at the remote sensor of the DVD player and press the DVD button. The DVD button will blink, indicating that the remote will now control your DVD player. (See page 39 for instruction on how to program the remote to control your DVD player.)

To operate additional audio equipment, point the remote at the remote sensor of the component you wish to control and press the CD, TAPE or AMP button. This button will blink, indicating that the remote will now control the desired component. (See page 40 for instructions on how to program the remote to control additional Audio equipment.)

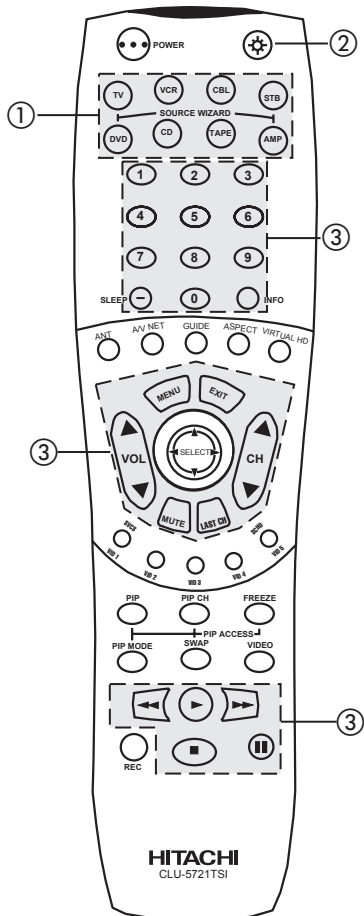

① These buttons allow the remote to control your TV, VCR, cable box, satellite receiver, DVD player, or other Audio equipment depending on which mode is chosen, as explained above.

②,③ LIGHT BUTTON

When you are in a dark room, press the light button ② on the remote to light up the buttons shown in ③ and the source button will blink. The light will stay on for about 8 seconds if any of the buttons are not pressed again. These buttons will not appear to light if the room is too bright.

HOW TO USE THE REMOTE TO CONTROL YOUR TV

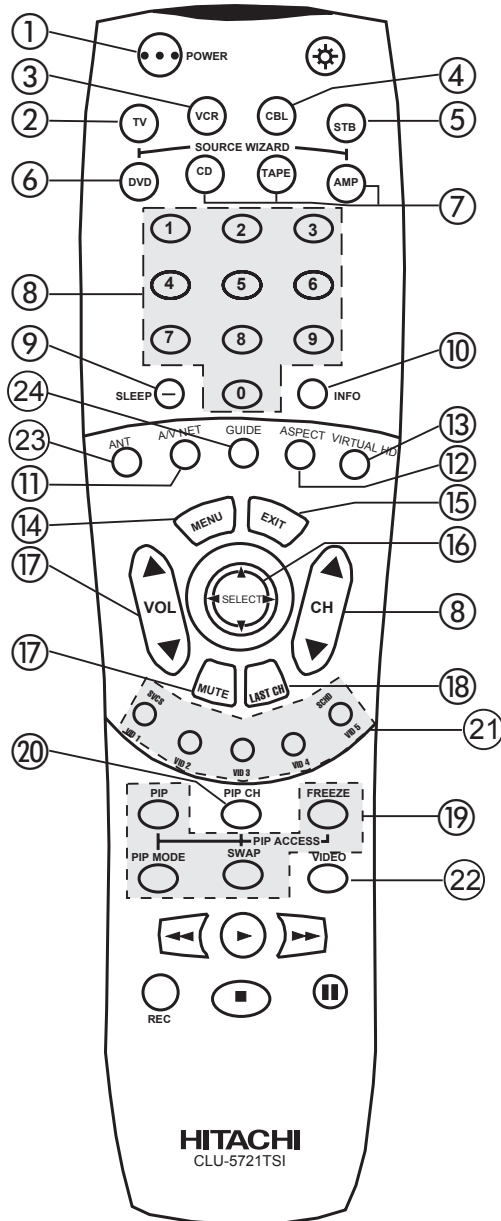

- ① **POWER button**
Press this button to turn the TV set on or off when the remote is in TV mode. (See page 24 for instructions on how to set the remote control to TV mode.)
- ② **TV button**
When the TV button is pressed, it will blink, to indicate the remote is in TV mode.
- ③ **VCR button**
When the VCR button is pressed, it will blink to indicate the remote is in VCR mode. (see page 36)
- ④ **CABLE (CBL)**
When the CABLE button is pressed, it will blink to indicate the remote is in CABLE mode. (see page 37)
- ⑤ **SET-TOP-BOX (STB)**
When the STB button is pressed, it will blink to indicate the remote is in STB mode. (see page 38)
If you have a Satellite receiver, use this button to program your Satellite receiver. (see page 38)
- ⑥ **DVD button**
When the DVD button is pressed, it will blink to indicate the remote is in DVD mode. (see page 39)



HOW TO USE THE REMOTE TO CONTROL YOUR TV

7 CD, TAPE, AMP buttons

When pressed, each of these buttons will blink to indicate the remote is in Audio mode. (see page 40)

8 CHANNEL selector buttons

CHANNEL selector buttons are used to select channels, lock access code, etc. Enter one, two, or three numbers to select channels. Enter "0" first for channels 1 to 9, or simply press the single digit channel you wish to tune then wait a few seconds for the TV to tune. For channels 100 and above, press the "1" button, wait until two dashes appear next to the channel display on your TV, then enter the remaining two numbers using the number buttons. Channel selection may also be performed by pressing CH up (▲) or down (▼).

When in ANT C, digital channels are indicated by the use of a (-) DASH in the subchannel number (for example "15-1"). Press buttons [0], [1], [5], [1] to tune to subchannel 15-1 or buttons [0], [1], [5], [0], [0], [1].

NOTE: The TV may not receive some channels if you are not in the correct ANTENNA/CABLE mode. (see page 63)

9 SLEEP and (-) DASH button

Press this button to display the sleep timer in the lower left corner of the screen. Every subsequent press of this button will add 15 minutes to this timer, up to a maximum of three hours. Once set, use INFO when you want to view time remaining. If the SLEEP button is pressed while the timer is set, it will reset to the original condition.

When in ANT C, Digital channels are indicated by the use of a (-) DASH in the subchannel number (for example "15-1"). Press buttons [1], [5], [-], [1] to tune to subchannel 15-1.

10 INFO button

Press this button when you want to check the channel being received, the picture source, if the channel has stereo (ST) or second audio program (SAP), the time, CHANNEL ID and if the TIMER is set.

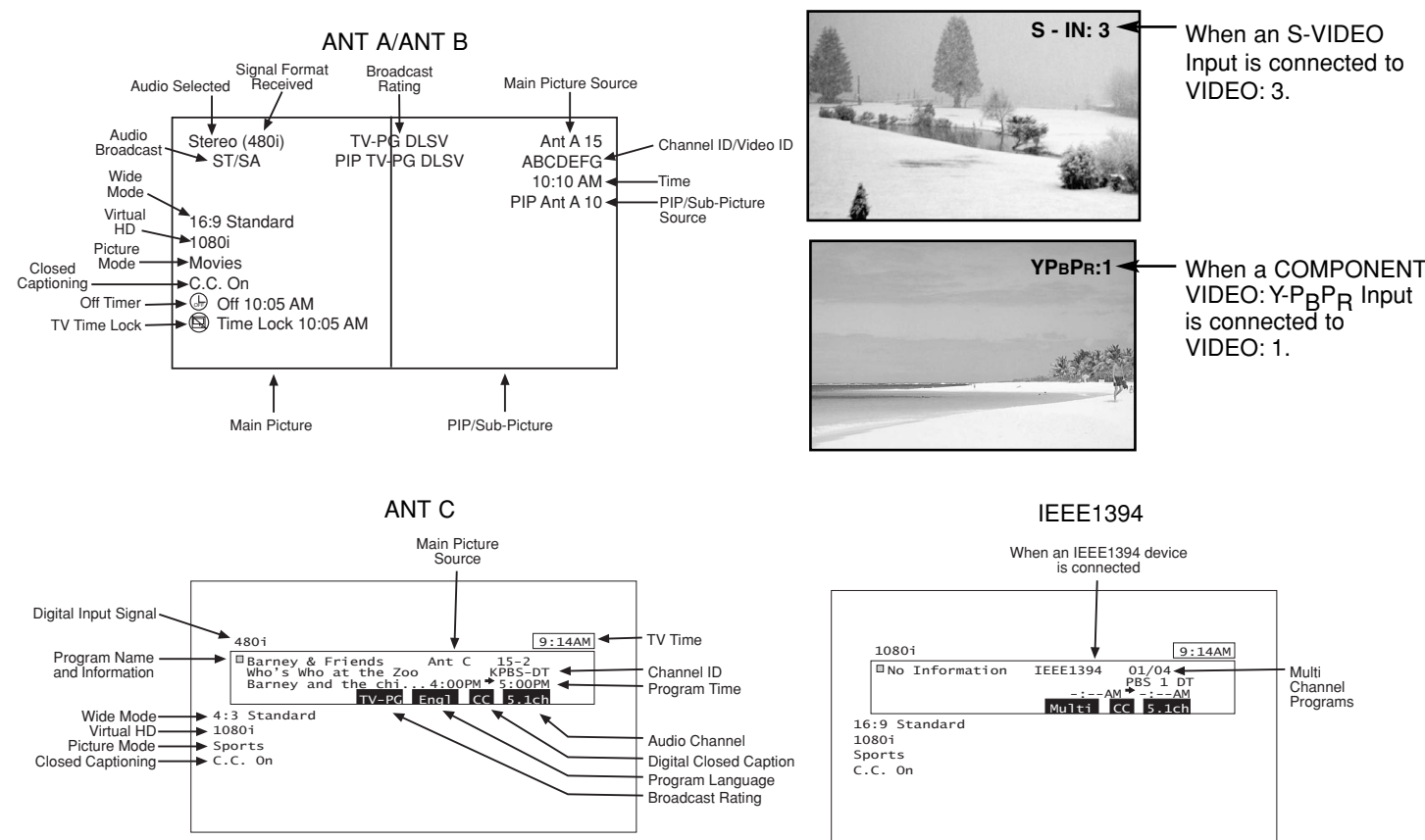

NOTE: When an IEEE1394 device is connected, press CH ▲, CH ▼ buttons to change Multi Channel programs.

HOW TO USE THE REMOTE TO CONTROL YOUR TV



11 AV/NET button

Press this button once to access the Audio/Video Network (A/V Net) menu. The A/V Net allows the user to control external components with the TV's remote control.

When in ANT C, press this button twice to quickly access the IEEE1394 menu (see page 68).

When you press the A/V NET button, the following window will pop up within the Display screen. The window will disappear after eight seconds if you don't press any buttons or if you press the A/V NET button again.

The A/V Net Setup Wizard will automatically start upon the very first use. (see page 21-23).

THUMBSTICK ▲ or ▼ to highlight the equipment you wish to control or setup.

Use THUMBSTICK ▲, ▼, ◀, ▶ to navigate and SELECT to select button. The command selected is passed through the IR mouse and to the AUDIO/VIDEO equipment. These on-screen buttons are called "Soft Keys".

This window shows the available Audio/Video equipment soft keys. The equipment list will scroll up or down but the selected equipment will always stay on top.

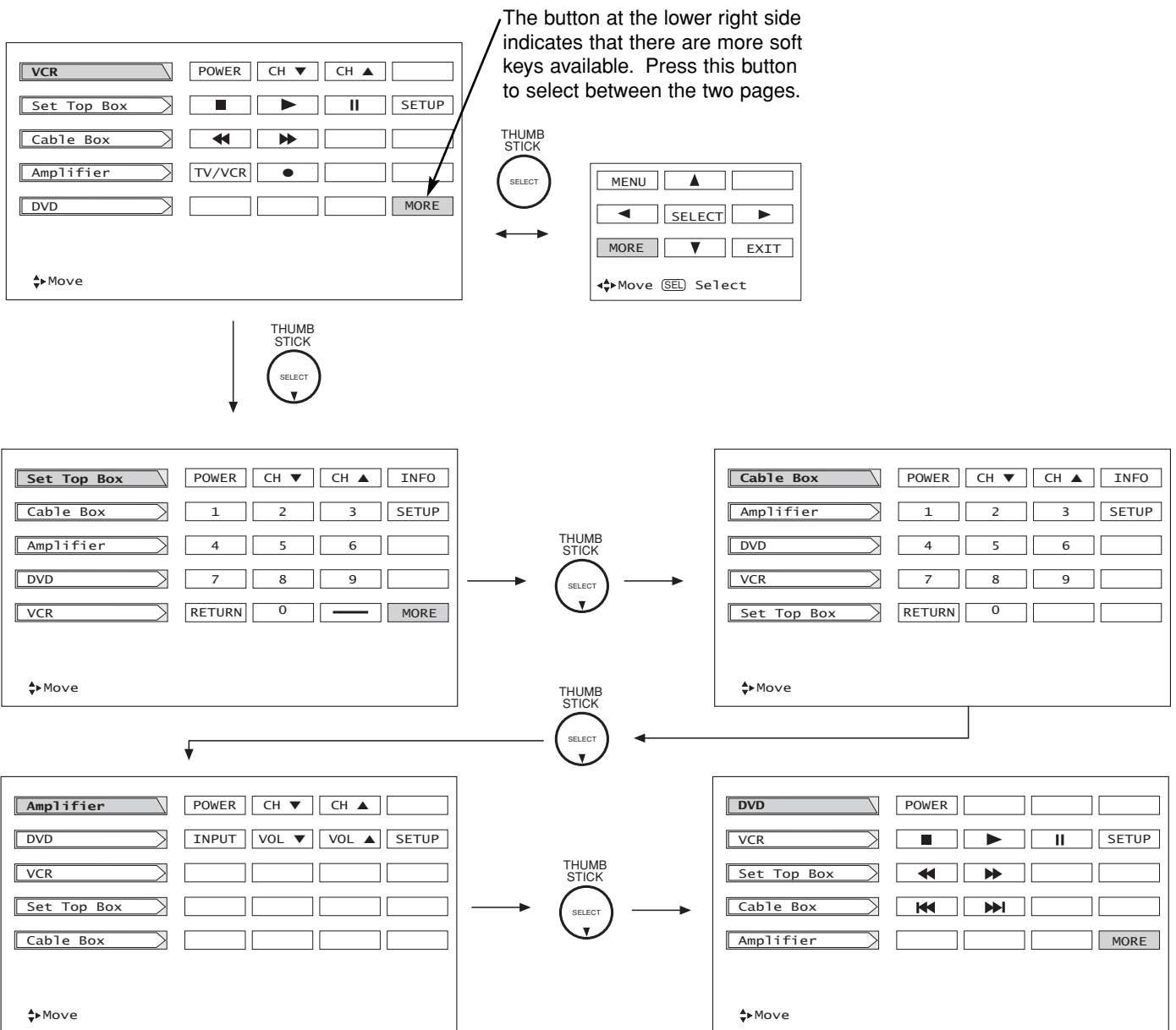

NOTE: There are some devices that don't have a function matching the softkey A/V NET display.



HOW TO USE THE REMOTE TO CONTROL YOUR TV

12 ASPECT button

Press this button to quickly change the picture format ASPECT ratio.

Depending on the input signal format received, the picture format ratio allows you to adjust the images through the following options.

- 4:3 STANDARD Use this aspect mode to display conventional (4:3) images. Side panels (gray areas) are placed to the left and right of the image to preserve the original aspect ratio of the source. Note: Use this mode for only 15% of your total viewing time to prevent uneven aging of the phosphors. Phosphors in the lighted area of the picture will age more rapidly than the gray areas.
- 4:3 EXPANDED Use this aspect mode to display conventional (4:3) sources by expanding the outer edges of the image to fill the 16:9 screen. The center of the image remains unaltered.
- 4:3 Zoom1/Zoom2 Use these aspect modes to zoom in on conventional (4:3) sources.
- 16:9 STANDARD Use this aspect mode to display 16:9 sources like HDTV and DVD's preserving the original 16:9 aspect ratio.
- 16:9 Zoom Use this aspect to Zoom-in once while in 16:9 aspect.

(1) NTSC Signal Format received

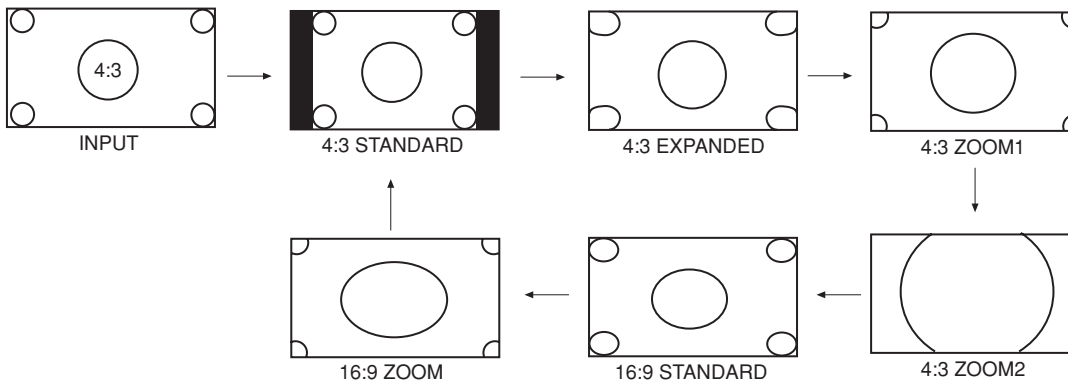

(2) 480i/480P Signal Format received

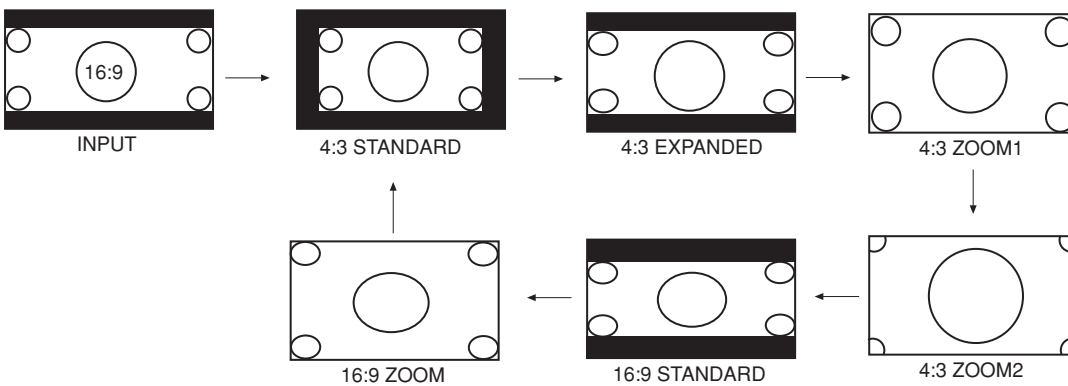

(3) 720P/1080i Signal Format received

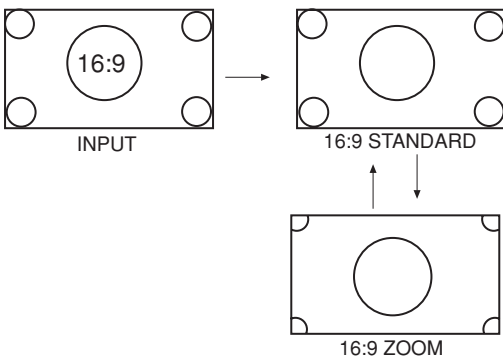

NOTE: When in ANT C, signal format is dependent on broadcaster.

HOW TO USE THE REMOTE TO CONTROL YOUR TV



- ⑬ **VIRTUAL HD button**
Press this button to toggle between 1080i and 540p (This feature is not available while in ANT C mode).
- ⑭ **MENU button**
The MENU button will start the On-Screen Display.
- ⑮ **EXIT button**
When in MENU mode, this button will exit all On-Screen Displays.
- ⑯ **THUMB STICK/SELECT button**
All the On-Screen Display features can be set or adjusted by using the THUMB STICK, except for numeric entries. The THUMB STICK will highlight functions or adjust and set different features. Press the THUMB STICK toward desired direction and press down to SELECT.

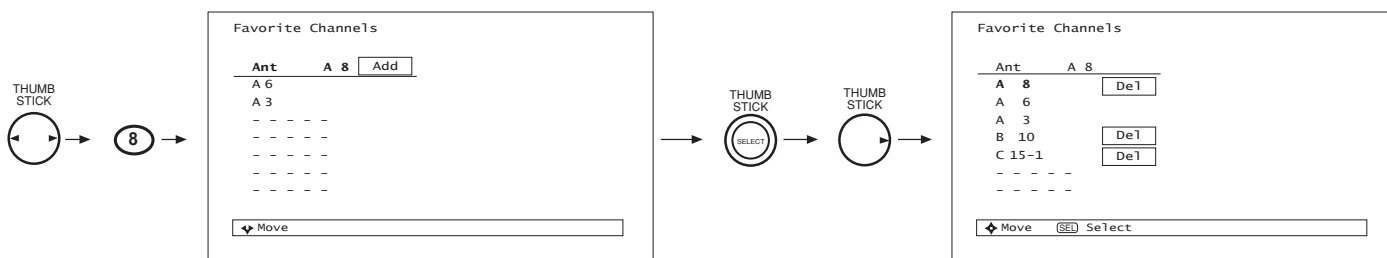

When no on-screen displays are on the TV screen, use THUMB STICK ◀ or ▶ to access the Favorite Channels feature.

To add channels to Favorite Channels, use the number keys to enter the channel number. Use THUMB STICK ▶ to highlight “Add”, then press SELECT to store the channel to the Favorite Channel feature.

To delete (Del) the channel from the Favorite Channel, use THUMB STICK ▲ , ▼ to highlight the channel, then THUMB STICK ▶ to highlight Delete (Del) and press SELECT to delete.

To view a Favorite Channel use THUMB STICK ▲ , ▼ to highlight the channel and press SELECT to view.

- ⑰ **VOLUME, MUTE button**
Press the VOLUME up (▲) or down (▼) button until you obtain the desired sound level.

To reduce the sound to one half of normal volume (SOFT MUTE) to answer the telephone, etc., press the MUTE button. Press the MUTE button again to turn the sound off completely (MUTE). To restore the sound, press the MUTE button one more time, or press the VOLUME UP (▲) button.



Closed Captioning will display automatically when MUTE/SOFT MUTE is on and Closed Caption is set to AUTO (See page 70).

When the TV power is turned off at a volume level 31 or greater, the volume level will default to 30 when the TV is turned on. However, if it is set to a level 30 or less, the volume level will be at the level it was set when the TV is turned ON.

- ⑱ **LAST CHANNEL (LAST CH) button**
Use this button to select between the last two channels viewed (Good for watching two sporting events, etc.).

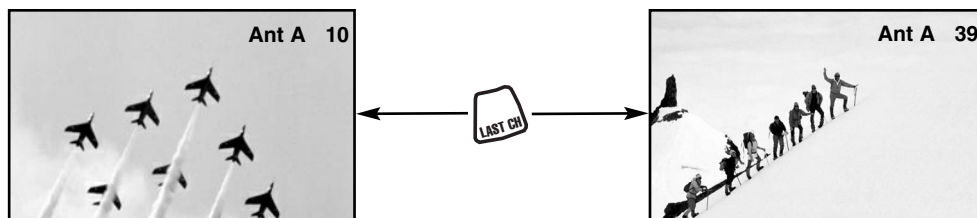



HOW TO USE THE REMOTE TO CONTROL YOUR TV

19 **PICTURE-IN-PICTURE buttons**
See separate section on pages 33-35 for a description.

20 **PIP CH button**
Use the PIP CH button to select between main picture and sub-picture tuning. The channel number which is highlighted indicates what channel is being controlled.

21 **VID1 ~ VID5**
When the remote control is in TV mode, press these buttons to directly select the video input sources between the five video inputs. When the remote control is in Set-Top-Box mode (STB) these buttons will control the Set-Top-Box or satellite receiver, and execute the secondary functions labeled as SVCS and SCHED.

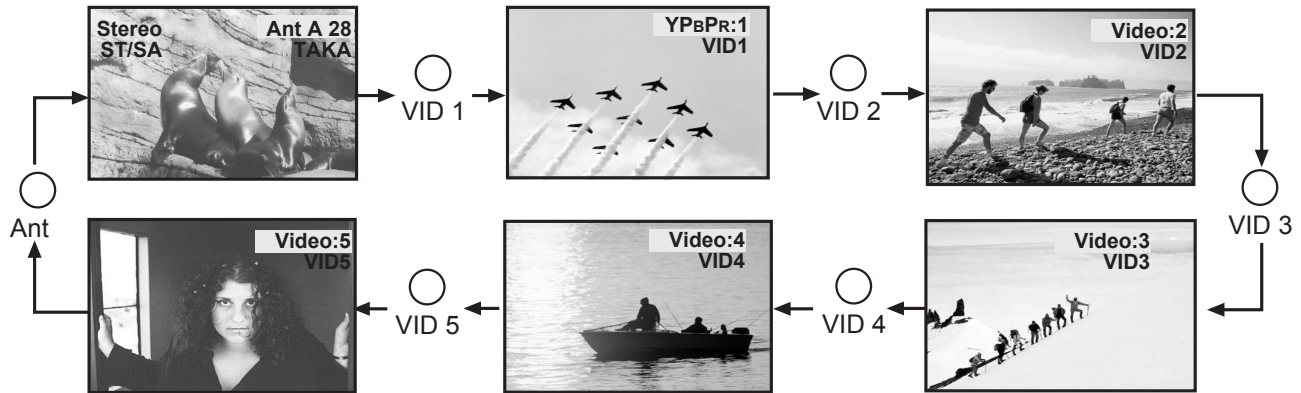

22 **VIDEO button**
Press this button to directly access the VIDEO adjustment menu.

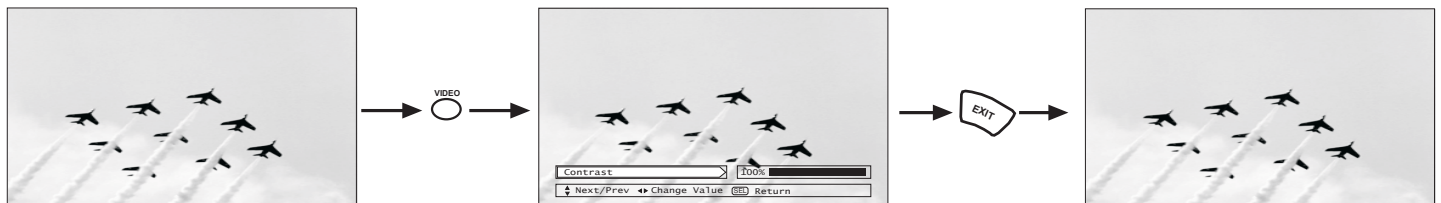

23 **ANTENNA button**
The ANT button will select between Antenna A, Antenna B and Antenna C each time the button is pressed.

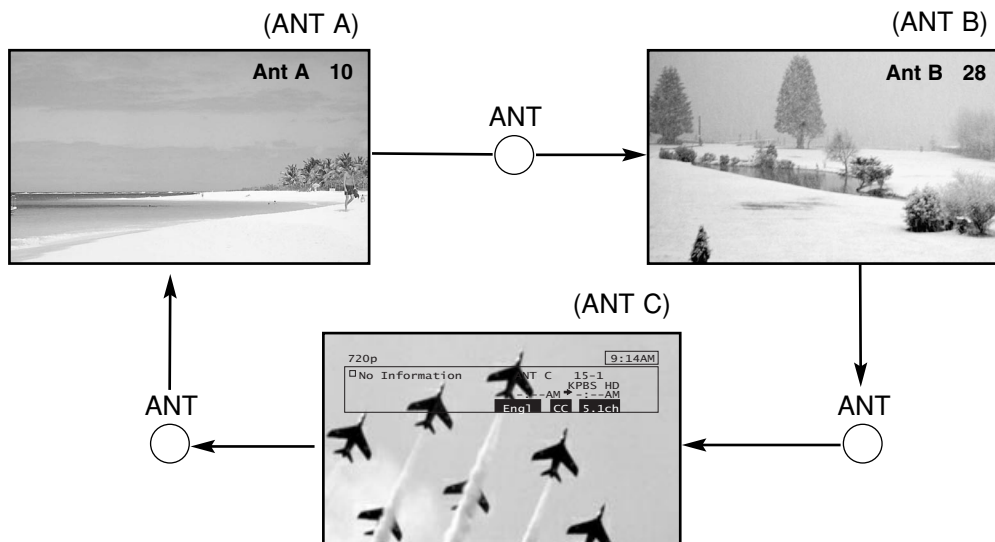

HOW TO USE THE REMOTE TO CONTROL YOUR TV



24 GUIDE button

The GUIDE button only works while in ANT C mode (DTV). Press this button to access the Channel Guide and Event Timer for ANT C. Press the GUIDE button again to return to normal viewing.

Select CHANNEL GUIDE to display available digital programs. Only scanned programs that are available at the present time will show in the Channel Guide (see Auto Channel Scan on page 65).

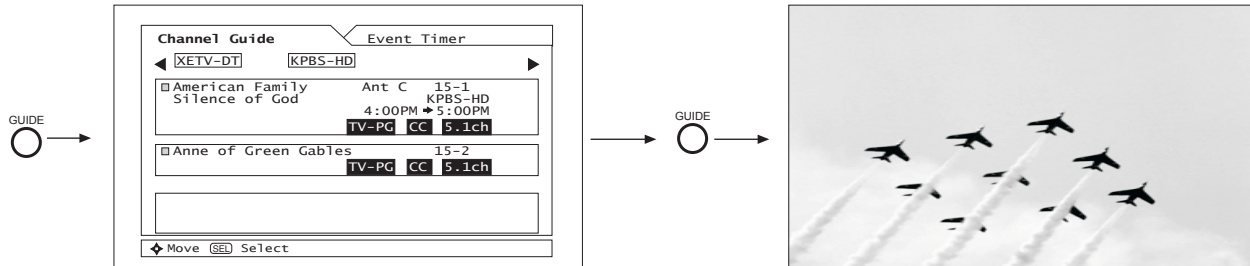

Use THUMB STICK ▲, ▼, ◀, ▶ to highlight the channel of choice (example: KPBS-HD). Press THUMB STICK ▲, ▼, to highlight the subchannel of choice (example: 15-1). Press down on THUMBSTICK to tune the subchannel of choice.

NOTES: If a channel has over 3 sub-channels (15-1, 15-2, 15-3, 15-4), you can scroll by using the up (▲) and down (▼) buttons.

Select EVENT TIMER to set the TV to view or record digital channels from ANT C at the time set. The CLOCK should be set first (see page 62). When EVENT TIMER is selected, the DATE, START/FINISH TIME, CHANNEL NUMBER and MODE (View or Recording) can be set individually.

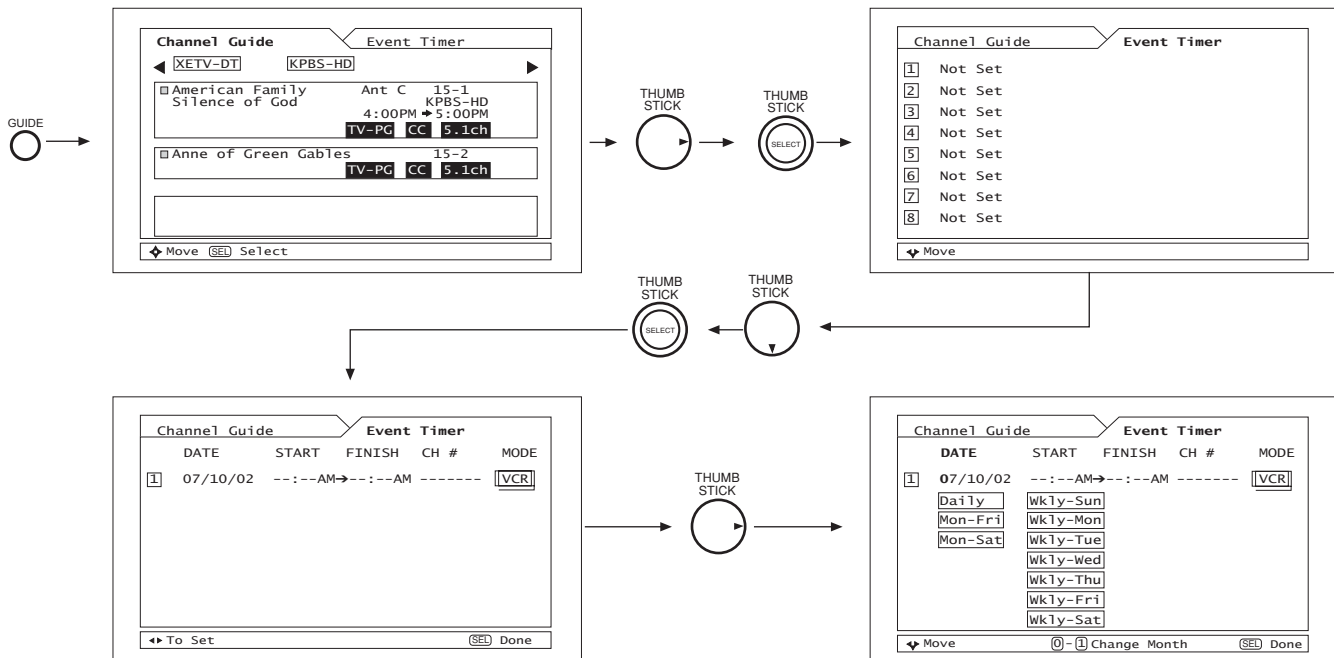



HOW TO USE THE REMOTE TO CONTROL YOUR TV

Use THUMB STICK ▲, ▼, ◀, ▶ to highlight chosen DATE options.

Press down on THUMBSTICK to select.

Use THUMBSTICK ▶ to highlight START TIME. Use Number buttons to set START TIME. (example: Press [0] [4] [3] [0])

Use THUMBSTICK ▲, ▼ to highlight AM or PM. Press down on THUMBSTICK to select. (example: PM)

Use THUMBSTICK ▶ to highlight FINISH TIME. (example; Press [0] [5] [0] [0])

Use THUMBSTICK ▲, ▼ to highlight AM or PM. Press down on THUMBSTICK to select. (example: PM)

Use THUMBSTICK ▶ to highlight CH# (Channel Number). Use number buttons to enter the channel number to be viewed or recorded.
(example: Press [0] [0] [4] [0] [0] [1])

Use THUMBSTICK ▲, ▼ to highlight chosen MODE (View or Recording). Press down on THUMBSTICK to select.

When VIEW is selected, a "✓" in the box means it is enabled.

When RECORDING is selected, use THUMBSTICK ▲, ▼ to highlight a recording device (example: D1 (D-VHS1)).

Press down on THUMBSTICK to select.

Press down on THUMBSTICK again to set. The screen below will appear.

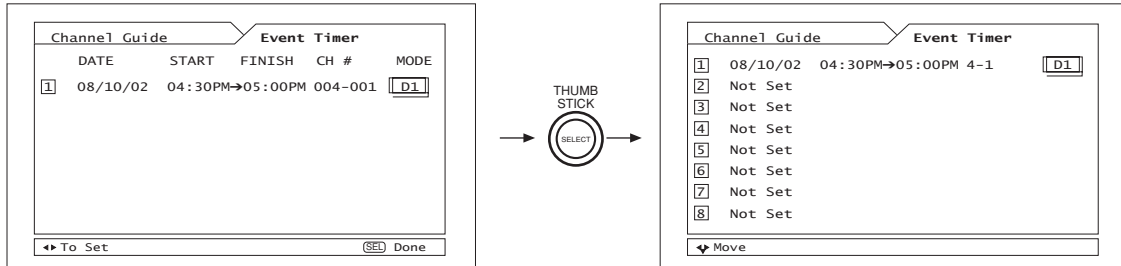

Press EXIT to quit the menu.

- NOTES:**
1. A maximum of 8 programs can be set on EVENT TIMER.
 2. EVENT TIMER cannot be set if an invalid channel number was entered.
 3. To cancel recording, press [REC] button on remote control first.
 4. The GUIDE button will be disabled when EVENT TIMER is activated.

PICTURE-IN-PICTURE (PIP)



Your HITACHI Projection TV incorporates Three Tuner technology designed for improved viewing enjoyment. This Three Tuner feature allows you to view antenna inputs on both the main picture and sub-picture simultaneously, with separate tuning control for each.

ANT A and ANT C input can be viewed as both the main picture and the sub-picture simultaneously. ANT B can only be viewed as a main picture. To select between main picture and PIP sub-picture tuning, press the PIP CH button on the remote. The green highlighted channel display will move with every press of the PIP CH button.

The Picture-in-Picture feature is convenient when you want to watch more than one program at the same time. You can watch a TV program while viewing other programs from the ANT A/C source or any of the video inputs.

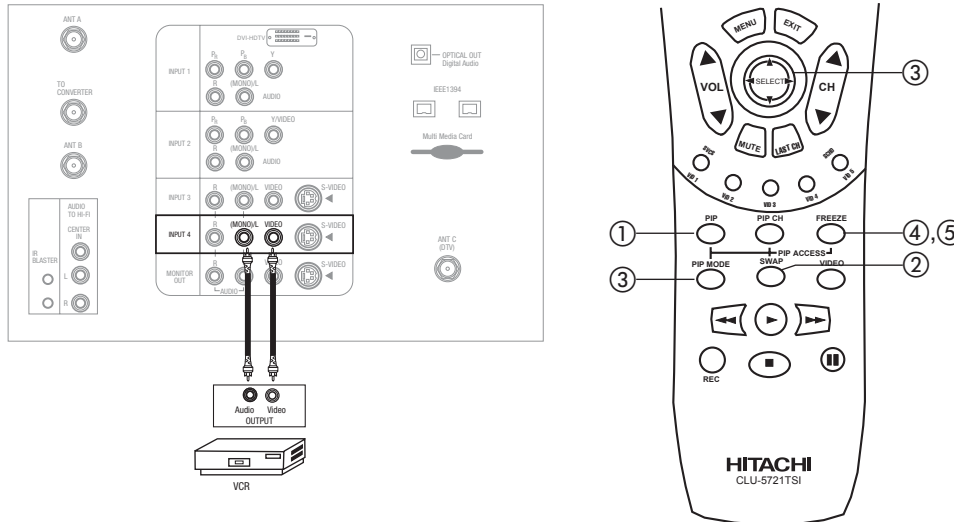

Use above connection to view VCR program as a sub-picture while viewing another program as main picture (ANT A, ANT B, ANT C, V:1, V:2, V:3, V:4, or V:5). You may also view the VCR program as a main picture while viewing another program as a sub-picture (ANT A, ANT C, V:1, V:2, V:3, or V:5).

① PIP button

Press the PIP button and a sub-picture will appear in one of the four different modes (POP, PIP, SPLIT or SURF), depending on the last selection of the PIP mode. To change the PIP mode, use the PIP MODE button to cycle through the four different modes.

POP MODE PICTURE-IN-PICTURE

Press the PIP button and a sub-picture appears in one of the four different modes (POP, PIP, SPLIT or SURF), depending on the last selection of the PIP mode. Press the PIP button again to remove the sub-picture from the screen. Use the PIP CH button to select between main and sub-picture tuning control (indicated by green highlighted channel display.) Press the VID1, VID2, VID3, VID4 or VID5 button when sub-picture channel tuning is being controlled, to change between VIDEO: 1, VIDEO: 2, VIDEO: 3, VIDEO:4 and VIDEO:5 and ANT:A source. (ANT B source cannot be viewed as a sub-picture.)

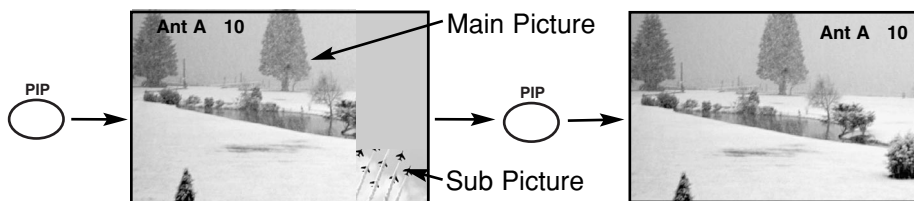

- NOTES:**
1. When ANT B is selected as the main channel, the SWAP feature is disabled.
 2. In POP mode, THUMBSTICK ▲, ▼ will move the sub-picture up/down.
 3. Only sound from the main picture can be heard.

PIP MODE PICTURE-IN-PICTURE This feature is only available with a 1080i component input or ANT C signal. For ANT C, this feature is available with a 1080i, 720p and 480p input signal) To prevent a pattern burn, occasionally move the sub-picture using the THUMBSTICK.

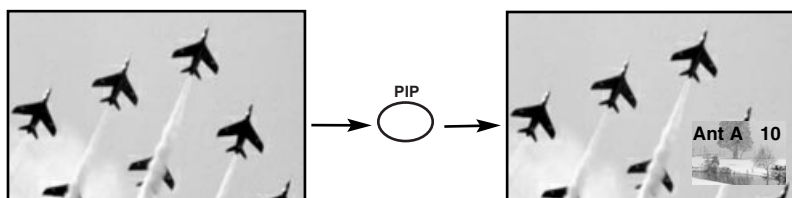



PICTURE-IN-PICTURE (PIP)

SPLIT MODE PICTURE-IN-PICTURE

Split Mode PIP displays the main picture and sub-picture evenly on the screen.

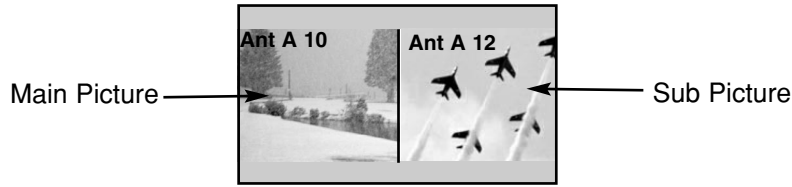

NOTE: When in ANT C SPLIT mode PIP, main picture and sub picture will always be the same.

SURF MODE PICTURE-IN-PICTURE

This feature will automatically scan all active channel numbers (those set in memory) and display them as PIP sub-pictures. Press the PIP button a second time to remove the sub-pictures from the screen.



- NOTES:**
1. If no buttons are pressed when in SURF mode, auto-scanning will continuously scan channels in memory. (see page 54)
 2. If a channel is tuned during this SURF scanning, sub-pictures will be removed from the screen.
 3. SURF MODE PIP is allowed only when ANT A, ANT B and ANT C is selected as the main channel.
 4. If MOVIE/TV RATINGS lock functions setting is ON, SURF mode will be deactivated.
 5. Closed Caption will not appear when SURF mode is on.

② SWAP button

If you wish to switch what is being shown on the main picture to the sub-picture, press the SWAP button.

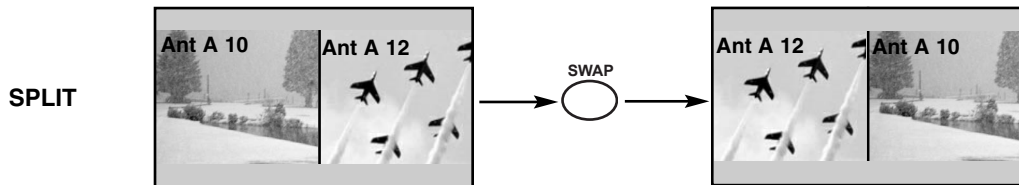

- NOTES:**
1. The SWAP button will only operate in POP, PIP, and SPLIT PIP mode.
 2. The SWAP function will not operate if ANT B input is set as the main channel (ANT B input cannot be displayed as a sub-picture.)

③ PIP MODE button

To change between the different PIP modes (POP, PIP, SPLIT or SURF) press the PIP MODE button when PIP is ON. Each press of this button will change PIP to a different mode.

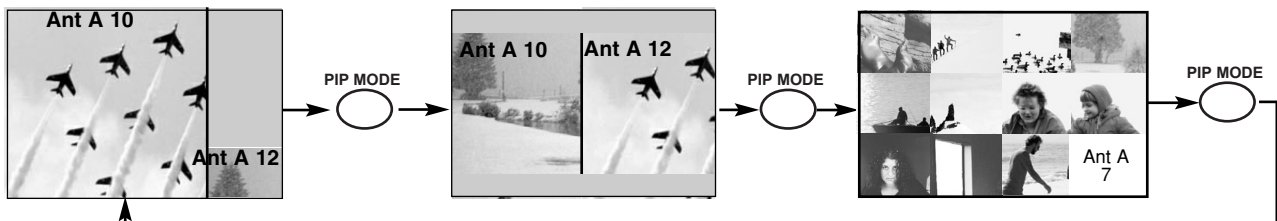

PIP MODES will depend on the type of signal format received.

	PICTURE-IN-PICTURE (PIP) MODES			
	POP	PIP	SPLIT	SURF
NTSC (ANT A/B)	YES	x	YES	YES
480i	YES	x	YES	x
480p	x	x	YES	x
720p	x	x	YES	x
1080i	x	YES	YES	x
ANT C (DTV)	YES	YES	YES	YES



PICTURE-IN-PICTURE (PIP)

④ FREEZE button (With PIP ON)

If you wish to freeze the sub-picture, press the FREEZE button. This is convenient when trying to write down the address for a mail order company, recording statistics for a sporting event, etc. To return the picture to motion, press the FREEZE button again.

NOTE: When PIP is on, the FREEZE function will only operate when POP/PIP/SPLIT mode is chosen.

⑤ FREEZE button (with PIP OFF)

Press the FREEZE button to freeze the picture, depending on the PIP mode selected (POP Main Freeze, POP Sub Freeze, SPLIT and STROBE).

To change FREEZE modes, use the PIP MODE button to cycle through the four different modes.

POP MAIN FREEZE (with PIP OFF)

PIP should be in POP mode. Press the FREEZE button to freeze one frame of the picture you are currently viewing and the frozen frame will show in the Main Picture. Press this button again or PIP to return to normal viewing. This feature is useful for freezing a picture frame with addresses.



POP SUB FREEZE (with PIP OFF)

PIP should be in POP mode. Press the PIP button and then press the FREEZE button to freeze the sub-picture. Press the FREEZE button again and press the PIP button to return to normal viewing.



SPLIT FREEZE (with PIP OFF)

PIP should be in SPLIT mode. Press the FREEZE button to freeze the picture you are currently viewing (only the right sub-picture will freeze). Press the FREEZE button again to return to normal viewing.

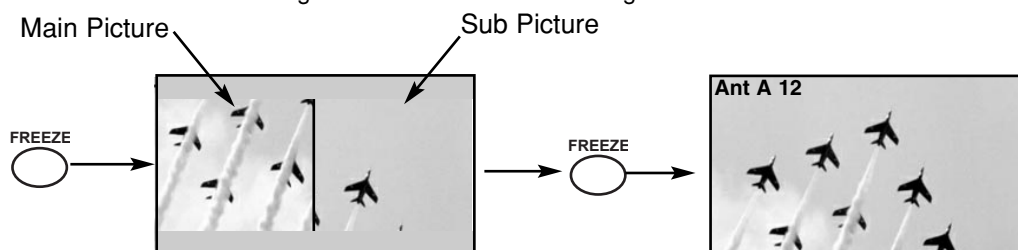

STROBE FREEZE (with PIP OFF)

PIP should be in SURF mode. Press the FREEZE button to freeze three frames of the picture you are currently viewing. Press this button again or PIP to return to normal viewing. This feature is useful for viewing a moving picture that has many details, for example, a close play in a sporting event or a golf swing.

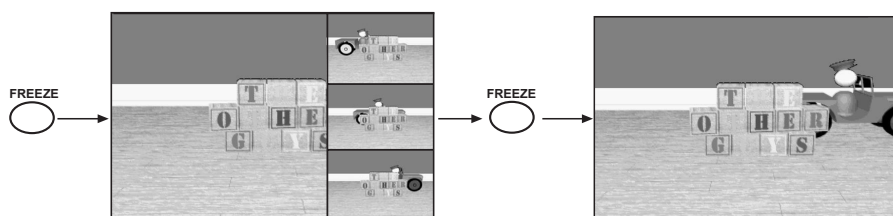

- NOTES:**
1. Each freeze frame is delayed about 0.1 (1/10) second.
 2. When in ANT A/ANT B, the FREEZE mode cycles through POP-POP-SPLIT-STROBE.
 3. When in ANT C, the FREEZE mode cycle will depend upon the signal format received.



USING THE REMOTE TO CONTROL VCR FUNCTIONS

Operating the precoded function for your VCR.

This remote is designed to operate different types of VCRs. You must first program the remote to match the remote system of your VCR. (refer to page 42 for pre-codes)

1. Turn ON your VCR.
2. Aim the remote control at the front of your VCR.
3. Press and release the VCR button to switch to VCR pre-coded mode.
4. Hold down the VCR button on the remote and enter the two digit preset code that matches your VCR, as shown on page 42. The indicator light will flash 3 times if the code was accepted.
5. Aim the remote at the VCR and press the POWER button. The remote will turn off your VCR when the correct two digit preset code is entered. When this occurs, the remote control is programmed for your VCR. If the VCR does not turn off, try a different two digit preset code.
6. The remote will now control your VCR.

NOTES:

1. If your VCR cannot be operated after performing the above procedures, your VCR's code has not been precoded into the remote.
2. In the unlikely event that your VCR cannot be operated after performing the above procedures, please consult your VCR operating guide.
3. The remote control will remember the codes you have programmed until the batteries are removed from the remote control. After replacing the batteries repeat the entire programming procedure as stated above.
4. The MENU button will act as the VCR MENU button for HITACHI VCRs.
5. The LAST CH button will act as your VCR ENTER button if required.
6. The SLEEP button will act as your VCR '100' button if required.

① VCR Button

This button allows the remote to control your VCR by setting it to VCR mode.

② PRECODED VCR Buttons

These buttons transmit the chosen precoded VCR codes. For some VCRs, you must press the RECORD button twice to record a program.

③ EXCLUSIVE TV Buttons

These buttons are for operating the TV.

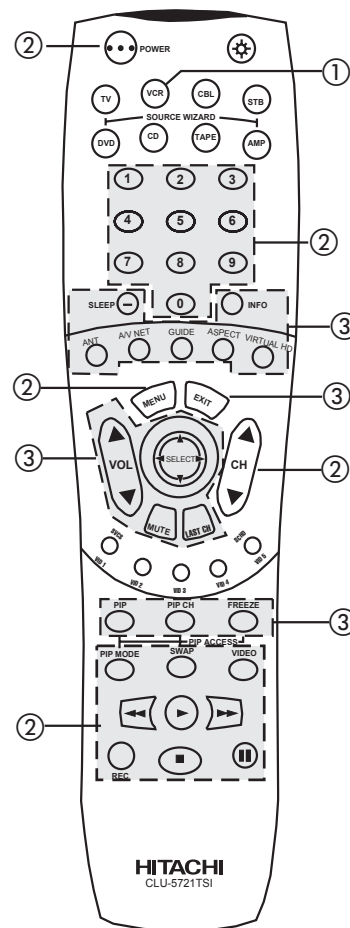

MY VCR CODE IS: _____

NOTE: Refer to instruction manual of the VCR for operation of the buttons exclusively for the VCR.

USING THE REMOTE TO CONTROL CABLE BOX FUNCTIONS



Operating the precoded function for your cable box.

This remote is designed to operate different types of cable boxes. You must first program the remote to match the remote system of your cable box. (refer to page 42)

1. Turn ON your cable box.
2. Aim the remote control at the front of your cable box.
3. Press and release the Cable (CBL) button to switch to Cable pre-coded mode.
4. Hold down the CBL button on the remote and enter the two digit preset code that matches your cable box as shown on page 42. The indicator light will flash 3 times if the code was accepted.
5. Aim the remote at the cable box and press the POWER button. The remote will turn off your cable box when the correct two digit preset code is entered. When this occurs, the remote control is programmed for your cable box. If the cable box does not turn off, try a different two digit preset code.
6. The remote will now control your Cable box.

NOTES:

1. If your cable box cannot be operated after performing the above procedures, your cable box code has not been precoded into the remote.
2. In the unlikely event that your cable box cannot be operated after performing the above procedures, please consult your cable box operating guide.
3. The remote control will remember the codes you have programmed until the batteries are removed from the remote control. After replacing the batteries repeat the entire programming procedure as stated above.
4. The LAST CH button will act as the cable box ENTER button if required.
5. The SLEEP button will act as your cable box '100' button if required.
6. The ANT button will act as the TV/STB button when in STB mode.

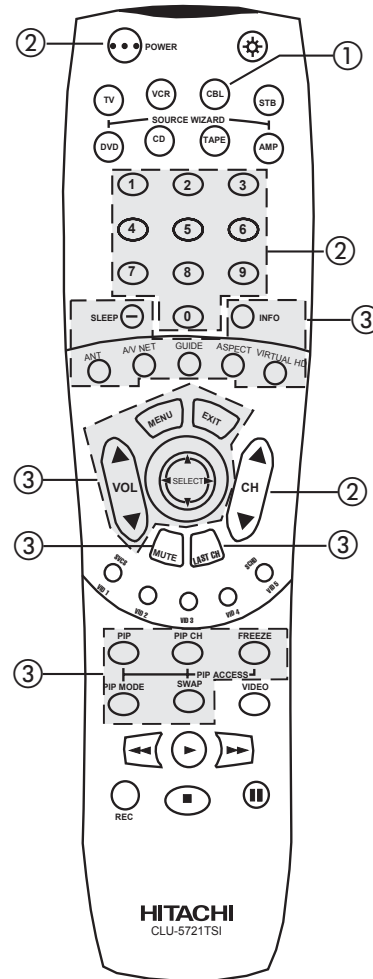

- ① **CABLE (CBL) button**
This button allows the remote to control your cable box by setting it to CABLE mode.
- ② **PRECODED CABLE BOX buttons**
These buttons transmit the chosen precoded cable codes.
- ③ **EXCLUSIVE TV buttons**
These buttons are for operating the TV.

MY CABLE BOX CODE IS: _____

NOTE: Refer to instruction manual of the Cable Box for operation of the buttons exclusively for the Cable Box.



USING THE REMOTE TO CONTROL SET-TOP-BOX/SATELLITE RECEIVER FUNCTIONS

Operating the precoded function for your set-top-box/satellite receiver.

This remote is designed to operate different types of set-top-box/satellite systems. You must first program the remote to match the remote system of your set-top-box/satellite systems. (refer to page 42)

1. Turn ON your set-top-box/satellite systems.
2. Aim the remote control at the front of your set-top-box/satellite systems.
3. Press and release the SET-TOP-BOX (STB) button to switch to set-top-box/satellite pre-coded mode.
4. Hold down the STB button on the remote and enter the two digit preset code that matches your set-top-box/satellite receiver as shown on page 42. The indicator light will flash 3 times if the code was accepted.
5. Aim the remote at the set-top-box/satellite receiver and press the POWER button. The remote will turn off your set-top-box/satellite receiver when the correct two digit preset code is entered. When this occurs, the remote control is programmed for your set-top-box/satellite receiver. If the set-top-box/satellite receiver does not turn off, try a different two digit preset code.
6. The remote will now control your set-top-box/satellite receiver.

NOTES:

1. If your set-top-box/satellite receiver cannot be operated after performing the above procedures, your set-top-box/satellite receiver code has not been precoded into the remote.
2. In the unlikely event that your set-top-box/satellite receiver cannot be operated after performing the above procedures, please consult your set-top-box/satellite receiver operating guide.
3. The remote control will remember the codes you have programmed until the batteries are removed from the remote control. After replacing the batteries repeat the entire programming procedure as stated above.
4. The ANT button will act as the TV/STB button when in STB mode.

- ① **SET-TOP-BOX (STB) button**
This button allows the remote to control your satellite receiver by setting it to SET-TOP-BOX/SATELLITE mode.
- ② **PRECODED SET-TOP-BOX/SATELLITE RECEIVER buttons**
These buttons transmit the chosen precoded set-top-box/satellite codes.
- ③ **EXCLUSIVE TV buttons**
These buttons are for operating the TV.

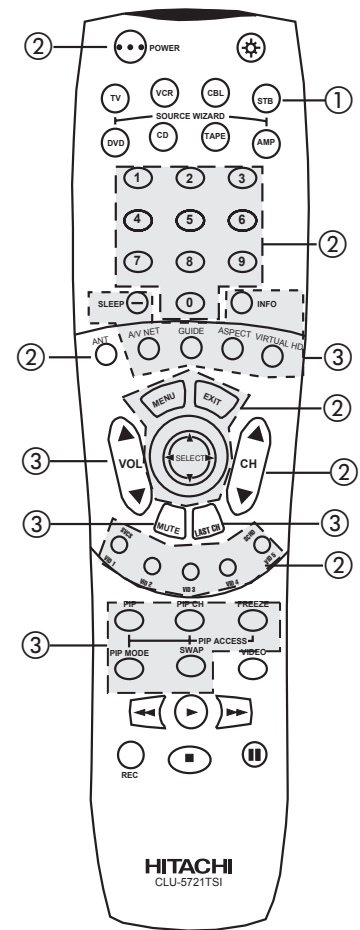

MY SATELLITE RECEIVER/STB CODE IS: _____

NOTE: Refer to instruction manual of the set-top-box/satellite receiver for operation of the buttons exclusively for the set-top-box/satellite receiver.

USING THE REMOTE TO CONTROL DVD FUNCTIONS



Operating the precoded function for your DVD player.

This remote is designed to operate different types of DVD players. You must first program the remote to match the remote system of your DVD player. (refer to page 42 for pre-codes)

1. Turn ON your DVD player.
2. Aim the remote control at the front of your DVD player.
3. Press and release the DVD button to switch to DVD pre-coded mode.
4. Hold down the DVD button on the remote and enter the two digit preset code that matches your DVD player, as shown on page 42. The indicator light will flash 3 times if the code was accepted.
5. Aim the remote at the DVD player and press the POWER button. The remote will turn off your DVD player when the correct two digit preset code is entered. When this occurs, the remote control is programmed for your DVD player. If the DVD player does not turn off, try a different two digit preset code.
6. The remote will now control your DVD player.
7. You will need to set the display type of your DVD player to 16:9 widescreen.

NOTES:

1. If your DVD player cannot be operated after performing the above procedures, your DVD player's code has not been precoded into the remote.
2. In the unlikely event that your DVD player cannot be operated after performing the above procedures, please consult your DVD player operating guide.
3. The remote control will remember the codes you have programmed until the batteries are removed from the remote control. After replacing the batteries repeat the entire programming procedure as stated above.

- ① **DVD Button**
This button allows the remote to control your DVD player by setting it to DVD mode.
- ② **PRECODED DVD Buttons**
These buttons transmit the chosen precoded DVD codes.
- ③ **EXCLUSIVE TV Buttons**
These buttons are for operating the TV.

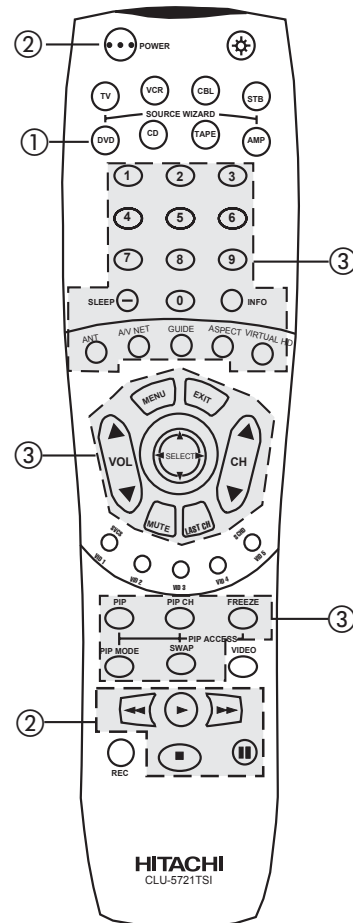

MY DVD PLAYER CODE IS: _____

NOTE: Refer to instruction manual of the DVD player for operation of the buttons exclusively for the DVD player.



USING YOUR REMOTE TO CONTROL ADDITIONAL AUDIO EQUIPMENT

Operating the precoded function for your Audio component.

This remote is designed to operate different types of Audio component. You must first program the remote to match the remote system of your Audio component. (refer to page 42 for pre-codes)

1. Turn ON your Audio component you wish to control with the Remote.
2. Aim the remote control at the front of your Audio component.
3. Press and release the CD, TAPE or AMP button (Audio buttons) to switch to Audio component pre-coded mode.
4. Hold down the CD, TAPE or AMP button on the remote and enter the two digit preset code that matches your Audio component, as shown on page 42. The indicator light will flash 3 times if the code was accepted.
5. Aim the remote at the Audio component and press the POWER button. The remote will turn off your Audio component when the correct two digit preset code is entered. When this occurs, the remote control is programmed for your Audio component. If the Audio component does not turn off, try a different two digit preset code.
6. The remote will now control your Audio component.
7. Repeat steps 1 - 6 if you wish to program the remote to control another Audio component. Be sure to use a different Audio button on the remote, since only one component can be programmed per button.

NOTES:

1. If your Audio component cannot be operated after performing the above procedures, your Audio component's code has not been precoded into the remote.
2. In the unlikely event that your Audio component cannot be operated after performing the above procedures, please consult your Audio equipment operating guide.
3. The remote control will remember the codes you have programmed until the batteries are removed from the remote control. After replacing the batteries repeat the entire programming procedure as stated above.

- ① **CD, TAPE, AMP Buttons**
These buttons allow the remote to control your Audio equipment by setting it to Audio mode.
- ② **PRECODED AUDIO Buttons**
These buttons transmit the chosen precoded Audio component codes.
- ③ **EXCLUSIVE TV Buttons**
These buttons are for operating the TV.

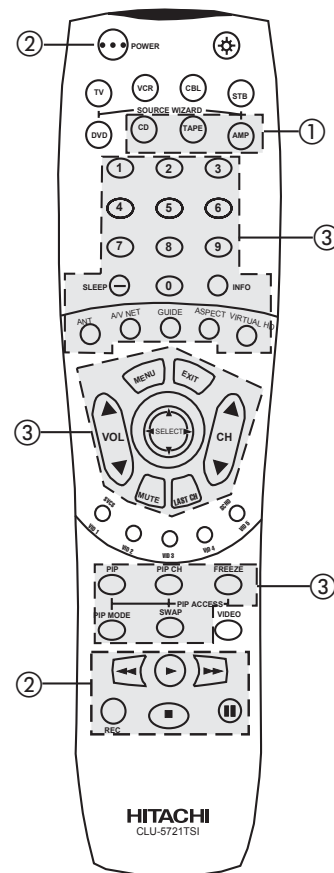

MY AUDIO EQUIPMENT CODE IS:

CD _____
 TAPE _____
 AMP/RCVR _____

NOTE: Refer to instruction manual of the Audio equipment for operation of the buttons exclusively for the Audio equipment.

THE SIMPLE REMOTE CONTROL



HITACHI has provided a second remote control for your convenience. The Simple Remote Control has the basic features that are most often used.

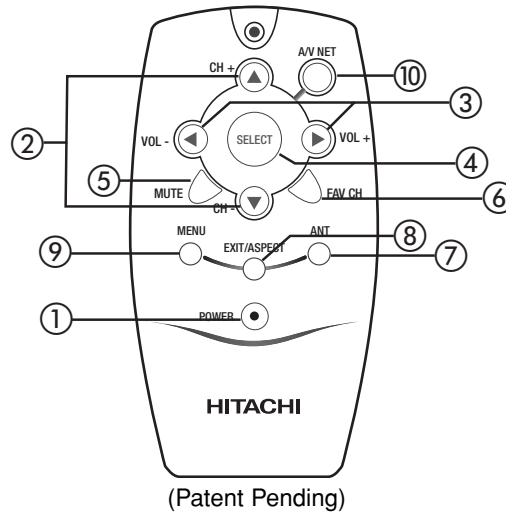

- ① **POWER button**
Press Power button to turn the TV set ON or OFF.
- ② **CH+ (▲), CH- (▼)**
Press the CH+ (▲) up or CH- (▼) down buttons to select desired channel or to navigate the on screen display features when in A/V NET mode.
- ③ **VOL- (◀), VOL+ (▶)**
Press the VOL- (◀) down or VOL+ (▶) up buttons to select desired sound level or to navigate the on screen display features when in A/V NET mode.
- ④ **SELECT button**
Press SELECT button to Select when in MENU and A/V NET mode.
- ⑤ **MUTE button**
To reduce the sound to one half of normal volume (SOFT MUTE) to answer the telephone, etc., press the MUTE button. Press the MUTE button again to turn the sound off completely (MUTE). To restore the sound, press the MUTE button one more time, or press the VOLUME Up (▶) button. (See complete explanation and example on page 29, Item ⑰.)
- ⑥ **FAV CH button**
Press FAV CH button to access your favorite channels.
- ⑦ **ANT button**
The ANT button will select between Antenna A/B and Antenna C each time the button is pressed. (See example on page 30, item ⑳.)
- ⑧ **EXIT/ASPECT button**
When in MENU mode, press the EXIT/ASPECT button to display the present picture format aspect ratio and exit all On-Screen Displays except the IEEE1394 Menu. Press the A/V NET button to exit the IEEE1394 Menu. When not in Menu Mode, press the EXIT/ASPECT button to change the picture format aspect ratio.
- ⑨ **MENU button**
Press the MENU button to start the On-Screen Display.
- ⑩ **A/V NET**
Press this button to access the Audio/Video network (A/V Net) menu. The A/V Net allows the user to control external components with the TV's remote control. (See complete explanation and example on page 27, item ⑪.)

When in ANT C, press this button twice to quickly access the IEEE1394 menu.

NOTE: The Simple Remote cannot be programmed to control external components.



VCR, CABLE, SATELLITE, DVD and AUDIO CODES FOR REMOTE CONTROL

VCR BRAND	CODE
Adventura	01
Aiko	09
Aiwa	01
Akai	02, 47, 48
American High	23
Asha	44
Audiovox	24
Beaumarck	44
Bell & Howell	32
Broksonic	33, 34, 41
Calix	24
Canon	23
Carver	31
CCE	09
Citizen	09, 24
Craig	19, 24, 44
Curtis Mathes	02, 23, 46
Cybernex	44
Daewoo	09, 17
Dynatech	01
Electrohome	24
Electrophonic	24
Emerex	08
Emerson	01, 09, 13, 16, 24, 27, 28, 33, 34, 36, 41, 47
Fisher	19, 21, 32
Fuji	10, 23
Funai	01
Garrard	01
GE	04, 23, 40, 46
Goldstar	24, 25, 43
Gradiente	01
Harley Davidson	01
Harmon/Kardon	25
Headquarter	18
Hi-Q	19
Hitachi	02, 03, 04, 05
Jensen	02
JVC	02, 14, 26
KEC	09, 24
Kenwood	02, 25, 26
KLH	30
Kodak	23, 24
Lloyd	01
Lloyd's	27
LXI	24
Magnavox	15, 23, 31, 35
Magnin	44
Marantz	23, 31
Marta	24
Matsushita	23
MEI	23
Memorex	01, 15, 18, 19, 20, 23, 24, 32, 44
MGA	16, 47
MGN Technology	44
Minolta	03, 05
Mitsubishi	16, 26, 39, 47, 48
Motorola	20, 23
MTC	01, 44
Multitech	01
NEC	02, 25, 26, 32
Nikko	24
Noblex	44
Olympus	12, 23
Optimus	20, 24, 32
Panasonic	11, 12, 23, 38
Penney	03, 23, 24, 25, 44
Pentax	03, 04, 05
Philco	23
Phillips	23, 31
Pilot	24
Pioneer	26
Pulsar	15

Quarter	18
Quartz	18
Quasar	23
Radio Shack	01, 24
Radix	24
Randex	24
RCA	03, 04, 05, 35, 40, 46
Realistic	01, 18, 19, 20, 21, 23, 24, 32, 44
Ricoh	22
Runco	15
Samsung	17, 44
Sanky	15, 20
Sansui	02, 26
Sanyo	18, 19, 32, 44
Scott	16, 17, 33, 34, 36, 41
Sears	03, 05, 18, 19, 21, 23, 24, 32
Sharp	20
Shintom	30
Shogun	44
Sony	08, 10, 22, 23
STS	03
Sylvania	01, 16, 23, 31
Symphonic	01
Tatung	02
Teac	01, 02
Technics	23, 38
Teknika	01, 23, 24
TMK	27, 44
Toshiba	16, 17, 21, 36
Totvision	24, 44
Unitech	44
Vector	17
Vector Research	25
Video Concepts	17, 47
Video Sonic	44
Wards	01, 03, 19, 20, 23, 35, 36, 44, 46
XR-1000	01, 23
Yamaha	25
Zenith	10, 15, 22

DVD BRAND	CODE
Denon	04
Hitachi	07, 12, 13
JVC	01
Kenwood	04
Magnavox	05
Mitsubishi	10
Panasonic	04
Phillips	06
Pioneer	03
RCA (Proscan)	09
Samsung	12
Sanyo	13
Sony	02
Toshiba	05
Yamaha	08
Zenith	05, 11

CABLE BRAND	CODE
ABC	01, 07, 08, 17, 18, 20, 36, 37, 49
Antronix	39
Archer	11, 24, 39
Belcor	32
Cable Star	32
Century	11
Citizen	11
Colour Voice	30, 42
Comtronics	25, 28
Contec	21
Dae Ryung	20
Eastern	14

Electricord	31
Everquest	51
Focus	52
Garrard	11
GC Electronics	32, 39
Gemini	05, 38, 43, 51
General Instrument	01, 12
Goldstar	10, 25
Hamlin	04, 13, 22, 23
Hitachi	01
Hytex	36
Jasco	11
Jerrold	01, 08, 12, 37, 49, 50, 51
Macom	35
Magnavox	15
Memorex	03
Movie Time	29, 31, 33
NSC	29, 33, 38
Oak	21, 36, 46
Panasonic	02, 03, 09
Paragon	03
Phillips	11, 15, 16, 26, 30, 42, 43, 44
Pioneer	06, 10, 19
Popular Mechanics	52
Pulsar	03
RCA	02
Realistic	39
Recoton	52
Regal	04, 22, 34
Regency	14
Rembrandt	01, 38
Runco	03
Samsung	10, 25
Scientific Atlanta	17, 20, 41, 45
Signal	25, 51
Signature	01
Sl Marx	25
Sprucer	02
Starcom	37, 49, 51
Stargate	25, 51
Starquest	51
Starsight	53, 54
Sylvania	18
Television	25
Texscan	18
Tocom	07, 27, 50
Toshiba	03
Tusa	51
TV 86	29
Unika	11, 39
United Artists	36
United Cable	49
Universal	11, 24, 31, 32, 34, 39
Videoway	47
Viewstar	15, 28, 29, 40
Zenith	03, 48
Zentek	52

SATELLITE BRAND	CODE
EchoStar	04
Hitachi	01
Hughes	05
RCA	02
Sony	03

SET-TOP-BOX	CODE
Panasonic	06
RCA	07
Samsung	08

AMPLIFIER BRAND	CODE
Aiwa	05, 06
Carver	01, 06, 08
Denon	10
Fisher	08, 11
Hitachi	12
JVC	13
Kenwood	14, 15, 17, 18
Magnavox	01, 06
Marantz	01, 06, 16
MCS	16
Optimus	03, 04, 11, 15, 20
Panasonic	16
Phillips	01, 06
Pioneer	03, 04, 20, 21, 22
Quasar	16
Sansui	06
Sanyo	11
Sharp	15
Sony	05
Technics	02, 16, 23, 24, 25
Victor	13
Wards	03, 05, 06, 08, 20, 21
Yamaha	15, 26

CD BRAND	CODE
Adcom	01
Aiwa	02
California Audio Lab	03
Carver	02
Denon	04
DKK	05
Emerson	01
Fisher	06
Genexxa	07
Hitachi	01, 07, 08, 09, 10, 11, 12
JVC	13
Kenwood	06, 14, 15
Krell	02
Magnavox	02
Marantz	02, 03
MCS	03
Mission	03
NSM	02
Onkyo	16
Optimus	05, 07, 17
Panasonic	03
Phillips	02
Pioneer	07, 17
Proton	02
QED	02
Quasar	03
RCA	01, 21
Realistic	01
Rotel	02
SAE	02
Sansui	02
Scott	01
Sony	05, 18
Technics	03, 19, 20
Victor	13

TAPE BRAND	CODE
Aiwa	11, 12
Hitachi	01, 02, 03, 04
JVC	05
Kenwood	06
Optimus	07
Pioneer	07
Sony	09, 10, 11, 12
Wards	07

ON-SCREEN DISPLAY (OSD)

1. Press MENU on the remote control to display the different features on your HITACHI Projection TV.
2. Press the THUMB STICK to highlight a different feature.
3. Press EXIT on the remote control to quickly exit from a menu.
4. Press A/V Net on the remote control to access the A/V Net menu to control external components. When in ANT C, press the A/V NET button twice to quickly access the IEEE1394 menu.
5. Press THUMB STICK ◀ or ▶ to access Favorite Channels menu.

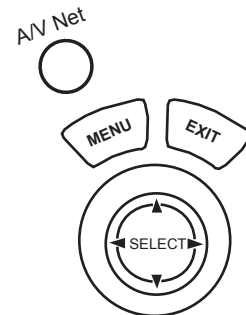

This part of the screen shows which selections are available.

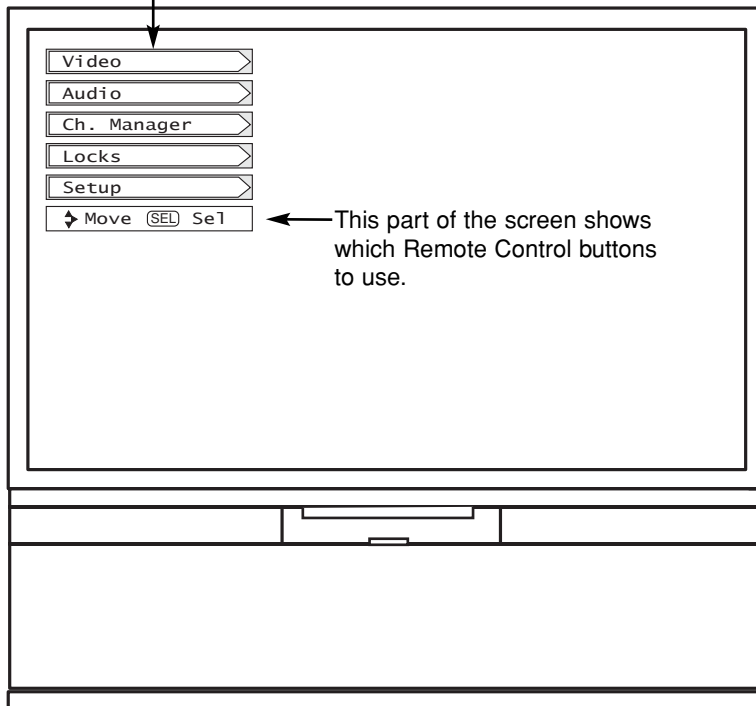

ON-SCREEN DISPLAY (OSD)

Video	Picture Mode	Select between the four picture modes: Sports, Movies, News, and Music.
	Contrast	Adjust contrast.
	Brightness	Adjust brightness.
	Color	Adjust color.
	Tint	Adjust tint.
	Sharpness	Adjust sharpness.
	Vertical Position	Centering top and bottom of the picture.
	Magic Focus	Automatic or manual alignment of the Red, Green and Blue colors to make white.
	Color System	Automatically change tint and color coordinates for DTV program.
Advanced Settings	Improve picture performance.	
Audio	Treble	Adjust the treble.
	Bass	Adjust the bass.
	Balance	Adjust the balance.
	Sound Enhancement	Set SRS and BBE surround settings.
	Advanced Settings	Improve sound performance.
	Advanced Digital	Digital Output Settings
Channel Manager	Ant A (NTSC)	View/edit Channel ID, Scan, and Lock settings in antenna A.
	Ant B (NTSC)	View/edit Channel ID, Scan, and Lock settings in antenna B.
	Ant C (DTV)	View/edit Channel ID, Scan, and Lock settings in antenna C.
Locks	Change Access Code	Change Lock access code.
	Engage Lock	Choose to lock channel, video input, and front panel.
	TV Time Lock	Set specific time to Lock TV.
	Movie Ratings	Block various types of movies and video types based on motion picture ratings.
	TV Ratings	Block various types of movies and television programming based on a parental guide ratings.
	Canadian Ratings (ENG)	Block various types of movies and television programming based on the Canadian ratings system.
	Canadian Ratings (FRN)	Block various types of movies and television programming based on the Canadian French ratings system.
Setup	Menu Preference	Choose English, French, or Spanish text.
	Set The Clock	Set the TV clock. It must be set before using Lock/Timer feature.
	Set The Channels	Set Channel Source and Auto Channel Scan.
	Set The Inputs	Label Video Inputs , VCR, DVD, etc.
	Set Event Timer	Turn TV on and off once, daily, or weekly.
	Set Closed Captions	Feature to display dialogue/text.
	Set Monitor Out	Set Monitor Out Source
	Upgrades	Softwares information for ANT C only.
	About Your TV	Displays TV model and dimensions.

VIDEO

Video

Select VIDEO to adjust picture settings and improve picture quality.

Picture Mode

Use this function to choose from automatic picture settings to optimize your TV's performance.

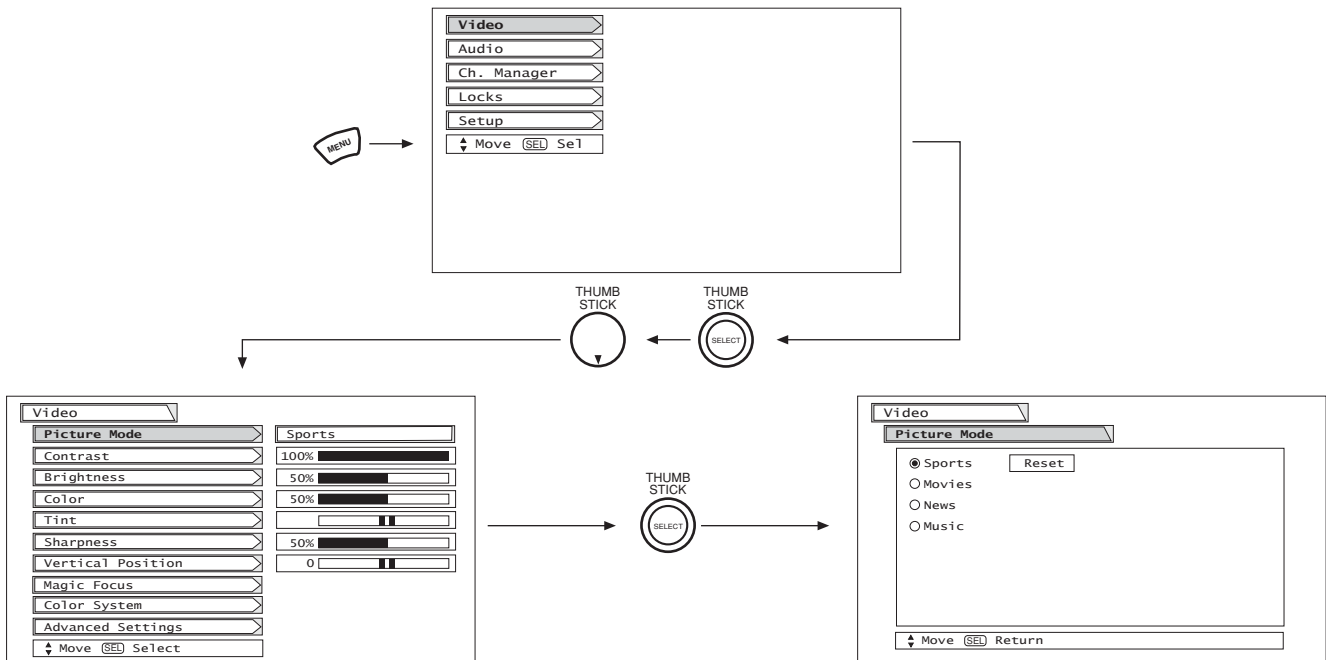

Use THUMB STICK ▲ or ▼ to highlight Picture Mode settings.

When SPORTS mode is selected, the following are automatically set:

CONTRAST - 100%, COLOR TEMPERATURE - HIGH, LOUDNESS - OFF, PERFECT VOLUME - OFF, BASS - 63%, SURROUND - SRS and BBE.

When MOVIES mode is selected, the following are automatically set:

CONTRAST - 60%, COLOR TEMPERATURE - STANDARD, SHARPNESS - 40%, BASS - 63%, LOUDNESS - OFF, PERFECT VOLUME - OFF, SURROUND - SRS, BBE and BBE Mach3Bass.

NOTE: MOVIE MODE 3:2 PULLDOWN DETECTION SPECIAL FEATURE

Theatrical movies are shot on film at 24 frames or still pictures per second, instead of 30 frames or 60 fields like video. When film is transferred to video for television viewing, the disparity between the two frame rates must be reconciled. This involves a process known as 3:2 pulldown.

When MOVIE mode is selected from the Picture Mode menu, your Hitachi Projection Television will activate the circuitry for this special feature to improve video performance when watching film based sources. This 3:2 pulldown detection will only work in MOVIE mode.

When NEWS mode is selected, the following are automatically set:

CONTRAST - 75%, COLOR TEMPERATURE - MEDIUM, LOUDNESS - ON, PERFECT VOLUME - ON.

When MUSIC mode is selected, the following are automatically set:

CONTRAST - 75%, COLOR TEMPERATURE - HIGH, LOUDNESS - OFF, PERFECT VOLUME - OFF, SURROUND - BBE Mach3Bass.

You can customize each of the above modes (SPORTS, MOVIES, NEWS, and MUSIC) to your preference to increase viewing performance and pleasure, depending upon the video program being viewed. However, if RESET is selected, each mode will reset to the initial conditions as explained above.

If RESET is selected in SPORTS mode, only SPORTS mode will return to factory conditions.

Press EXIT to quit menu or select PICTURE MODE to return to previous menu.

Use the THUMB STICK ▲ or ▼ to highlight the function to be adjusted.
Press the THUMB STICK ◀ or ▶ to adjust the function. Press down on THUMB STICK to select the function settings.
Press MENU to return to main menu or select PICTURE MODE to return to previous menu.
Press EXIT to quit menu.

Contrast

Use this function to change the contrast between black and white levels in the picture. This adjustment will only affect the picture when ADVANCED SETTINGS DIMMER is OFF.

Brightness

Use this function to adjust overall picture brightness.

Color

Use this function to adjust the level of color in the picture.

Tint

Use this function to adjust flesh tones so they appear natural.

Sharpness

Use this function to adjust the amount of fine detail in the picture.

Vertical Position

This function allows you to select when aspect style is either 4:3 EXPANDED/ZOOM1/ZOOM2. Vertical position can be changed with this mode. Adjustable range is -10 (video center is toward bottom of screen) to +10 (video center is toward top of screen).

- NOTES:**
1. If CONTRAST is selected, you are adjusting CONTRAST. The additional menu items BRIGHTNESS, COLOR, TINT, and SHARPNESS can be selected and adjusted in the same manner.
 2. It may be necessary to adjust TINT to obtain optimum picture quality when using the COMPONENT VIDEO Y-P_BP_R input jacks.
 3. If you are using the COMPONENT VIDEO input jacks (Y-P_BP_R) and notice that the TINT and COLOR are abnormal, check to make sure that the VIDEO-Color System is set properly.
 4. ANT A/ANT B and ANT C have different Video settings. Also, each of the video inputs have their own settings.
 5. If COLOR is set to minimum level, the On-Screen Display (OSD) will be difficult to see.

VIDEO

Magic Focus

Auto Digital Convergence Adjustment

Please turn ON your television for at least 20 minutes before using this feature.

The Magic Focus button on control panel will not work when adjustment mode is set to Manual (see page 48).

Your HITACHI Projection TV has three color projection tubes: one for red, one for green, one for blue. When mixed together in the proper proportion, the output of these three color tubes can produce any color. To produce these colors, however, the beams must be precisely aligned over each other so that the colors can be mixed. The process of aligning these picture beams is called "convergence".

Over a period of time, the picture tubes can drift out of alignment due to normal bumps and vibrations or moving the TV. If you move your TV, or if, after a time, you notice color rings or halos around objects in the picture, you may want to converge (align) the colors.

Properly converged, the lines appear white, which is actually a combination of the outputs of the three color tubes. The output of the green tube is stationary. The outputs of the red and blue tubes can be adjusted. When properly aligned, the outputs of all three tubes should be directly over each other to produce the white lines.

To simplify convergence, HITACHI incorporates a function called MAGIC FOCUS located on the front control panel, which allows the TV to self-adjust. Press this MAGIC FOCUS button and the convergence self adjustment will start and this process will take approximately 20 seconds. If this button is pressed during this process, no change in picture quality will occur. After this 20 second self-adjust period, picture quality will be optimum. (Do not move the TV during self-adjust.)

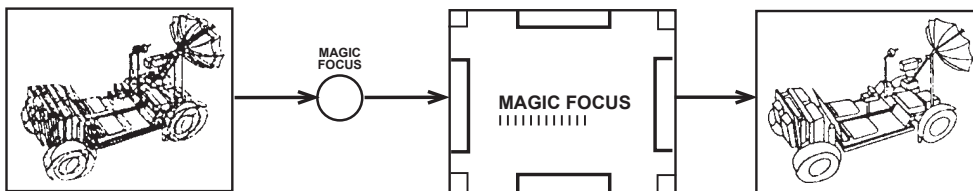

NOTES: Only a momentary press of the MAGIC FOCUS button is necessary to start AUTO DIGITAL CONVERGENCE. At any time during this convergence correction process, you may press the MAGIC FOCUS button to exit the MAGIC FOCUS mode. However, the convergence correction process needs to be completed to SAVE the new corrected convergence data.

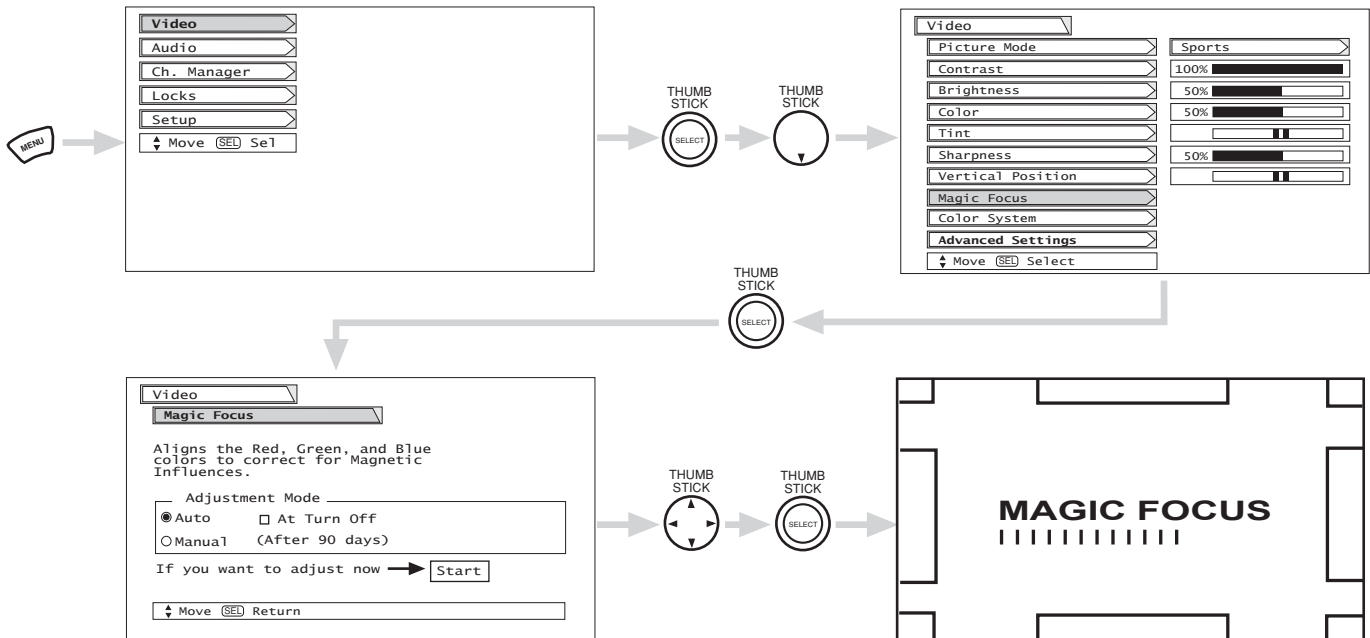

NOTES: When Auto Start at Turn Off is selected, the TV will adjust itself after 90 days.

Manual Convergence Adjustment Mode

- NOTES:**
1. Please turn ON your television for at least 20 minutes before using this feature.
 2. Auto Adjustment Mode is recommended. If convergence is still not acceptable, use the Manual Adjustment Mode. DO NOT press MAGIC FOCUS or use Auto Adjustment Mode after using Manual Adjustment Mode.

Using the Remote Control, select VIDEO-MAGIC FOCUS-MANUAL ADJUSTMENT MODE-START to access convergence crosshatch pattern. The adjustment point is indicated by the Adjustment Point Cursor.

To Move Adjustment Point

To move the adjustment point cursor using the THUMBSTICK, the Adjustment Cursor must be WHITE. Another way to move the Adjustment Point Cursor is to press the following buttons: [2] up, [4] left, [5] down, [6] right. If you use the number buttons while the adjustment point is WHITE, it will change to RED.

To Change the Color of Adjustment Point

Press the SELECT button repeatedly (WHITE-RED-BLUE-WHITE...). Green color is fixed and cannot be adjusted.

To Adjust the Convergence

Move the Adjustment Cursor to the point to be adjusted. Use the THUMB STICK to match the RED and BLUE colors to GREEN (reference color). Properly aligned, all three colors should appear white.

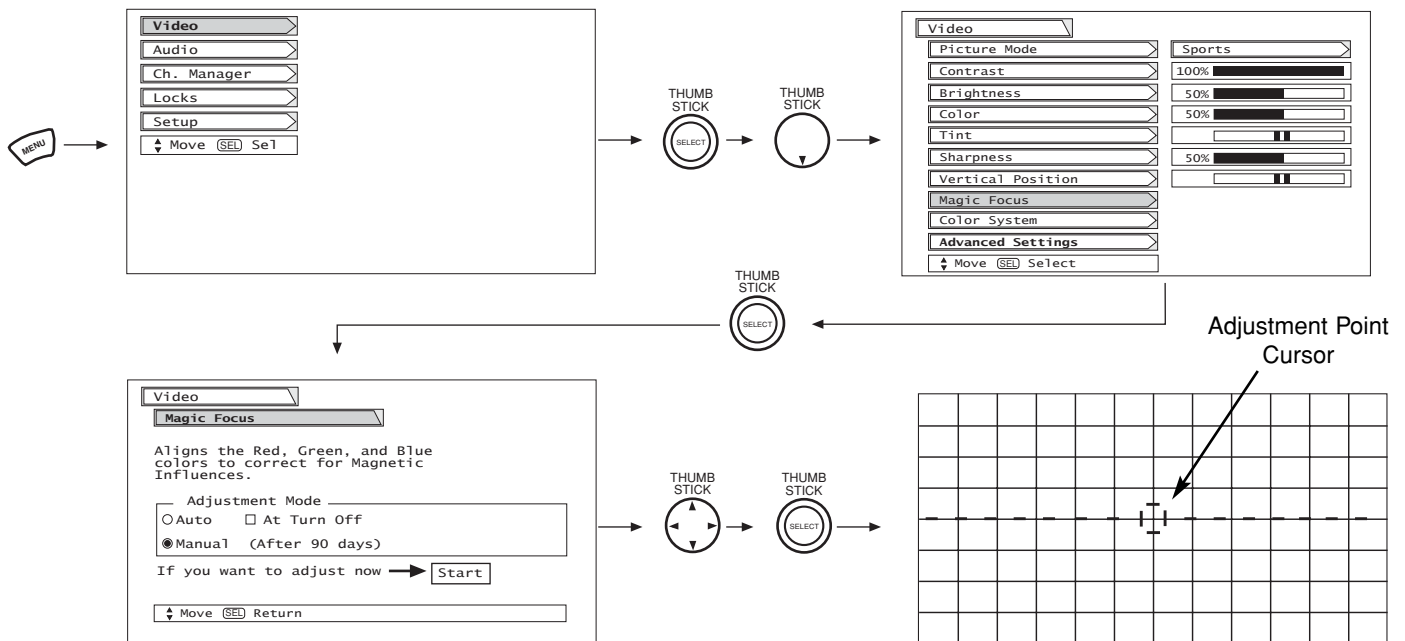

If convergence is acceptable after Manual Convergence adjustment, press EXIT button to access menu mode.

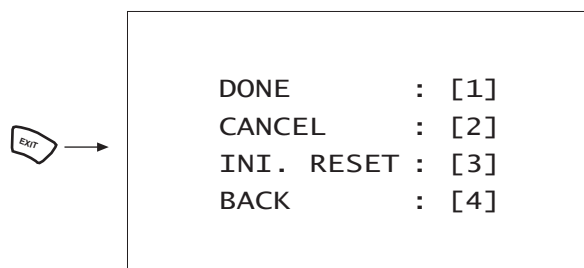

Press the [1] button on the remote control to SAVE adjusted data and return to main picture.

Press the [2] button on the remote control to CANCEL adjusted data and return to main picture.

Press the [3] button on the remote control to recall the factory pre-set convergence data.

Press the [4] button on the remote control to return to the manual convergence adjustment mode (crosshatch pattern).

Press the [9] button on the remote control to read the SAVED adjusted data. If there is no saved data, pressing the [9] button will recall the factory pre-set data.

VIDEO

Color System

This function allows you to automatically change tint and color coordinates for DTV programs.
 HDTV - High Definition Television - Use for High Vision Signal Y-P_BP_R from HDTV Set-Top Box.
 SDTV/DVD - Standard Definition Television or DVD (Digital Versatile Disc Player) Y-C_BC_R.

- NOTES:**
1. If Color System is set improperly (does not match actual input signal), the color and tint of the main picture will be abnormal.
 2. You must be tuned to VIDEO: 1 or 2 inputs and have a component hooked up to the Y-P_BP_R input jacks to access this color system.
 3. All component color type settings will affect only color component input you are currently viewing. If you are using both sets of component input jacks, be sure to set the color system feature for both inputs.

Advanced Settings

Your HITACHI Projection TV has an ADVANCED SETTINGS function which will automatically adjust picture settings to produce the highest quality picture possible. When ADVANCED SETTINGS is highlighted, press down on THUMB STICK to access an ADVANCED SETTINGS feature.

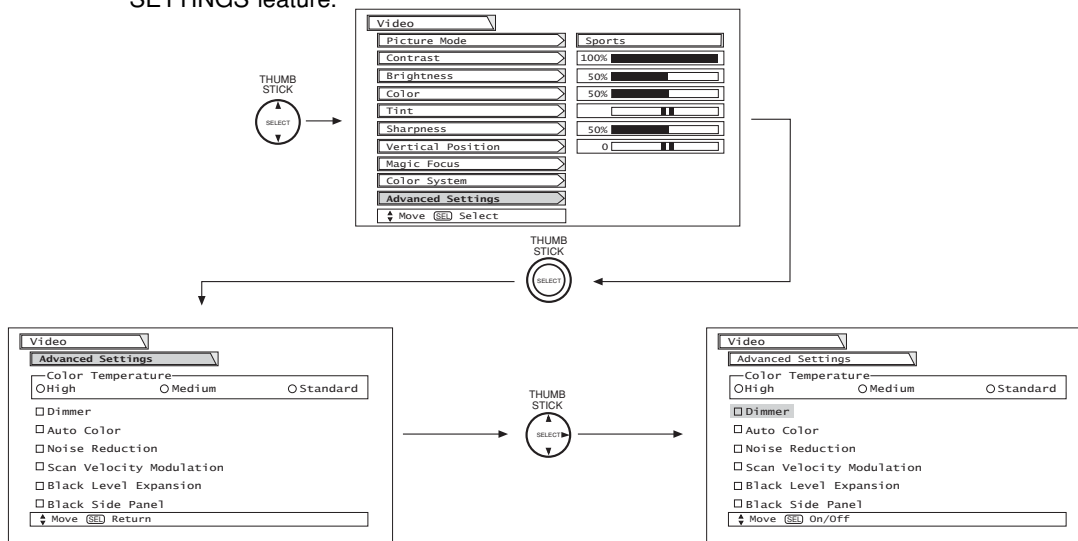

Use THUMB STICK to highlight functions.

Press down on THUMB STICK to select the function setting. When the function has an “✓” in the box, it is ON.

Press down on THUMB STICK to change COLOR TEMPERATURE setting. When the function shows a “⊙”, it is selected.

Press EXIT to quit menu.

Color Temperature

Set this to High for less intense colors with more blue, set to Medium for hot colors with more red, or set to Standard for standard colors.

Dimmer

Turn ON the Dimmer to reduce picture contrast and brightness automatically when viewing in a dark room.

Auto Color

The AUTO COLOR function automatically monitors and adjusts the color to maintain constant color levels even after a program or channel changes. It also maintains natural flesh tones while preserving fidelity of background colors.

Noise Reduction

The NOISE REDUCTION function automatically reduces conspicuous noise in the picture without degrading picture quality. When the Noise Reduction feature is ON, the Sharpness feature is disabled.

Scan Velocity Modulation

The Scan Velocity Modulation function automatically enhances the edges between light and dark areas.

Black Level Expansion

The BLACK LEVEL EXPANSION function automatically enhances shadow detail in dark scenes.

Black Side Panel

The BLACK SIDE PANEL function turns the gray side bars on/off when watching 4:3 signals in Standard mode. The top/bottom gray bar will appear in SPLIT MODE PIP and SPLIT FREEZE.

NOTE: To maximize operating life of the TV's picture tubes when watching 4:3 signal, Black Side Panel is cancelled at Power OFF. It is recommended to watch 4:3 signal with gray side bar.

Audio

Select AUDIO to adjust the TV to your preference and to improve the sound quality.

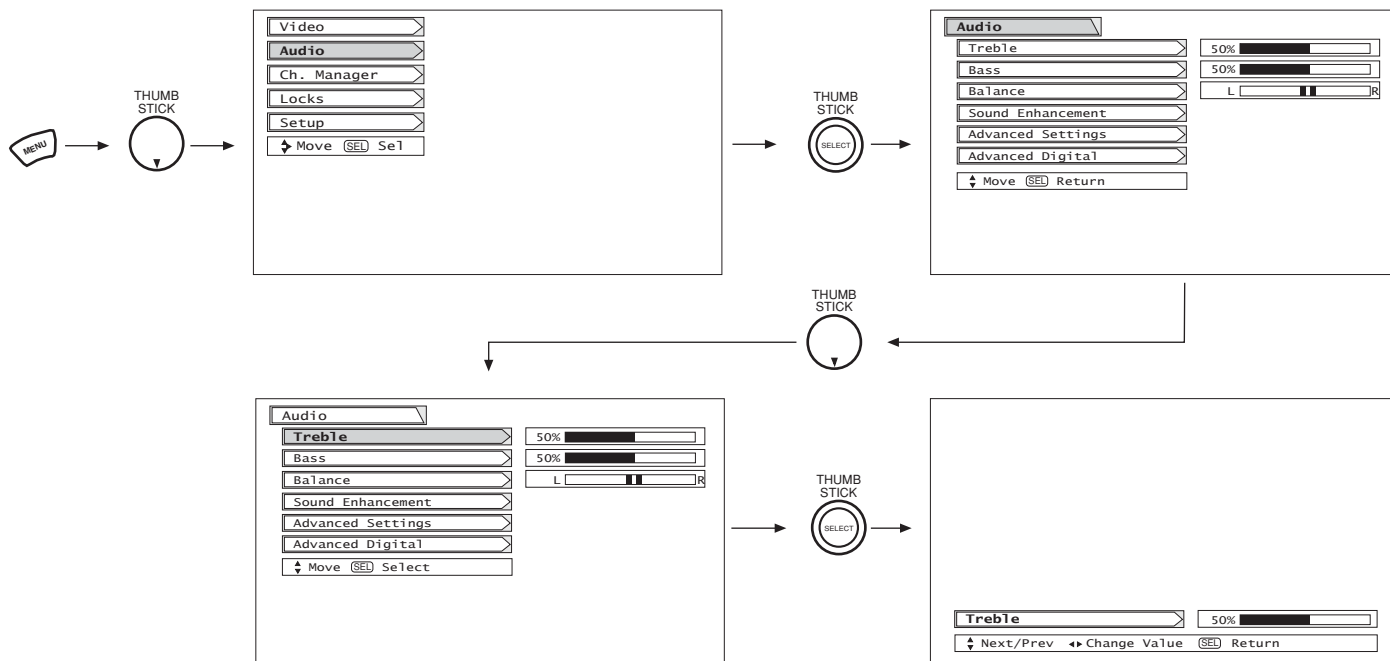

Use THUMB STICK to highlight functions.
 Press down on THUMB STICK to select the function setting.
 Press THUMB STICK ◀ or ▶ to adjust the function.
 Press EXIT to quit MENU, or select Audio to return to the main menu.

NOTE: If TREBLE is selected you are adjusting treble. The additional menu items Bass and Balance can be selected and adjusted in the same manner.

Treble

This function controls the high frequency audio to all speakers.

Bass

This function controls the low frequency audio to all speakers.

Balance

This function will control the left to right balance of the TV internal speakers and the AUDIO TO HI-FI output.

AUDIO

Sound Enhancement

The following surround settings will reproduce the “live” sound you would hear in concert halls, sports stadiums, movie theaters, etc. with only two speakers.

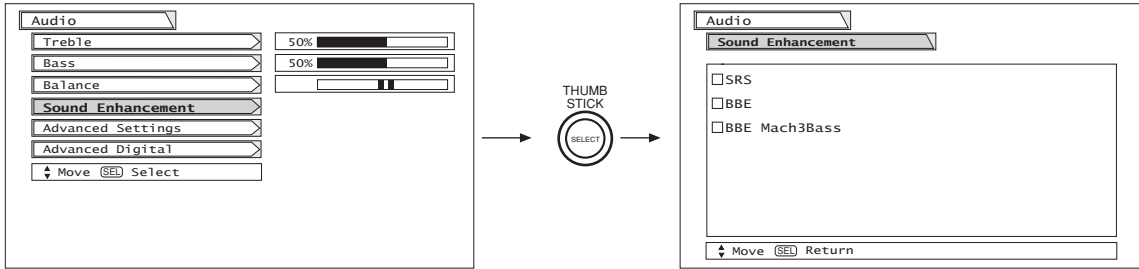

To enter SOUND ENHANCEMENT, use THUMB STICK ▲ or ▼ to highlight then press down on THUMB STICK to select SOUND ENHANCEMENT of your choice.

Use the THUMB STICK to highlight your sound enhancement choice, and press SELECT to select your choice.



Based on the principles of the human hearing system, SRS technology delivers an exciting and realistic 3D Sound experience from just two external speakers (or) the two internal speakers of your HITACHI Television. If your HITACHI Television is connected to an external audio system, SRS will also create an incredible 3D sound experience from two speakers and even enhance a complete multi-speaker surround sound system.

NOTES: *SRS and the  symbol are registered trademarks of SRS Labs, Inc. SRS technology is incorporated under license from SRS Labs, Inc.

BBE Technology

Sound reproduction quality enhancement system. The BBE technology produces sound that is natural and crisp from just two speakers (or) the two internal speakers of your HITACHI television. If your HITACHI television is connected to an external audio system, BBE will also create an incredible crisp sound experience from two speakers and even more complete and accurate reproduction of the original performance. BBE brings to the listener’s ear a more complete and accurate reproduction of the original performance. Each voice, speaking or singing, each instrument or sound effect is presented with its attendant harmonics or partials more clearly audible. The ear can then more easily recognize the unique tonal colors of each sound as though the sound was being produced live.



BBE Mach3Bass provides rich and natural bass sound.

NOTES: Licensed by BBE Sound, Inc. under USP4638258 and 4482866. BBE, BBE Mach3Bass and BBE symbol are registered trademarks of BBE Sound, Inc. Manufactured under license from BBE Sound, Inc.

Advanced Settings

Use **ADVANCED SETTINGS** to improve the sound performance of your TV, depending on listening conditions.

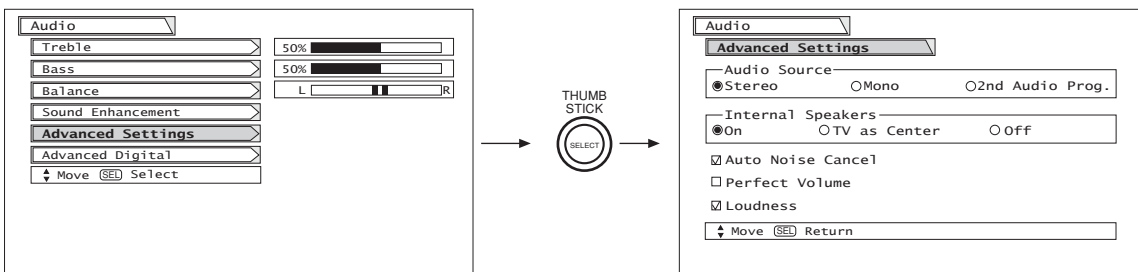

Press THUMB STICK ▲ or ▼ to highlight a function. Press down on THUMB STICK to select the function setting. When the function has a “✓” in the box it is ON.

Audio Source

Multi-Channel Television Sound will allow you to select **STEREO** (a stereo broadcast), **MONO** (monaural sound) used when receiving a weak stereo broadcast or **SAP** (second audio program) which may be a secondary language, weather report, etc.

The mode you select will be displayed at the left edge of the TV. The source received will be displayed above the mode. See example below for each selection when both stereo and second audio are received (monaural is always received).

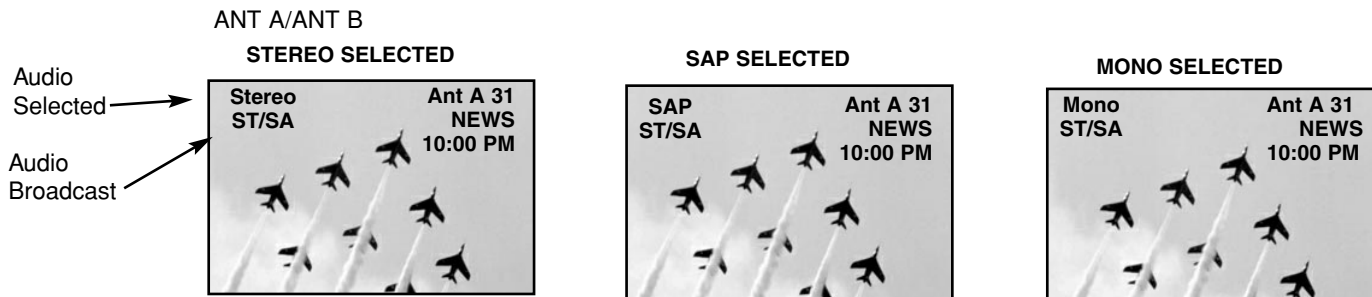

ANT C

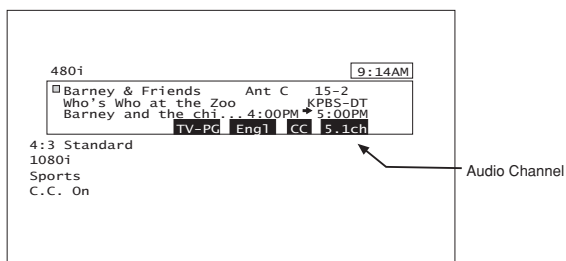

NOTE: ANT C Audio Source availability is dependent on broadcaster.

Internal Speakers

On - Select this feature if using the internal speakers only.

TV as Center - Select this feature when setting up external speakers from a separate stereo system. The TV's speakers will work as the center speaker (see page 14).

Off - Select this feature is you prefer to use only speakers from a separate stereo system.

Auto Noise Cancel

This function eliminates the noise between stations. If a channel is tuned and is noisy, this function will automatically eliminate the audio for that channel.

Perfect Volume

This function will automatically adjust volume so each channel has the same average volume level.

Loudness

This function will improve the quality of both low and high frequency sounds when listening at low volume levels.

AUDIO

Advanced Digital

Use ADVANCED DIGITAL if your TV is connected to an amplifier/receiver with optical digital input with Dolby Digital or PCM decoder capabilities.

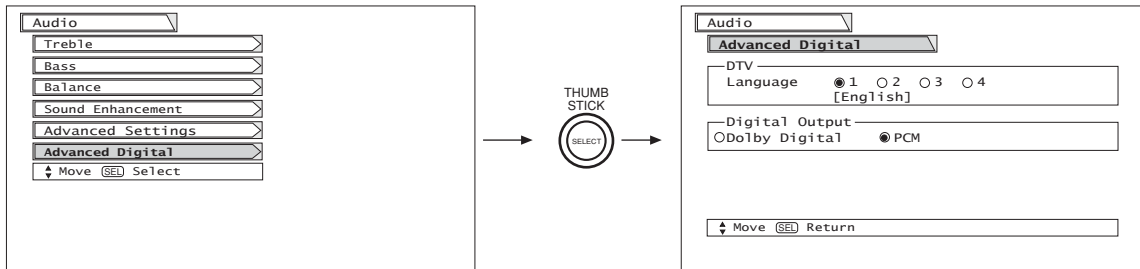

Press THUMB STICK ▲ or ▼ to highlight a function. Press down on THUMBSTICK to select the function setting.

DTV Language

Some programs transmit more than one DTV language option. Most will have English as a default language. DTV language will allow you to select up to 4 language options.

If more than one DTV Language is available, the DTV Language options will be in white. If only one language is available, the DTV Language options will be grayed out.

Digital Output

This function allows you to select between Dolby® Digital and PCM.

Dolby® Digital - Select this feature if the TV is connected to an amplifier/receiver with a Dolby® Digital only decoder; it will provide six independant soundtrack channels through the optical output jack (Digital Audio).

PCM - Select this feature if the TV is connected to an amplifier/receiver with a PCM only decoder; it will provide two independant soundtrack channels through the optical output jack (Digital Audio).

NOTE: *Manufactured under license from Dolby Laboratories. “Dolby” and the double-D symbol are trademarks of Dolby Laboratories.

Channel Manager

This function allows you to review which channels are labeled (CH ID), which have been added to Channel Memory (SCAN), and which are protected by LOCK.

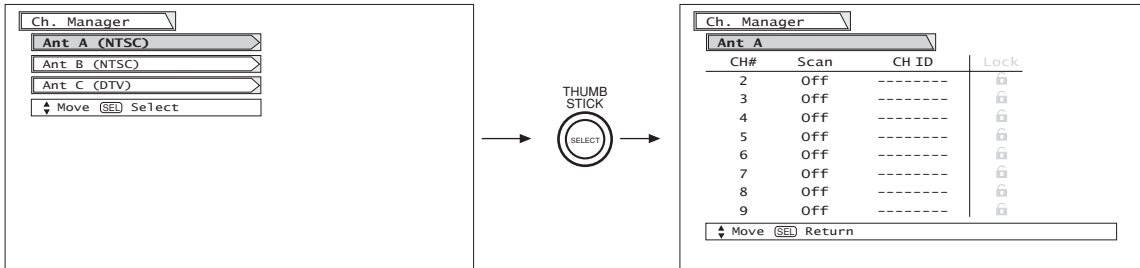

Press THUMB STICK ▲ or ▼ to review more channels.
Press EXIT to quit menu.

Scan

Use this feature after Auto Channel Scan is completed to add (On) or skip (Off) additional channels to the remote control channel ▲ or ▼ buttons.

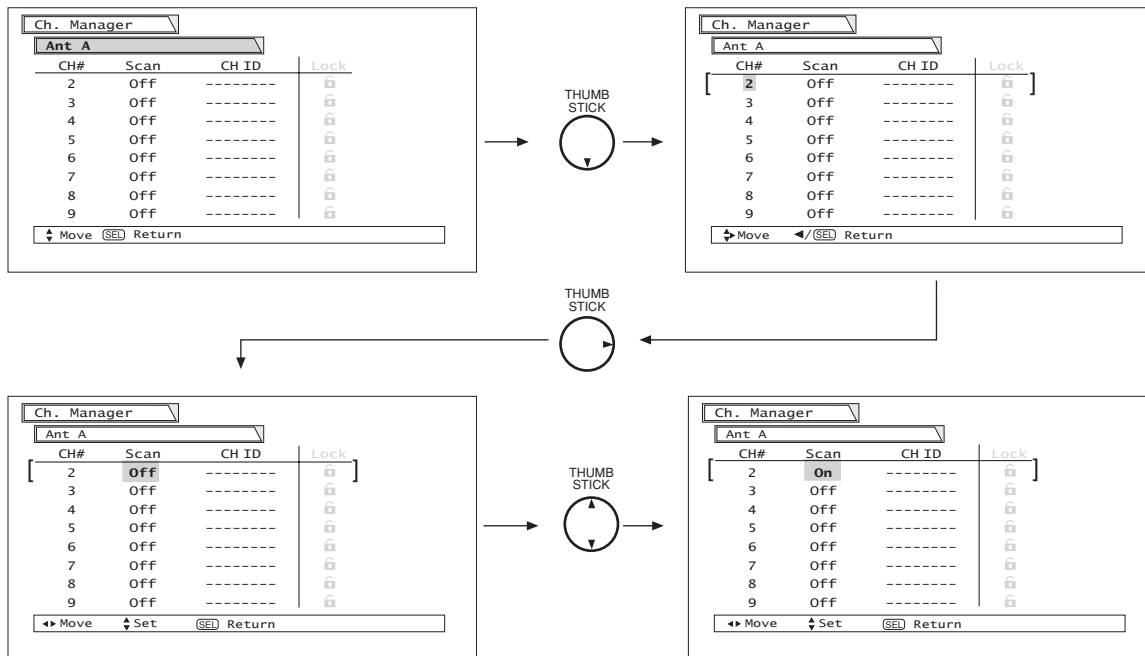

To add (Scan-On) or skip (Scan-Off) additional channels while in Channel Manager, THUMB STICK to highlight the channel number, then THUMB STICK ▲ or ▼ to highlight other channels. Once the desired channel is highlighted, THUMB STICK ► to scan column, then THUMB STICK ▲ or ▼ to select ON or OFF.

NOTE: Lock feature can not be selected or set in CHANNEL MANAGER.

CHANNEL MANAGER

Channel ID

This selection contains advanced features which will make TV viewing easier and more enjoyable. Use this feature to give up to 20 channels a name when ANTENNA signal source is selected and up to 60 channels a name when CATV signal source is selected.

ANT A/ANT B

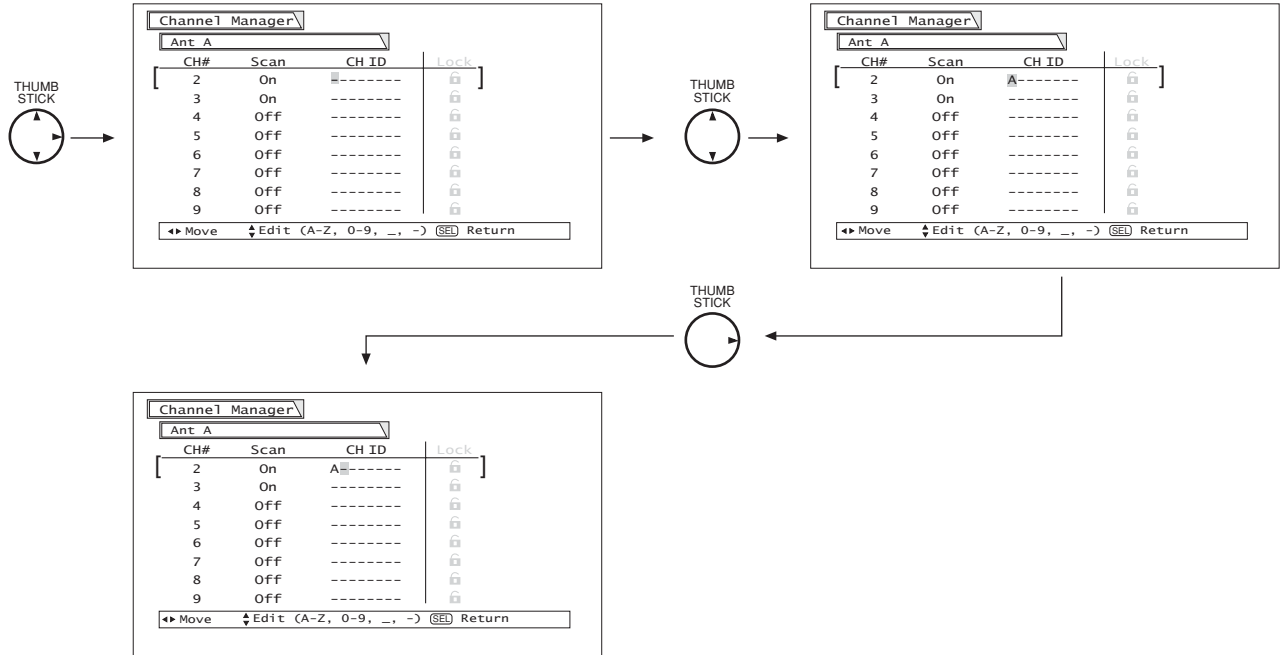

ANT C

Channel Manager			
Ant C (DTV)			
CH#	Scan	CH ID	Lock
8-2	On	KFMB SD	🔒
10-1	On	KGTV-HD	🔒
15-1	On	KPBS-HD	🔒
15-2	On	KPBS-DT	🔒
23-1	On	XETV-DT	🔒
40-1	On	CH1	🔒
8-1	On	KFMB HD	🔒

⬅ Move ⬇ Edit ⏹ Return

- NOTES:**
1. If ANT A and ANT B are in the same ANTENNA/CABLE mode, the CHANNEL ID for both antenna inputs will be the same.
 2. CHANNEL ID will be displayed only when channel is displayed as main picture.
 3. CHANNEL ID in ANT C are automatically set by the channel broadcaster and cannot be changed to your preference.
 4. To get CHANNEL ID in ANT C, Auto Channel Scan must be done first.
 5. ANT C will have no channel listing if there are no available channels.
 6. CHANNEL ID in ANT C will not be displayed when PIP is on.

Locks

This function will block out the picture and sound of the selected channel or video input. It can also be used to keep the TV from being viewed for a scheduled time period that you set.

The code to enter the Locks feature is a four digit secret code number. The factory preset code is 0000. Use the number buttons to select access code.

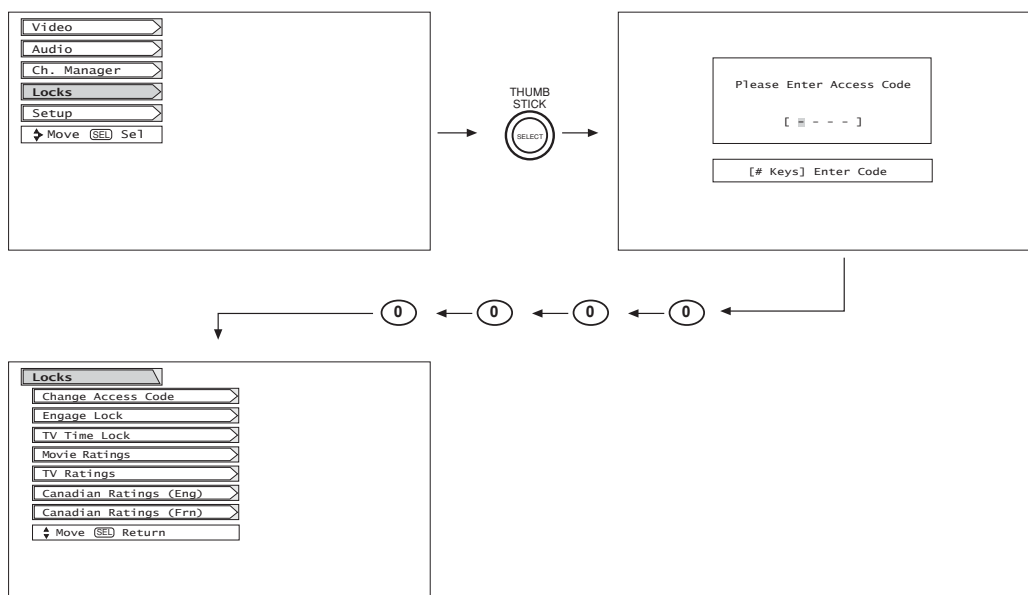

Use THUMB STICK ▲ or ▼ to highlight function and then press SELECT button.

To change the access code number, select Change Access Code. Enter a new four digit key number you prefer.

Select CHANGE ACCESS CODE to change factory preset code (0000) to your preference.

When ENGAGE LOCK is selected, SET CHANNEL LOCK, SET INPUT LOCK, and SET FRONT PANEL LOCK can be set individually.

When SET CHANNEL LOCK is turned on, the picture and sound for the chosen channel will be blocked out.

When SET INPUT LOCK is turned on, the picture and sound for all video inputs and the picture and sound for channels 3, 4 of ANT A/B will be blocked out.

When FRONT PANEL LOCK is turned on, all buttons on the Front Panel will be deactivated, except the Power button.

When TV TIME LOCK is turned on (☑ TIME LOCK) you can set the BEGIN and END times (THUMB STICK ►) and the TV cannot be viewed during that time period (Set clock first). Use CURSOR ▲ or ▼ to highlight ONCE (TV will time out one time only), DAILY (TV will time out every day), WEEKLY - SUN~WEEKLY - MON (TV will time out one time a week) or OFF (to disable this function).

When MOVIE RATINGS is selected, you can block various types of movies and video tapes based on motion picture ratings. Picture-in-Picture will also be blocked automatically (see page 57).

When TV RATINGS is selected, various types of television programming based on a parental guide ratings will be blocked. Picture-in-Picture will also be blocked automatically (see page 58).

Use CANADIAN RATINGS to block various types of movies and television programs based on the two rating systems used in Canada that you feel may be inappropriate due to its content (see pages 59-60).

If you forget your secret code, use the factory code 7777 to erase your key number. This will reset the secret code number back to the factory preset 0000.

Press EXIT to quit the menu.

- NOTE:**
1. If ANT A and ANT B are in the same signal source mode (see page 63), when a channel is locked, it is locked on both antenna inputs.
 2. When using TIME LOCK make sure the clock is set (see page 62).
 3. Text appears on the screen to indicate that TV TIMED LOCK is activated.
 4. If MOVIE/TV Ratings Lock and Closed Caption settings are ON, PIP SURF mode will be deactivated.
 5. The IEEE1394 input will not lock when the SET INPUT LOCK is turned on.
 6. When in ANT C, digital broadcast rating availability will depend on the broadcaster. If rating is available, rating icon will be highlighted (see page 26).

LOCKS

Movie Ratings

Use MOVIE RATINGS to block from showing any movie you feel might have inappropriate content.

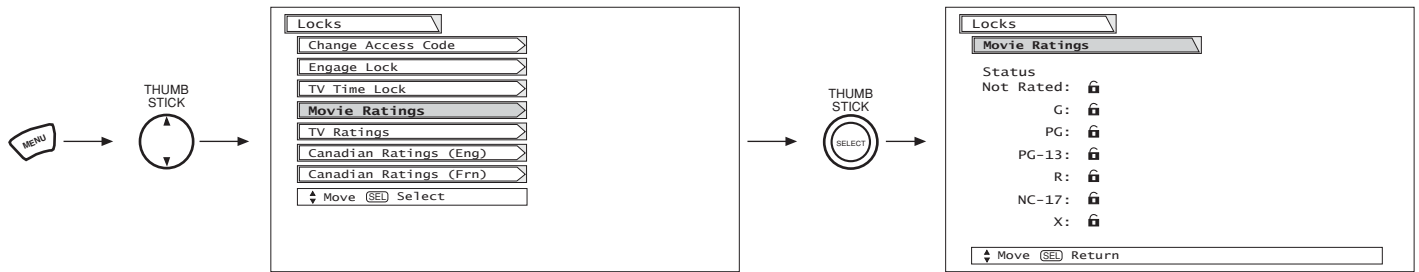

Use THUMB STICK ▲ or ▼ to select the MOVIE RATING category that you want to block.

Press SELECT to block the MOVIE RATING that you have selected. Once rating is selected, for example PG-13, all movies rated PG-13 and higher (R, NC-17, and X) will be blocked.

Press EXIT to quit menu or select MOVIE RATING to return to the previous menu.

Motion Picture Ratings Chart

G	General audiences. All ages admitted.
PG	Parental guidance suggested. Some material may not be suitable for children.
PG-13	Parents strongly cautioned. Some material may be inappropriate for children under 13.
R	Restricted. Under 17 requires accompanying parent or adult guardian.
NC-17	No one 17 and under admitted.
X	Adults only
NOT RATED (NR)	Contains no rating. Not Rated (NR) and Not Applicable (NA) programs. Movie has not been rated or ratings do not apply.

TV Ratings

Use TV RATINGS to block from showing any programs or movies you feel might have inappropriate content.

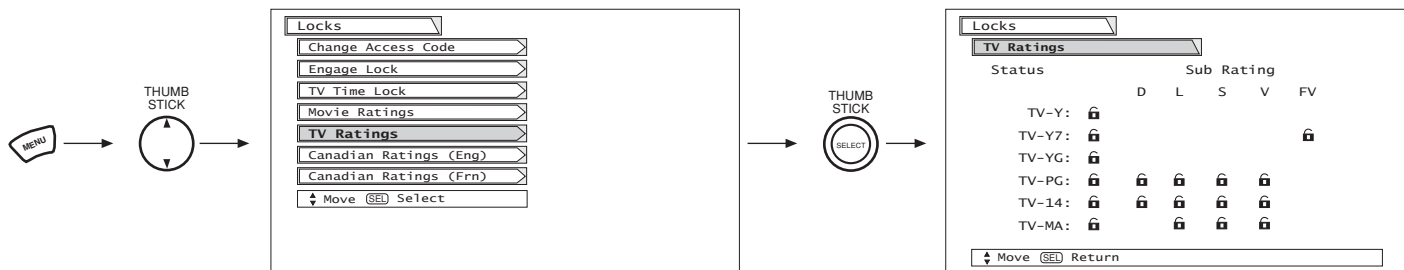

Use THUMB STICK ▲ or ▼ to highlight the category that you want to block. Press select to block the TV RATING that you have selected. Press EXIT to quit menu or select TV RATING to return to the previous menu.

TV Parental Guide Ratings Chart

TV-Y	All children. The themes and elements in this program are specifically designed for a very young audience, including children from ages 2-6.
TV-Y7	Directed to older children. Themes and elements in this program may include mild physical or comedic violence, or may frighten children under the age of 7.
TV-G	General audience. It contains little or no violence, no strong language, and little or no sexual dialogue or situations.
TV-PG	Parental guidance suggested. The program may contain infrequent coarse language, limited violence, some suggestive sexual dialogue and situations.
TV-14	Parents strongly cautioned. This program may contain sophisticated themes, intense sexual situation, more intense violence and intensely suggestive dialogue.
TV-MA	Mature audiences only. This program may contain mature themes, indecent language, graphic violence, and explicit sexual content.
FV	Fantasy Violence
V	Violence
S	Sexual Situation
L	Adult Language
D	Sexually Suggestive Dialogue.

NOTE:

If you Block TV-14D, you will still permit TV-MA programs; If you block TV-14DV, you will automatically block TV-MAV programs, but you will still permit TV-MALS programs. This means that the TV will block violence in TV-14 and higher (TV-MA), but not language and sex.

LOCKS

Canadian Ratings (Eng)

Use Canadian Ratings (Eng) to block any type of movie and television program in Canada that you feel might be inappropriate in its content.

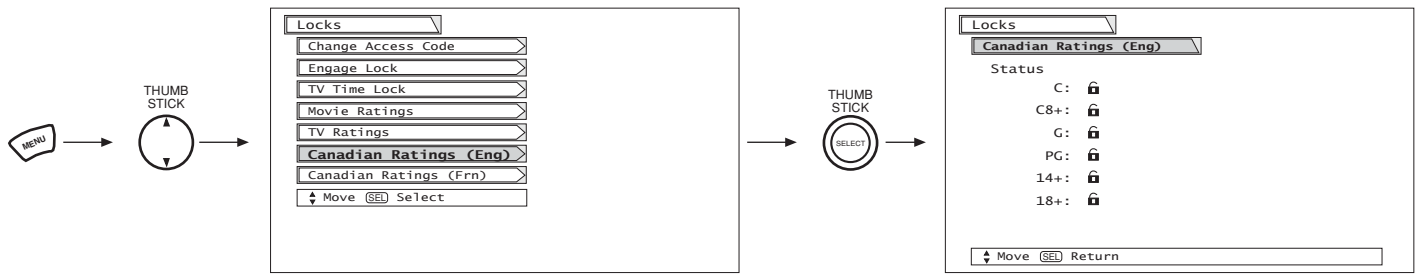

Use THUMB STICK ▲ or ▼ to select the CANADIAN RATINGS (Eng) category that you want to block. Press SELECT to set the CANADIAN RATINGS (Eng) that you have selected. Once rating is selected, for example C8+, all movies and television programs rated C8+ and higher (G, PG, 14+ and 18+) will be blocked automatically. Press EXIT to quit menu.

Canadian Ratings English Chart

C	Programming intended for children under age 8 - Violence Guidelines; Careful attention is paid to themes, which could threaten children's sense of security and well-being. There will be no realistic scenes of violence. Depictions of aggressive behaviour will be infrequent and limited to portrayals that are clearly imaginary, comedic or unrealistic in nature. Other Content Guidelines: There will be no offensive language, nudity or sexual content.
C8+	Programming generally considered acceptable for children 8 years and over to watch on their own - Violence Guidelines: Violence will not be portrayed as the preferred, acceptable, or only way to resolve conflict; or encourage children to imitate dangerous acts which they may see on television. Any realistic depictions of violence will be infrequent, discreet, of low intensity and will show the consequences of the acts. Other Content Guidelines: There will be no profanity, nudity or sexual content.
G	General Audience - Violence Guidelines: Will contain very little violence, either physical or verbal or emotional. Will be sensitive to themes which could frighten a younger child, will not depict realistic scenes of violence which minimize or gloss over the effects of violent acts. Other Content Guidelines: There may be some inoffensive slang, no profanity and no nudity.
PG	Parental Guidance - Programming intended for a general audience but which may not be suitable for younger children. Parents may consider some content inappropriate for unsupervised viewing by children ages 8-13. Violence Guidelines: Depictions of conflict and/or aggression will be limited and moderate; may include physical, fantasy, or supernatural violence. Other Content Guidelines: May contain infrequent mild profanity, or mildly suggestive language. Could also contain brief scenes of nudity.
14+	Programming contains themes or content which may not be suitable for viewers under the age of 14 - Parents are strongly cautioned to exercise discretion in permitting viewing by pre-teens and early teens. Violence Guidelines: May contain intense scenes of violence. Could deal with mature themes and societal issues in a realistic fashion. Other Content Guidelines: May contain scenes of nudity and/or sexual activity. There could be frequent use of profanity.
18+	Adult - Violence Guidelines: May contain violence integral to the development of the plot, character or theme, intended for adult audiences. Other Content Guidelines: May contain graphic language and explicit portrayals of nudity and/or sex.

Canadian Ratings (Frn)

Use CANADIAN RATINGS (FRN) to block Canadian French programs according to various program ratings that you feel might be inappropriate in its content.

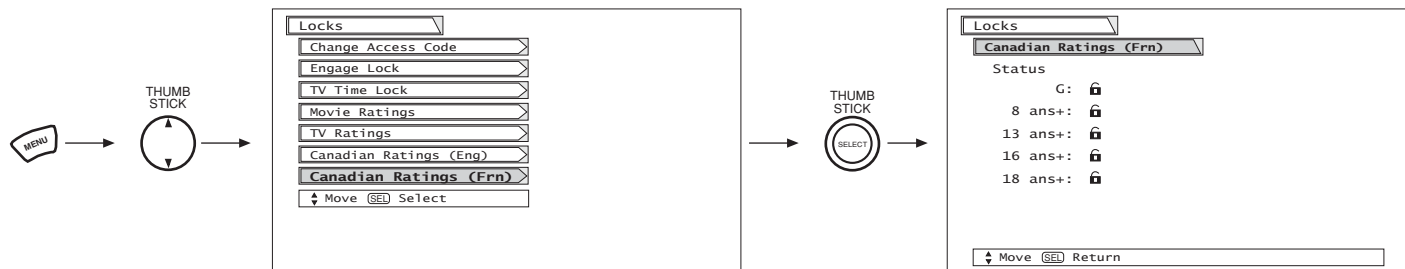

Use THUMB STICK ▲ or ▼ to highlight the category that you want to block. Press SELECT to set the CANADIAN RATINGS (FRN) that you have selected. Once rating is selected, for example 8 ans+, all movies and television programs rated 8 ans+ and higher will be automatically blocked.

Press EXIT to quit menu or select THUMB STICK ◀ to return to the previous menu.

Canadian Ratings French Chart

G	General - Programming intended for audiences of all ages. Contains no violence, or the violence content is minimal or is depicted appropriately with humor or caricature or in an unrealistic manner.
8 ans +	8 + General - Not recommended for young children - Programming intended for a broad audience but contains light or occasional violence that could disturb young children. Viewing with an adult is therefore recommended for young children (under the age of 8) who cannot differentiate between real and imaginary portrayals.
13 ans +	Programming may not be suitable for children under the age of 13 - Contains either a few violent scenes or one or more sufficiently violent scenes to affect them. Viewing with an adult is therefore strongly recommended for children under 13.
16 ans +	Programming is not suitable for children under the age of 16 - Contains frequent scenes of violence or intense violence.
18 ans +	Programming restricted to adults - Contains constant violence or scenes of extreme violence.

SETUP

Setup

Select SETUP when setting your TV up for the first time. Use the THUMB STICK ▲ or ▼ on the remote to highlight the function desired.

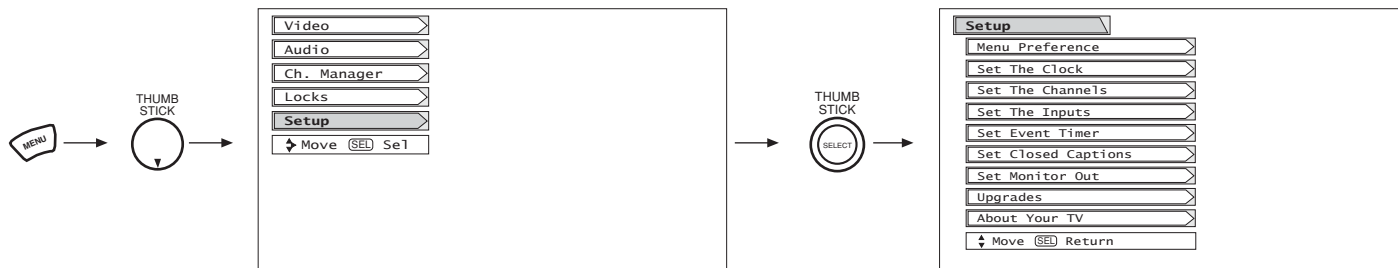

Use THUMB STICK ▲ or ▼ to select the sub-menu of your choice.

Menu Preference

This feature will allow you to select any one of three different languages for all on-screen displays.

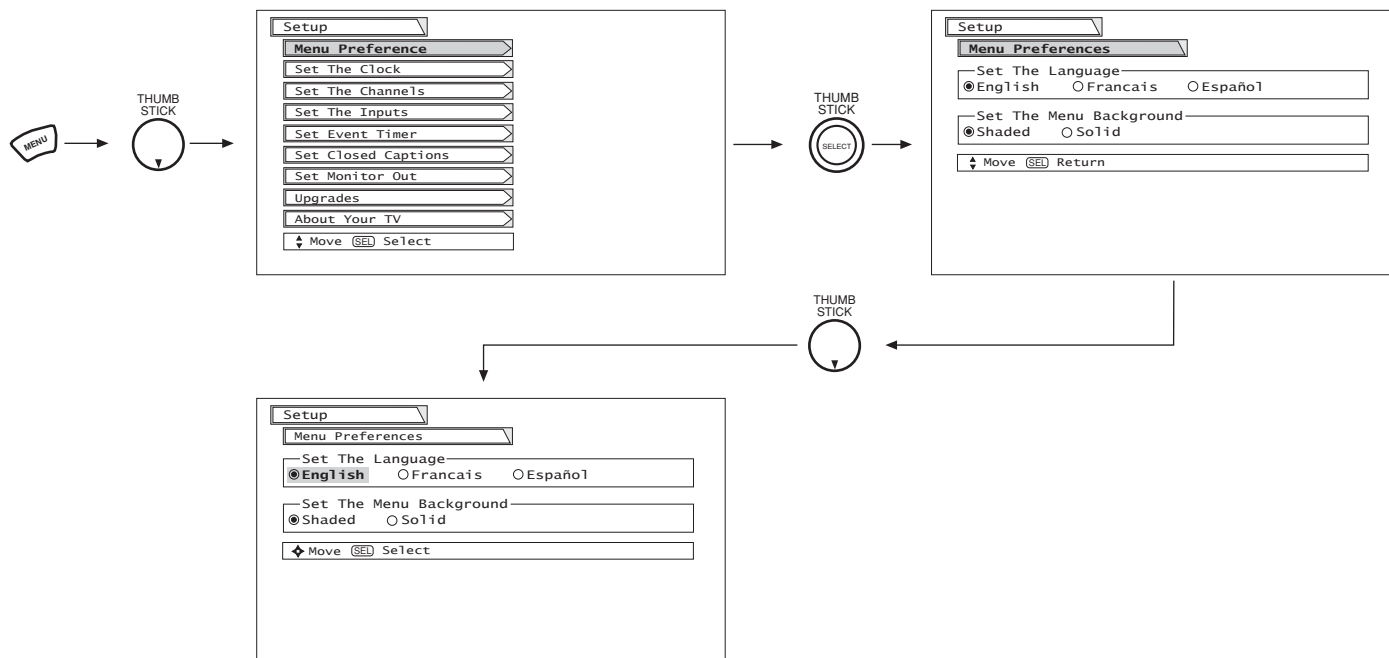

Use THUMB STICK ◀, ▶ to highlight the language of your choice. Press SELECT to select the highlighted language. Press EXIT to quit menu or select MENU PREFERENCE to return to previous menu.

Set The Menu Background

This function allows you to choose from two menu backgrounds.

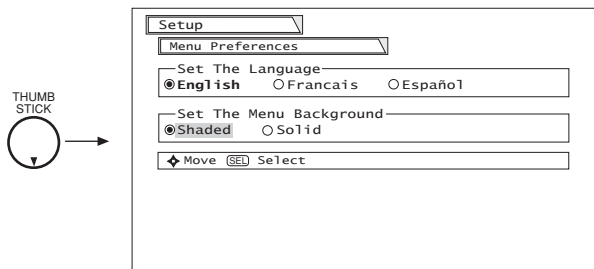

Use THUMB STICK ◀, ▶ to highlight SET THE MENU BACKGROUND (shaded or solid), and press down on THUMB STICK to select setting.

Press EXIT to quit menu or THUMB STICK ◀ to return to previous menu.

Select SOLID for a black background (no picture can be seen behind menu screen), or select SHADED for a light background.

Set The Clock

The time must be adjusted before you can use the “Set Event Timer” or “TV Time Out” features.

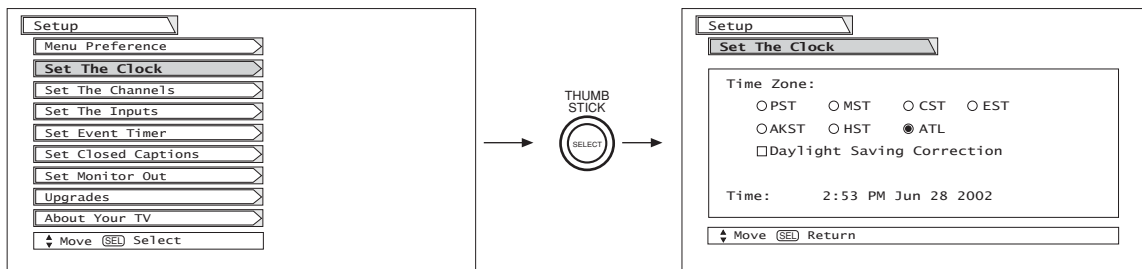

Use THUMBSTICK ▲, ▼, ◀, ▶ to highlight the chosen Time Zone settings.

Press down on THUMBSTICK to select.

If you observe daylight savings, use THUMBSTICK to highlight “Daylight Saving Correction” and press down on THUMBSTICK to select.

Use THUMBSTICK ▲, ▼, ◀, ▶ to highlight the current time (hour and minute), AM or PM, Month, Day, and Year.

Use THUMBSTICK ▲, ▼ to adjust settings.

Press down on THUMBSTICK to set the Time and Date.

Press EXIT to quit menu.

NOTES: When “Daylight Saving Correction” is checked “✓”, the TV will automatically calculate the clock adjustment for Daylight Saving.

SETUP

Set The Channels

For ANT A and ANT B, select ANTENNA if you are using an indoor or outdoor antenna. Select Cable if you have cable TV.

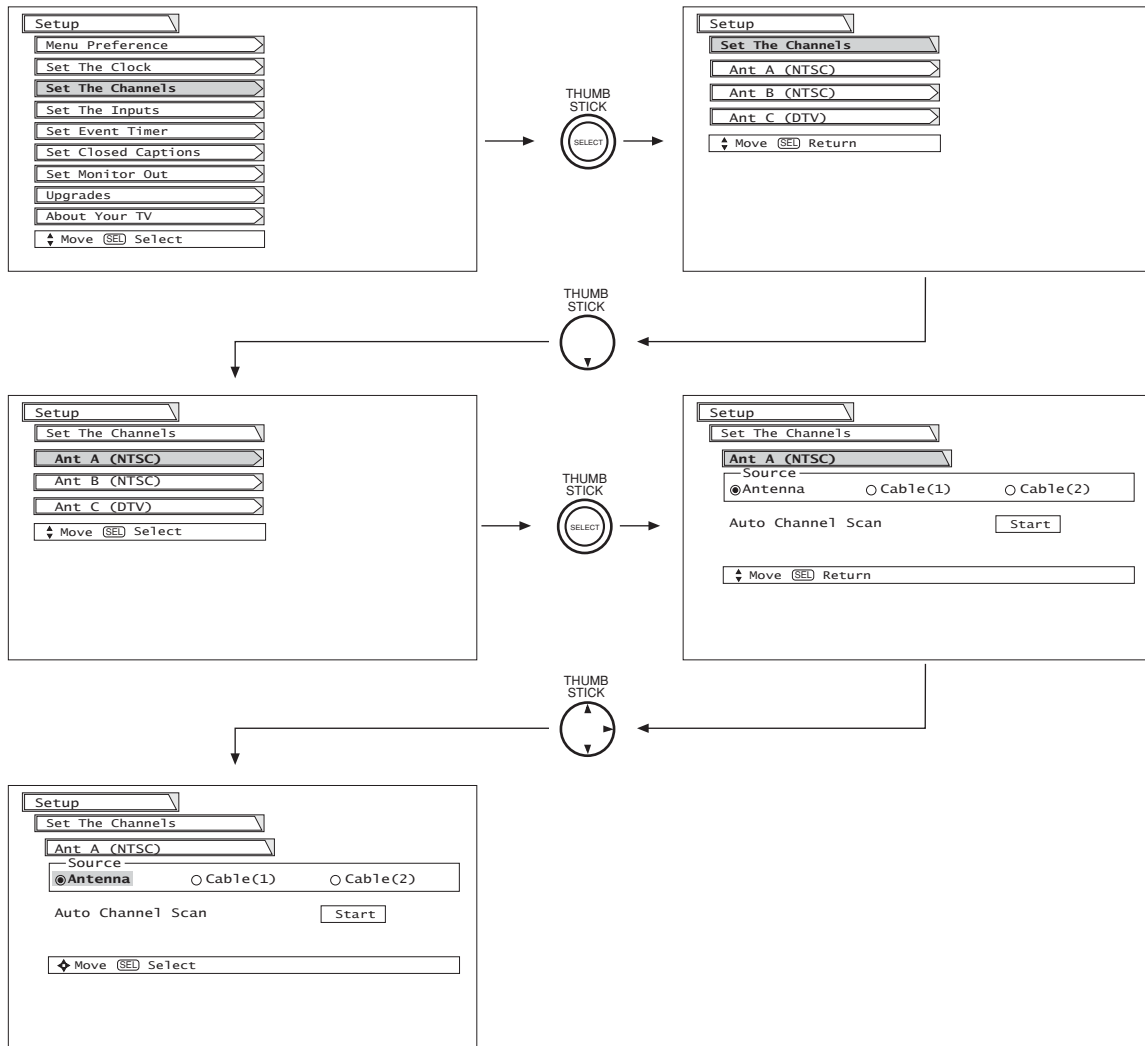

NOTE: If certain CATV channel's picture are poor or unable to be viewed in Cable (1) mode, select Cable (2).

Choose ANT C for digital signals. Select Antenna if you are using an indoor or outdoor antenna to receive your digital signals or select cable if you have digital cable.

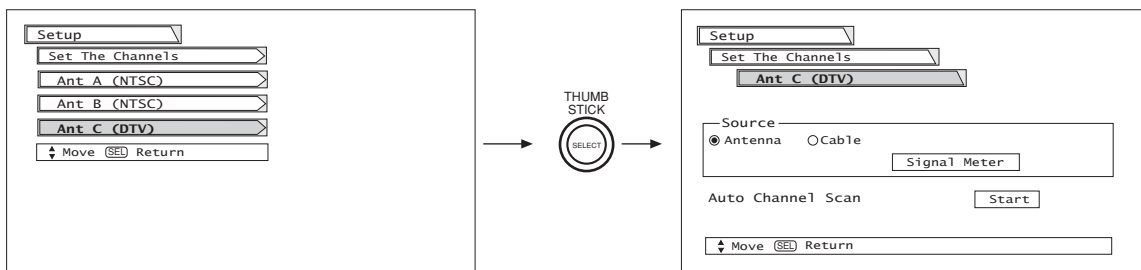

Use THUMB STICK ◀, ▶ to highlight the correct signal source.
 Press down on THUMB STICK to select highlighted signal source.
 Press EXIT to quit MENU or select ANT A, ANT B or ANT C to return to previous menu.

RECEPTION BAND	
AIR	CATV1 or CATV2
VHF 2~13ch UHF 14-69ch	1~125

Reception channels are shown at the left.

Refer to your cable or TV guide for channel identification standards.

Signal Meter

When in ANT C, select Signal Meter when using an indoor or outdoor antenna. This feature will show the signal strength and peak values of the Antenna signal to help you adjust your antenna to optimize signal reception. If Auto Channel Scan is not performed first, you cannot use this feature and the screen below will appear (see page 65).

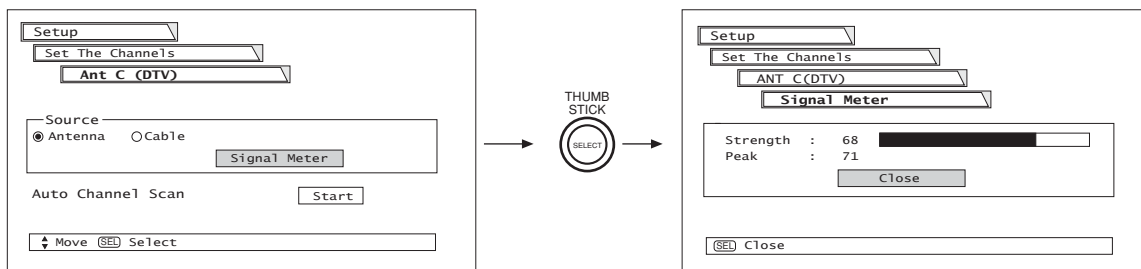
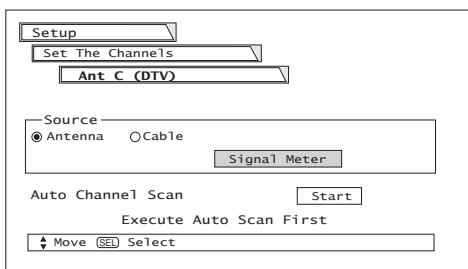

Press down on THUMB STICK to Close or press Exit to quit MENU.

- NOTES:**
1. The signal meter menu will automatically disappear after 30 seconds.
 2. Weak signals will display a black screen (no video, no audio).
 3. Antenna positioning must be accurate for best signal reception.

SETUP

Auto Channel Scan

This feature will automatically store active TV channels in Auto Channel Scan. This will allow you to skip unused channels when using CHANNEL UP (▲) or DOWN (▼).

ANT A/ANT B

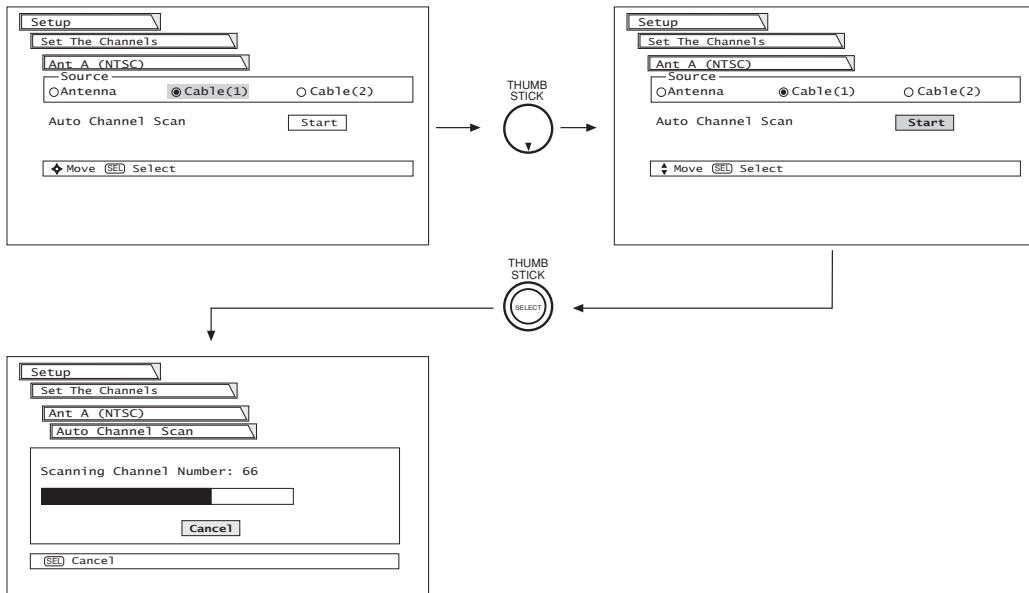

If the EXIT button is pressed while AUTO CHANNEL SCAN function is engaged, programming will stop. If two antenna are connected, switch antenna inputs with the ANT button and repeat AUTO CHANNEL SCAN for the second antenna input.

Remember to select the correct ANTENNA/CABLE mode before using AUTO CHANNEL SCAN. See CHANNEL MANAGER - SCAN to add or to delete additional channels.

ANT C

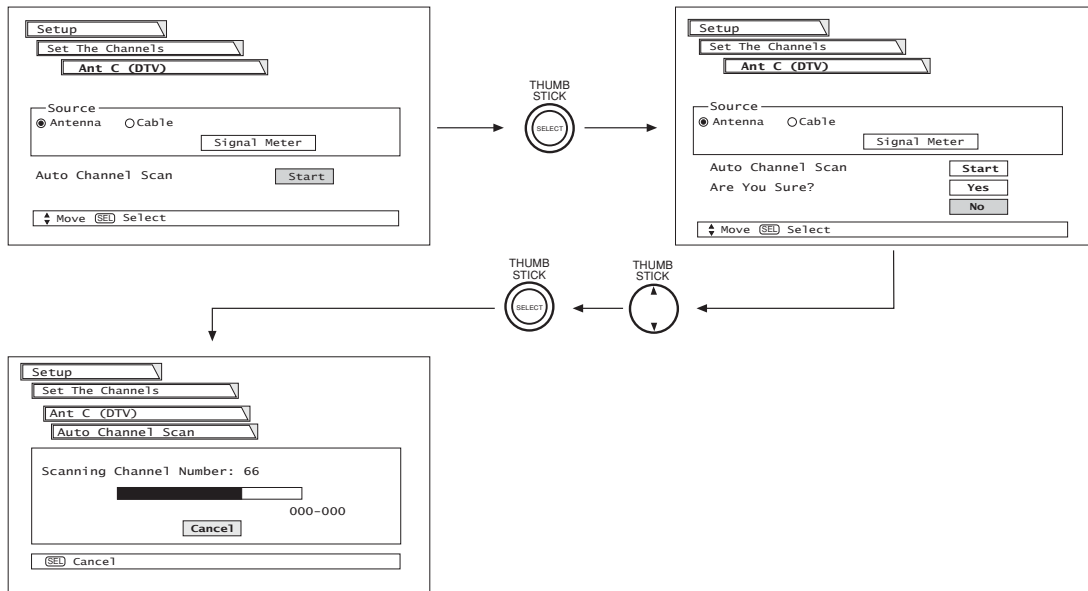

Press down on THUMB STICK to cancel Auto Channel Scan.
Press EXIT to quit menu.

- NOTES:**
1. Auto Channel Scan must be performed first when using ANT C for the first time.
 2. When in ANT C, only channels stored in Channel Manager during Auto Channel Scan can be tuned using the number buttons on the remote control (see pages 54-55, and 65).
 3. When Source-Cable is selected, performing Auto Channel Scan in ANT C will also store scrambled channels in its memory. These channels will be shown as blank on the screen when the channel selector buttons on the remote control are used. Please use CHANNEL MANAGER menu to skip (Scan - Off) these scrambled channels (see page 54).
 4. Turning the power off while executing Auto Channel Scan will only store channels scanned before the power interruption.
 5. If your ANT C source is an antenna, repeat Auto Channel Scan everytime antenna position/direction is changed.
 6. Channel availability in ANT C depends on the broadcaster. Certain channels that are available during the day may not be available at night.

Set The Inputs

Use this feature to give a name to any of the five video inputs.

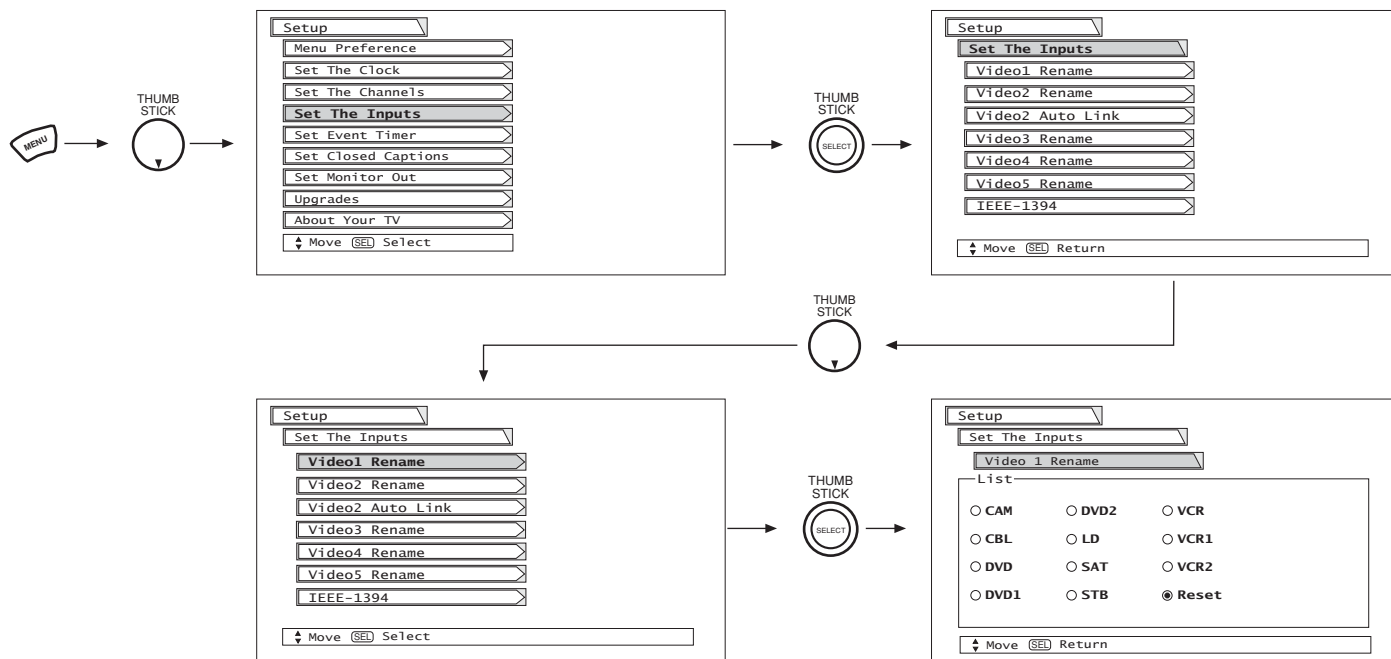

Press THUMB STICK ▲, ▼, ◀, ▶, to highlight the name of the video inputs.
Press down on THUMB STICK to select desired input name.

Select RESET to set video names to original factory preset condition.

SETUP

Video 2 Auto Link

Use this function to automatically turn the TV on and tune to Video2 when it detects a video signal to input 2.

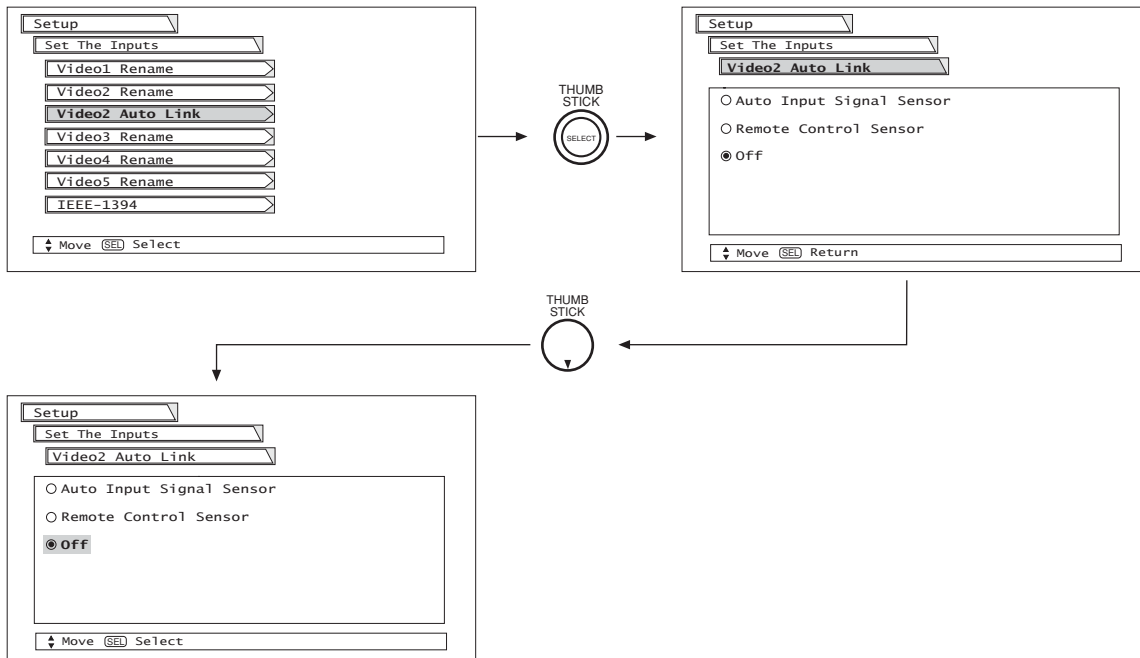

Use THUMB STICK ▲ or ▼, then press down on THUMB STICK to change AUTO LINK setting.

When AUTO INPUT SIGNAL SENSOR is selected, the TV will turn on and tune to Video2 automatically, when the Video2 input device is turned on. This is convenient when you want to watch a movie with your VCR, laserdisc player, or DVD player.

When REMOTE CONTROL SENSOR is selected, the TV will turn on and switch to Video2 automatically when the Video2 input device is turned on and the VCR, laserdisc, or DVD play button on your remote control is pressed. This is convenient when you want to record a movie with your VCR and watch it later.

Select Off to disable this function.
Press EXIT to quit menu.

- NOTES:**
1. Once the TV has been turned on using the AUTO LINK feature, it must be reset before AUTO LINK is used again. To do this, turn your VCR, laserdisc, or DVD player OFF. This feature is now reset and will turn on your TV as described above.
 2. When using REMOTE CONTROL SENSOR mode, any remote control button will substitute for your video input device play button. However, intended operation is for use with your VCR, laserdisc, or DVD play button.
 3. If no remote control button is pressed after the TV is turned on by AUTO LINK, the TV will automatically turn off after three hours.

IEEE-1394

Use this function to control your devices with digital interface capability. To quickly enter the IEEE1394 menu, press the A/V Net button on the remote control twice (2x) while in ANT C mode. To use this function, you need to be tuned to ANT C (see pages 64-65).

(When an IEEE1394 device is not connected)

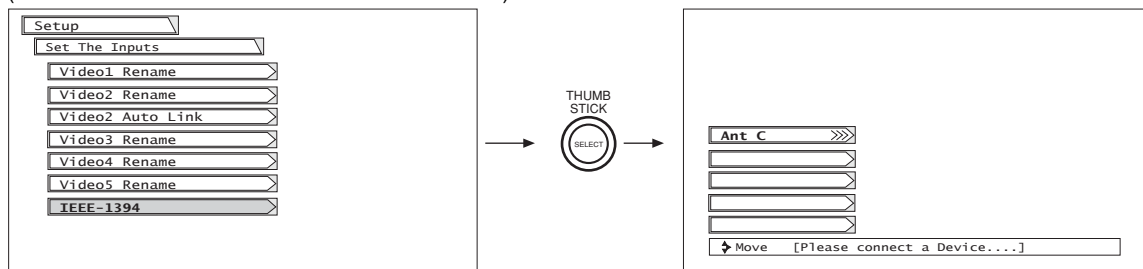

(When an IEEE1394 device is connected)

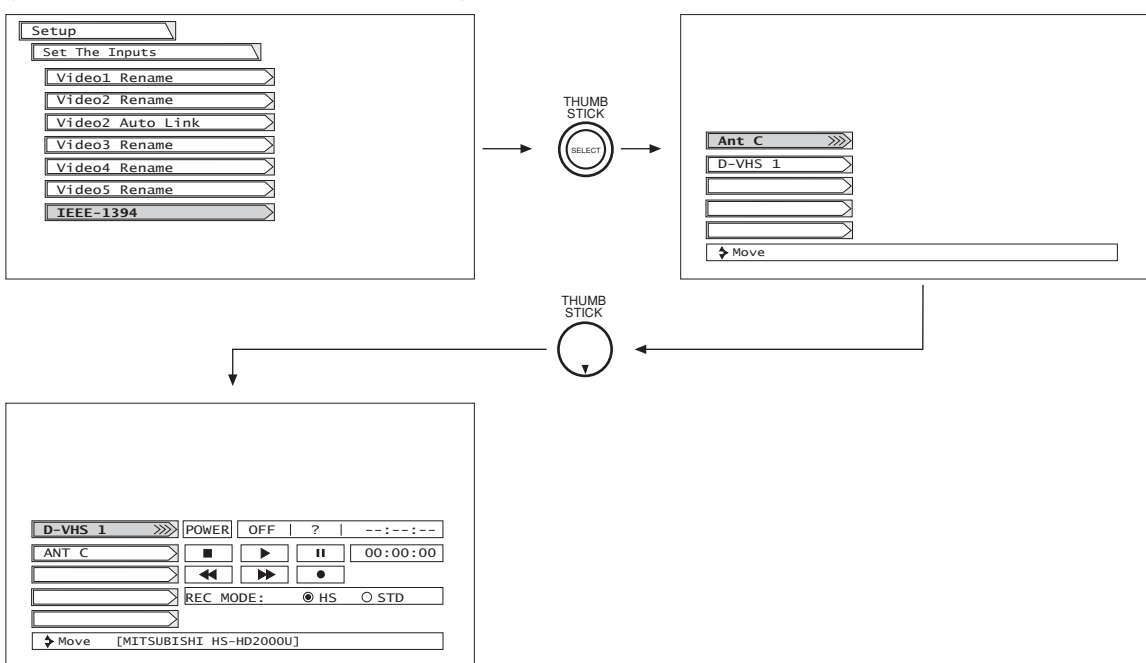

Use THUMB STICK ▼ to select connected devices (example: D-VHS1).

Use THUMB STICK ► to highlight POWER.

Press down on THUMBSTICK to power ON the device.

Use THUMB STICK ▲, ▼, ◀, ▶, to select D-VHS operation.,

Press down on THUMBSTICK to enable the selected operation.

Use THUMBSTICK ▲, ▼ to select Ant C.

Use THUMBSTICK ► to return to Ant C.

- NOTES:**
1. The digital device will be automatically recognized if properly connected. If there is no device connected to the IEEE1394 jacks, the On-Screen-Display will always show a note to connect the devices.
 2. Four (4) IEEE1394 devices can be listed on the menu, but only 1 device at a time can be used. If a fifth device is connected, it will replace the first device on the menu list.
 3. This TV's IEEE1394 connection is not compatible with a DV camcorder (Digital Video Camcorder) or a PC.
 4. This TV's IEEE1394 connection will not support a digital device that goes into a POWER SAVE mode (Sleep mode). Before using a digital device, turn off it's POWER SAVE feature.
 5. The On-Screen-Display will not disappear until the A/V Net button is pressed.
 6. When an IEEE1394 device is disconnected, it will still be shown in the menu but will be grayed out.
 7. Not all devices with IEEE1394 capability are compatible with this TV. Any compatibility problems with other manufacturers devices should be brought to the attention of those manufacturers.

SETUP

Set Event Timer

This function will automatically turn the Projection TV on and off, one time only, every day, or once a week. This Event Timer is only for ANT A/ANT B. To set Event Timer in ANT C, press the GUIDE button on the remote control (see page 31-32).

If the clock is not set, you can not use this function and the screen below will appear in ANT A and ANT B. The message on the screen will disappear after 3 seconds, then the screen automatically goes to the clock setup mode (see page 62).

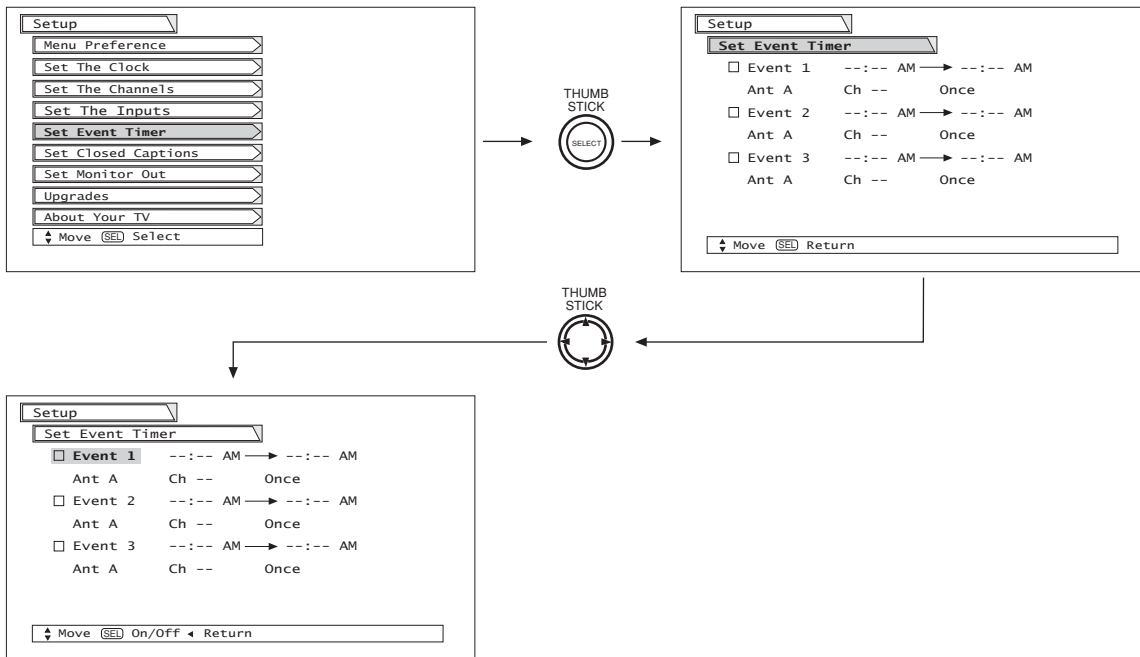
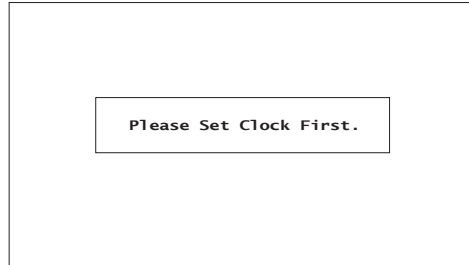

- Use THUMB STICK ▼ to select Event 1, 2 or 3.
- Use THUMB STICK ► to change position of On time, Off time, Antenna, Channel, and On/Off Frequency.
- Use THUMB STICK ▲ or ▼ to select the time the TV will turn on and off.
- Use THUMB STICK ▲ or ▼ to select the day of the week you want the timer to turn on TV.
- Use number buttons to set the channel the TV will tune to when it automatically turns on.
- Use THUMB STICK ▲ or ▼ to select mode Once (TV will turn on/off one time only), Daily (TV will turn on/off at the same time every day), or Weekly-SUN (TV will turn on/off at same time every week).
- Press EXIT to quit the menu.

NOTE:

1. The Off Timer will only activate if the TV was turned on by the On Timer and no channel selection was made after this time. If you change the channel after the On Timer has been activated, the Off Timer will deactivate.
2. If no remote control button is pressed after Event Timer is activated, the TV will automatically turn off after three hours. Therefore, do not Set Event Timer for more than three hours if you do not plan to send a Remote Control I/R to your TV.



CAUTION: Do not use your TV as a deterrent when away from home by using the On and Off Timers. For safety, the TV should be turned off when you are away from home.

Closed Caption

Closed Captions are the dialogue, narration, and/or sound effects of a television program or home video which are displayed on the TV screen. Your local TV program guide denotes these programs as **CC** or .

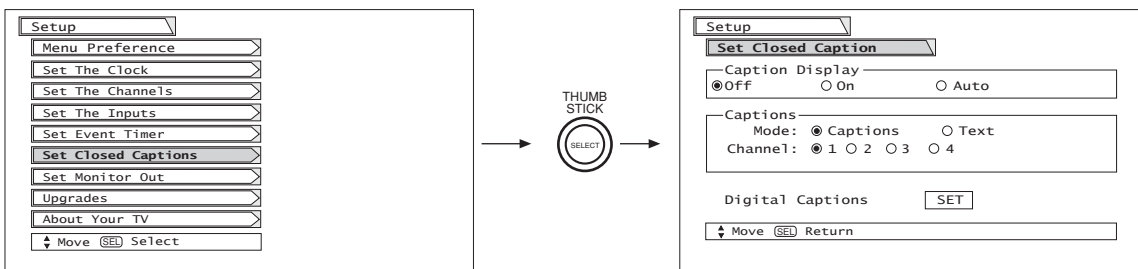

Caption Display: On/Off will turn the **CC** display on or off.

Auto will turn the **CC** display on when Mute/Soft Mute is on.

Caption Mode: **Captions** is for the program you are viewing.

Text is for additional information such as news reports or a TV program guide. This information covers the entire screen and viewing the TV program is not possible. Text may not be available with every **CC** program.

CHANNEL:

- 1 is used for the primary language (usually English).
- 2 is sometimes used for a second language (may vary by region).
- 3 is sometimes used for a third language (may vary by region).
- 4 is sometimes used for a fourth language (may vary by region).

Use THUMB STICK ▲, ▼, ◀, ▶ to highlight the function to change then press down on THUMB STICK to select the function. Press EXIT to quit menu or THUMB STICK ◀ to return to previous menu.

Digital Captions: This feature is only available in ANT C. Set captions for digital programs. This function will help choose and set available language, font, size and style of digital captions.

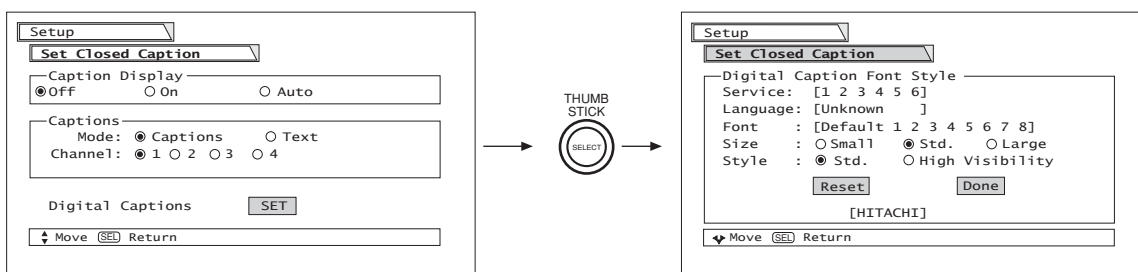

Use THUMB STICK ▲, ▼, ◀, ▶ to highlight desired Digital Captions feature. Press down on THUMB STICK to select desired feature. Select Reset to return to default settings. Select Done to enable new settings. Press EXIT to quit menu or THUMB STICK ◀ to return to previous menu.

- NOTES:**
1. Some types of digital closed captions will not work with this TV.
 2. CAPTION DISPLAY will not work when viewing a 480p, 720p, or 1080i input via the COMPONENT: Y-P_BP_R inputs.
 3. When PIP Surf is on, Closed Caption will not work.
 4. Digital Captions are sometimes different from original style.
 5. Closed Caption and Digital Captions availability and content depends on the broadcaster. Closed Caption is available when Closed Caption icon is highlighted (see page 26).

SETUP

Set Monitor Out This feature will select the source of the Monitor Output.

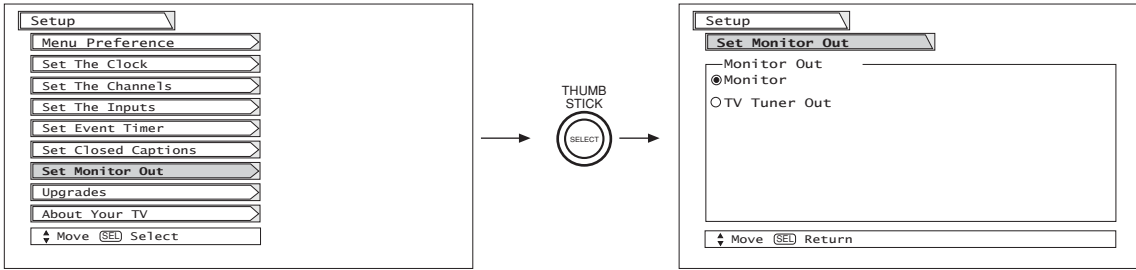

Monitor- Select Monitor to output the audio and video signals of the chosen input source (ANT A, ANT B, VID3-VID5) to a VCR or other A/V device. It will also send digital audio and video signals from ANT C - DTV and IEEE1394 devices that are not copy protected.

TV Tuner Out- Select TV Tuner Out to output the audio and video signals of the last watched Antenna Source (ANT A, AN T B, ANT C).

Use THUMB STICK ▲, ▼ to highlight the function to change then press down on THUMB STICK to select the function. Press EXIT to quit menu or THUMB STICK ◀ to return to previous menu.

Upgrades This function only works in ANT C (Digital Signal). It shows software information and easy upgrade procedure. This function allows the TV software to be upgraded by using a flash card (MMC Card). If a future software upgrade is required for your TV, Hitachi will notify and provide you with a flash card. In order to receive written notification and the flash card, please complete and return the warranty card.

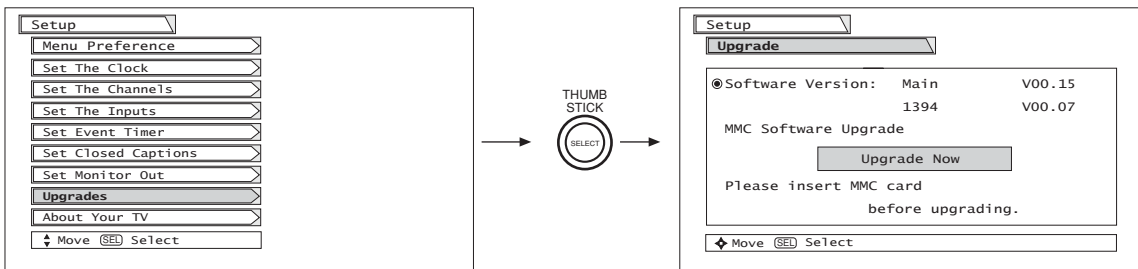

NOTE: Any power interruption during the upgrade process will cancel the upgrade. When this happens, repeat the upgrade procedure.

Insert MMC card, then press THUMB STICK ▲, ▼ to highlight “Upgrade Now”. Press down on THUMBSTICK to select and start upgrading.

About Your TV The TV model name and dimensions will be displayed on the TV screen. The dimensions of each TV model are listed on page 75.

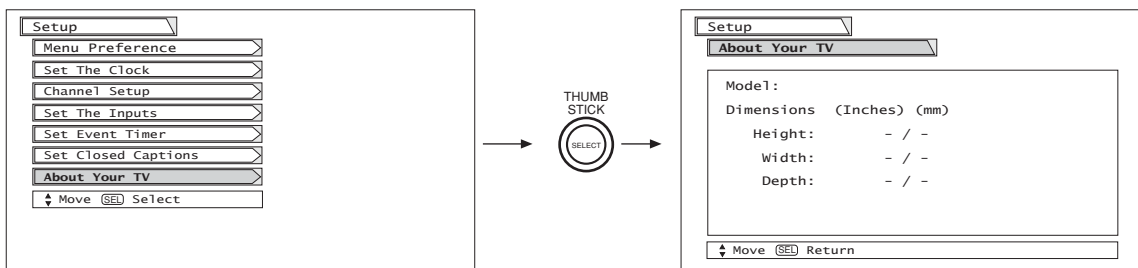



CARE OF YOUR HITACHI TELEVISION AND YOUR REMOTE CONTROL

DO

Dust the screen and cabinet with a soft cloth.

Clean the screen with a soft cloth moistened in warm water and dry with a soft cloth. A mild soap may be used if the screen is extremely dirty.

Place your Television away from extreme heat, humidity, and extremely dusty places.

Remove the plug from the wall outlet if your Television will not be used for a long period of time, for instances, when you go on vacation.

DO NOT

Do not clean your screen or cabinet with strong cleaners, polishes or a chemically treated cloth.

Do not place rubber or vinyl products or cellophane tape on your Television.

Do not touch the screen too often.

Do not subject the remote control to shocks such as dropping it on the floor, etc. Physical damage to the precision parts may result.





Avoid placing the remote control or the Simple Remote Control in a high humidity place or getting it wet. Do not leave it on or near a heater. Excessive heat or moisture may cause the unit to cease operation.

When the batteries run down, remote control operation will become erratic or possibly stop altogether. Replace the old batteries with two new "AA" or "AAA" size batteries as soon as possible to preserve the remote control precodes that were set for the devices. Pressing a remote control button with a "DEAD" battery might erase all precodes in memory. Do not use an old battery with a new battery.

Exposure of the viewing screen to prolonged direct sunlight or heat may cause the screen to permanently warp, resulting in a distorted picture.

RECEPTION PROBLEMS

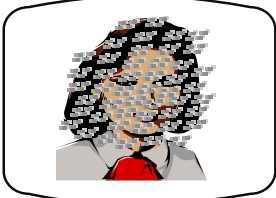
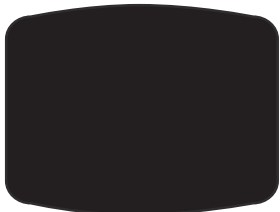

	<ul style="list-style-type: none"> • IGNITION NOISE: Black spots or horizontal streaks may appear, picture may flutter or drift. Usually caused by interference from automobile ignition systems, neon lamps, electrical drills, and other electrical appliances.
	<ul style="list-style-type: none"> • GHOSTS: Ghosts are caused by the television signal following two paths. One is the direct path and the other is reflected from tall buildings, hills or some other objects. Changing the direction or position of the antenna may improve reception. Ghosting may also be caused by defects in the antenna system such as unshielded leads or connecting several sets to the same antenna without using multiple antenna couplers.
	<ul style="list-style-type: none"> • SNOW: If your receiver is located in the fringe area of a television station where the signal is weak, your picture may be marred by the appearance of small dots. When the signal is extremely weak, it may be necessary to install a special antenna to improve the picture.
	<ul style="list-style-type: none"> • RADIO FREQUENCY INTERFERENCE: The interference produces moving ripples or diagonal streaks, and in some cases, causes loss of contrast in the picture.
	<ul style="list-style-type: none"> • BLOCK NOISE (Ant C Input): Fuzzy blocks may appear in some area or the whole area of the screen. This is usually caused by interference from automobile ignition systems, neon lamps, electrical drills, ghosting of the image and weak signals.
	<ul style="list-style-type: none"> • BLACK SCREEN (ANT C Input): When using an antenna, weak signals will display a black screen. It may be necessary to upgrade your antenna.

NOTE: The TV set can generate sound distortion in external devices such as a radio. Please separate radio equipment from the TV set to a considerable distance.



SYMPTOMS	CHECK THESE ITEMS AND TRY THESE ADJUSTMENTS											
	Be sure external connection is correct	Be sure power cord is plugged in	Be sure TV is switched "ON"	Try another channel (station trouble)	Check antenna connections (back of TV)	Check outside antenna	Check for local interference	Adjust Contrast control	Adjust Brightness control	Adjust Color control	Adjust Tint control	Adjust Volume control
No Picture, no sound	●	●	●	●	●	●	●					
Sound OK, picture poor	●			●	●	●	●	●	●			
Picture OK, sound poor	●			●	●	●	●	●				●
Picture blurred	●			●	●	●	●	●				
Lines or streaks in picture				●	●	●	●	●				
Poor reception on some channels				●	●	●	●	●				
Picture rolls vertically				●				●				
No color	●			●	●	●	●			●		
Poor color	●			●	●	●	●			●	●	

HITACHI Projection Television incorporates advanced power surge protection technology designed to protect against component or circuit damage due to external or internal voltage power surges.

IF YOUR TELEVISION SHOULD APPEAR TO HAVE A LOSS OF POWER, PLEASE FOLLOW THIS PROCEDURE:

1. Press the power switch (ON/OFF switch) once.
2. If there is still no power, wait 30 seconds and press the power switch again.
3. If there is still no power, unplug the power cord from the wall. Wait 30 seconds and plug the power cord back in. Press the power switch again.

This protective technology should provide for years of lasting entertainment from your HITACHI Projection Television.



USEFUL INFO

Features:

- Superfine Picture Quality
1280 Line Horizontal Resolution
- Remote (Controls many VCR brands, cable boxes, satellite boxes, and other audio equipment.)
- Extra Simple Remote for easy basic operations.
- New Easy-to-Use (3-Language) On-Screen Menu
- New A/V Network Infra-Red (IR) System
Control up to 4 components with one remote. (2 IR Mouse cables included.)
- Full Set of Input Jacks, including S-VIDEO
- COMPONENT VIDEO: Y-P_B/P_R
- Velocity Modulation
- Six Aspect Modes
- Closed Caption Decoder
- 3-Tuner Picture in Picture
- Magic Focus (Auto Digital Convergence and Manual Adjustment)
- 3 Antenna Inputs (2-NTSC; 1-ATSC)
- Video Input Sensor
- 2 IEEE1394/5C Interface
- Digital Audio Output (Dolby® Digital and PCM)
- 3 Dimensional Y/C Comb Filter
- Full 1080i HDTV capable.
- DVI with HDCP (High bandwidth Digital Content Protection V1.0 compatible).
- **BBE** Technology.
- **BBE Mach3Bass** Technology.
- **SRS** by **SRS** Technology.
- **DOLBY DIGITAL** Technology.

*SRS and the  symbol are registered trademarks of SRS Labs, Inc. SRS technology is incorporated under license from SRS Labs, Inc.

*Licensed by BBE Sound, Inc. under USP4638258 and 4482866. BBE, BBE Mach3Bass and BBE symbol are registered trademarks of BBE Sound, Inc. Manufactured under license from BBE Sound, Inc.

*Manufactured under license from Dolby Laboratories. "Dolby" and the double-D symbol are trademarks of Dolby Laboratories.

Inputs:

- Power InputAC 120V, 60Hz
- Stand-by Power6.5W
- Power Consumption
- Refer to rear panel at the back of the T.V.
- Antenna input impedance75 Ohm
- Channel coverage181ch.
VHF-Band2 ~ 13
UHF-Band14 ~ 69
CATV Mid BandA-5 ~ A-1
.A-I
Super BandJ-W
Hyper BandW+1 - W+28
Ultra BandW+29 - W+84
- Video1.0Vp-p, 75 Ohm
- S-Video
Luminance (Y)1.0Vp-p, 75 Ohm
Chrominance (C)0.286Vp-p, 75 Ohm
- Component Video
Luminance (Y)1.0Vp-p, 75 Ohm
Chrominance (P_B/P_R)0.7Vp-p, 75 Ohm
- Audio input Impedence47k Ohm
- Average input level470mVrms
- DVI - HDTVDVI 25pin
- IEEE13944 pin

Outputs:

- Video1.0Vp-p, 75 Ohm
- Audio (Fixed)470mVrms, 1k Ohm
- S-Video
Luminance (Y)1.0Vp-p, 75 Ohm
Chrominance (C)0.286Vp-p, 75 Ohm
- Optical Out (Digital Audio)
.1 optical connector

Dimensions:

	51XWX20B	57XWX20B	65XWX20B
• Height (in.) (mm)	50 1/8 1,273.5	54 3/16 1,376.2	59 7/8 1,520.7
• Width (in.) (mm)	48 12/16 1,239.0	54 1,372.0	61 1,549.0
• Depth (in.) (mm)	25 1/16 636.0	25 8/16 647.9	28 710.7
• Weight (lbs.)	238	265	319

NOTE: Due to improvements, specifications in this operating guide are subject to change without notice.



HITACHI

*Service
hotline*

To locate an authorized
HITACHI service facility
in the continental U.S.A.
and Canada,

DIAL TOLL FREE

7 days a week, 24 hours a day

800 HITACHI

(1-800-448-2244)

Hitachi America, LTD. Home Electronics Division

Hitachi has made every effort to assure you hours of trouble free operation from your unit. However, should you require service, a network of Hitachi Authorized Service Facilities has been established in all 50 states and Puerto Rico. Each facility will provide you with convenient and expedient assistance. Our service hotline operator will direct you to the Hitachi Authorized Service Facility nearest you. Just present proof of purchase and/or delivery receipts to the Hitachi Authorized Service Facility, and service will be rendered in accordance with the terms of the limited warranty as stated on your warranty card or operating guide.

Should you have any questions regarding warranty, service, operation, or technical assistance, please contact:

**Hitachi America, LTD.
Home Electronics Division
1855 Dornoch Court
San Diego, CA 92154**

USEFUL INFO



Hitachi Canada, LTD. Digital Media Division

Should you have any questions regarding warranty, service, operation, or technical assistance, please contact:

**In Canada:
1-800-HITACHI
(1-800-448-2244)**

**Monday - Friday EST 9:00am - 7:00pm
Saturday EST 9:00am - 5:00pm**

*Look for your French Manual on the outside of the box.
If the manual is missing, call*

**1-800-HITACHI
(1-800-448-2244)**

for a copy.

Pour de plus amples renseignements sur le service durant la période couverte par la garantie, sur le fonctionnement ou pour de l'assistance technique communiquez avec:

**Au Canada:
1-800-HITACHI
(1-800-448-2244)**

**Lundi - Vendredi L'EST 9:00am - 7:00pm
Samedi L'EST 9:00am - 5:00pm**

*La version français de votre manual se trouve a l'exterieur de la boîte.
Si le manuel est manquant, coposez le*

**1-800-HITACHI
(1-800-448-2244)**

pour obenir votre copie.

**HITACHI CANADA, LTD.
6740 Campobello Road
Mississauga, ON L5N 2L8**



INDEX

A

- Accessories, 4
- Antennas (Connecting), 5, 6
- Aspect Ratio, 28
- Audio (Advanced Digital)
 - DTV Language, 53
 - Optical Output, 53
 - Dolby Digital, 53
- Audio (Sound Enhancement)
 - SRS, 51
 - BBE, 51
 - BBE Mach3 Bass, 51
- Audio Settings, 50 - 53
- Audio Source, 52
- Audio/Video Network (A/V Net), 21 - 23, 27, 41
- Auto Color, 49
- Auto Noise Cancel, 52

B

- Balance, 50
- Bass, 50
- Black Level Expansion, 49
- Black Side Panel, 49
- Brightness, 46

C

- Channel Manager, 54 - 55
- Channel Setup, 63
 - Auto Channel Scan, 65 - 66

- Clock
 - Time, 62
 - Time Zone, 62
 - Date, 62
- Closed Captions
 - Analog Captions, 70
 - Digital Captions, 70
- Color System, 49
- Color Temperature, 49
- Color, 46
- Contrast, 46
- Convergence (see Magic Focus)

D

- Date, 62
- Daylight Saving Correction, 62
- Dimmer, 49
- DVI-HDTV, 10, 12, 18

E

- Event Timer
 - ANT A/B, 69
 - ANT C, 31 - 32

G

- Guide button on remote, 31 - 32

I

- IEEE1394, 6, 10, 12, 20, 68
- Input Setup, 66
- IR Blaster, 10, 21



L

Language

- Menu Language, 61
- DTV Language, 53

Locks

- Change Access Code, 56
- Channel Lock, 56
- Input Lock, 56
- Front Panel Lock, 56
- TV Time Lock, 56
- Movie Ratings, 57

- TV Ratings, 58
- TV Ratings (Canadian - English), 59
- TV Ratings (Canadian - French), 60

Loudness, 52

M

Magic Focus

- Auto Convergence, 7, 47
- Manual Convergence, 48

Menu Preference

- Language, 61
- Background, 61

Monitor Out, 9, 71

N

Noise Reduction, 49

P

- Perfect Volume, 52
- Picture Mode, 45

- Picture-in-Picture (PIP), 33 - 35
- Picture-outside-Picture (POP), 33

R

Remote Control

- Simple Remote, 41
- Functions, 24 - 35
- Programming Codes, 36 - 40
- Installing Batteries, 4

S

- Scan Velocity Modulation, 49
- Sharpness, 46
- Sound Enhancement, 51

Speakers, 52

- Connecting External Speakers, 5, 13 - 14

T

- Time, 62
- Tint, 46
- Treble, 50

U

Upgrades, 10, 71

V

- Vertical Position, 46
- Video Settings, 45 - 49
- Virtual HD, 29

HITACHI

Free Manuals Download Website

<http://myh66.com>

<http://usermanuals.us>

<http://www.somanuals.com>

<http://www.4manuals.cc>

<http://www.manual-lib.com>

<http://www.404manual.com>

<http://www.luxmanual.com>

<http://aubethermostatmanual.com>

Golf course search by state

<http://golfingnear.com>

Email search by domain

<http://emailbydomain.com>

Auto manuals search

<http://auto.somanuals.com>

TV manuals search

<http://tv.somanuals.com>