

TABLE OF CONTENTS

HITACHI

PROJECTION COLOR TV

46UX24B/25K

60SX12B/13K

50UX26B/27K

50SX8B

OPERATING GUIDE

TABLE OF CONTENTS

TABLE OF CONTENTS	2
IMPORTANT.....	3
SAFETY TIPS.....	5
PICTURE CAUTIONS	10
ACCESSORIES	11
REMOTE CONTROL BATTERY INSTALLATION AND REPLACEMENT	11
HOW TO SET UP YOUR NEW HITACHI PROJECTION TV.....	12
HOOK-UP CABLES AND CONNECTORS	14
ANTENNA CONNECTIONS TO REAR JACK PANEL.....	14
FRONT PANEL CONTROLS.....	16
MENU/EXIT BUTTON	16
INPUT selector.....	16
VOLUME level	16
FRONT PANEL JACKS AND CONNECTIONS.....	18
REAR PANEL JACKS	19
REAR PANEL CONNECTIONS	21
REAR SPEAKER TERMINAL CONNECTION.....	22
TIPS ON REAR PANEL CONNECTIONS.....	23
AUDIO SYSTEM SETUP.....	24
THE GENIUS REMOTE CONTROL (CLU-952MP)	25
MULTI-PAGE WINDOWS.....	26
HOW TO USE THE GENIUS REMOTE TO CONTROL YOUR TV.....	27
PICTURE-IN-PICTURE (PIP)	30
USING THE REMOTE TO CONTROL VCR FUNCTIONS.....	35
USING THE REMOTE TO CONTROL CABLE BOX/SATELLITE FUNCTIONS	36
USING THE REMOTE TO CONTROL AUDIO EQUIPMENT FUNCTIONS.....	37
AUDIO, CABLE/SATELLITE, AND VCR CODES.....	38
ULTRATEC OSD	46
INITIAL SETUP.....	49
CUSTOMIZE.....	57
VIDEO SETTINGS.....	65
AUDIO SETTINGS	67
HOME THEATER.....	70
INFO. CENTER.....	74
CARE OF YOUR HITACHI PROJECTION TV AND YOUR REMOTE CONTROL.....	77
RECEPTION PROBLEMS.....	78
CHECK HERE BEFORE CALLING FOR SERVICE.....	79
SPECIFICATIONS	80

IMPORTANT

Follow all warnings and instructions marked on this television receiver.



**CAUTION: TO REDUCE THE RISK OF ELECTRIC SHOCK,
DO NOT REMOVE COVER (OR BACK).
NO USER-SERVICEABLE PARTS INSIDE.
REFER SERVICING TO QUALIFIED SERVICE PERSONNEL.**



The lightning flash with arrowhead symbol, within an equilateral triangle, is intended to alert the user to the presence of uninsulated "dangerous voltage" within the product's enclosure that may be of sufficient magnitude to constitute a risk of electric shock to persons.



The exclamation point within an equilateral triangle is intended to alert the user to the presence of important operating and maintenance (servicing) instructions in the literature accompanying the appliance.

WARNING:

TO PREVENT FIRE OR SHOCK HAZARD, DO NOT EXPOSE THIS TELEVISION SYSTEM TO RAIN OR MOISTURE.

NOTE: There are no user serviceable parts inside the receiver.
Model number and serial number are indicated on the back side of the set.



POWER SOURCE:

This projection color TV is designed to operate on 120 volts 60 Hz, AC household current.

Insert power cord into a 120 volt 60 Hz outlet.

TO PREVENT ELECTRIC SHOCK, DO NOT USE THE TELEVISION'S PLUG WITH AN EXTENSION CORD, RECEPTACLE, OR OTHER OUTLET UNLESS THE BLADES AND GROUND TERMINAL CAN BE FULLY INSERTED TO PREVENT BLADE EXPOSURE. NEVER CONNECT THE TV TO 50 Hz, DIRECT CURRENT, OR ANYTHING OTHER THAN THE SPECIFIED VOLTAGE.

IMPORTANT

NOTE: This television receiver will display television closed captioning ( or ), in accordance with paragraph 15, 119 of the FCC rules.



CAUTION: Never remove the back cover of the set as this can expose you to very high voltages and other hazards. If the set does not operate properly, unplug the set and call your dealer or service shop.

SAFETY TIPS

IMPORTANT SAFEGUARDS

SAFETY POINTS YOU SHOULD KNOW ABOUT YOUR HITACHI TELEVISION RECEIVER

CAUTION:

- * Read all of these instructions.
- * Save these instructions for later use.
- * Follow all warnings and instructions marked on the television receiver.

Our reputation has been built on the quality, performance, and ease of service of HITACHI television receivers.

Safety is also foremost in our minds in the design of these units. To help you operate these products properly, this section illustrates safety tips which will be of benefit to you. Please read it carefully and apply the knowledge you obtain from it to the proper operation of your HITACHI television receiver.

Please fill out your warranty card at once and mail it to HITACHI. This will enable HITACHI to notify you promptly in the improbable event that a safety problem should be discovered in your model of product.

FOR YOUR PERSONAL SAFETY

1 This television set is equipped with a polarized alternating-current line plug (a plug having one blade wider than the other). This plug will fit into the power outlet only one way. This is a safety feature. If you are unable to insert the plug fully into the outlet, try reversing the plug. If the plug should still fail to fit, contact your electrician to replace your obsolete outlet. Do not defeat the safety purpose of the polarized plug.

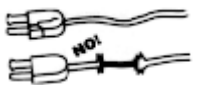

2 When the power cord or plug is damaged or frayed, unplug this television set from the wall outlet and refer servicing to qualified service personnel.



3 Do not overload wall outlets and extension cords as this can result in fire or electric shock.



4 Do not allow anything to rest on or roll over the power cord, and do not place the TV where the

SAFETY TIPS

power cord is subject to traffic or abuse. This may result in a shock or fire hazard.



5 Do not attempt to service this television set yourself as opening or removing covers may expose you to dangerous voltage or other hazards. Refer all servicing to qualified service personnel.



6 Never push objects of any kind into this television set through cabinet slots as they may touch dangerous voltage points or short out parts that could result in a fire or electric shock. Never spill liquid of any kind on the television set.



7 If the television set has been dropped or the cabinet has been damaged, unplug this television set from the wall outlet and refer servicing to qualified service personnel.



8 If liquid has been spilled into this television set, unplug it from the wall outlet and refer service to qualified service personnel.



9 Do not subject your television set to impact of any kind. Be particularly careful not to damage the picture tube surface.



10 Unplug this television set from the wall outlet before cleaning. Do not use liquid cleaners or aerosol cleaners. Use a damp cloth for cleaning.



11-1 Do not place this television set on an unstable cart, stand, or table. The television set may fall, causing serious injury to a child or an adult, and serious damage to the appliance. Use only with a cart or stand recommended by the manufacturer, or sold with the television set. Wall or shelf mounting should follow the manufacturer's instructions, and should use a mounting kit approved by the manufacturer.

SAFETY TIPS



11-2 An appliance and cart combination should be moved with care. Quick stops, excessive force, and uneven surfaces may cause the appliance and cart combination to overturn.

PROTECTION AND LOCATION OF YOUR SET

12 Do not use this television set near water, for example, near a bathtub, washbowl, kitchen sink, or laundry tub, in a wet basement, or near a swimming pool, etc.



Never expose the set to rain or water. If the set has been exposed to rain or water, unplug the set from the wall outlet and refer servicing personnel.



13 Choose a place where light (artificial or sunlight) does not shine directly on the screen.



14 Avoid dusty places, since accumulated dust inside the chassis may cause failure of the set when high humidity persists.

15 The set has slots, or openings in the cabinet for ventilation purposes, to provide reliable operation of the receiver, and to protect from overheating. These openings must not be blocked or covered.



Never cover the slots or openings with cloth or other material.



Never block the bottom ventilation slots of the set by placing it on a bed, sofa, rug, etc.



Never place the set near or over a radiator or heat register.



Never place the set in a "built-in" enclosure, unless proper ventilation provided.

PROTECTION AND LOCATION OF YOUR SET

16-1 If an outside antenna is connected to the television set, be sure the antenna system is

SAFETY TIPS

protected against voltage surges and built up static charges, Section 810 of the National Electrical Code, NFPA No. 70-1975, provides information with respect to proper grounding of the mast and supporting structure, grounding of the lead-in wire to an antenna discharge unit, size of grounding conductors, location of antenna discharge unit, connection to grounding electrode, and requirements for the grounding electrode.

Click to see antenna grounding diagram.

16-2 Note to CATV system installer: (Only for the television set with CATV reception)

This reminder is provided to call the CATV system installer's attention to Article 820-40 of the NEC that provides guidelines for proper grounding and, in particular, specifies that the cable ground shall be connected to the grounding system of the building, as close to the point of cable entry as practical.

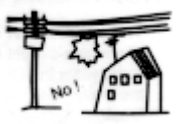

17 An outside antenna system should not be located in the vicinity of overhead power lines or other electrical lights or power circuits, or where it can fall into such power lines or circuits. When installing an outside antenna system, extreme care should be taken to keep from touching such power lines or circuits as contact with them might be fatal.



18 For added protection for this television set during a lightning storm, or when it is left unattended and unused for long periods of time, unplug it from the wall outlet and disconnect the antenna. This will prevent damage due to lightning and power-line surges.

OPERATION OF YOUR SET



19 This television set should be operated only from the type of power source indicated on the marking label. If you are not sure of the type of power supply at your home, consult your television dealer or local power company. For television sets designed to operate from battery power, refer to the operating instructions.



20 If the television set does not operate normally by following the operating instructions, unplug this set television set from the wall outlet and refer servicing to qualified service personnel. Adjust only those controls that are covered in the operating instructions as improper adjustment of other controls may result in damage and will often require extensive work by a qualified technician to restore the television set to normal operation.



21 When going on a holiday: If your television set is to remain unused for a period of time, turn the television set "off" and unplug it from the wall outlet.

IF THIS SET DOES NOT OPERATE PROPERLY



22 If you are unable to restore normal operation by following the detailed procedure in your operating instructions, do not attempt any further adjustment. Unplug the set and call your dealer or service technician.

23 Whenever the television set is damaged or fails, or a distinct change in performance indicates a need for service, unplug the set and have it checked by a professional service technician.

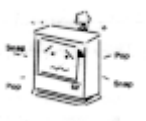

24 It is normal for some TV sets to make occasional snapping or popping sounds, particularly when being turned on or off. If the snapping or popping is continuous or frequent, unplug the set and consult your dealer or service technician.

FOR SERVICING AND MODIFICATION



25 Do not use attachments not recommended by the television set manufacturer as they may cause hazards.

26 When replacement parts are required, be sure the service technician has used replacement parts specified by the manufacturer that have the same characteristics as the original part. Unauthorized substitutions may result in fire, electric shock, or other hazards.



27 Upon completion of any service or repairs to the television set, ask the service technician to perform routine safety checks to determine that the television is in safe operating condition.

PICTURE CAUTIONS

WARNING

Continuous on-screen displays such as video games, stock market quotations, computer generated graphics, and other fixed (non-moving) patterns can cause permanent damage to projection television receivers. Such "PATTERN BURNS" constitute misuse and are NOT COVERED by your Hitachi Factory Warranty.

When using the Picture-in-Picture function, the sub-picture should not be left permanently in one corner of the screen or a "pattern burn" may develop over a long period of time.

This projection television receiver was intended mainly for the private viewing of programs broadcast by TV stations and cable companies and programs from other video sources. Public viewing may require prior authorization from the broadcaster or owner of the video program.

ACCESSORIES

Check to make sure you have the following accessories before disposing of the packing material.

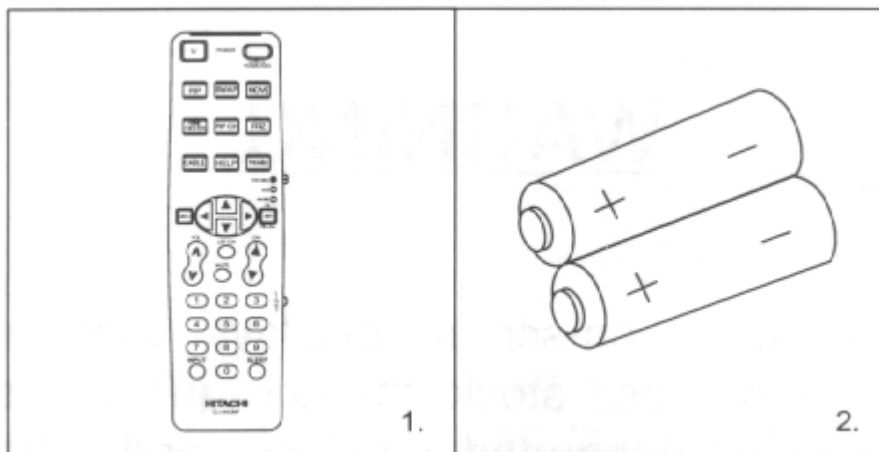

1. Remote Control Unit CLU-413UI (Part No. HL00213)
2. Two "AA" size, 1.5 V batteries (For Remote Control Unit).

REMOTE CONTROL BATTERY INSTALLATION AND REPLACEMENT

1. Open the battery cover of the remote transmitter by pushing the notched part of the cover with your fingers.
2. Insert two new "AA" size batteries equivalent for the remote. When replacing old batteries, push them towards the springs and lift them out.
3. Match the (+) and (-) marks in the battery compartment.
4. Replace the cover.

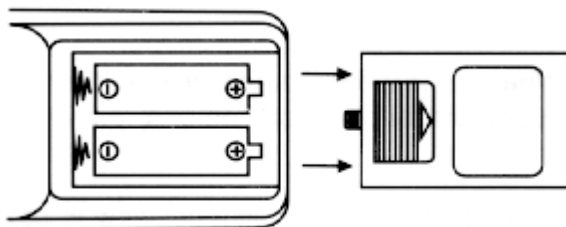
BOTTOM VIEW

HOW TO SET UP YOUR NEW HITACHI PROJECTION TV

ANTENNA

Unless your TV is connected to a cable TV system or to a centralized antenna system, a good outdoor color TV antenna is recommended for the best performance. However, if you are located in an exceptionally good signal area that is free from interference, and multiple image ghosts, an indoor antenna may be sufficient.

LOCATION

Select an area where sunlight or bright indoor illumination will not fall directly on the picture screen. Also, be sure that the location selected allows free flow of air to and from the perforated back cover of the set.

To avoid cabinet warping, cabinet color changes, and increased chance of set failure, do not place the TV where temperatures can become excessively hot. For example, in direct sunlight or near a heating appliance, etc.

VIEWING

The major benefit of the HITACHI Projection Television is its large viewing screen. To see this large screen at its best, test various locations in the room to find the best spot for viewing. The drawings give several suggestions.

The best picture is seen by sitting directly in front of the TV and about 10 to 18 feet from the screen. Picture brightness decreases as the viewer moves to the left or right of the receiver.

During daylight hours, reflections from outside light may appear on the screen. If so, drapes or screens can be used to reduce the reflection or the TV can be located in a different section of the room.

If the TV's audio output will be connected to a Hi-Fi system's external speakers, the best audio performance will be obtained by placing the speakers equidistant from each side of the receiver cabinet and as close as possible to the height of the picture screen center. For best stereo separation, place the external speakers at least 4 feet from the side of the TV. Place the surround speakers to the side or behind the viewing area. Differences in room sizes and acoustical environments will require some experimentation with speaker placement for best performance.

HOW TO SET UP YOUR NEW HITACHI PROJECTION TV

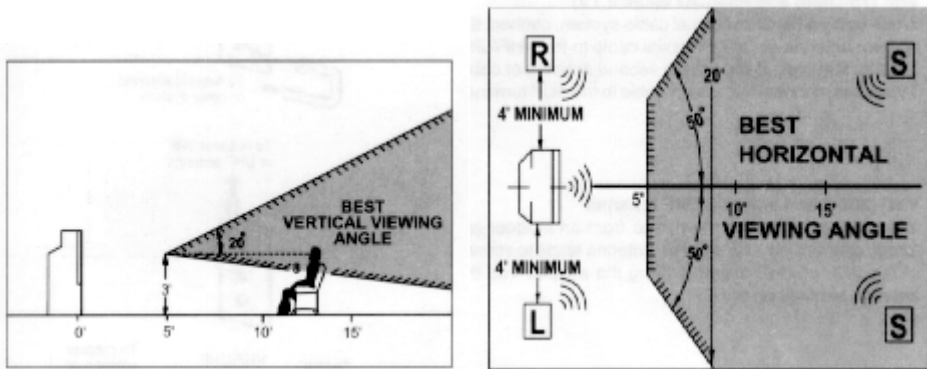

CAUTION: The magnetic field of external speakers may cause the TV picture to distort if the speakers are placed too close to the television. Move the speakers away from the TV until there is no picture distortion.

HOOK-UP CABLES AND CONNECTORS

Most video/audio connections between components can be made with shielded video and audio cables that have phono connectors. For best performance, video cables should use 75-Ohm coaxial shielded wire. Cables can be purchased from most stores that sell audio/video products. Below are illustrations and names of common connectors.

Before purchasing any cables, be sure of the output and input connector types required by the various components. Also make sure the cables are the correct length.

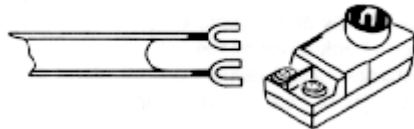

300-Ohm Twin Lead Connector Connector

This outdoor antenna cable must be connected to an antenna adaptor (300-Ohm to 75-Ohm).



"F" Type 75-Ohm Coaxial Antenna

For connecting RF signals (antenna or cable TV) to the antenna jack on the television.



Phono Connector

Used on all standard video and audio VCRs, cables which connect to inputs and outputs located on the Television's rear jack panel and front control panel.



S-Video (Super Video) Connector

This connector is used on camcorders, and laser disc players with an S-Video in place of the standard video cable to produce a high-quality picture.

ANTENNA CONNECTIONS TO REAR JACK PANEL

VHF (75-Ohm) antenna/CATV(cable TV)

When using a 75-Ohm coaxial cable system, connect the outdoor antenna or CATV coaxial cable to the VHF/UHF 75-Ohm terminal.

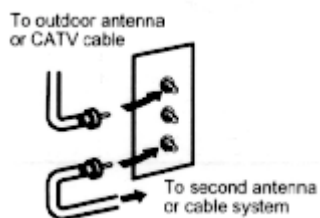

VHF (300-Ohm) antenna/UHF antenna

When using a 300-Ohm twin lead from an outdoor antenna, connect the VHF or UHF antenna leads to screws of the VHF or UHF adaptor. Plug the adaptor into the antenna terminal on the TV.

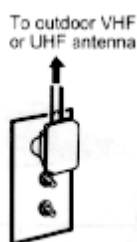

When both VHF and UHF antennas are connected

Attach an optional antenna cable mixer to the TV antenna terminal, and connect the cables to the antenna mixer. Consult your dealer or service store for the antenna mixer.

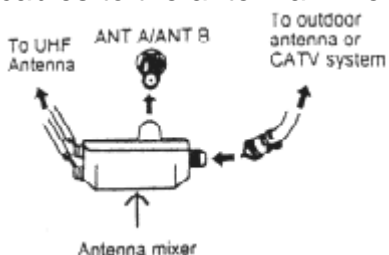

FRONT PANEL CONTROLS

Click to see front panel diagram.

MENU/EXIT BUTTON

This button allows you to enter the MENU mode without using the remote. It makes it possible to set TV features to your preference, without using the remote. This button also serves as the EXIT button when in MENU mode.

INPUT selector

Press this button to select the current antenna source, VIDEO: 1, 2, 3 or alternate antenna source. Your selection is shown in the top right corner of the screen.

VOLUME level

Press these buttons for your desired sound level. The volume level will be displayed on the TV screen. These buttons also serve as the cursor left and right buttons when in MENU mode.

4 CHANNEL selector

Press these buttons until the desired channel appears in the top right corner of the TV screen. These buttons also serve as the cursor down and up buttons when in MENU mode.

5 POWER button

Press this button to turn the TV on or off.

6 POWER light

You will see a red light when the TV is turned on.

NOTE: Your HITACHI TV will appear to be turned "OFF" if there is no video input when VIDEO: 1, 2 or 3 is selected. Check the Power Light to make sure the TV is off when not in use.

7 AI (Artificial Intelligence) sensor

This "Artificial Intelligence" sensor will make automatic picture adjustments

8 REMOTE CONTROL sensor

Point your Remote at this area when selecting channels, adjusting volume, etc.

9 MAGIC FOCUS

Use this button to adjust your picture quality to optimum performance. (See page 40.)

10 ADJUSTMENT MODE button

FRONT PANEL CONTROLS

This button is for service technicians only. DO NOT press this button. If this button is accidentally pressed, please turn off your television using the front panel power button. Your TV will operate normally when you turn it on again.

11 FRONT INPUT JACKS (for VIDEO:3)

Use these audio/video jacks for a "quick" hook-up from a camcorder or VCR to instantly view your favorite show or new recording. (Press the INPUT button until VIDEO:3 appears in the top right corner of the TV screen. If you have mono sound, insert the audio cable in to the left channel jack.)

FRONT PANEL JACKS AND CONNECTIONS

The front panel jacks are provided as a convenience to allow you to easily connect a camcorder or VCR as shown in the following examples:

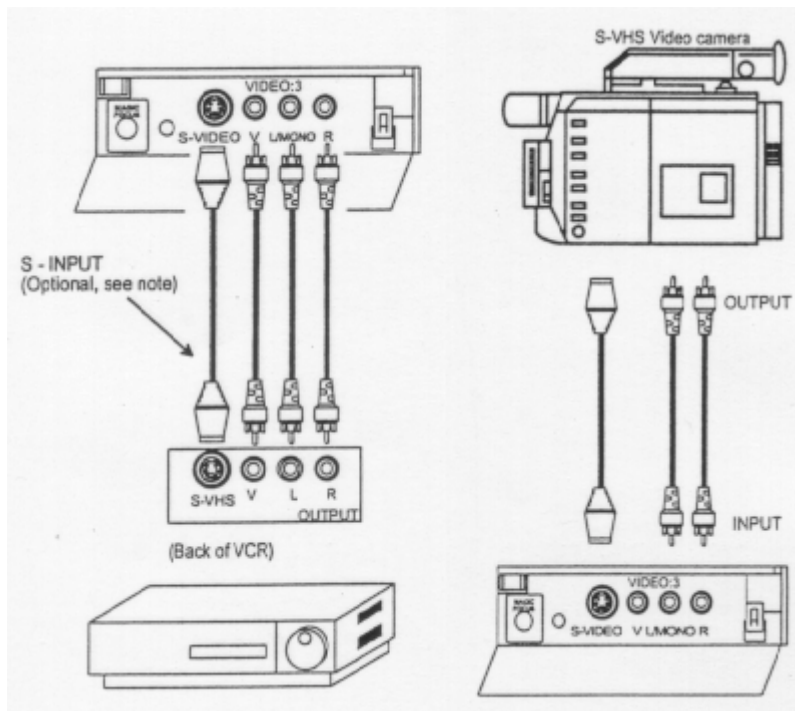

NOTE: Completely insert connection cord plugs when connecting to front panel jacks. If you do not, the played back picture may be abnormal. If you have a S-VHS VCR, use the S-INPUT cable in place of the standard video cable. If you have mono sound, insert the audio cable into the left channel jack.

REAR PANEL JACKS

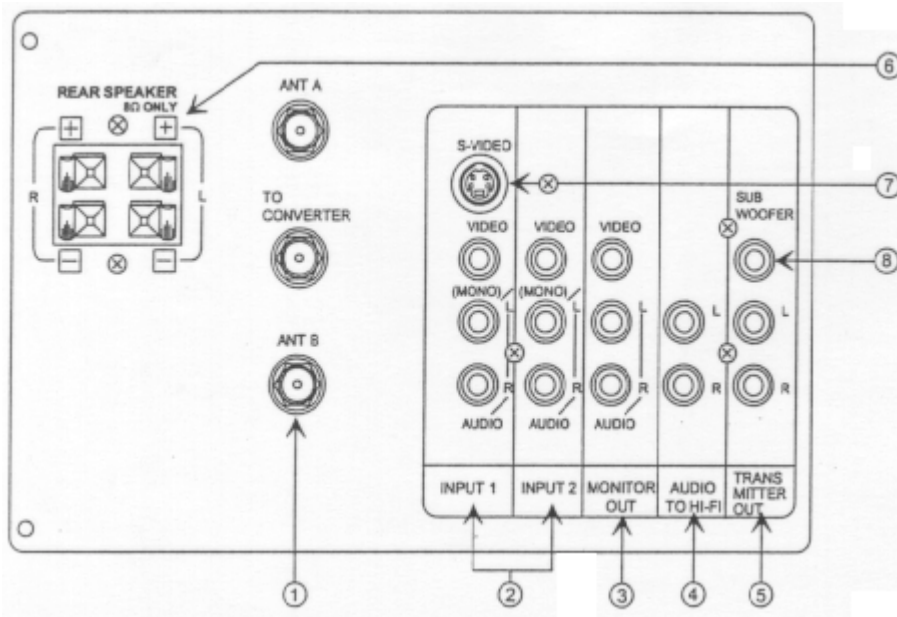

1 Antenna Input/Output

The remote control allows you to switch between two separate 75-Ohm RF antenna inputs, ANT A and ANT B. ANT A input can be displayed as a Main Picture or Sub-Picture. ANT B can only be displayed as a Main Picture. (ANT B cannot be displayed as a PIP sub-picture.) The antenna output labeled "TO CONVERTER" allows the ANT A connection to pass directly to a different source such as a cable box.

2 Audio/Video Inputs 1, 2

The "INPUT" button will step through each video source and antenna source input each time it is pressed. Use the audio and video inputs to connect external devices, such as VCR's, camcorders, laser disc players, etc. (If you have mono sound, insert the audio cable into the left channel jack.)

3 Monitor Out

These jacks provide fixed audio and video signals which are used for recording.

4 Audio to Hi-Fi

These jacks provide variable audio output to a separate stereo system amplifier. With this connection, the audio to the stereo can be controlled by the televisions main volume. Use these jacks for the SURROUND Left and Right channels. (See page 15.)

5 Transmitter Out

These jacks provide variable audio output to a set of wireless speakers. They can also be used for another stereo system amplifier. With this connection, the audio can be controlled by the televisions remote control.

6 Rear Speaker Terminals

These terminals are used to connect external speakers, which are used for the surround sound feature. The volume level is controlled by the remote control main volume buttons and also by an independent rear volume feature found in the HOME THEATER-SURROUND menu. Use speakers with 8 Ohm impedance only.

7 S-Video

Input 1 provides S-Video (Super Video) jacks for connecting equipment with S-Video output capability.

8 Sub Woofer

This jack provides variable output to a sub-woofer accessory.

REAR PANEL CONNECTIONS

Click to see Rear Panel Connections Illustration

Typical full feature set-up. Follow connections that pertain to your personal entertainment system.

REAR SPEAKER TERMINAL CONNECTION

Connect after turning the power to the TV OFF.

Press the Right Speaker red button and insert the positive (+) lead wire into the hole next to the button. Once the wire is in place, pull the red button back to the original position and the wire is locked into place. In the same manner, press the Right Speaker black button and insert the negative (-) lead wire. Repeat this procedure for the Left Speaker.



CAUTION: Do not short speaker terminals, (do not connect a wire directly across any two terminals). This could cause damage to your audio outputs or damage your TV in other ways.

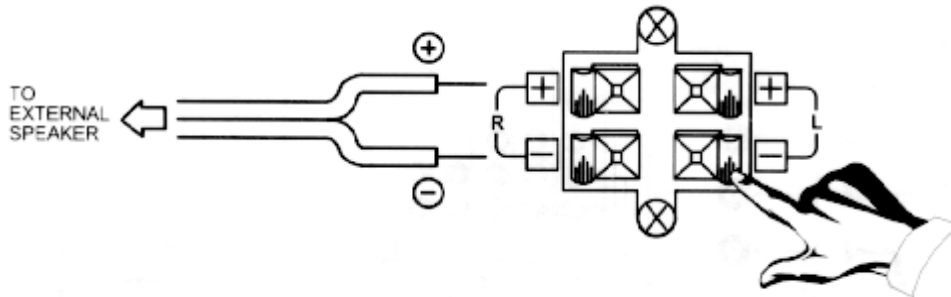

CAUTION: Do not connect speakers simultaneously to the REAR SPEAKER terminal of the Projection TV and an external amplifier. This could damage both the TV and the speakers. Your TV was designed to use 8 Ohm speakers only. Any other type may degrade the audio performance of your entertainment system.

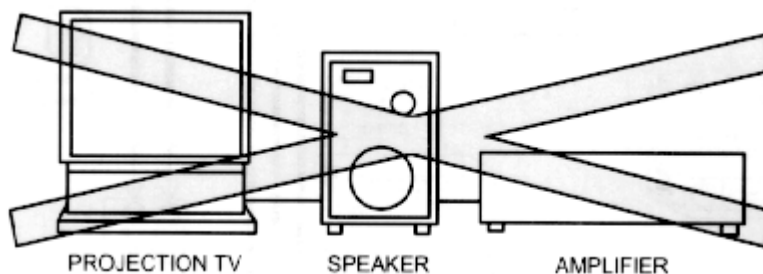

TIPS ON REAR PANEL CONNECTIONS

The S-Video connection is provided for high performance laser discs, VCR's etc., that have this feature. Use this connection in place of the standard video connection if your device has this feature.

If your device has only one audio output (mono sound), connect it to the left audio jack on the TV.

Refer to the operating guide of your other electronic equipment for additional information on connecting your hook-up cables.

A single VCR can be used for VCR #1 and VCR #2, but note that a VCR cannot record its own video or line output (INPUT:1 in the example on page 13.) Refer to your VCR operating guide for more information on "line" input-output connections.

AUDIO SYSTEM SETUP

Match the numbers below to the diagram for speaker placement and refer to the table for the current surround sound requirements. (See page 56 for SURROUND functions.)

1 The television's internal speakers.

2 The television's internal center channel speaker, which is on only when the television is in SURROUND DOLBY- mode.

3 These speakers are connected to a separate audio amplifier. Use the "AUDIO TO HI-FI" output on the TV.

4 These speakers are connected to the Rear Speaker 8 Ohm output on the TV.

5 These speakers are controlled by a wireless speaker transmitter. Use the "TRANSMITTER OUT" output on the TV.

6 This sub woofer is connected to the "SUB WOOFER" output on the TV.

Click to see Audio System Setup Illustration

* If optional left and right speakers are connected (3), the internal speakers (1) may be turned off for better separation between the left, center, and right channels. The center channel audio will be heard from (2).

THE GENIUS REMOTE CONTROL (CLU-952MP)

In addition to controlling the functions of your HITACHI Projection TV, the new remote is designed to operate different types of VCR's, CATV (Cable TV) converters and Audio equipment with one touch. Basic operation keys are grouped together in one area. All other controls are separated from them and arranged in MULTI-PAGE sections, with a display that can be switched to cover any of the three pages. Functions are arranged and properly categorized into windows, making operation simple when multiple functions are to be controlled.

To operate your TV, point the remote at the remote sensor of the TV and press the TV POWER button. Press the TV button and the remote will now control your TV.

To operate your VCR, point the remote at the remote sensor of the VCR. Slide the MULTI-PAGE select switch to VCR and press the VCR POWER button to turn on the VCR power. The remote will now control your VCR. (See page 27 for instructions on how to program the remote to control your VCR.)

To operate your Cable Box, point the remote at the remote sensor of the cable box. Slide the MULTI-PAGE select switch to TV/CABLE and press the CABLE POWER button to turn on the cable box power. Press the CATV button and the remote will now control your cable box. (See page 28 for instructions on how to program the remote to control your cable box.)

To operate your Audio Equipment, point the remote at the remote sensor of the audio component you would like to operate. Slide the MULTI-PAGE select switch to AUDIO and press the button which corresponds to the component you would like to control (AMP, CD, or TAPE). Press the AUDIO POWER button to turn on the audio component power. The remote will now control your audio equipment. (See page 29 for instructions on how to program the remote to control your audio equipment.)

Genius Remote Control Illustration

1 MULTI-PAGE select switch

This selects the button layout of the multi-page section of the remote control.

2 MULTI-PAGE buttons

These buttons change functions as shown on page 17.

3 LIGHT BUTTON

When you are in a dark room, press this button on the side of the remote to light up the buttons shown in 4. The light will stay on for about 8 seconds if the light button is not pressed again. These buttons will not appear to light if the room is too bright.

MULTI-PAGE WINDOWS

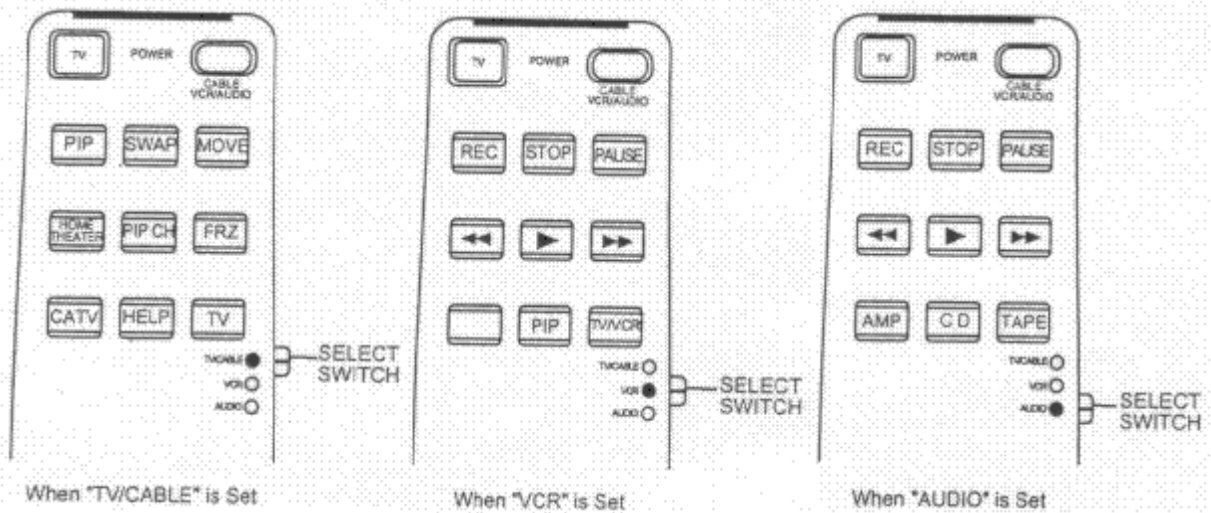

HOW TO USE THE GENIUS REMOTE TO CONTROL YOUR TV

Genius Remote Control Illustration

1 TV POWER button

Press this button to turn the TV set on or off.

2 CABLE/VCR/AUDIO POWER button

Once the remote is programmed, press this button to control power to your Cable Box, VCR or Audio Equipment, depending on the button layout of the MULTI-PAGE section of the remote control, as chosen by the MULTI-PAGE select switch. (See pages 16, 27, 28, 29.)

3 EXIT/RECALL/COMMERCIAL SKIP button

Press this button when no menu is displayed when you want to check the channel being received, or if it has stereo (ST) or second audio program (SAP).

You can also check the time, CHANNEL ID, and if the SLEEP TIME has been set. (See pages 21, 39, and 41.)

When in MENU mode, this button will exit all On Screen Displays.

Press this button twice quickly, when no menu is displayed, to enable the COMMERCIAL SKIP function. This will tune the TV to the last channel viewed and after 30 seconds, tune back to the original channel.



You can also use the RECALL button to quickly clear many of the other on-screen display.

4 PIP CH button

Use the PIP CH button to select between main picture and sub-picture tuning. An arrow next to the channel number will indicate which channel is being controlled.

5 MENU, CURSOR buttons

All the On-Screen Display features can be set or adjusted by using these buttons.

The "MENU" button will start the On-Screen Display.

The "CURSOR" buttons will highlight functions or adjust and set different features.

6 CHANNEL SELECTOR buttons

"CHANNEL SELECTOR" buttons are used to set Family Favorites, Channel Memory, etc..

Enter two or three numbers to select channels. Enter "0" first for channels 1 to 9 . For channels 100 and above, press the 1 button, wait until another dash appears next to the channel display on your TV, then enter the remaining two numbers using the number

HOW TO USE THE GENIUS REMOTE TO CONTROL YOUR TV

buttons.

Channel selection may also be performed by pressing CH up (▲) or down (▼). You may also use these buttons for QUICK LIST. Press and hold the CH up (▲) or down (▼) button and a window will appear, allowing you to choose the channel you wish to tune. Release the CH (▲) or (▼) button when the channel you wish to tune is highlighted, and the TV will tune to that channel.

NOTE: The TV may not receive some channels if you are not in the correct SIGNAL SOURCE mode. (See page 35.)

7 INPUT button

The INPUT button will select between both antenna signals and the three sets of video input jacks each time the button is pressed. If the Picture-in-Picture is on, the INPUT button will select between the three sets of video input jacks and both antenna sources when main channel is chosen with the PIP CH button. If the sub-picture is chosen, the INPUT button will select between the three sets of video input jacks and the ANT A antenna source (ANT B source cannot be displayed as a PIP Sub-Picture.)

NOTE: When ANT A is selected, the channel number in the upper right corner of the screen is in green. When ANT B is selected, the channel number is in yellow.

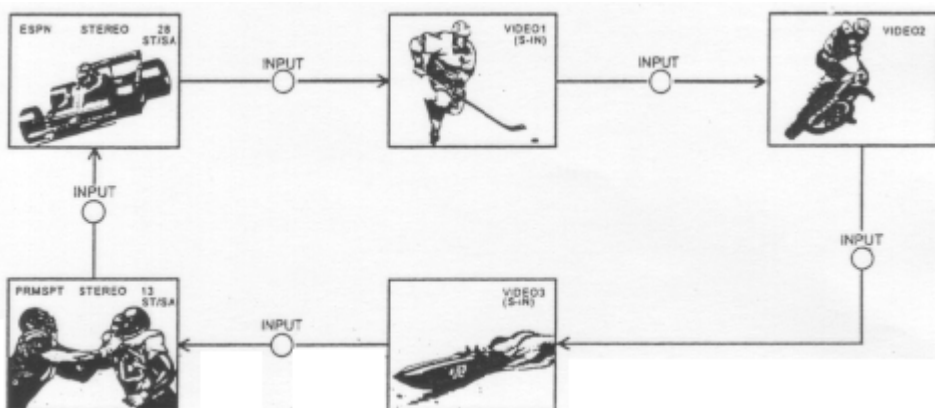

8 VOLUME, MUTE buttons

Press the "VOLUME" up (▲) or down (▼) button until you obtain the desired sound level.

To turn the sound off instantly to answer the telephone, etc., press the "MUTE" button. Press the "MUTE" button again or press the "VOLUME" up (▲) button to restore the sound.

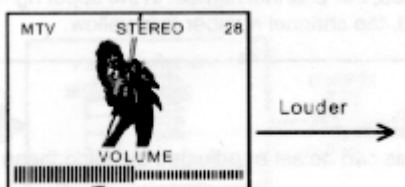

HOW TO USE THE GENIUS REMOTE TO CONTROL YOUR TV

Closed Caption will appear when TV is muted, regardless of CLOSED CAPTIONED

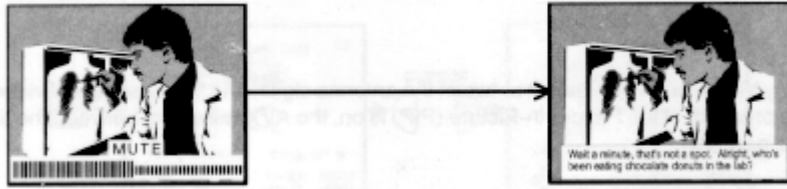

on/off.

9 LAST CHANNEL (LST-CH) button

Use this button to select between the last two channels viewed. (Good for watching two sporting events, etc.)

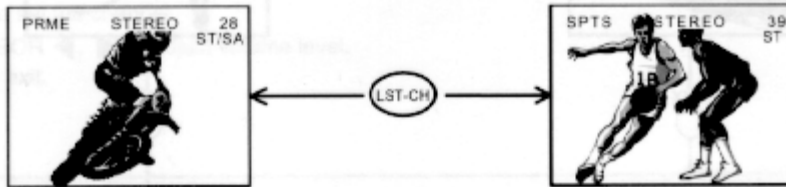

10 PICTURE-IN-PICTURE

See separate section on page 22 for a description.

11 HOME THEATER button

Press this button to enter the THEATER MODES menu (Every press of this button will change THEATER MODES settings. (See page 55.)

12 CATV button (This button may be named CABLE on your remote control.)

Press this button to allow the remote to control your cable box. (See page 28.)

13 HELP button

Press this button when a menu is displayed to view HELP text, which give a description of the displayed menu.

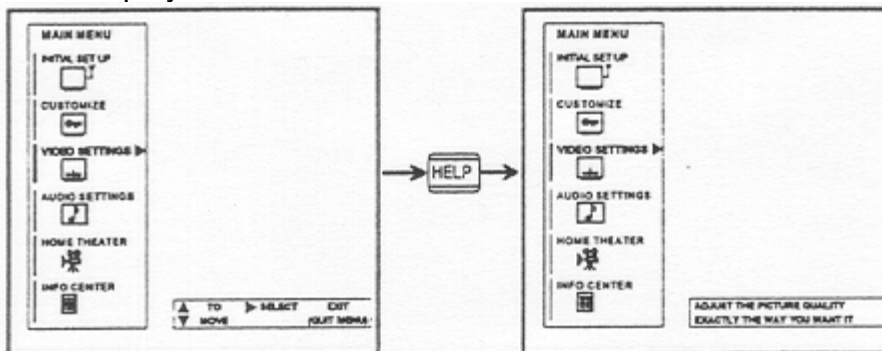

14 TV button

Press this button to allow the remote to control your TV.

15 SLEEP button

Press this button to display the sleep timer in the lower left corner of the screen. Every subsequent press of this button will add 15 minutes to this timer, up to a maximum of 3 hours. Once set, use RECALL when you want to view time remaining. If the SLEEP button is pressed while the timer is set, it will reset to the original condition.

PICTURE-IN-PICTURE (PIP)

Your Hitachi Projection TV incorporates Dual Tuner technology designed to give you improved viewing enjoyment. This Dual Tuner feature allows you to view antenna inputs on both MAIN and PIP sub-pictures simultaneously, with separate tuning control for each. The Dual Tuner can operate with only one input (ANT A only) or two inputs (ANT A and ANT B).

ANT A input can be viewed as both main picture and sub-picture, simultaneously. ANT B can only be viewed as a Main Picture. To select between Main Picture and PIP sub-picture tuning, press the PIP CH button on the remote. The arrow next to the channel display will move with every press of the PIP CH button. When the arrow is next to the top channel display, channel tuning is for the Main Picture. When the arrow is next to the lower channel display, channel tuning is for the PIP sub-picture. This method of picture tuning is the same for one antenna input (ANT A only) and two antenna inputs (ANT A and ANT B).

The Picture-in-Picture feature is convenient when you want to watch more than one program at the same time. You can watch a TV program while viewing other programs from the ANT A source or any of the video inputs.

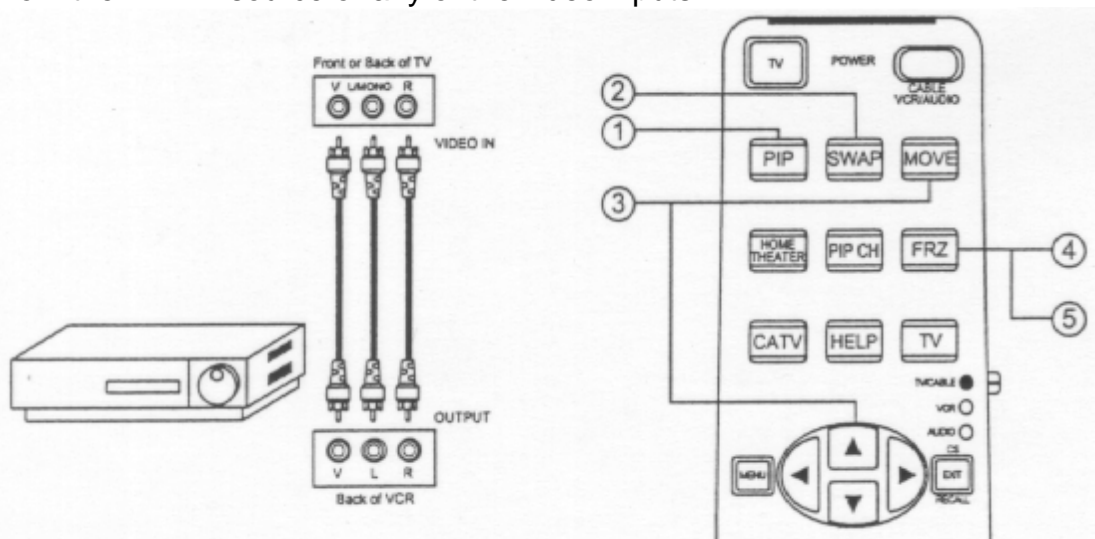

1 PIP button

Press the "PIP" button and a screen appears which allows you to use CURSOR ▲, ▼ to select which type of PIP you wish to view. (SINGLE, SPLIT, or MULTI CH for SX models and SINGLE or MULTI CH for UX models.)

SINGLE MODE PIP:

Press the "PIP" button a second time and a sub-picture appears in one corner of the screen. Press the button again to reduce the size of the sub-picture. Press the "PIP" button a fourth time to remove the sub-picture from the screen. Use the "PIP CH" button to select between Main and Sub-Picture tuning control (indicated by arrow next to

PICTURE-IN-PICTURE (PIP)

channel number.) Press the INPUT button when sub-picture channel tuning is being controlled, to change between VIDEO:1, VIDEO: 2, VIDEO: 3 and ANT A antenna source. (ANT B source cannot be viewed as a sub-picture.)

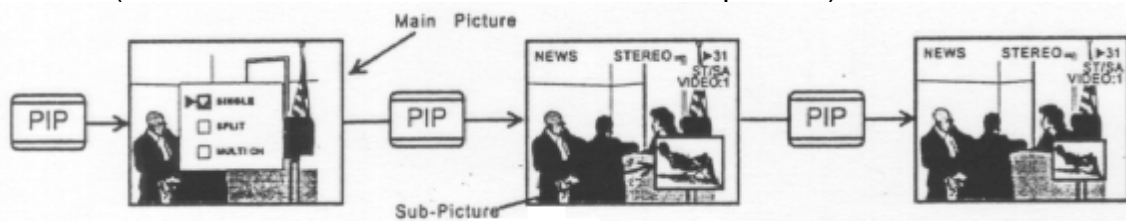

NOTE: Since ANT B source cannot be viewed as a sub-picture, only single PIP mode is possible when ANT B is selected as the Main Channel.

SPLIT MODE PIP: (SX models only)

When you press the "PIP" button a second time, the main channel and the PIP sub-picture will appear at the center of the screen (Main channel on left side and sub-picture on right side). Press the "PIP" button a third time to return to normal viewing. PIP sub-picture control is the same as described in SINGLE MODE.



MULTI CH PIP

When you press the "PIP" button a second time to begin Multi-Channel PIP. This feature will automatically scan through all active channels (those set in memory) and display them as PIP sub-pictures, along the left and bottom edges of the screen for SX models or along the right edge of the screen for UX models. Press the "PIP" button a third time to remove the sub-pictures from the screen.

(MV7, SX models only)



(MV4, UX models only)



NOTE:

1. If no buttons are pressed when in MULTI-CHANNEL PIP mode, autoscanning will continuously scan.
2. If a channel is tuned during this MULTI-CHANNEL scanning, sub-pictures will be removed from the screen.

2 SWAP button

If you wish to switch what is being shown on the main picture to the sub-picture, press the "SWAP" button.

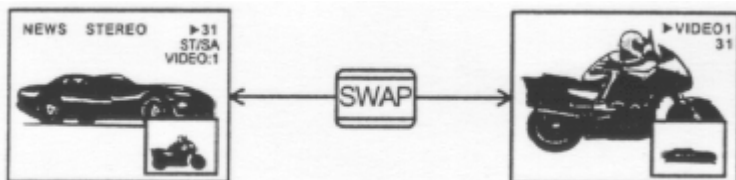

NOTE: The SWAP button will only operate when the SINGLE PIP mode is chosen. The SWAP function will not operate if ANT B input is set as the main channel (ANT B input cannot be displayed as a sub-picture).

3 MOVE button

To move the sub-picture to another corner, press the "MOVE" button. The sub-picture moves one step counter-clockwise every time the "MOVE" button is pressed. (Example below illustrates the "MOVE" operation for initial shipping conditions. If you have customized a PIP position, the "MOVE" operation may differ slightly from this example.)

ii It is also possible to customize one PIP position. To do this, simply use the remote control CURSOR buttons while the sub-picture is displayed, to shift the sub-picture to a position you prefer.

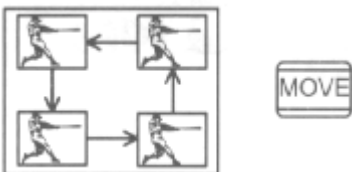

NOTE: The MOVE and CUSTOMIZING PIP position functions will only operate when SINGLE PIP mode is chosen.

4 FREEZE (FRZ) button (With PIP ON)

If you wish to freeze the sub-picture, press the "FRZ" button. This is convenient when trying to write down the address for a mail order company, recording statistics for a sporting event, etc. To return the picture to motion, press the button again.

NOTE: The FREEZE function will only operate when SINGLE PIP mode or SPLIT PIP

mode (SX models only) is chosen. When used in SPLIT PIP mode, only the right sub-picture is frozen (Left sub-picture remains active).

5 FREEZE (FRZ) button (With PIP OFF)

Press the "FRZ" button without a sub-picture and a screen appears which allows you to use CURSOR ▲, ▼ to select which type of FREEZE mode you wish to view (SINGLE, STROBE, SPLIT, or MAIN for SX models and SINGLE or STROBE for UX models).

SINGLE FREEZE

Press the "FRZ" button a second time to freeze one frame of the picture you are currently viewing. Press this button again or "PIP" to return to normal viewing.



STROBE FREEZE

Press the "FRZ" button a second time to freeze several frames of the picture you are currently viewing (Seven frames for SX models and four frames for UX models). Press this button again or "PIP" to return to normal viewing. This feature is useful for viewing a moving picture that has many details, for example, a close play in a sporting event or golf swing.

(MV7, SX models only)



(MV4, UX models only)



SPLIT FREEZE (SX models only)

Press the "FRZ" button a second time to freeze one frame of the picture you are currently viewing (Only the sub-picture will freeze). Press this button again or "PIP" to return to normal viewing.

PICTURE-IN-PICTURE (PIP)



iii MAIN FREEZE (SX models only)

Press the "FRZ" button a second time to freeze one frame of the picture you are currently viewing. The entire screen will freeze. Press this button again or "PIP" to return to normal viewing.



CAUTION: A pattern burn may develop if the sub-picture is left in the same corner permanently. If the PIP feature is used frequently, occasionally shift the sub-picture to a different corner. You may also vary its position using the CURSOR buttons. (UX models only.)

NOTE:

1. Only sound from the main picture can be heard, unless you choose sub-picture audio from HOME THEATER-WIRELESS SOUND mode and use the "TRANSMITTER OUT" outputs on the rear panel. (See page 60.)
2. Each freeze frame is delayed about 0.1 (1/10) second.

USING THE REMOTE TO CONTROL VCR FUNCTIONS

Operating the pre-coded function for your VCR.

This remote is designed to operate different types of VCR's. You must first program the remote to match the remote system of your VCR. (Refer to page 30.)

Remote Control Illustration

1. Set the MULTI-PAGE select switch to "VCR".
2. Turn ON your VCR.
3. Aim the remote control at the front of your VCR.
4. While holding down the VCR POWER button on the remote, enter the 2 digit preset code that matches your VCR as shown on page 30. The remote will turn off your VCR when the correct 2 digit preset code is entered. When this occurs, the remote control is programmed for your VCR. If the VCR does not turn off after 5 seconds, try a different 2 digit preset code.
5. The remote will now control your VCR.

NOTES:

1. If your VCR cannot be operated after performing the above procedures, this means that your VCR code has not been precoded into the remote.
2. In the unlikely event that your VCR cannot be operated after performing the above procedures, please consult your VCR operating guide.
3. The remote control will remember the codes you have programmed in until the batteries are removed from the remote control. After replacing the batteries repeat the entire programming procedure stated above.
4. If your VCR does not have a power function, the remote will issue the CHANNEL UP function.
5. The MENU button will act as the VCR MENU button for HITACHI VCR's.
6. The LST-CH button will act as your VCR ENTER button if required.
7. The SLEEP button will act as your VCR +100 button if required.

1 PRECODED VCR buttons

These buttons transmit the chosen precoded VCR codes.

2 EXCLUSIVE TV buttons

These buttons are for operating the TV.

USING THE REMOTE TO CONTROL CABLE BOX/SATELLITE FUNCTIONS

Operating the pre-coded function for your cable/satellite box.

This remote is designed to operate different types of cable boxes and Digital Satellite Systems. You must first program the remote to match the remote system of your cable/satellite box. (Refer to page 30.)

Remote Control Illustration

1. Set the MULTI-PAGE select switch to "TV/CABLE".
2. Turn ON your cable/satellite box.
3. Press the CATV button on the remote to switch to CATV mode.
4. Aim the remote control at the front of your cable/satellite box.
5. While holding down the CABLE POWER button on the remote, enter the 2 digit preset code that matches your VCR as shown on page 30. The remote will turn off your cable/satellite box when the correct 2 digit preset code is entered. When this occurs, the remote control is programmed for your cable/satellite box. If the cable/satellite box does not turn off after 5 seconds, try a different 2 digit preset code.
6. The remote will now control your cable/satellite box.

NOTES:

1. If your cable/satellite box cannot be operated after performing the above procedures, this means that your VCR code has not been precoded into the remote.
2. In the unlikely event that your cable/satellite box cannot be operated after performing the above procedures, please consult your cable/satellite box operating guide.
3. The remote control will remember the codes you have programmed in until the batteries are removed from the remote control. After replacing the batteries repeat the entire programming procedure stated above.
4. If your cable/satellite box does not have a power function, the remote will issue the CHANNEL UP function.
5. The LST-CH button will act as your cable/satellite box ENTER button if required.
7. The SLEEP button will act as your cable/satellite box +100 button if required.

1 PRECODED CABLE/SATELLITE buttons

These buttons transmit the chosen precoded CATV/Satellite codes.

2 EXCLUSIVE TV buttons

These buttons are for operating the TV.

USING THE REMOTE TO CONTROL AUDIO EQUIPMENT FUNCTIONS

Operating the pre-coded function for your audio equipment.

This remote is designed to operate different types of audio equipment. You must first program the remote to match the remote system of your audio equipment.

Remote Control Illustration

1. Set the MULTI-PAGE select switch to "AUDIO".
2. Turn ON the audio component you wish to control with your remote control (AMP, CD or TAPE).
3. Aim the remote control at the front of your audio equipment.
4. While holding down the button on the remote which corresponds with the component you wish to control (AMP, CD, or TAPE), enter the 2 digit preset code that matches your audio component as shown on page 30. The remote will turn off your audio component when the correct 2 digit preset code is entered. When this occurs, the remote control is programmed for your audio component. If the audio component does not turn off after 5 seconds, try a different 2 digit preset code.
5. The remote will now control your audio component.
6. Repeat steps 2-5 until all audio equipment preset codes are programmed into the remote.

NOTES:

1. If your audio component cannot be operated after performing the above procedures, this means that your audio component code has not been precoded into the remote.
2. In the unlikely event that your audio component cannot be operated after performing the above procedures, please consult your audio component operating guide.
3. The remote control will remember the codes you have programmed in until the batteries are removed from the remote control. After replacing the batteries repeat the entire programming procedure stated above.
4. If your audio component does not have a power function, the remote will issue another obvious function that the audio component will respond to, such as CD open/close.
5. The default for AUDIO Mode is AMP.
6. If you wish to control your Receiver or misc audio equipment, you must follow the remote programming procedure shown above. You may use the AMP, CD, or TAPE buttons, but note that these buttons may not be used for more than one component.

1 PRECODED AMP, CD, OR TAPE buttons

These buttons transmit the chosen precoded audio component codes.

2 EXCLUSIVE TV buttons

These buttons are for operating the TV.

AUDIO, CABLE/SATELLITE, AND VCR CODES

AMPLIFIER

AMPLIFIER BRAND	CODES	AMPLIFIER BRAND	CODES
CARVER	51	MAGNAVOX	51
MARANTZ	51	OPTIMUS	00,01
PHILIPS	51	PIONEER	00,01
TECHNICS	02	WARDS	00

CD PLAYER

CD PLAYER BRAND	CODE	CD PLAYER BRAND	CODE
ADCOM	16	AIWA	17
CALIFORNIA AUDIO LAB	06	CARVER	17
DENON	04	DKK	03
EMERSON	16	FISHER	08
GENEXXA	07	HITACHI	07,14,15,16,21,23,24
JVC	10	KENWOOD	05,08,19
KRELL	17	MAGNAVOX	17
MARANTZ	06,17	MCS	06
MISSION	06	NSM	17
ONKYO	13	OPTIMUS	03, 07, 52
PANASONIC	06	PHILIPS	17

AUDIO, CABLE/SATELLITE, AND VCR CODES

CD PLAYER BRAND	CODE	CD PLAYER BRAND	CODE
PIONEER	07,52	PROTON	17
QED	17	QUASAR	06
RCA	09,16	REALISTIC	16
ROTEL	17	SAE	17
SANSUI	17	SCOTT	16
SONY	03,18	Technics	06, 20, 22
VICTOR	10		

CABLE BRAND

CABLE BRAND	CODES	CABLE BRAND	CODES
ABC	03,05,06,09,11,12,14	ARCHER	40
BELCOR	31	CABLE STAR	31
CENTURY	40	CITIZEN	40
CONTEC	15	DAE RYUNG	06
GARRARD	40	GC ELECTRONICS	31
GEMINI	13	GENERAL INSTRUMENTS	09,51
GOLD STAR	39	HAMLIN	08,16,49,50
HITACHI	09	HYTEX	05
JASCO	40	MEMOREX	00
MOVIETIME	42	NSC	42
OAK	05,15	PANASONIC	00,17,38

AUDIO, CABLE/SATELLITE, AND VCR CODES

CABLE BRAND	CODES	CABLE BRAND	CODES
PARAGON	00	PHILIPS	40
PIONEER	39,63	PULSAR	00
RCA	17	REGAL	16,49,50
REMBRANDT	09	RUNCO	00
SAMSUNG	39	SCIENTIFIC ATLANTA	06,49,50
SIGNAL	13	SIGNATURE	09
SPRUCER	17	STARCOM	03,13
STARGATE	13	STARQUEST	13
TOCOM	10,11,33	TOSHIBA	00
TURSA	13	UNIKA	40
UNITED ARTIST	05	UNITED CABLE	03
UNIVERSAL	31,40	ZENITH	00,62

CASSETTE BRAND

CASSETTE BRAND	CODE	CASSETTE BRAND	CODE
HITACHI	56,57,61,62	JVC	59
KENWOOD	55	OPTIMUS	54
PANASONIC	60	PIONEER	54
SONY	58,63	WARDS	54

AUDIO, CABLE/SATELLITE, AND VCR CODES

MISC. AUDIO BRAND

MISC. AUDIO BRAND	CODE	MISC. AUDIO BRAND	CODE
AIWA	25,26	JERROLD	53,55
SCIENTIFIC ATLANTA	54	STARCOM	53
SONY	25,26		

RECEIVER BRAND CODES

RECEIVER BRAND	CODE	RECEIVER BRAND	CODE
AIWA	37,40	CARVER	28,32,40
CASIO	41	CLARINETTE	41
DENON	27	FISHER	32,43
HITACHI	44	JVC	33
KENWOOD	30,39,47,48	LLOYD'S	41
MAGNAVOX	40,41	MARANTZ	31,40
MCS	31	MODULAIRE	41
ONKYO	35	OPTIMUS	34,39,43
PANASONIC	31	PENNY	41
PHILLIPS	40	PIONEER	29,34,45
QUASAR	31	REALISTIC	41
SANSUI	40	SANYO	43
SHARP	39	SONY	37
TECHNICS	31,42,46,50	VICTOR	33
WARDS	29, 32, 34, 37, 40	YAMAHA	38,39
YORX	41		

SATELLITE BRANDS

SATELLITE BRAND	CODES	SATELLITE BRAND	CODES
GENERAL INSTRUMENT	64	JERROLD	64,65
PRIMESTAR	64,65	RCA	60
SONY	66		

TELEVISION BRAND

TELEVISION BRAND	CODES	TELEVISION BRAND	CODES
HITACHI	00	MEGATRON	00

VCR BRAND

VCR BRAND	CODES	VCR BRAND	CODES
ADVENTURA	00	AIKO	50
AIWA	00	AKAI	14,23
AMERICA HIGH	09	ASHA	48
AUDIOVOX	10	BEAUMARK	48
BELL & HOWELL	30	Broksonic	33, 37, 43
CALIX	10	CANON	09
CARVER	28	CCE	27,.50
CITIZEN	10,50	COLT	27
CRAIG	10,19,27,48	Curtis Mathes	09, 14, 22
CYBERMAX	48	DAEWOO	17,50
DYNATECH	00	Electrohome	10

AUDIO, CABLE/SATELLITE, AND VCR CODES

VCR BRAND	CODE	VCR BRAND	CODE
ELECTROPHONIC	10	EMEREX	06
EMERSON	00, 01, 10, 16, 23, 33, 37, 40, 43, 50	Fisher	19, 30
Fuji	07,09	FUNAI	00
GARRARD	00	GE	09, 22, 24
Goldstar	10, 11	Gradiente	00
Harley Davidson	00	Harman/Kardon	11
Harwood	27	Headquarter	18
Hi-Q	19	Hitachi	14,15,24
Jensen	14	JVC	14,26
KEC	10,50	Kenwood	11,14,26
KLH	27	Kodak	9,10
Lloyd	00	Lloyd's	40
Logik	27	LXI	10
Magnavox	09,12,28	Magnin	48
Marantz	09,28	Marta	10
Matsushita	09	MGA	16,23
MGN Technology	48	Minolta	15
Mitsubishi	16,23,26	Motorola	09,20
MTC	00,48	Multitech	00,27
NEC	11,13,14,26	Nikko	10
Noblex	48	Olympus	09

AUDIO, CABLE/SATELLITE, AND VCR CODES

Optimus	10,20,30	Panasonic	09,35,46
Penney	09,10,11,13,15,48	Pentax	15,24
Philco	09	Phillips	09,28
Pilot	10	Pioneer	26
Protec	27	Pulsar	12
Quarter	18	Quartz	18
Quasar	09	Radio Shack	00,10
Radix	10	Randex	10
RCA	15,22,24	Realistic	00,09,10,18,19,20,30,48
Ricoh	08	Runco	12
Samsung	17,48	Sanky	12,20
Sansui	14,26	Sanyo	18,19,30,48
Scott	16,17,33,37,43	Sears	09,10,15,18,19,30
Sharp	20	Shintom	27
Shogun	48	Singer	27
Sony	06,07,08,09	STS	15
Sylvania	00,09,10,18	Symphonic	00
Tatung	14	Teac	00,14
Technics	09,35	Teknika	00,09,10
TMK	40,48	Toshiba	16,17
Totevision	10,48	Unitech	48
Vector	17	Vector Research	11,13

AUDIO, CABLE/SATELLITE, AND VCR CODES

Video Concepts	13,17,23	Videosonic	48
Wards	00,09,15,19,20,22,27,48	XR-1000	00,09,27
Yamaha	11	Zenith	07,08,12

ULTRATEC OSD

1. Press MENU on the remote control to display the different features on your HITACHI Projection TV.

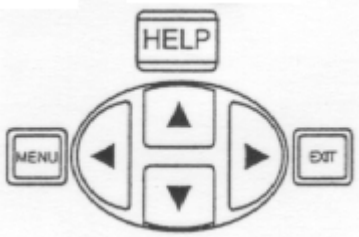

2. Press the CURSOR buttons to highlight a different feature.
3. Press EXIT on the remote control to quickly exit from a menu.
4. Press HELP on the remote control when a menu is displayed, and text will appear giving a description of that menu.

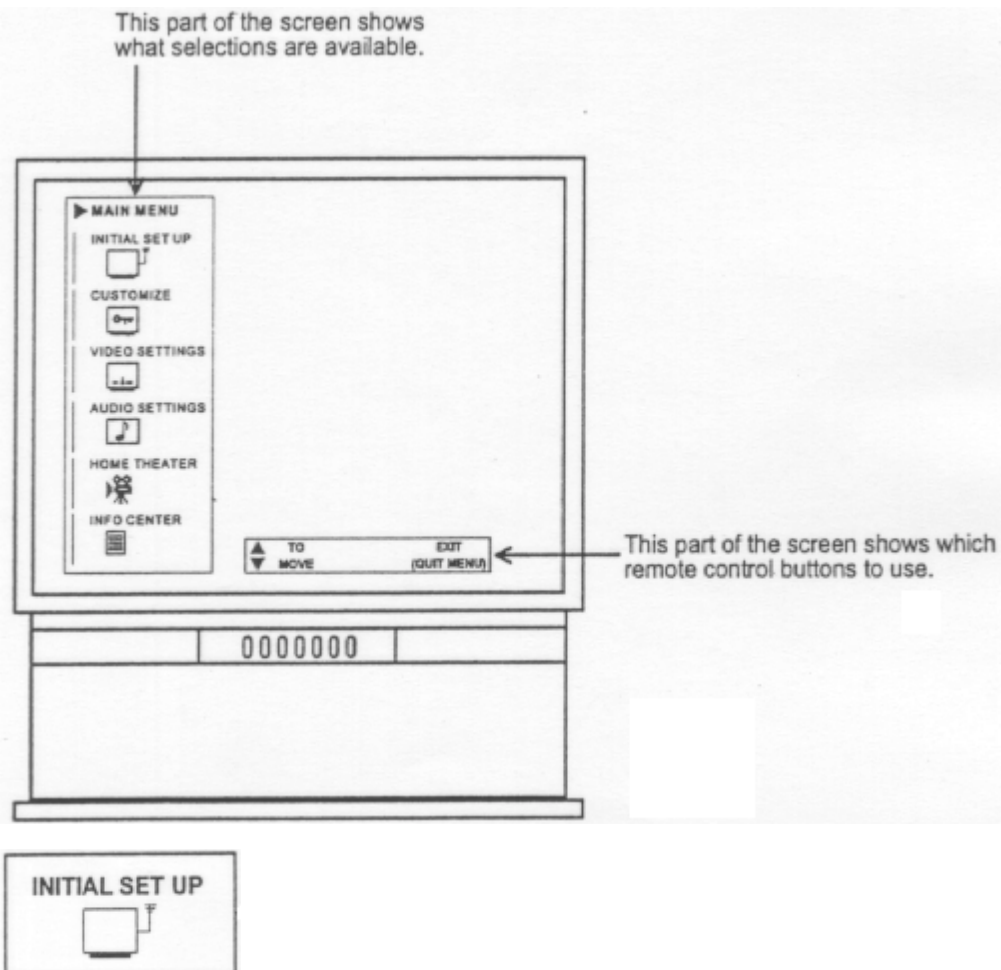

MENU LANGUAGE	Choose English, French, or Spanish text.
PLUG & PLAY	Optimum hook up for your system.
SIGNAL SOURCE	Select Antenna or Cable TV.
AUTO CHANNEL SET	First time set up for channel buttons.
CHANNEL MEMORY	Channel buttons, add, skip.
CHANNEL LIST	Check channel name, scan, and child lock.
CLOCK SET	Set before using timer features.
MAGIC FOCUS	Automatically match red, green, and blue colors to make white.

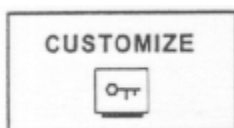

CHANNEL ID	Label channels PAY1, ABC, etc.
VIDEO ID	Label video inputs VCR1, LASER1, etc.
FAMILY FAVORITES	Allows you to set and view favorite channels.
CHILD LOCK	Block channel picture and sound.
4 EVENT PROGRAM	Turn TV on and off once, daily, or weekly.
AUTO LINK	Automatically turn TV on with Video: 1 input.
CLOSED CAPTION	Feature to display dialogue/text.
MENU BACKGROUND	Select from two types of backgrounds.



CONTRAST	Adjust contrast.
BRIGHTNESS	Adjust brightness.
COLOR	Adjust color.
TINT	Adjust tint.
SHARPNESS	Adjust sharpness.
RESET	Set VIDEO settings to factory preset.
ADVANCED SETTINGS	Improve picture performance.



BASS	Adjust bass.
TREBLE	Adjust treble.
BALANCE	Adjust balance.
RESET	Set AUDIO settings to factory preset.
ADVANCED SETTINGS	Improve sound performance.



THEATER MODES	Picture and sound are automatically set.
---------------	--

ULTRATEC OSD

SURROUND	Special sound effects.
OFF	Deactivates all surround modes.
MATRIX	Simulate surround sound for Non-Dolby programs.
HALL	Creates concert hall sound.
DOLBY	Provides true Dolby surround sound.
GRAPHIC EQ	More precise audio control.
WIRELESS SOUND	Adjust audio output for wireless speaker.
SUB-WOOFER	Adjust Sub-Woofer volume.

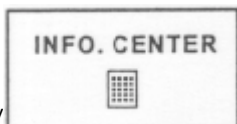

iv

PERSONAL MESSAGES	Use to leave message or daily reminder.
SPECIAL EVENT	
REMINDER	Set TV to remind you of birthday's, etc.
CALENDAR	Check day, month, year and Special Events.
SECURITY VIEWER	Automatically turn PIP on with VIDEO:2 input.

INITIAL SETUP

INITIAL SETUP



Select INITIAL SETUP when setting your TV up for the first time. Use the CURSOR ▲, ▼ buttons on the remote to highlight the function desired.

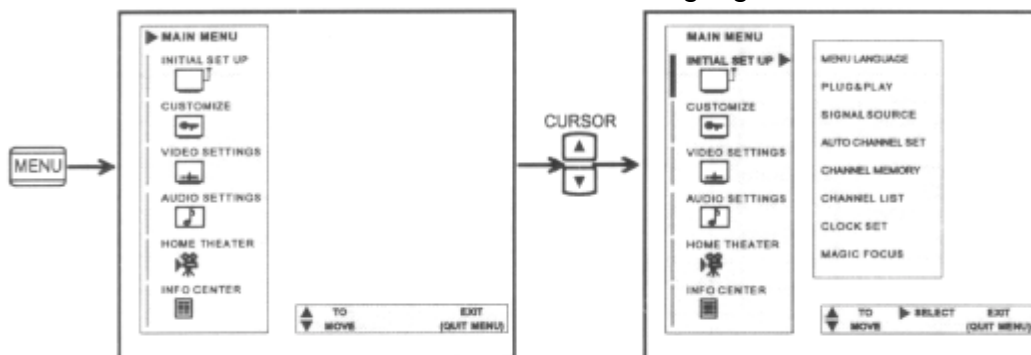

NOTE: To see an autodemonstration of the on-screen display with HELP text displayed, press and hold the POWER button on the TV set for approximately 5 seconds. Press the POWER button on the TV again to end the autodemonstration.

MENU LANGUAGE

This feature will allow you to select any one of 3 different languages for all on screen displays.

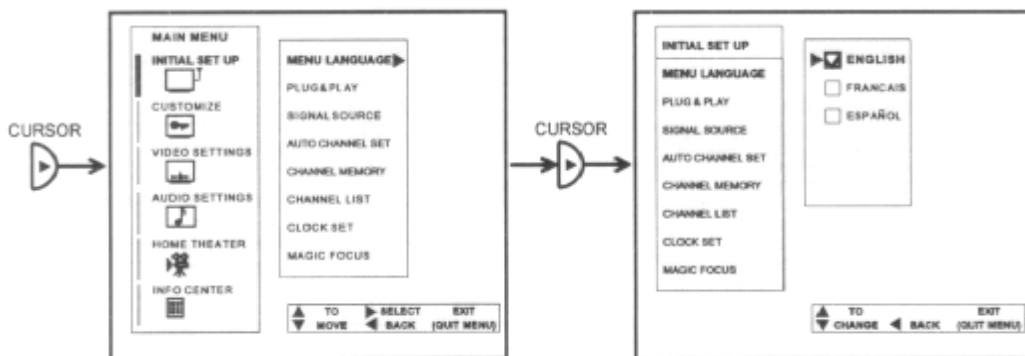

Use CURSOR ▲ or ▼ to select the MENU LANGUAGE of your choice. Press EXIT to quit menu or CURSOR ◀ to return to previous menu.

PLUG & PLAY

INITIAL SETUP

This graphic guide function will help you to properly set up your TV or Home Theater System. Simply answer two questions and a graphic will be displayed, showing you the optimum setup for your personalized system.

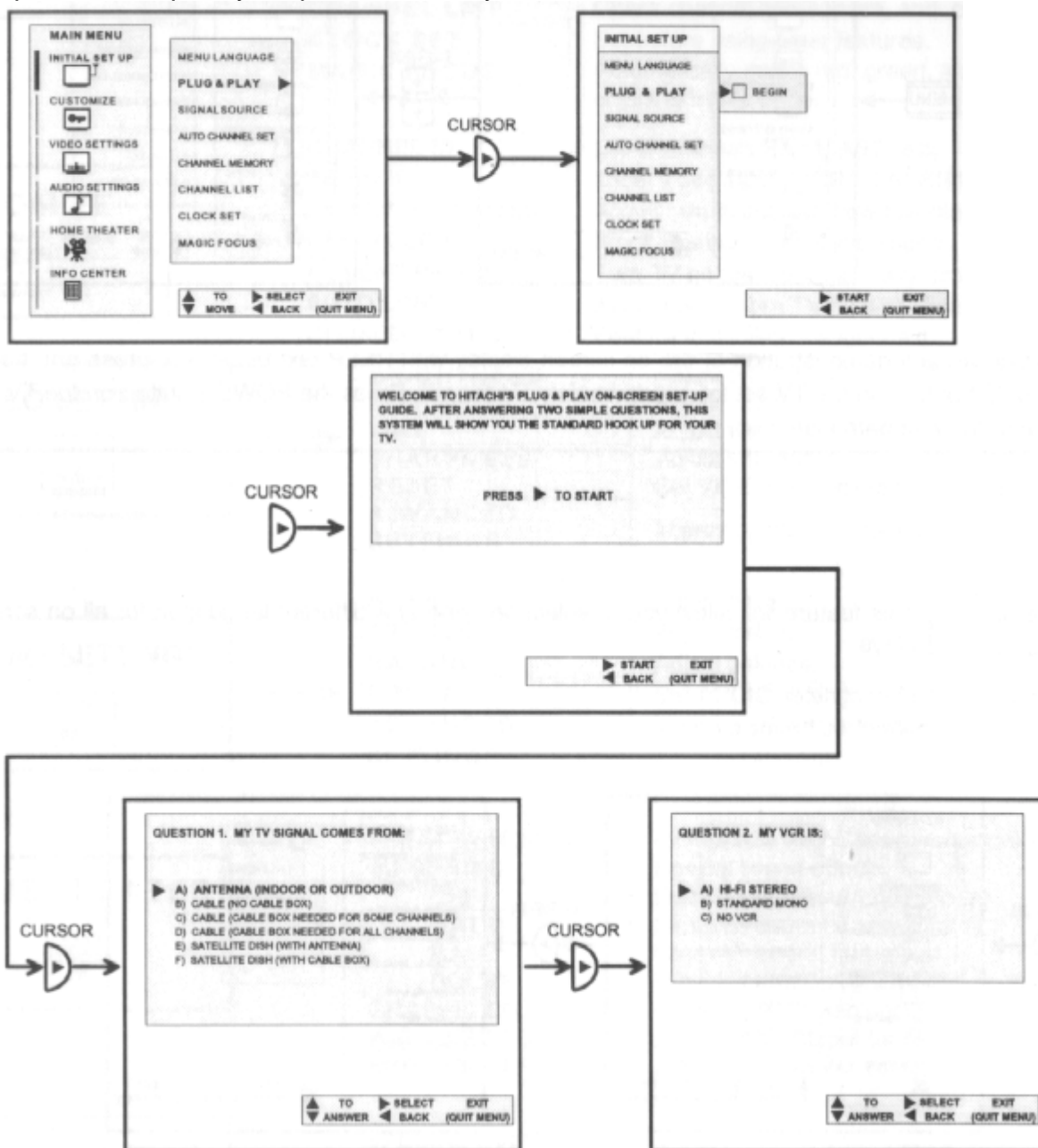

Press CURSOR ▲ or ▼ to highlight the correct answers to both questions.

Press CURSOR ► to display the graphic guide.

Press EXIT to quit menu or CURSOR ► to begin AUTO CHANNEL SET. (See page 36.)

SIGNAL SOURCE

Select ANTENNA if you are using an indoor or outdoor antenna. Select CATV if you

INITIAL SETUP

have cable TV.

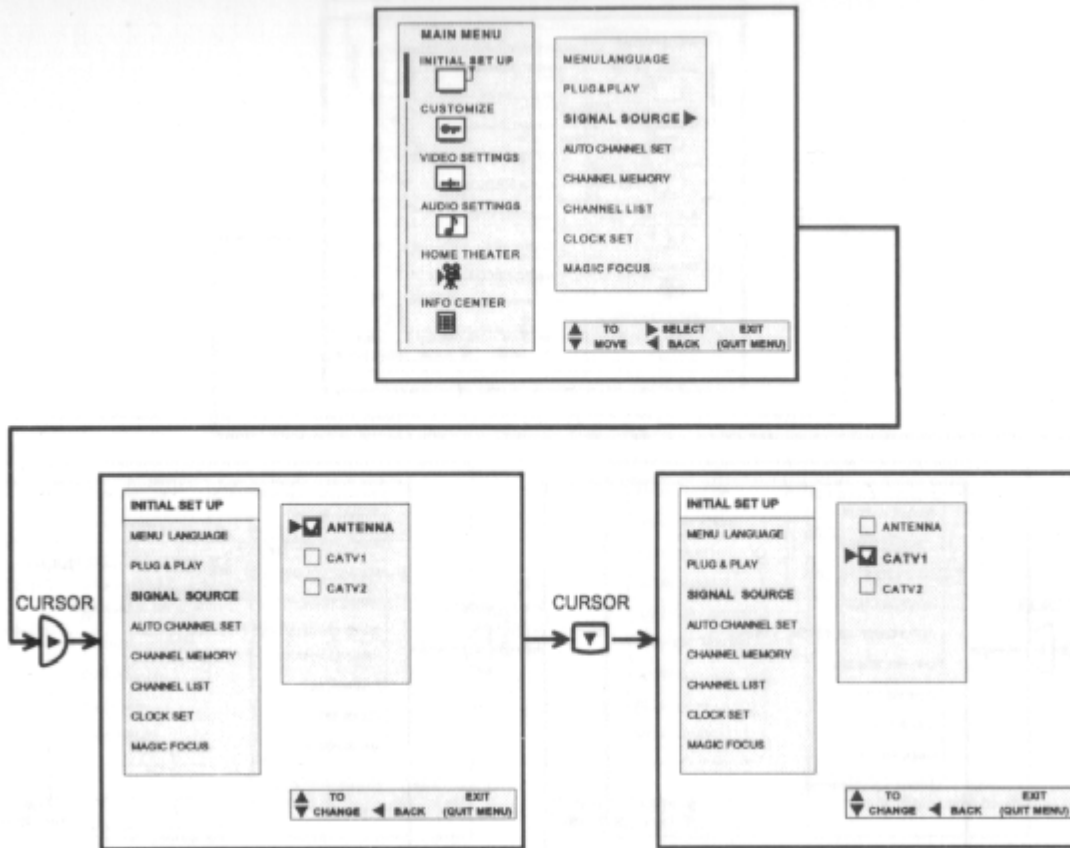

Press CURSOR ▲ or ▼ to highlight and select the correct SIGNAL SOURCE mode. Press EXIT to quit MENU or CURSOR ◀ to return to previous menu.

RECEPTION BAND		
AIR	CATV 1 or CATV 2	
	CATV CHANNEL	Indicated on the screen
VHF 2 ~ 13ch UHF 14 ~ 69ch	VHF 2 ~ 13	2 ~ 13
	Mid band A ~ I	14 ~ 22
	A-5 ~ A-1	95 ~ 99
	Super band J ~ W	23 ~ 36
	Hyper band W + 1 ~ W + 28	37 ~ 64
	Ultra band W + 29 ~ W + 84	65 ~ 125

Reception channels for each mode are shown at the left.

Refer to your cable or TV guide for channel identification standards.

If certain CATV channels are poor or not possible in CATV1 mode, set SIGNAL SOURCE to CATV2.

AUTO CHANNEL SET

This feature will automatically store active TV channels in CHANNEL MEMORY. This will allow you to skip over unused channels when using the CHANNEL UP (▲) or

INITIAL SETUP

DOWN (▼) buttons.

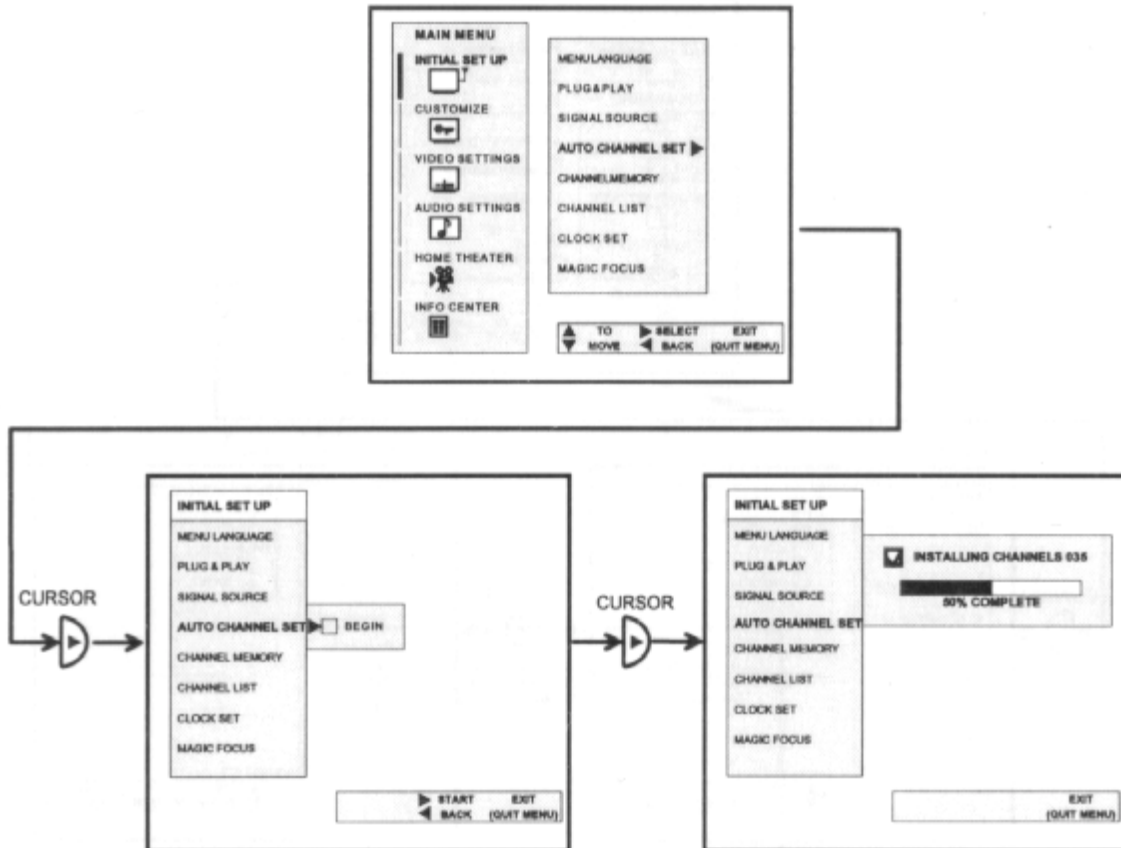

If the EXIT button is pressed while the AUTO CHANNEL SET function is engaged, programming will stop. If two antennas are connected, switch antenna inputs with the INPUT button and repeat AUTO CHANNEL SET for the second antenna input. Remember to select the correct SIGNAL SOURCE mode before using AUTO CHANNEL SET for the second antenna input. See CHANNEL MEMORY to add or erase additional channels.

CHANNEL MEMORY

Use this function after AUTO CHANNEL SET to add or erase additional channels to the remote control CHANNEL ▲ or ▼ buttons.

INITIAL SETUP

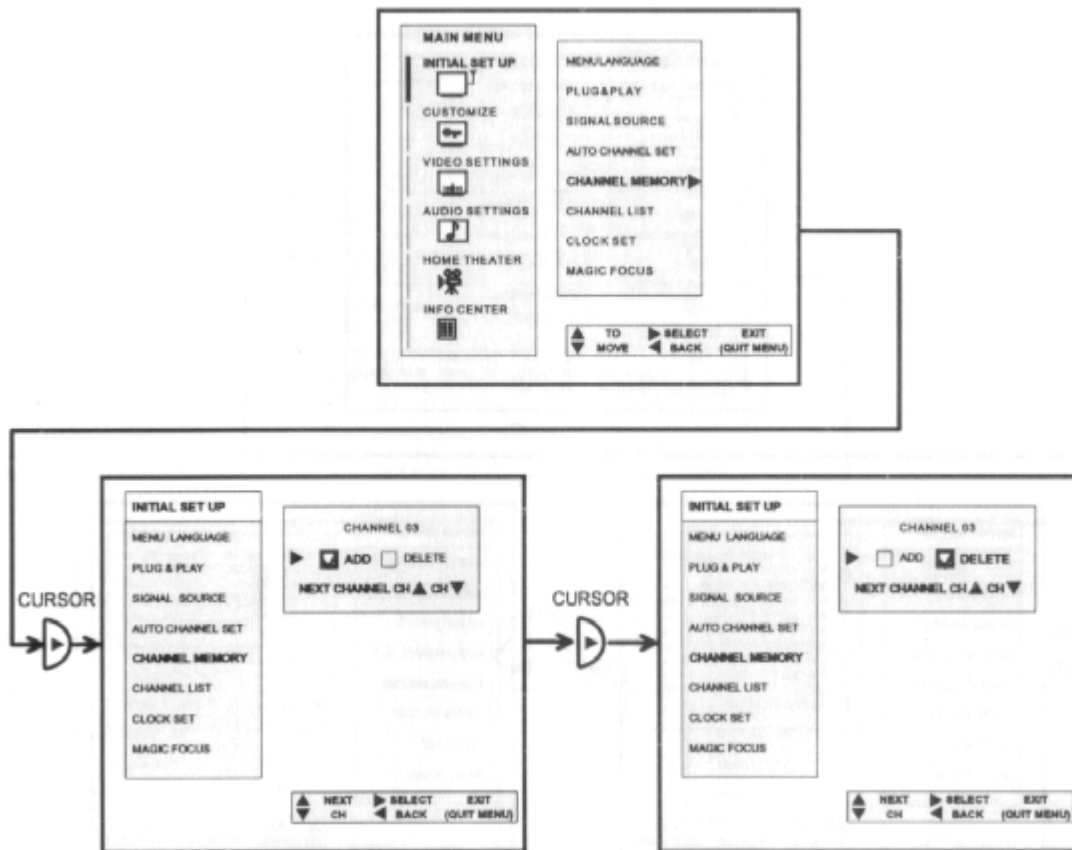

Add or erase additional channels while still in CHANNEL MEMORY using CURSOR ▲ or ▼, CHANNEL ▲ or ▼, and number buttons and then add or erase using the CURSOR ▶ button.

Press EXIT to quit menu or CURSOR ◀ to return to previous menu.

CHANNEL LIST

This function allows you to review which channels are labeled in CHANNEL ID (NAME) which have been added to CHANNEL MEMORY (SCAN), and which are protected by CHILD LOCK (LOCK).

INITIAL SETUP

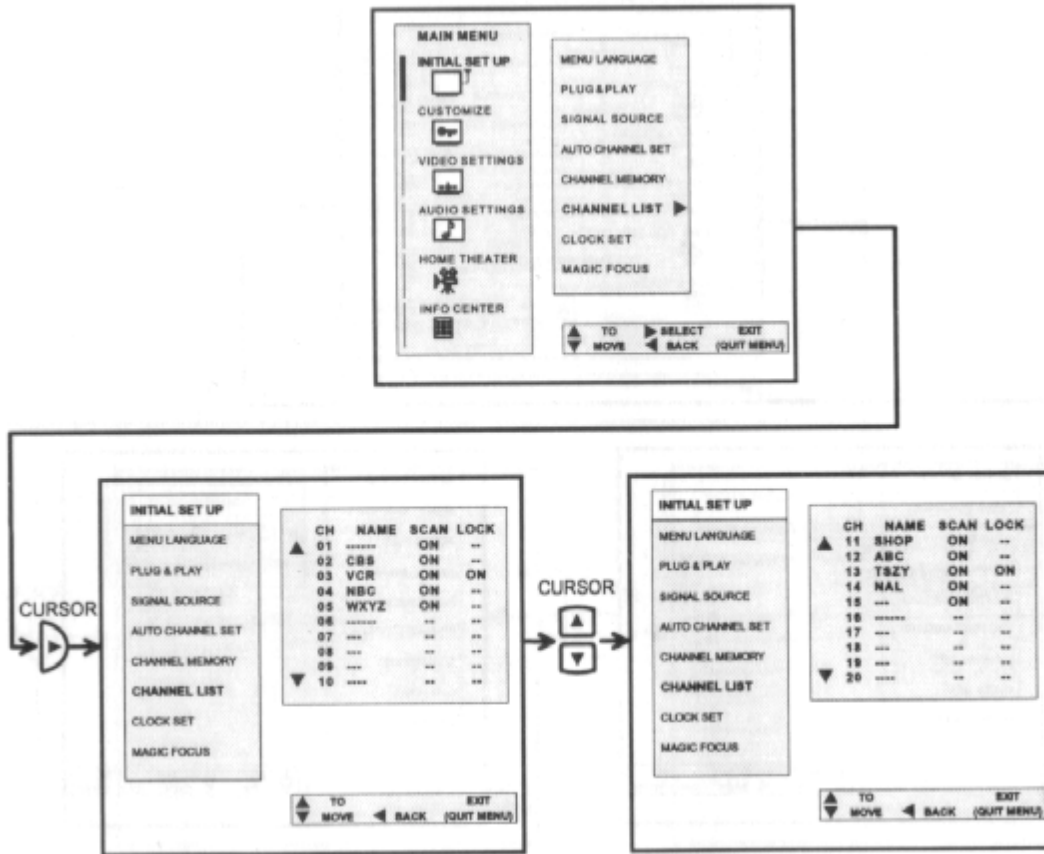

Press CURSOR ▲ or ▼ to review more channels.

Press EXIT to quit menu or CURSOR ◀ to return to previous menu.

CLOCK SET

The time must be set before you can use 4 EVENT PROGRAM, PERSONAL MESSAGE, SPECIAL EVENT REMINDER, or CALENDAR.

INITIAL SETUP

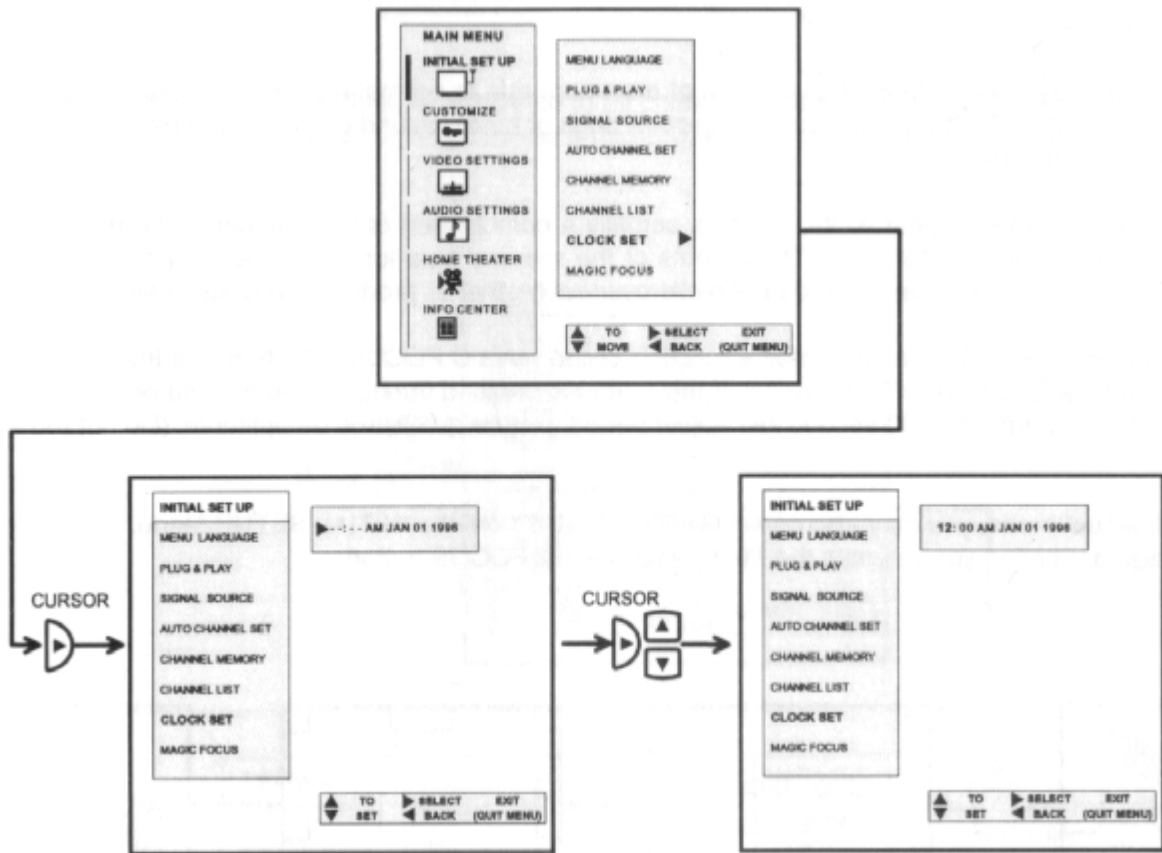

Use CURSOR ▲ or ▼ buttons to set the time, date, and year.

Press CURSOR ► to change position.

Press EXIT to quit menu or CURSOR ◀ to return to previous menu.

MAGIC FOCUS

Your projection TV has three color projection tubes: one for red, one for green, one for blue. When mixed together in the proper proportion, the output of these three color tubes can produce any color. To produce these colors, however, the beams must be precisely aligned over each other so that the colors can be mixed. The process of aligning these picture beams is called "convergence".

Over a period of time, the picture tubes can drift out of alignment due to normal bumps and vibrations or moving the TV. If you move your TV, or if, after a time, you notice color rings or halos around objects in the picture, you may want to converge (align) the colors.

Properly converged, the lines appear white, which is actually a combination of the outputs of the three color tubes. The output of the green tube is stationary. The outputs of the red and blue tubes can be adjusted. When properly aligned, the outputs of all three tubes should be directly over each other to produce the white lines.

To simplify convergence, HITACHI incorporates a function called MAGIC FOCUS, which allows the TV to self adjust. This process will take approximately 90 seconds. If this button is pressed during the 90 second period, no change in picture quality will occur. After this 90 second self adjust period, picture quality will be optimum. (Do not

INITIAL SETUP

move TV during self adjust.)

To enter this self adjust mode, you may also select MAGIC FOCUS from the INITIAL SETUP Menu. However, this will display a message prompting you to press the front panel MAGIC FOCUS button.

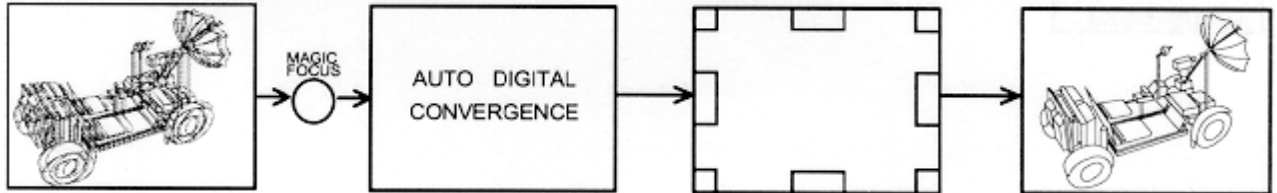

NOTE: Only a momentary press of the MAGIC FOCUS button is necessary to start AUTO DIGITAL CONVERGENCE. At any time during this convergence correction process, you may press the MAGIC FOCUS button to exit the MAGIC FOCUS mode.

Do not press the MAGIC FOCUS button for more than 3 seconds. This is only for extreme cases of misconvergence and requires assistance from service. If one of the pictures shown below appears on the television screen, press the MAGIC FOCUS button a second time to exit this manual set up mode.

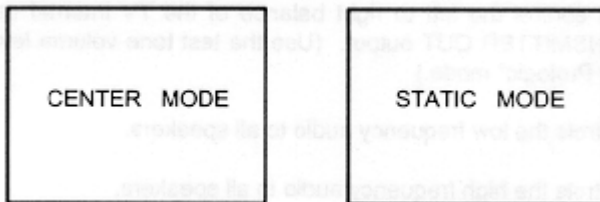

CUSTOMIZE



This selection contains advanced features which will make TV viewing easier and more enjoyable.

CHANNEL ID

Use this feature to give up to 20 channels a name when ANTENNA signal source is selected and up to 60 channels a name when CATV1 signal source is selected.

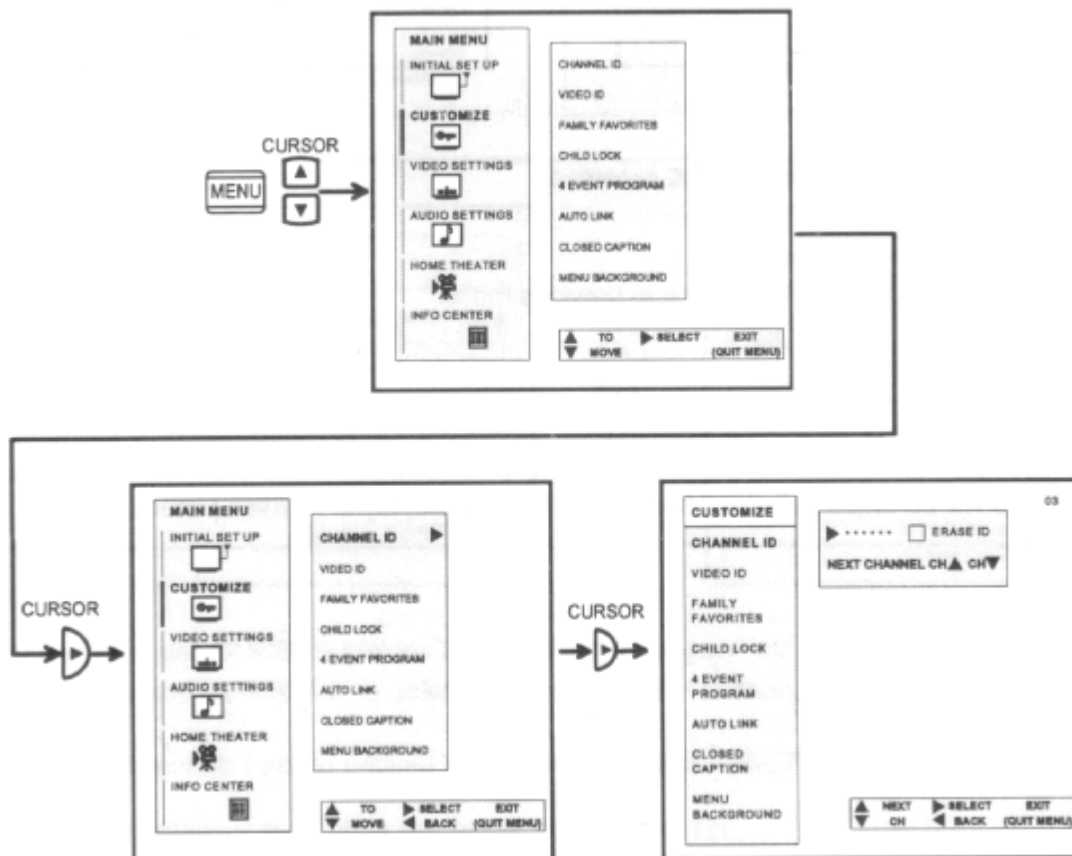

Press CURSOR ▲ or ▼ to select letters.

Press CURSOR ► to change character position.

Press CURSOR ▲ or ▼, CHANNEL ▲ or ▼, and the number buttons to select and label additional channels. The CHANNEL ID will now appear in the top left corner of the screen.

Press EXIT to quit menu or CURSOR ◀ to return to previous menu.

CUSTOMIZE

The (*) represents a blank space.
Select ERASE ID to erase a CHANNEL ID.

NOTE: CHANNEL ID will be displayed only when channel is displayed as main picture.

VIDEO ID

Use this feature to give a name to any of the 3 video inputs.

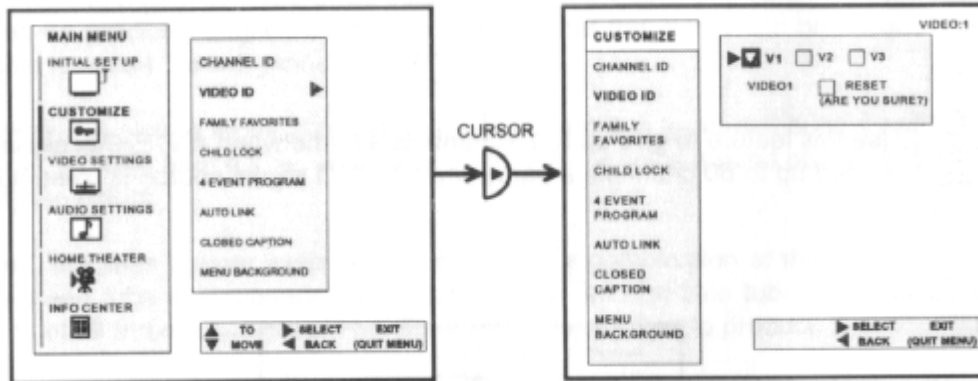

Press CURSOR to select the video input to be renamed.
Press CURSOR or to select letters.
Press CURSOR to change position.
Press EXIT to quit menu or CURSOR to return to previous menu.

The (*) represents a blank space.
Select RESET to set VIDEO to original condition.

NOTE: VIDEO ID will be displayed only when VIDEO input is displayed as main picture.

FAMILY FAVORITES (MENU)

This function allows you to group your favorite channels into 6 personalized categories that you can rename. A total of 24 channels for UX models and 42 channels for SX models can be stored in the FAMILY FAVORITES function.

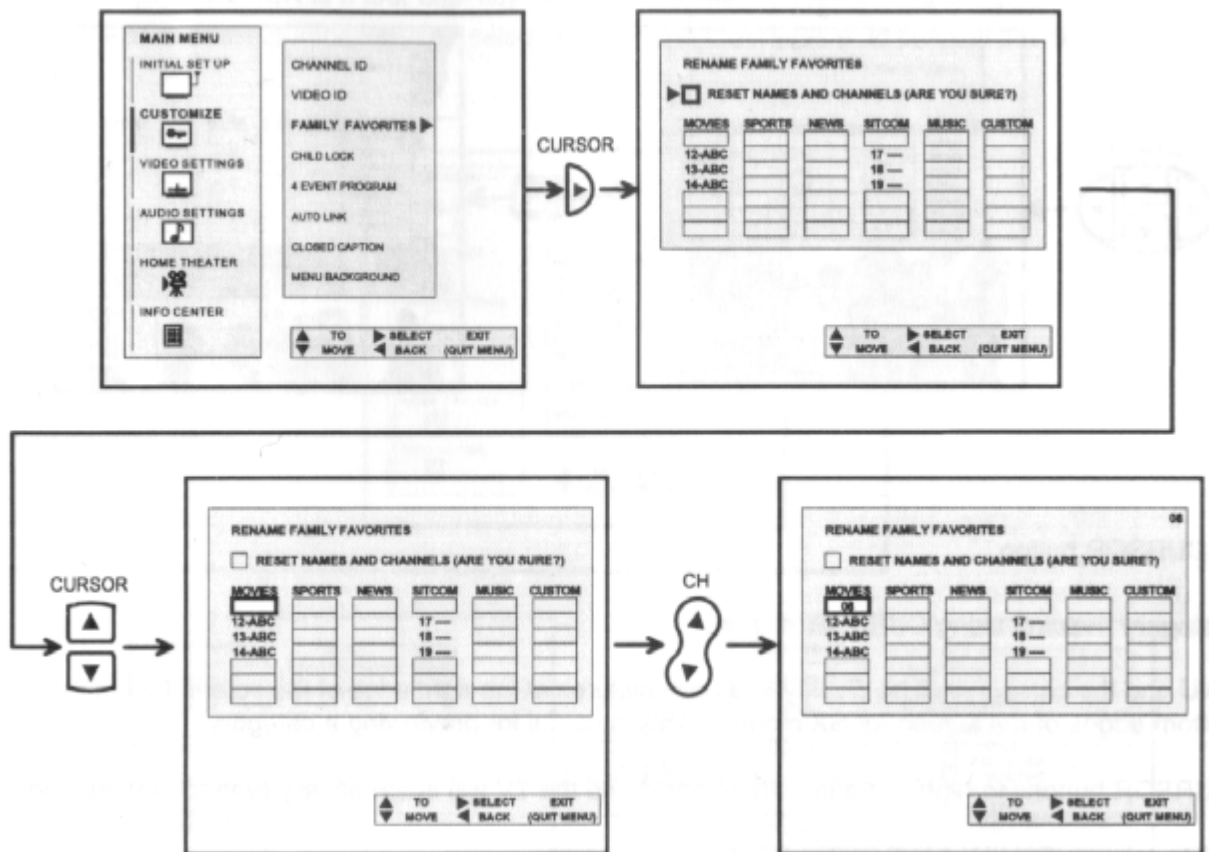

To rename the categories, use CURSOR buttons to highlight the category you would like to rename. Use CURSOR ▲ or ▼ to change a letter and CURSOR ► to select the next character to change.

To reset categories and channels back to original factory preset, select RESET then press CURSOR ►.

To enter a channel into a category, highlight a box below the category title.

Press CHANNEL ▲ or ▼ or the number buttons to enter the desired channel. Repeat until category has been set with your favorite channels. The channel to be added is displayed in the top right corner of the screen.

Enter channel 00 to erase a favorite channel.

NOTE: This function cannot be access when ANT B is the main channel.

FAMILY FAVORITES (OPERATION)

Use this function to tune the main picture to a desired favorite channel.

CUSTOMIZE

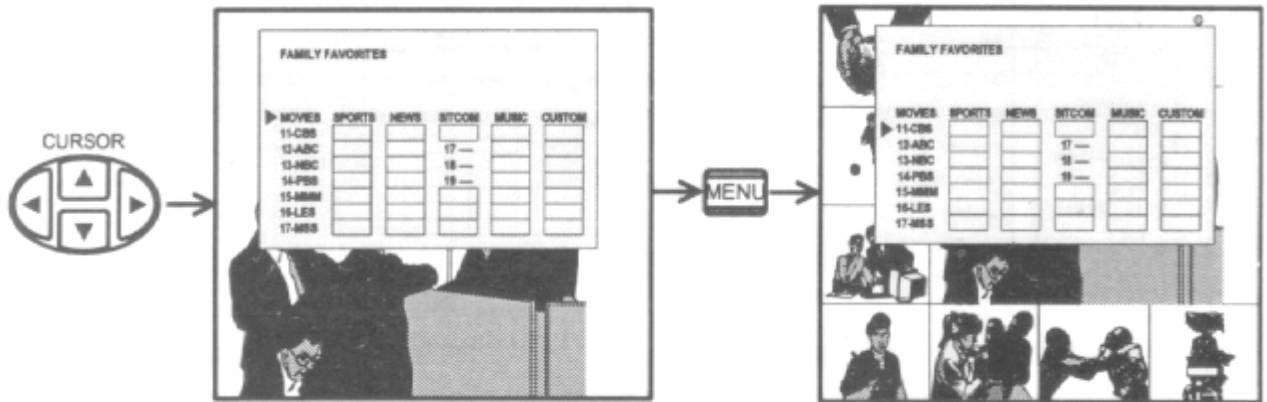

Press any CURSOR button.

Select a category heading using CURSOR ◀ or ▶.

Press MENU and the category will be displayed as sub-pictures at the right edge of the screen for UX models and the left and bottom edges of the screen for SX models. This is useful for previewing a category.

Use the CURSOR buttons to highlight a favorite channel and the TV will automatically tune to that channel.

Press EXIT to remote FAMILY FAVORITES OSD from the screen.

NOTE: If a category has some blank channel entries, these channels will appear as black sub-pictures.

CHILD LOCK

This function will block out the picture and sound of the selected channel or video input. It can also be used to keep the TV from being viewed for a scheduled amount of time that you set.

The code to enter CHILD LOCK is a four digit key number. The factory preset code is 0000.

Use CURSOR ▲ or ▼ or the number keys to select number and CURSOR ▶ to change position.

CUSTOMIZE

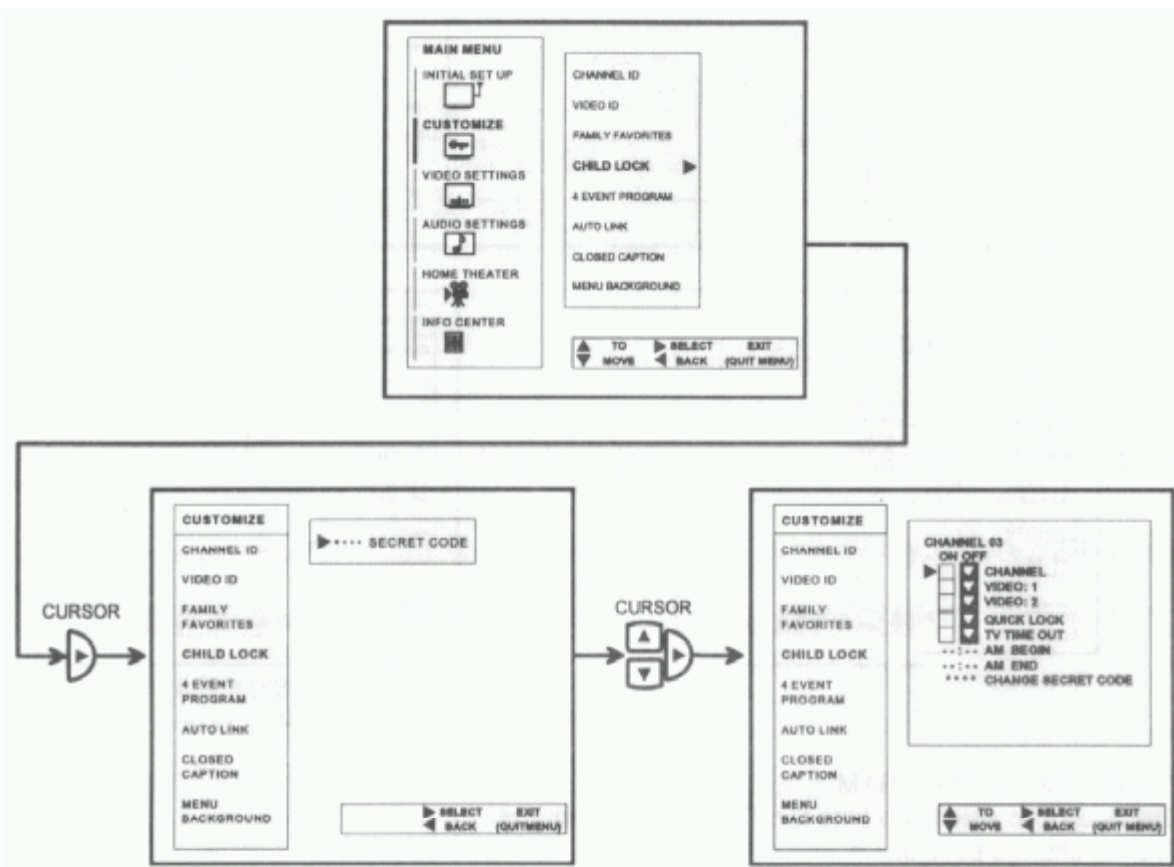

Use CURSOR ▲ or ▼ to highlight function and CURSOR ► to set ON or OFF.

When CHANNEL is turned on, the picture and sound for the chosen channel will be blocked out.

When VIDEO: 1, 2 or 3 is turned on, the picture and sound for the chosen video input will be blocked out (To lock a Video input, you must be tuned to the input you wish to lock).

When QUICK LOCK is turned on, the picture and sound for channels 3, 4 and all Video inputs will be blocked out.

When TV TIME OUT is turned on, you can set the BEGIN and END times and the TV cannot be viewed during that time period.

To change the key number, select CHANGE SECRET CODE. Enter a new four digit key number you prefer.

If you forget your key number, use the factory code 7777 to erase your key number. This will reset the key number back to the factory preset 0000.

NOTE: If ANT A and ANT are in the same SIGNAL SOURCE mode (see page 35), when a channel is locked, it is locked on both antenna inputs.

When using TV TIME OUT make sure the clock is set (see page 39).

4 EVENT PROGRAM

CUSTOMIZE

This function will automatically turn the TV on and off, one time only, every day or once a week.

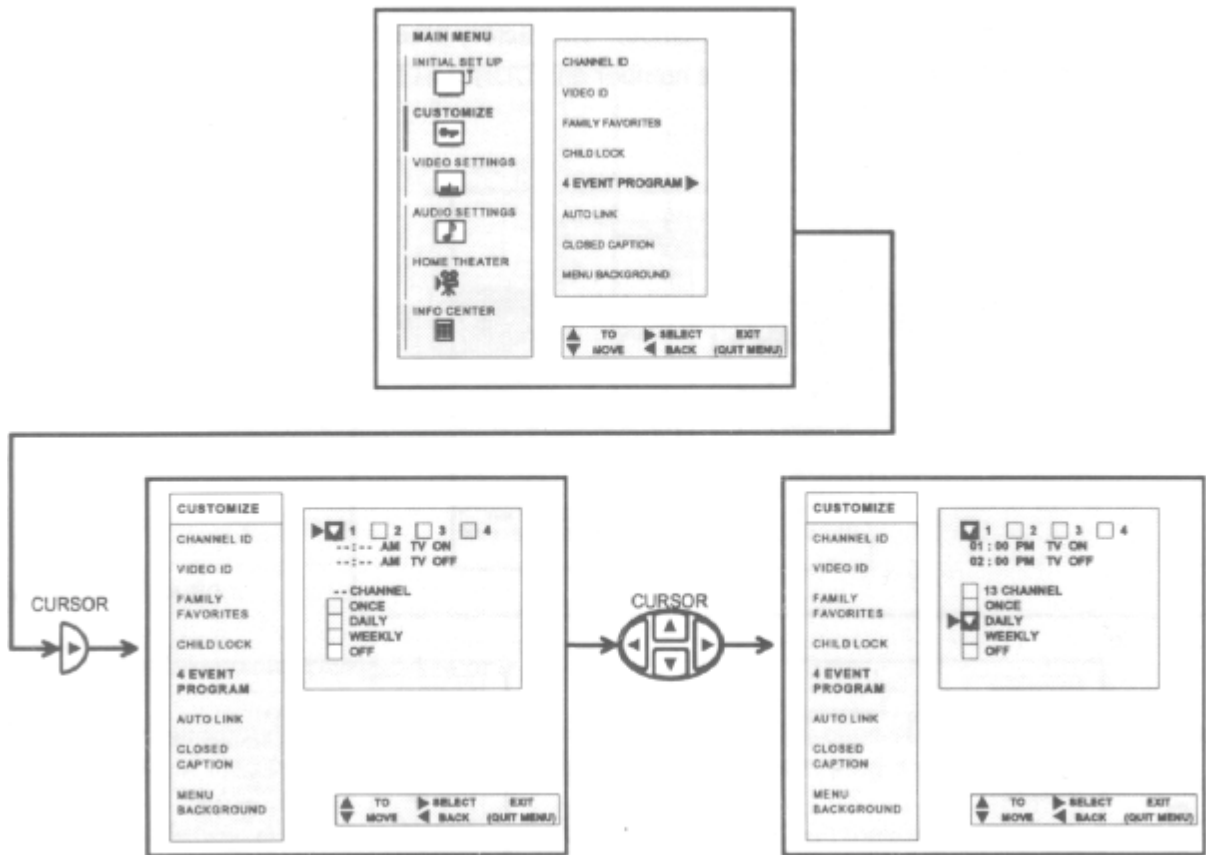

Press CURSOR **▶** to select PROGRAM 1, 2, 3 or 4.

Press CURSOR **▲** or **▼** to select the time the TV will turn on and off.

Use CURSOR **▶** to change position.

Press CURSOR **▲** or **▼** to highlight then CURSOR **▶** to select MODE: ONCE (one time only) or MODE: DAILY (TV will turn on/off at the same time every day), or MODE: WEEKLY (TV will turn on/off at same time every week).

Press CURSOR **▲** or **▼**, CHANNEL **▲** or **▼**, or number buttons to set the channel the TV will tune to when it automatically turns on.

NOTE:

The OFF Timer will only activate if the TV was turned on or tuned with the ON timer and no channel selection was made after this time. If you change the channel after the ON Timer has been activated, the OFF Timer will deactivate.

One certain models, the Mode: WEEKLY will turn the TV on/off every week day.

If no remote control button is pressed after ON timer is activated, the TV will automatically turn off after 3 hours.



CAUTION: Do not use your TV as a deterrent when away from home by using the

ON and OFF TIMERS. For safety, the TV should be turned off when you are away from home.

AUTO LINK

Use this function to automatically turn the TV on and tune to VIDEO: 1 when it detects a VIDEO: 1 input.

PICTURE

Use CURSOR ▲ or ▼ to change AUTO LINK setting.



When AUTO is selected, the TV will turn on and tune to VIDEO: 1 automatically, when a VIDEO: 1 input is detected. This is convenient when you want to watch a movie with your VCR or Laser Disc Player.

When REMOTE is selected, the TV will turn on and tune to VIDEO: 1 automatically, when a VIDEO: 1 input is detected and the VCR play button on your remote control is pressed.

This is convenient when you want to record a movie with your VCR and watch it later. Select OFF to disable this function.

Press EXIT to quit menu or CURSOR ◀ to return to previous menu.

CLOSED CAPTION

Closed captions are the dialogue, narration, and/or sound effects of a television program or home video which are displayed on the TV screen. Your local TV program guide denotes these programs as  or .

PICTURE

DISPLAY: ON/OFF will turn the  display on or off.

MODE: C.C. (Closed Caption) is for the program you are viewing.

MODE: TEXT is for additional information such as news reports or a TV program guide.

This information covers the entire screen and viewing the TV program is not

possible. TEXT may not be available with every  program.

CHANNEL: 1 is used for the primary language (usually English).

CHANNEL: 2 is sometimes used for a second language (may vary by region).

Use CURSOR ▲ or ▼ to highlight the function to change; press CURSOR ▶ to change the function.

Press EXIT to quit menu or CURSOR ◀ to return to previous menu.

NOTE: If you do not have sound, make sure MUTE is not set. CCD will display when "MUTE" is pressed, whether CCD is in the "ON" or "OFF" mode.

MENU BACKGROUND

CUSTOMIZE

This function allows you to choose from 2 MENU BACKGROUNDS.

PICTURE

Use CURSOR ▲ or ▼ to change the MENU BACKGROUND setting.

Select SHADOW and a light background is visible. Select CLEAR and no background is visible.

Press EXIT to quit menu or CURSOR ◀ to return to previous menu.

VIDEO SETTINGS

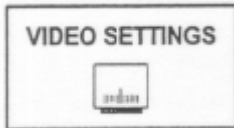

Select VIDEO SETTINGS to adjust picture settings and improve picture quality.

PICTURE

Use the CURSOR ▲ or ▼ to highlight the function to be adjusted.

Press CURSOR ◀ or ▶ to adjust the function.

Use CURSOR ▲ or ▼ to highlight RESET or ADVANCED SETTINGS, then CURSOR ◀ to return to previous menu.

Press EXIT to quit menu.

NOTE: If CONTRAST is selected, you are adjusting CONTRAST. The additional menu items BRIGHTNESS, COLOR, TINT, and SHARPNESS can be selected and adjusted in the same manner.

CONTRAST

Use this function to change the contrast between black and white levels in the picture. This adjustment will only affect the picture when PICTURE SETTINGS AI is OFF. (See page 51.)

BRIGHTNESS

Use this function to adjust overall picture brightness.

COLOR

Use this function to adjust the level of color in the picture.

TINT

Use this function to adjust the flesh tones so they appear natural.

SHARPNESS

Use this function to adjust the amount of fine detail in the picture.

RESET

When RESET is selected, press CURSOR ► to return video adjustments to factory preset conditions.

ADVANCED SETTINGS

Your HITACHI TV has an AI (Artificial Intelligence) function which automatically adjust picture settings to produce the highest quality picture possible.

When AI is highlighted, use CURSOR ► to turn the AI on or off.

PICTURE

Use CURSOR ▲ or ▼ to select function.

Use CURSOR ► to change the function setting.

Press EXIT to quit menu or CURSOR ◀ to return to previous menu.

AI (ARTIFICIAL INTELLIGENCE)

When the AI function is on, the TV's internal computer will perform the following:

1. Automatically monitor and adjust contrast depending on room lighting (sensor is located in the front panel) to produce a more natural picture.
2. Automatically monitor and adjust color levels and maintain natural flesh tones.
3. Automatically compensate for weak or strong TV signals to produce a clear picture.

Turn the AI function off to control other PREFERENCE SETTINGS.

AUTO COLOR

The AUTO COLOR function automatically monitors and adjusts the color to maintain constant color levels even after a program or channel changes. It also maintains natural flesh tones while preserving fidelity of background colors. For best picture performance leave the AUTO COLOR function on.

NOISE REDUCTION

The NOISE REDUCTION function automatically reduces conspicuous noise in the picture without degrading picture quality.

SUPER CONTRAST

Turn on SUPER CONTRAST to improve picture detail in areas of high brightness.

COLOR TEMPERATURE

Set this to WARM for hotter colors with more red, or set to COOL for less intense colors with more blue.

AUDIO SETTINGS



Select AUDIO SETTINGS to adjust the TV to your preference and to improve the sound quality.

PICTURE

Use the CURSOR ▲ or ▼ to highlight the function to be adjusted.

Press CURSOR ◀ or ▶ to adjust the function.

Use CURSOR ▲ or ▼ to highlight RESET or ADVANCED SETTINGS, CURSOR ◀ to return to previous menu.

Press EXIT to quit menu.

NOTE: If BASS is selected you are adjusting BASS. The additional menu items TREBLE and BALANCE can be selected and adjusted in the same manner.

BASS

This function controls the low frequency audio to all speakers.

TREBLE

This function controls the high frequency audio to all speakers.

BALANCE

This function will control the left to right balance of the TV internal speakers, the AUDIO TO HI FI output, and TRANSMITTER OUT output (Use the test tone volume levels to control balance when in "Surround-Dolby" Mode).

RESET

When RESET is selected, press CURSOR ▶ to return audio adjustments to factory preset conditions.

NOTE: When BASS or TREBLE are adjusted, the GRAPHIC EQUALIZER will be set to original factory conditions.

ADVANCED SETTINGS

AUDIO SETTINGS

Use **ADVANCED SETTINGS** to improve the sound performance on the TV depending on listening conditions.

PICTURE

Press **CURSOR** ▲ or ▼ to highlight a function.

Press **CURSOR** ► to change the function setting.

Press **EXIT** to quit menu or **CURSOR** ◀ to return to previous menu.

MTS MODE

(Multi-Channel Television Sound) will allow you to select **STEREO** (a stereo broadcast), **SAP** (second audio program) which may be a secondary language, weather report, etc. or **MONO** (monaural sound) used when receiving a weak stereo broadcast.

The sources received will be displayed below the channel number. The source you select will be displayed to the left of the channel number. See example below for each selection when both stereo and second audio are received (monaural is always received).



PERFECT VOLUME

This function will automatically adjust volume so each channel has the same average volume level. (This function will be automatically set to off and cannot be turned on when **HOME THEATER-DOLBY** mode is selected.)

AUTO NOISE CANCEL

This function eliminates the noise in between stations. If a channel is tuned and is noisy, this function will automatically eliminate the audio for that channel.

DYNAMIC BASS

This function allows you to enjoy spectacular bass sound that would normally be heard only with expensive home speaker systems.

LOUDNESS

This function will improve the quality of both low and high frequency sounds when listening at low volume levels. (Enabling this function will automatically reset your **GRAPHIC EQUALIZER**.)

INT. SPEAKERS

This function is useful when first setting up the external speakers, or if you prefer to use only speakers from a separate stereo system.

NOTE: If the optional left and right speakers are connected while in **HOME THEATER-DOLBY NORMAL**, the internal speakers may be turned off for better separation between the left, center, and right channels. The center channel audio will still be heard from the

AUDIO SETTINGS

television's center speaker.

HOME THEATER



Use this function to choose Picture and Sound settings for a true HOME THEATER experience.

THEATER MODES

Use this function to choose from automatic picture and sound settings to optimize your TV's performance.

PICTURE

Use CURSOR ▲ or ▼ or the HOME THEATER button on your remote control to change THEATER MODES settings. When MOVIE mode is chosen, AI and DYNAMIC BASS are automatically set to ON.

When SPORTS mode is chosen, AI is automatically set to ON while DYNAMIC BASS is automatically set to OFF.

Press EXIT to quit menu or CURSOR ◀ to return to previous menu.

SURROUND

The following surround settings will reproduce the "live" sound you would hear in concert halls, sports stadiums, movie theaters, etc. when you set up your speaker system as shown in the section on rear panel connections on pages 13-15. The surround system is most effective with movie and other stereo material that is Dolby Surround encoded, and played on a stereo VCR.

PICTURE

When using WIRELESS SOUND (TRANSMITTER OUT jacks on rear panel), REAR SPEAKERS mode must be chosen to receive the Surround audio program.

To enter the SURROUND MODE, use CURSOR ▲ or ▼ to highlight then press CURSOR ▶ to select SURROUND MODE of your choice.

Now press CURSOR ▲ or ▼ to highlight, then press CURSOR ▶ to select function to be adjusted.

Use CURSOR ◀ or ▶ to adjust the volume of rear and main speakers. Main volume also controls AUDIO TO HI-FI. Adjust Main volume first.

Each surround setting has separate main and rear volume controls, except OFF and Dolby 3CH which have no rear volume controls. DOLBY PRO LOGIC also has a center volume, while MATRIX and HALL have balance controls. (Balance while in DOLBY PRO LOGIC mode is adjusted by using the TEST TONE volume controls.)

The center and rear volume will increase or decrease when main is adjusted to keep an equal balance between the surround channels.

The maximum volume allowed for the center and rear will depend on how loud the main

volume is set.

SURROUND OFF

Use this for normal stereo/mono broadcasts.

MATRIX SURROUND

Listener is surrounded by many sound sources such as a sporting event, etc.

NOTE: Some TV systems do not transmit optimum audio channel separation which can reduce the effectiveness of the MATRIX SURROUND function.

HALL SURROUND

Resonant sound - Listener has the feeling of being in a concert hall.

DOLBY PRO LOGIC

Dolby Pro Logic provides four separate sound channels: left, center, right and surround.

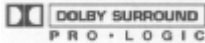
For a properly encoded program marked  the center sound channel contains the dialogue for the program viewed. The left and right channels produce sound effects that will match the action on the TV screen. For example, Dolby Pro Logic will enhance the effect of a car viewed driving from the left side of the TV screen to the right side. The surround channel (speakers) are placed behind the viewing area to add additional spatial sound effects.

To fully benefit from Dolby Pro Logic Surround, it is recommended that the surround speaker system be complete as shown on page 15.

PICTURE

Press CURSOR ▲ or ▼ to highlight a surround function.

Press CURSOR ► to change the surround function.

The function can be set to 3CH LOGIC or PRO LOGIC. When 3CH LOGIC is set, the surround channel sound is split equally between the left and right speakers of a separate audio amplifier. When PRO LOGIC is set, separate surround speakers must be used.

Also, the function can be set to NORMAL or TV AS CENTER. When NORMAL is set, center channel sound is sent to the TV center speaker only. When TV AS CENTER is set, center channel sound is split equally between the left and right TV speakers.

TEST TONE

A test sound is generated allowing the listener to balance volume from each channel. Adjust the volume levels until all channels are equal.

PICTURE

Press CURSOR ▲ or ▼ to highlight, then press CURSOR ► to select TEST TONE.

Use CURSOR ◀ or ▶ to adjust VOLUME. (Adjust balance by adjusting Front L and Front R volume control.)

Press EXIT to quit menu or MENU to return to previous menu.

NOTE: When in Dolby Surround Mode, the Audio-Advanced Settings-Perfect Volume feature will automatically be set to off mode.

GRAPHIC EQUALIZER

Use this function to precisely control tonal quality by using seven different frequency controls.

PICTURE

Press CURSOR **▶** to select the frequency you wish to adjust.

To increase the amount of frequency audio to all speakers, use CURSOR **▲**.

To decrease the amount of frequency audio to all speakers, use CURSOR **▼**.

Press EXIT to quit menu or CURSOR **◀** to return to previous menu.

NOTE: When this function is used or adjusted, the AUDIO SETTINGS functions BASS, TREBLE, and LOUDNESS will be reset to original factory conditions.

WIRELESS SOUND

This feature allows you to choose between 3 possible variable audio outputs for a separate set of wireless speakers or another stereo amplifier. The audio output may be either MAIN TV AUDIO, SUB PICTURE AUDIO, or REAR SPEAKERS.

This feature also allows you to turn the internal speakers on or off, when MAIN TV AUDIO is chosen. You can also adjust PIP volume if you have chosen SUB PICTURE AUDIO as your variable audio output.

PICTURE

Press CURSOR **▲** or **▼** to highlight a function.

Press CURSOR **▶** to select the function.

Press EXIT to quit menu or CURSOR **◀** to return to previous menu.

MAIN TV AUDIO

When set to MAIN TV AUDIO mode, your wireless speakers will play the same audio as played on your TV. When set to this mode, you may choose to turn the television's internal speakers on or off. Also, the volume of your wireless speakers will be controlled by the TV volume control.

SUB PICTURE AUDIO

When set to SUB PICTURE AUDIO mode, your wireless speakers will play the PIP sub-picture audio program. The volume of your wireless speakers will now be controlled by the PIP VOL. control, which may be varied from 00 (min.) to 32 (max.). If no sub-picture is displayed, no audio program is heard.

REAR SPEAKERS

When set to REAR SPEAKERS mode, your wireless speakers will play the Surround audio program. The volume of your wireless speakers will be controlled by the TV volume control, dependent upon the amount of REAR selected from SURROUND

mode. (See pages 56 and 58.)

SUB WOOFER

Use this feature to provide variable audio output to optional sub woofer.

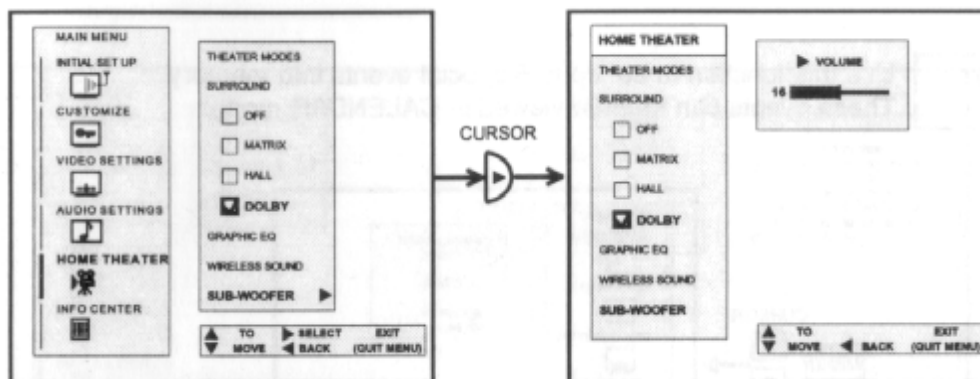

Use CURSOR ▼ to select the volume adjustment bar.

Use CURSOR ◀ or ▶ to adjust SUB WOOFER volume.

Press EXIT to quit menu or CURSOR ▲ to highlight VOLUME, then CURSOR ◀ to return to previous menu.

INFO. CENTER

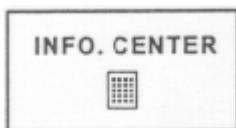

This function allows your TV to assist you with your busy day to day schedule.

PERSONAL MESSAGE

Use this function to set one or two personal messages once a day or one time only.

Press CURSOR **▶** to select Message 1 or Message 2.

Press CURSOR **▲** or **▼** to select a letter or other character.

Press CURSOR **▶** to change position.

The asterisk (*) represents a blank space.

Use CURSOR **▲** or **▼** until ERASE MESSAGE is highlighted, then press CURSOR **▶** to erase message.

Press CURSOR **▲** or **▼** to choose MODE or TIME.

Press CURSOR **▶** to set MODE when it is highlighted.

Press CURSOR **▲** or **▼** or number buttons to set the time.

Press EXIT to quit menu or CURSOR **◀** to return to previous menu.

NOTE: At the selected time, the message will be displayed until a remote control button is pressed.

SPECIAL EVENT REMINDER

Use this function to set up to 6 special events into memory.

These events can then be viewed in CALENDAR mode.

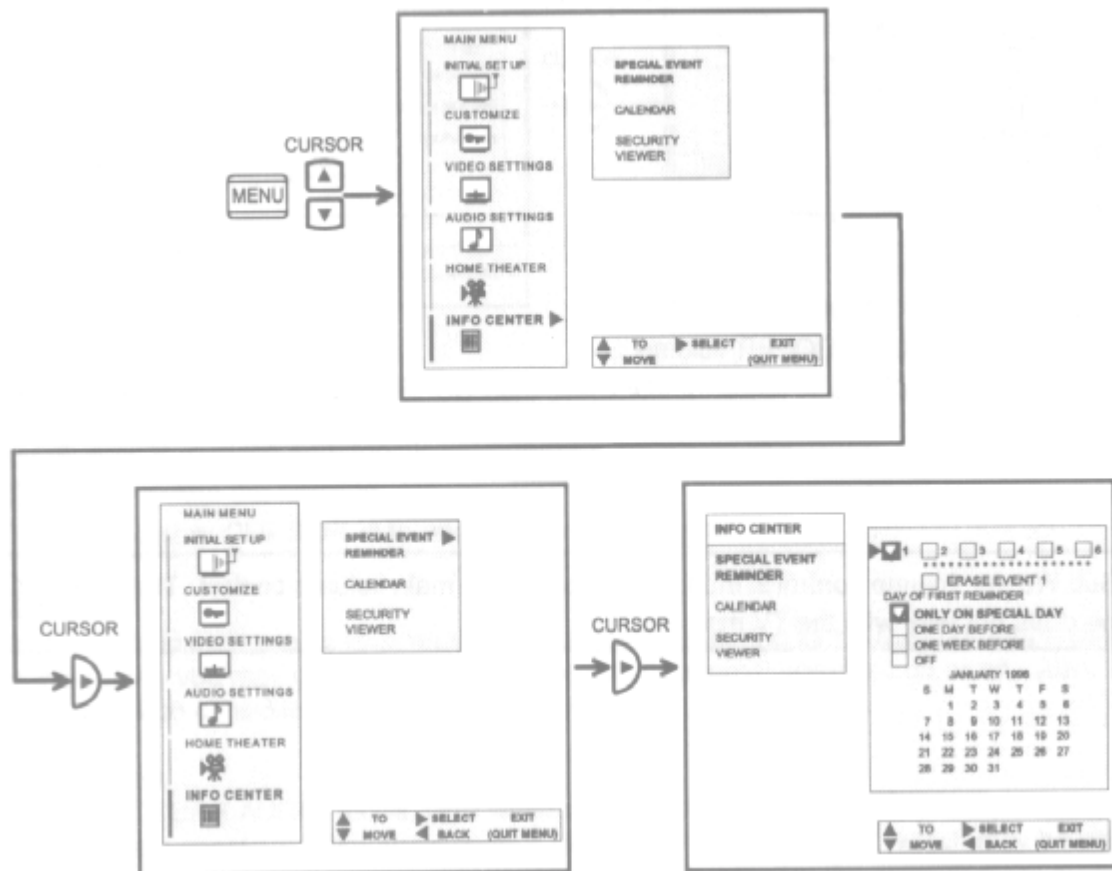

Press CURSOR ► to select EVENT 1 to 6.

Press CURSOR ▲ or ▼ to select a letter.

Press CURSOR ► to change position.

To erase Special Event, select ERASE EVENT then press CURSOR ►.

Highlight the day of first reminder using CURSOR buttons, then press CURSOR ► to select.

Select day of reminder using CURSOR buttons.

To exit date set mode but remain in SPECIAL EVENT REMINDER menu, press the MENU button.

Press EXIT to quit menu or CURSOR ◀ to return to previous menu.

NOTE: Special events set into memory will appear as blinking green dates in CALENDAR mode. At the selected time, the message will appear in CALENDAR mode. When the TV is turned on, the SPECIAL EVENT REMINDER message will automatically appear at the selected time. Each special event message can be a maximum of 20 characters long.

CALENDAR

Use this function to check the day, month, and year.

INFO. CENTER

Dates programmed in SPECIAL EVENT REMINDER will appear blinking and special event message will be displayed.

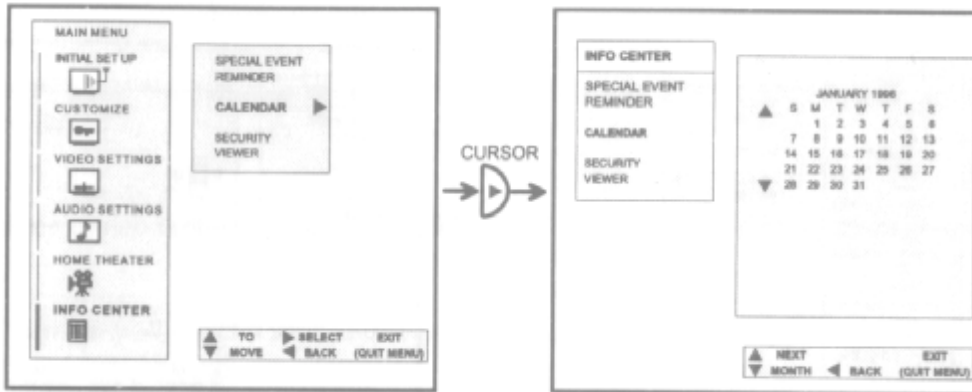

Press CURSOR ▲ or ▼ to change the month.

Press EXIT to quit menu or CURSOR ◀ to return to previous menu.

NOTE: Dates of SPECIAL EVENT REMINDER will appear blinking. Special event message will be displayed only if current date is within the Day Of First Reminder Specifications as chosen in SPECIAL EVENT REMINDER. (See page 6?.)
CALENDAR will appear blinking when a Special Event message is set.

SECURITY VIEWER

Use this feature to set VIDEO: 2 input to automatically appear in the PIP.

This is useful when you want to view the image from an optional camera in the baby's room or at your front door.

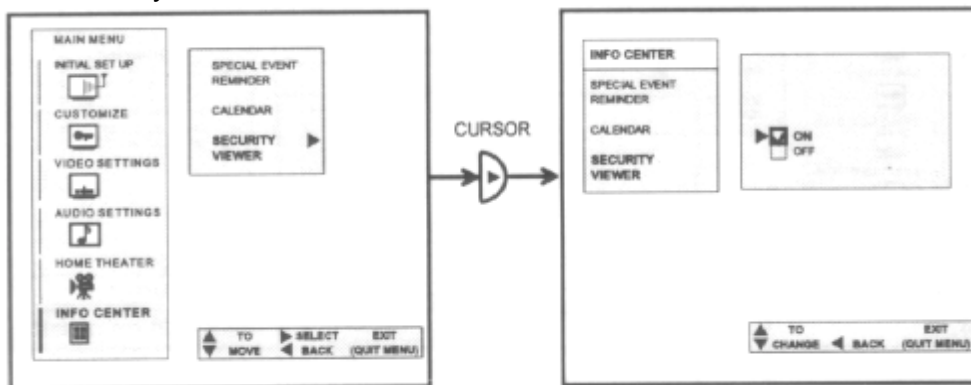

Press CURSOR ▲ or ▼ to change SECURITY VIEWER setting.

When ON is selected, the PIP will turn on and tune to VIDEO: 2 automatically, when a VIDEO: 2 input is detected. The PIP will automatically disappear after 30 seconds.

Press EXIT to quit menu or CURSOR ◀ to return to previous menu.

CARE OF YOUR HITACHI PROJECTION TV AND YOUR REMOTE CONTROL

DO

Dust the screen and cabinet with a soft cloth.

Clean the screen with a soft cloth moistened with warm water. Dry with a soft cloth. (A mild soap may be used if the screen is extremely dirty.)

Place your TV and remote control away from extreme heat, humidity and extremely dusty places.

Remove the plug from the wall outlet if your television will not be used for a long period of time, for instance, when you go on vacation

DO NOT

Do not clean your screen or cabinet with strong cleaners, polishes or a chemically treated cloth.

Do not place rubber or vinyl products or cellophane tape on your set.

Do not touch the screen too often.

Do not subject the remote control to shocks such as dropping it on the floor, etc.

Physical damage to the precision parts may result.

Avoid placing the remote control in a high humidity place or getting it wet. Don't leave it on or near a heater. Excessive heat or moisture may cause the unit to cease operation.

When the batteries run down, remote control operation will become erratic or possibly stop altogether.

Replace the old batteries with fresh "AA" size batteries.

Exposure of the viewing screen to prolonged direct sunlight or heat may cause the screen to permanently warp, resulting in a distorted picture.

RECEPTION PROBLEMS

**• IGNITION NOISE:**

Black spots or horizontal streaks may appear, picture may flutter or drift. Usually caused by interference from automobile ignition systems, neon lamps, electrical drills and other electrical appliances.

**• GHOSTS:**

Ghosts are caused by the television signal following two paths. One is the direct path and the other is reflected from tall buildings, hills or some other objects. Changing the direction or position of the antenna may improve reception. Ghosting may also be caused by defects in the antenna system such as unshielded leads or connecting several sets to the same antenna without using multiple antenna couplers.

**• SNOW:**

If your receiver is located in the fringe area of a television station where the signal is weak, your picture may be marred by the appearance of small dots. When the signal is extremely weak, it may be necessary to install a special antenna to improve the picture.

**• RADIO FREQUENCY INTERFERENCE:**

The interference produces moving ripples or diagonal streaks, and in some cases, causes loss of contrast in the picture.

CHECK HERE BEFORE CALLING FOR SERVICE

CHECK HERE BEFORE CALLING FOR SERVICE

Troubleshooting chart.

This Projection Television incorporates advanced power surge protection technology designed to protect against component or circuit damage due to internal voltage or power surges.

IF YOUR SET SHOULD APPEAR TO HAVE A LOSS OF POWER, PLEASE FOLLOW THIS PROCEDURE:

- 1) Push the power switch (ON/OFF switch) once.
- 2) If there is still no power, wait 30 seconds and push the power switch again.
- 3) If there is still no power, unplug the power cord from the wall. Wait thirty seconds and plug the power cord back in. Push the power switch again.

This protective technology should provide for years of lasting entertainment from your Projection Television.

SPECIFICATIONS

Features:

- Superfine Picture Quality 1000 Line Horizontal Resolution
- Pure Green and Red Filter Lenses
- Artificial Intelligence System
- Dolby Pro Logic*/Hall/Matrix 3-Way Surround Sound
- Remote (Controls many VCR brands, cable boxes, and other audio equipment.)
- High Definition On-Screen Display (UltraTEC)
- Full set of Input Jacks, including S-Video
- Closed Caption Decoder
- High Resolution Picture-in-Picture with Freeze
- Tuned Port Bass Reflex Speakers
- Magic Focus (Auto Digital Convergence)
- Dual Antenna Inputs
- Auto Link

*"Dolby," the double-D symbol, and (where applicable) "Pro Logic" are trademarks of Dolby Laboratories Licensing Corporation.

Manufactured under license from Dolby Laboratories Licensing Corporation. Additionally licensed under one or more of the following patents: U.S. number 3,959,590; Canada numbers 1,004,603 and 1,037,877. "Dolby", "Pro-Logic", and the double-D symbol are trademarks of Dolby Laboratories Corporation.

Inputs:

- Power Input.....AC 120V, 60Hz
- Power Consumption (operating)
 - 46UX24B/25K.....173W
 - 50UX26B/27K.....173W
 - 60SX12B/13K.....176W
 - 50SX8B.....176W
- Power Consumption (Maximum)
 - 46UX24B/25K.....253W
 - 50UX26B/27K.....253W
 - 60SX12B/13K.....257W
 - 50SX8B.....257W
- Antenna input impedance.....75 Ohm
- Channel coverage.....181 ch.
 - VHF-Band.....2 ~ 13
 - UHF-Band.....14~69
 - CATV Mid Band.....A-5 ~ A-1, A-1
 - Super Band.....J-W
 - Hyper Band.....W+1-W+28

SPECIFICATIONS

- Ultra Band.....W+29-W+84
- Video.....1.0Vp-p, 75 Ohm
- S-Video
- Luminance (Y).....1.0Vp-p, 75 Ohm
- Chrominance (C).....0.286Vp-p, 75 Ohm
- Audio input impedance.....47k Ohm
- Average input level.....470mVrms
- Maximum input level.....940mVrms

Outputs:

- Video.....1.0Vp-p, 75 Ohm
- Audio (fixed).....470mVrms, 1k Ohm

Dimensions:

	46UX24B/25K	50UX26B/27K	60SX12B/13K	
50SX8B				
• Height (in.)	49 1/8	51 13/16	61 7/16	51
13/16				
• Width (in.)	40	43 3/16	51 1/4	43
3/16				
• Depth (in.)	22 3/8	21 1/4	27	21 1/4
• Weight (lbs.)	198	228	362	
228				

HITACHI SERVICE HOTLINE

To locate an authorized HITACHI service facility in the continental U.S.A.

DIAL TOLL FREE

7 days a week, 24 hours a day

800 HITACHI

1-800-448-2244

Hitachi Home Electronics (America), Inc.

Hitachi has made every effort to assure you hours of trouble free operation from your unit. However, should you require service, a network of Hitachi Authorized Service Facilities has been established in all 50 states and Puerto Rico. Each facility will provide you with convenient and expedient assistance. Our service "Hotline" operator will direct you to the Hitachi Authorized Service Facility nearest you. Just present proof of purchase and/or delivery receipts to the Hitachi Authorized Service Facility, and service will be rendered in accordance with the terms of the limited warranty as stated on your warranty card or operating guide.

Should you have any questions regarding in-warranty service, operation or technical assistance, please contact:

**Hitachi Home Electronics (America), Inc
Hawaii**
3890 Steve Reynolds Blvd

Hitachi Sales Corporation of
3219 Koapaka St.

SPECIFICATIONS

Norcross, GA 30093
Tel: 770-279-5600

Honolulu, HI 96819
Tel: 808-836-3621

For TV's purchased in Canada only, please contact one of the Hitachi offices below, should you have any questions regarding service, operation or technical assistance.

MONTREAL

3300 Trans Canada
Estate

Point Claire, Quebec
H9R 1B1

Tel: (514)697-9150

Fax: (514)697-2209

TORONTO

6740 Campobello Road

Mississauga, Ontario
L5N 2L8

Tel: (905) 821-4545

Fax: (905) 826-6627

VANCOUVER

54 Humber Place, Annacia Industrial

New Westminister, B.C.
V3M 6A6

Tel: (604) 526-8566

Fax: (604) 526-8127

error(s) in manual:

Page 24, PIP, see note

ⁱⁱThis can only be done on the UX models. The user cannot customize the PIP location on the SX models. There are two versions of this manual, the one you are looking at now and one that explains this note. The caller could have either one.

ONCE YOU HAVE THE PIP TURNED ON TO SINGLE, YOU CAN THEN MOVE THE PIP BOX WITH THE CURSOR ARROW KEYS. THEN WHEN YOU PRESS MOVE THE PIP BOX SHIFTS BETWEEN THE FOUR POSITIONS ONE OF WHICH WILL BE WHERE YOU MOVED THE BOX TO. SIMPLE ENOUGH? A CALLER MOVED THE PIP FROM THE LOWER LEFT TO THE UPPER LEFT AND WHEN HE USED MOVE AT THAT POINT HE WAS ONLY GETTING 3 PIP BOX POSITIONS! --THE CATCH, IT TOOK FOUR PUSHES OF MOVE TO ROTATE THRU THE THREE POSITIONS. ONCE HE MOVED IT BACK TO THE LOWER LEFT CORNER HE HAD HIS FOUR POSITIONS BACK. 10/17/96.

ⁱⁱⁱThe Main Freeze function is listed in some versions of the manual but not others.

^{iv}Personal Messages is listed only in certain versions of this manual.

^v**Personal Message appears in only some versions of this manual.**

Free Manuals Download Website

<http://myh66.com>

<http://usermanuals.us>

<http://www.somanuals.com>

<http://www.4manuals.cc>

<http://www.manual-lib.com>

<http://www.404manual.com>

<http://www.luxmanual.com>

<http://aubethermostatmanual.com>

Golf course search by state

<http://golfingnear.com>

Email search by domain

<http://emailbydomain.com>

Auto manuals search

<http://auto.somanuals.com>

TV manuals search

<http://tv.somanuals.com>