

PROJECTION MONITOR Operating Guide for 51M200, 65M200, 51M200A

IMPORTANT SAFETY INSTRUCTIONS	2-3
FIRST TIME USE	4-19
THE REMOTE CONTROL	20-30
ON-SCREEN DISPLAY	31-52
CARE OF YOUR ASPECT PROJECTION MONITOR AND REMOTE CONTROL	53
USEFUL INFORMATION	54-57
INDEX	58



IMPORTANT SAFETY INSTRUCTIONS





SAFETY POINTS YOU SHOULD KNOW ABOUT YOUR ASPECT PROJECTION MONITOR

Our reputation has been built on the quality, performance, and ease of service of ASPECT Projection Monitors.

Safety is also foremost in our minds in the design of these units. To help you operate these products properly, this section illustrates safety tips which will be of benefit to you. Please read it carefully and apply the knowledge you obtain from it to the proper operation of you ASPECT Projection Monitor.

Please fill out your warranty card and mail it to ASPECT. This will enable ASPECT to notify you promptly in the improbable event that a safety problem should be discovered in your product model.

Follow all warnings and instructions marked on this Projection Monitor.

 <div style="text-align: center;"> <p>CAUTION</p> <p>RISK OF ELECTRIC SHOCK DO NOT OPEN</p> </div> 		<p>The lightning flash with arrowhead symbol, within an equilateral triangle, is intended to alert the user to the presence of uninsulated "dangerous voltage" within the product's enclosure that may be of a sufficient magnitude to constitute a risk of electric shock to persons.</p>
<p>CAUTION: TO REDUCE THE RISK OF ELECTRIC SHOCK, DO NOT REMOVE COVER (OR BACK). NO USER SERVICEABLE PARTS INSIDE. REFER SERVICING TO QUALIFIED SERVICE PERSONNEL.</p>		<p>The exclamation point within an equilateral triangle, is intended to alert the user to the presence of important operating and maintenance (servicing) instructions in the literature accompanying the appliance.</p>

WARNING:

- TO REDUCE THE RISK OF FIRE OR ELECTRIC SHOCK, DO NOT EXPOSE THIS APPARATUS TO RAIN OR MOISTURE.
- THE PROJECTION MONITOR SHOULD NOT BE EXPOSED TO DRIPPING OR SPLASHING. OBJECTS FILLED WITH LIQUIDS, SUCH AS VASES, SHOULD NOT BE PLACED ON THE PROJECTION MONITOR.

NOTE:

- There are no user serviceable parts inside the Projection Monitor.
- Model and serial numbers are indicated on back side of the Projection Monitor.

CAUTION: Adjust only those controls that are covered in the instructions, as improper changes or modifications not expressly approved by ASPECT Brand Electronics could void the user's warranty.

MODIFICATIONS: The FCC requires the user to be notified that any changes or modifications made to this device that are not expressly approved by ASPECT Brand Electronics may void the user's authority to operate the equipment.

POWER SOURCE

THIS PROJECTION MONITOR IS DESIGNED TO OPERATE ON 120 VOLTS 60Hz, AC CURRENT. INSERT THE POWER CORD INTO A 120 VOLT 60Hz OUTLET.

TO PREVENT ELECTRIC SHOCK, DO NOT USE THE PROJECTION MONITOR'S (POLARIZED) PLUG WITH AN EXTENSION CORD, RECEPTACLE, OR OTHER OUTLET UNLESS THE BLADES AND GROUND TERMINAL CAN BE FULLY INSERTED TO PREVENT BLADE EXPOSURE.

NEVER CONNECT THE PROJECTION MONITOR TO 50Hz, DIRECT CURRENT, OR ANYTHING OTHER THAN THE SPECIFIED VOLTAGE.

 **CAUTION:** Never remove the back cover of the Projection Monitor as this can expose you to very high voltages and other hazards. If the Projection Monitor does not operate properly, unplug the Projection Monitor and call your authorized dealer or service center.

 As an ENERGY STAR® Partner, Hitachi, Ltd. has determined that this product meets the ENERGY STAR® guidelines for energy efficiency.



IMPORTANT SAFETY INSTRUCTIONS

Read before operating equipment

Follow all warnings and instructions marked on this Projection Monitor.

1. Read these instructions.
2. Keep these instructions.
3. Heed all warnings.
4. Follow all instructions.
5. Do not use this apparatus near water.
6. Clean only with a dry cloth.
7. Do not block any ventilation openings. Install in accordance with the manufacturer's instructions.
8. Do not install near any heat sources such as radiators, heat registers, stoves, or other apparatus (including amplifiers) that produce heat.
9. Do not defeat the safety purpose of the polarized or grounding-type plug. A polarized plug has two blades with one wider than the other. A grounding type plug has two blades and a third grounding prong. The wide blade or the third prong are provided for your safety. If the provided plug does not fit into your outlet, consult an electrician for replacement of the obsolete outlet.
10. Protect the power cord from being walked on or pinched particularly at plugs, convenience receptacles, and the point where they exit from the apparatus.
11. Only use the attachments/accessories specified by the manufacturer.

12.  Use only with the cart, stand, tripod, bracket, or table specified by the manufacturer, or sold with the apparatus. When a cart is used, use caution when moving the cart/apparatus combination to avoid injury from tip-over.

13. Unplug this apparatus during lightning storms or when unused for long periods of time.
14. Refer all servicing to qualified service personnel. Servicing is required when the apparatus has been damaged in any way, such as power-supply cord or plug is damaged, liquid has been spilled or objects have fallen into apparatus, the apparatus has been exposed to rain or moisture, does not operate normally, or has been dropped.

Do not place any objects on the top of the Projection Monitor which may fall or cause a child to climb to retrieve the objects.

Projection Monitor's are heavy and can mark or damage floor surfaces (especially wood flooring) if moved improperly. Do not slide or force Projection Monitor into position.

PREVENTION OF SCREEN BURN

This Wide Screen Projection Monitor is designed to display wide screen pictures. Images should be viewed mostly in wide screen format or zoomed to fill the screen with moving pictures. Use of side panels, top and bottom panels of standard picture formats should only be 15% of your total viewing time to prevent uneven aging of the phosphors. Phosphors in the lighted area of the picture will age more rapidly than the gray areas. Continuous on-screen displays such as video games, stock market quotations, computer generated graphics, and other fixed (non-moving) patterns can cause permanent damage to Projection Monitors. Such "SCREEN BURNS" constitute misuse and are **NOT COVERED** by your ASPECT Factory Warranty.

Lead Notice

This product contains lead. Dispose of this product in accordance with applicable environmental laws. For product recycling and disposal information, contact your local government agency or the Electronic Industries Alliance at www.eiae.org (in the US) or the Electronic Product Stewardship Canada at www.epsc.ca (in Canada). **FOR MORE INFORMATION, CALL 1-800-488-2244.**

15. Projection Monitors are designed to comply with the recommended safety standards for tilt and stability. Do not apply excessive pulling force to the front, or top, of the cabinet which could cause the product to overturn resulting in product damage and/or personal injury.
16. Follow instructions for wall, shelf or ceiling mounting as recommended by the manufacturer.
17. An outdoor antenna should not be located in the vicinity of overhead power lines or other electrical circuits.
18. If an outside antenna is connected to the receiver be sure the antenna system is grounded so as to provide some protection against voltage surges and built up static charges. Section 810 of the National Electric Code, ANSI/NFPA No. 70-1984, provides information with respect to proper grounding for the mast and supporting structure, grounding of the lead-in wire to an antenna discharge unit, size of grounding connectors, location of antenna-discharge unit, connection to grounding electrodes and requirements for the grounding electrode.

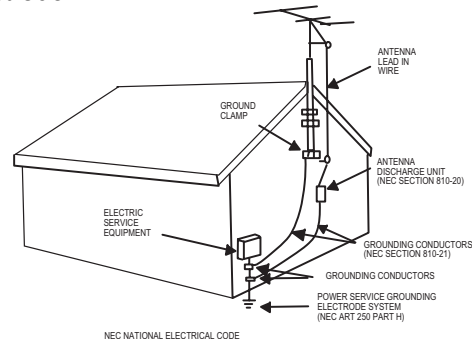

Note to the CATV system installer: This reminder is provided to call the CATV system installer's attention to Article 820-44 of the NEC that provides guidelines for proper grounding and, in particular, specifies that the cable ground shall be connected to the grounding system of the building, as close to the point of cable entry as practical.

Disposal of this product may require specific instructions pertaining to your resident state. For disposal or recycling information, please contact your local authorities or the Electronic Industries Alliance: www.eiae.org.



Check to make sure you have the following accessories before disposing of the packing material.

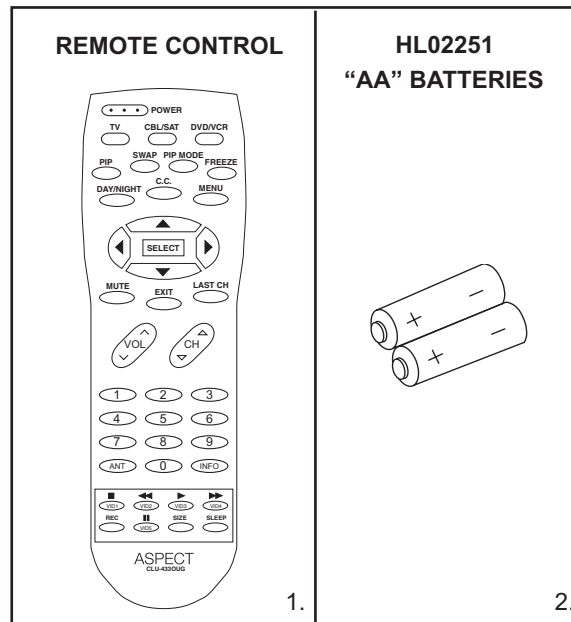

1. Remote Control Unit is either CLU-4330UG (Part No. HL02251).
2. Two "AA" size, 1.5V batteries (For Remote Control Unit).

REMOTE CONTROL BATTERY INSTALLATION AND REPLACEMENT

1. Open the battery cover of the remote control by pushing the notched part of the cover with your fingers and pulling the cover off.
2. Insert two new "AA" size batteries for the remote control. When replacing old batteries, push them towards the springs and lift them out.
3. Match the batteries to the (+) and (-) marks in the battery compartment.
4. Replace the cover.

BOTTOM VIEW

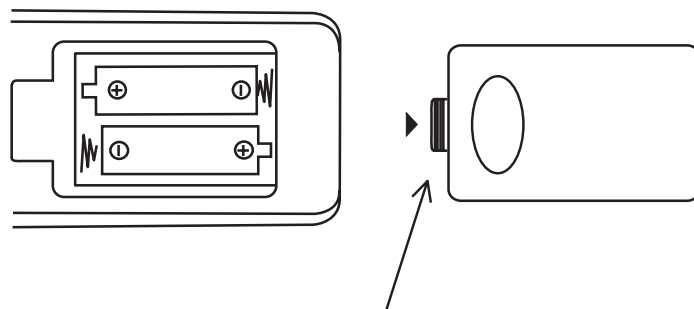

Lift up on tab to remove back cover.



CAUTION: Danger of explosion if battery is incorrectly replaced. Replace with the same or equivalent type.



HOW TO SET UP YOUR NEW HITACHI PROJECTION MONITOR

LOCATION

Select an area where sunlight or bright indoor illumination will not fall directly on the picture screen. Also, be sure that the location selected allows a free flow of air to and from the perforated back cover of the set.

To avoid cabinet warping, cabinet color changes, and increased chance of set failure, do not place the Projection Monitor where temperatures can become excessively hot, for example, in direct sunlight or near a heating appliance, etc.

VIEWING

The major benefit of the ASPECT Projection Monitor is its large viewing screen. To see this large screen at its best, test various locations in the room to find the optimum spot for viewing.

The best picture is seen by sitting directly in front of the Projection Monitor and about 10 to 18 feet from the screen. Picture brightness decreases as the viewer moves to the left and right of the receiver.

During daylight hours, reflections from outside light may appear on the screen. If so, drapes or screens can be used to reduce the reflection or the Projection Monitor can be located in a different section of the room.

If the Projection Monitor's audio output will be connected to a Hi-Fi system's external speakers, the best audio performance will be obtained by placing the speakers equidistant from each side of the receiver cabinet and as close as possible to the height of the picture screen center. For best stereo separation, place the external speakers at least four feet from the side of the Projection Monitor, place the surround speakers to the side or behind the viewing area. Differences in room sizes and acoustical environments will require some experimentation with speaker placement for best performance.

FIRST TIME USE

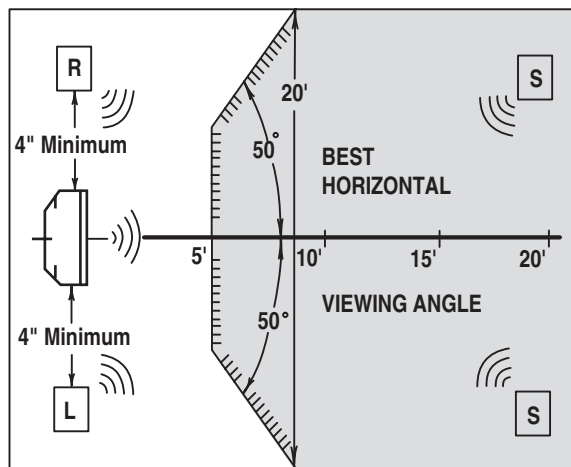
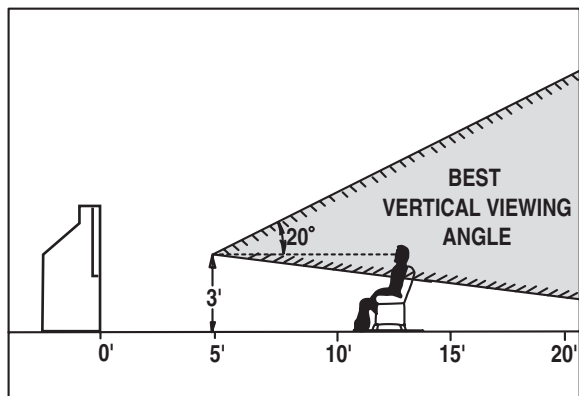

CAUTION: Magnetic fields, such as those of external speakers, may cause the picture to distort if they are placed too close to the Projection Monitor. Move the magnetic field source away from the Projection Monitor until there is no picture distortion.



HOOK-UP CABLES AND CONNECTORS

FIRST TIME USE

Most video/audio connections between components can be made with shielded video and audio cables that have phono connectors. For best performance, video cables should use 75-Ohm coaxial shielded wire. Cables can be purchased from most stores that sell audio/video products. Below are illustrations and names of common connectors. Before purchasing any cables, be sure of the output and input connector types required by the various components and the length of each cable.



Phono Connector

Used on all standard video and audio cables which connect to inputs and outputs located on the Projection Monitor's rear jack panel and front control panel.



S-Video (Super Video) Connector

This connector is used on camcorders, VCRs and laser-disc players with an S-Video feature in place of the standard video cable to produce a high quality picture.

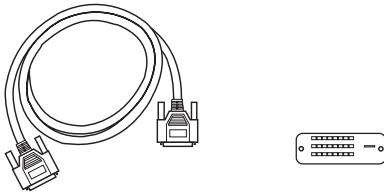

Digital Visual Interface (DVI) Connection Cable

This cable is used to connect external devices with DVI-HDTV output capability. It delivers digital video in its native format. Audio information is carried separately.



FRONT PANEL CONTROLS

FIRST TIME USE

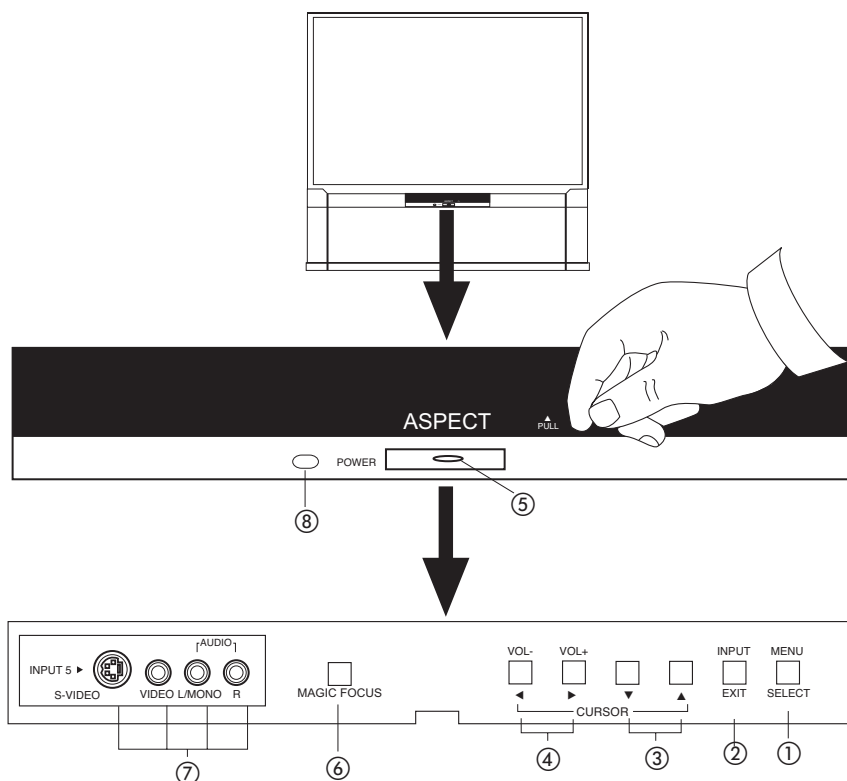

① MENU/SELECT button

This button allows you to enter the MENU, making it possible to set Projection Monitor features to your preference without using the remote. This button also serves as the SELECT button when in MENU mode.

② INPUT/EXIT button

Press this button to select the current VIDEO: 1, 2, 3, 4, 5. Your selection is shown in the top right corner of the screen. This button also serves as the EXIT button when in MENU mode.

NOTES: Your remote control does not have an INPUT button. To change to video inputs, press VID1~VID5 buttons depending on your choice (see page 22).

③ CURSOR UP/DOWN buttons

These buttons serve as the cursor down (▼) and up (▲) buttons when in MENU mode.

④ VOLUME level

Press these buttons for your desired sound level. The volume level will be displayed on the Projection Monitor screen. These buttons also serve as the cursor left (◀) and right (▶) buttons when in MENU mode.

⑤ POWER button/POWER LED

Press this button to turn the Projection Monitor on or off. This LED light is ON during normal operation.

⑥ MAGIC FOCUS

Use this button to automatically adjust your picture quality to optimum performance (see page 46). The Magic Focus button will not work when adjustment mode is set to manual (see page 47).

⑦ FRONT INPUT JACKS (INPUT 5)

Use these audio/video jacks for a quick hook-up from a camcorder or VCR to instantly view your favorite show or new recording. Press the INPUT button until VIDEO: 5 appears in the top right corner of the Projection Monitor screen. If you have mono sound, insert the audio cable into the left audio jack.

⑧ IR RECEIVER Sensor

When using the remote control, point it towards the IR receiver for best response.



FRONT PANEL JACKS AND CONNECTORS

FIRST TIME USE

The front panel jacks are provided as a convenience to allow you to easily connect a camcorder or VCR as shown in the following examples:

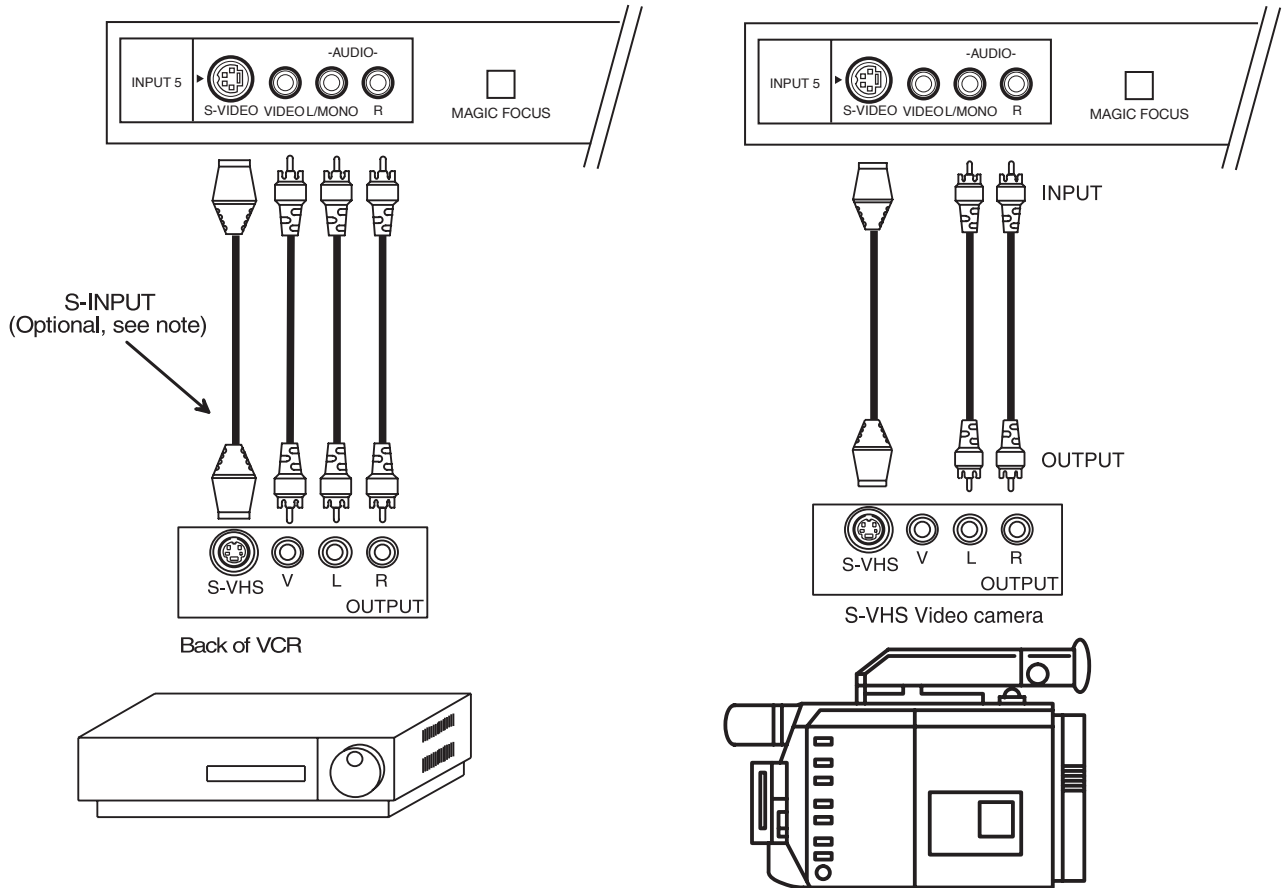

NOTE:

1. Completely insert connection cord plugs when connecting to front panel jacks. If you do not, the played back picture may be abnormal.
2. If you have a S-VHS VCR, use the S-INPUT cable in place of the standard video cable.
3. If you have a mono VCR, insert the audio cable into the left audio jack of your Projection Monitor.



REAR PANEL JACKS

FIRST TIME USE

IMPORTANT: This is a monitor only product. No TV or Cable tuner is included.

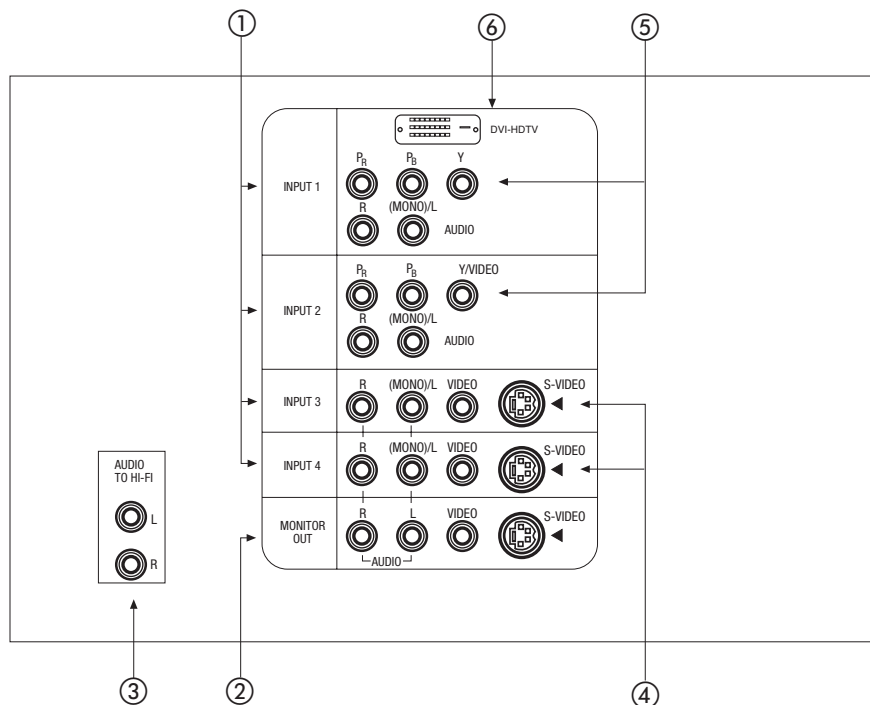

① Audio/Video Inputs 1, 2, 3 and 4

The VID1~VID4 buttons will select each video source each time they are pressed. Use the audio and video inputs to connect external devices, such as VCRs, camcorders, laserdisc players, DVD players etc. (If you have mono sound, insert the audio cable into the left audio jack.)

NOTE: You may use VIDEO or S-VIDEO inputs to connect to INPUT 3 and 4, but only one of these inputs may be used at a time.

② MONITOR OUT

These jacks provide fixed audio and video signals which are used for recording. Use the S-VIDEO Output for high quality video output.

NOTE: S-VIDEO Output may be used for recording, only when the input is of S-VIDEO type.

③ AUDIO TO HI-FI Output

These jacks provide variable audio output to a separate stereo amplifier. With this connection, the audio to the stereo can be controlled by the television's main volume.

④ S-VIDEO Inputs 3 and 4

Inputs 3 and 4 provide S-VIDEO (Super Video) jacks for connecting equipment with S-VIDEO output capability.



⑤ Component: Y-P_BP_R Inputs

Inputs 1 and 2 provide Y-P_BP_R jacks for connecting equipment with this capability, such as a DVD player or Set Top Box. You may use composite video signal for INPUT:2.

- NOTES:**
1. Do not connect composite VIDEO and S-VIDEO to Input 3, 4 or 5 at the same time. S-VIDEO has priority over VIDEO input.
 2. Your component outputs may be labeled Y, B-Y, and R-Y. In this case, connect the components B-Y output to the Monitor's P_B input and the components R-Y output to the Monitor's P_R input.
 3. Your component outputs may be labeled Y-C_BC_R. In this case, connect the component C_B output to the Monitor's P_B input and the component C_R output to the Monitor's P_R input.
 4. It may be necessary to adjust TINT to obtain optimum picture quality when using the Y-P_BP_R inputs. (See page 34)
 5. To ensure no copyright infringement, the MONITOR OUT output will be abnormal, when using the Y-P_BP_R jacks.
 6. Input 2 (Y/VIDEO) can be used for composite video or component video input.

⑥ DVI-HDTV Input (Input 1)

Use this DVI-HDTV Input for your external devices with DVI-HDTV output such as a Set-Top-Box, high-band DTV decoders, DVD players and D-VHS with Digital Content Protection.

- NOTES:**
1. Only DTV format such as 1080i, 720p, 480i and 480p are available for DVI-HDTV input.
 2. The DVI-HDTV input is NOT compatible when used with a DVD player from a personal computer.
 3. When connecting a Set-Top-Box with a copy-protect digital out terminal, a high definition picture can be displayed on the screen in its digital form.

REAR PANEL CONNECTIONS



TYPICAL FULL-FEATURE SETUP

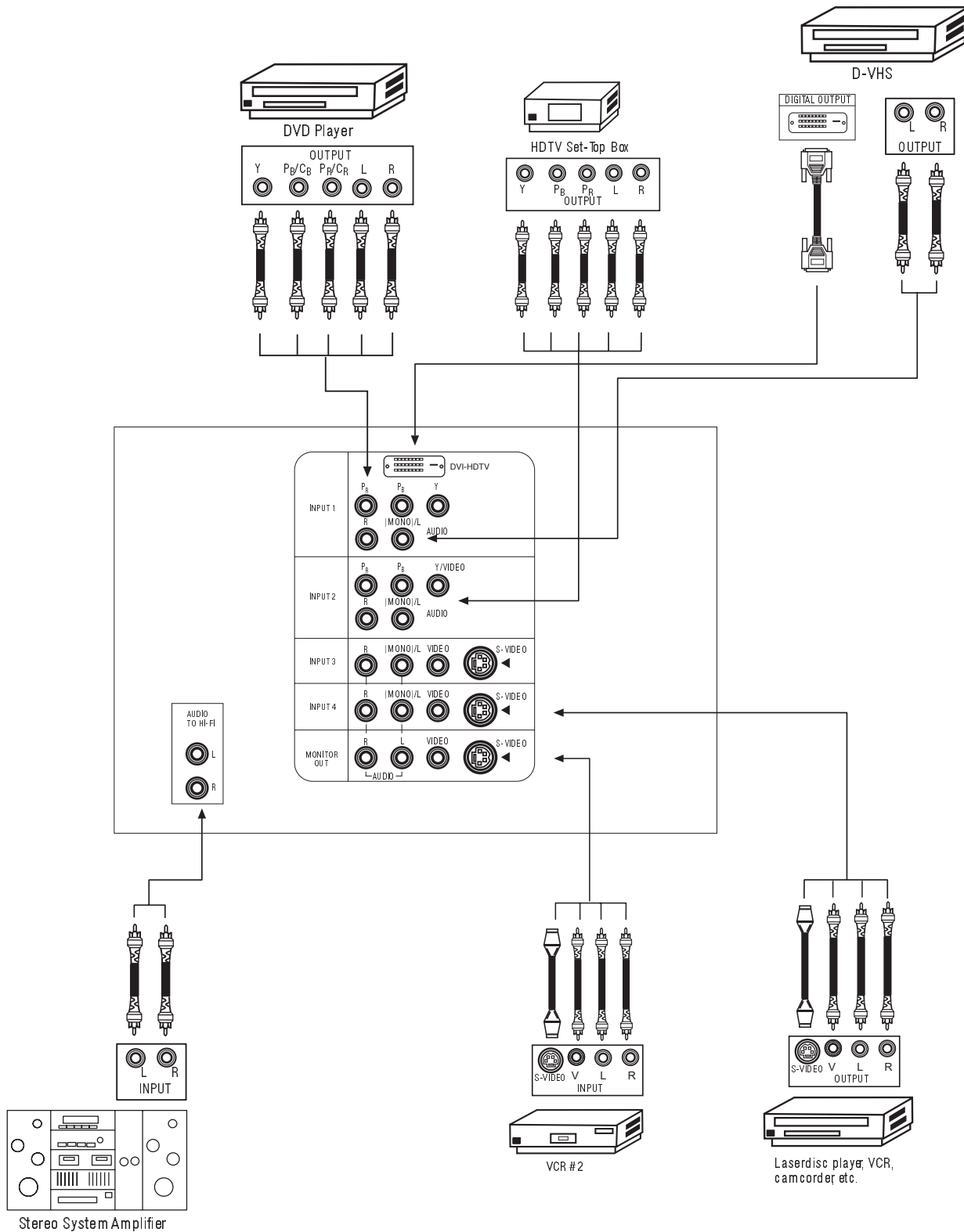

FIRST TIME USE

- NOTE:**
1. Connect only 1 component to each input jack.
 2. Follow connections that pertain to your personal entertainment system.
 3. Composite video signal can be input to Input2~Input5.
 4. Cables are not included with the purchase of this Projection Monitor.



TIPS ON REAR PANEL CONNECTIONS

- S-VIDEO and DVI-HDTV connections are provided for high performance laserdisc players, VCRs etc. that have this feature. Use these connections in place of the standard video connection if your device has this feature.
- If your device has only one audio output (mono sound), connect it to the left audio jack on the Projection Monitor.
- Refer to the operating guide of your other electronic equipment for additional information on connecting your cables.
- You may use VIDEO or S-VIDEO inputs to connect to Input 3, Input 4 or Input 5, but only one of these may be used at a time.
- Connect only 1 component (VCR, DVD player, camcorder, etc.) to each input jack.
- COMPONENT: Y-P_BP_R (Input 1 & 2) connections are provided for high performance components, such as DVD players and set-top-boxes. Use these connections in place of the standard video connection if your device has this feature. Input 2 accepts both composite or component video signals.
- Your component outputs may be labeled Y, B-Y, and R-Y. In this case, connect the components B-Y output to the Monitor's P_B input and the components R-Y output to the Monitor's P_R input.
- Your component outputs may be labeled Y-C_BC_R. In this case, connect the components C_B output to the Monitor's P_B input and the components C_R output to the Monitor's P_R input.
- You may use composite video signal for Input 2~Input 5.
- It may be necessary to adjust TINT to obtain optimum picture quality when using the Y-P_BP_R inputs (see page 34).
- To ensure no copyright infringement, the MONITOR OUT output will be abnormal, when using the Y-P_BP_R jacks.
- When using a DVI input from a Set-Top-Box, it is recommended that a 1080i or 720p input signal is used.

CONNECTING EXTERNAL AUDIO DEVICES



To control the audio level of an external audio amplifier with the remote control, connect the system as shown below.

REAR PANEL OF PROJECTION MONITOR

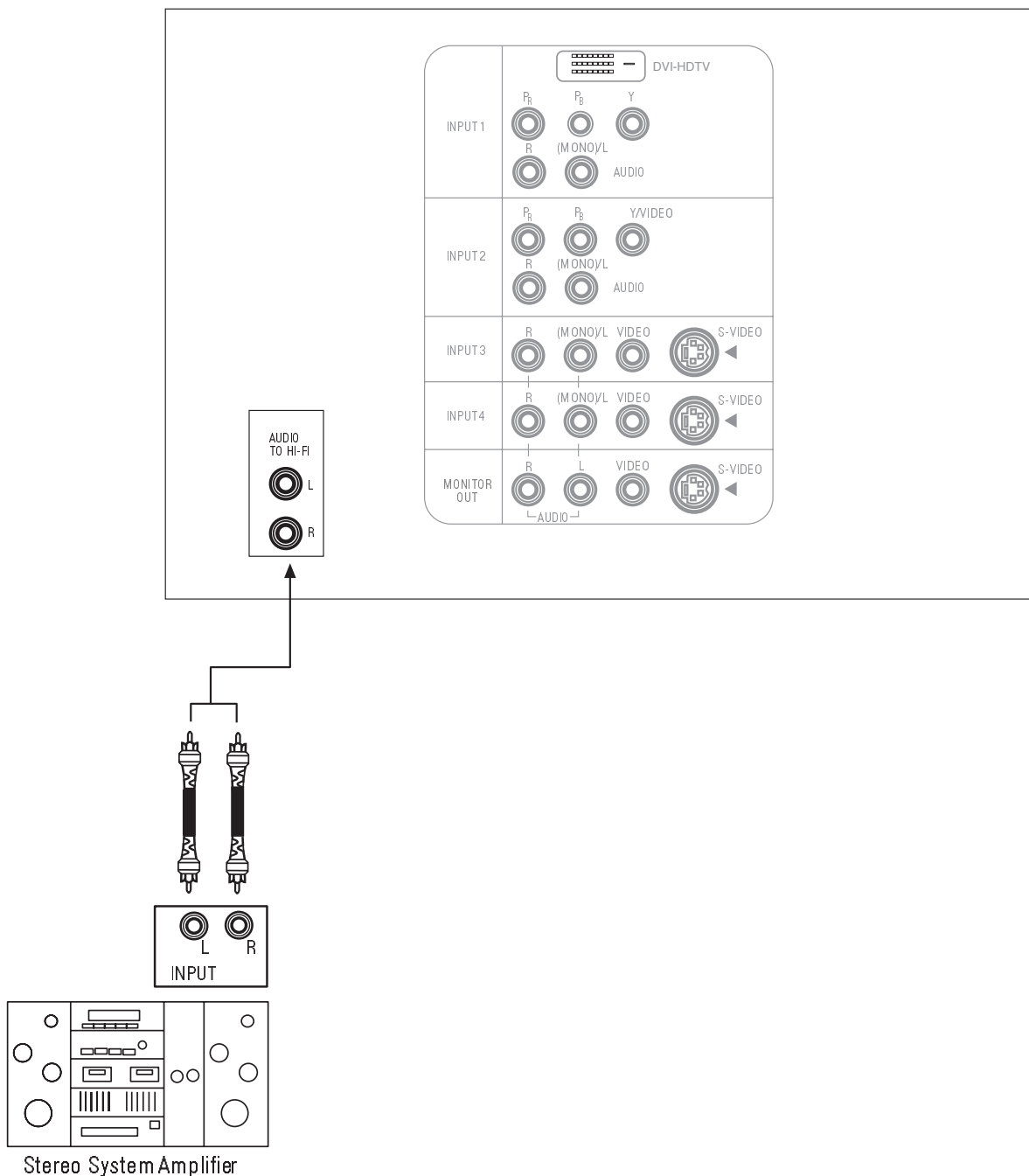

FIRST TIME USE

NOTE: To prevent damage to the speaker and distorted sound, set the volume control of the audio amplifier lower and adjust the sound using the remote control of the Projection Monitor.



CONNECTING EXTERNAL VIDEO SOURCES

The exact arrangement you use to connect the VCR, camcorder, laserdisc player, DVD player, or HDTV Set Top Box to your Projection Monitor is dependent on the model and features of each component. Check the owner's manual of each component for the location of video and audio inputs and outputs.

The following connection diagrams are offered as suggestions. However, you may need to modify them to accommodate your particular assortment of components and features. For best performance, video and audio cables should be made from coaxial shielded wire.

Before Operating External Video Source

The input mode is changed every time the VID1~VID5 button is pressed as shown below. Connect an external source to the INPUT terminal, then press the VID1~VID5 button as necessary to view the input source (see page 22).

FIRST TIME USE

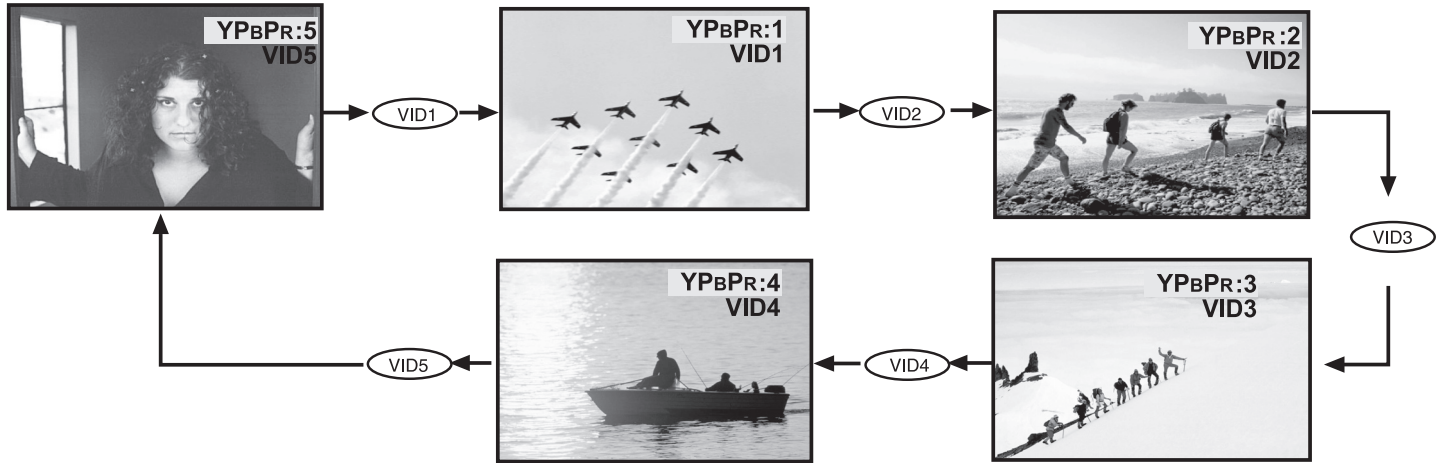

NOTE: When a video signal is not received from the VIDEO INPUT JACK on the back panel of the Projection Monitor (i.e., VCR/laserdisc player, etc. is not connected or the video device is OFF), the Monitor will appear to be OFF.



CONNECTING EXTERNAL VIDEO SOURCES

CONNECTING A MONAURAL AUDIO SOURCE TO INPUT1~INPUT5

1. Connect the cable from the VIDEO OUT of the VCR or the laserdisc player to the INPUT (VIDEO) jack, as shown on the Projection Monitor below.
2. Connect the cable from the AUDIO OUT of the VCR or the laserdisc player to the INPUT (MONO)/L(AUDIO) jack.
3. Press the VID4 button to view the program from the VCR or the laserdisc player. The VIDEO label disappears automatically after approximately four seconds.

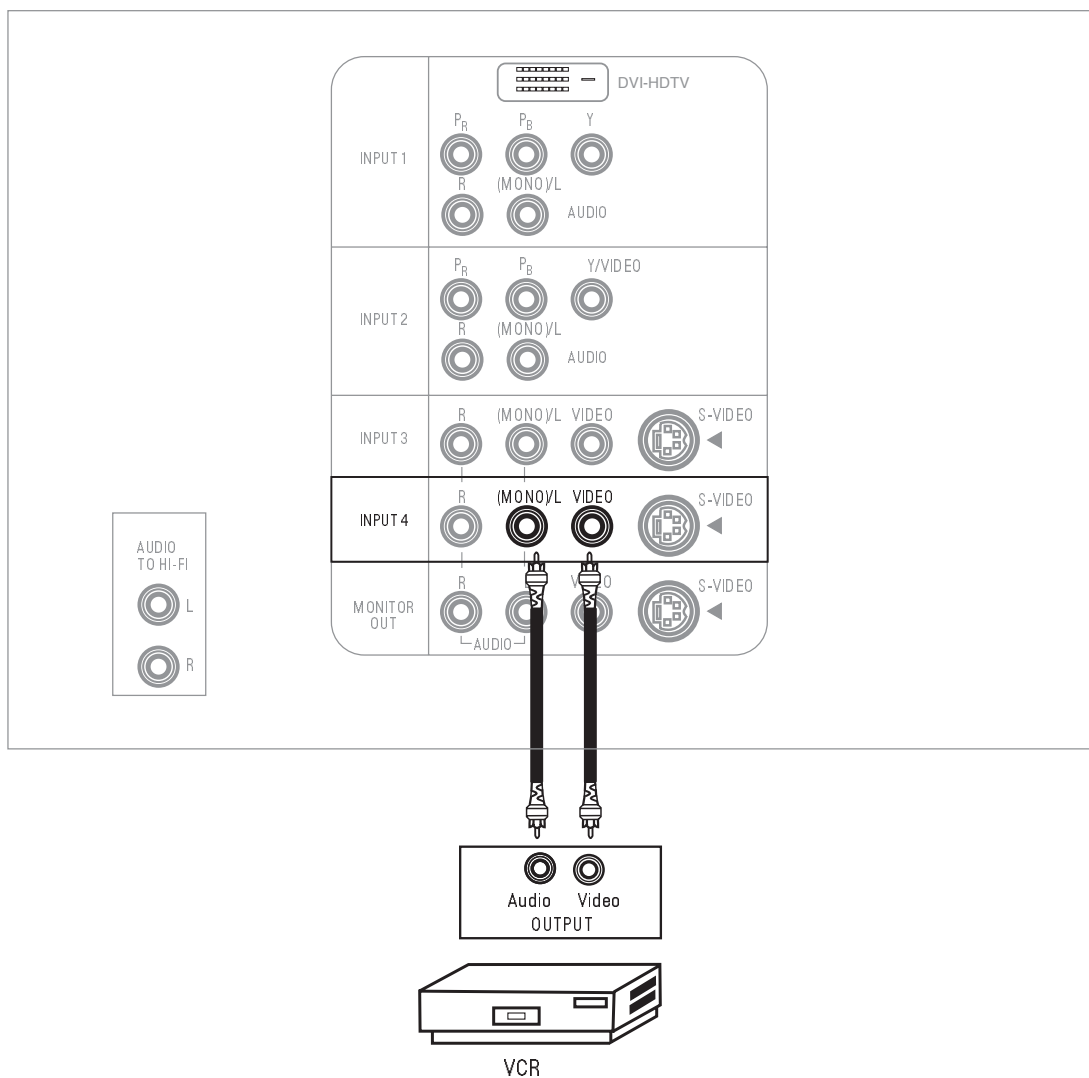

FIRST TIME USE



CONNECTING EXTERNAL VIDEO SOURCES

FIRST TIME USE

CONNECTING A STEREO SOURCE TO INPUT1-INPUT5

1. Connect the cable from the VIDEO OUT of the VCR or the laserdisc player to the INPUT (VIDEO) jack, as shown on the Projection Monitor below.
2. Connect the cable from the AUDIO OUT R of the VCR or the laserdisc player to the INPUT (AUDIO/R) jack.
3. Connect the cable from the AUDIO OUT L of the VCR or the laserdisc player to the INPUT (AUDIO/L) jack.
4. Press the VID4 button to view the program from the VCR or laserdisc player. The VIDEO label disappears automatically after approximately four seconds.

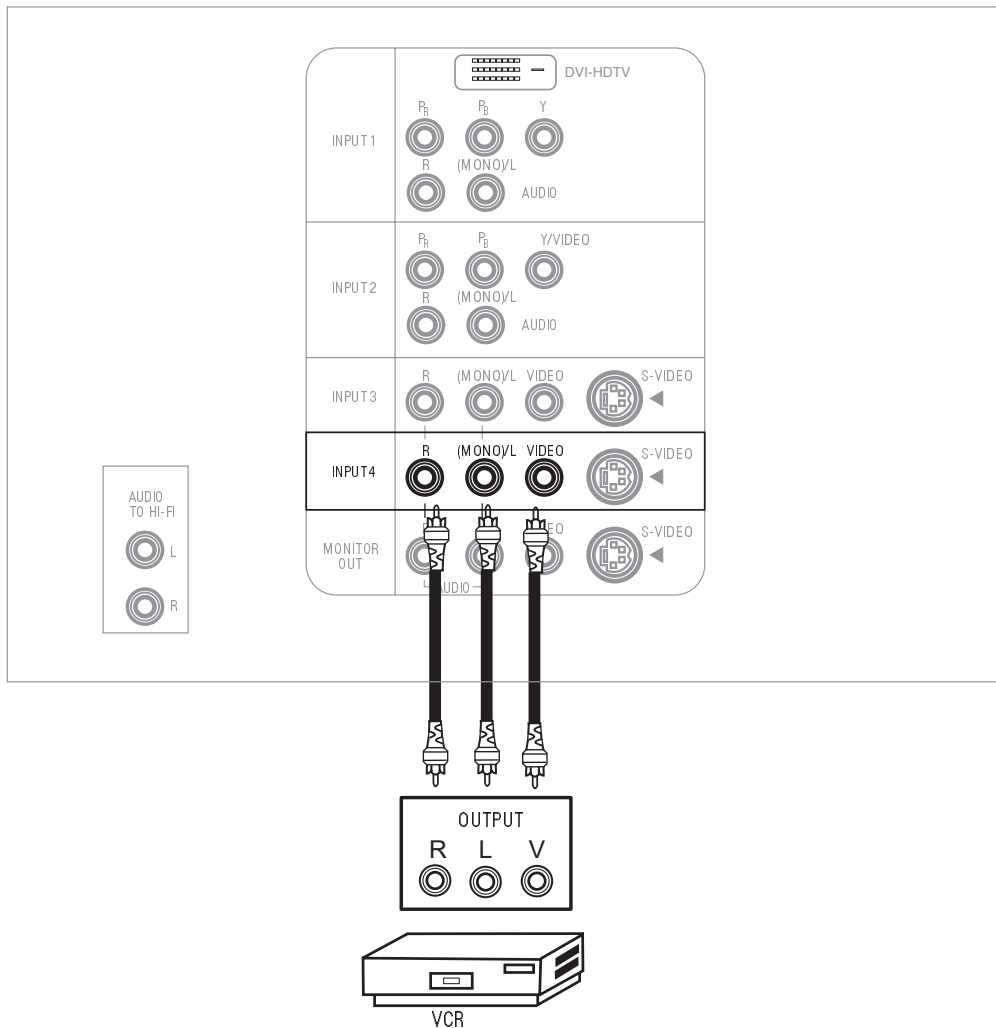

NOTE: Completely insert the connection cord plugs when connecting to rear panel jacks. The picture and sound that is played back will be abnormal if the connection is loose.



CONNECTING EXTERNAL VIDEO SOURCES

CONNECTING AN S-VIDEO SOURCE TO INPUT 3, 4 AND 5

1. Connect the cable from the S-VIDEO OUT of the VCR or the laserdisc player to the INPUT (S-VIDEO) jack, as shown on the Projection Monitor below.
2. Connect the cable from the AUDIO OUT R of the VCR or the laserdisc player to the INPUT (AUDIO/R) jack.
3. Connect the cable from the AUDIO OUT L of the VCR or the laserdisc player to the INPUT (AUDIO/L) jack.
4. Press the VID4 button to view the program from the VCR or laserdisc player. The VIDEO label disappears automatically after approximately four seconds.

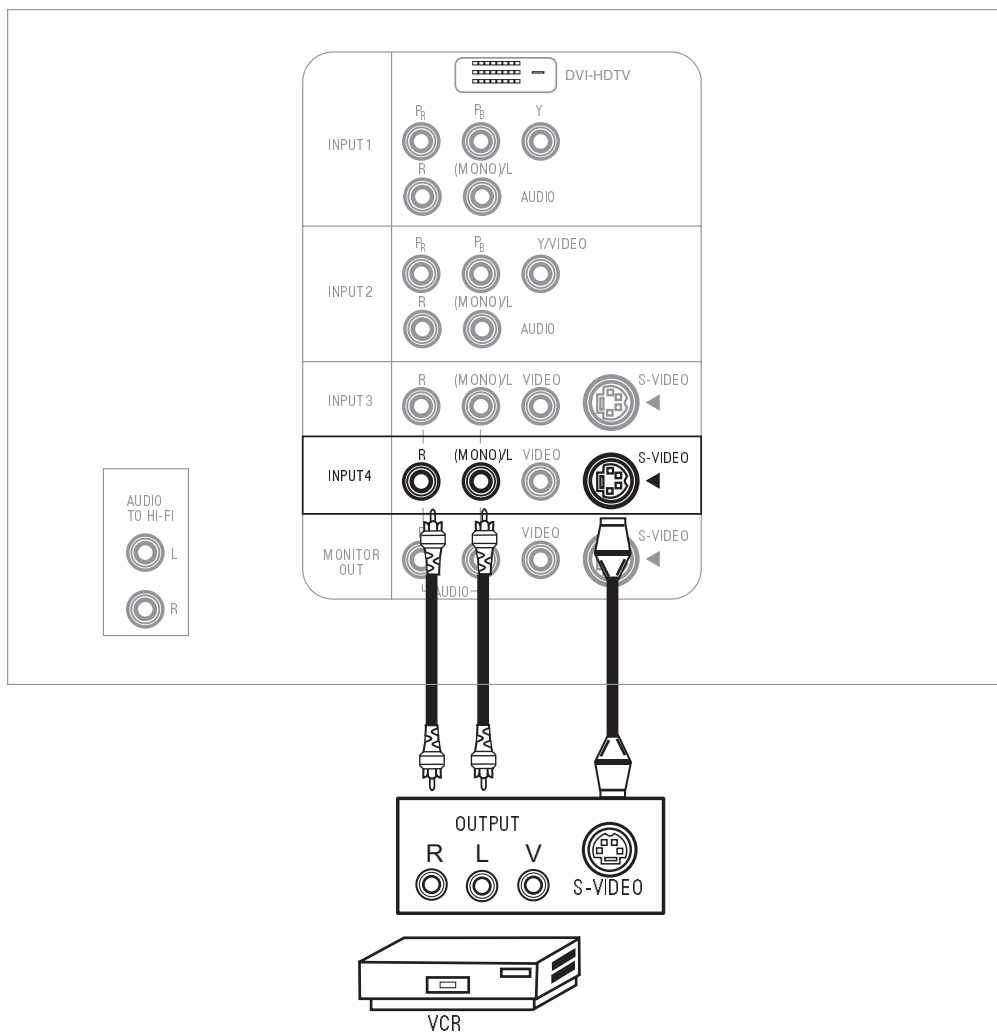

NOTE: Completely insert the connection cord plugs when connecting to rear panel jacks. The picture and sound that is played back will be abnormal if the connection is loose.



CONNECTING EXTERNAL VIDEO SOURCES

FIRST TIME USE

CONNECTING A COMPONENT SOURCE WITH DVI-HDTV CAPABILITY TO INPUT 1.

1. Connect the DVI connection cable from the output of the HDTV set top box or DVD player to the DVI-HDTV input as shown on the Projection Monitor below.
2. Connect the cable from the AUDIO OUT R of the HDTV set top box or DVD player to the INPUT (AUDIO/R) jack.
3. Connect the cable from the AUDIO OUT L of the HDTV set top box or DVD player to the INPUT (AUDIO/L) jack.
4. Press the VID1 button to view the program from the HDTV set top box or DVD player. The VIDEO label disappears automatically after approximately four seconds.

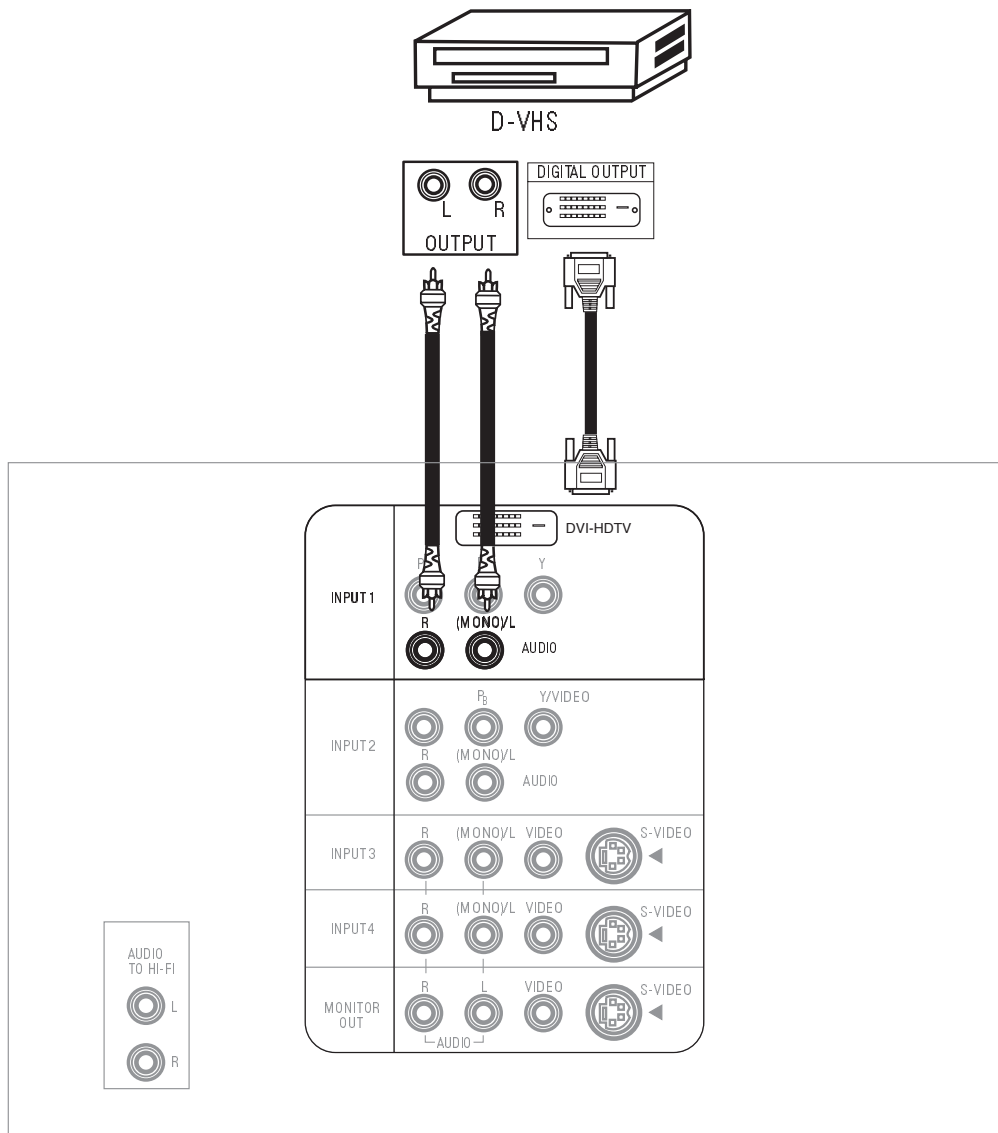



CONNECTING EXTERNAL VIDEO SOURCES

CONNECTING A COMPONENT SOURCE TO INPUT 1 OR 2: Y-P_BP_R.

1. Connect the cable from the Y OUT of the Laserdisc/DVD player or HDTV set top box to the INPUT (Y) jack, as shown on the Projection Monitor below.
2. Connect the cable from the C_B/P_B OUT or B-Y OUT of the Laserdisc/DVD player or HDTV set top box to the INPUT (P_B) jack.
3. Connect the cable from the C_R/P_R OUT or R-Y OUT of the Laserdisc/DVD player or HDTV set top box to the INPUT (P_R) jack.
4. Connect the cable from the AUDIO OUT R of the Laserdisc/DVD player or HDTV set top box to the INPUT (AUDIO/R) jack.
5. Connect the cable from the AUDIO OUT L of the Laserdisc/DVD player or HDTV set top box to the INPUT (AUDIO/L) jack.
6. Press the VID1 button, to view the program from the Laserdisc/DVD player or HDTV set top box. The VIDEO label disappears automatically after approximately four seconds.

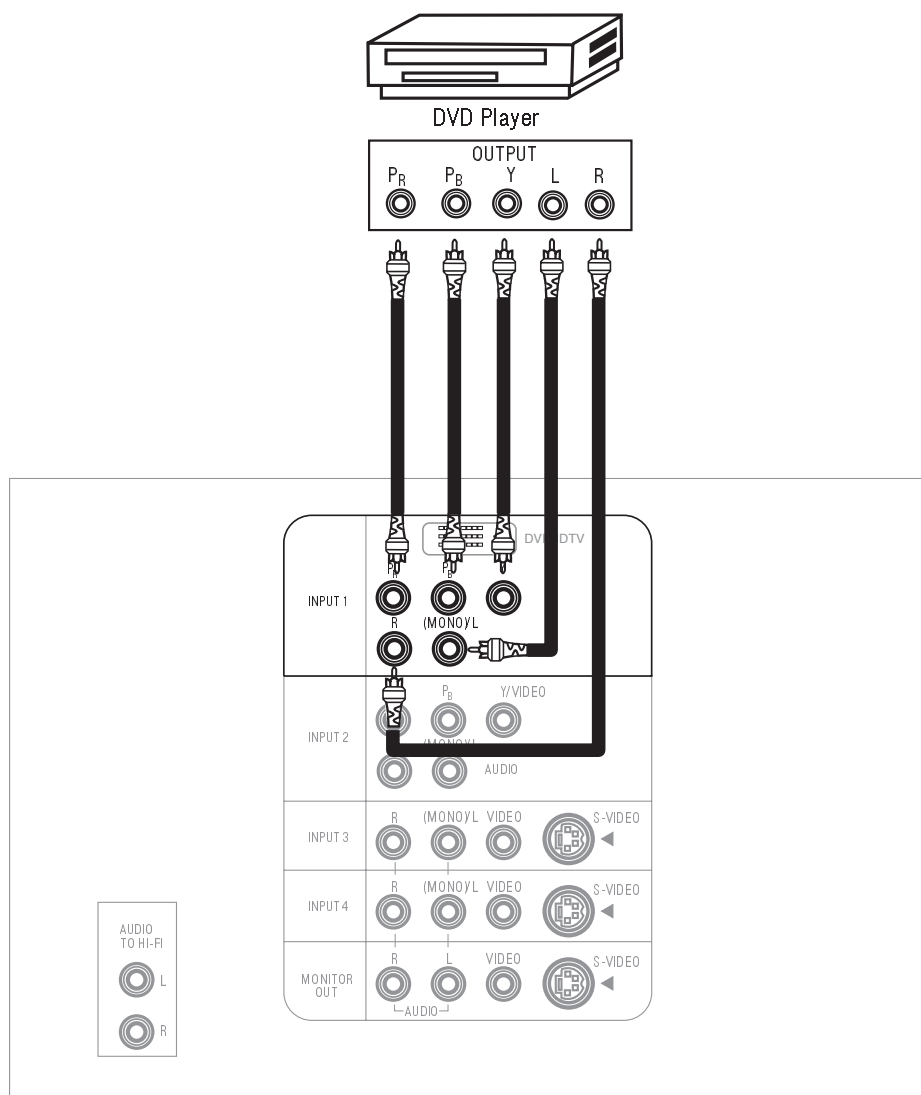

- NOTE:**
1. Completely insert the connection cord plugs when connecting to rear panel jacks. The picture and sound that is played back will be abnormal if the connection is loose.
 2. See page 12 for tips on REAR PANEL CONNECTIONS.



THE REMOTE CONTROL

In addition to controlling all the functions on your ASPECT Projection Monitor, the new remote control is designed to operate different types of VCRs, CBL (Cable TV) converters, satellite receivers, DVD players, and other audio/video equipment. Basic operation keys are grouped together in one area.

To operate your Projection Monitor, point the remote control at the IR Receiver sensor (see page 7) of the Projection Monitor and press the TV button. The remote will now control your Projection Monitor.

To operate your cable/satellite box, point the remote at the remote sensor of the cable/satellite box and press the CABLE/SATELLITE (CBL/SAT) button. The remote will now control your cable/satellite box (see page 29 for instructions on how to program the remote to control your cable box.)

To operate your DVD/VCR player, point the remote at the remote sensor of the DVD/VCR player and press the DVD/VCR button. The remote will now control your DVD/VCR player (see pages 28 and 30 for instruction on how to program the remote to control your DVD/VCR player.)

THE REMOTE CONTROL

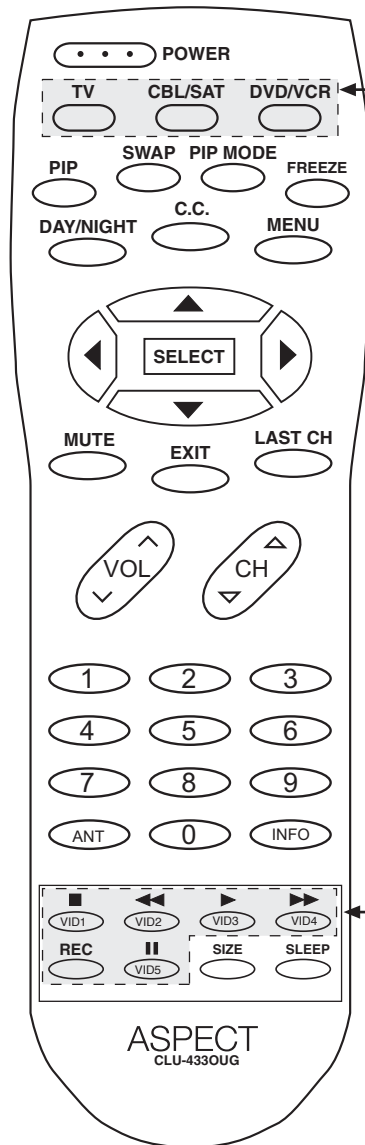

These buttons allow the remote to control your TV (Projection Monitor), VCR, DVD or cable/satellite box depending on which mode is chosen, as explained above.

TV (Projection Monitor) OR VCR/DVD BUTTONS
When in TV (Projection Monitor) mode, these buttons, except the REC button, will select from five video input sources. When in VCR/DVD mode, these buttons transmit the chosen precoded VCR/DVD codes.

HOW TO USE THE REMOTE TO CONTROL YOUR PROJECTION MONITOR

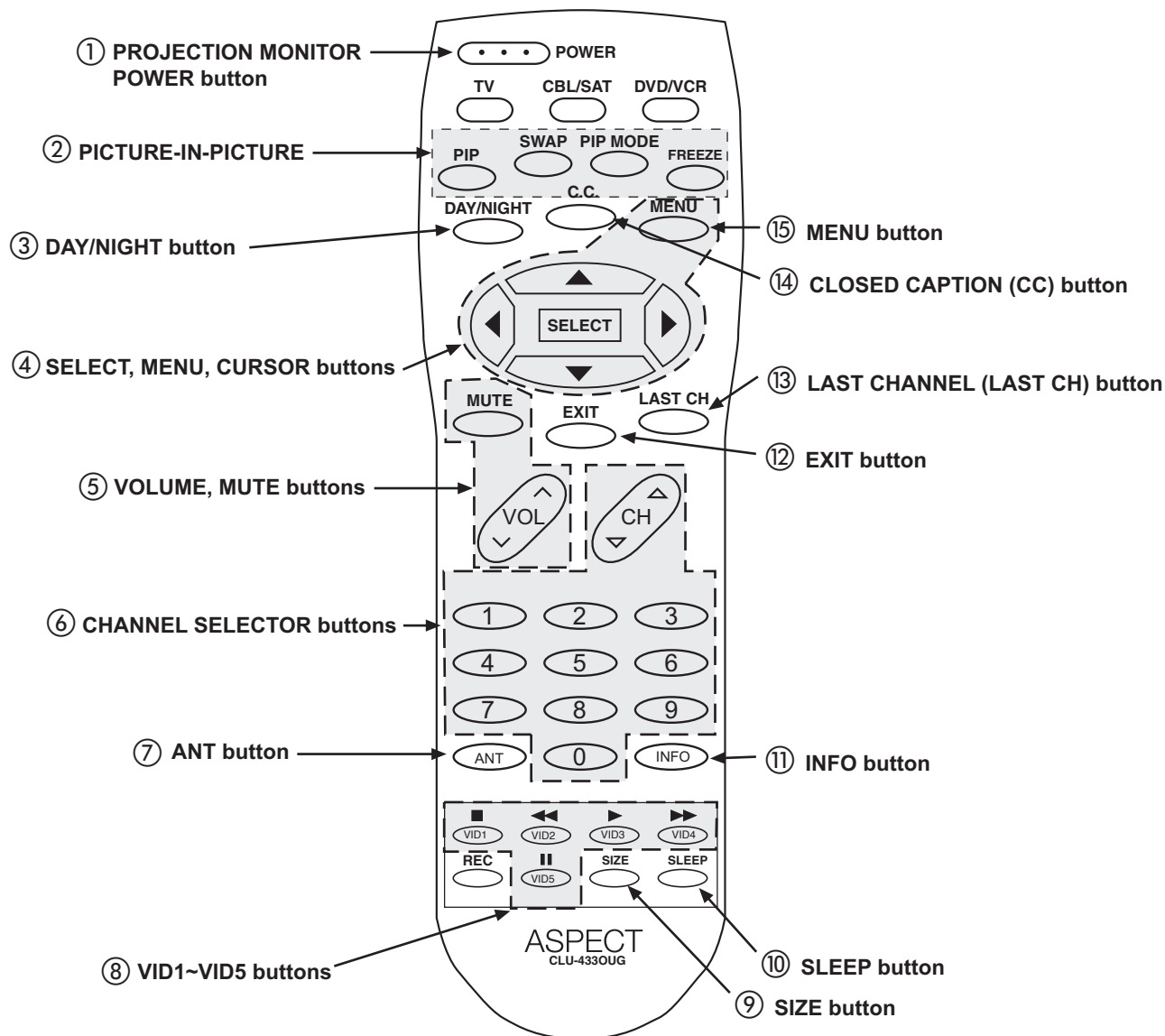

- ① POWER button**
Press this button to turn the Projection Monitor on or off when the remote is in TV (Monitor) mode.
- ② PICTURE-IN-PICTURE buttons**
See separate section on pages 25, 26 and 27 for description.
- ③ DAY/NIGHT button**
Press this button to toggle between Day and Night picture mode settings. Select Day for day time viewing with more brightness and contrast to compete with room light. Select Night for night time viewing with less brightness and contrast for a more detailed picture (see page 33 for settings changes).
- ④ SELECT, MENU, CURSOR buttons**
All the On-Screen Display features can be set or adjusted by using the CURSOR buttons, except for numeric entries. The CURSOR will highlight functions or adjust and set different features. Press the CURSOR toward desired direction then press the SELECT button to select.

THE REMOTE CONTROL



HOW TO USE THE REMOTE TO CONTROL YOUR PROJECTION MONITOR

⑤ VOLUME, MUTE button

Press the VOLUME up (▲) or down (▼) button until you obtain the desired sound level.

To reduce the sound to one half the normal volume (SOFT MUTE), press the MUTE button. Press the MUTE button again to turn the sound off completely (MUTE). To restore the sound, press the MUTE button one more time, or press the VOLUME Up (▲) button.



Closed Captioning will display when MUTE/SOFT MUTE is on and Closed Caption is set to AUTO (See page 52).

⑥ CHANNEL selector buttons [Cable Box/Satellite Receiver (CBL/SAT) Mode Only]

These buttons are only applicable when the remote control is in CBL/SAT mode.

CHANNEL selector buttons are used to select channels, lock access code, etc.

Enter one, two, or three numbers to select channels. Enter "0" first for channels 1 to 9, or simply press the single digit channel you wish to tune then wait a few seconds for the device to tune. For channels 100 and above, press the "1" button, wait until two dashes appear next to the channel display on your Projection Monitor, then enter the remaining two numbers using the number buttons. Channel selection may also be performed by pressing CH up (▲) or down (▼).

⑦ ANTENNA button [Satellite Receiver (SAT) Mode Only]

The ANT button is only applicable when the Remote Control is in SAT mode.

⑧ VID1 ~ VID5

When the remote control is in TV (Monitor) mode, press these buttons to directly select the video input sources between the five video inputs. When the remote control is in DVD/VCR mode, these buttons will control the DVD or VCR, and execute the secondary function labeled.

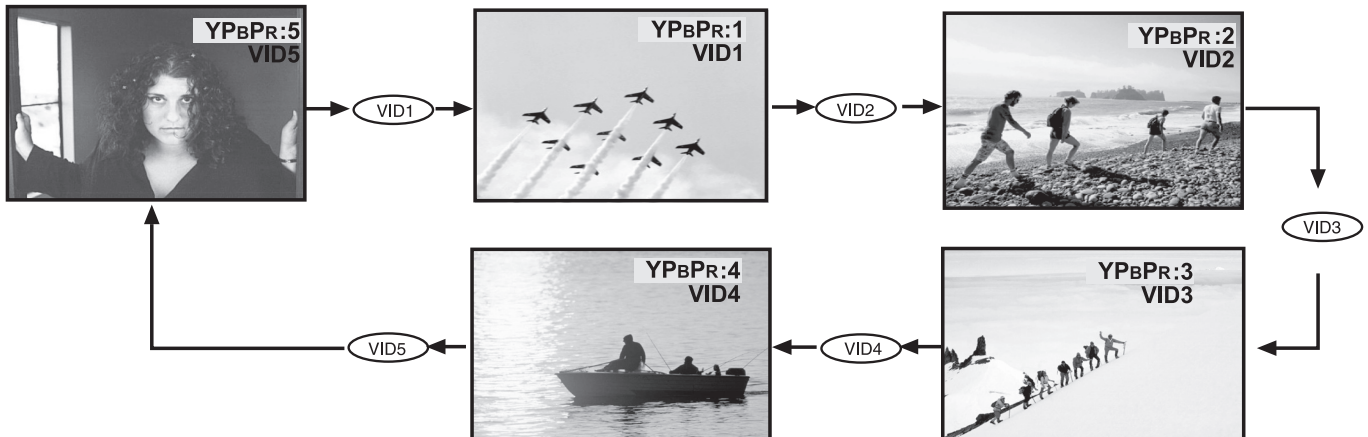

HOW TO USE THE REMOTE TO CONTROL YOUR PROJECTION MONITOR



9 SIZE button

Press this button to quickly change the picture format SIZE ratio.

Depending on the input signal, the picture format ratio allows you to adjust the images through the following options.

- 4:3 Standard Use this size mode to display conventional (4:3) images. Side panels (gray areas) are placed to the left and right of the image to preserve the original size ratio of the source. Note: Use this mode for only 15% of your total viewing time to prevent uneven aging of the phosphors. Phosphors in the lighted area of the picture will age more rapidly than the black areas.
- 4:3 Expanded use this size mode to display conventional (4:3) sources by linearly increasing image expansion from the center towards the edges of the display area in order to fill it.
- 4:3 Zoom1/Zoom2 Use these size modes to zoom in on conventional (4:3) sources.
- 16:9 Standard Use this size mode to display 16:9 sources like HDTV and DVD's preserving the original 16:9 aspect ratio.
- 16:9 Zoom Use this size mode to zoom 16:9 images.

(1) 480i/NTSC

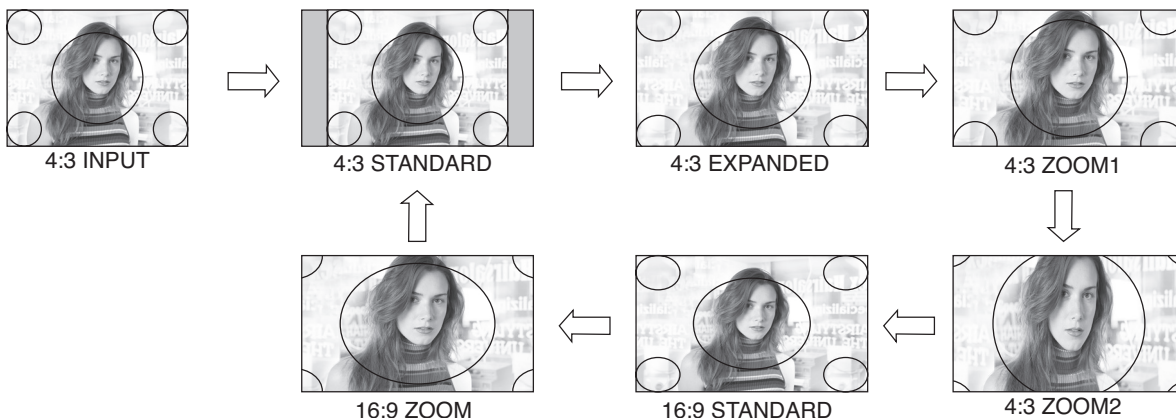

(2) 480p INPUT with Video ID: Letter

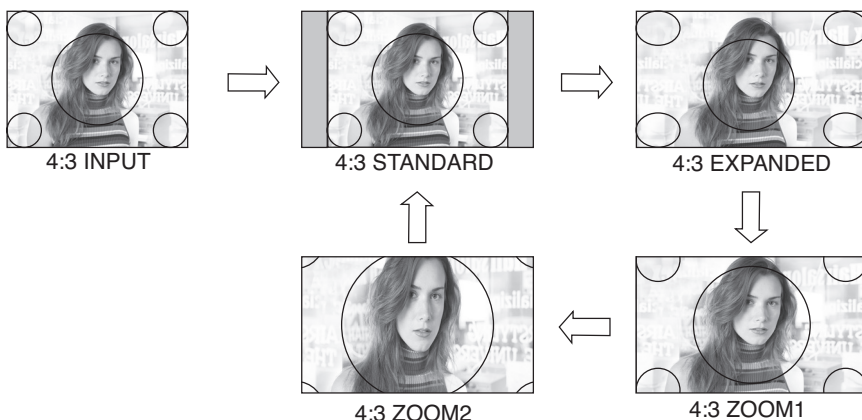

(3) 720p/1080i INPUT

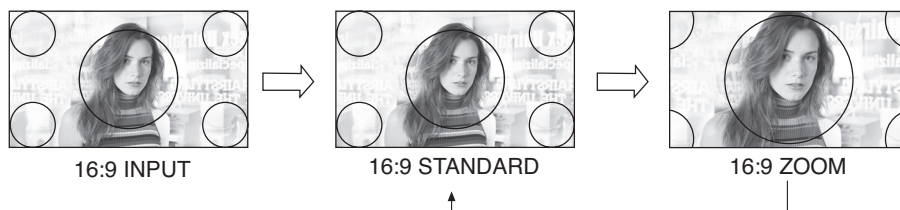

NOTE: All five video inputs have independent Picture Format ratio settings.



HOW TO USE THE REMOTE TO CONTROL YOUR PROJECTION MONITOR

- ⑩ **SLEEP button**
Show and set your SLEEP timer for up to 3 hours in 15 minute intervals.



- ⑪ **INFO button**
Press this button when you want to check the channel being received, the picture source, if the channel has stereo (ST) or second audio program (SAP), the time and CHANNEL ID.

When a COMPONENT VIDEO: Y-P_BP_R Input is connected to VIDEO: 1.

When an S-VIDEO Input is connected to VIDEO: 3.

- ⑫ **EXIT button**
When in MENU mode, this button will exit all On-Screen Displays.
- ⑬ **LAST CHANNEL (LAST CH) button [Cable Box/Satellite Receiver (CBL/SAT) Mode Only]**
This button is only applicable when in CBL/SAT mode. Use this button to select between the last two channels viewed.

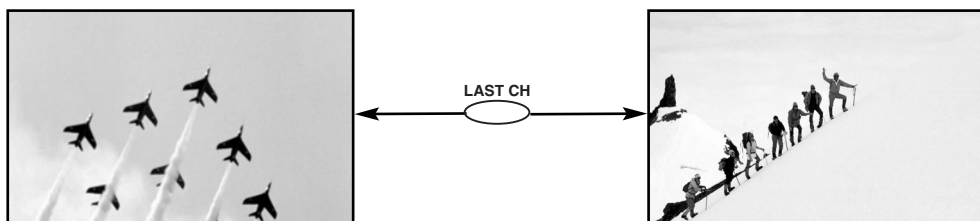

- ⑭ **C.C. button**
Press this button to set the Closed Caption options to ON, OFF, and AUTO.
- ⑮ **MENU button**
The MENU button will start the On-Screen Display.

THE REMOTE CONTROL

PICTURE-IN-PICTURE (PIP)



All Video inputs can be viewed as both the main picture and the sub-picture simultaneously. To select between main picture and PIP sub-picture tuning, press the SWAP button on the remote. The green highlighted Video input display will move with every press of the SWAP button. You can change your Video input when the green highlighted display is shown.

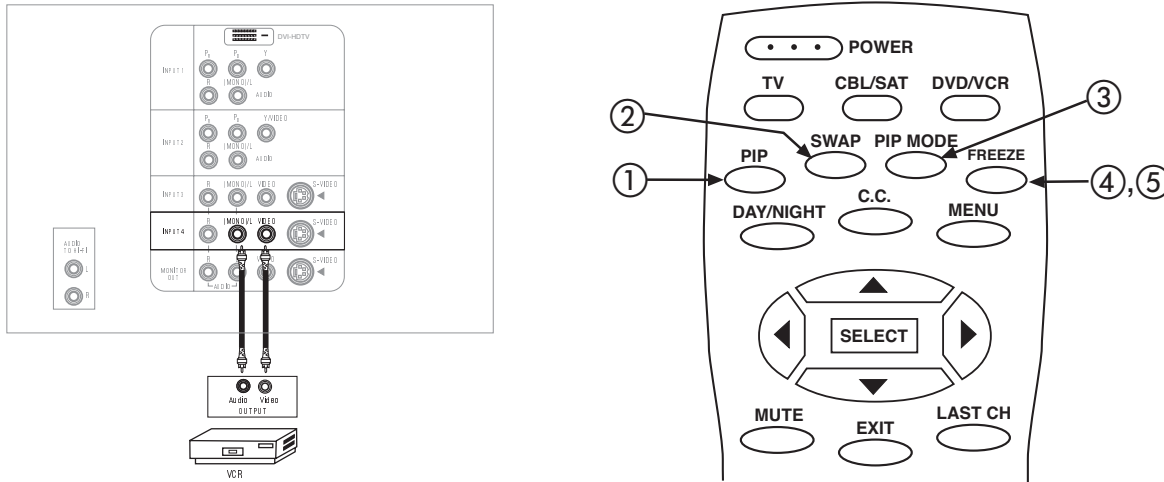

Use above connection to view VCR program as a sub-picture while viewing another program as main picture (VID 1, VID2, VID3, VID5).

① PIP button

Press the PIP button and a sub-picture will appear in one of the three different modes (POP, PIP or SPLIT), depending on the last selection of the PIP mode. To change the PIP mode, use the PIP MODE button to cycle through the three different modes.

POP MODE PICTURE-IN-PICTURE

POP Mode PIP displays the sub-picture outside of the main picture. Use the CURSOR PAD (▲ or ▼) to move the sub-picture. This feature is not available with a 1080i signal. Please refer to the PICTURE-IN-PICTURE MODES Table (see page 26).

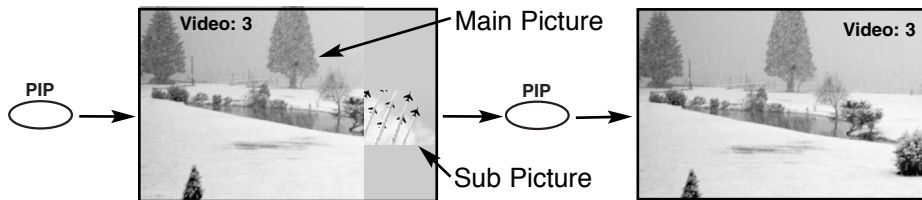

- NOTES:**
1. In POP mode, CURSOR ▲ and ▼ will move the sub-picture up/down.
 2. Only Sound from the main picture can be heard.

PIP MODE PICTURE-IN-PICTURE (This feature is only available with a 1080i signal)

To prevent a pattern burn, occasionally move the sub-picture using the CURSOR ◀, ▶, ▲, ▼.

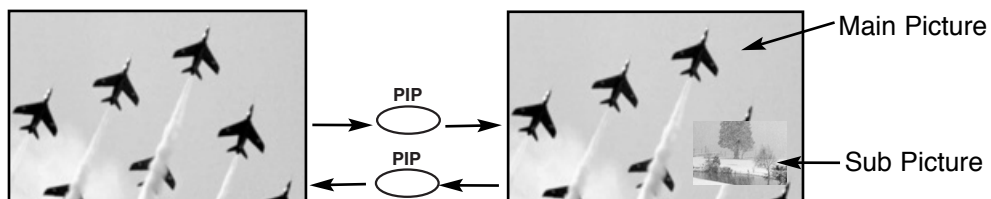



PICTURE-IN-PICTURE (PIP)

SPLIT MODE PICTURE-IN-PICTURE

Split Mode PIP displays the main picture and sub-picture evenly on the screen.



② SWAP button

If you wish to enable the Audio from the Main Picture to the Sub-Picture, press the SWAP button.

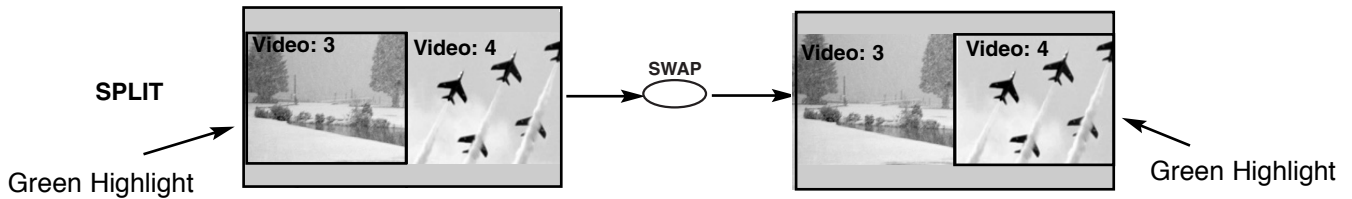

NOTE: The SWAP button will only operate in POP/SPLIT/PIP mode.

③ PIP MODE button

To change between the different PIP modes (POP, PIP or SPLIT) press the PIP MODE button when PIP is ON. Each press of this button will change PIP to a different mode.

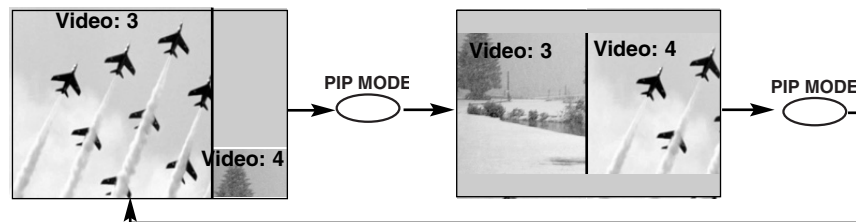

PIP MODES will depend on the type of input signal.

PICTURE-IN-PICTURE (PIP) MODES

	POP	PIP	SPLIT
480i	YES	x	YES
480p	x	x	YES
720p	x	x	YES
1080i	x	YES	YES



PICTURE-IN-PICTURE (PIP)

④ FREEZE button (With PIP ON)

If you wish to freeze the sub-picture, press the FREEZE button. This is convenient when trying to write down the address for a mail order company, recording statistics for a sporting event, etc. To return the picture to motion, press the FREEZE button again.

NOTE: When PIP is on, the FREEZE function will only operate when POP/PIP/SPLIT mode is chosen.

⑤ FREEZE button (with PIP OFF)

Press the FREEZE button to freeze the picture, depending on the PIP mode selected (POP Sub Freeze, SPLIT or STROBE). To change FREEZE modes, use the PIP MODE button to cycle through the three different modes.

POP SUB FREEZE (with PIP OFF)

PIP should be in POP mode. Press the FREEZE button to freeze. Press the FREEZE button again to return to normal viewing.



SPLIT FREEZE(with PIP OFF)

PIP should be in SPLIT mode. Press the FREEZE button to freeze the picture you are currently viewing (only the right sub-picture will freeze). Press the FREEZE button again to return to normal viewing.

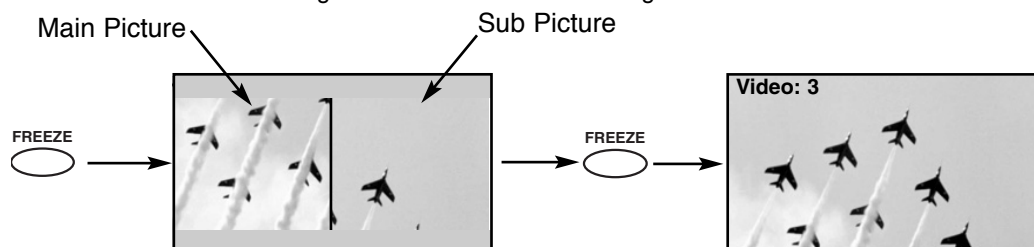

STROBE FREEZE(with PIP OFF)

Freeze Mode should be in STROBE Freeze. Press the FREEZE button to freeze three frames of the picture you are currently viewing. Press this button again to return to normal viewing. This feature is useful for viewing a moving picture that has many details, for example, a close play in a sporting event or a golf swing.

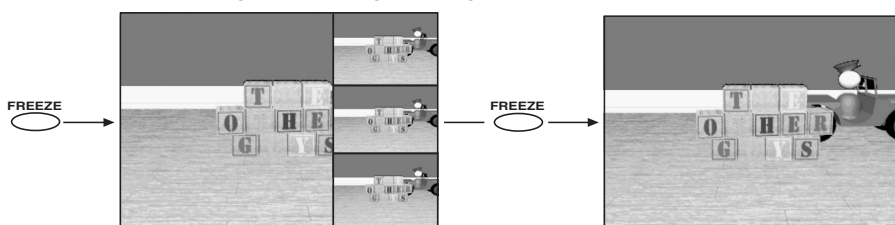

NOTES: Each freeze frame is delayed about 0.1 (1/10) second.

THE REMOTE CONTROL



USING THE REMOTE TO CONTROL VCR FUNCTIONS

Operating the precoded function for your VCR.

This remote is designed to operate different types of VCRs. You must first program the remote to match the remote system of your VCR.

1. Turn ON your VCR.
2. Aim the remote control at the front of your VCR.
3. Press and release the DVD/VCR button to switch to VCR pre-coded mode.
4. Hold down the DVD/VCR button on the remote and enter the two digit preset code that matches your VCR, as shown below.
5. Aim the remote at the VCR and press the POWER button. The remote will turn off your VCR when the correct two digit preset code is entered. When this occurs, the remote control is programmed for your VCR. If the VCR does not turn off, try a different two digit preset code.
6. The remote will now control your VCR.

NOTES:

1. If your VCR cannot be operated after performing the above procedures, your VCR's code has not been precoded into the remote.
2. In the unlikely event that your VCR cannot be operated after performing the above procedures, please consult your VCR operating guide.
3. The remote control will remember the codes you have programmed until the batteries are removed from the remote control. After replacing the batteries repeat the entire programming procedure as stated above.

① DVD/VCR Button

This button allows the remote to control your VCR by setting it to VCR mode.

② PRECODED VCR Buttons

These buttons transmit the chosen precoded VCR codes. For some VCRs, you must press the RECORD button twice to record a program.

③ EXCLUSIVE TV (Monitor) Buttons

These buttons are for operating the Projection Monitor.

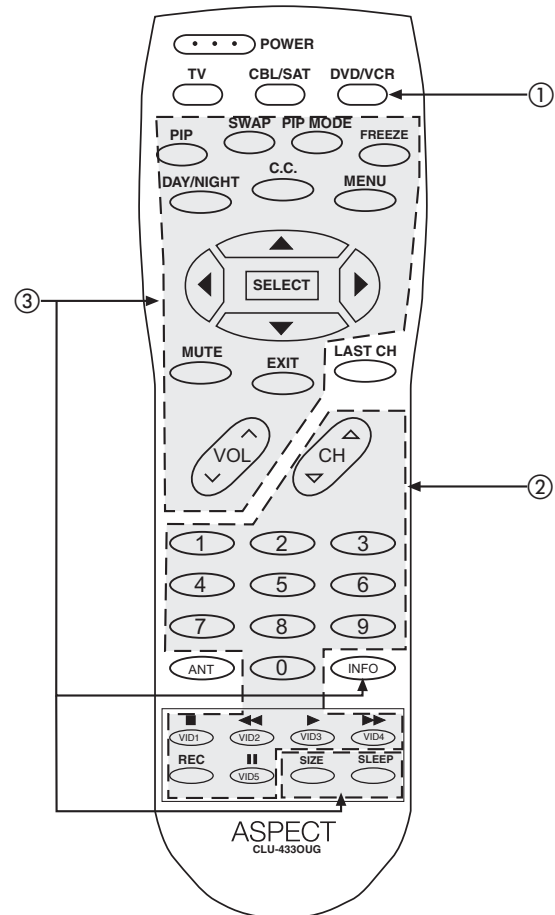

MY VCR CODE IS: _____

VCR BRAND	CODE
Aiwa	.48
Daewoo	.45
Emerson	.20,21,22,23,24
Fisher	.34,37,38,39
Funai	.52
General Electric	.33
Goldstar	.36
Hitachi	.00,01,02,03,04,05,06
JVC	.18,49,50,51
Magnavox	.12,13,14
Mitsubishi	.27,28,29,30
NEC	.40,41
Panasonic	.10,11
Philips	.14
Samsung	.17,25,26
Scott	.16
Sharp	.31,32
Shintom	.19
Sony	.07,08,09
Symphonic	.42
Teknica	.46
Toshiba	.15

NOTE: Refer to instruction manual of the VCR for operation of the buttons exclusively for the VCR.

USING THE REMOTE TO CONTROL CABLE/SATELLITE BOX FUNCTIONS



Operating the precoded function for your cable/satellite box.

This remote is designed to operate different types of cable/satellite boxes. You must first program the remote to match the remote system of your cable/satellite box .

1. Turn ON your cable/satellite box.
2. Aim the remote control at the front of your cable/satellite box.
3. Press and release the cable/satellite (CBL/SAT) button to switch to cable/satellite pre-coded mode.
4. Hold down the CBL/SAT button on the remote and enter the two digit preset code that matches your cable/satellite box as shown below.
5. Aim the remote at the cable/satellite box and press the POWER button. The remote will turn off your cable/satellite box when the correct two digit preset code is entered. When this occurs, the remote control is programmed for your cable/satellite box. If the box does not turn off, try a different two digit preset code.
6. The remote will now control your cable/satellite box.

NOTES:

1. If your cable/satellite box cannot be operated after performing the above procedures, your cable/satellite box code has not been precoded into the remote.
2. In the unlikely event that your cable/satellite box cannot be operated after performing the above procedures, please consult your cable/satellite box operating guide.
3. The remote control will remember the codes you have programmed until the batteries are removed from the remote control. After replacing the batteries repeat the entire programming procedure as stated above.

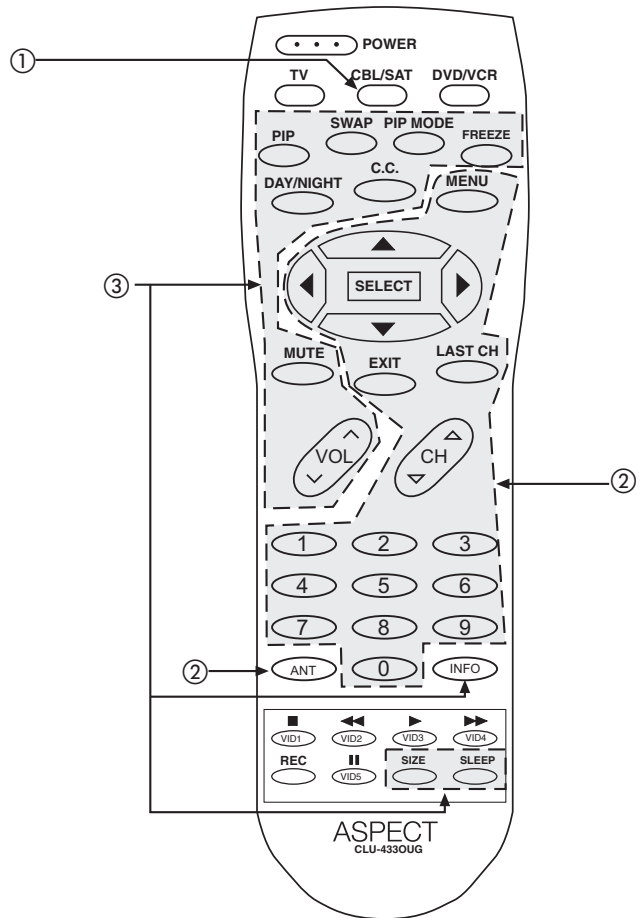

THE REMOTE CONTROL

① CABLE (CBL/SAT) Button

This button allows the remote to control your cable/satellite box by setting it to CABLE/SATELLITE mode.

② PRECODED CABLE/SATELLITE BOX Buttons

These buttons transmit the chosen precoded cable/satellite codes.

③ EXCLUSIVE TV (Monitor) Buttons

These buttons are for operating the Projection Monitor.

CABLE BRAND	CODE
General Instrument	17
Hamlin	22, 23, 24, 25
Jerrold	.00, 01, 02, 03, 04, 05, 06, 07, 21
Oak	26, 27, 28
Panasonic	18, 19, 20
Pioneer	13, 14
Scientific Atlanta	.08, 09, 10
Tocom	15, 16
Zenith	11, 12

SATELLITE BRAND	CODE
Ecostar	32
Hitachi	29
Hughes	33
Panasonic	34
RCA	.30, 35
Samsung	36
Sony	31

MY CABLE/SATELLITE BOX CODE IS: _____

NOTE: Refer to instruction manual of the Cable/Satellite Box for operation of the buttons exclusively for the Cable/Satellite Box.



USING THE REMOTE TO CONTROL DVD FUNCTIONS

Operating the precoded function for your DVD player.

This remote is designed to operate different types of DVD players. You must first program the remote to match the remote system of your DVD player.

1. Turn ON your DVD player.
2. Aim the remote control at the front of your DVD player.
3. Press and release the DVD/VCR button to switch to DVD pre-coded mode.
4. Hold down the DVD/VCR button on the remote and enter the two digit preset code that matches your DVD player, as shown below.
5. Aim the remote at the DVD player and press the POWER button. The remote will turn off your DVD player when the correct two digit preset code is entered. When this occurs, the remote control is programmed for your DVD player. If the DVD player does not turn off, try a different two digit preset code.
6. The remote will now control your DVD player.

NOTES:

1. If your DVD player cannot be operated after performing the above procedures, your DVD player's code has not been precoded into the remote.
2. In the unlikely event that your DVD player cannot be operated after performing the above procedures, please consult your DVD player operating guide.
3. The remote control will remember the codes you have programmed until the batteries are removed from the remote control. After replacing the batteries repeat the entire programming procedure as stated above.

THE REMOTE CONTROL

- ① **DVD/VCR Button**
This button allows the remote to control your DVD player by setting it to DVD mode.
- ② **PRECODED DVD Buttons**
These buttons transmit the chosen precoded DVD codes.
- ③ **EXCLUSIVE TV (Monitor) Buttons**
These buttons are for operating the Projection Monitor.

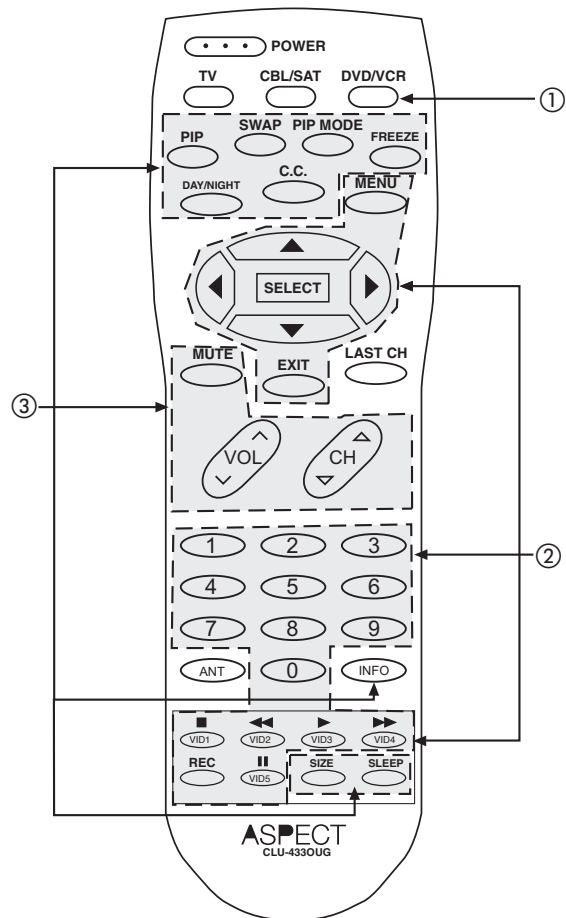

DVD BRAND	CODE
Hitachi	.53, 59, 60
Panasonic	.55
Pioneer	.56
RCA	.57
Samsung	.59
Sanyo	.60
Sony	.54
Toshiba	.58

MY DVD PLAYER CODE IS: _____

NOTE: Refer to instruction manual of the DVD player for operation of the buttons exclusively for the DVD player.

ON-SCREEN DISPLAY (OSD)

1. Press MENU on the remote control to display the different features on your ASPECT Projection Monitor.
2. Press the CURSOR ◀, ▶, ▲ and ▼ to highlight a different feature, then press SELECT to choose.
3. Press EXIT on the remote control to quickly exit from a menu.
4. Press CURSOR ◀ or ▶ to access Favorite Channels menu.

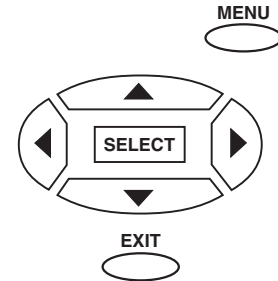

This part of the screen shows which selections are available.

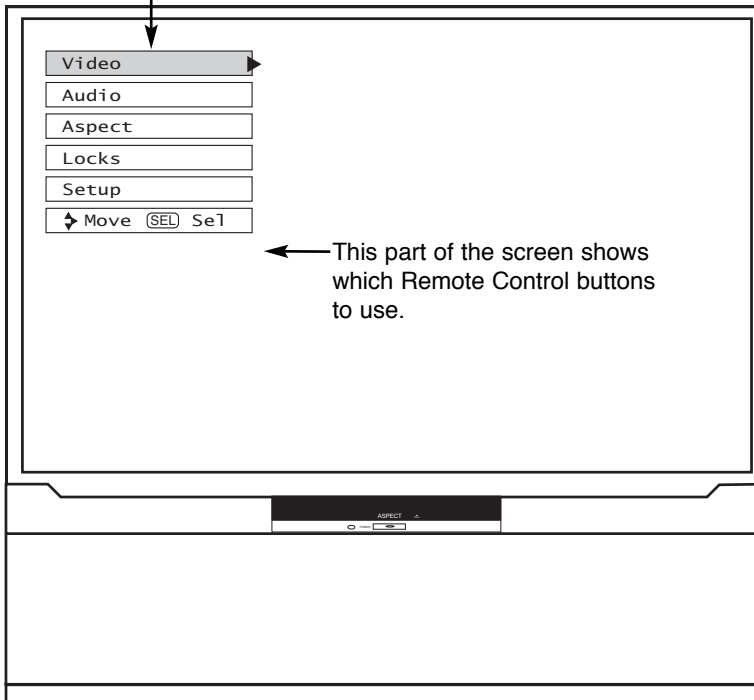

← This part of the screen shows which Remote Control buttons to use.

Video	Picture Mode	Select between the two picture modes; Day and Night.
	Contrast	Adjust contrast.
	Brightness	Adjust brightness.
	Color	Adjust color.
	Tint	Adjust tint.
	Sharpness	Adjust sharpness.
	Color Temperature	Set this to High for less intense color with more blue, set to Medium for natural color, set to Standard for standard colors or Black and White for more reddish color.
	Black Enhancement	Adjust shadow detail in dark screens.
	Edge Enhancement	Automatically enhances the edges between light and dark areas.
	Reset Video Settings	Choose to Reset Video settings.
	Color Management	Adjust and balance individual colors to make either deeper or more pure according to preference.
	Color Decoding	Adjust the percentage of Red, Green and Color according to preference.
	Auto Color	The AUTO COLOR function automatically monitors and adjusts the color to maintain constant color levels even after a program or channel changes. It also maintains natural flesh tones while preserving fidelity of background colors.
	Noise Reduction	Reduces conspicuous noise in the picture.
Auto Movie Mode	Turn ON/OFF the 3:2 Pulldown detection feature.	
Audio	Treble	Adjust the treble.
	Bass	Adjust the bass.
	Balance	Adjust the balance.
	Sound Enhancement	Select SRS and BBE settings.
	Internal Speakers	Select internal speakers to be "on" or "off".
	Perfect Volume	Adjust volume in fixed setting.
	Loudness	Adjust Loudness.
Aspect	Mode	Choose the picture format aspect ratio.
Locks	Change Access Code	Change Lock access code.
	Engage Lock	Choose to lock channel, video input, and front panel.
	Movie Ratings	Block various types of movies and video types based on motion picture ratings.
	TV Ratings	Block various types of movies and television programming based on a parental guide ratings.
	Canadian Ratings (ENG)	Block various types of movies and television programming based on the Canadian ratings system.
Canadian Ratings (FRN)	Block various types of movies and television programming based on the Canadian French ratings system.	
Setup	Magic Focus Tune Up	Automatic and manual alignment of the red, green and blue colors to make white.
	Menu Preference	Choose English, French, or Spanish text.
	Set The Clock	Set the Projection Monitor clock. It must be set before using the Lock feature.
	Set The Inputs	Label Video Inputs , VCR, DVD, etc.
	Set The Color System	Set tint and color coordinates for DTV programs.
	Set Virtual HD	Select between 1080i and 540p signal.
	Set Black Side Panel	Set the gray side bars on/off when watching 4:3 signals in standard mode.
	Set Closed Captions	Feature to display dialogue/text.
	About Your TV	Information display for this Projection Monitor.

VIDEO

Video

Select VIDEO to adjust picture settings and improve picture quality. You can independently customize each of the Video Inputs to your preference to increase viewing performance and pleasure depending upon the video program being viewed. If RESET is selected, only the selected input will reset to initial conditions.

Picture Mode

Use this function to choose from automatic picture settings to optimize your Projection Monitor's performance.

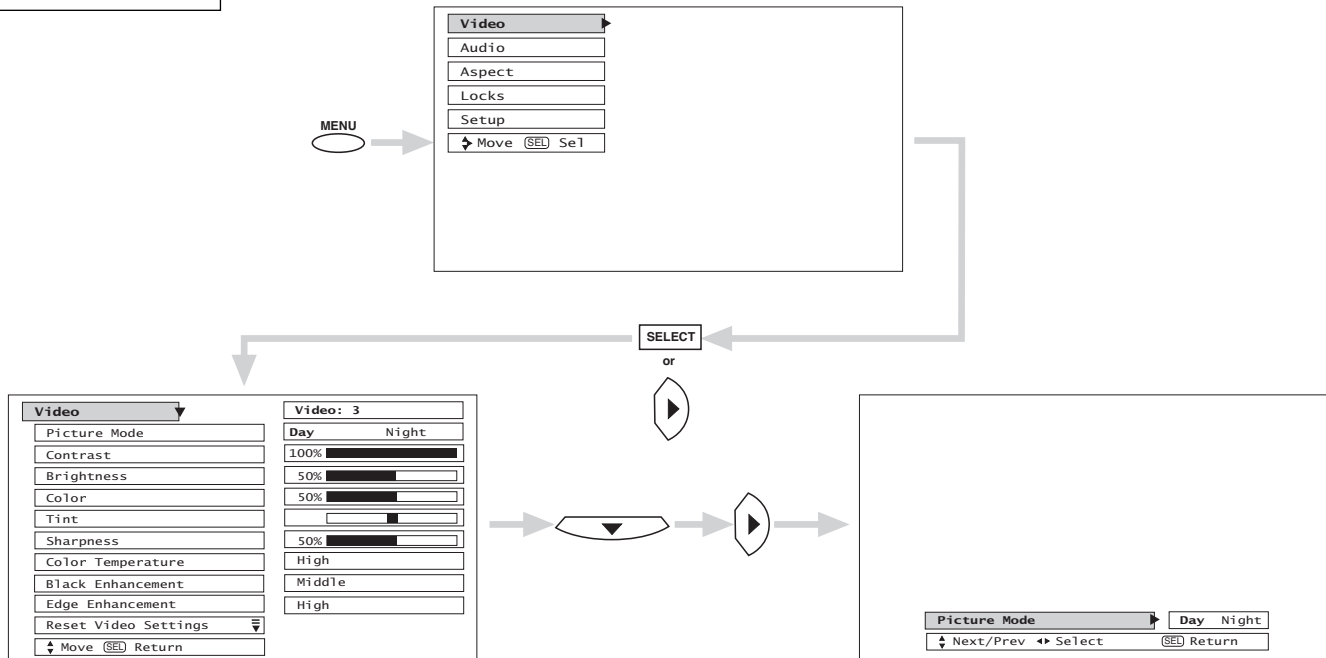

Use CURSOR ◀ or ▶ to highlight and select Picture Mode settings.

Function	Day	Night	Reset
Contrast	100%	50%	Reset the video menu settings on current input automatically to Day Mode.
Brightness	50%	50%	
Color	50%	45%	
Tint	Center	Center	
Sharpness	50%	50%	
Color Temperature	High	Standard	
Black Enhancement	Middle	Low	
Edge Enhancement	High	Low	
Auto Color	Off	Off	
Noise Reduction	Off	Off	
Color Management (Set User Colors)	Off	Off	
Auto Movie Mode (3:2 Pulldown)	Off	Off	

Press EXIT to quit menu or select PICTURE MODE to return to previous menu.

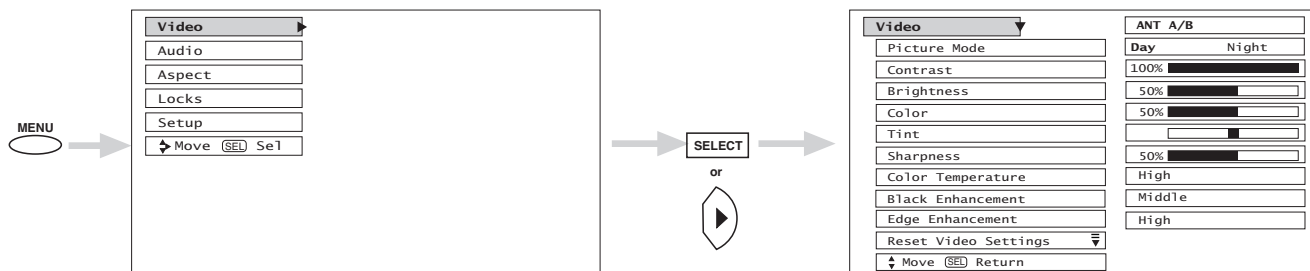

Use the CURSOR ▲ or ▼ to highlight the function to be adjusted.

Press the SELECT button to select the function settings.

Press the CURSOR ◀ or ▶ to adjust the function.

Press MENU to return to main menu.

Press EXIT to quit menu.

Contrast

Use this function to change the contrast between black and white levels in the picture.

Brightness

Use this function to adjust overall picture brightness.

Color

Use this function to adjust the level of color in the picture.

Tint

Use this function to adjust flesh tones so they appear natural.

Sharpness

Use this function to adjust the amount of fine detail in the picture. Sharpness function will be disabled when Noise Reduction is ON.

Color Temperature

Set this to High for cooler color with more blue, set to Medium for more natural color, set to Standard for accurate color or set to Black/White for more reddish color.

Black Enhancement

Use this function to enhance the shadow detail in dark scenes using the settings off, low, middle and high.

Edge Enhancement

Use this function to automatically enhance the edges between light and dark areas using the settings Off, Low, Middle, and High.

- NOTES:**
1. If CONTRAST is selected, you are adjusting CONTRAST. The additional menu items BRIGHTNESS, COLOR, TINT, and SHARPNESS can be selected and adjusted in the same manner.
 2. It may be necessary to adjust TINT to obtain optimum picture quality when using the COMPONENT VIDEO Y-P_BP_R input jacks.
 3. Each of the video inputs have their own independent settings.

VIDEO

Reset Video Settings

This function allows you to Reset the Video Menu Settings of the present input and return it to the Day VIDEO mode.

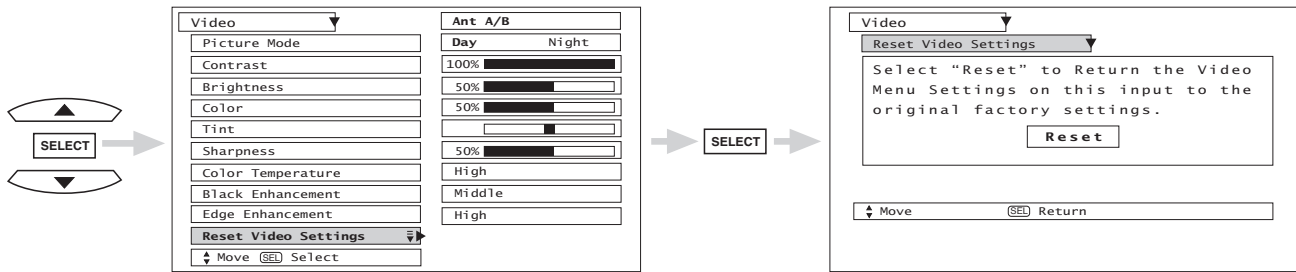

Use CURSOR to highlight functions.
Press the SELECT button to select Reset Video Settings.

Use CURSOR ▼ to access other video settings.

You can customize each of the Video Inputs to your preference to increase viewing performance and pleasure, depending upon the video program being viewed. If RESET is selected, only the selected Input will reset to the initial conditions as explained above.

If RESET is selected in Video:1 mode, only Video:1 mode will return to factory conditions.

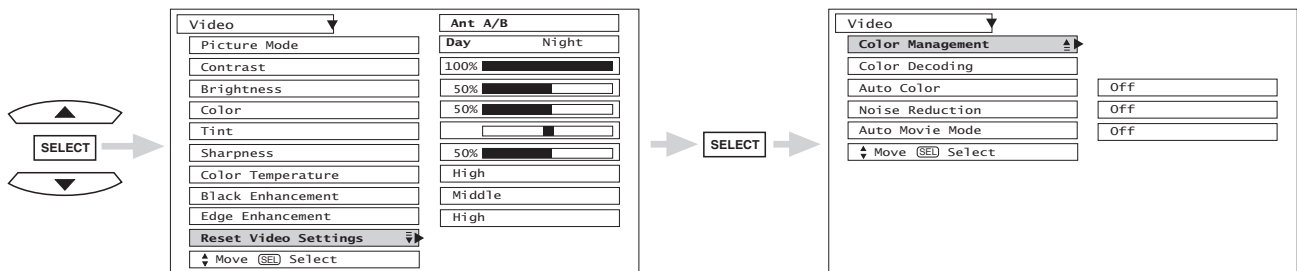

Color Management

Use this function to adjust and balance the listed individual colors to make them either deeper or more pure depending on the user's preference.

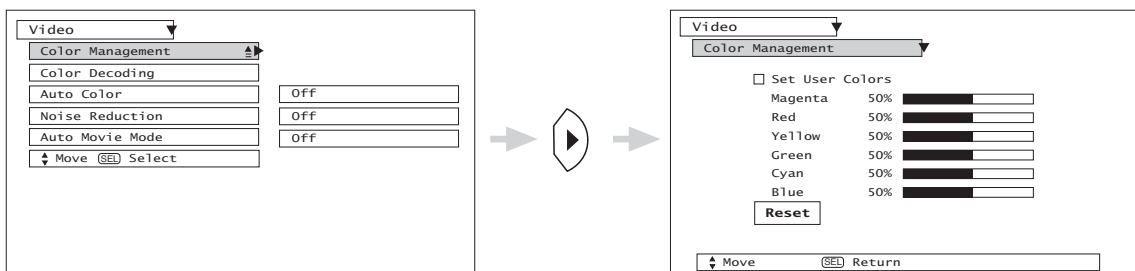

Use CURSOR to highlight function.
Press the SELECT button to select the User Colors setting. When the function has a "✓" in the box, it is ON.
Press CURSOR ◀, ▶, ▼ and ▲ to highlight and adjust individual colors.
Use CURSOR to highlight and select "Reset" to return all colors to default settings.

NOTE: When the Set User Colors box is not checked, the listed colors will be grayed out.

Color Decoding

Use this function to adjust the percentage of Red, Green and Color according to the user's preference. Use TINT to adjust flesh tones so they appear natural.

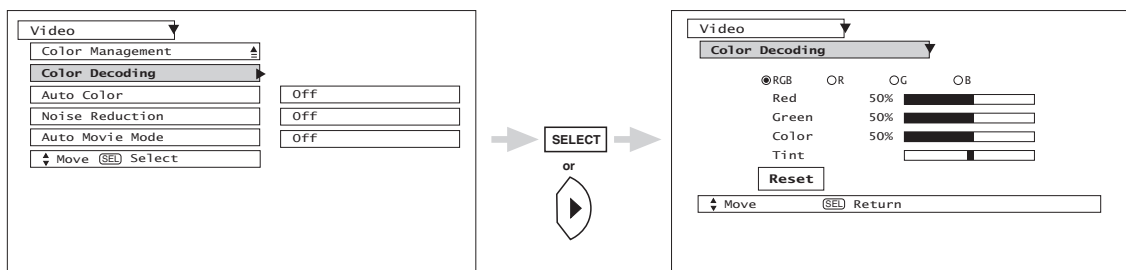

Use CURSOR to highlight function.

Press the SELECT button to select from 4 menu items.

Press CURSOR ◀, ▶, ▼ and ▲ to highlight and adjust Red, Green, Color and Tint.

Use CURSOR to highlight and select "Reset" to return all settings to default.

NOTE: Color Decoding settings are independently stored in each of the 4 Color Temperature settings.

Auto Color

The AUTO COLOR function automatically monitors and adjusts the color to maintain constant color levels even after a program or channel changes. It also maintains natural flesh tones while preserving fidelity of background colors.

NOTE: When using Component or DVI-HDTV input, Auto Color will not be available (grayed out).

Noise Reduction

The NOISE REDUCTION function automatically reduces conspicuous noise in the picture without degrading picture quality. Set NOISE REDUCTION to OFF if the Projection Monitor experiences picture blocking. When Noise Reduction is ON, Sharpness function is disabled (grayed out).

Auto Movie Mode

The Auto Movie Mode function turns ON or OFF the 3:2 PULLDOWN DETECTION SPECIAL FEATURE. Theatrical movies are shot on film at 24 frames or still pictures per second, instead of 30 frames or 60 fields like video. When film is transferred to video for Projection Monitor viewing, the disparity between the two frame rates must be reconciled. This involves a process known as 3:2 pulldown.

When Auto Movie Mode is turned ON from the VIDEO menu, your ASPECT Projection Monitor will activate the circuitry for this special feature to improve video performance when watching film based sources.

NOTES:

1. When using Progressive Scan Component or DVI-HDTV input (Ex. 480p, 720p and 1080i), Auto Movie Mode will not be available (grayed out).
2. All Video settings are independent of each other based on it's input (Input 1~5).

AUDIO

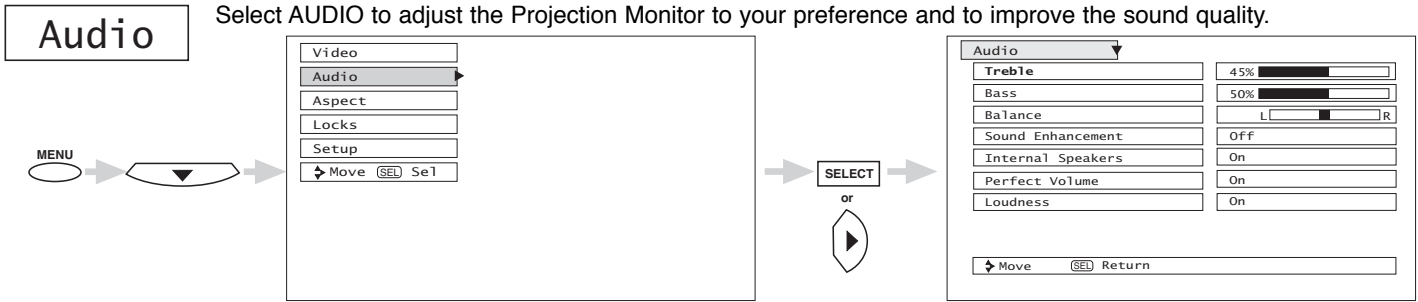

Press CURSOR ▲ or ▼ to select menu item.
 Press CURSOR ◀ or ▶ to adjust the function.
 Press EXIT to quit the MENU, or select AUDIO to return to the main menu.

NOTE: If TREBLE is selected you are adjusting treble. The additional menu items Bass and Balance can be selected and adjusted in the same manner.

- | | |
|--------------------------|--|
| Treble | This function controls the high frequency audio to all speakers. |
| Bass | This function controls the low frequency audio to all speakers. |
| Balance | This function will control the left to right balance of the Projection Monitor internal speakers. |
| Sound Enhancement | See page 38. |
| Internal Speakers | This function is useful when setting up the external speakers.
ON - Select this feature if using the internal speakers only.
OFF - Select this feature if you prefer to use only speakers from a separate stereo system. |
| Perfect Volume | This function will automatically adjust volume so each channel and input has the same average volume level. |
| Loudness | This function turns loudness ON or OFF. It will improve the quality of both low and high frequency sounds when listening at low volume levels. |

Sound Enhancement

The following surround settings will reproduce the “live” sound you would hear in concert halls, sports stadiums, movie theaters, etc. with only two speakers.

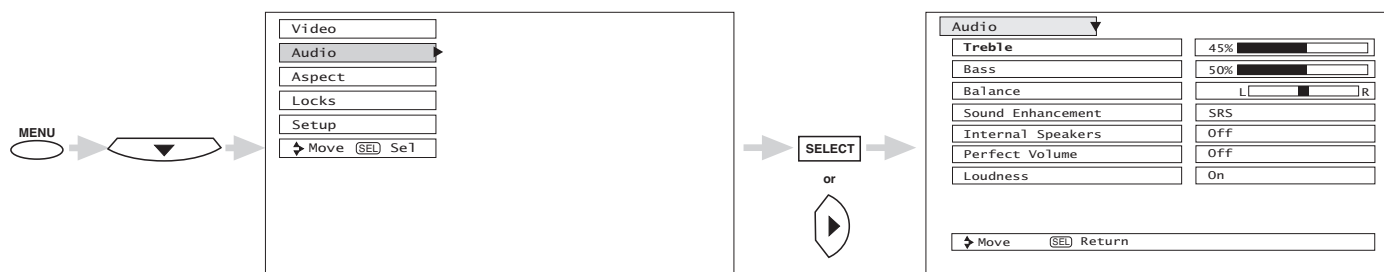

To enter SOUND ENHANCEMENT, use CURSOR ▲ or ▼ to highlight then press CURSOR ► to select SOUND ENHANCEMENT of your choice (Off, SRS, BBE and SRS and BBE).

Use the CURSOR to highlight your sound enhancement choice, and press SELECT to select your choice.



Based on the principles of the human hearing system, SRS technology delivers an exciting and realistic 3D Sound experience from just two external speakers (or) the two internal speakers of your ASPECT Projection Monitor. If your ASPECT Projection Monitor is connected to an external audio system, SRS will also create an incredible 3D sound experience from two speakers and even enhance a complete multi-speaker surround sound system.

NOTES: *SRS and the  symbol are trademarks of SRS Labs, Inc. SRS technology is incorporated under license from SRS Labs, Inc.

BBE Technology

Sound reproduction quality enhancement system. The BBE technology produces sound that is natural and crisp from just two speakers (or) the two internal speakers of your ASPECT Projection Monitor. If your ASPECT Projection Monitor is connected to an external audio system, BBE will also create an incredible crisp sound experience from two speakers. BBE brings to the listener's ear a more complete and accurate reproduction of the original performance. Each voice, speaking or singing, each instrument or sound effect is presented with its attendant harmonics or partials more clearly audible. The ear can then more easily recognize the unique tonal colors of each sound as though the sound was being produced live.

NOTES: Licensed by BBE Sound, Inc. under USP5510752 and 5736897. BBE and BBE symbol are registered trademarks of BBE Sound, Inc. Manufactured under license from BBE Sound, Inc.

ASPECT

Aspect Mode

Use this function to select the Picture Format Aspect Ratio (SIZE).

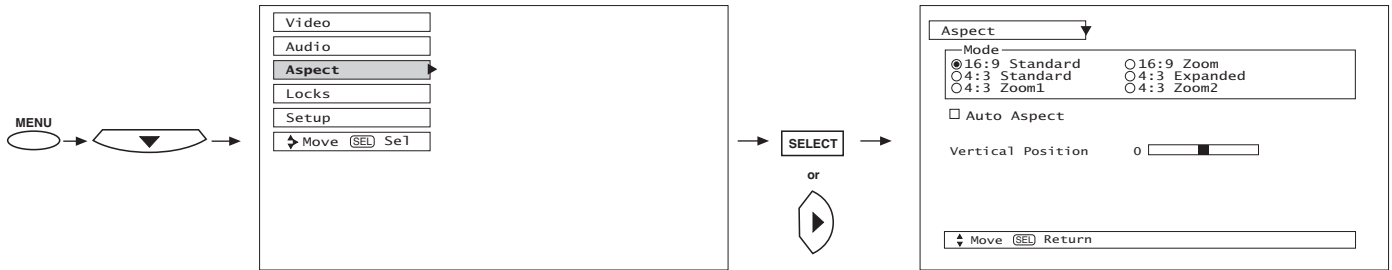

Auto Aspect

Automatically adjust the Aspect Ratio depending on the input signal to fill the screen.

Press CURSOR ▲, ▼, ◀ and ▶ to select menu item.

Press the SELECT button to select. A “√” in the box indicates that the feature is ON.

- NOTES:**
1. The Auto Aspect function is recommended on an input signal with VIDEO ID.
 2. The Auto Aspect function is best used on composite video, S-Video, and 480i component signals.
 3. See page 23 for Aspect Mode availability.

Vertical Position

This function allows you to select when aspect style is either 4:3 EXPANDED/ZOOM1/ZOOM2 or 16:9 ZOOM. Vertical position can be changed with these modes. For example, it will be useful for centering the picture area at both the top and bottom of the picture with 480i/480P signal. Adjustable range is -10 (video center is toward bottom of screen) to +10 (video center is toward top of screen).

Press CURSOR ▲ or ▼ to select menu item.

Press CURSOR ◀ or ▶ to adjust the function.

Press EXIT to quit the MENU, or select ASPECT to return to the main menu.

NOTE: Vertical Position will not be available in 4:3 Standard and 16:9 Standard modes.

Locks

This function is only available if used in conjunction with an external tuner. This function will block out the picture and sound of the selected channel or video input. It can also be used to keep the Projection Monitor from being viewed for a scheduled time period that you set.

The code to enter the Locks feature is a four digit secret code number. The factory preset code is 0000. Use the number buttons to select secret code.

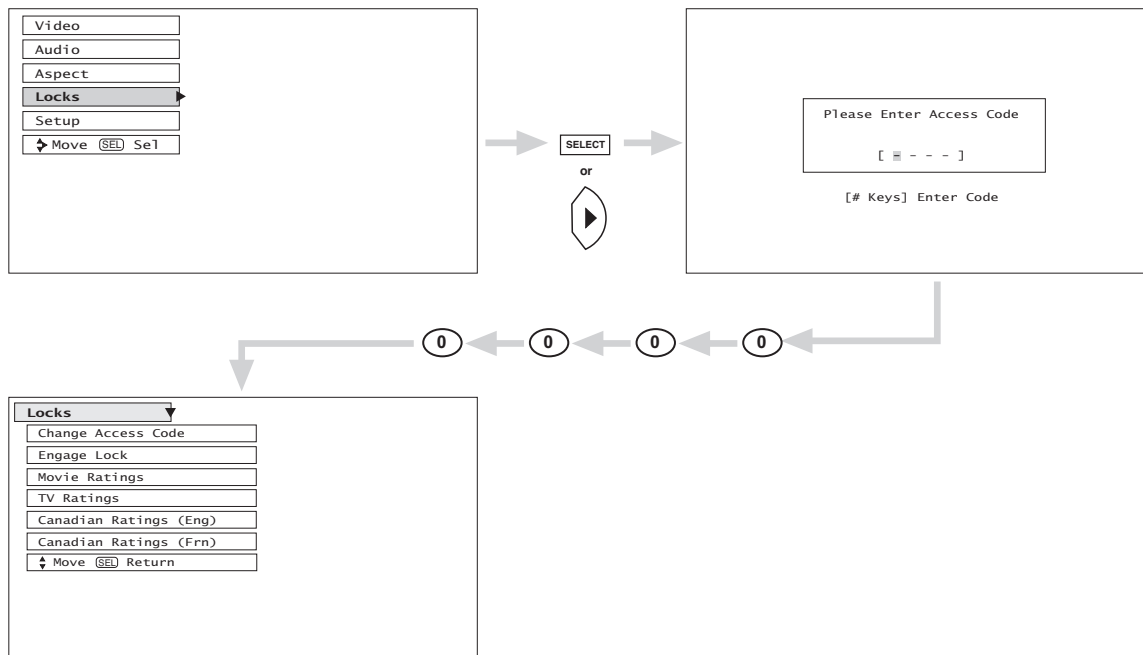

Use CURSOR ▲ or ▼ to highlight function and then press SELECT button.

To change the secret code number, select Change Access Code. Enter a new four digit key number you prefer.

Select CHANGE ACCESS CODE to change the factory preset code (0000) to your preference.

When ENGAGE LOCK is selected, SET INPUT LOCK and SET FRONT PANEL LOCK can be set individually.

When SET INPUT LOCK is turned on, the picture and sound for all video inputs will be blocked out.

When FRONT PANEL LOCK is turned on, all buttons on the Front Panel will be deactivated, except the Power button.

When MOVIE RATINGS is selected, you can block various types of movies and video tapes based on motion picture ratings. Picture-in-Picture will also be blocked automatically (see page 41).

When TV RATINGS is selected, various types of television programming based on a parental guide ratings will be blocked. Picture-in-Picture will also be blocked automatically (see page 42).

Use CANADIAN RATINGS to block various types of movies and television programs based on the two rating systems used in Canada that you feel may be inappropriate due to its content (see pages 43-44).

If you forget your secret code, use the factory code 7777 to erase your key number. This will reset the secret code number back to the factory preset 0000.

Press EXIT to quit the menu or select LOCKS to return to previous menu.

LOCKS

Movie Ratings

Use MOVIE RATINGS to prevent viewing of any movie that you feel may be inappropriate due to its content.

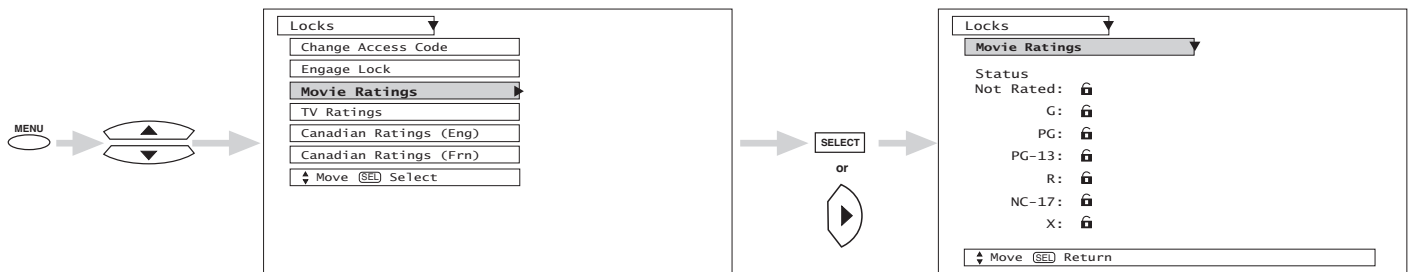

Use CURSOR ▲ or ▼ to select the MOVIE RATING category that you want to block.

Press SELECT to block the MOVIE RATING that you have selected. Once rating is selected, for example PG-13, all movies rated PG-13 and higher (R, NC-17, and X) will be blocked.

Press EXIT to quit the menu or select MOVIE RATINGS to return to the previous menu.

Motion Picture Ratings Table

NOT RATED	Contains no rating. Not Rated (NR) and Not Applicable (NA) programs. Movie has not been rated or ratings do not apply.
G	General audiences. All ages admitted.
PG	Parental guidance suggested. Some material may not be suitable for children.
PG-13	Parents strongly cautioned. Some material may be inappropriate for children under 13.
R	Restricted. Under 17 requires accompanying parent or adult guardian.
NC-17	No one 17 and under admitted.
X	Adults only

- NOTES:**
1. A movie rating is dependent upon the movie that is viewed. If the movie does not carry a rating, the Projection Monitor will not block it.
 2. Blocking "NOT RATED" programs may block emergency programming, sports, news, public service announcements, religious programs and weather.

TV Ratings

Use TV RATINGS to prevent the viewing of any TV program that you feel may be inappropriate due to its content.

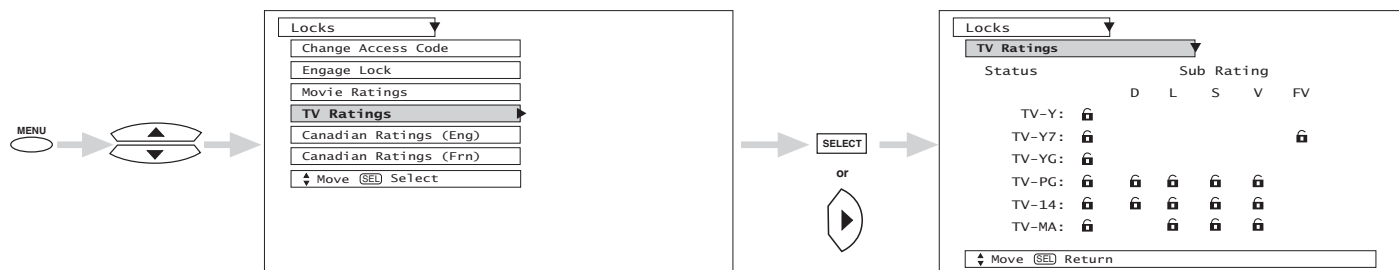

Use CURSOR ▲ or ▼ to highlight the category that you want to block.

Press select to block the TV RATINGS that you have selected.

Press EXIT to quit the menu or select TV RATINGS to return to the previous menu.

TV Parental Guide Ratings Table

TV-Y	All children. The themes and elements in this program are specifically designed for a very young audience, including children from ages 2-6.
TV-Y7	Directed to older children. Themes and elements in this program may include mild physical or comedic violence, or may frighten children under the age of 7.
TV-G	General audience. It contains little or no violence, no strong language, and little or no sexual dialogue or situations.
TV-PG	Parental guidance suggested. The program may contain infrequent coarse language, limited violence, some suggestive sexual dialogue and situations.
TV-14	Parents strongly cautioned. This program may contain sophisticated themes, intense sexual situation, more intense violence and intensely suggestive dialogue.
TV-MA	Mature audiences only. This program may contain mature themes, indecent language, graphic violence, and explicit sexual content.
FV	Fantasy Violence
V	Violence
S	Sexual Situation
L	Adult Language
D	Sexually Suggestive Dialogue.

NOTE:

1. If you Block TV-14D, you will still permit TV MA programs; If you block TV-14V, you will automatically block TV-MAV programs, but you will still permit TV-MALS programs. This means that the Projection Monitor will block violence in TV-14 and higher (TV-MA), but not language and sex.
2. TV program ratings are dependent on the broadcaster. If the program is not rated, the Projection Monitor will not block it.

LOCKS

Canadian Ratings (Eng)

Use CANADIAN RATINGS (ENG) to block any type of movie and television program in Canada that you feel might be inappropriate in its content.

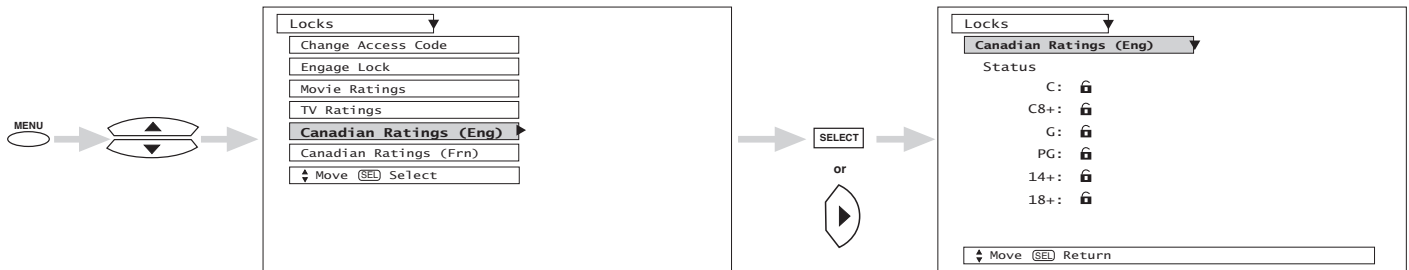

Use CURSOR ▲ or ▼ to select the CANADIAN RATINGS (Eng) category that you want to block.

Press SELECT to set the CANADIAN RATINGS (Eng) that you have selected. Once rating is selected, for example C8+, all movies and television programs rated C8+ and higher (G, PG, 14+ and 18+) will be blocked automatically. Press EXIT to quit menu.

Canadian Ratings English Table

C	Programming intended for children under age 8 - Violence Guidelines: Careful attention is paid to themes, which could threaten children's sense of security and well-being. There will be no realistic scenes of violence. Depictions of aggressive behaviour will be infrequent and limited to portrayals that are clearly imaginary, comedic or unrealistic in nature. Other Content Guidelines: There will be no offensive language, nudity or sexual content.
C8+	Programming generally considered acceptable for children 8 years and over to watch on their own - Violence Guidelines: Violence will not be portrayed as the preferred, acceptable, or only way to resolve conflict; or encourage children to imitate dangerous acts which they may see on television. Any realistic depictions of violence will be infrequent, discreet, of low intensity and will show the consequences of the acts. Other Content Guidelines: There will be no profanity, nudity or sexual content.
G	General Audience - Violence Guidelines: Will contain very little violence, either physical or verbal or emotional. Will be sensitive to themes which could frighten a younger child, will not depict realistic scenes of violence which minimize or gloss over the effects of violent acts. Other Content Guidelines: There may be some inoffensive slang, no profanity and no nudity.
PG	Parental Guidance - Programming intended for a general audience but which may not be suitable for younger children. Parents may consider some content inappropriate for unsupervised viewing by children ages 8-13. Violence Guidelines: Depictions of conflict and/or aggression will be limited and moderate; may include physical, fantasy, or supernatural violence. Other Content Guidelines: May contain infrequent mild profanity, or mildly suggestive language. Could also contain brief scenes of nudity.
14+	Programming contains themes or content which may not be suitable for viewers under the age of 14 - Parents are strongly cautioned to exercise discretion in permitting viewing by pre-teens and early teens. Violence Guidelines: May contain intense scenes of violence. Could deal with mature themes and societal issues in a realistic fashion. Other Content Guidelines: May contain scenes of nudity and/or sexual activity. There could be frequent use of profanity.
18+	Adult - Violence Guidelines: May contain violence integral to the development of the plot, character or theme, intended for adult audiences. Other Content Guidelines: May contain graphic language and explicit portrayals of nudity and/or sex.

Canadian Ratings (Frn)

Use CANADIAN RATINGS (FRN) to block Canadian French programs according to various program ratings that you feel might be inappropriate in its content.

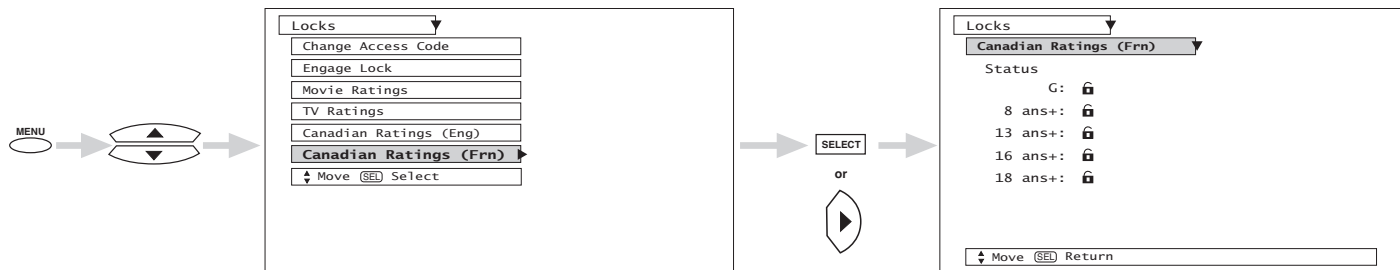

Use CURSOR ▲ or ▼ to highlight the category that you want to block.

Press SELECT to set the CANADIAN RATINGS (Frn) that you have selected.

Once rating is selected, for example 8 ans+, all movies and television programs rated 8 ans+ and higher will be automatically blocked.

Press EXIT to quit menu or select CURSOR ◀ to return to the previous menu.

Canadian Ratings French Table

G	General - Programming intended for audiences of all ages. Contains no violence, or the violence content is minimal or is depicted appropriately with humor or caricature or in an unrealistic manner.
8 ans +	8 + General - Not recommended for young children - Programming intended for a broad audience but contains light or occasional violence that could disturb young children. Viewing with an adult is therefore recommended for young children (under the age of 8) who cannot differentiate between real and imaginary portrayals.
13 ans +	Programming may not be suitable for children under the age of 13 - Contains either a few violent scenes or one or more sufficiently violent scenes to affect them. Viewing with an adult is therefore strongly recommended for children under 13.
16 ans +	Programming is not suitable for children under the age of 16 - Contains frequent scenes of violence or intense violence.
18 ans +	Programming restricted to adults - Contains constant violence or scenes of extreme violence.

SETUP

Setup

Select SETUP when setting your Projection Monitor up for the first time. Use the CURSOR ▲ or ▼ on the remote to highlight the function desired.



Use CURSOR ▲ or ▼ to select the sub-menu of your choice.

Magic Focus Tune Up

Auto Digital Convergence Adjustment

Please turn ON your Projection Monitor for at least 20 minutes before using this feature.

The Magic Focus button on control panel will not work when adjustment mode is set to Manual (see page 47).

Your ASPECT Projection Monitor has three color projection tubes: one for red, one for green, one for blue. When mixed together in the proper proportion, the output of these three color tubes can produce any color. To produce these colors, however, the beams must be precisely aligned over each other so that the colors can be mixed. The process of aligning these picture beams is called "convergence".

Over a period of time, the picture tubes can drift out of alignment due to normal bumps and vibrations or moving the Projection Monitor. If you move your Projection Monitor, or if, after a time, you notice color rings or halos around objects in the picture, you may want to converge (align) the colors.

Properly converged, the lines appear white, which is actually a combination of the outputs of the three color tubes. The output of the green tube is stationary. The outputs of the red and blue tubes can be adjusted. When properly aligned, the outputs of all three tubes should be directly over each other to produce the white lines.

To simplify convergence, ASPECT Projection Monitor incorporates a function called MAGIC FOCUS located on the front control panel, which allows the Projection Monitor to self-adjust. Press this MAGIC FOCUS button and the convergence self adjustment will start and this process will take approximately 20 seconds. If this button is pressed during this process, no change in picture quality will occur. After this 20 second self-adjust period, picture quality will be optimum (do not move the Projection Monitor during self-adjust).

You may also select MAGIC FOCUS TUNE UP from the Setup Menu.

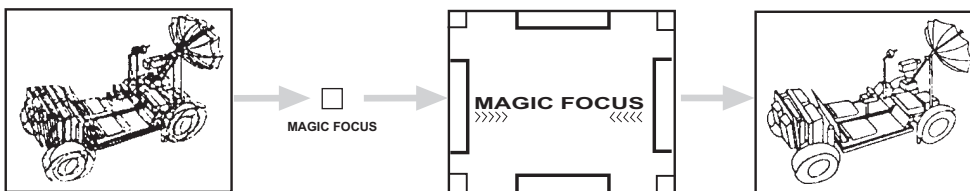

NOTES: Only a momentary press of the MAGIC FOCUS button is necessary to start AUTO DIGITAL CONVERGENCE. At any time during this convergence correction process, you may press the MAGIC FOCUS button to exit the MAGIC FOCUS mode. However, the convergence correction process needs to be completed to SAVE the new corrected convergence data.

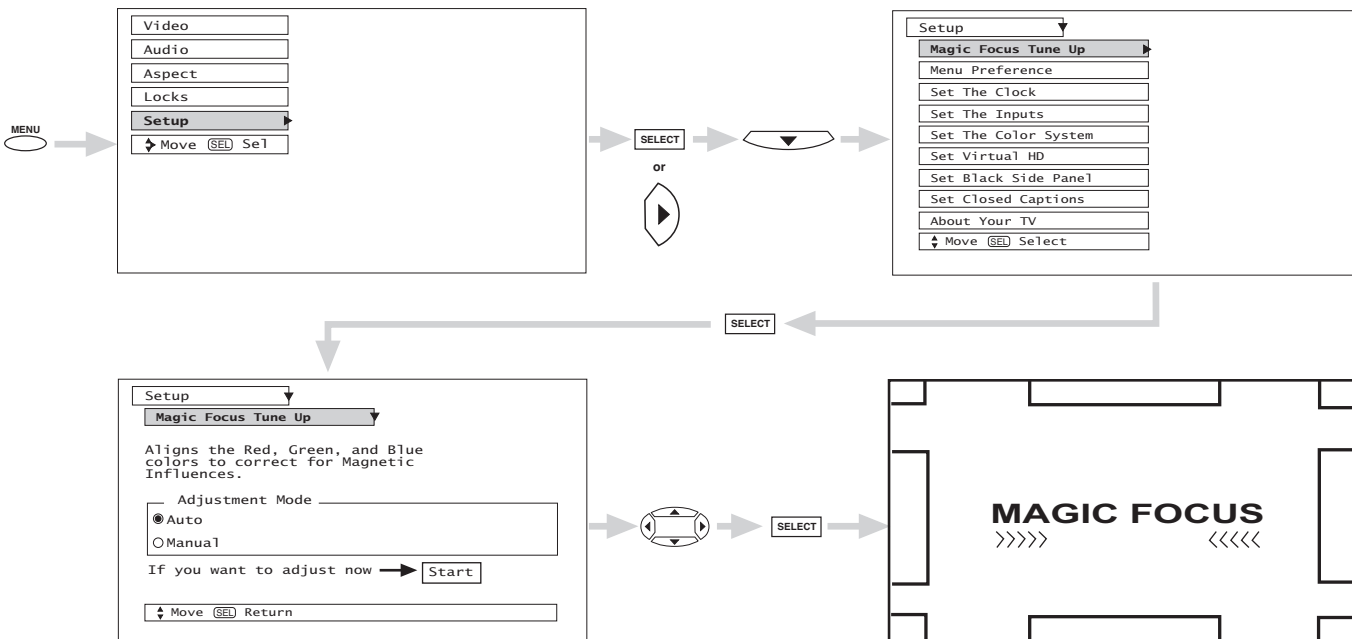

ON-SCREEN DISPLAY

SETUP

Manual Convergence Adjustment Mode

- NOTES:**
1. Please turn ON your Projection Monitor for at least 20 minutes before using this feature.
 2. Auto Adjustment Mode is recommended. If convergence is still not acceptable, use the Manual Adjustment Mode.
 3. If Auto Adjust mode is selected or the Magic Focus button is pressed, all manual adjust mode settings will be erased.

Using the Remote Control, select SETUP-MAGIC FOCUS TUNE UP-MANUAL ADJUSTMENT MODE-START to access convergence crosshatch pattern. The adjustment point is indicated by the Adjustment Point Cursor.

To Move Adjustment Point

To move the adjustment point cursor using the CURSOR buttons, the Adjustment Cursor must be WHITE. Another way to move the Adjustment Point Cursor is to press the following buttons: [2] up, [4] left, [5] down, [6] right. If you use the number buttons while the adjustment point is WHITE, it will change to RED.

To Change the Color of Adjustment Point

Press the SELECT button repeatedly (WHITE-RED-BLUE-WHITE...). Green color is fixed and cannot be adjusted.

To Adjust the Convergence

Move the Adjustment Cursor to the point to be adjusted. Use the CURSOR to match the RED and BLUE colors to GREEN (reference color). Properly aligned, all three colors should appear white.

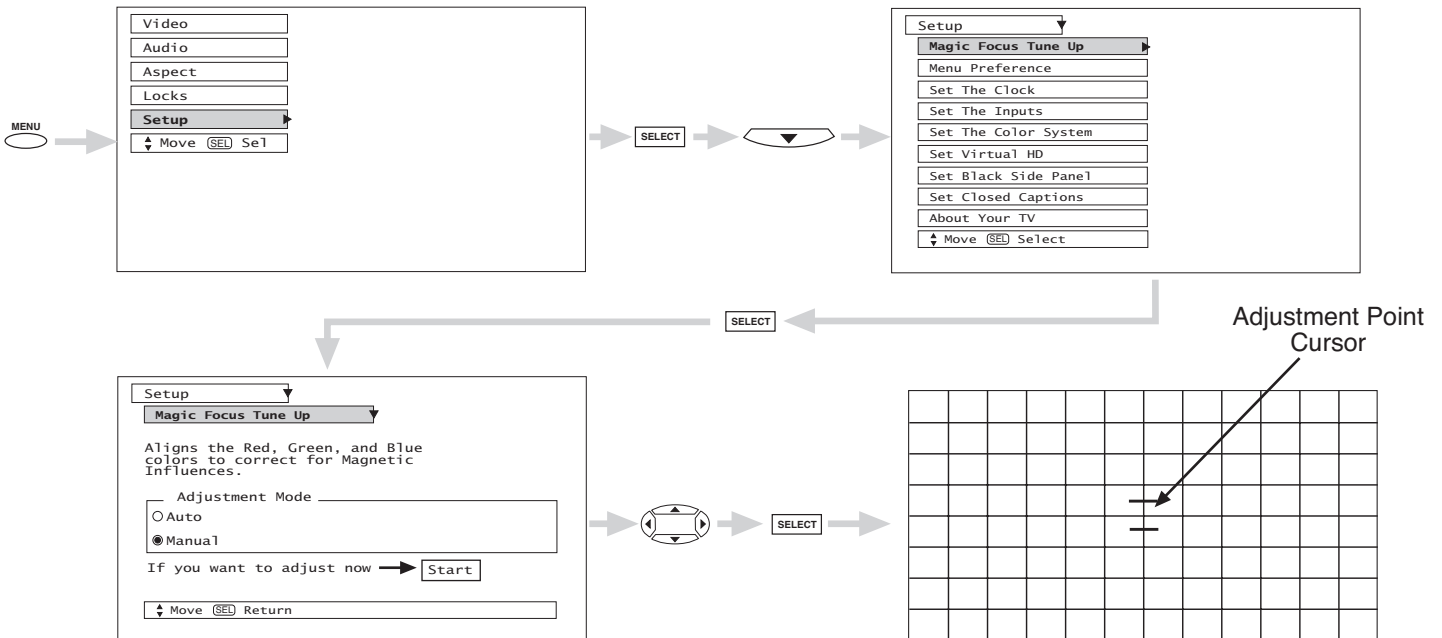

If convergence is acceptable after Manual Convergence adjustment, press EXIT button to access menu mode.

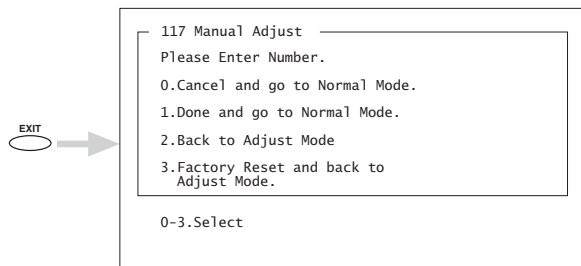

- Press the [0] button on the remote control to CANCEL adjusted data and return to main picture.
- Press the [1] button on the remote control to SAVE adjusted data and return to main picture.
- Press the [2] button on the remote control to return to the manual convergence adjustment mode (crosshatch pattern).
- Press the [3] button on the remote control to recall the factory pre-set convergence data.

Menu Preference

This feature will allow you to select any one of three different languages for all on-screen displays.

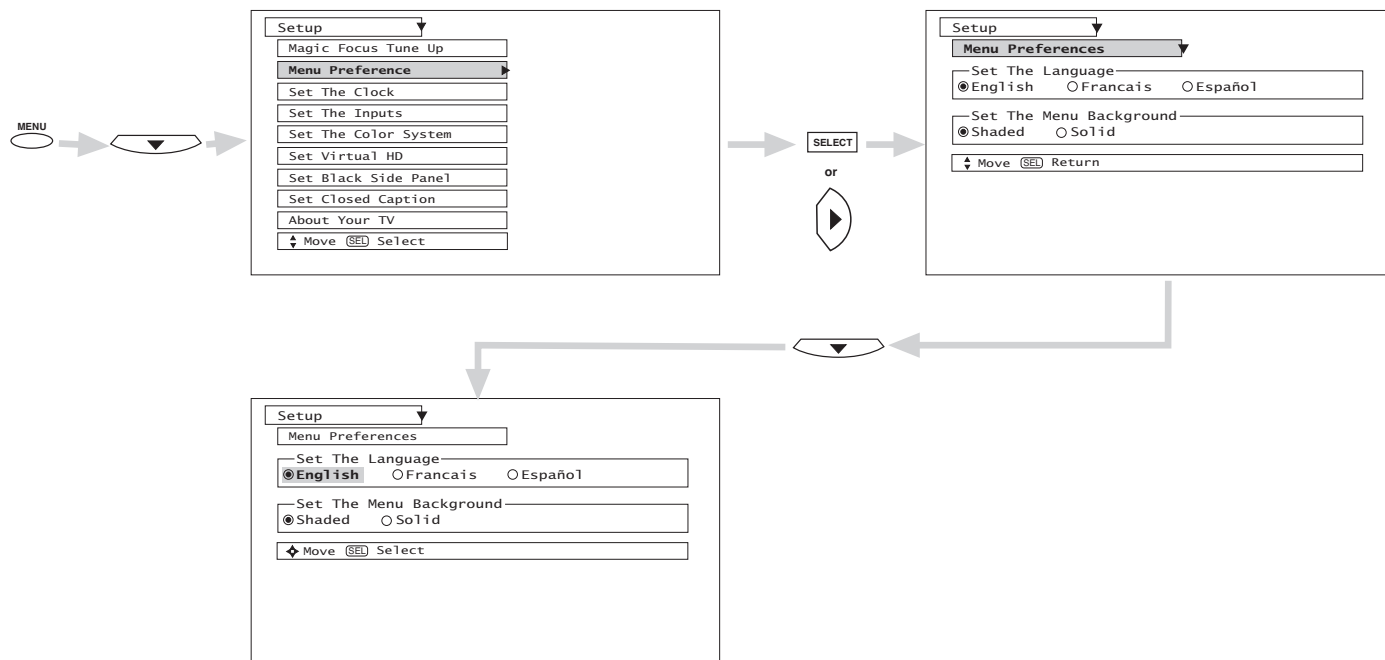

Use CURSOR ◀ or ▶ to highlight the language of your choice.

Press SELECT to select the highlighted language.

Press EXIT to quit menu or select MENU PREFERENCE to return to previous menu.

SETUP

Menu Background

This function allows you to choose from two menu backgrounds.

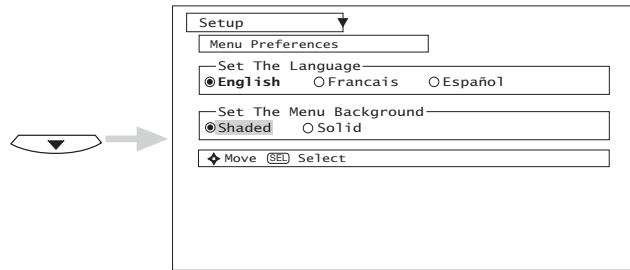

Use CURSOR ◀ or ▶ to highlight SET THE MENU BACKGROUND (shaded or solid), and press the SELECT button to select setting. Press EXIT to quit menu or CURSOR ◀ to return to previous menu. Select SOLID for a black background (no picture can be seen behind menu screen), or select SHADED for a light background.

Set The Clock

The clock must be adjusted before you can use the "Set Event Timer" features.

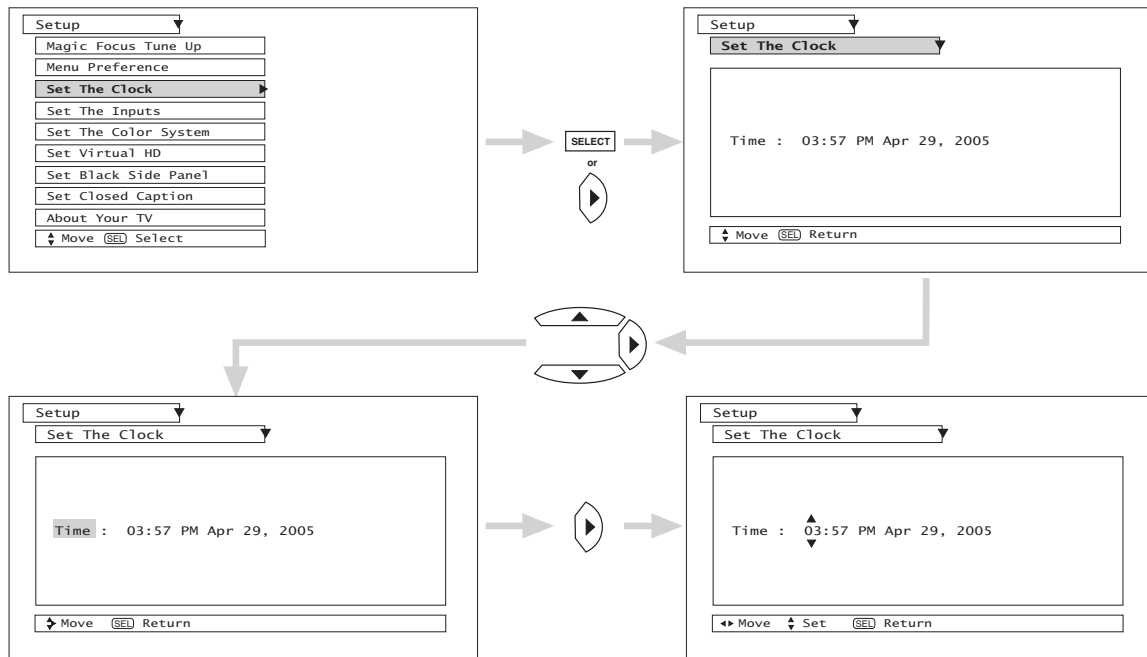

Use CURSOR ▲ or ▼ to set the time and date.
Press CURSOR ◀ or ▶ to change position.
Press EXIT to quit menu or select SET THE CLOCK to return to previous menu.

Set The Inputs

Use this feature to give a name to any of the five video inputs.

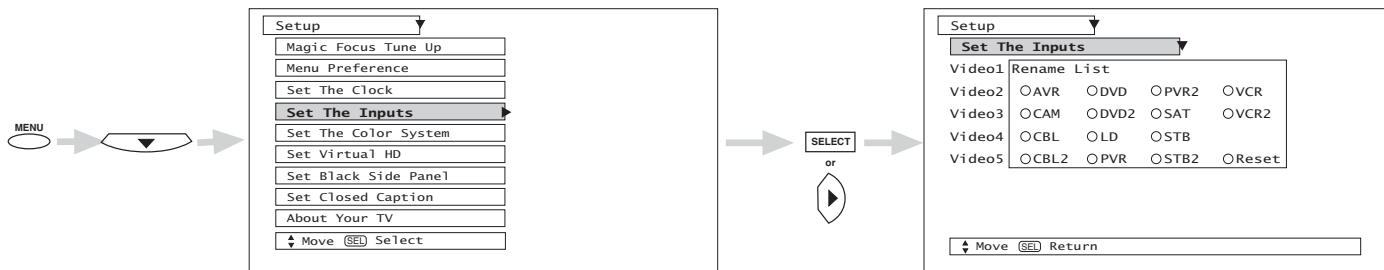

Press CURSOR **▲**, **▼**, **◀**, **▶** to highlight the name of the video inputs.
Press the SELECT button to select desired input name.

Select RESET to set video names to original factory preset condition.

Video 2 Auto Link

Use this function to automatically turn the Projection Monitor on and tune to Video2 when it detects a video signal to input 2.

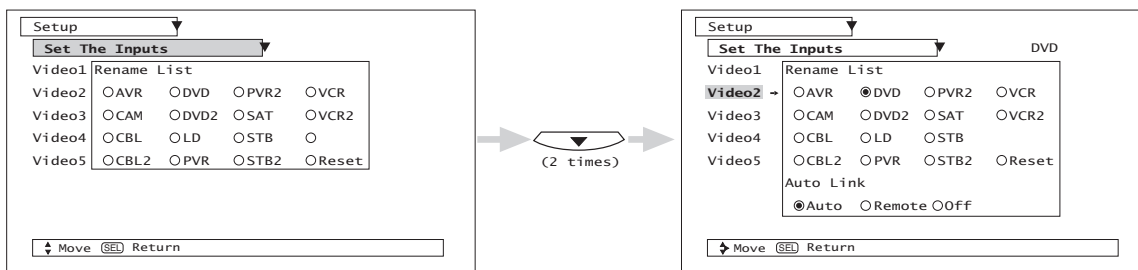

Use CURSOR **◀**, **▶**, **▲** and **▼** then press the SELECT button to change AUTO LINK setting.

When AUTO is selected, the Projection Monitor will turn on and tune to Video2 automatically, when the Video2 input device is turned on. This is convenient when you want to watch a movie with your VCR, laserdisc player, or DVD player.

When REMOTE is selected, the Projection Monitor will turn on and switch to Video2 automatically when the Video2 input device is turned on and the VCR, laserdisc, or DVD play button on your remote control is pressed.

This is convenient when you want to record a movie with your VCR and watch it later.

Select Off to disable this function.

Press EXIT to quit menu.

- NOTES:**
- Once the Projection Monitor has been turned on using the AUTO LINK feature, it must be reset before AUTO LINK is used again. To do this, turn your VCR, laserdisc, or DVD player OFF. This feature is now reset and will turn on your Projection Monitor as described above.
 - When using REMOTE mode, any remote control button will substitute for your video input device play button. However, intended operation is for use with your VCR, laserdisc, or DVD play button.
 - If no remote control button is pressed after the Projection Monitor is turned on by AUTO LINK, the Projection Monitor will automatically turn off after three hours.

SETUP

Set The Color System

This function allows you to automatically change tint and color coordinates for DTV programs.
HDTV - High Definition Television - Use for High Vision Signal Y-P_BP_R from HDTV Set-Top Box.
SDTV/DVD - Standard Definition Television or DVD (Digital Versatile Disc Player) Y-C_BC_R.

- NOTES:**
1. If Color System is set improperly (does not match actual input signal), the color and tint of the main picture will be abnormal.
 2. You must be tuned to VIDEO: 1 or 2 inputs and have a component hooked up to the Y-P_BP_R input jacks to access this color system.
 3. All component color type settings will affect only color component input you are currently viewing. If you are using both sets of component input jacks, be sure to set the color system feature for both inputs.

Set Virtual HD

Use this feature to select between 1080i and 540p.

Set Black Side Panel

The BLACK SIDE PANEL function turns the gray side bars on/off when watching 4:3 signals in Standard mode. The top/bottom gray bar will appear in SPLIT MODE PIP and SPLIT FREEZE.

- NOTE:** To maximize operating life of the Projection Monitor's picture tubes when watching 4:3 signal, Black Side Panel is cancelled at Power OFF. It is recommended to watch 4:3 signal with gray side bar.

Set Closed Caption

Closed Captions are the dialogue, narration, and/or sound effects of a television program or home video which are displayed on the Projection Monitor screen. Your local TV program guide denotes these programs as **CC** or .

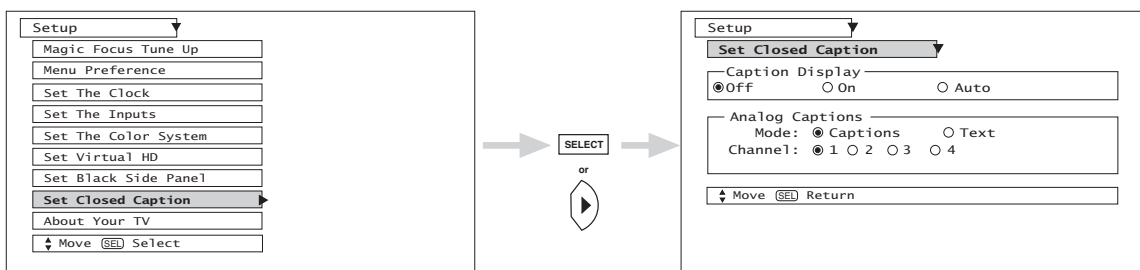

Caption Display: On/Off will turn the **CC** display on or off.

Auto will turn the **CC** display on when Mute/Soft Mute is on.

Caption Mode: Captions is for the program you are viewing.

Text is for additional information such as news reports or a TV program guide. This information covers the entire screen and viewing the TV program is not possible. Text may not be available with every **CC** program.

- CHANNEL:**
- 1 is used for the primary language (usually English).
 - 2 is sometimes used for a second language (may vary by region).
 - 3 is sometimes used for a third language (may vary by region).
 - 4 is sometimes used for a fourth language (may vary by region).

Use CURSOR ▲, ▼ to highlight the function to change then press the SELECT button to change the function. Press EXIT to quit menu or CURSOR ◀ to return to previous menu.

- NOTE:**
1. CAPTION DISPLAY will not work when viewing a 480p, 720p, or 1080i input via the COMPONENT: Y-P_BP_R inputs.
 2. When PIP Surf is on, Closed Caption will not work.

About Your TV

The Projection Monitor model name and set dimensions will be displayed on the screen. The set dimensions of the Projection Monitor model is listed on page 56.

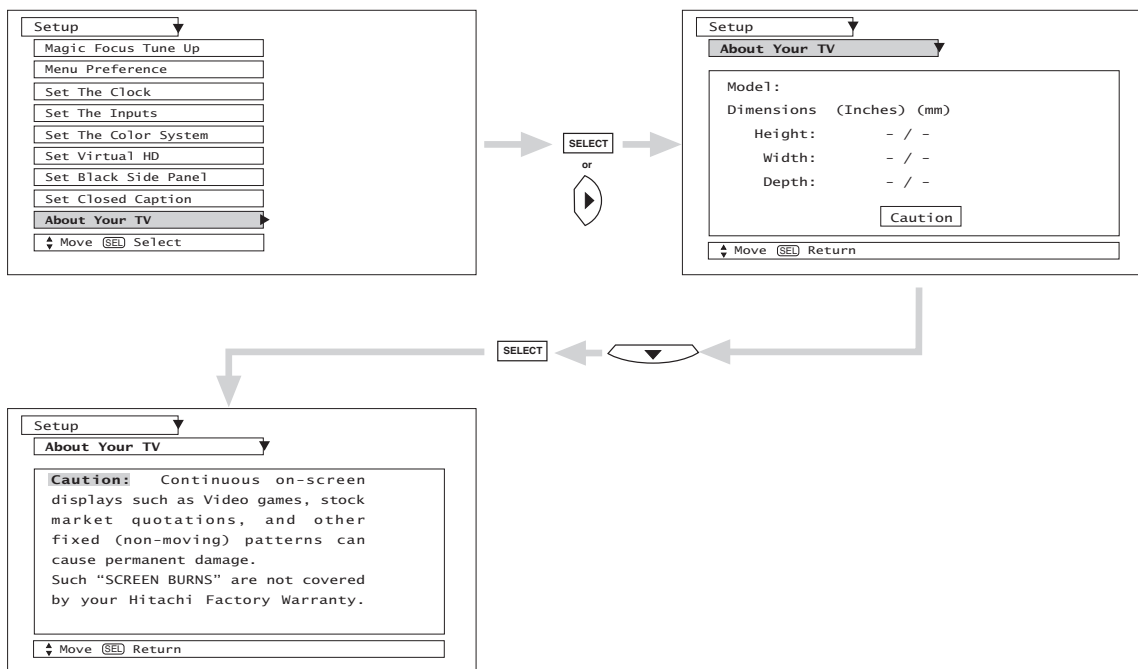

CARE OF YOUR ASPECT PROJECTION MONITOR AND YOUR REMOTE CONTROL



DO

Dust the screen and cabinet with a soft cloth.

Clean the screen with a soft cloth moistened in warm water and dry with a soft cloth. A mild soap may be used if the screen is extremely dirty.

Place your Projection Monitor away from extreme heat, humidity, and extremely dusty places.

Remove the plug from the wall outlet if your Projection Monitor will not be used for a long period of time, for instances, when you go on vacation.

DO NOT

Do not clean your screen or cabinet with strong cleaners, polishes or a chemically treated cloth.

Do not place rubber or vinyl products or cellophane tape on your Projection Monitor.

Do not touch the screen too often.

Do not subject the remote control to shocks such as dropping it on the floor, etc. Physical damage to the precision parts may result.





Avoid placing the remote control in a high humidity place or getting it wet. Do not leave it on or near a heater. Excessive heat or moisture may cause the unit to cease operation.

When the batteries run down, remote control operation will become erratic or possibly stop altogether. Replace the old batteries with two new "AA" size batteries. Do not use an old battery with a new battery.

Exposure of the viewing screen to prolonged direct sunlight or heat may cause the screen to permanently warp, resulting in a distorted picture.



Reception Problems

	<ul style="list-style-type: none">• IGNITION NOISE: Black spots or horizontal streaks may appear, picture may flutter or drift. Usually caused by interference from automobile ignition systems, neon lamps, electrical drills, and other electrical appliances.
	<ul style="list-style-type: none">• GHOSTS: Ghosts are caused by the television signal following two paths. One is the direct path and the other is reflected from tall buildings, hills or some other objects. Changing the direction or position of the antenna may improve reception. Ghosting may also be caused by defects in the antenna system such as unshielded leads or connecting several sets to the same antenna without using multiple antenna couplers.
	<ul style="list-style-type: none">• SNOW: If your receiver is located in the fringe area of a television station where the signal is weak, your picture may be marred by the appearance of small dots. When the signal is extremely weak, it may be necessary to install a special antenna to improve the picture.
	<ul style="list-style-type: none">• RADIO FREQUENCY INTERFERENCE: The interference produces moving ripples or diagonal streaks, and in some cases, causes loss of contrast in the picture.

NOTE: The Projection Monitor can generate sound distortion in external devices such as a radio. Please separate radio equipment from the Projection Monitor set to a considerable distance.



SYMPTOMS	CHECK THESE ITEMS AND TRY THESE ADJUSTMENTS								
	Be sure external connection is correct	Be sure power cord is plugged in	Be sure Projection Monitor is switched "ON"	Check for local interference	Adjust Contrast control	Adjust Brightness control	Adjust Color control	Adjust Tint control	Adjust Volume control
No Picture, no sound	●	●	●						
Sound OK, picture poor	●			●	●	●			
Picture OK, sound poor	●			●					●
Picture blurred	●			●					
Lines or streaks in picture				●					
Picture rolls vertically				●					
No color	●						●		
Poor color	●						●	●	

ASPECT Projection Monitor incorporates advanced power surge protection technology designed to protect against component or circuit damage due to external or internal voltage power surges.

IF YOUR PROJECTION MONITOR SHOULD APPEAR TO HAVE A LOSS OF POWER, PLEASE FOLLOW THIS PROCEDURE:

1. Press the power switch (ON/OFF switch) once.
2. If there is still no power, wait 30 seconds and press the power switch again.
3. If there is still no power, unplug the power cord from the wall. Wait 30 seconds and plug the power cord back in. Press the power switch again.

This protective technology should provide for years of lasting entertainment from your ASPECT Projection Monitor.



Features:

- Superfine Picture Quality
1280 Line Horizontal Resolution
- Remote (Controls many VCRs, DVD players, cable boxes, and satellite boxes.)
- New Easy-to-Use (3-Language) On-Screen Menu
- Full Set of Input Jacks, including S-VIDEO
- COMPONENT VIDEO: Y-P_B/P_R
- Velocity Modulation
- Six Aspect Modes
- Closed Caption Decoder
- Picture in Picture
- Magic Focus (Auto Digital Convergence and Manual Adjustment)
- Video Input Sensor
- 3 Dimensional Y/C Comb Filter
- Compatible with 1080i, 720p, 480p and 480i input signals.
- DVI-HDTV (High bandwidth Digital Content Protection V1.0 compatible).
- High Bandwidth Digital Content Protection V1.0 Compatible.
- **BBE** Technology.
*Licensed by BBE Sound, Inc. under USP5510752 and 5736897. BBE and BBE symbol are registered trademarks of BBE Sound, Inc. Manufactured under license from BBE Sound, Inc.
- **SRS** Technology.
*SRS and the  symbol are trademarks of SRS Labs, Inc. SRS technology is incorporated under license from SRS Labs, Inc.

Inputs:

- Power Input AC 120V, 60Hz
- Stand-by Power 1.3W
- Power Consumption
- Refer to rear panel at the back of the Projection Monitor
- Video 1.0Vp-p, 75 Ohm
- S-Video
Luminance (Y) 1.0Vp-p, 75 Ohm
Chrominance (C) 0.286Vp-p, 75 Ohm
- Component Video
Luminance (Y) 1.0Vp-p, 75 Ohm
Chrominance (P_B/P_R) 0.7Vp-p, 75 Ohm
- Audio input Impedence 47k Ohm
- Average input level 470mVrms
- DVI-HDTV DVI 25 pin

Outputs:

- Video 1.0Vp-p. 75 Ohm
- Audio (Fixed) 470mVrms, 1k Ohm

Dimensions:

	51M200	51M200A	65M200
• Height (in.) (mm)	50 1/4 1,275.0		59 7/8 1,520.7
• Width (in.) (mm)	48 3/4 1,239.0		61 1,549.0
• Depth (in.) (mm)	25 1/16 636.0		28 3/16 716
• Weight (lbs.) (kg.)	245 111.0		324 147.0

NOTE: Due to improvements, specifications in this operating guide are subject to change without notice.



ASPECT

*Service
hotline*

To locate an authorized
ASPECT service facility
in the continental U.S.A.
and Canada,

DIAL TOLL FREE

7 days a week, 24 hours a day

1-800-448-2244

ASPECT Brand Electronics

ASPECT has made every effort to assure you hours of trouble free operation from your unit. However, should you require service, a network of ASPECT Authorized Service Facilities has been established in all 50 states and Puerto Rico. Each facility will provide you with convenient and expedient assistance. Our service hotline operator will direct you to the ASPECT Authorized Service Facility nearest you. Just present proof of purchase and/or delivery receipts to the ASPECT Authorized Service Facility, and service will be rendered in accordance with the terms of the limited warranty as stated on your warranty card or operating guide.

Should you have any questions regarding warranty, service, operation, or technical assistance, please contact:

ASPECT Brand Electronics
2420 Fenton Street
Chula Vista, CA 91914



A

Accessories, 4
Aspect Ratio, 23
Audio (Sound Enhancement)
 SRS, 38
 BBE, 38
Audio Settings, 37 - 38
Auto Color, 36

B

Balance, 37
Bass, 37
Black Enhancement, 34
Black Side Panel, 51
Brightness, 34

C

Clock
 Time, 49
Closed Captions
 Captions, 52
Color Management, 35
Color Temperature, 34
Color, 34
Contrast, 34
Convergence (see Magic Focus)

I

Input Setup, 50

L

Language
 Menu Language, 48
Locks
 Change Access Code, 40
 Input Lock, 40
 Front Panel Lock, 40
 TV Time Lock, 40
 Movie Ratings, 41
 TV Ratings, 42
 TV Ratings
 (Canadian - English), 43
 TV Ratings
 (Canadian - French), 44
Loudness, 37

M

Magic Focus
 Auto Convergence, 7, 46
 Manual Convergence, 47
Menu Preference
 Language, 48
 Background, 49
Monitor Out, 9

P

Picture Mode, 33
Picture-in-Picture (PIP), 25 - 27
Picture-outside-Picture (POP), 25

R

Remote Control
 Functions, 20 - 31
 Programming Codes, 28 - 30
 Installing Batteries, 4

S

Sharpness, 34
Sound Enhancement, 38
Speakers, 37
 Connecting External Speakers, 5, 13

T

Time, 49
Tint, 34
Treble, 37

V

Vertical Position, 39
Video Settings, 33 - 36











ASPECT

Free Manuals Download Website

<http://myh66.com>

<http://usermanuals.us>

<http://www.somanuals.com>

<http://www.4manuals.cc>

<http://www.manual-lib.com>

<http://www.404manual.com>

<http://www.luxmanual.com>

<http://aubethermostatmanual.com>

Golf course search by state

<http://golfingnear.com>

Email search by domain

<http://emailbydomain.com>

Auto manuals search

<http://auto.somanuals.com>

TV manuals search

<http://tv.somanuals.com>