

INSTRUCTION MANUAL

HITACHI
Inspire the Next

42" Colour TV

L42VK04U

529/8439



Important - Please read these instructions fully before installing or operating and keep for future reference.

These instructions contain important information which will help you get the best from your television and ensure safe and correct installation and operation.

For any help concerning set up and use of your TV please call the Customer Helpline: 0845 604 0105

Lines open: 9am - 8pm Monday to Saturday and 10am - 4pm Sunday

HITACHI

Inspire the Next

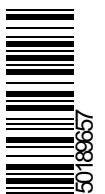

Contents

Features	2	Locking a Channel	18
Introduction	2	Managing Stations: Favourites	18
Intended Use	2	Button Functions	18
Preparation	2	Managing Stations: Sorting Channel List	18
Symbols in this manual	3	On-Screen Information	19
Safety Precautions	3	Media Playback Using Media Browser	19
Power Source	4	Viewing Videos via USB	19
Power Cord	4	Viewing Photos via USB	20
Information for Users		Media Browser Settings	20
in European Union Countries	5	Changing Image Size: Picture Formats	21
Connection to a Television Distribution		Configuring Picture Settings	22
System (Cable TV etc.) from Tuner	5	Operating Picture Settings Menu Items	22
Taking out of service and storing	6	Picture Settings Menu Items	22
Package Contents	6	PC Picture Settings Operation	22
Environmental Information	7	Configuring Sound Settings	23
Remote Control Buttons	8	Operating Sound Settings Menu Items	23
LCD TV and Operating Buttons	9	Sound Settings Menu Items	23
Viewing the Back side Connections	9	Configuring Your TV's Settings	23
Viewing the Connections - Side Connectors	10	Operating Settings Menu Items	23
Power Connection	10	Settings Menu Items	23
Aerial Connection	10	Using a Conditional Access Module	24
Using Digital Multimedia Connectors	11	Viewing Conditional Access Menu (*)	24
USB Memory Connection	11	Configuring Language Preferences	24
Connecting the LCD TV to a PC	11	Language Settings	25
Connecting to a DVD Player	12	Parental Control	25
Using Side AV Connectors	12	Parental Settings Menu Operation (*)	25
Using Other Connectors	12	Timers	26
Using the Cable Holder	12	Setting Sleep Timer	26
Remote Control Handset	13	Setting Programme Timers	26
Inserting Batteries	13	Configuring Date/Time Settings	26
Switching On/Off	13	Configuring Source Settings	27
To Switch the TV On	13	Configuring Other Settings	27
To Switch the TV Off	13	Operation	27
Digital Teletext (** for UK only)	13	Other Features	28
Analogue Teletext	13	Teletext	28
Input Selection	13	Tips	29
Operation with the Buttons on the TV	14	Appendix A: PC Input Typical Display Modes	30
Operation with the Remote Control	14	Appendix B: AV and HDMI Signal	
First Time Installation	14	Compatibility (Input Signal Types)	30
Viewing Electronic Programme Guide (EPG)	15	Appendix C: Supported DVI Resolutions	31
Auto Tuning	16	Appendix D: Supported	
Auto Channel Scan Menu Operation	16	File Formats for USB Mode	32
Manual Tuning	16	Appendix E: Software Upgrade	33
Digital Manual Search	17	Appendix E: Pin Specifications	34
Analogue Manual Search	17	SCART connector pin specifications	34
Analogue Fine Tune	17	HDMI connector pin specifications	34
Clear Service List (*)	17	Signal Input	34
Managing Stations: Channel List	17	Specifications	35
Operating the Channel List	17	Definitions of Important Terms	36
Moving a Channel	18	DVB-T functionality information	37
Deleting a Channel	18	Product Guarantee	38
Renaming a Channel	18		

Features

- Remote controlled colour LCD TV.
- Fully integrated Terrestrial digital TV (DVB-T - MPEG2).
- HDMI connectors for digital video and audio. This connection is also designed to accept high definition signals.
- USB input.
- 1000 programmes (analogue+digital).
- OSD menu system.
- Integrated tuner DVB-T, MPEG2 compatible.
- Scart socket for external devices (such as video, video games, audio set, etc.).
- Stereo sound system. (German+Nicam)
- Teletext, fasttext, TOP text.
- Headphone connection.
- Automatic programming system.
- Forward or backward manual tuning.
- Sleep timer / Child lock.
- Automatic sound mute when no transmission.
- NTSC playback.
- AVL (Automatic Volume Limiting).
- Auto power down.
- PLL (Frequency Search).
- PC input.
- Plug&Play for Windows 98, Windows 7, ME, 2000, XP, Vista.
- Game Mode

Introduction

Read the corresponding instructions of this handbook prior to the first usage of the device, even when the usage of electronic devices is familiar to you. Notice especially the chapter SAFETY PRECAUTIONS. Carefully keep the handbook as future reference. When selling the device or giving it away, absolutely give these direction for use.

Thank you for choosing this product. This Instruction Book will guide you for the proper operation of your TV. Before operating the TV, please read this Instruction Book thoroughly. Keep this Instruction Book in a safe place for future references.



Intended Use

This device is intended to receive and display TV programs. The different connection options make an additional expansion of the reception and display sources possible (various external devices). This device is only suitable for the operation in dry interiors. This appliance is intended solely for private domestic use and may not be used for industrial and commercial purposes. We exclude liability in principle, if the device is not used as intended, or unauthorized modifications have been made. To operate your LCD TV in extreme ambient conditions may cause the damage of the device.

Preparation

For ventilation, leave a free space of at least 10 cm all around the set. To prevent any fault and unsafe situations, please do not place any objects on top of the set. Use this device in moderate climates.

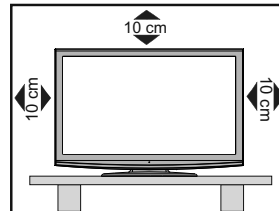

Symbols in this manual

The following symbols are used in the manual as a marker for restrictions and precautions and safety instructions. Please note such information for security reasons.

WARNING

If you do not pay attention to such a marked warning, it can cause serious injury or death or property damage. Please note these warnings strictly, in order to ensure a safe operation.

IMPORTANT

Warnings on the appliance and restrictions are displayed like this. Please read this information strictly in order to operate the system correctly and avoid damage.

NOTE

Information about the operation and additional explanations are marked like this. To be aware of such information is recommended to ensure that the functions can be used optimally.

Safety Precautions

Please read the following recommended safety precautions carefully for your safety.

SOME DOS AND DON'TS ON THE SAFE USE OF EQUIPMENT

This equipment has been designed and manufactured to meet international safety standards but, like any electrical equipment, care must be taken if you are to obtain the best results and safety is to be assured.

DO read the operating instructions before you attempt to use the equipment.

DO ensure that all electrical connections (including the mains plug, extension leads and inter-connections between the pieces of equipment) are properly made and in accordance with the manufacturer's instructions. Switch off and withdraw the mains plug before making or changing connections.

DO consult your dealer if you are ever in doubt about the installation, operation or safety of your equipment.

DO be careful with glass panels or doors on equipment.

DO route the mains lead so that it is not likely to be walked on, crushed, chafed, or subjected to excessive wear and tear or heat.

DON'T remove any fixed cover as this may expose dangerous voltages.

DON'T obstruct the ventilation openings of the equipment with items such as newspapers, tablecloths, curtains, etc. Overheating will cause damage and shorten the life of the equipment.

DON'T allow electrical equipment to be exposed to dripping or splashing, or objects filled with liquids, such as vases, to be placed on the equipment.

DON'T place hot objects or naked flame sources such as lighted candles or nightlights on, or close to equipment. High temperatures can melt plastic and lead to fires.

DON'T use makeshift stands and **NEVER** fix legs with wood screws - to ensure complete safety always fit the manufacturer's approved stand or legs with the fixings provided according to the instructions.

DON'T use equipment such as personal stereos or radios so that you are distracted from the requirements of traffic safety. It is illegal to watch television whilst driving.

DON'T listen to headphones at high volume, as such use can permanently damage your hearing.

DON'T leave equipment switched on when it is unattended unless it is specifically stated that it is designed for unattended operation or has a stand-by mode. Switch off using the switch on the equipment and make sure that your family know how to do this. Special arrangements may need to be made for infirm or handicapped people.

DON'T continue to operate the equipment if you are in any doubt about it working normally, or if it is damaged in any way - switch off, withdraw the mains plug and consult your dealer.

ABOVE ALL

--- NEVER let anyone especially children push anything into holes, slots or any other opening in the case - this could result in a fatal electrical shock;

--- NEVER guess or take chances with electrical equipment of any kind

--- it is better to be safe than sorry!



Power Source

The TV set should be operated only from a 220-240 V AC, 50 Hz outlet. Ensure that you select the correct voltage setting for your convenience.

Power Cord

Do not place the set, a piece of furniture, etc. on the power cord (mains lead) or pinch the cord. Handle the power cord by the plug. Do not unplug the appliance by pulling from the power cord and never touch the power cord with wet hands as this could cause a short circuit or electric shock. Never make a knot in the cord or tie it with other cords. The power cords should be placed in such a way that they are not likely to be stepped on. A damaged power cord can cause fire or give you an electric shock. When it is damaged and needs to be replaced, it should be done by qualified personnel.

This TV receiver is supplied with a moulded mains plug. The mains plug must not be cut off, as it may contain a special radio interference filter, the removal of which could lead to impaired performance. If you wish to extend the lead, obtain an appropriate safety approved extension lead or consult your dealer.

Observe the manufacturers instructions when connecting extension leads to the set. Check the fuse rating on the new plug; this should be fitted with a 5 Amp fuse which conforms to either ASTA or BSI (BS1362) approvals, these are easily identifiable by either the  or  symbols. If you are in any doubt about the installation of an extension lead, please consult a competent electrician.

Moisture and Water

Do not use this device in a humid and damp place (avoid the bathroom, the sink in the kitchen, and near the washing machine). Do not expose this device to rain or water, as this may be dangerous and do not place objects filled with liquids, such as flower vases, on top. Avoid from dripping or splashing.



If any solid object or liquid falls into the cabinet, unplug the TV and have it checked by qualified personnel before operating it any further.

Cleaning

Before cleaning, unplug the TV set from the wall outlet. Do not use liquid or aerosol cleaners. Use soft and dry cloth.



Ventilation

The slots and openings on the TV set are intended for ventilation and to ensure reliable operation. To prevent overheating, these openings must not be blocked or covered in anyway.

Heat and Flames

The set should not be placed near to open flames and sources of intense heat such as an electric heater. Ensure that no open flame sources, such as lighted candles, are placed on top of the TV. Batteries should not be exposed to excessive heat such as sunshine, fire or the like.



Lightning

Before a storm or lightning, or when going on holiday, disconnect the power and aerial lead from the wall sockets.

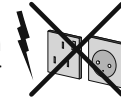

Replacement Parts

When replacement parts are required, make sure that the service technician has used replacement parts, which are specified by the manufacturer or have the same specifications as the original one. Unauthorized substitutions may result in fire, electrical shock or other hazards.

Servicing

Please refer all servicing to qualified personnel. Do not remove the cover yourself as this may result in an electric shock.



Waste Disposal

- Instructions for waste disposal:

Packaging and packaging aids are recyclable and should principally be recycled. Packaging materials, such as foil bag, must be kept away from children. Batteries, including those which are heavy metal-free, should not be disposed of with household waste. Please dispose of used batteries in an environmentally friendly manner. Find out about the legal regulations which apply in your area.

- Don't try to recharge batteries. Danger of explosion. Replace batteries only with the same or equivalent type.

Information for Users in European Union Countries

The above mark is in compliance with the Waste Electrical and Electronic Equipment Directive 2002/96/EC (WEEE). The mark indicates the requirement NOT to dispose of the equipment including any spent or discarded batteries as unsorted municipal waste, but use the return and collection systems available. If the batteries or accumulators included with this equipment display the chemical symbol Hg, Cd, or Pb, then it means that the battery has a heavy metal content of more than 0.0005% Mercury, or more than 0.002% Cadmium or more than, 0.004% Lead

Disconnecting the Device

The mains plug is used to disconnect TV set from the mains and therefore it must remain readily operable.

Headphone Volume

Excessive sound pressure from earphones and headphones can cause hearing loss.



Installation

To prevent injury, this device must be securely attached to the wall in accordance with the installation instructions when mounted to the wall (if the option is available).

LCD Screen

The LCD panel is a very high technology product with about a million thin film transistors, giving you fine picture details. Occasionally, a few non-active pixels may appear on the screen as a fixed blue, green or red point. Please note that this does not affect the performance of your product.

WARNING: Do not leave your TV in standby or operating mode when you leave your house.

Connection to a Television Distribution System (Cable TV etc.) from Tuner

Device connected to the protective earthing of the building installation through the mains connection or through other apparatus with a connection to protective earthing-and to a television distribution system using coaxial cable, may in some circumstances create a fire hazard.

Connection to a cable distribution system has therefore to be provided through a device providing electrical isolation below a certain frequency range (galvanic isolator, see EN 60728-11).

WARNING:

Do not leave your TV in standby or operating mode when you leave your house.

- The Standby / On button doesn't separate this device completely from mains. Moreover the device consumes power in the standby operation. In order to separate the device completely from mains, the mains plug has to be pulled from the mains socket. Because of that the device should be set up in a way, that an unobstructed access to mains socket is guaranteed, so that in case of emergency the mains plug can be pulled immediately. To exclude the danger of fire, the power cord should principally be separated from the mains socket prior to a longer period of non-usage, i.e. during vacations.

Electrical device not in the hands of children

WARNING: Never let children use electrical device unsupervised. Children can't always recognize properly the possible dangers. Batteries / accumulators can be life threatening when swallowed. Store batteries out of reach of small children. In case of swallowing a battery medical aid has to be sought immediately. Also keep the packaging foils away from children. There is danger of suffocation.

Safety Instructions for the Operation of the Appliance

If fixed images are displayed for a period of more than 2 hours continuously, it may result in the outline of the images that were displayed for too long to remaining visible on the screen, i.e. permanent 'afterimages' remain on the screen.

The same applies, if for a period of more than 2 hours

- an unchanged background
- logos, video games, computer pictures, Teletext
- a non screen filling format (e.g. a 4:3-format), is displayed.



NOTE: This appliance is not built for the long-term rendering or replay of static images, including

Logos, video games, computer pictures, Teletext and non screen filling formats.

Through rendering or replay of fixed images, Logos, video games, computer pictures, Teletext and non screen filling formats, the created permanent 'afterimages' cannot be undone. They do not represent an operating error and are not covered by the manufacturers warranty.

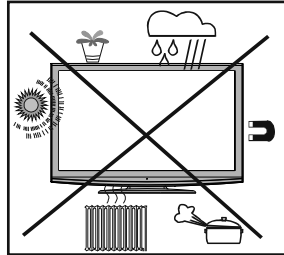



Taking out of service and storing

Unplug the TV from the mains and pack the TV in an appropriate cardboard box. Remove the batteries from the remote control and pack the remote control with the TV set.

 **NOTE:** The TV set should be stored in a dry and dust-free room.

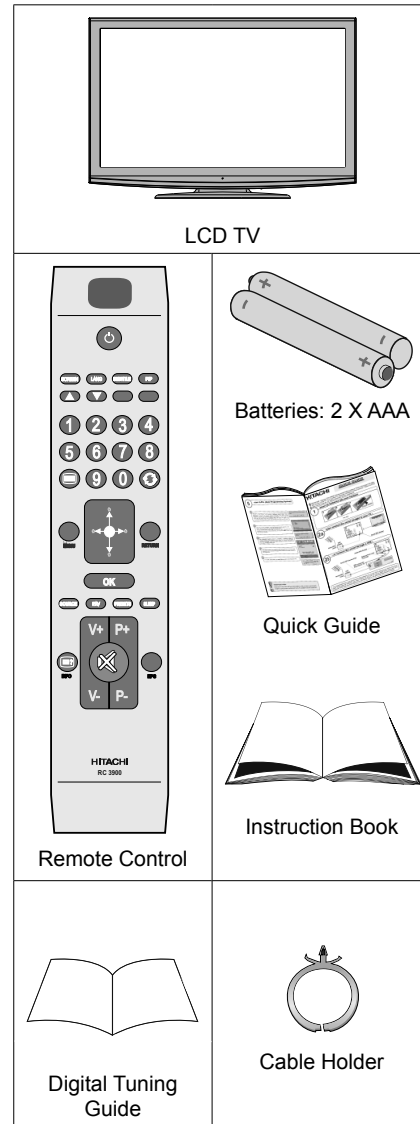
Package Contents



 **NOTE:** You should check the accessories after purchasing. Make sure that each accessory is included.



Environmental Information

- This television is designed to consume less energy to save environment. You not only help to save the environment but also you can save money by reducing electricity bills thanks to the energy efficiency feature of this TV. To reduce energy consumption, you should take the following steps:
- You can use Power Save Mode setting, located in the **Other Settings** menu. If you set Power Save Mode as On, the TV will switch to energy-saving mode and luminance level of TV set will be decreased to optimum level. Note that some picture settings will be unavailable to be changed when the TV is in Power Save Mode.

Power Save Mode

Off

- When the TV is not in use, please switch off or disconnect the TV from the mains wall socket. This will also reduce energy consumption.
- Disconnect power when going away for longer time.
- Please help us to save environment by following these steps.

Repair Information

Please refer all servicing to qualified personnel. Only qualified personnel must repair the TV. Please contact your local dealer, where you have purchased this TV for further information.





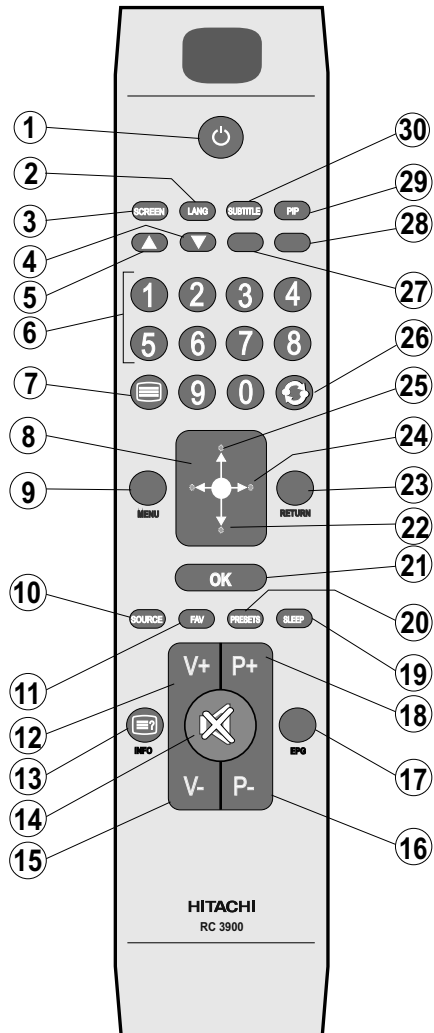

Remote Control Buttons

1. Standby
2. Mono/Stereo - Dual I-II / Current Language (*)
(in DVB channels)
3. Image size / Zooms videos (in Media Browser
video mode)
4. Green button/List Schedule(in EPG)/Tag/Untag
All(in favourite list)/Play-Slideshow(in Media
Browser)
5. Red button/Stop(in Media Browser)
6. Numeric buttons
7. Teletext / Mix(in TXT mode)
8. Cursor Left
9. Menu on-off
10. AV / Source selection
11. Favourite Mode Selection(in DVB channels)
12. Volume Up
13. Info / Reveal (in TXT mode)
14. Mute
15. Volume Down
16. Programme Down / Page up(in DVB channels)
17. Electronic programme guide(in DVB channels)
18. Programme Up / Page down(in DVB channels)
19. Sleep Timer
20. Picture mode selection. / Changes picture mode
(in Media Browser video mode)
21. Okay (Confirm) / Hold (in TXT mode)/ Edit
Channel List
22. Cursor Down
23. Exit / Return / Index page (in TXT mode)
24. Cursor Right / Subpage (in TXT mode)
25. Cursor Up
26. Previous programme
27. Yellow button/Pause (in Media Browser)/
Timeline Schedule(in EPG)
28. Blue button/Edit Channel List/Filter (In Favourite
List&EPG)/Loop-Shuffle (in Media Browser)
29. No function
30. Subtitle on-off (in DVB channels)

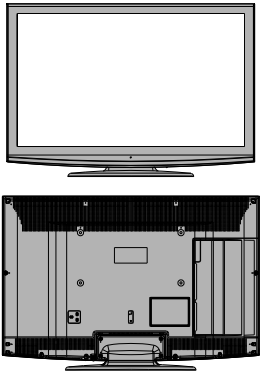

LCD TV and Operating Buttons

FRONT and REAR VIEW	Control buttons VIEW	Control Buttons
		<ol style="list-style-type: none"> 1. Standby/On button 2. TV/AV button 3. Programme Up/Down buttons 4. Volume Up/Down buttons <p>NOTE: Press “ ” and   buttons at the same time to view main menu.</p>

Viewing the Back side Connections

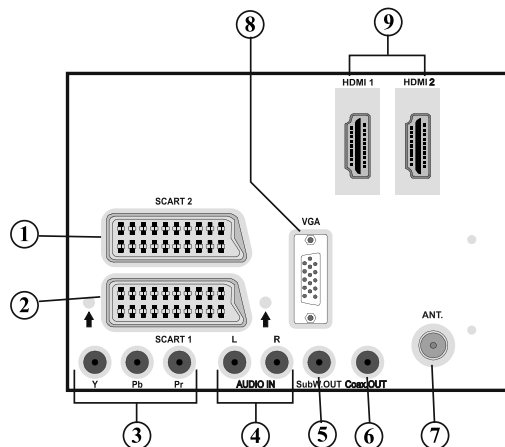

1. **SCART 2** inputs or outputs for external devices.
2. **SCART 1** input or output for external devices. Connect the SCART cable between SCART socket on TV and SCART socket on your external device (such as a decoder, a VCR or a DVD player).

NOTE: If an external device is connected via the SCART socket, the TV will automatically switch to AV mode.
3. **Component Video Inputs (YPbPr)** are used for connecting component video. You can connect the component video and audio sockets with a device that has component output. Connect the component video cables between the **COMPONENT VIDEO INPUTS** on the TV and the component video outputs of your device. While connecting, be sure that the letters on your TV, “**Y**”, “**Pb**”, “**Pr**” correspond with your device’s connectors.
4. **PC/YPbPr Audio Inputs** are used for connecting audio signals of a PC or a device that connects to the TV via YPbPr. Connect the PC audio cable between the **AUDIO INPUTS** on the TV and audio output of your PC to enable PC audio. Connect the audio cable between **AUDIO INPUTS** on the TV and audio outputs of your device to enable component audio.

5. **Subwoofer Out** is for connecting an external, active subwoofer to the set to give a much deeper bass effect. Use an appropriate RCA cable to connect the TV set to a subwoofer unit.
6. **S/PDIF Coaxial Out** outputs digital audio signals of the currently watched source. Use an **SPDIF coaxial cable** to transfer audio signals to a device that has S/PDIF input
7. **RF Input** connects to an aerial antenna system.
Note that if you use a decoder or a media recorder, you should connect the aerial cable through the device to the television with an appropriate antenna cable, as shown in the illustration in the following pages.
8. **PC Input** is for connecting a personal computer to the TV set.
Connect the PC cable between the **PC INPUT** on the TV and the PC output on your PC
9. **HDMI Inputs** are for connecting a device that has an **HDMI** socket. Your LCD TV is capable of displaying High Definition pictures from devices such as a High Definition Satellite Receiver or Blu-ray Player. These devices must be connected via the HDMI sockets or Component Socket. These sockets can accept either 720p or 1080p signals. No sound connection is needed for an HDMI to HDMI connection.

Viewing the Connections - Side Connectors

1. CI Slot is used for inserting a CI card. A CI card allows you to view all the channels that you subscribe to. For more information, see "Conditional Access" section.
2. Side USBs
3. Headphone jack is used for connecting an external headphone to the system. Connect to the HEADPHONE jack to listen to the TV from headphones (optional).
4. Video Input is used for connecting video signals of external devices. Connect the video cable between the VIDEO IN socket on the TV and the VIDEO OUT jack on your device.
5. Audio Inputs are used for connecting audio signals of external devices. Connect the audio cable between the AUDIO INPUTS on the TV and the AUDIO OUTPUT jacks on your device.

NOTE: If you connect a device to the TV via the VIDEO INPUT, you should also connect your device with an audio cable to the AUDIO INPUTS of the TV to enable audio.

6. The Power-switch is used for turning the TV "Off" or into "Standby-Mode"

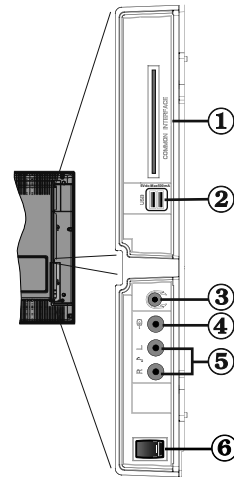

Power Connection

IMPORTANT: The TV set is designed to operate on 220-240V AC, 50 Hz.

- After unpacking, allow the TV set to reach the ambient room temperature before you connect the set to the mains. Plug the power cable to the mains socket outlet.

Aerial Connection

- Connect the aerial or cable TV plug to the AERIAL INPUT socket located at the rear of the TV.

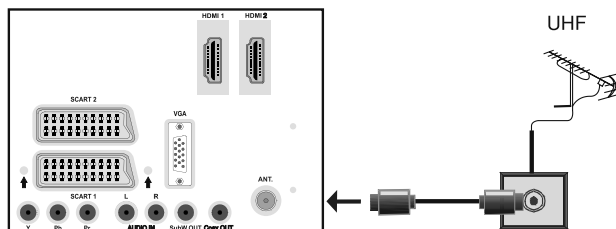

Using Digital Multimedia Connectors

- You can connect USB devices to your TV by using the USB inputs of the TV. This feature allows you to display/play JPG, MP3 and video files stored in a USB stick.
- It is possible that certain types of USB devices (e.g. MP3 Players) may not be compatible with this TV.
- You should back up your files before making any connections to the TV set in order to avoid any possible data loss. Note that manufacturer will not be responsible for any file damage or data loss.
- Do not pull out USB module while playing a file.

⚠ WARNING: Quickly plugging and unplugging USB devices, is a very hazardous operation. Especially, do not repeatedly quickly plug and unplug the drive. This may cause physical damage to the USB player and especially the USB device itself.

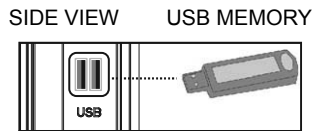

USB Memory Connection

⚠ IMPORTANT: The TV should be switched off while plugging or unplugging a USB device. Plug your USB device to the USB inputs of the TV. You can connect two usb device to your TV by using the USB inputs of the TV at the same time.

✎ NOTE: It is possible certain types of hard disk drives are not supported.

Connecting the LCD TV to a PC

For displaying your computer's screen image on your LCD TV, you can connect your computer to the TV set. Power off both computer and display before making any connections. Use 15-pin D-sub display cable to connect a PC to the LCD TV. When the connection is made, switch to PC source. See "Input selection" section. Set the resolution that suits your viewing requirements. Resolution information can be found in the appendix parts.

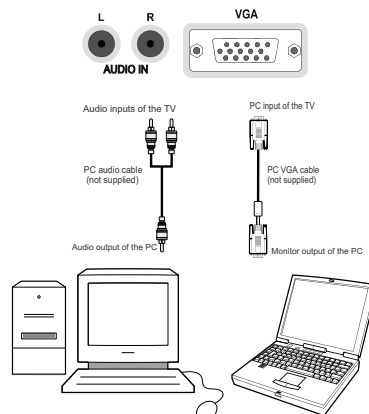

✎ NOTE: If you connect a PC to the TV using HDMI connection, radio interference may occur. Therefore this type of connection is not recommended. You should use VGA connection instead.

Connecting to a DVD Player

If you want to connect a DVD player to your LCD TV, you can use connectors of the TV set. DVD players may have different connectors. Please refer to your DVD player's instruction book for additional information. Power off both the TV and the device before making any connections.

 **NOTE:** Cables shown in the illustration are not supplied.

- If your DVD player has an HDMI socket, you can connect via HDMI. When you connect to DVD player as illustrated below, switch to HDMI source. See, "Input Selection" section.
- Some DVD players are connected through COMPONENT SOCKETS. Use a component video cable to connect video input. For enabling audio, use a component audio cable as illustrated below. When the connection is made, switch to YPbPr source. See, "Input selection" section.
- You may also connect through the SCART 1 or SCART 2. Use a SCART cable as shown below.

 **NOTE:** These three methods of connection perform the same function but in different levels of quality. It is not necessary to connect by all three methods.

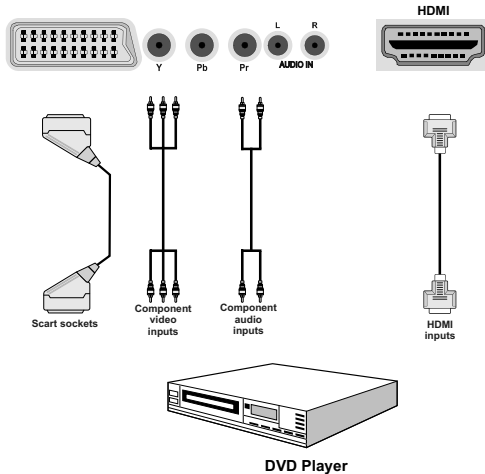

Using Side AV Connectors

You can connect a range of optional equipment to your LCD TV.

- For connecting a camcorder, connect to the VIDEO IN socket and the AUDIO SOCKETS. For selecting the related source, see the section "Input selection" in the following parts.
- To listen the TV sound from headphones, connect to the HEADPHONE jack of the TV.

Using Other Connectors

You can connect a range of optional equipment to your LCD TV. Possible connections are shown below. Note that cables shown in the illustration are not supplied.

- For connecting a device that has SPDIF support, use an appropriate SPDIF cable to enable sound connection.

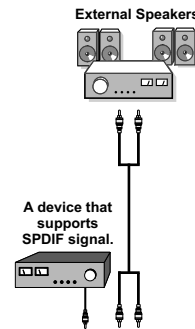

Using the Cable Holder

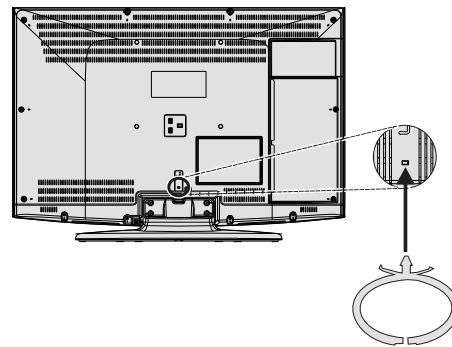

You can use the supplied cable holder as the following:

- Place the cable holder into the cable holder hole located on the rear side of the TV as illustrated above.
- Place cables into the cable holder after all necessary connections are made.

Remote Control Handset

Inserting Batteries

- Remove the battery cover located on the back of the handset by gently pulling backwards from the indicated part.
- Insert two **AAA/R3** or equivalent type batteries inside. Observe the correct polarity (+/-) when inserting batteries and replace the battery cover.

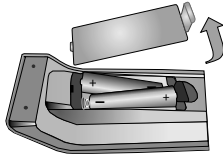

NOTE: Remove the battery from remote control handset when it is not to be used for a long period. Otherwise it can be damaged due to any leakage of batteries. Remote range is approximately 7m/23ft.

Switching On/Off

To Switch the TV On

- Connect the power cord to the 220-240V AC, 50 Hz outlet.
- Switch the “” button to position “” so the TV will switch to standby mode. Then the standby LED lights up.
- To switch on the TV from standby mode either:
 - Press the “” button, P+ / P- or a numeric button on the remote control.
 - Press the “”, - or + button of the TV.

The TV will then switch on.

NOTE: If you switch on your TV via P +/- buttons on the remote control or +/- on the TV set, the programme that you were watching last will be reselected.

By either method the TV will switch on.

To Switch the TV Off

- Switch the “” button to position 2 as illustrated, so the TV will switch OFF.
- To power down the TV completely, unplug the power cord from the mains socket.

NOTE: When the TV is switched to standby mode, standby LED can blink to indicate that features such as Standby Search, Over Air Download or Timer is active.

Digital Teletext (** for UK only)

- Press the “” button.
- The digital teletext information appears.
- Operate it with the coloured buttons, cursor buttons and **OK** button.

The operation method may differ depending on the contents of the digital teletext.

Follow the instructions displayed on digital teletext screen.

- When Press “**SELECT**” button or similar message appears on the screen, press the OK button.
- When the “” button is pressed, the TV returns to television broadcasting.
- With digital terrestrial broadcasting (DVB-T), in addition to digital teletext broadcasting together with the normal broadcasting, there are also channels with just digital teletext broadcasting.
- The aspect ratio (picture shape) when watching a channel with just digital teletext broadcasting is the same as the aspect ratio of the picture viewed previously.
- When you press the “” button again, the digital teletext screen will be displayed.

Analogue Teletext

Please do refer to the “TELETEXT” explanation on page 29.

Input Selection

Once you have connected external systems to your TV, you can switch to different input sources. Press “**SOURCE**” button on your remote control consecutively for directly changing sources.

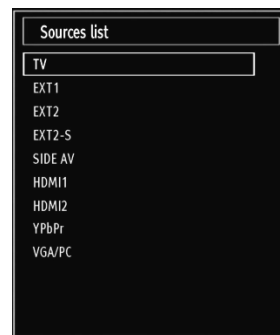

You can operate your TV using both the remote control and onset buttons.

Operation with the Buttons on the TV

Volume Setting

- Press “**-**” button to decrease volume or “**+**” button to increase volume, so a volume level scale (slider) will be displayed on the screen.

Programme Selection

- Press “**P/CH +**” button to select the next programme or “**P/CH -**” button to select the previous programme.

Viewing Main Menu

- Press the “**V+**”/“**V-**” button at the same time to view main menu. In the Main menu select sub-menu using “**AV**” button and set the sub-menu using “**-**”/“**+**” buttons. To learn the usage of the menus, refer to the menu system sections.

AV Mode

- Press the “**AV**” button in the control panel on the TV to switch between AV modes.

Operation with the Remote Control

- The remote control of your TV is designed to control all the functions of the model you selected. The functions will be described in accordance with the menu system of your TV.

Volume Setting

- Press “**V+**” button to increase the volume. Press “**V-**” button to decrease the volume. A volume level scale (slider) will be displayed on the screen.

Programme Selection (Previous or Next Programme)

- Press “**P-**” button to select the previous programme.
- Press “**P+**” button to select the next programme.

Programme Selection (Direct Access)

- Press numeric buttons on the remote control to select programmes between 0 and 9. The TV will switch to the selected programme. To select programmes, press the numeric buttons consecutively. When the pressing time is due for the second numeric button, only the first digit programme will be displayed. Press directly the programme number to reselect single digit programmes.

First Time Installation

IMPORTANT: Ensure that the aerial is connected and a Common Interface module is not inserted before switching on the TV for the first time installation.

- When the TV is operated for the first time, installation wizard will guide you through the process. First, language selection screen will be displayed:

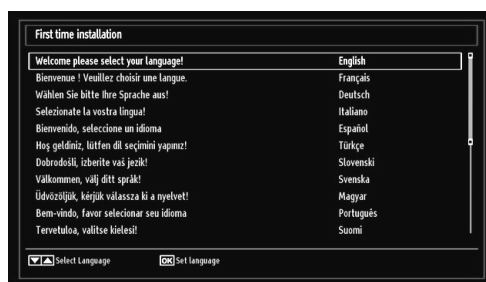

- Use “**▼**” or “**▲**” buttons to select your language and press **OK** button to set selected language and continue.
- After selecting the language, “**Welcome!**” screen will be displayed, requiring you to set **Country**, **Teletext Language** and **Scan Encrypted** options.



- By pressing “**◀**” or “**▶**” button, select the **country** you want to set and press “**▼**” button to highlight **Teletext Language** option. Use “**◀**” or “**▶**” button to select desired Teletext Language.
- Press “**▼**” button after setting Teletext Language option. **Scan Encrypted** will be then highlighted. You can set **Scan Encrypted** as **Yes** if you want to scan coded stations. Afterwards select the desired Teletext Language.
- Press **OK** button on the remote control to continue and the following message will be displayed on the screen:

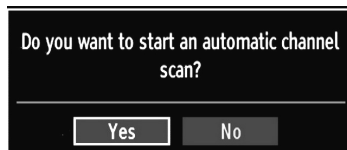

To select the "Yes" or "No" option, highlight the item by using "◀" or "▶" buttons and press **OK** button.

Afterwards, the following OSD will be displayed on the screen and the television will search for digital and analogue TV broadcasts.

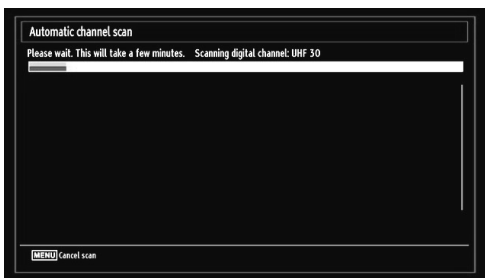

NOTE: You can press "MENU" button to cancel.

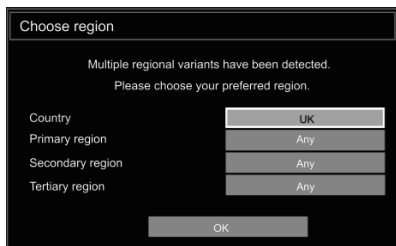

End of the search process, **Choose Region** menu screen will be displayed (if any multiple region variants are detected). Please select country and region choice then press **OK** to continue.

- After all the available stations are stored, Channel List will be displayed on the screen. If you like the sort channels, according to the LCN(Logical Channel Number), please select "Yes" and then press **OK**.



- Press **OK** button to quit channel list and watch TV.

Viewing Electronic Programme Guide (EPG)

You can view the electronic programme guide (EPG) to view information about available programmes. To view the **EPG** menu please press **EPG** button on the remote control.

- Press "▼"/"▲" buttons to navigate through channels.
- Press "◀"/"▶" buttons to navigate through the programme list.
- **EPG** menu displays available information on all channels.
- Please note that event information is updated automatically. If there are no event information data available for channels, **EPG** will be displayed with blanks.

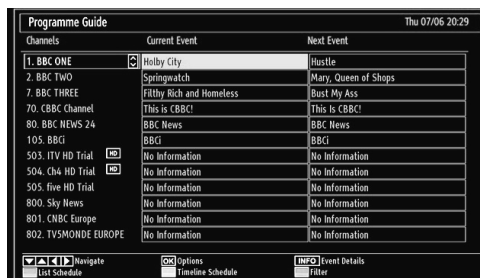

OK (Options): Displays programme options including "Select Channel" option.

INFO (Event Details): Displays the programmes in detail.

Green button: Programme schedule will be listed

Yellow button: Display EPG data in accordance with timeline schedule

Blue button (Filter): Views filtering options.

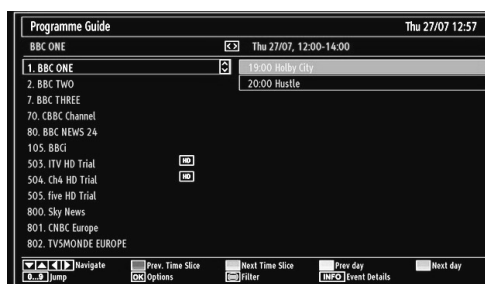

Red button (Prev Time Slice): Displays the programmes of previous time slice.

Green button (Next Time Slice): Displays the programmes of the next time slice.

Yellow button (Prev Day): Displays the programmes of previous day.

Blue button (Next day): Displays the programmes of the next day.

Numeric buttons (Jump): Jumps to the preferred channel directly via numeric buttons.

OK (Options): Displays programme options including **"Select Channel"** option.

Text button (Filter): Views filtering options.

INFO (Details): Displays the programmes in detail.



Red button (Prev Day): Displays the programmes of previous day.

Green button (Next day): Displays the programmes of the next day.

Yellow button (Zoom): Expands programme information.

Blue button (Filter): Views filtering options.

INFO (Details): Displays the programmes in detail.

Numeric buttons (Jump): Jumps to the preferred channel directly via numeric buttons.

OK (Options): Displays programme options including **"Select Channel"** option.

Text (Search): Displays **"Guide Search"** menu.

SUBTTL: Press **SUBTTL** button to view Select Genre menu. Using this feature, you can search the programme guide database in accordance with the genre. Info available in the programme guide will be searched and results matching your criteria will be listed.

(Now) : Shows the current programme.

Auto Tuning

HINT: Auto tuning feature will help you to retune the TV set in order to store new services or stations.

Press **"MENU"** button on the remote control and select **Installation** by using **"◀"** or **"▶"** button. Press **OK** button and the following menu screen will be displayed.

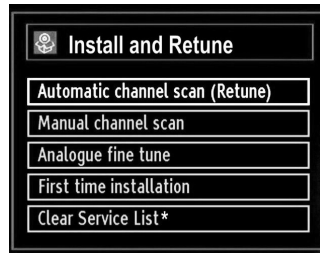

Select **Automatic Channel Scan** by using **"▼"/"▲"** button and press **OK** button. **Automatic Channel Scan** options will be displayed. You can select **Digital Aerial, Analogue or Digital Aerial-Analogue** tuning using **"▼"/"▲"** and **OK** buttons.

Auto Channel Scan Menu Operation

Digital: Searches and stores aerial DVB stations.

Analogue: Searches and stores analogue stations.

Full: Searches and stores both analogue and aerial DVB stations.

- Whenever you select an automatic search type and press **OK** button, a confirmation screen will appear on the screen. To start installation process, select **Yes**, to cancel select **No** by using **"◀"** or **"▶"** and **OK** button.
- After auto channel scan type is set and selected and confirmed, installation process will start and progress bar will move along. Press **"MENU"** button to cancel process. In such a case, located channels are not stored.

Manual Tuning

HINT: This feature can be used for direct broadcast entry.

- Select **Manual Channel Scan** from the Installation menu by using **"▼"/"▲"** and **OK** buttons. Manual Scan options screen will be displayed.
- Select the desired **Search Type** using **"◀"** or **"▶"** button. Manual search options will change accordingly. Use **"▼"/"▲"** button to highlight an item and then press **"◀"** or **"▶"** button to set an option. You can press **"MENU"** button to cancel.

Digital Manual Search

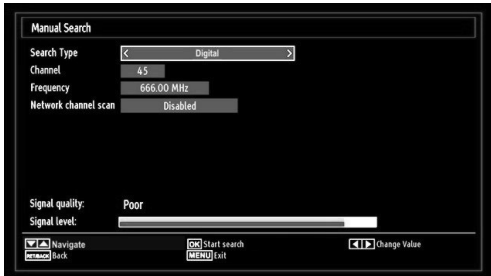

In manual channel scan, the number of the multiplex or frequency are entered manually and only that multiplex or frequency are searched for the channels. After selecting search type as **Digital**, you can enter the multiplex or frequency number using the numeric buttons and press **OK** button to search.

Analogue Manual Search

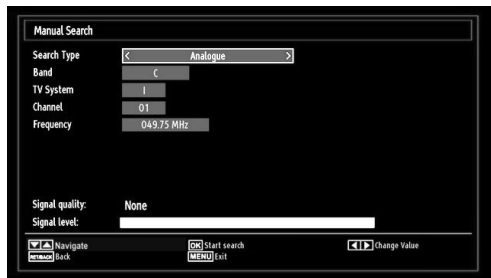

After selecting search type as analogue, you can use “▼”/“▲” button to highlight an item and then press “◀” or “▶” button to set an option.

Enter the channel number or frequency using the numeric buttons. You can then press **OK** button to search. When the channel is located, any new channels that are not on the list will be stored.

Analogue Fine Tune

- Select **Analogue Fine Tune** from the Installation menu by using “◀” or “▶” and **OK** buttons. Analogue fine tune screen will be displayed. Analogue Fine Tune feature will not be available if there are no analogue channels, digital channels and external sources stored.
- Press **OK** button to proceed. Use “◀” or “▶” button to set Fine Tune. When finished, press **OK** button again.

Clear Service List (*)

(*) This setting is visible only when the Country option is set to Denmark, Sweden, Norway or Finland.

Use this setting to clear channels stored. Press “▼” or “▲” button to select Clear Service List and then press **OK**. The following OSD message will be displayed on the screen:

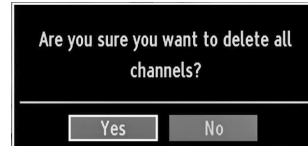

Press **OK** to cancel. Select Yes by pressing “◀” or “▶” button and press **OK** to delete all of the channels.

Managing Stations: Channel List

The TV sorts all stored stations in the Channel List. You can edit this channel list, set favourites or set active stations to be listed by using the Channel List options.

- Press “**MENU**” button to view main menu. Select Channel List item by using “◀” or “▶” button. Press **OK** to view menu contents.



Select **Edit Channel List** to manage all stored channels. Use “◀” or “▶” and **OK** buttons to select Edit Channel List.

Operating the Channel List



- Press “▼” or “▲” button to select the channel that will be processed. Press “◀” or “▶” button to select a function on Channel List menu.
- Use **P+/P-** buttons to move page up or down.
- Press **BLUE** button to view filtering options.
- Press “**MENU**” button to exit.

Moving a Channel

- First select the desired channel. Select Move option in the channel list and press **OK** button.
- Edit Number screen will be displayed. Enter the desired channel number by using the numeric buttons on the remote control. If there is a previously stored channel on that number, a warning screen will be displayed. Select Yes if you want to move the channel and press **OK**.
- Press **OK** button to process. Selected channel is now moved.

Deleting a Channel

You can press **GREEN** button to tag/untag all channels; **YELLOW** button to tag/untag channel.

- Select the channel that you want to delete and select **Delete** option. Press **OK** button to continue.
- A warning screen will appear. Select **YES** to delete, select **No** to cancel. Press **OK** button to continue.

Renaming a Channel

- Select the channel that you want to rename and select **Edit Name** option. Press **OK** button to continue.
- Pressing “◀” or “▶” button moves to the previous/next character. Pressing “▼” or “▲” button toggles the current character, i.e., ‘b’ character becomes ‘a’ by “▼” and ‘c’ by “▲”. Pressing the numeric buttons ‘0...9’ replaces the highlighted character with the characters printed above the button one by one as the button is pressed.
- When finished, press **OK** button to save. Press “MENU” to cancel.

Locking a Channel

You can press **GREEN** button to tag/untag all channels; **YELLOW** button to tag/untag a single channel.

- Select the channel that you want to lock and select **Lock** option. Press **OK** button to continue.
- You will be asked to enter parental control PIN. Default PIN is set as **0000**. Enter the PIN number.



- Press **OK** button when the desired channel is highlighted to lock/unlock the channel. Lock symbol will be displayed next to the selected channel.

Managing Stations: Favourites

You can create a list of favourite programmes.

- Press “MENU” button to view main menu. Select Channel List item by using “◀” or “▶” button. Press **OK** to view menu contents.
- Select **Favourites** to manage favourite list. Use “▼” / “▲” and **OK** buttons to select **Favourites**.
- You can set various channels as favourites so that only the favourite channels are navigated.

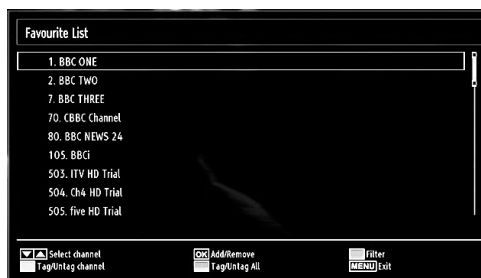

- Select a channel by using “▼” or “▲” button. Press **OK** button to add selected channel to favourites list. Press **OK** button again to remove.

Button Functions

- **OK**: Add/remove a station.
- **YELLOW**: Tag/untag a channel.
- **GREEN**: Tag/untag all channels.
- **BLUE**: Displays filtering options.

Managing Stations: Sorting Channel List

You can select broadcasts to be listed in the channel list. To display specific types of broadcast, you should use Active channel list setting.

Select Active channel list from the Channel list menu by using “▼” / “▲” button. Press **OK** button to continue.



You can select a broadcast type option from the list by using “▼” / “▲” and **OK** buttons.

On-Screen Information

You can press **"INFO"** button to display on-screen information. Details of the station and current programme will be displayed on the information banner.

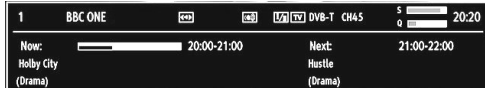

The information banner gives information on the channel selected and the programmes on it. The name of the channel is displayed, along with its channel list number.

Hint: Not all channels broadcast the programme data. If the name and time of the programme are not available, then information banner will be displayed with blanks.

If the selected channel is locked, you must enter the correct four-digit numeric code to view the channel (default code is **0000**). **"Enter PIN"** will be displayed on the screen in such a case:

Media Playback Using Media Browser

If the USB stick is not recognized after power off/on or First Time Installation, first, plug the USB device out and power off/on the TV set. Plug the USB device in again.

To display Media Browser window, press either **"MENU"** button on the remote control and then select Media Browser by pressing **"◀"** or **"▶"** button. Press **OK** button to continue. Media Browser menu options will be displayed.

Also, when you plug USB devices, media browser screen will be displayed automatically:

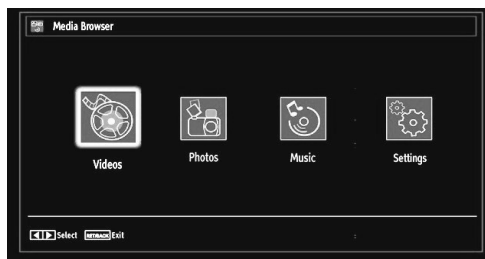

You can play music, picture and video files from the connected USB memory stick. Use **"◀"** or **"▶"** button to select Videos, Photos, Music or Settings.

You can connect two USB devices to your TV. If both USB devices include music, picture or video files, USB selection osd will be displayed on the screen. The first USB device connected to the TV will be named as USB Drive1.

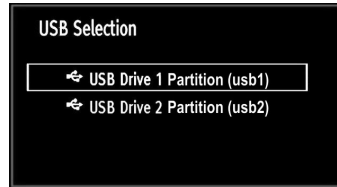

Select a device by using **"▼"** or **"▲"** button and press **OK**.

Viewing Videos via USB

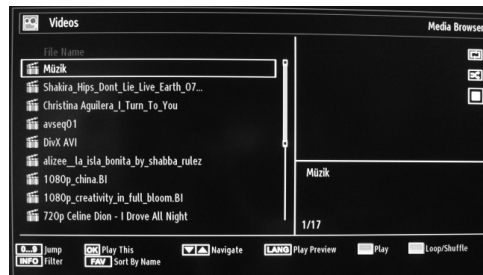

When you select Videos from the main options, available video files will be filtered and listed on this screen. You can use **"▼"** or **"▲"** button to select a video file and press **OK** button to play a video. If you select a subtitle file and press **OK** button, you can select or deselect that subtitle file. The following menu will be displayed while playing a video file:

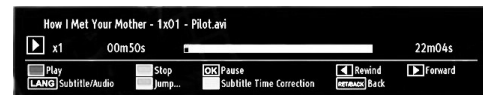

- Play (RED button):** Starts the video playback.
- Stop (BLUE button):** Stops the video playback.
- Pause (OK button):** Pause the video playback.
- Rewind (◀◀ button):** Goes backward.
- Forward (▶▶ button):** Goes forward.
- Subtitle/Audio (LANG. button):** Sets subtitle/Audio.
- Jump (GREEN button):** Jumps to time. Use numeric buttons to type the desired time and press GREEN button again to proceed.
- Yellow:** Opens subtitle time correction menu



Press **RETURN** button to switch back to previous menu.

Viewing Photos via USB

When you select Photos from the main options, available image files will be filtered and listed on this screen.

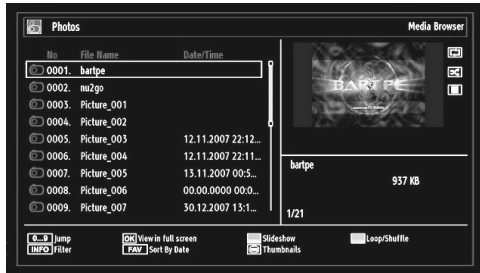

0...9 (Jump) (Numeric buttons): Jump to selected file using the numeric buttons.

OK: Views the selected picture in full screen.

▼ / ▲: Navigate.

Slideshow (GREEN button): Starts the slideshow using all images.

TXT button: Views images in thumbnails.

FAV button: Sorts files by date.

OK button: Toggles viewing style.

BLUE button: Loop/shuffle.

Slideshow Options



Pause (YELLOW button): Pauses the slideshow.

Continue (GREEN button): Continues the slideshow.

Loop/Shuffle (BLUE button): Press once to disable Loop. Press again to disable both Loop and Shuffle. Press once more to enable only Shuffle. Press again to enable all. You can follow the disabled functions with the change of the icons.

Previous/Next (Left/Right buttons): Jumps to previous or next file on slideshow.

Rotate (Up/Down buttons): Rotates the image using up/down buttons.

RET/BACK: Back to file list.

INFO: Displays help screen.

Playing Music Files via USB

When you select Music from the main options, available audio files will be filtered and listed on this screen.



▼ / ▲: Navigate.

Play (GREEN button): Plays all media files starting with the selected one.

Stop (RED button): Stops playback.

Pause (YELLOW button): Pauses the selected playback.

Sort (FAV button): Sorts files by Title, Artist or Album.

Loop/Shuffle (BLUE button): Press once to disable Loop. Press again to disable both Loop and Shuffle. Press once more to enable only Shuffle. Press again to enable all. You can follow the disabled functions with the change of the icons.

0..9 (Numeric buttons): The TV will jump to the file starting with the letter you input via the numeric buttons on your remote control.

Play This (OK button): Plays the selected file.

Previous/Next (Left/Right buttons): Jumps to previous or next file to play.

INFO: Changes filter options.

Media Browser Settings

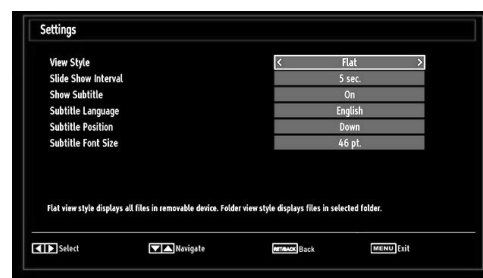

You can set your Media Browser preferences by using the Settings dialog. Press “▼” or “▲” button to highlight an item and use “◀” or “▶” button to set.

View Style: Sets default browsing mode.

Slide Show Interval: Sets slide show interval time.

Show Subtitle: Sets subtitle enabling preference.

Subtitle Position: Sets subtitle position as up or down.

Subtitle Font Size: Sets subtitle font size (max. 54pt).

Changing Image Size: Picture Formats

- Programmes can be watched in different picture formats, depending on the transmission received.
- You can change the aspect ratio (image size) of the TV for viewing the picture in different zoom modes.
- Press “**SCREEN**” button repeatedly to change the image size. Available zoom modes are listed below.

Auto

When a **WSS (Wide Screen Signalling)** signal, which shows the aspect ratio of the picture, is included in the broadcast signal or the signal from an external device, the TV automatically changes the **ZOOM** mode according to the **WSS** signal.

- When the **AUTO** mode does not function correctly due to poor **WSS** signal quality or when you want to change the **ZOOM** mode, change to another **ZOOM** mode manually.

16:9

This uniformly stretches the left and right sides of a normal picture (4:3 aspect ratio) to fill the wide TV screen.

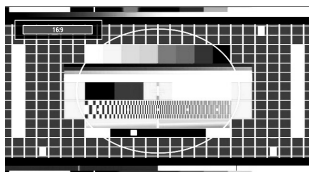

- For 16:9 aspect ratio pictures that have been squeezed into a normal picture (4:3 aspect ratio), use the **16:9** mode to restore the picture to its original shape.

Subtitle

This zooms up the wide picture (16:9 aspect ratio) with subtitles to the full screen.

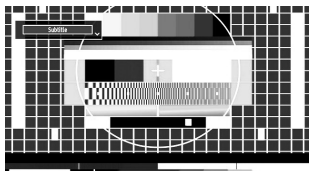

NOTE: You can shift to screen up or down by pressing “▼” / “▲” buttons while picture zoom is selected as panoramic, 14:9 Zoom, Cinema or Subtitle.

14:9

This zooms up the wide picture (14:9 aspect ratio) to the upper and lower limits of the screen.

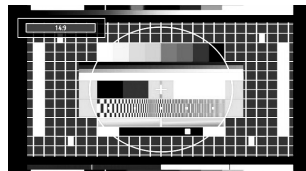

14:9 Zoom

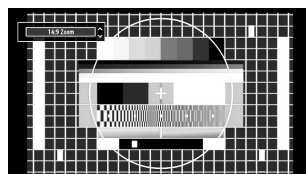

This option zooms to the 14:9 picture.

4:3

Use to view a normal picture (4:3 aspect ratio) as this is its original size.

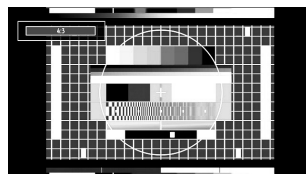

Panoramic

This stretches the left and right sides of a normal picture (4:3 aspect ratio) to fill the screen, without making the picture appear unnatural.

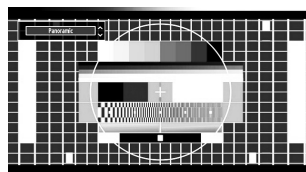

The top and bottom of the picture are slightly cut off.

Cinema

This zooms up the wide picture (16:9 aspect ratio) to the full screen.

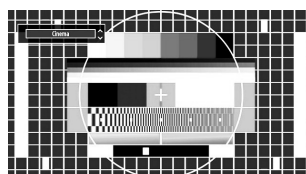

Configuring Picture Settings

You can use different picture settings in detail.

Press "MENU" button and select the Picture icon by using "◀" or "▶" button. Press OK button to view Picture Settings menu.

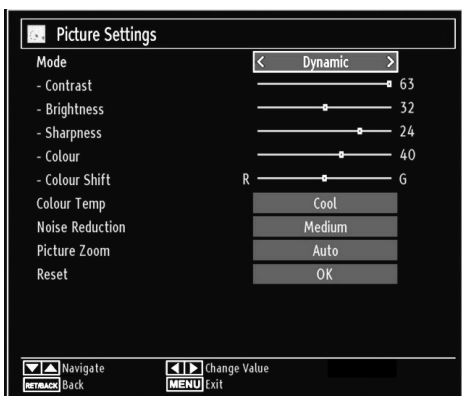

Operating Picture Settings Menu Items

- Press "▼" or "▲" button to highlight a menu item.
- Use "◀" or "▶" button to set an item.
- Press "MENU" button to exit.

Picture Settings Menu Items

Mode: For your viewing requirements, you can set the related mode option. Picture mode can be set to one of these options: **Cinema, Game, Dynamic** and **Natural**.

Contrast: Sets the lightness and darkness values of the screen.

Brightness: Sets the brightness value for the screen.

Sharpness: Sets the sharpness value for the objects displayed on the screen.

Colour: Sets the colour value, adjusting the colors.

Colour Shift: Adjust the desired colour tone.

Colour Temp: Sets the desired colour tone.

Setting **Cool** option gives white colours a slight blue stress.

For normal colours, select **Normal** option.

Setting **Warm** option gives white colours a slight red stress.

Noise Reduction: If the broadcast signal is weak and the picture is noisy, use **Noise Reduction** setting to reduce the noise amount. Noise Reduction can be set to one of these options: **Low, Medium, High** or **Off**.

Game Mode: When Game Mode is set to On, specific game mode settings, which are optimized for better video quality, will be loaded.

NOTE: When Game Mode is on, some items in the Picture Settings menu will be unavailable to be set.

Picture Zoom: Sets the picture size to Auto, 16:9, Subtitle, 14:9, 14:9 Zoom, 4:3, Panoramic or Cinema.

Reset: Resets the picture settings to factory default settings.

While in VGA (PC) mode, some items in Picture menu will be unavailable. Instead, VGA mode settings will be added to the Picture Settings while in PC mode.

PC Picture Settings Operation

For adjusting PC picture items, do the following:

Press "◀" or "▶" button to select Picture icon. Picture menu appears on the screen.

Contrast, Brightness, Colour, Colour Temp and Picture Zoom, Reset settings in this menu are identical to settings defined in TV picture settings menu. **Sound, Settings and Source** settings are identical to the settings explained in the main menu system.

PC Position: Select this to display PC position menu items.

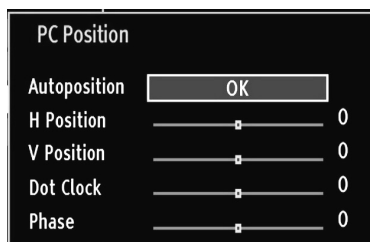

Autoposition: Automatically optimizes the display. Press **OK** to optimize.

H Position: This item shifts the image horizontally to right hand side or left hand side of the screen.

V Position: This item shifts the image vertically towards the top or bottom of the screen.

Dot Clock: Dot Clock adjustments correct the interference that appear as vertical banding in dot intensive presentations like spreadsheets or paragraphs or text in smaller fonts.

Phase: Depending on the resolution and scan frequency that you input to the TV set, you may see a hazy or noisy picture on the screen. In such a case you can use this item to get a clear picture by trial and error method.

Configuring Sound Settings

Sound settings can be configured according to your personal preferences.

Press “MENU” button and select the first icon by using “◀” or “▶” button. Press OK button to view Sound Settings menu.

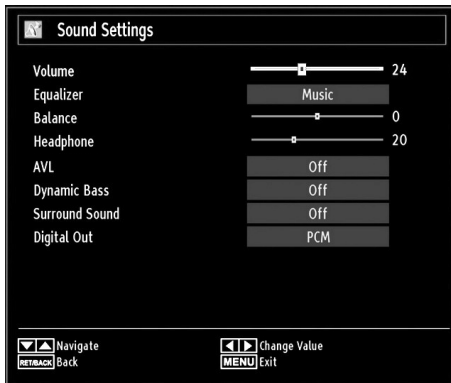

Operating Sound Settings Menu Items

- Press “▼” or “▲” button to highlight a menu item.
- Use “◀” or “▶” button to set an item.
- Press “MENU” button to exit.

Sound Settings Menu Items

Volume: Adjusts volume level.

Equalizer: Press OK button to view equalizer sub-menu.

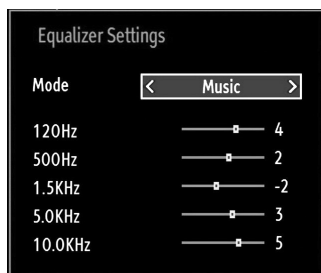

In equalizer menu, the preset can be changed to **Music, Movie, Speech, Flat, Classic** and **User**. Press the “MENU” button to return to the previous menu.

NOTE: Equalizer menu settings can be changed manually only when the **Equalizer Mode** is in **User**.

Balance: This setting is used for emphasizing left or right speaker balance.

Headphone: Sets headphone volume.

AVL: Automatic Volume Limiting (AVL) function sets the sound to obtain fixed output level between programmes (For instance, volume level of advertisements tend to be louder than programmes).

Dynamic Bass: Dynamic Bass is used to increase bass effect of the TV set.

Surround Mode: Surround mode can be changed as On or Off.

Digital Out: Sets digital out audio type.

Configuring Your TV's Settings

Detailed settings can be configured to suit your personal preferences.

Press “MENU” button and select Settings icon by using “◀” or “▶” button. Press OK button to view Settings menu.



Operating Settings Menu Items

- Press “▼” or “▲” button to highlight a menu item.
- Press OK button to select an item.
- Press “MENU” button to exit.

Settings Menu Items

Conditional Access: Controls conditional access modules when available.

Language: Configures language settings.

Parental: Configures parental settings.

Timers: Sets timers for selected programmes.

Date/Time: Sets date and time.

Sources: Enables or disables selected source options.

Other Settings: Displays other setting options of the TV set.

Using a Conditional Access Module

IMPORTANT: Insert or remove the CI module only when the TV is **SWITCHED OFF**.

- In order to watch certain digital channels, a conditional access module (CAM) can be necessary. This module must be inserted in the CI slot of your TV.
- Obtain the Conditional Access Module (CAM) and the viewing card by subscribing to a pay channel company, then insert those to the TV using the following procedure.
- Insert the CAM and then the viewing card to the slot that is located in the terminal cover at the rear side of the TV.
- The CAM should be correctly inserted, it is impossible to insert fully if reversed. The CAM or the TV terminal may be damaged if the CAM is forcefully inserted.

Connect the TV to the mains supply, switch on and then wait for few moments until the card is activated.

- When no module is inserted, “**No Common Interface module detected**” message appears on the screen.
- Refer to the module instruction manual for details of the settings.

Viewing Conditional Access Menu (*)

(*) These menu settings may change depending on the service provider.

Press “**MENU**” button and select the icon by using “◀” or “▶” button. Press **OK** button to view Settings menu. Use “▼” or “▲” button to highlight **Conditional Access** and press **OK** to view menu items.

Configuring Language Preferences

You can operate the TV's language settings using this menu.

Press “**MENU**” button and select the fifth icon by using “◀” or “▶” button. Press **OK** button to view Settings menu. Use “◀” or “▶” button to highlight **Language** and press **OK** to continue:

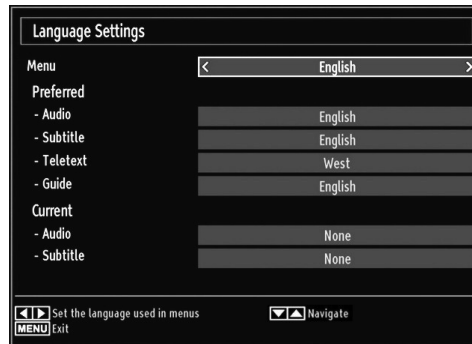

Use “▼” or “▲” button to set an item. Settings are stored automatically.

Menu: displays the system language.

Preferred

These settings will be used if available. Otherwise the current settings will be used.

- **Audio:** Sets the preferred audio language.
- **Subtitle:** Sets the subtitle language. Selected language will be seen in subtitles.
- **Teletext:** Sets teletext language.
- **Guide:** Sets the preferred Guide language.

Current (*)

(*) These settings can be changed if only the broadcaster supports. Otherwise, settings will not be available to be changed.

Audio: Changes the audio language for the current channel.

- **Subtitle:** Sets the subtitle language for the current channel.

NOTE: If the Country option is set to Denmark, Sweden, Norway or Finland, the Language Settings menu will function as described below:

Language Settings

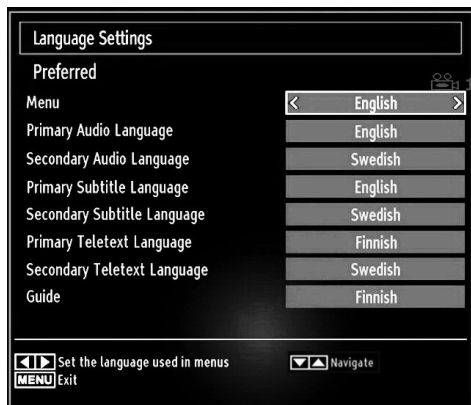

In the configuration menu, highlight the Language Settings item by pressing “▼” or “▲” buttons. Press OK and Language Settings submenu will be displayed on the screen:

Use “▼” or “▲” buttons to highlight the menu item that will be adjusted and then press “◀” or “▶” button to set.

NOTES:

- System Language determines the on-screen menu language.
- Audio Language is used for selecting the soundtrack of a channels.
- Primary settings are the first priority when multiple choices are available on a broadcast. Secondary settings are the alternatives when the first options are not available.

Parental Control

To prohibit viewing of certain programmes, channels and menus can be locked by using the parental control system.

This function enables or disables the menu protection system and allows the PIN code to be changed.

Press “MENU” button and select the icon by using “◀” or “▶” button. Press OK button to view Settings menu. Use “▼” or “▲” button to highlight **Parental** and press OK to continue:



To display parental lock menu options, PIN number should be entered. Factory default PIN number is **0000**. After coding the correct PIN number, parental settings menu will be displayed:



Parental Settings Menu Operation (*)

- Select an item by using “▼” or “▲” button.
- Use “◀” or “▶” button to set an item.
- Press OK button to view more options.

(*) If you set Country option as UK in the first time installation, Maturity Lock option will not be visible. This setting is available only for EU countries.

Menu Lock: Menu lock setting enables or disables the menu access. You can disable access to the installation menu or the whole menu system.

Maturity Lock: When set, this option gets the maturity information from the broadcast and if this maturity level is disabled, disables access to the broadcast.

Child Lock: When Child Lock is set, the TV can only be controlled by the remote control. In this case the control panel buttons will not work, except for the Standby/On button. When Child Lock is activated you are able to switch the TV into Standby mode with the Standby/On button. To switch the TV on again, you need the remote control. Hence, if one of those buttons is pressed, **Child Lock Is On** will be displayed on the screen when the menu screen is not visible.

Set PIN: Defines a new PIN number. Use numeric buttons to enter a new pin number. You will need to code your new pin a second time for verification purposes.

IMPORTANT: The factory default pin number is **0000**, if you change the pin number make sure you write it down and keep it safe.

Timers

To view Timers menu, press "MENU" button and select **Settings** icon by using "◀" or "▶" button. Press **OK** button to view **Settings** menu. Use "▼" or "▲" button to highlight **Timers** and press **OK** to continue:

Setting Sleep Timer

This setting is used for setting the TV to turn off after a certain time.

- Highlight Sleep Timer by using "▼" or "▲" button.
- Use "◀" or "▶" button to set. The timer can be programmed between **Off** and **2.00** hours (120 minutes) in steps of 30 minutes.

Setting Programme Timers

You can set programme timers for a particular programme using this feature.

- Press **YELLOW** button on the remote control to add a timer.

 **NOTE: YELLOW** button works only when the TV is in digital mode.

Timer Type: This feature is unavailable to be set.

Channel: Changes channel by using "◀" or "▶".

Date: Enter a date using the numeric buttons.

Start: Enter a starting time using the numeric buttons.

End: Enter an ending time using the numeric buttons.

Duration: Displays duration between the starting and ending time.

Repeat: Sets a timer to be repeated as Once, Daily or Weekly. Use "◀" or "▶" buttons to select an option.

Change/Delete: Controls parental settings on timers.

- Press **GREEN** button to save the timer. Press **RED** button to cancel.

Editing a Timer

- Select the timer you want to edit by pressing "▼" or "▲" button.
- Press **GREEN** button. Edit Timer menu screen will be displayed.
- When finished with editing, press **GREEN** button to save. You can press "MENU" button to cancel.

Deleting a Timer

- Select the timer you want to delete by pressing "▼" or "▲" button.
- Press **RED** button.
- Select **YES** by using "◀" or "▶" buttons to delete the timer. Select **NO** to cancel.

Configuring Date/Time Settings

Select **Date/Time** in the Settings menu to configure Date/Time settings. Press **OK** button.

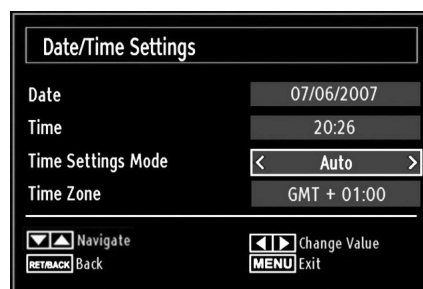

- Use "▼" or "▲" buttons to highlight **Date/Time**.

Date, Time, Time Settings Mode and Time Zone Setting will be available.

Use "▲" or "▼" buttons to highlight the Time Settings Mode. Time Settings Mode is set using "◀" or "▶" buttons. It can be set to AUTO or MANUAL.

When AUTO is selected, Date/Time and Time Zone options will not be available to be set. If MANUAL option is selected as the Time Zone can be altered:

- By pressing "▲" or "▼" buttons select Time Zone.

Use "◀" or "▶" buttons to change the Time Zone between GMT-12 or GMT+12. Date/Time on the top of the menu list will then change according to the selected Time Zone.

- Changes are automatically stored. Press "MENU" to exit.

Configuring Source Settings

You can enable or disable selected source options. The TV will not switch to the disabled source options when "SOURCE" button is pressed.

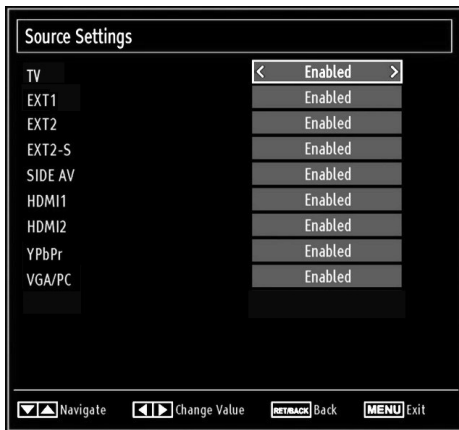

- Select **Sources** in the Settings menu and press **OK** button.
- Press "▼" or "▲" buttons to select a source.
- Use "◀" or "▶" button to enable or disable the selected source. Changes are automatically stored.

Configuring Other Settings

To view general configuration preferences, select **Other Settings** in the Settings menu and press **OK** button.

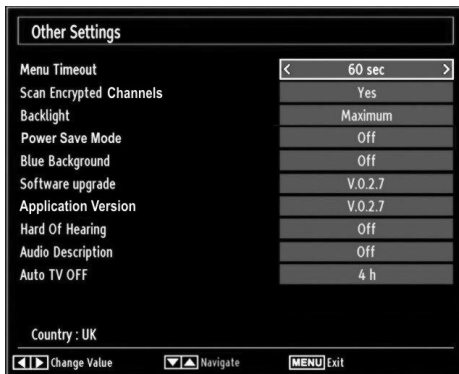

Operation

- Press "▼" or "▲" buttons to select an item.
- Use "◀" or "▶" button to set an option.
- Press **OK** button to view a sub-menu.

Menu Timeout: Changes timeout duration for menu screens.

Scan Encrypted Channels: When this setting is set as **YES**, search process will locate the encrypted channels as well. If it is set as **NO**, encrypted channels will not be located in automatic search or manual search.

Backlight: This setting controls the backlight level and it can be set to Auto, Maximum, Minimum, Medium and Eco Mode.

Power Save Mode: Use "▼" or "▲" button to select Power Save Mode. Press "◀" or "▶" button to set Power Save Mode as On or Off. See the section, "Environmental Information" in this manual for further information on Power Save Mode.

NOTE: Backlight function will be invisible if Power Save Mode is set to on.

Blue Background: Activates or deactivates blue background system when the signal is weak or absent.

Software Upgrade: To ensure that your TV always has the most update information, you can use this setting. In order for the proper operation, please ensure that the TV is set to standby mode.

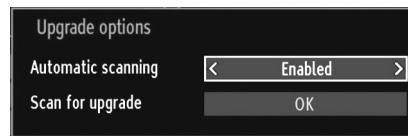

You can enable or disable automatic upgrade by setting **Automatic Scanning** option.

You can manually search for new software by selecting **Scan for upgrade**.

Application version: Displays the current application version.

Hard of Hearing: If the broadcaster enables any special signal concerning the audio, you can set this setting as On to receive such signals.

Audio Description: Audio description refers to an additional narration track for blind and visually impaired viewers of visual media, including television and movies. The description narrator talks through the presentation, describing what is happening on the screen during the natural pauses in the audio (and sometimes during dialogue, if deemed necessary). You can use this feature, only if the broadcaster supports that additional narration track.

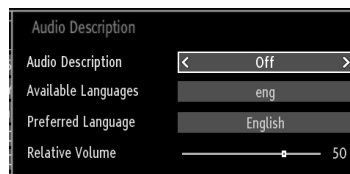

Auto TV Off: You can set the timeout value of auto off feature. After the timeout value is reached and the TV is not operated for selected time, the TV will go off.

Other Features

Displaying TV Information: Programme Number, Programme Name, Sound Indicator, time, teletext, channel type and resolution information is displayed on the screen when a new programme is entered or "INFO" button is pressed.

Mute Function: Press "MUTE" button to disable sound. Mute indicator will be displayed in the upper side of the screen. To cancel mute, there are two alternatives; the first one is pressing the "MUTE" button and the second one is increasing the volume level.

Picture Mode Selection: By pressing PRESETS button, you can change Picture Mode settings in accordance with your viewing requirements. Available options are **Dynamic, Natural, Cinema** and **Game**.

Displaying Subtitles: If there is any subtitle information available in the broadcast, you can enable subtitles by pressing the SUBTITLE button of the remote control. Press SUBTITLE button again to disable subtitle function.

If "Subtitle" is On, pressing the "INFO" button causes the following warning message display on the screen (** for UK only)

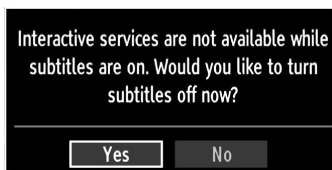

Teletext

Teletext system transmits information such as news, sports and weather on your TV. Note that if the signal degrades, for example in poor/adverse weather conditions, some text errors may occur or the teletext mode may be aborted.

Teletext function buttons are listed below:

"Teletext / Mix" button: Activates teletext mode when pressed once. Press again to place the teletext screen over the programme (mix). Pressing again will quit the teletext mode.

"RETURN" Index: Selects the teletext index page.

"INFO" Reveal: Shows hidden information (e.g. solutions of games).

"OK" Hold: Holds a text page when convenient. Press again to resume.

"Left/Right" Subcode Pages: Selects subcode pages if available when the teletext is activated.

P+ / P- and numbers (0-9): Press to select a page.

 **NOTE:** Most TV stations use code 100 for their index pages.

Coloured Buttons (RED/GREEN/YELLOW/BLUE)

Your TV supports both **FASTEXT** and **TOP text** systems. When these systems are available, the pages are divided into groups or topics. When **FASTEXT** system is available, sections in a teletext page will become colour-coded and can be selected by pressing the coloured buttons. Press a coloured button that corresponds to with your needs. The coloured writings will appear, showing you which coloured buttons to use when **TOP text** transmission is present. Pressing "Down" or "Up" commands will request the next or previous page respectively.

Tips

Screen Care: Clean the screen with a slightly damp, soft cloth. Do not use abrasive solvents as they may damage the coating layer of the TV screen. For your safety, unplug the mains plug when cleaning the set. When moving the TV, hold it properly from the bottom part.

Image Persistence: Please note that ghosting may occur while displaying a persistent image. LCD TVs' image persistence may disappear after a short time. Try turning off the TV for a while.

To avoid this, do not leave the screen in still picture for extended periods.

No Power: If your TV system has no power, please check the main power cable and connection to the mains socket outlet.

Poor Picture: Have you selected the correct TV system? Is your TV set or house aerial located too close to a non-earthed audio equipment or neon lights, etc.? Mountains or high buildings can cause double pictures or ghost images. Sometimes you can improve the picture quality by changing the direction of the aerial. Is the picture or teletext unrecognisable? Check if you have entered the correct frequency. Please retune the channels. The picture quality may degrade when two peripherals are connected to the TV at the same time. In such a case, disconnect one of the peripherals.

No Picture: Is the aerial connected properly? Are the plugs connected tightly to the aerial socket? Is the aerial cable damaged? Are suitable plugs used to connect the aerial? If you are in doubt, consult your dealer. No Picture means that your TV is not receiving a transmission. Have you selected the correct button on the remote control? Try once more. Also make sure the correct input source has been selected.

Sound: You can not hear any sound. Did you perhaps interrupt the sound, pressing the  button? Sound is coming from only one of the speakers. Is the balance set to one extreme? See **Sound Menu**.

Remote Control: Your TV no longer responds to the remote control. Perhaps the batteries are exhausted. If so you can still use the local buttons on the TV.

Input Sources: If you cannot select an input source, it is possible that no device is connected. Check the AV cables and connections if you have tried to connect a device.

Appendix A: PC Input Typical Display Modes

The display has a maximum resolution of 1920 x 1200. The following table is an illustration of some of the typical video display modes. Your TV may not support different resolutions. Supported resolution modes are listed below. If you switch your PC to an unsupported mode, a warning OSD will appear on the screen.

Index	Resolution	Frequency
1	640x400	70Hz
2	640x480	60Hz
3	640x480	72Hz
4	640x480	75Hz
5	800x600	56Hz
6	800x600	60Hz
7	800x600	70Hz
8	800x600	72Hz
9	800x600	75Hz
10	1024x768	60Hz
11	1024x768	70Hz
12	1024x768	72Hz
13	1024x768	75Hz
14	1152x864	75Hz
15	1280x768	60Hz
16	1360x768	60Hz
17	1280x768	75Hz
18	1280x960	60Hz
19	1280x960	75Hz
20	1280x1024	60Hz
21	1280x1024	75Hz
22	1400x1050	60Hz
23	1600x1200	60Hz
24	1920x1080	60Hz
25	1920x1200	60Hz

Appendix B: AV and HDMI Signal Compatibility (Input Signal Types)

Source	Supported Signals	Available	
EXT-1 (SCART-1)	PAL 50/60	O	
	NTSC 60	O	
	RGB 50	O	
	RGB 60	O	
EXT-2 (SCART-2)	PAL 50/60	O	
	NTSC 60	O	
	RGB 50	X	
	RGB 60	X	
SIDE AV	PAL 50/60	O	
	NTSC 60	O	
YPbPr	480I	60Hz	O
	480P	60Hz	O
	576I	50Hz	O
	576P	50Hz	O
	720P	50Hz	O
	720P	60Hz	O
	1080I	50Hz	O
	1080I	60Hz	O
HDMI1 HDMI2	480I	60Hz	O
	480P	60Hz	O
	576I	50Hz	O
	576P	50Hz	O
	720P	50Hz	O
	720P	60Hz	O
	1080I	50Hz	O
	1080I	60Hz	O
	1080P	50Hz	O
	1080P	60Hz	O
	1080P	24 HZ	O

(X: Not Available, O: Available)

In some cases a signal on the LCD TV may not be displayed properly. The problem may be an inconsistency with standards from the source equipment (DVD, Set-top box, etc.). If you do experience such a problem please contact your dealer and also the manufacturer of the source equipment.

Appendix C: Supported DVI Resolutions

When connecting devices to your TV's connectors by using DVI converter cables (not supplied), you can refer to the following resolution information.

Index	Resolution	Frequency
1	640x400	70Hz
2	640x480	60Hz
3	640x480	72Hz
4	640x480	75Hz
5	800x600	56Hz
6	800x600	60Hz
7	800x600	70Hz
8	800x600	72Hz
9	800x600	75Hz
10	1024x768	60Hz
11	1024x768	70Hz
12	1024x768	72Hz
13	1024x768	75Hz
14	1152x864	75Hz
15	1280x768	60Hz
16	1360x768	60Hz
17	1280x768	75Hz
18	1280x960	60Hz
19	1280x960	75Hz
20	1280x1024	60Hz
21	1280x1024	75Hz
22	1400x1050	60Hz
23	1600x1200	60Hz
24	1920x1080	60Hz
25	1920x1200	60Hz
26	480p	60Hz
27	576p	50Hz
28	720p	50Hz
29	720p	60Hz
30	1080i	50Hz
31	1080i	60Hz
32	1080p	24Hz
33	1080p	25Hz
34	1080p	30Hz
35	1080p	50Hz
36	1080p	60Hz

Appendix D: Supported File Formats for USB Mode

Supported Players			
Player	Stream	Video Decoder (MSVD)	Audio Decoder (MSAD)
Audio	MP3	None	MP3
Audio	WAV/AIFF	None--	LPCM
MPEG1 Program Stream	MPEG-1	MPEG1	MP3, AC-3 (optional) and PCM
MPEG2 Program Stream	MPEG-2	MPEG2	MP3, AC-3 (optional) and PCM
AVI (Xvid)	XVID	MPEG2	MP3, AC-3 and PCM



Appendix E: Software Upgrade

- Your TV is capable of finding and updating new software upgrades over broadcast channels.
- For broadcast channels search, TV looks the available channels stored in your settings. So before software upgrade search, it is advised to auto search and update all available channels.

1) Software upgrade search via user interface

- It is possible manually to check if there is a new software upgrade for your TV set.
- Simply navigate on your main menu. Choose **Settings** and select **Other Settings** menu. In **Other Settings** menu navigate on to the **Software Upgrade** item and press **OK** button to open **Upgrade Options** menu.
- In **Upgrade Options** menu select **Scan for upgrade** and press **OK** button.
- If a new upgrade is found, it starts to download the upgrade. A progress bar indicates the remaining download progress. When download completes with success a message is displayed for reboot to activate new software. Press **OK** to continue with the reboot operation.

2) 3.AM search and upgrade mode

- If **Automatic scanning** in **Upgrade Options** menu is enabled, TV wakes up at 03:00 and searches broadcast channels for new software upgrade. If new software is found and downloaded successfully, with next power up TV opens with new software version.

Note on reboot operation: Reboot is the last step in software upgrade operation if download of new software is finished successfully. During reboot TV makes final initializations. In reboot sequence panel power is closed and front led indicates the activity with blinking. Around 5 minutes later TV restarts with new software activated.

- If your TV fails to restart in 10 minutes, unplug power for 10 minutes and re-plug again. TV should open with new software safely. If you still can not get TV working, please kindly repeat unplug and plug sequence a few times more. If your set still can not operate, please call the service personnel to fix the problem for you.

⚠ WARNING: While led is blinking during reboot do not unplug your TV's power. Doing this may cause your TV not to re-open again and can only be fixed by service personnel.



Products



Battery

Information for Users on Disposal of Old Equipment and Batteries

[European Union only]

These symbols indicate that equipment with these symbols should not be disposed of as general household waste. If you want to dispose of the product or battery, please consider the collection systems or facilities for appropriate recycling.

Notice: The sign Pb below the symbol for batteries indicates that this battery contains lead.

Appendix E: Pin Specifications

SCART connector pin specifications

Pin	Input signal	Pin	Input signal
1	AUDIO OUT (RIGHT)	12	Not used
2	AUDIO IN (RIGHT)	13	RGB-R GND
3	AUDIO OUT (LEFT/MONO)	14	GND
4	AUDIO GND	15	RGB-R / S.VHS CHROMINANCE IN
5	RGB-B GND	16	BLANKING SIGNAL
6	AUDIO IN (LEFT/MONO)	17	COMPOSITE VIDEO GND
7	RGB-B IN	18	BLANKING SIGNAL GND
8	AUDIO / RGB SWITCH / 16:9	19	COMPOSITE VIDEO OUT
9	RGB-G GND	20	COMPOSITE VIDEO / S.VHS LUMINANCE IN
10	Not used	21	GND / SHIELD (CHASSIS)
11	RGB-G IN		

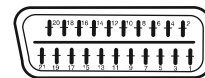

HDMI connector pin specifications

Pin	Input signal	Pin	Input signal
1	TMDS Data2+	11	TMDS Clock Shield
2	TMDS Data2 Shield	12	TMDS Clock-
3	TMDS Data 2-	13	CEC
4	TMDS Data 1+	14	Reserved (N.C. on device)
5	TMDS Data1 Shield	15	SCL
6	TMDS Data1-	16	SDA
7	TMDS Data0+	17	DDC/CED Ground
8	TMDS Data0 Shield	18	+5V Power
9	TMDS Data0-	19	Hot Plug Detect
10	TMDS Clock+		

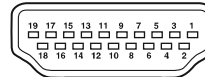

Signal Input

PC RGB Terminal (D-sub 15-pin connector)

Pin	Input signal
1	R
2	G or sync on green
3	B
4	No connection
5	No connection
6	R.GND
7	G.GND
8	B.GND
9	No connection
10	GND
11	No connection
12	[SDA]
13	H.sync or H/V composite sync
14	V.sync. [V.CLK]
15	[SCL]

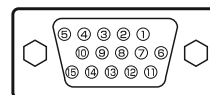

Specifications

TV BROADCASTING

PAL/SECAM B/G D/K K' I/I' L/L'

RECEIVING CHANNELS

VHF (BAND I/III)

UHF (BAND U)

HYPERBAND

NUMBER OF PRESET CHANNELS

1000

CHANNEL INDICATOR

On Screen Display

RF AERIAL INPUT

75 Ohm (unbalanced)

OPERATING VOLTAGE

220-240V AC, 50 Hz.

AUDIO

German + Nicam Stereo

AUDIO OUTPUT POWER (W_{RMS}) (10% THD)

2 x 8

POWER CONSUMPTION (W)

210 W (max)

< 0,5W (Standby)

PANEL

16:9 display, 42" Screen Size

DIMENSIONS (mm)

DxLxH (with foot): 246 x 1014 x 687

Weight (Kg): 17,5

DxLxH (without foot): 103 x 1014 x 657

Weight (Kg): 16

OUTPUT/INPUT CONNECTIONS

2 x HDMI

2 x Scart with CVBS-, RGB- and Y/C-signal input

2 x USB

1 x PC / VGA

1 x Digital Audio out (coaxial)

1 x 3,5 mm headphones

1 x CI - Slot

1 x Side-A/V

Digital Reception	MHEG-5 ENGINE compliant with ISO/IEC 13522-5 UK engine Profile 1	for UK
	Object carousel support compliant with ISO/IEC 135818-6 and UK DTT profile	
	Frequency range: 474-850 MHz for UK models	
	170-862 MHz for EU models	
	Transmission standard: DVB-T. MPEG-2	
	Demodulation: COFDM with 2K/8K FFT mode	
	FEC: all DVB modes	
	Video: MP@ML, PAL, 4:3/16:9	
	Audio: MPEG Layer I&II 32/44.148kHz.	

Definitions of Important Terms

Aspect Ratio

This refers to the ratio of the width to the height of a picture.

AVL

Automatic volume limiter.

Brightness

This defines the overall light level of the entire image.

Contrast

This will adjust the range of optical density and tone of the complete picture.

Component Audio Inputs

Used for the standard analogue audio for interconnection of components.

Component Video Inputs (Y/Pb/Pr)

This video signal consist of colour differences and a luminance signal.

HDMI

High Definition Multimedia Interface. This connection provides high-quality, uncompressed digital video and audio, combining both audio and video signals via a single connection.

LCN

LCN is the Logical Channel Number system that organizes available broadcasts in accordance with a recognizable channel sequence.

Multichannel audio

Means that the TV program is aired in several audio versions, for example, in two different languages. This is possible if on an analogue TV each of the two channels of the stereo tracks for left and right channels are occupied with one audio track in mono (single channel). In digital TV multiple audio streams can be broadcasted and selected on the receiver side

NTSC

United States' standard for scanning television signals that has been adopted by some other countries.

OSD

On Screen Display. Information, like channel number and volume on the screen of a TV.

PAL

The European TV standard for scanning television signals.

Scart

A 21-pin audio/video connector found primarily on European televisions.

Sharpness

A control that creates the effect of greater resolution by light to dark transitions.

System

Defines the broadcast type of the TV picture since these broadcast systems are not same for all countries.

VGA

VGA is a common standard graphics display system for PCs.

SECAM

The video format used in France and some other countries, similar to PAL.



DVB-T functionality information

This DVB receiver is only suitable for use in the country which it was designed to be used in.

Although this DVB receiver conforms to the latest DVB specifications at the time of manufacture, we cannot guarantee compatibility with future DVB transmissions due to changes that may be implemented in broadcast signals and technologies.

Some digital television functions may not be available in all countries.

We continually strive to improve our products; therefore, specifications may change without prior notice.

For advice on where to purchase accessories, please contact the store where you purchased your equipment.



Product Guarantee



Product Guarantee

This product guaranteed against manufacturing defects for a period of



This product is guaranteed for twelve months from the date of original purchase. Any defect that arises due to faulty materials or workmanship will either be replaced, refunded or repaired free of charge where possible during this period by the dealer from whom you purchased the unit.

The guarantee is subject to the following provisions:

- The guarantee does not cover accidental damage, misuse, cabinet parts, knobs or consumable items.
- The product must be correctly installed and operated in accordance with the instructions contained in this manual.
- It must be used solely for domestic purpose.
- The guarantee will be rendered invalid if the product is re-sold or has been damaged by inexpert repair.
- Specifications are subject to change without notice.
- The manufacturer disclaims any liability for the incidental or consequential damages.
- The guarantee is in addition to, and does not diminish your statutory or legal rights.
- In the event of a problem with the product with in the guarantee period call the **Customer Helpline: 0845 604 0105.**

Guarantor: Argos Ltd
489 - 499 Avebury Boulevard
Central Milton Keynes
MK9 2NW

Free Manuals Download Website

<http://myh66.com>

<http://usermanuals.us>

<http://www.somanuals.com>

<http://www.4manuals.cc>

<http://www.manual-lib.com>

<http://www.404manual.com>

<http://www.luxmanual.com>

<http://aubethermostatmanual.com>

Golf course search by state

<http://golfingnear.com>

Email search by domain

<http://emailbydomain.com>

Auto manuals search

<http://auto.somanuals.com>

TV manuals search

<http://tv.somanuals.com>