

Contents

Environmentally Friendly Waste Disposal	2
Hints and Tips for Eco-friendly Washing	2
Safety Instructions	3
Parts and Accessories	5
Control Panel and Display	6
Before You Start Washing	8
How to Use the Washing Machine	9
List of Programs	14
Partial Operations Using the Fuzzy Program	18
In Case of Power Outage	21
Care and Maintenance	21
Troubleshooting	23
Error Codes	24
How to Install the Washing Machine	25
Customer Service	30
Specifications	30

Thank you for purchasing a Hitachi fully automatic washing machine.

- Please read these operating & installation instructions carefully for proper operation of the machine.
- Please keep these operating & installation instructions for future reference.

Environmentally Friendly Waste Disposal

Disposing of the packaging

The shipping package has protected your new washing machine on its way to your home. All materials are ecologically harmless and recyclable. Please contribute to a better environment by disposing of packaging materials in an environmentally conscious manner.

Ask your dealer about current means of disposal.

Risk of choking!

Do not let children play with packaging and associated parts. There is a risk of suffocating on plastic bags and collapsible boxes.

Old appliances are not worthless rubbish. Environment-conscious recycling can reclaim valuable new materials.

Disposing of your old appliance

Risk of death!

Unplug the power plug from appliances you are no longer using. Cut off the power cord and dispose of it with the plug.

If you wish to discard this product, contact your local authorities or dealer and ask for the correct method of disposal.

Hints and Tips for Eco-friendly Washing

- Keep to the load limit of each program.
- Add detergent according to the degree of soiling, laundry size, and water hardness. Follow the detergent manufacturer's instructions regarding the amount of detergent to use.
- This washing machine has enhanced water-saving features such as Spin Shower Rinse and uses less water than former models. If you want to save more water, select the Water Save program using the Program button.

Safety Instructions

This washing machine is designed for home use only.

Before operating the washing machine, please read these safety instructions carefully.



Warning

Issues which could cause death or serious injury.

General safety

- Do not dismantle, repair or modify the washing machine.
→ This could cause malfunction, fire, electric shock or injury.
→ Contact your local service center for repairs.
- Do not put fire sources or anything inflammable in or near the washing machine (gas, diesel, petroleum, thinner, alcohol, or clothes stained with these substances).
→ This could cause an explosion or fire.
- Do not pour water on the washing machine when it is running.
→ This could cause an electric shock.
- Do not climb on the washing machine. Do not place heavy object, drop any object or apply impact on the lid glass.
→ This could cause lid glass breakage. If any scratch or breakage is found on lid glass, stop using the washing machine and contact your local service center to request inspection and repair.
- It is a malfunction if the tub is still spinning when the lid lock is released and you can open the lid. If this happens, do not touch the laundry inside the tub and stop using the washing machine immediately. Contact your local service center for repair.
- This appliance is not intended for use by persons (including children) with reduced physical, sensory or mental capabilities, or lack of experience and knowledge, unless they have been given supervision or instruction concerning use of the appliance by a person responsible for their safety.

Installation

- Do not install the washing machine in an extremely humid place, such as a bathroom or a place exposed to rain.
→ Risk of fire, electric shock, current leakage, corrosion or product damage.
- Do not install the washing machine on a board with castors or on an unstable surface.
→ This may cause injury or malfunction due to abnormal vibration.
- The washing machine must be grounded if you use a two-pin plug adapter on the three-pin plug.
→ Not doing so could cause the electric shock, electronic substrate and electronic parts damage.
- Use a new water supply hose to connect the washing machine to the water tap.
- The opening must not be obstructed by carpeting if the washing machine is installed on a carpeted floor.

Power source and cord

- Do not insert or remove the power plug with wet hands.
→ This could cause an electric shock.
- Use the rated voltage. Do not connect other devices to the same outlet.
→ Using the washing machine and other electric appliances on the same outlet may cause the plug to overheat and result in fire.
- Clean off any dust on the power plug.
→ A dirty or dusty plug may cause a fire.
- Do not use an electric socket or outlet that is damaged or loose.
→ This could cause an electric shock, short circuit, or fire.
- Do not damage, cut, modify, bend, or fold the power cord.
→ This could damage the power cord and cause a fire or electric shock.
- Do not use an extension cord on the power cord.
→ This could cause overheating or fire.
- If the power cord is damaged, it must be replaced by a service agent or repair shop authorized by the manufacturer to avoid risks.

Safety Instructions

Child safety

- Keep packaging out of reach of children and infants.
→ Danger of suffocation.
- Do not let children climb onto the washing machine or to get into the tub. Do not leave boxes or chairs near the washing machine that children could use to climb onto it.
→ This may cause injury.
- Children should be supervised to ensure that they do not play with the appliance.

⚠ Caution

Issues which could cause injury or damage property.

General safety

- If there is a water outage or you remove the water supply hose and reattach it, close the tap, select Tub clean program and press the Start/Pause button, then slowly open the tap.
→ Air pressure from a large amount of air in the water pipes could damage the washing machine.
- Periodically check that the union nut on the water supply hose is tight.
→ A loose nut may cause a water leak.
- Remove the power plug from the outlet and close the water tap if you will not use the washing machine for a long time.

Use

- All packaging materials must be removed before using the washing machine.
→ This could cause malfunction or abnormal vibration.
- Check inside the tub before operating the washing machine.
→ Check that no pets or small animals are in the tub.
- Do not wash items, such as raincoats, wet suits, ski suits, sleeping bags, cushions, pillows, shoes, shower curtain or other things, through which water does not flow easily.
→ The washing machine may not work properly, or it could cause injury or damage the washing machine.
- Do not fold and stack large items together, such as blankets, when washing them.
- Do not use a laundry net that is larger than 40 cm on a side.
→ The clothes may become off balance and cause abnormal vibration during the spin cycle.
- Do not load laundry over the lower part of the liquid load balancer (dotted line).
→ Doing so could cause laundry to fly out of the tub during the spin cycle and damage the clothes or the washing machine, or cause a water leak.
- Always put detergent into the detergent dispenser when washing laundry.
- Do not use water hotter than 50°C.
- Do not wash items together with coins, pins, or stones.
→ This may damage clothes or the washing machine, or cause a water leak. Check inside pockets before washing.
- Do not press the buttons with sharp pointed objects.
- Do not put heavy objects, liquid-filled containers or equipment which produces heat on the washing machine.
→ This may damage the washing machine or its top.

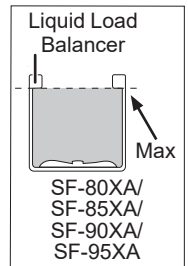

Care and maintenance

- If detergent, fabric softener or bleach spills on the surface of the machine, clean it up with a damp cloth immediately.
→ The plastic or steel parts of the washing machine may be damaged.
- Do not place equipment that produces heat near the washing machine.
→ This may cause deformation of the washing machine.

Parts and Accessories

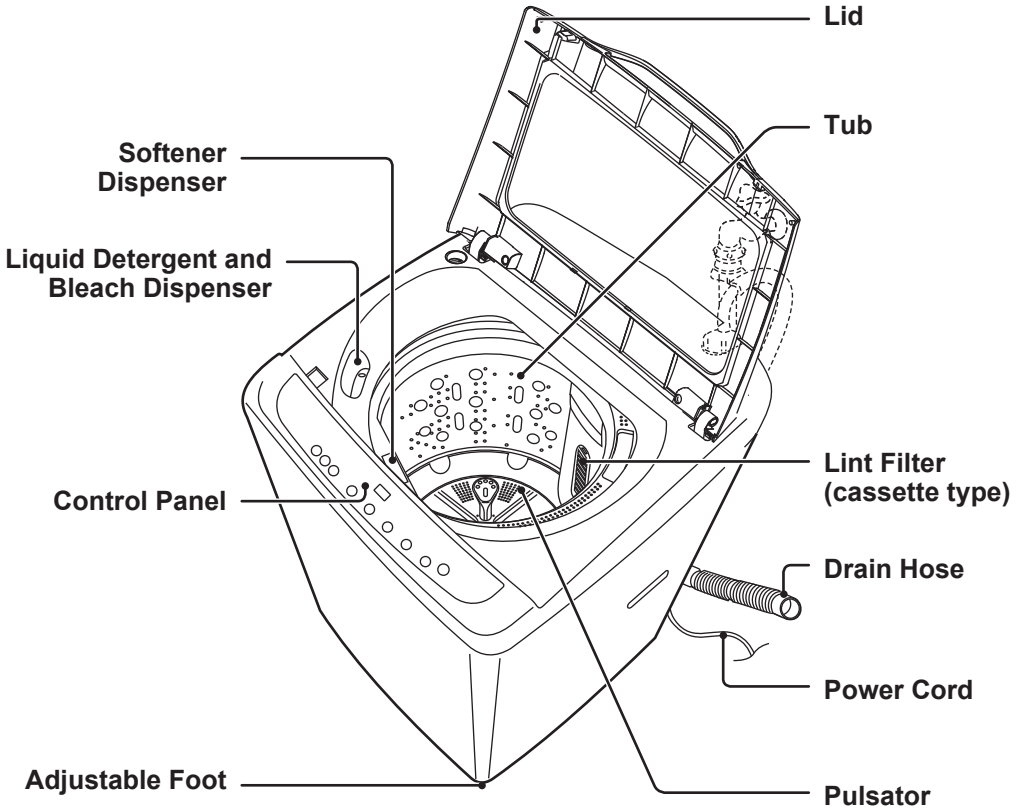

Accessories

Water Supply Hose and One-touch Joint

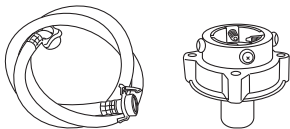

(1 set)

Foot Caps

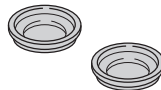

(2 pieces)

Rat Guard

(2 pieces)

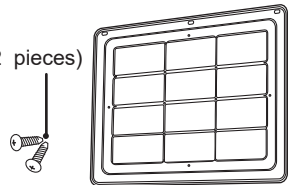

Optional accessories

Laundry Net



Refer to page 12
Part number PTSF-80J 009

Control Panel and Display

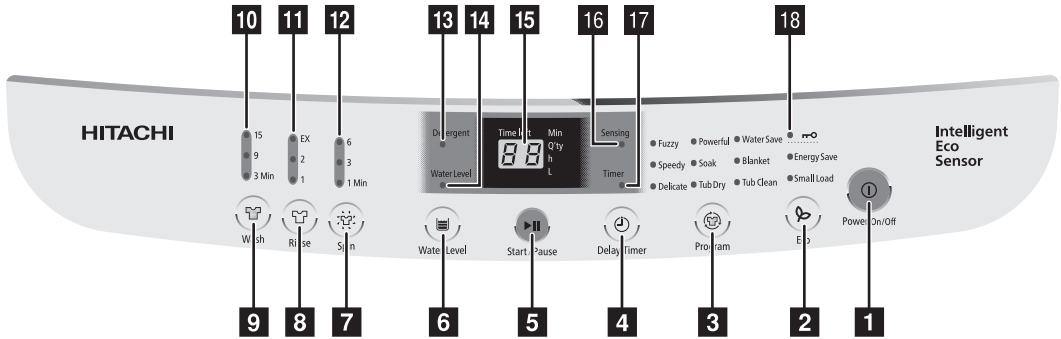

1 Power button

Press this button to switch power on and off. The washing machine automatically switches off when operations are finished. The washing machine also turns off automatically if it is not operated or no button is pressed for 10 minutes after the power has turned on.

2 Eco button

Select Eco modes. Energy Save mode and Small Load mode can be set in the Fuzzy programs.

3 Program button

Select programs. The program changes each time the button is pressed.

4 Delay Timer button

The delay time can be set between 3 and 12 hours.

5 Start/Pause button

Starts and pauses operation. When the washing machine is paused for over one hour and no operations are done, it turns off automatically.

6 Water level button

Changes the water level.

7 Spin button

Changes the spin time. The spin time can be set between one and 9 minutes.

8 Rinse button

Changes the number and type of rinses.

9 Wash button

Changes the washing time. The washing time can be set between 3 and 18 minutes.

10 Wash indicator

Shows the washing time.

11 Rinse indicator

Shows the number and type of rinses.

12 Spin indicator

Shows the spin time.

Control Panel and Display

- | | |
|---------------------------------|---|
| 13 Detergent indicator | The amount of detergent is shown on the display when the Detergent indicator is lit. The display shows the number of scoops of powder detergent. (Each scoop is 35g) |
| 14 Water Level indicator | Lights the Water Level indicator and shows the amount of water to be used for washing in liters on the display. |
| 15 Display | Shows the amount of detergent, the amount of water, remaining time and timer. |
| 16 Sensing indicator | Flashes when the machine is checking the amount of fabric. |
| 17 Timer indicator | Lights the Timer indicator and shows the time to finish the operations on the display. |
| 18 Lid lock indicator | Locks the lid during the spin cycle. The lid cannot be opened while this indicator is lit and the lid is locked. To release the lock, press the Start/Pause button to pause operation. The lock is automatically released after a short time. |

Before You Start Washing

Preparation of the laundry

- Remove any foreign objects (coins, safety pins, etc.).
- Put delicate clothes (knits, lingerie, etc.) in a net.
- Remove large lumps of lint, mud, sand, hair, and pet hair from laundry.
- Tie strings and close fasteners.

Sorting the laundry

- Sort laundry according to the type of fabric and care label symbols (cottons, blended fabrics, synthetics, wool, hand washable items, etc.).
- Do not wash extremely small loads, such as only a pair of jeans.
→ The clothes may become off balance and cause abnormal vibration during the spin cycle.
- Separate colored and white items.

Risk of injury!

Do not wash the following items, through which water does not flow easily, because doing so creates abnormal vibration during the spin cycle and could cause injury or malfunction.

- Waterproof items, such as a wet suit, ski suit, shower curtain, etc.
- Items with non-slip rubber backing, such as door mats.
- Cushions, pillows, shoes, etc.

Detergents and additives

- Use an appropriate amount of detergent according to the water level on the washing machine.
The type and amount of detergent depend on the type of fabric, volume, load size, degree of soiling, and hardness of the water used.
Use less detergent if:
 - The load is small.
 - The laundry is not very dirty.
- Too much detergent can result in excess foam, which reduces rinse efficiency or may cause a water leak.
- Depending on the detergent brand, detergent may not dissolve completely if the water pressure is low or the water is too cold.
- When using softeners or bleaches, follow the instructions on the package.
- Detergent remained in drain route may be caused by quality of water or type of detergent. In case of repeatedly using under this condition, it may cause washer trouble.

1 Sort the laundry

- Sort the laundry according to the type of fabric, care label symbol, and degree of soiling.
→Page 8: Preparation of the laundry
- Do not exceed the maximum load.
- Laundry shall not exceed the lower part of the liquid load balancer (dotted line). Otherwise, laundry may jump out from the wash tub while spinning and it may cause damage.

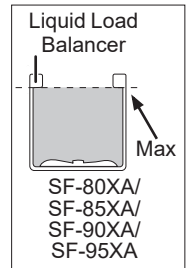

2 Press the Power button to turn on the power

- If no program is selected within 10 minutes, the washing machine automatically switches itself off. Press the Power button again to turn on the power.

3 Select and adjust the program

- Select a program with the Program button.
→Page 14: List of Programs
- You can change the combination or settings of wash, rinse, and spin operations with the Wash, Rinse, and Spin buttons.
- You can set the Eco modes in the Fuzzy program with the Eco button.
→Page 11: How to use Eco mode

4 Press the Start/Pause button

- Before operation starts, the laundry is weighed, and amount of detergent and water level appear on the display.

5 Put detergent into the Tub and close the Lid

- The amount of detergent is based on a single 35-gram scoop of powder detergent. Since the required amount of detergent varies depending on the type of detergent, follow the instructions on the package of detergent.
- For liquid detergent, follow the instructions on the package and add it to the Liquid Detergent Dispenser.
- Add softener to the Softener Dispenser according to the instructions on the package of softener. The softener is added to the tub automatically before the final rinse.
- For liquid bleach, follow the instructions on the package and add it to the Bleach Dispenser.
- The speed that the lid closes may vary, depending on the temperature, however, this is not abnormal.

– Pausing a program:	Press the Start/Pause button. The washing machine will switch itself off if it is not restarted within 1 hour.
– Adding clothes partway through a program:	Press the Start/Pause button to pause operation and add your clothes. In the case the lid is locked, wait until the tub stops completely and the lid lock is automatically released. After adding the clothes, close the lid and press the Start/Pause button to restart operation. * Note: It is not recommended to add a large amount of clothes as the washing machine first measures the load size to determine optimum operation.
– Terminating a program:	Press the Start/Pause button, and press the Power button to turn off the power.

6 Program ends

- The alarm sounds when a program ends.

Press the Water Level button for 3 seconds to deactivate the alarm or to change the sound in the following way.

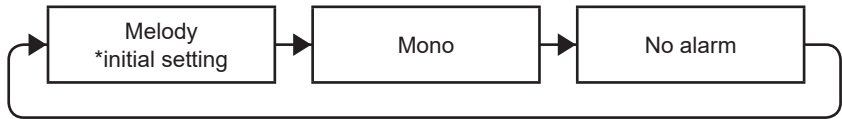

- The washing machine automatically switches off when the operations are finished.

How to use the Eco mode

1. Press the Power button to turn on the power.
2. Select the Fuzzy program.
3. Press the Eco button and select the Eco mode (Energy Save or Small Load).
4. Press the Start/Pause button.
5. Put detergent into the tub and close the lid.
 - The mode changes each time the button is pressed.
 - The Energy Save mode helps you to reduce energy consumption up to 40% compared to the normal Fuzzy program.
 - The Small Load mode is a dedicated mode for small load up to 0.6 kg. It uses less water and detergent compared to normal Fuzzy program. (Not for a piece of clothing with weight of 0.6kg.) This mode is suitable for washing small clothes, such as socks.

How to Use the Washing Machine

How to use the Blanket program

1. Prepare the laundry.

- Fold large items, such as quilts or blankets, as follows. They should not be taller than 25 cm after they are folded.

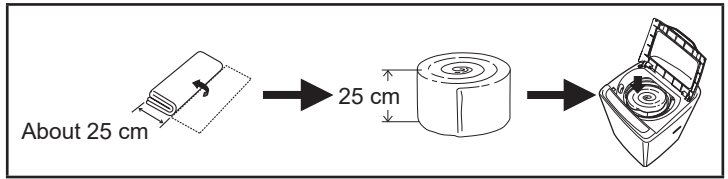

If it exceeds 25 cm, use a laundry net, which is sold separately. (Laundry net: Part number PTSF-80J 009)

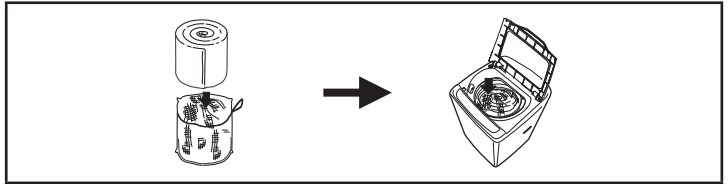

2. Press the Power button to turn on the power.
3. Select the Blanket program.
4. Add detergent and close the lid.
5. Press the Start/Pause button.

Items you can wash with the Blanket program

- Washable quilts

Machine washable quilts with synthetic (polyester) batting.

When not using the optional laundry net:

150 cm x 200 cm or smaller, and less than 1.5 kg

When using the optional laundry net:

174 cm x 225 cm or smaller, and less than 2 kg

(Laundry net: Part number PTSF-80J 009)

- Washable blankets

Up to 3 kg of synthetic blankets that are labeled as hand washable.

– For electric blankets, follow the instructions for the electric blanket.

- Other washable items

Mattress pads labeled as hand washable.

- Do not fold and stack large items together, (such as sheets) when washing them.
→ The clothes may become off balance and cause abnormal vibration during the spin cycle.
- If C3 is shown in the indicator, close the lid.

How to Use the Washing Machine

How to use the Tub Dry program

- Use this program separately from other washing programs. (Do not put laundry into the tub.)
- 1. Press the Power button to turn on the power.
- 2. Select the Tub Dry program.
- 3. Close the lid and press the Start/Pause button.
- The tub spins quickly the same as the regular spin cycle to remove the water from the tub.

How to use the Tub Clean program

- Use this program separately from other washing programs. (Do not put laundry into the tub.)
- 1. Press the Power button to turn on the power.
- 2. Select the Tub Clean program.
- 3. Press the Start/Pause button. The washing machine starts pouring water into the tub.
- 4. Add tub cleaner, according to the package, to the tub. (Liquid peroxide-based bleach is also effective as a tub cleaner. Since the required amount of bleach varies depending on the type of bleach, follow the instructions on the package of bleach.)
- 5. Close the lid.
- Water is added to the maximum level to wash away dirt you cannot see on the tub and outer tub. After that, Normal Rinse is performed twice to flush out any remaining dirt or tub cleaner.

How to use the Delay Timer

1. Press the Power button to turn on the power.
 2. Select a program.
 3. Press the Delay Timer button and select the time to finish washing. Each press of the button adds an hour starting from 3 hours to 12 hours later.
 4. Press the Start/Pause button.
 5. Add detergent and close the lid. The power turns off after a short time.
 6. Operations finish at the set time.
- The Delay Timer is unavailable for the Blanket, Tub Dry, and Tub Clean programs.
 - To change the setting, press the Power button and do the settings again.
 - If there is a power outage while the timer is set, the timer setting is cancelled. If this happens, press the Power button again and reset the timer.
 - To prevent your laundry from wrinkling, remove it as soon as possible after washing is done.

List of Programs



: Default settings



: Changeable settings (via corresponding button)

Program		Fuzzy	FUZZY	FUZZY
			ENERGY SAVE	SMALL LOAD
Maximum load	95XA	9.5 kg		0.6 kg
	90XA	9 kg		0.6 kg
	85XA	8.5 kg		0.6 kg
	80XA	8 kg		0.6 kg
Amount of water	95XA	32 to 65 L (automatically)		20 L
		20 to 65 L		20 to 26 L
	90XA	32 to 65 L (automatically)		20 L
		20 to 65 L		20 to 26 L
	85XA	32 to 63 L (automatically)		20 L
		20 to 63 L		20 to 26 L
	80XA	32 to 60 L (automatically)		20 L
		20 to 60 L		20 to 26 L
Wash	95XA	12 min	47 min	9 min
	90XA		47 min	
	85XA		47 min	
	80XA		42 min	
		3, 9, 12, 15, 18 min, or none	-	-
Rinse		Spin shower rinse 1 time + Beat eco rinse 1 time		Normal Rinse 1 time
		Normal Rinse 1 time, Water-Injection Rinse 1 time, Normal Rinse 2 times, Water-Injection Rinse 2 times, or None	-	-
Spin		6 min		6 min
		1, 3, 6, 9 min, or none	-	-
Required time (guide)	95XA	35 to 51 min	73 to 75 min	23 min
	90XA	35 to 51 min	73 to 75 min	
	85XA	35 to 51 min	73 to 75 min	
	80XA	35 to 51 min	73 to 75 min	

List of Programs



: Default settings



: Changeable settings (via corresponding button)

Program		POWERFUL	WATER SAVE	SPEEDY
Maximum load	95XA	9.5 kg	9.5 kg	3 kg
	90XA	9 kg	9 kg	3 kg
	85XA	8.5 kg	8.5 kg	3 kg
	80XA	8 kg	8 kg	3 kg
Amount of water	95XA	32 to 65 L (automatically)	32 to 60 L (automatically)	41 L
		20 to 65 L	20 to 60 L	20 to 65 L
	90XA	32 to 65 L (automatically)	32 to 60 L (automatically)	41 L
		20 to 65 L	20 to 60 L	20 to 65 L
	85XA	32 to 63 L (automatically)	32 to 58 L (automatically)	41 L
		20 to 63 L	20 to 58 L	20 to 63 L
	80XA	32 to 60 L (automatically)	32 to 56 L (automatically)	41 L
		20 to 60 L	20 to 56 L	20 to 60 L
Wash		18 min	9 min	3 min
		3, 9, 12, 15, 18 min, or none	3, 9, 12, 15, 18 min, or none	3, 9, 12, 15, 18 min, or none
Rinse		Normal Rinse 2 times	Spin shower rinse 2 times	Extra rinse 1 time
		Normal Rinse 1 time, Water-Injection Rinse 1 time, Normal Rinse 2 times, Water-Injection Rinse 2 times, or None	Normal Rinse 1 time, Water-Injection Rinse 1 time, Normal Rinse 2 times, Water-Injection Rinse 2 times, or None	Normal Rinse 1 time, Water-Injection Rinse 1 time, Normal Rinse 2 times, Water-Injection Rinse 2 times, or None
Spin		9 min	6 min	6 min
		1, 3, 6, 9 min, or none	1, 3, 6, 9 min, or none	1, 3, 6, 9 min, or none
Required time (guide)	95XA	47 to 59 min	31 to 34 min	29 min
	90XA	47 to 59 min	31 to 34 min	
	85XA	47 to 59 min	31 to 34 min	
	80XA	47 to 59 min	31 to 34 min	

List of Programs



: Default settings



: Changeable settings (via corresponding button)

Program		DELICATE	BLANKET	SOAK		
				1 hr	3 hrs	5 hrs
Maximum load	95XA	2 kg	3 kg	9.5 kg		
	90XA	2 kg	3 kg	9 kg		
	85XA	2 kg	3 kg	8.5 kg		
	80XA	2 kg	3 kg	8 kg		
Amount of water	95XA	41 L	65 L	65 L		
		20 to 65 L	20 to 65 L	20 to 65 L		
	90XA	41 L	65 L	65 L		
		20 to 65 L	20 to 65 L	20 to 65 L		
	85XA	41 L	63 L	63 L		
		20 to 63 L	20 to 63 L	20 to 63 L		
	80XA	41 L	60 L	60 L		
		20 to 60 L	20 to 60 L	20 to 60 L		
Wash		9 min	9 min	60 min	180 min	300 min
		3, 9, 12, 15, 18 min, or none	-	-	-	-
Rinse		Extra rinse 1 time	Normal Rinse 2 times	Spin shower rinse 1 time + Beat eco rinse 1 time		
		Normal Rinse 1 time, Water-Injection Rinse 1 time, Normal Rinse 2 times, Water-Injection Rinse 2 times, or None	-	Normal Rinse 1 time, Water-Injection Rinse 1 time, Normal Rinse 2 times, Water-Injection Rinse 2 times, or None		
Spin		3 min	6 min	6 min	6 min	6 min
		1, 3, 6, 9 min, or none	1, 3, 6, 9 min, or none	1, 3, 6, 9 min, or none	1, 3, 6, 9 min, or none	1, 3, 6, 9 min, or none
Required time (guide)	95XA	23 min	40 min	84 min	200 min	320 min
	90XA					
	85XA					
	80XA					







List of Programs

- The wash time and the spin time may change during the program depending on the weight and type of laundry being washed.
- The required times are guidelines. More time may be required than is noted here depending on the water pressure and the type of laundry.
- Programs cannot be changed after they are started. To change them, turn the power off and then on again, then select a program.
- We do not recommend using fabric softener when the Water Save program is selected.
- The Water Save program cycle is the recommended program cycle for a normally soiled load of laundry at the rated capacity.
- Spin Shower Rinse* is used in the Fuzzy program to enhance water-saving performance without compromising the efficiency of rinsing.
* Spin Shower Rinse: A powerful shower and centrifugal force rinse out detergent more effectively.
- The clear part of the lid and control panel may become foggy or may form dew on the edge of lid if you use hot water to wash your laundry, however, this is not abnormal. Wipe it off after washing your laundry.
- It has the potential not to be enough for max load according to the kind of clothes.
- Even if you set the delay timer, it may start soon according to the required time of the program.
- Water flow is adjusted automatically according to the amount of load and water level. When loads are heavy and water level are high, water flow is adjusted at slower rate to maintain the performance of washer.
- Amount of detergent is indicated according to following table as a guide.







	Load (guide)	Water Level	Detergent (guide)	Amount of detergent
(SF-95XA)	6~9.5 kg	50~65 L	1.0~1.2 cup	33~43 g
	4~6 kg	41~65 L	0.8~1.2 cup	27~43 g
(SF-90XA)	6~9 kg	50~65 L	1.0~1.2 cup	33~43 g
	4~6 kg	41~65 L	0.8~1.2 cup	27~43 g
(SF-85XA)	6~8.5 kg	50~63 L	1.0~1.2 cup	33~42 g
	4~6 kg	41~63 L	0.8~1.2 cup	27~42 g
(SF-80XA)	6~8 kg	50~60 L	1.0~1.1 cup	33~40 g
	4~6 kg	41~60 L	0.8~1.1 cup	27~40 g
	2~4 kg	35~50 L	0.7~1.0 cup	23~35 g
	0~2 kg	32~44 L	0.6~0.8 cup	21~29 g

* Detergent is based on a single 35-gram scoop of powder detergent.
The amount of detergent is based on a type of 20-gram per 30-liter.
Since the required amount of detergent varies depending on the type of detergent, follow the instructions on the package of detergent.





Partial Operations Using the Fuzzy Program

If you want...	To customize the wash program	To reuse the wash water and separate your laundry	To not spin the laundry because you are worried about wrinkles
Operations	Wash ⇒ Rinse ⇒ Spin	Wash only	Wash ⇒ Rinse
Setting method			
1.	 <p>Power On/Off</p>	Turn on the power.	
2.	 <p>Fuzzy</p>	Select the Fuzzy program.	
3.	 <p>Water level</p>	Set the amount of water. If you do not set the amount of water, it is set automatically based on the weight of the laundry.	
4.	  	<ul style="list-style-type: none"> ■ Set the wash time with the Wash button. ■ Set the number and type of rinses with the Rinse button. ■ Set the spin time with the Spin button. 	<ul style="list-style-type: none"> ■ Set the wash time with the Wash button. ■ Set the number and type of rinses with the Rinse button.
5.	 <p>Start/Pause</p>	Press the Start/Pause button to start.	
Remarks	Operates according to the wash, rinse, and spin settings.	Stops while the wash water is still in the tub.	Stops while the rinse water is still in the tub.

Partial Operations Using the Fuzzy Program

If you want...	To rinse only	To rinse and spin	To drain and spin
Operations	Rinse only	Rinse ⇒ Spin	Drain ⇒ Spin
Setting method			
1.		Turn on the power.	
2.		Select the Fuzzy program.	
3.		Set the amount of water. If the amount of water is not set, then maximum water level is used.	Cannot be used.
4.	  	<ul style="list-style-type: none"> ■ Set the number and type of rinses with the Rinse button. 	<ul style="list-style-type: none"> ■ Set the number and type of rinses with the Rinse button. ■ Set the spin time with the Spin button.
5.		Press the Start/Pause button to start.	
Remarks	Drains water and spins before rinsing. Stops while the rinse water is still in the tub.	Drains water and spins before rinsing.	Drains water and spins.

Partial Operations Using the Fuzzy Program

■ Repeatedly press the     buttons until the water level, wash, rinse, and spin settings you want are set. If the indicator is not lit, that operation is not performed.

■ You can set the amount of water each time you press the Water Level button in a range from 20 to 65 L.

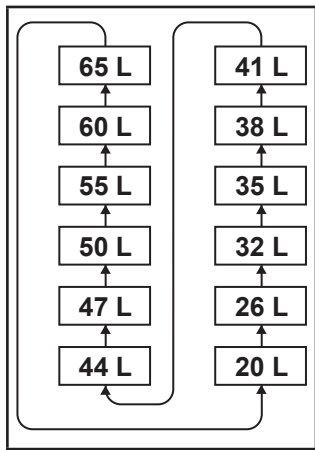

SF-95XA

■ You can set the amount of water each time you press the Water Level button in a range from 20 to 65 L.

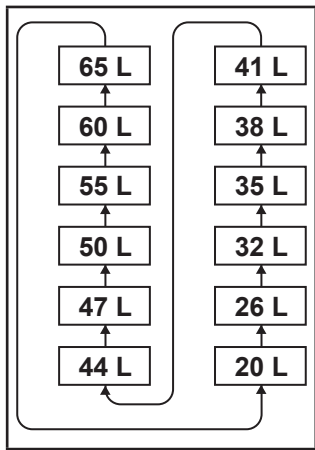

SF-90XA

■ You can set the amount of water each time you press the Water Level button in a range from 20 to 63 L.

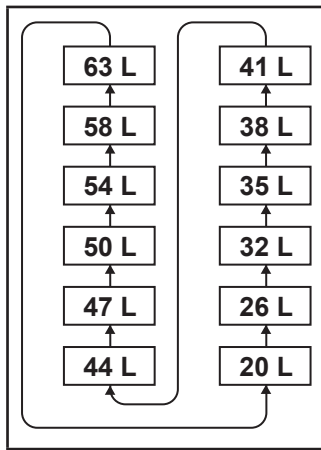

SF-85XA

■ You can set the amount of water each time you press the Water Level button in a range from 20 to 60 L.

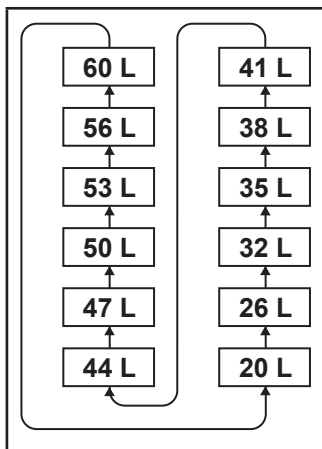

SF-80XA

Partial Operations Using the Fuzzy Program

- You can set the wash time each time you press the Wash button in a range from 3 to 18 minutes and no washing.

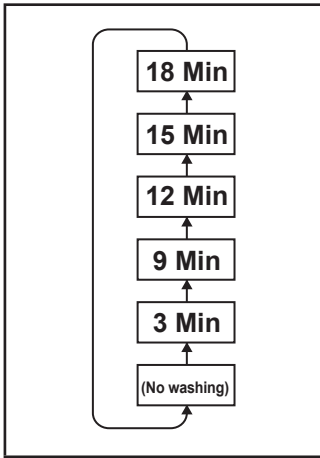

- You can set the number and type of rinses by pressing the Rinse button. Each time you press the Rinse button the setting changes in sequence, from Normal Rinse 2 times, Water-Injection Rinse 2 times, no rinsing, Normal Rinse 1 time, Water-Injection Rinse 1 time.

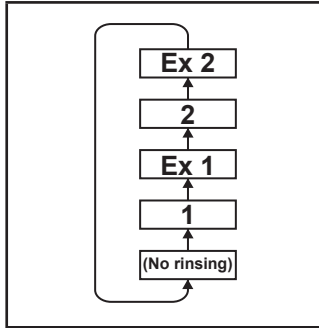

- You can set the spin time each time you press the Spin button in a range of 1 to 9 minutes and no spinning.

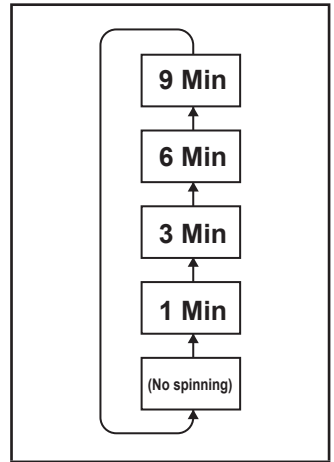

In Case of Power Outage

If there is a power outage

The washing machine is equipped with a restart function. If a power outage occurs while the washing machine is operating, the cycle (i.e., wash, rinse, or spin) at that time is saved, and when the power is restored, automatically restart from the interrupted cycle. If there is a power outage during the operation, the lid is locked and cannot be opened. After the power is restored, the lock is released.

Care and Maintenance

Cleaning the lint filter (cassette type)

1. Press down on the knob on the top of the lint filter (cassette type) and pull it towards you.
2. Open the lint filter (cassette type) to the sides and remove the lint that is inside.
3. Reverse the procedure to replace the lint filter (cassette type).

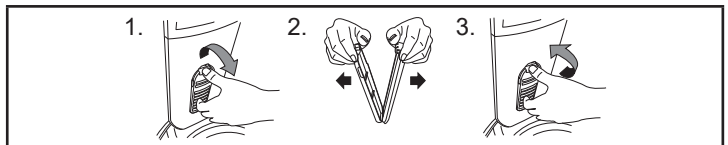

Care and Maintenance

Cleaning the water supply inlet

1. Close the tap.
2. Disconnect the water supply hose from the top of the washing machine. (Water in the hose may be drained when you disconnect the hose.)
3. Use a brush or something to clean the water supply inlet of the washing machine.
4. Reverse the procedure to replace the water supply hose.

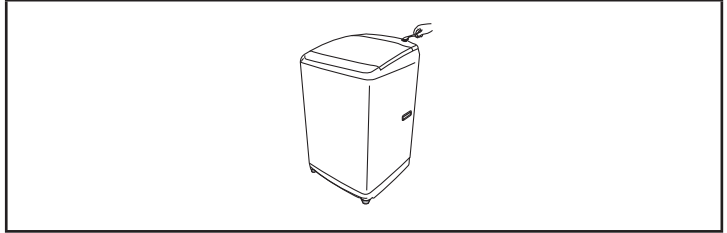

Maintenance of softener dispenser

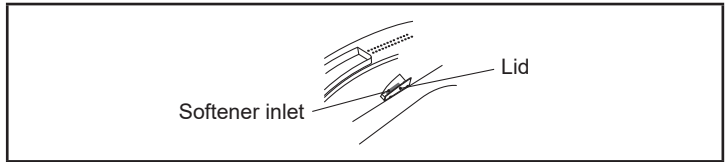

- If there is a softener remaining in the softener inlet, wash away with water. Rub with toothbrush if necessary.
- If the softener congealed in the dispenser, pour warm water (about 40°C) into it and dissolve the softener.

Care and maintenance of the washing machine

- Clean the machine body.
Wipe the outside of the washing machine with a soft cloth. Do not use solvents such as alcohol or benzene.
- If you use a chemically treated cloth, use it according to the instructions for the product.
- If detergent or softener gets on the washing machine, quickly wipe it off. The surface could be damaged.

Troubleshooting

Problem	Possible cause
Does not operate	<ul style="list-style-type: none"> ● The power plug is not inserted in the power outlet. ● There is a power outage. ● The Delay Timer has been set.
It is wet, even though it is the first time to use it (drain hose, tub, etc.)	<ul style="list-style-type: none"> ● There may be moisture or water left in the tub or hoses from the performance test before shipping from the factory.
The remaining time increases during operation	<ul style="list-style-type: none"> ● The remaining time is adjusted to compensate for the speed of the incoming water.
Water is added again during the washing process	<ul style="list-style-type: none"> ● Water is added automatically up to the set water level if the water level falls because water is absorbed by the laundry.
Wash time is longer than the time that was set manually	<ul style="list-style-type: none"> ● If the water pressure is low, the operating time may increase due to a longer water supply time.
The washing machine stops during the spin cycle and starts adding water	<ul style="list-style-type: none"> ● If the laundry is extremely off balance when the spin cycle starts, the spin cycle stops and the rinse cycle starts to rebalance the laundry. After the load is rebalanced, the spin cycle starts again.
During the spin cycle, the tub spins increasingly faster	<ul style="list-style-type: none"> ● This is to more efficiently remove water.
Sound of water is heard when the tub moves	<ul style="list-style-type: none"> ● That is the sound of water in the Liquid Load Balancer, which is used for balancing when the tub is spinning.
The lid does not open	<ul style="list-style-type: none"> ● When the lid lock indicator is lit, the lid is locked and cannot be opened. ● The lid is locked and cannot be opened because there was a power outage or the power was turned off while the lid lock indicator was lit. Turn on the power and wait for the lock to be released.
The strength of water flow does not change in spite of changing the indicator	<ul style="list-style-type: none"> ● It may not change the strength of water flow according to the process and the load amount. It is not abnormal.

Error Codes

Error code	Description	Things to check	Solution
C1	Water is not supplied	<ul style="list-style-type: none"> ● Is the tap open? ● Has dirt collected in the water supply inlet filter? ● Are the water pipes or water supply hose frozen? ● Has the water supply been disrupted? 	Check the tap, water supply inlet filter, water pipes, and water supply hose.
C2	Water does not drain	<ul style="list-style-type: none"> ● Is the drain hose blocked? ● Is the drain hose twisted, crushed, or frozen? ● Is the drain hose connected correctly? ● Is the drain outlet too high? 	Check the drain hose and the drain outlet.
C3	The tub does not spin	<ul style="list-style-type: none"> ● Is the lid open? 	Close the lid.
C4		<ul style="list-style-type: none"> ● Is the laundry all on one side of the tub? ● Does the laundry include too many thick items like cotton blankets or jeans or too many large items like sheets? ● Is the washing machine wobbling, or is the floor under the washing machine slanted? ● Are there any unwashable things in the tub? →Page 8: Preparation of the laundry (sorting the laundry) 	Add a few more items to wash. (If there is only one item in the tub, it is likely to become unbalanced.)
C8	The lid cannot be locked	<ul style="list-style-type: none"> ● Is the lid closed? ● Are there any foreign objects in the lock? 	Check that the lid is completely closed. Check that there are no foreign objects in the lock.
C9	The lid lock cannot be released	<ul style="list-style-type: none"> ● Are there any foreign objects in the lock? 	Turn the power off and then on again and wait a little while. If the lid is still locked, contact a service center for repair.
Ch	The spinning speed does not reach the specified value.	<ul style="list-style-type: none"> ● Check if there is too much powder detergent? ● Check if the drain hose is clogged? ● Check if the drain hose is installed correctly? 	Check the amount of powder detergent used. Check the drain hose and its installation.

- If warning sign such as “F0”, “F9”...etc. are shown in the display, stop operating the washer immediately and contact an authorized service dealer or a service agent for further inspection and/or repairing.

How to Install the Washing Machine

Safety precautions

- Do not use a damaged power plug, doing so is dangerous. Contact a repair center that is certified by the manufacturer to replace the plug.
- If the outlet you are using is a 2-pin outlet, use an adapter to change from three pins to two pins. If you do this, be sure to connect an earth wire. There are risk of electric shock, electronic substrate and electronic parts damage if you do not connect an earth wire.
- Do not connect an earth wire to a gas pipe, telephone wire, water pipe, or lightning rod. Remove the power plug from the electric outlet when you are attaching an earth wire.
- You do not need to attach an earth wire if the electric outlet is a 3-pin type with earth terminal.

Where to install the washing machine

- The hoses may be damaged or rupture if they freeze. Do not install the washing machine outside or any other place where there is a risk of freezing.
- Install the washing machine on a solid level floor to avoid excessive vibration and noise.
- Do not install the washing machine in an extremely humid place, such as a bathroom or a place exposed to rain.
- Do not install the washing machine in a slippery or unstable location. Doing so could cause abnormal vibration.
- Install the washing machine away from walls as shown below to avoid abnormal noise and vibration.

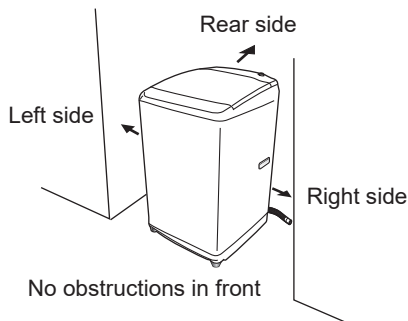

Area	Clearance (cm)
Left	1.5*
Right	1.5*
Rear	1.5

* Should be 9 cm or more for the side with the drain hose.

How to Install the Washing Machine

Installing the drain hose

1. Lay the washing machine down on its back.
2. Install the rat guard between outside lock and inside lock as shown in the illustration.
3. Attach screws.
4. Pull the drain hose out of the washing machine.
5. Insert the narrow part of the drain hose into the clamp on the washing machine.
6. Stand the washing machine up.

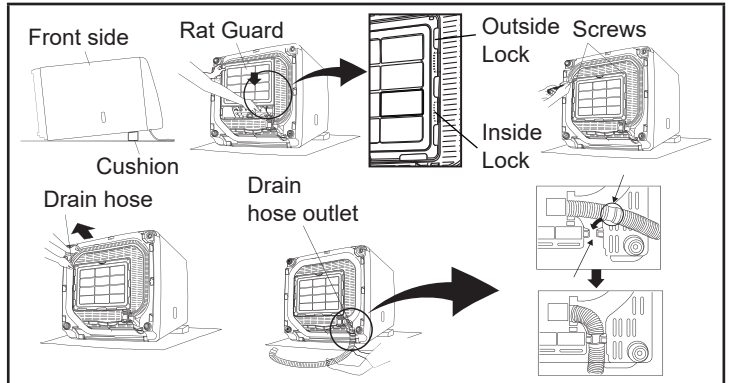

7. Insert the end of the drain hose into the drain hose outlet.
 - Do not allow the drain hose to be bent, twisted, pulled out and damaged, stepped on, or crimped.
 - Spread a cloth on the ground before laying the washing machine down on its back to prevent damaging it.
 - Use a knife to cut the end of the drain hose at a 45 degree angle because if the drain channel is shallow and the end of the drain hose is blocked, it could cause a malfunction.

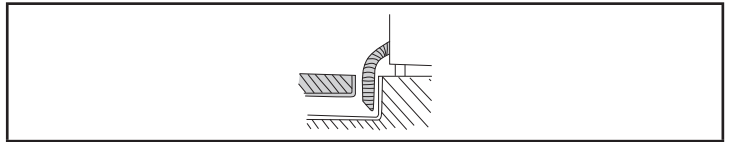

- Keep the top of the drain hose no more than 10 cm above the floor if it crosses a door sill or something else. If it is higher than this, the water has difficulty draining and a "C2" error (water does not drain) may occur.
- Do not extend the drain hose more than 2 meters from the washing machine.

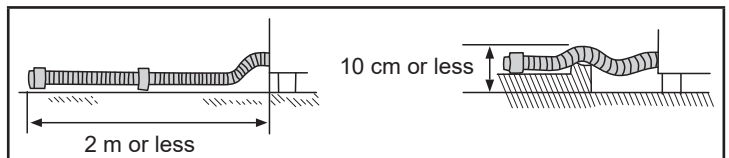

How to Install the Washing Machine

Connecting to the tap

- **Water supply hose**

- The optimum water pressure is 0.03 to 0.8 MPa.
- Use a horizontal tap.



Connect the water supply hose to the water supply inlet on the washing machine.

Check that the rubber seal is in the hose connector.

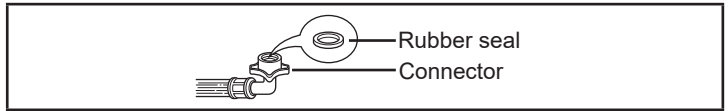

* Water supply hose for screw type tap is optional (Part No.BD-W80MV 151)

Securely fasten the water supply hose to the tap and be sure there is no water leakage.

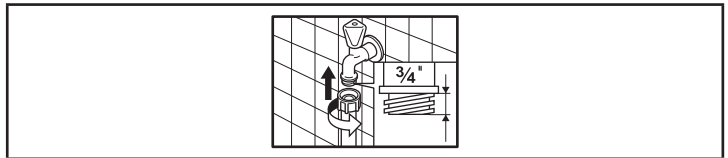

How to Install the Washing Machine

* Water supply hose with one-touch joint

1. Loosen the top connector.

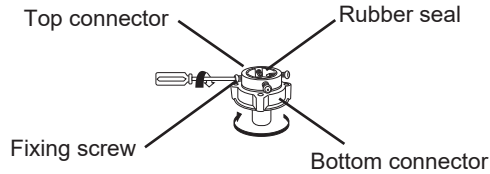

- If the diameter of the tap is larger than the connector ring, remove the ring.

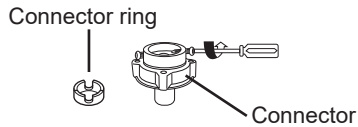

2. Press up on the top connector so the rubber seal and the tap are firmly sealed. Next, tighten the 4 screws.

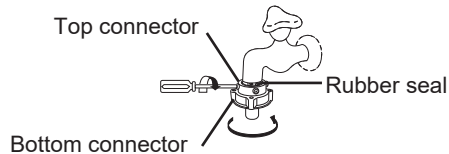

- Rotate the bottom connector so there is no water leakage.
- Close the tap so you can remove the water supply hose from the bottom connector. Next, pull off the hose and lower the clasp.

3. Attach the water supply hose to the bottom connector and lower the clasp.

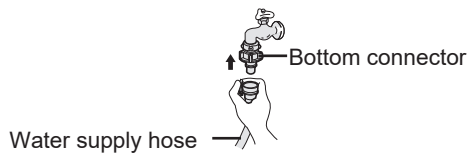

- Make sure the union nut between the water supply hose and the washing machine is firmly tightened.
- Before operating the washing machine, open the tap to confirm that the water supply hose is correctly connected. If the union nut is loose water will leak.

How to Install the Washing Machine

Connecting the power

- Connect the washing machine correctly to a grounded AC power supply.
- The voltage of the power supply must match the voltage rating of the washing machine.
- Do not use extension cords or overload the power outlet by using power strips.

Checking levelness

- Be sure the washing machine does not wobble.
- Use the spirit level on the washing machine to check for levelness. Adjust the adjustable foot if the washing machine is not level.

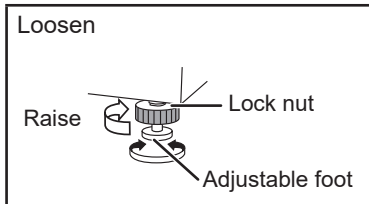

Rotate the lock nut in the direction of the arrow to loosen it and then rotate the adjustable foot to stabilize the washing machine.

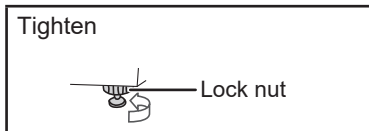

When the adjustment is finished, rotate the lock nut in the direction of the arrow to tighten it.

Checking after installation

If any of the following problems or other abnormalities occur, immediately unplug the power plug and contact your local service center.

- The washing machine does not operate when the power is turned on.
- The power cord is damaged.
- There are abnormal vibrations or sounds during operation.
- There is a smell of burning.

Customer Service

If the washing machine malfunctions, check the Operating & Installation Instructions thoroughly before you call for repairs.

If you are unable to identify or solve the problem, contact your local service center.

When you call the service center, you will need to tell them the model of the washing machine, describe the malfunction, and give them your address and phone number.

Specifications

Model	SF-95XA
Maximum mass of dry cloth	9.5 kg
Power supply	See the rating plate on the back of the washing machine.
Standard water level	65 L (maximum water level)
Standard amount of water used	110 L (Fuzzy program operation)
Water pressure	0.03 to 0.8 MPa (0.3 to 8 Kgf/cm ²)
Dimensions / Weight	Width 590 mm x Depth 600 mm x Height 1002 mm / 34 kg

Model	SF-90XA
Maximum mass of dry cloth	9 kg
Power supply	See the rating plate on the back of the washing machine.
Standard water level	65 L (maximum water level)
Standard amount of water used	110 L (Fuzzy program operation)
Water pressure	0.03 to 0.8 MPa (0.3 to 8 Kgf/cm ²)
Dimensions / Weight	Width 590 mm x Depth 600 mm x Height 1002 mm / 34 kg

Model	SF-85XA
Maximum mass of dry cloth	8.5 kg
Power supply	See the rating plate on the back of the washing machine.
Standard water level	63 L (maximum water level)
Standard amount of water used	107 L (Fuzzy program operation)
Water pressure	0.03 to 0.8 MPa (0.3 to 8 Kgf/cm ²)
Dimensions / Weight	Width 590 mm x Depth 600 mm x Height 1002 mm / 34 kg

Model	SF-80XA
Maximum mass of dry cloth	8 kg
Power supply	See the rating plate on the back of the washing machine.
Standard water level	60 L (maximum water level)
Standard amount of water used	104 L (Fuzzy program operation)
Water pressure	0.03 to 0.8 MPa (0.3 to 8 Kgf/cm ²)
Dimensions / Weight	Width 590 mm x Depth 600 mm x Height 1002 mm / 34 kg

Free Manuals Download Website

<http://myh66.com>

<http://usermanuals.us>

<http://www.somanuals.com>

<http://www.4manuals.cc>

<http://www.manual-lib.com>

<http://www.404manual.com>

<http://www.luxmanual.com>

<http://aubethermostatmanual.com>

Golf course search by state

<http://golfingnear.com>

Email search by domain

<http://emailbydomain.com>

Auto manuals search

<http://auto.somanuals.com>

TV manuals search

<http://tv.somanuals.com>