

Contents

Motorcycle Safety P. 2

Operation Guide P. 20

Maintenance P. 73

Troubleshooting P. 135

Information P. 159

Specifications P. 183

Index P. 187

Welcome

Congratulations on your purchase of a new Honda motorcycle. Your selection of a Honda makes you part of a worldwide family of satisfied customers who appreciate Honda's reputation for building quality into every product.

To ensure your safety and riding pleasure:

- Read this owner's manual carefully.
- Follow all recommendations and procedures contained in this manual.
- Pay close attention to safety messages contained in this manual and on the motorcycle.

To protect your investment, we urge you to take responsibility for keeping your motorcycle well serviced and maintained. Also, observe the break-in guidelines, and always perform the pre-ride inspection and other periodic checks in this manual.

When service is required, remember that your Honda dealer knows your motorcycle best. If you have the required mechanical "know-how" and tools, you can purchase an official Honda Service Manual to help you perform many maintenance and repair tasks. ≥ P. 177

Read the warranty information thoroughly so that you understand the warranty coverage and that you are aware of your rights and responsibilities. ≥ P. 178

You may also want to visit our website at www.powersports.honda.com.

Canada www.honda.ca.

Happy riding!

California Proposition 65 Warning

WARNING: This product contains or emits chemicals known to the State of California to cause cancer and birth defects or other reproductive harm.

A Few Words About Safety

Your safety, and the safety of others, is very important. Operating this motorcycle safely is an important responsibility.

To help you make informed decisions about safety, we have provided operating procedures and other information on safety labels and in this manual. This information alerts you to potential hazards that could hurt you or others.

Of course, it is not practical or possible to warn you about all hazards associated with operating or maintaining a motorcycle. You must use your own good judgment.

You will find important safety information in a variety of forms, including:

- Safety labels on the motorcycle
- Safety Messages preceded by a safety alert symbol  and one of three signal words: DANGER, WARNING, or CAUTION.

These signal words mean:

3 DANGER

You **WILL** be **KILLED** or **SERIOUSLY HURT** if you don't follow instructions.

3 WARNING

You **CAN** be **KILLED** or **SERIOUSLY HURT** if you don't follow instructions.

3 CAUTION

You **CAN** be **HURT** if you don't follow instructions.

Other important information is provided under the following titles:

NOTICE Information to help you avoid damage to your motorcycle, other property, or the environment.

Motorcycle Safety

This section contains important information for safe riding of your motorcycle.
Please read this section carefully.

Safety Guidelines.....	P. 3
Safety Labels.....	P. 8
Safety Precautions.....	P. 10
Riding Precautions	P. 12
Accessories & Modifications.....	P. 17
Off-Road Safety	P. 18
Loading	P. 19

Safety Guidelines

Follow these guidelines to enhance your safety:

- Perform all routine and regular inspections specified in this manual.
- Stop the engine and keep sparks and flame away before filling the fuel tank.
- Do not run the engine in enclosed or partly enclosed areas. Carbon monoxide in exhaust gases is toxic and can kill you.

Always Wear a Helmet

It's a proven fact: helmets and protective apparel significantly reduce the number and severity of head and other injuries. So always wear an approved motorcycle helmet and protective apparel. 2 P. 10

Before Riding

Make sure that you are physically fit, mentally focused and free of alcohol and drugs. Check that you and your passenger are both wearing an approved motorcycle helmet and protective apparel. Instruct your passenger on holding onto the grab rail or your waist, leaning with you in turns, and keeping their feet on the footpegs, even when the motorcycle is stopped.

Take Time to Learn & Practice

Even if you have ridden other motorcycles, practice riding in a safe area to become familiar with how this motorcycle works and handles, and to become accustomed to the motorcycle's size and weight.

We recommend that all riders take a certified course approved by the Motorcycle Safety Foundation (MSF). New riders should start with the basic course, and even experienced riders will find the advanced course beneficial.

For information about the MSF training course nearest you, call the national toll-free number: (800) 446-9227.

USA Other riding tips can be found in the You and Your Motorcycle Riding Tips booklet that came with your motorcycle.

Developing off-road riding skill is a gradual step-by-step process. Start by practicing at low speeds in a safe area and slowly build your skills.

Ask your dealer if there are off-road riding groups in your area where you can learn from experienced riders. Also be sure to read Tips & Practice Guide for the Off-Highway Motorcyclist that came with your new motorcycle.

Ride Defensively

Always pay attention to other vehicles around you, and do not assume that other drivers see you. Be prepared to stop quickly or perform an evasive maneuver.

Make Yourself Easy to See

Make yourself more visible, especially at night, by wearing bright reflective clothing, positioning yourself so other drivers can see you, signaling before turning or changing lanes, and using your horn when necessary.

Be Alert for Off-road Hazards

The terrain can be present a variety of challenges when you ride off-road. Continually “read” the terrain for unexpected turns, drop-offs, rocks, ruts and other hazards. Always keep your speed low enough to allow time to see and react to hazards.

Ride within Your Limits

Never ride beyond your personal abilities or faster than conditions warrant. Fatigue and inattention can impair your ability to use good judgment and ride safely.

Don't Drink and Ride

Alcohol and riding don't mix. Even one alcoholic drink can reduce your ability to respond to changing conditions, and your reaction time gets worse with every additional drink. Don't drink and ride, and don't let your friends drink and ride either.

Keep Your Honda in Safe Condition

It's important to keep your motorcycle properly maintained and in safe riding condition. Having a breakdown can be difficult, especially if you are stranded off-road far from your base. Inspect your motorcycle before every ride and perform all recommended maintenance. Never exceed load limits (2 P. 19), and do not modify your motorcycle or install accessories that would make your motorcycle unsafe (2 P. 17).

If You are Involved in a Crash

Personal safety is your first priority. If you or anyone else has been injured, take time to assess the severity of the injuries and whether it is safe to continue riding. Call for emergency assistance if needed. Also follow applicable laws and regulations if another person or vehicle is involved in the crash.

If you decide to continue riding, first turn the ignition switch to the OFF position, and evaluate the condition of your motorcycle. Inspect for fluid leaks, check the tightness of critical nuts and bolts, and check the handlebar, control levers, brakes, and wheels. Ride slowly and cautiously.

Your motorcycle may have suffered damage that is not immediately apparent. Have your motorcycle thoroughly checked at a qualified service facility as soon as possible.

Emergency Shut-down Procedure for Motorcycles Equipped with Dual Clutch Transmission

CRF1000D

Unlike standard motorcycles, or its manual transmission sibling, the CRF1000D with dual-clutch transmission does not have a clutch lever that would provide you with an additional means to control the engine power being transmitted to the rear wheel. Thus, in the unlikely event that you experience a stuck throttle or other unintended application of power to the rear wheel, you should shut down the engine by use of the engine stop switch (2 P. 51). By moving this switch to the  (Off) position, you will immediately stop the engine but maintain all electrical system functions, including lights and indicators.

Carbon Monoxide Hazard

Exhaust contains poisonous carbon monoxide, a colorless, odorless gas. Breathing carbon monoxide can cause loss of consciousness and may lead to death.

If you run the engine in confined or even partly enclosed area, the air you breathe could contain a dangerous amount of carbon monoxide.

Never run your motorcycle inside a garage or other enclosure.

3 WARNING

Running the engine of your motorcycle while in an enclosed or even partially enclosed area can cause a rapid build-up of toxic carbon monoxide gas.

Breathing this colorless, odorless gas can quickly cause unconsciousness and lead to death.

Only run your motorcycle's engine when it is located in a well ventilated area outdoors.

Safety Labels

Safety and information labels on your motorcycle provide important safety information and may warn you of potential hazards that could cause serious injury. Read these labels carefully and don't remove them.

If a label comes off or becomes hard to read, contact your dealer for a replacement.

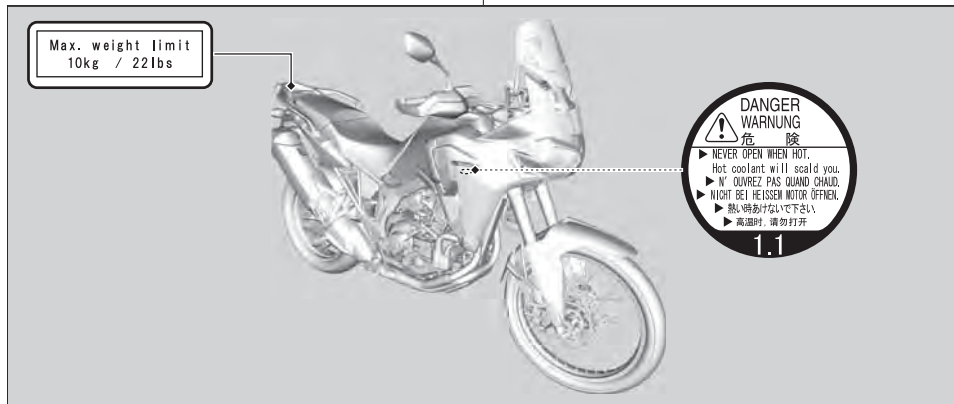

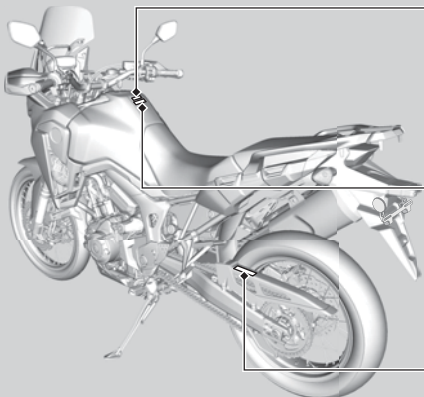

For your protection, always wear your helmet while riding.
Read the owner's manual carefully.

⚠ WARNING

Improper loading can cause a crash and you may be seriously hurt or killed.
See "Load Limits and Guidelines" in your Owner's Manual for complete instructions.

TIRE INFORMATION

		kPa	kgf/cm ²	psi
Cold tire pressures				
Up to maximum weight capacity	Front	200	2,00	29
	Rear	280	2,80	41
Up to 90kg(200lbs) load	Front	200	2,00	29
	Rear	250	2,50	36
Tire size				
Front		150/70R18M/C 70H		
Rear		90/90-21M/C 54H		
Min. recommend tire center tread depth.				
Front		1,5mm (0,06in.)		
Rear		2,0mm (0,08in.)		
Maximum weight capacity		178kg(392lbs)		

DRIVE CHAIN

Keep chain adjusted and lubricated 40 mm (1 5/8 in.) Freeplay



Read owner's manual.

Safety Precautions

- Ride cautiously and keep your hands on the handlebar and feet on the footpegs.
- Keep passenger's hands onto the grab rail or your waist, passenger's feet on the footpegs while riding.
- Always consider the safety of your passenger, as well as other drivers and riders.

Protective Apparel

Make sure that you and any passenger are wearing an approved motorcycle helmet, eye protection, and high-visibility protective clothing. Ride defensively in response to weather and road conditions.

Helmet

Should be safety-standard certified, high-visibility, and correct size for your head.

- Must fit comfortably but securely, with the chin strap fastened.
- Face shield with unobstructed field of vision or other approved eye protection.

USA Look for a DOT (Department of Transportation) certification label on any helmet you buy.

3 WARNING

Not wearing a helmet increases the chance of serious injury or death in a crash.

Make sure that you and any passenger always wear an approved helmet and protective apparel.

■ Gloves

Full-finger leather gloves with high abrasion resistance.

■ Boots or Riding Shoes

Sturdy boots with non-slip soles and ankle protection.

■ Jacket and Pants

Protective, highly visible, long-sleeved jacket and durable long pants for riding (or a protective suit).

■ Additional Off-road Gear

On-road apparel may also be suitable for casual off-road riding. But if you plan on any serious off-road riding you will need more serious off-road gear. In addition to your helmet and eye protection, we recommend off-road motorcycle boots and gloves, riding pants with knee and hip pads, a jersey with elbow pads, and a chest/shoulder protector.

Riding Precautions

Break-in Period

During the first 300 miles (500 km) of running, follow these guidelines to ensure your motorcycle's future reliability and performance.

- Avoid full-throttle starts and rapid acceleration.
- Avoid hard braking and rapid down-shifts.
- Ride conservatively.

Brakes

Observe the following guidelines:

- Avoid excessively hard braking and downshifting.
 - ⌋ Sudden braking can reduce the motorcycle's stability.
 - ⌋ Where possible, reduce speed before turning; otherwise you risk sliding out.
- Exercise caution on low traction surfaces.
 - ⌋ The tires slip more easily on such surfaces and braking distances are longer.
- Avoid continuous braking.
 - ⌋ Repeated braking, such as when descending long, steep slopes can seriously overheat the brakes, reducing their effectiveness. Use engine braking with intermittent use of the brakes to reduce speed.
- For full braking effectiveness, operate both the front and rear brakes together.

| Anti-lock Brake System (ABS)

This model is equipped with an Anti-lock Brake System (ABS) designed to help prevent the brakes from locking up during hard braking.

- ABS does not reduce braking distance. In certain circumstances, ABS may result in a longer stopping distance.
- ABS does not function at speeds below 6 mph (10 km/h).
- The brake lever and pedal may recoil slightly when applying the brakes. This is normal.
- Always use the recommended front/rear tires and sprockets to ensure correct ABS operation.

| Engine Braking

Engine braking helps slow your motorcycle down when you release the throttle. For further slowing action, downshift to a lower gear. Use engine braking with intermittent use of the brakes to reduce speed when descending long, steep slopes.

| Wet or Rainy Conditions

Road surfaces are slippery when wet, and wet brakes further reduce braking efficiency. Exercise extra caution when braking in wet conditions.

If the brakes get wet, apply the brakes while riding at low speed to help them dry.

Parking

- Park on a firm, level surface.
- If you must park on a slight incline or loose surface, park so that the motorcycle cannot move or fall over.
- Make sure that high-temperature parts cannot come into contact with flammable materials.
- Do not touch the engine, muffler, brakes and other high-temperature parts until they cool down.
- To reduce the likelihood of theft, always lock the handlebar and remove the key when leaving the motorcycle unattended. Use of an anti-theft device is also recommended.

Parking with the Side Stand

1. Stop the engine.
2. Push the side stand down.
3. Slowly lean the motorcycle to the left until its weight rests on the side stand.
4. Turn the handlebar fully to the left.
 - ⊃ Turning the handlebar to the right reduces stability and may cause the motorcycle to fall.
5. Turn the ignition switch to the LOCK position and remove the key. ≥ P. 52

Refueling and Fuel Guidelines

Follow these guidelines to protect the engine, fuel system and catalytic converter:

- Use only unleaded gasoline.
- Use recommended octane number. Using lower octane gasoline will result in decreased engine performance.
- Do not use fuels containing a high concentration of alcohol. \geq P. 176
- Do not use stale or contaminated gasoline or an oil/gasoline mixture.
- Avoid getting dirt or water in the fuel tank.

Honda selectable torque control

When the Honda selectable torque control (Torque Control) detects rear wheel spin during acceleration, the system will limit the amount of torque applied to the rear wheel based on the Torque Control level selected.

Torque Control will allow some wheel spin during acceleration at the lower Torque Control levels settings. Select a level that is appropriate for your skill and riding conditions.

Torque Control does not work during deceleration and will not prevent the rear wheel from skidding due to engine braking. Do not close the throttle suddenly, especially when riding on slippery surfaces.

Torque Control may not compensate for rough road conditions or rapid throttle operation. Always consider road and weather conditions, as well as your skills and condition, when applying throttle.

If your motorcycle gets stuck in mud, snow or sand, it may be easier to free it with the Torque Control temporarily switched off.

Temporarily turning off Torque Control also may help you maintain control and balance when riding on off-road terrain.

Always use the recommended tires and sprockets to ensure correct Torque Control operation.

Accessories & Modifications

We strongly advise that you do not add any accessories that were not specifically designed or approved for your motorcycle by Honda or make modifications to your motorcycle from its original design. Doing so can make it unsafe. Modifying your motorcycle may also void your warranty and make your motorcycle illegal to operate on public roads and highways. Before deciding to install accessories on your motorcycle be certain the modification is safe and legal.

3WARNING

Improper accessories or modifications can cause a crash in which you can be seriously hurt or killed.

Follow all instructions in this owner's manual regarding accessories and modifications.

Do not pull a trailer with, or attach a sidecar to, your motorcycle. Your motorcycle was not designed for these attachments, and their use can seriously impair your motorcycle's handling.

Off-Road Safety

Learn to ride in an uncongested off-road area free of obstacles before venturing onto unfamiliar terrain.

- Always obey local off-road riding laws and regulations.
- Obtain permission to ride on private property. Avoid posted areas and obey “NO Trespassing” signs.
- Ride with a friend on another motorcycle so that you can assist each other in case of trouble.
- Familiarity with your motorcycle is critically important should a problem occur far from help.
- Never ride beyond your ability and experience or faster than conditions warrant.
- If you are not familiar with the terrain, ride cautiously. Hidden rocks, holes, or ravines could spell disaster.

- A muffler is required in most off-road areas. Don't modify your exhaust system. Remember that excessive noise bothers everyone and creates a bad image for motorcycling.

Loading

- Carrying extra weight affects your motorcycle's handling, braking and stability. Always ride at a safe speed for the load you are carrying.
- Avoid carrying an excessive load and keep within specified load limits.

Maximum weight capacity / Maximum luggage weight ≥ P. 183

- Tie all luggage securely, evenly balanced and close to the center of the motorcycle.
- Do not place objects near the lights or the muffler.

Also follow these guidelines when you ride off-road on rough terrain:

- Do not carry a passenger.
- Keep cargo small and light weight. Make sure it cannot easily be caught on brush or other objects, and that it does not interfere with your ability to shift position to maintain balance and stability.

3 WARNING

Overloading or improper loading can cause a crash and you can be seriously hurt or killed.

Follow all load limits and other loading guidelines in this manual.

Parts Location

CRF1000A

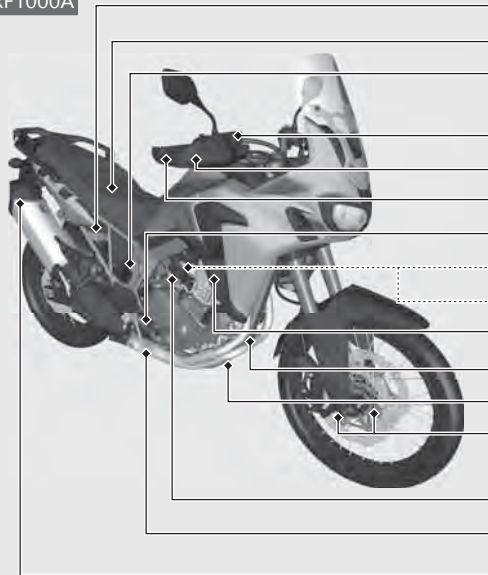

- Rear brake fluid reservoir ➔ P.112
- Document bag/Hex wrench ➔ P.71
- Rear suspension compression damping adjuster ➔ P.134
- Front brake fluid reservoir ➔ P.112
- Front brake lever ➔ P.128
- Throttle grip ➔ P.125
- Coolant reserve tank ➔ P.110
- Main fuse & FI fuse ➔ P.156
- ABS main fuse ➔ P.157
- Crankcase breather ➔ P.126
- Engine oil filter ➔ P.106
- Skid plate ➔ P.100
- Front suspension compression damping adjusters ➔ P.131
- Battery box cover ➔ P.97
- Rear brake pedal
- Spark arrester ➔ P.102

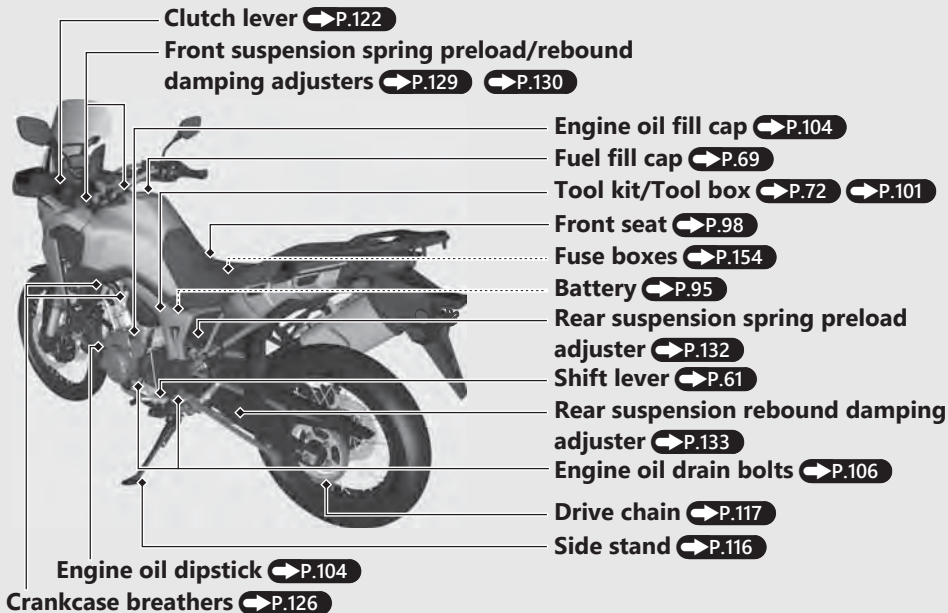

Parts Location *(Continued)*

CRF1000D

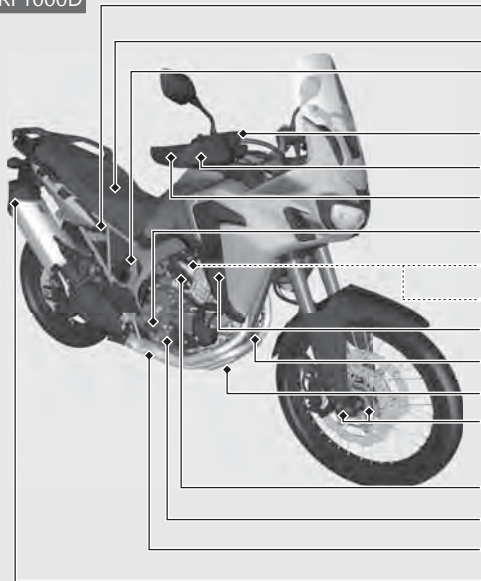

- Rear brake fluid reservoir ➔ P.112
- Document bag/Hex wrench ➔ P.71
- Rear suspension compression damping adjuster ➔ P.134
- Front brake fluid reservoir ➔ P.112
- Front brake lever ➔ P.128
- Throttle grip ➔ P.125
- Coolant reserve tank ➔ P.110
- Main fuse & FI fuse ➔ P.156
- ABS main fuse/DCT main fuse ➔ P.158
- Crankcase breather ➔ P.126
- Engine oil filter ➔ P.106
- Skid plate ➔ P.100
- Front suspension compression damping adjusters ➔ P.131
- Battery box cover ➔ P.97
- Clutch oil filter ➔ P.108
- Rear brake pedal
- Spark arrester ➔ P.102

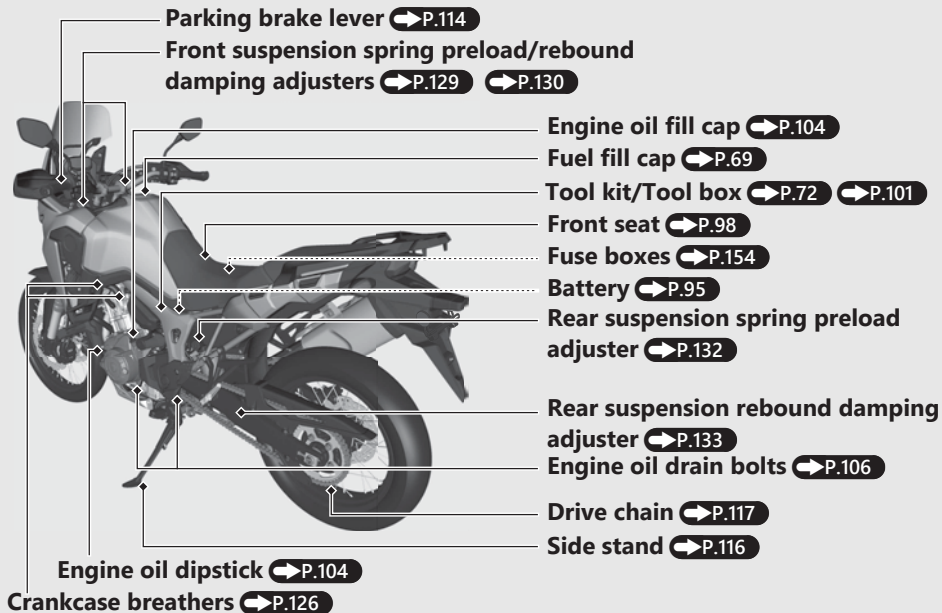

Instruments

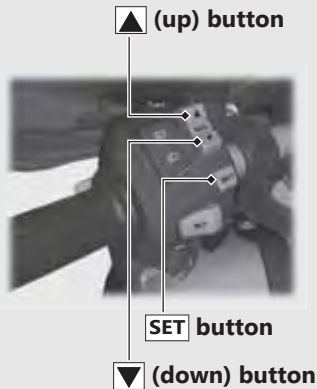

Display Check

When the ignition switch is turned to the ON position, all the mode and digital segments will show. If any part of these displays does not come on when it should, have your dealer check for problems.

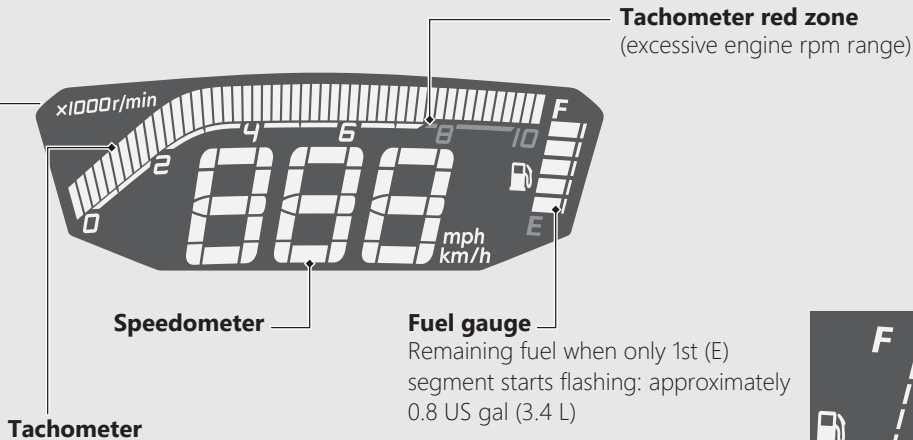

Tachometer

NOTICE

Do not operate the engine in the tachometer red zone. Excessive engine speed can adversely affect engine life.

Fuel gauge

Remaining fuel when only 1st (E) segment starts flashing: approximately 0.8 US gal (3.4 L)

At the same time, the available driving distance is displayed.

If the fuel gauge indicator flashes in a repeat pattern or turns off:

➔ P.142



Instruments (Continued)



Clock (12-hour display)

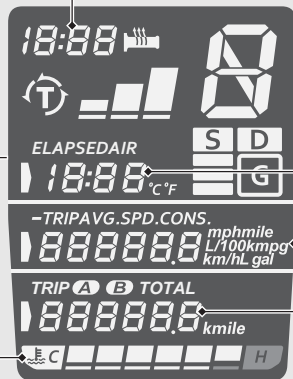

Coolant temperature gauge ()

When the coolant is over specified temperature, the 6th (H) segment flashes and high coolant temperature indicator lights. ➔ P.45



If the 6th (H) segment flashes while riding: ➔ P.137

If the coolant temperature gauge flashes sequentially or turns off: ➔ P.142

To select the trip time/air temperature gauge display, current fuel mileage/average fuel mileage/average speed/subtraction trip/amount of remaining fuel/available driving distance display and odometer/tripmeter display, press the **[SET]** button first, then the **[▲]** (up) button or the **[▼]** (down) button.

Press the **[SET]** button. The selected display is set.

Trip time [ELAPSED]/Air temperature gauge [AIR] display **➔P.30**

Current fuel mileage [CONS.]/Average fuel mileage [AVG. CONS.]/Average speed [AVG. SPD.]/Subtraction trip [-TRIP]/ Amount of remaining fuel/Available driving distance display **➔P.31**

Odometer [TOTAL] & Tripmeter [TRIP A/B] display **➔P.36**

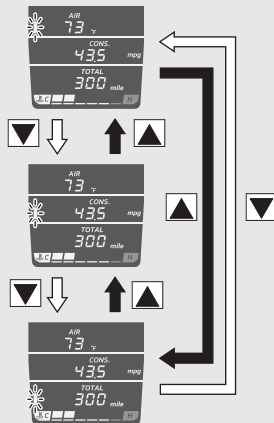

Instruments (Continued)

Torque Control level → P.56

S indicator

CRF1000D

Comes on when the S mode is selected in the AT MODE.

→ P.65

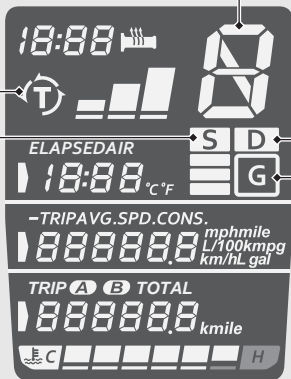

D indicator

CRF1000D

Comes on when the D mode is selected in the AT MODE.

→ P.65

G indicator

CRF1000D

Comes on when the G switch is turned on. → P.54

Gear position indicator



CRF1000A

The gear position is shown in the gear position indicator.

- ⌋ “-” appears when the transmission is not shifted properly.

CRF1000D

The gear position is shown in the gear position indicator when the D, S mode or MT MODE are selected.

- ⌋ “-” flashes when the engine stop switch position is changed from  (Run) to  (Off) position with the ignition switch in the ON position.
- ⌋ “-” flashes when the ignition switch is turned to the ON position with the engine stop switch  (Off) position.

The indicator may flash if:

- ⌋ The front wheel leaves the ground.
- ⌋ You turn the wheel while the motorcycle is upright on the stand.

This is normal. To operate the system again, turn the ignition switch to the OFF position, and then to the ON position again.

If the “-” indicator is blinking in the gear position window while riding:  P.141

Instruments *(Continued)*

Trip time [ELAPSED]/Air temperature gauge [AIR] display

The ▲ (up) or the ▼ (down) button selects between the air temperature gauge and the trip time when this display is selected.

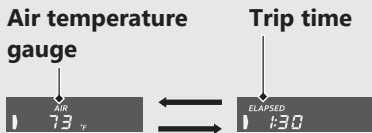

Air temperature gauge

Shows ambient temperature.

Display range: 14 to 122°F (–10 to 50°C)

- Below 14°F (–10°C): "--" is displayed
- Above 122°F (50°C): 122°F or 50°C flashes

The temperature readout may be incorrect at low speeds due to reflected heat.

Trip time

Shows operating time since the engine was started.

Display range: 0:00 to 19:59 (hours:minutes)

- The trip time return to 0:00 when the readout exceeds 19:59.

Current fuel mileage [CONS.]/Average fuel mileage [AVG. CONS.]/Average speed [AVG. SPD.]/Subtraction trip [-TRIP]/Amount of remaining fuel/Available driving distance display

The ▲ (up) or the ▼ (down) button selects the current fuel mileage, average fuel mileage, average speed, subtraction trip, available driving distance and amount of remaining fuel when this display is selected.

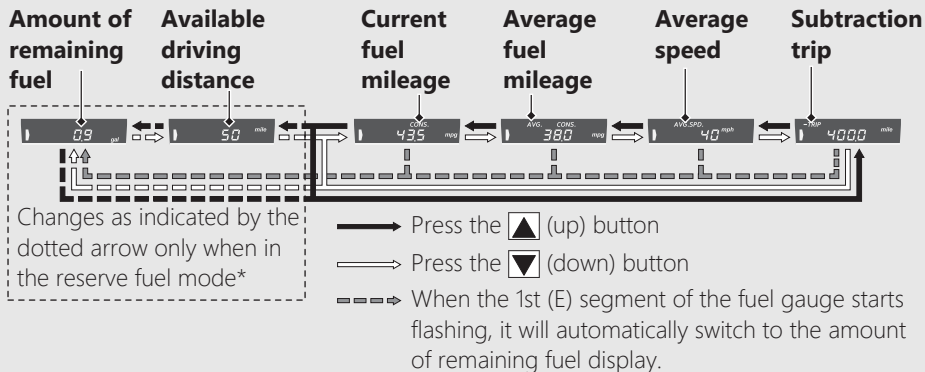

* Reserve fuel mode: When the 1st (E) segment of the fuel gauge flashes and the low fuel indicator lights, the available driving distance display and amount of remaining fuel display can be selected.

Instruments *(Continued)*

Current fuel mileage

Displays the current or instant fuel mileage. Display range: 0.1 to 99.9 mpg (L/100km or km/L)

- When your speed is less than 5 mph (7 km/h): "--.-" is displayed.
- Less than 0.1 mpg (L/100km or km/L) or more than 99.9 mpg (L/100km or km/L): "--.-" is displayed.

When "--.-" is displayed except for the above-mentioned cases, go to your dealer for service.

Average fuel mileage

Displays the average fuel mileage since the selected tripmeter was reset.

The average fuel mileage will be calculated based on value displayed on the tripmeter (A or B) selected. Also, the average fuel mileage for tripmeter A will be displayed when the odometer is selected.

Display range: 0.1 to 99.9 mpg (L/100km or km/L)

- Initial display: "--.-" is displayed.
- Less than 0.1 mpg (L/100km or km/L) or more than 99.9 mpg (L/100km or km/L): "--.-" is displayed.
- When the tripmeter A or B is reset: "--.-" is displayed.

When "--.-" is displayed except for the above-mentioned cases, go to your dealer for service.

To reset the average fuel mileage:

➡ P.37

Average speed

Displays the average speed since the selected tripmeter was reset.

The average speed will be calculated based on value displayed on the tripmeter (A or B) selected. Also, the average speed for tripmeter A will be displayed when the odometer is selected.

- Initial display: "---" is displayed.

When "---" is displayed while riding, go to your dealer for service.

To reset the average speed: ➡ P.37

Instruments *(Continued)*

Subtraction trip

Distance travelled is subtracted from a preset figure.

Setting range: 000.0 to 999.0 mile or km

- When the unit changed to "km" after setting the subtraction trip to "624 mile" or more with the unit set to "mile", "999.1 km" or more are displayed.

When the subtraction value reaches "-1000.0 mile" (-1600.0 km) while riding, the number will flash.

- If the display is switched to another indication when the subtraction value has reached "-1000.0 mile" (-1600.0 km) and the number is flashing, the number will no longer flash but just stay on when the display is returned to the subtraction trip.

- To reset the subtraction trip to the set value, press and hold the **SET** button while subtraction trip is displayed.



When "---.-" is displayed while riding, go to your dealer for service.

To set the subtraction trip: ➔ **P.42**

Available driving distance (only reserve fuel mode)

When the 1st (E) segment of the fuel gauge flashes, the estimated available driving distance is indicated.

Display range: 99 to 0 mile (km)

- Above 99 mile (km): "99" is displayed
- When the amount of remaining fuel is below 0.2 gal (1.0 L), "--" is displayed.
- When the battery reconnects during reserve fuel mode, "--" is displayed.

The indicated available driving distance is calculated based on the driving conditions, and the indicated figure may not always be the actual allowable distance. When the fuel gauge is near to E or when E segment blinks, fill fuel promptly.

When "--" is displayed except for the above-mentioned cases, go to your dealer for service.

Amount of remaining fuel (only reserve fuel mode)

When the 1st (E) segment of the fuel gauge flashes, the estimated amount of remaining fuel can be selected.

Display range: 0.8 to 0.2 gal (gallon) or 3.4 to 1.0 L (liters)

- Below 0.2 gal (1.0 L): "-.-" is displayed
- When the battery reconnects during reserve fuel mode, "-.-" is displayed.

The amount of remaining fuel is calculated from the driving conditions.

The indicated amount of remaining fuel may be different from the actual amount. When the fuel gauge is near to E or when E segment blinks, fill fuel promptly.

When "-.-" is displayed except for the above-mentioned cases, go to your dealer for service.

Instruments *(Continued)*

Odometer [TOTAL] & Tripmeter [TRIP A/B] display

The ▲ (up) or the ▼ (down) button selects the odometer, the tripmeter A and tripmeter B when this display is selected.

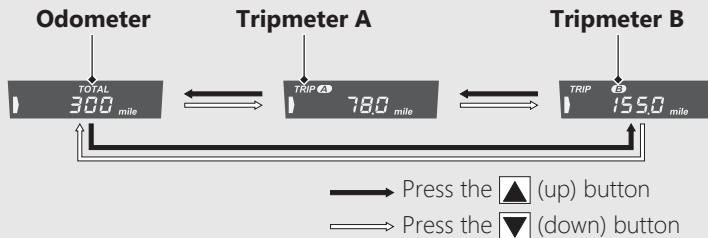

Odometer

Total distance ridden. When "-----" is displayed, go to your dealer for service.

Tripmeter A/B

Distance ridden since tripmeter was reset.

When "-----.-" is displayed, go to your dealer for service.

To reset the tripmeter: ➡ P.37

To reset the tripmeter, average fuel mileage and average speed

To reset tripmeter A, average fuel mileage and average speed (these are based on tripmeter A) together, press and hold the **SET** button while tripmeter A is displayed.

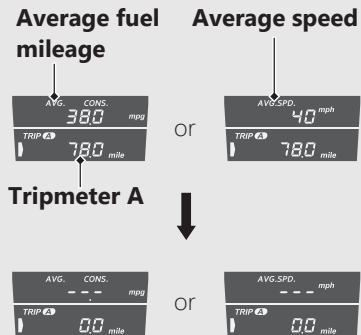

To reset tripmeter B, average fuel mileage and average speed (these are based on tripmeter B) together, press and hold the **SET** button while tripmeter B is displayed.

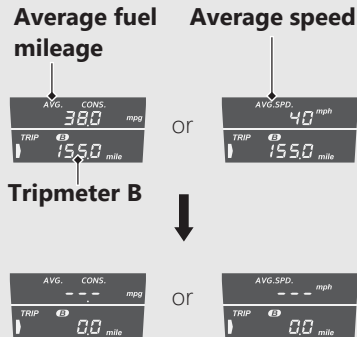

Instruments *(Continued)*

Display Setting

You can adjust the display settings.

- Clock setting
- Backlight brightness adjustment
- Changing the speed and mileage unit
- Changing the air temperature gauge unit
- Changing the fuel mileage meter unit
- Setting the subtraction trip

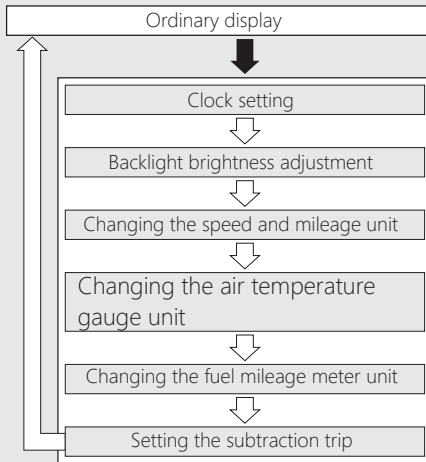

➡ Press and hold the ▼ (down) button and the **SET** button

➡ Press the **SET** button

If the ignition switch is turned to the OFF position or none of the **SET**, **▲**, **▼** buttons is pressed for about 30 seconds, the control is automatically switched from the setting mode to the ordinary display.

If the button is not pressed for about 30 seconds, items in the process of being set will be discarded and only items where settings have been finalised will be applied.

Only if the ignition switch is turned to the OFF position will items in the process of being set and those that are finalised be applied.

1 Clock setting:

- 1 Turn the ignition switch to the ON position.
- 2 Press and hold the **SET** button and the **▼** (down) button, the hour digits start flashing.
- 3 Press the **▲** (up) button or the **▼** (down) button until the desired hour is displayed.
 - ↳ Press and hold the **▲** (up) button or the **▼** (down) button to advance the hour fast.



- 4 Press the **SET** button. The minute digits start flashing.



Instruments *(Continued)*

- 5 Press the ▲ (up) button or the ▼ (down) button until the desired minute is displayed.
- ↳ Press and hold the ▲ (up) button or the ▼ (down) button to advance the minute fast.

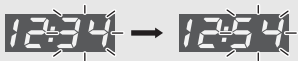

- 6 Press the SET button. The clock is set, and then the display moves to the backlight brightness adjustment.

2 Backlight brightness adjustment:

You can adjust the brightness to one of five levels.

- 1 Press the ▲ (up) button or the ▼ (down) button. The brightness is switched.

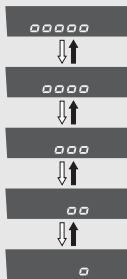

→ Press the ▲ (up) button

⇌ Press the ▼ (down) button

- 2 Press the SET button. The backlight is set, and then the display moves to the changing of the speed and mileage unit.

3 Changing the speed and mileage unit:

- 1 Press the ▲ (up) button or the ▼ (down) button to select either "mph" and "mile" or "km/h" and "km".

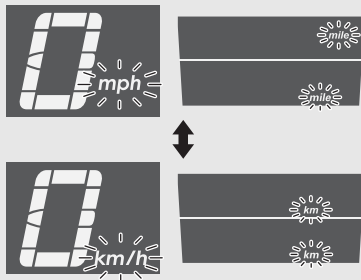

- 2 Press the **SET** button. The speed and mileage unit is set, and then the display moves to the changing of the coolant temperature gauge unit.

4 Changing the air temperature gauge unit:



- 1 Press the ▲ (up) button or the ▼ (down) button to select either "°F" or "°C".



- 2 When selecting the "mph" and "mile". Press the **SET** button. The air temperature gauge unit is set, and then the display moves to the changing of the setting of subtraction trip.
 When selecting the "km/h" and "km". Press the **SET** button. The air temperature gauge unit is set, and then the display moves to the changing of the fuel mileage meter unit.

Instruments *(Continued)*

5 Changing the fuel mileage meter unit:

- 1 Press the  (up) button or the  (down) button to select "L/100km" or "km/L".







- 2 Press the  button. The fuel mileage meter unit is set, and the display moves to the setting of subtraction trip.

6 Setting the subtraction trip:

- 1 The preset figure is displayed and the third digit will be flashing.



- 2 To set the third digit, press the  (up) button or the  (down) button until the desired figure appears.
 - ↳ Press and hold the  (up) button or the  (down) button to advance the figure fast.





- 3 Press the  button. The second digit starts flashing.



- 4 Repeat the steps 2 and 3 for setting of the second and first digits.
- 5 Press the **SET** button. The trip distance is set, and then the display will return to the ordinary display.

The trip distance will not be reset when you complete setting of the subtraction trip by pressing the **SET** button only or when you set the trip distance to the same as the current distance. When entering the setting mode using "km" unit after setting the trip distance to "626 mile" or more with the unit set to "mile", "---." will appear.

Press the  (up) button or the  (down) button to display "000.0", and then set the trip distance again if necessary.

Pressing the **SET** button while "---." is displayed will return the display to the ordinary display and keep the previous trip distance.

Indicators

If one of these indicators does not come on when it should, have your dealer check for problems.

← Left turn signal indicator

PGM-FI (Programmed Fuel Injection) malfunction indicator lamp (MIL)

Comes on briefly when the ignition switch is turned to the ON position with the engine stop switch in the  (Run) position.

Comes on when the ignition switch is turned to the ON position with the engine stop switch in the  (Off) position.

If it comes on while engine is running: 

Low oil pressure indicator

Comes on when the ignition switch is turned to the ON position.

Goes off when the engine starts.

If it comes on while engine is running: 

High beam indicator

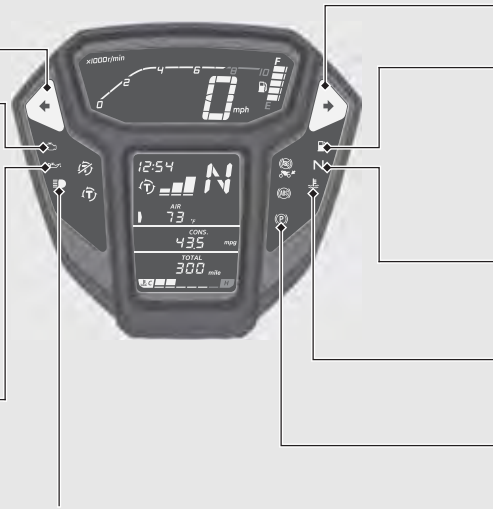

 **Right turn signal indicator** **Low fuel indicator**

- Comes on briefly when the ignition switch is turned to the ON position.
- Comes on when there is only reserve fuel left in the fuel tank. Remaining fuel when low fuel indicator comes on: 0.8 US gal (3.4 L)

1st (E) segment of the fuel gauge flashes:  **P.35**

 **Neutral indicator**

Comes on when the transmission is in Neutral.

 **High coolant temperature indicator**

If it comes on while riding:  **P.137**

 **Parking brake indicator** **CRF1000D**

Lights as a reminder that you have not released the parking brake lever.

Indicators (Continued)

Torque Control OFF indicator

- Comes on when the Torque Control is turned is turned off.

Torque Control indicator

- Comes on when the ignition switch is turned to the ON position. Goes off when your speed reaches approximately 6 mph (10 km/h) to indicate Torque Control is ready to work.
- Blinks when Torque Control is operating.

If it comes on while riding:  **P.140**





Rear ABS (Anti-lock Brake System) OFF indicator

- Comes on briefly when the ignition switch is turned to the ON position.
- Comes on when the ABS function on the rear wheel is turned off.



ABS (Anti-lock Brake System) indicator

Comes on when the ignition switch is turned to the ON position.
Goes off when your speed reaches approximately 6 mph (10 km/h).

If it comes on while riding:  **P.139**

Switches

CRF1000A

Torque Control switch



Torque Control level setting and
Torque Control on/off.  P.56

Turn signal switch

Pressing the switch turns
the turn signal off.

Horn button

Headlight dimmer/Passing light control switch

-  : High beam
-  : Low beam
-  **PASS** : Flashes the high beam headlight.

Ignition Switch

Switches the electrical system on/off, locks the steering.

- Key can be removed when in the OFF or LOCK position.

Steering Lock:  P.52

Rear ABS switch

Switches the ABS function on the rear wheel on/off.  P.53

Engine stop switch/ Start button

Should normally remain in the  (Run) position.

- In an emergency, switch to the  (Off) position to stop the engine.

Hazard switch

Switchable when the ignition switch is turned to the ON position. Can be turned to off regardless of the ignition switch position.

- The signals continue flashing with the ignition switch in OFF or LOCK after the hazard switch is on.



Switches *(Continued)*

CRF1000D

Torque Control switch

Torque Control level setting and Torque Control on/off.  **P.56**

Headlight dimmer/Passing light control switch

-  : High beam
-  : Low beam
-  **PASS** : Flashes the high beam headlight.

Shift up switch (+)

To shift up the gear.

 **P.68**

Horn button

Shift down switch (-)

To shift down the gear.  **P.68**

Turn signal switch

Pressing the switch turns the turn signal off.

N-D Switch

To shift between Neutral and AT MODE.  **P.66**

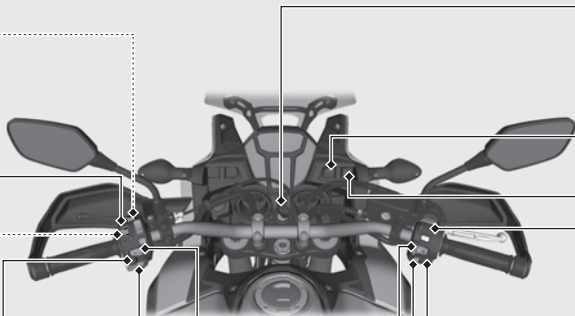

Ignition Switch

Switches the electrical system on/off, locks the steering.

- ⌋ Key can be removed when in the OFF or LOCK position.

Steering Lock: ➡ P.52

Rear ABS switch

Switches the ABS function on the rear wheel on/off. ➡ P.53

G switch

Switches the G switch on/off. ➡ P.54

Engine stop switch/ Start button

Should normally remain in the  (Run) position.

- ⌋ In an emergency, switch to the  (Off) position to stop the engine.

A/M Switch

To shift between the AT MODE and MT MODE. ➡ P.66

Hazard switch

Switchable when the ignition switch is turned to the ON position. Can be turned to off regardless of the ignition switch position.

- ⌋ The signals continue flashing with the ignition switch in OFF or LOCK after the hazard switch is on

Switches *(Continued)*

Steering Lock

Lock the steering when parking to help prevent theft.

A U-shaped wheel lock or similar device is also recommended.

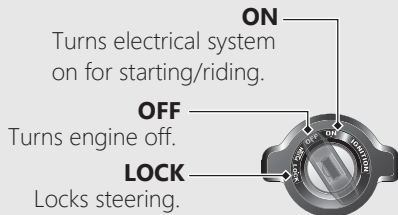
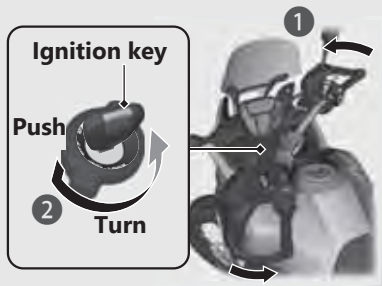

Locking

- 1 Turn the handlebar all the way to the left or right.
- 2 Push the key down, and turn the ignition switch to the LOCK position.
 - ⌋ Jiggle the handlebar if the lock is difficult to engage.
- 3 Remove the key.

Unlocking

Insert the key, push it in, and turn the ignition switch to the OFF position.

ABS function on the rear wheel

The ABS function on the rear wheel can be optionally turned off for off-road riding.

- Each time the ignition switch is turned to the ON position, the ABS function on both wheels will automatically be turned on.

To turn off the ABS function on the rear wheel

- Stop the motorcycle.
- Press and hold the rear ABS switch until the rear ABS OFF indicator starts flashing, then release the switch while the indicator is flashing.
 - The rear ABS OFF indicator is on, when the ABS function on the rear wheel is turned off.
 - The ABS function on the rear wheel remains on, if the switch is released after indicator stops flashing.

To turn on the ABS function on both wheels

- Stop the motorcycle.
- Press and hold the rear ABS switch until the rear ABS OFF indicator is turned off, or turn the ignition switch to the OFF position and the ON position.



ABS function on both wheels is on.



ABS function on rear wheel is off.

Rear ABS switch



G switch

CRF1000D

The G switch can change the engine characteristics of your motorcycle to help improve traction and machine control for off-road riding by reducing the amount of clutch slip during throttle operation.

- Each time the ignition switch is turned to the ON position, the G switch will automatically be set to off.
- The G switch may not compensate for rough road conditions.

Always consider road and weather conditions, as well as your skills and condition, when applying throttle.

G switch on or off

- Stop the motorcycle and close the throttle completely.
- Press the G switch.



Parking Brake

CRF1000D

Parking Brake Lever

Be sure the parking brake is applied while parking and warming up the engine.

- ⌋ Make sure the parking brake lever is released before riding.

To apply the parking brake

Squeeze the parking brake lever (a) fully then rotate the lock lever (b) clockwise until it engages the slot on the parking brake lever bracket back to lock the rear wheel.

- ⌋ The parking brake lock will not function if the parking brake is not adjusted properly.

➔ P.114

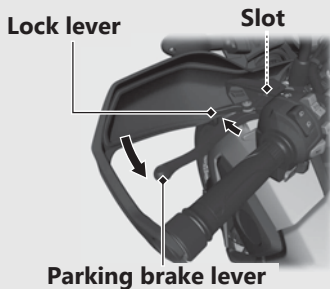

To release the parking brake

Squeeze the parking brake lever until the lock lever is released from the slot on the parking brake lever bracket.

- ⌋ Before riding, check that the parking brake indicator is turned off and make sure that the parking brake is fully released so there is no drag on the rear wheel.

Honda selectable torque control

Torque Control level (engine power control) can be selected or turned on/off.

- ⊣ Do not operate the Torque Control switch while riding.
Stop the motorcycle first and the turn off or on and select the desired level.
- ⊣ The Torque Control setting cannot be changed or turned off when the system is activated (Torque Control indicator flashing).
- ⊣ Each time the ignition switch is turned to the ON position, the Torque Control level will automatically be set to level 3 (max).
- ⊣ When the Torque Control is turned from the off position to the on position, it will automatically be set to level 3 (max).

Torque Control level setting

The level can be selected by pressing the Torque Control switch.

- ⊣ Level 3 is the maximum Torque Control level
- ⊣ Level 1 is the minimum Torque Control level

Torque Control on and off

Torque Control can be turned on and off by press and hold the Torque Control switch.

Torque Control switch



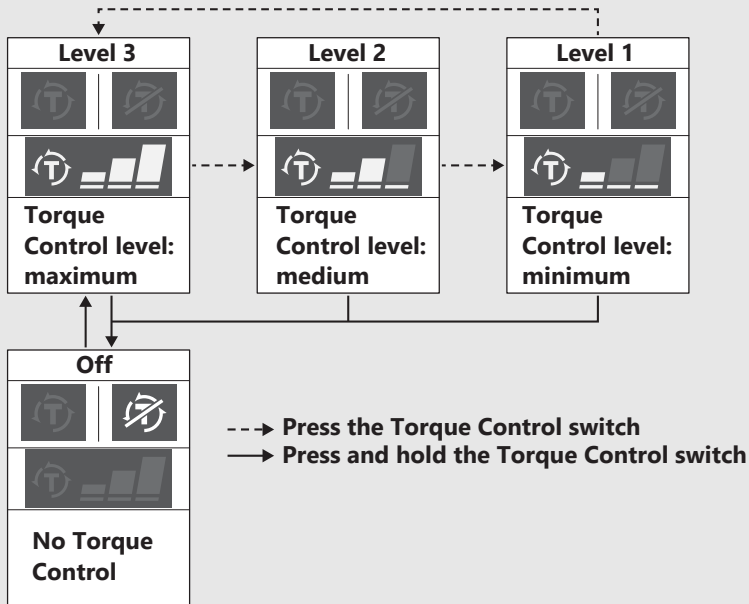

Starting the Engine

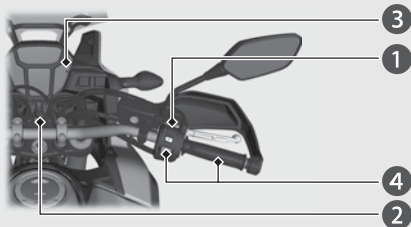

CRF1000A

Start your engine using the following procedure, regardless of whether the engine is cold or warm.



NOTICE

- If the engine does not start within 5 seconds, turn the ignition switch to the OFF position and wait 10 seconds before trying to start the engine again to recover battery voltage.
- Extended fast idling and revving the engine can damage the engine, and the exhaust system.
- Snapping the throttle or fast idling for more than about 5 minutes may cause exhaust pipe discoloration.
- The engine will not start if the throttle is fully open.

- 1 Make sure the engine stop switch is in the  (Run) position.
- 2 Turn the ignition switch to the ON position.
- 3 Shift the transmission to Neutral ( indicator come on). Alternatively, pull in the clutch lever to start your motorcycle with the transmission in gear so long as the side stand is raised.
- 4 Press the start button with the throttle completely closed.

If the engine does not start:



- a Open the throttle fully and press the start button for 5 seconds.
- b Repeat the normal starting procedure.
- c If the engine starts, open the throttle slightly if idling is unstable.
- d If the engine does not start, wait 10 seconds before trying steps a & b again.

If Engine Will Not Start  **P.136**

CRF1000D

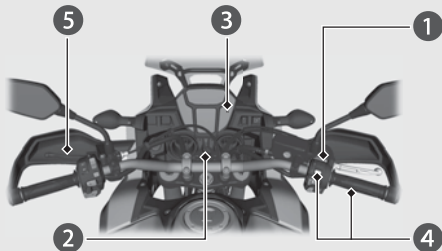
Start your engine using the following procedure, regardless of whether the engine is cold or warm.



- 1 Make sure the engine stop switch is in the  (Run) position.
- 2 Turn the ignition switch to the ON position.
- 3 Check the transmission in Neutral ( indicator come on).
- 4 Press the start button with the throttle completely closed.
- 5 Make sure the parking brake lever is released before riding.  P.55

If Engine Does Not Start  P.58

NOTICE

- If the engine does not start within 5 seconds, turn the ignition switch to the OFF position and wait 10 seconds before trying to start the engine again to recover battery voltage.
- Extended fast idling and reving the engine can damage the engine, and the exhaust system.
- Snapping the throttle or fast idling for more than about 5 minutes may cause exhaust pipe discoloration.
- The engine will not start if the throttle is fully open.

Starting the Engine *(Continued)*

When you stop the engine

- a To stop the engine, put gear to Neutral (N indicator to come on).
 - u If you turn the ignition switch to the OFF position when the motorcycle in gear, the engine will shut off with the clutch disengaged.
- b Turn the ignition switch to the OFF position.
- c Set the parking brake when you park the motorcycle.  **P.55**

Shifting Gears

CRF1000A

Your motorcycle transmission has 6 forward gears in a one-down, five-up shift pattern.

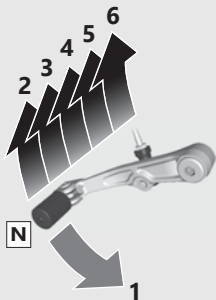

If you put the motorcycle in gear with the side stand down, the engine will shut off.

Recommended Shift Points

Shifting Up

From 1st to 2nd	12 mph (20 km/h)
From 2nd to 3rd	19 mph (30 km/h)
From 3rd to 4th	25 mph (40 km/h)
From 4th to 5th	31 mph (50 km/h)
From 5th to 6th	37 mph (60 km/h)

Shifting Down

From 6th to 5th	28 mph (45 km/h)
From 5th to 4th	22 mph (35 km/h)
From 4th to 3rd	16 mph (25 km/h)

NOTICE

Improper shifting can damage the engine, transmission, and drive train. Also, coasting or towing the motorcycle for long distances with the engine off can damage the transmission.

Shifting Gears *(Continued)*

CRF1000D

Your motorcycle is equipped with an automatically controlled 6-speed transmission. It can be shifted automatically (by AT MODE) or manually (by MT MODE).

Recommended Shift Points

Shifting Up

From 1st to 2nd	12 mph (20 km/h)
From 2nd to 3rd	19 mph (30 km/h)
From 3rd to 4th	25 mph (40 km/h)
From 4th to 5th	31 mph (50 km/h)
From 5th to 6th	37 mph (60 km/h)

Shifting Down

From 6th to 5th	28 mph (45 km/h)
From 5th to 4th	22 mph (35 km/h)
From 4th to 3rd	16 mph (25 km/h)

NOTICE

Improper shifting can damage the engine, transmission, and drive train. Also, coasting or towing the motorcycle for long distances with the engine off can damage the transmission.

CRF1000D

Dual Clutch Transmission

In order to respond to rider demands in a broad range of situations, the transmission is equipped with three operating modes, AT MODE (including D mode for regular operation and three levels of S mode for sporty riding); and MT MODE (MT mode for a 6-speed manual operation), which delivers the same shift feel as a manual transmission.

- Always use the recommended tires and sprockets to ensure correct Dual Clutch Transmission operation.

The Dual Clutch Transmission system runs a self check immediately after starting the engine.

"**N**" appears in the gear position indicator window for a few seconds, then goes out. While "**N**" appears, you cannot shift into gear.

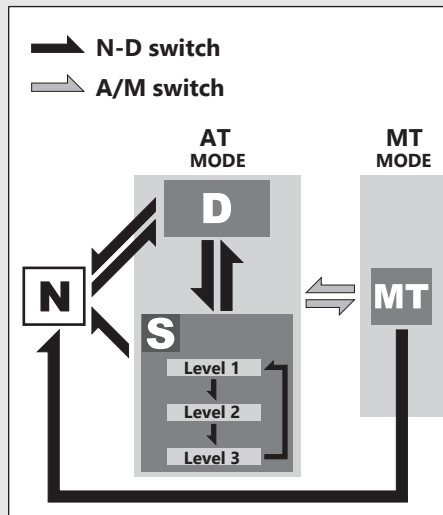

Shifting Gears *(Continued)*

Neutral (N): Neutral is selected automatically when you turn the ignition switch to the ON position.

If neutral is not selected when you turn the ignition switch to the ON position.

- ⊔ Turn the ignition switch to the OFF position and then to the ON position again.
- ⊔ If neutral is still not selected after turning the ignition switch to the OFF position, and then to the ON position again. ➔ **P.141**

You may hear (click) noises when the transmission shifts to Neutral (N). This is normal.

When you can change between N and D

- ⊔ Motorcycle is stopped and the engine is idling.
- ⊔ Throttle is completely closed. It is not possible to change from Neutral to D mode while the throttle is applied.
- ⊔ You cannot change between N and D mode while the wheels are rotating.
- ⊔ Side stand is raised.

NOTICE

To prevent clutch damage, do not use the throttle to keep the motorcycle stopped uphill.

AT MODE: In this mode the gears are shifted automatically according to your riding conditions.

And also using the shift up switch (+) or shift down switch (-), you can temporarily shift up or down in AT MODE by using the shift switch. These switches are convenient when you want to temporarily down-shift in front of a curve, etc.  **P.68**

You can choose between two modes within AT MODE: D mode and S mode.

D mode (AT): This is the standard mode when AT MODE is selected. Select D mode for regular operation and efficient fuel economy.

S mode (AT): Select this mode while riding in AT MODE when you need more power, such as when overtaking, climbing hills, pulling away.

S mode has three levels of adjustment.

MT MODE: MT MODE (6-speed manual operation) You can choose between 6 gears in this mode.

Shifting Gears *(Continued)*

Changing between Neutral and AT MODE/MT MODE

Changing from Neutral (N) to AT MODE

Press the D-S side of the N-D switch (a).

The D mode indicator comes on, "1" is shown in the gear position indicator and first gear is selected.

Changing from AT or MT MODE to Neutral

Press N on the N-D switch (b).

Changing between D mode and S mode while in AT MODE

Press the D-S side of the N-D switch. The S or D indicator comes on (c , d).

Changing between AT MODE and MT MODE

Press the A/M switch (e).

The S or D indicator goes out while MT MODE is selected (f).

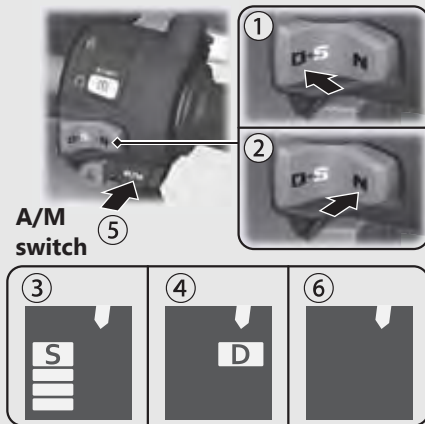

S mode level selecting while in AT MODE

While in S mode, press and hold the D-S side of the N-D (a) switch.

- Close the throttle completely. Then select the desired level of the S mode.

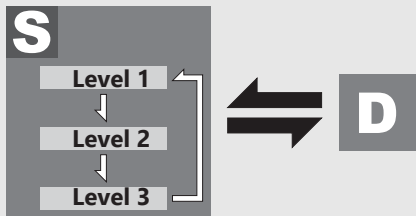

- Press and hold the D-S side of the N-D switch
- Press the D-S side of the N-D switch

N-D switch

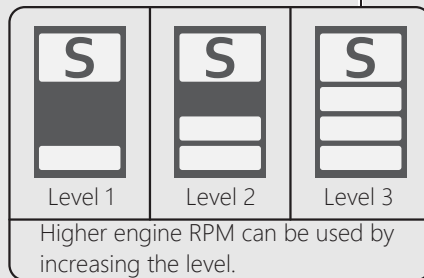
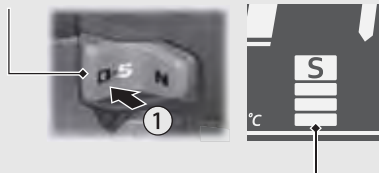

The selected level is maintained even when the ignition switch is turned to the OFF position, or transmission is switched to out of S mode.

Shifting Gears *(Continued)*

Riding in MT MODE

Shift up and down with the shift up switch (+) and shift down switch (-).

The selected gear is shown on the gear position indicator.

- ⌋ If the MT MODE is selected, the transmission does not shift up automatically. Do not allow the engine revs to go into the red zone.
- ⌋ The transmission automatically shifts down when you slow down, even in MT MODE.
- ⌋ You will start from 1st gear even if MT MODE is selected.

Gear shift operation

Shifting Up:

Press the shift up switch (+) (**g**).

Shifting Down:

Press the shift down switch (-) (**h**).

You cannot continue shifting gear by keeping the shift switch pressed.

To continue shifting gear release the switch and press it again.



Shift Limit

You cannot downshift if the engine will exceed the rev limit.

Refueling

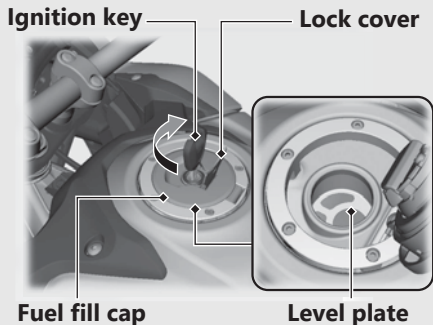

Do not fill with fuel above the level plate.

Fuel type: Unleaded gasoline only

Recommended fuel octane number:

Pump Octane Number (PON) 86 or higher.

Tank capacity: 4.97 US gal (18.8 L)

Refueling and Fuel Guidelines ➔ P.15

Opening the Fuel Fill Cap

Open the lock cover, insert the ignition key, and turn it clockwise to open the fuel fill cap.

Closing the Fuel Fill Cap

- 1 After refueling, push the fuel fill cap closed until it locks.
- 2 Remove the key and close the lock cover.
 - ⊣ The key cannot be removed if the fuel fill cap is not locked.

3 WARNING

Gasoline is highly flammable and explosive. You can be burned or seriously injured when handling fuel.

- Stop the engine, and keep heat, sparks, and flame away.
- Handle fuel only outdoors.
- Wipe up spills immediately.

Storage Equipment

Helmet Holder

A helmet holder is located under the front seat.

The helmet set wire is secured with the rear fender under the front seat. ➔P.71

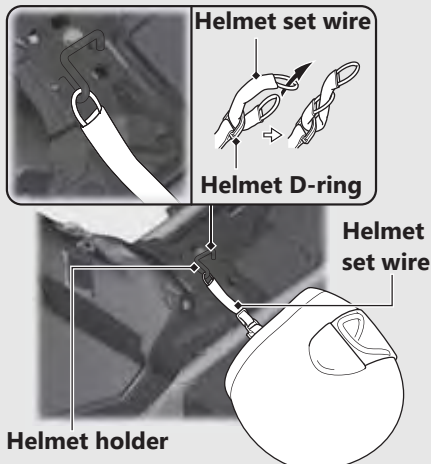

⌋ Use the helmet holder only when parked.

Removing the front seat ➔P.98

3 WARNING

Riding with a helmet attached to the holder can interfere with your ability to safely operate the motorcycle and could lead to a crash in which you can be seriously hurt or killed.

Use the helmet holder only while parked. Do not ride with a helmet secured by the holder.

Helmet Set Wire/U-shaped Lock

The helmet set wire is secured on the rear fender under the front seat with the rubber strap. There is also space to store a U-shaped lock on the rear fender using the rubber strap.

Helmet set wire

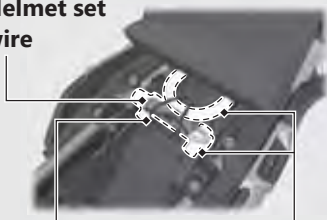

Rubber strap

U-shaped lock

- ⌋ U-shaped lock is not included with this motorcycle.
- ⌋ Some U-shaped locks may not fit in the compartment due to their size or design.

Removing the front seat ➡ P.98

Document Bag/Hex Wrench

The document bag and hex wrench are located on the underside of the front seat.



Removing the front seat ➡ P.98

Storage Equipment *(Continued)*

Tool Kit

The tool kit is located in the tool box.

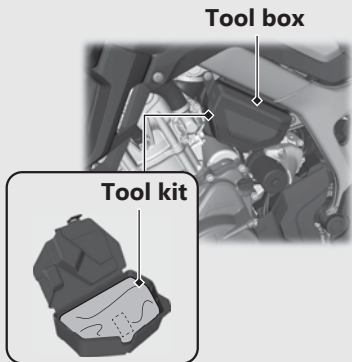

Rear Carrier

Never exceed the maximum weight limit.

Maximum Weight: 22 lb (10 kg)



Remove the tool box ➡ P.101

Maintenance

Please read "Importance of Maintenance" and "Maintenance Fundamentals" carefully before attempting any maintenance. Refer to "Specifications" for service data.

An optional larger tool kit may be available.

Check with your Honda dealer's parts department.

Importance of Maintenance	P. 74	Drive Chain	P. 117
Maintenance Schedule	P. 76	Wheels	P. 121
Maintenance Fundamentals	P. 79	Clutch	P. 122
Removing & Installing Body Components ..	P. 95	Throttle	P. 125
Battery	P. 95	Crankcase Breather	P. 126
Battery Box Cover	P. 97	Other Adjustments	P. 127
Front Seat	P. 98	Adjusting the Headlight Aim	P. 127
Skid Plate	P. 100	Adjusting the Brake Lever	P. 128
Tool Box	P. 101	Adjusting the Front Suspension	P. 129
Spark Arrester	P. 102	Adjusting the Rear Suspension	P. 132
Engine Oil	P. 104		
Coolant	P. 110		
Brakes	P. 112		
Side Stand	P. 116		

Importance of Maintenance

Importance of Maintenance

Keeping your motorcycle well-maintained is absolutely essential to your safety and to protect your investment, obtain maximum performance, avoid breakdowns, and reduce air pollution. Maintenance is the owner's responsibility. Be sure to inspect your motorcycle before each ride, and perform the periodic checks specified in the Maintenance Schedule. 2 P. 76

3WARNING

Improperly maintaining your motorcycle or failing to correct a problem before you ride can cause a crash in which you can be seriously hurt or killed.

Always follow the inspection and maintenance recommendations and schedules in this owner's manual.

For information about the exhaust emission and noise emission requirements of the U.S. Environmental Protection Agency (EPA), and the Environment Canada (EC). 2 P. 171

USA

Maintenance, replacement or repair of the emission control devices and systems may be performed by any motorcycle repair establishment or individual using parts that are "certified" to EPA standards.

Maintenance Safety

Always read the maintenance instructions before you begin each task, and make sure that you have the tools, parts, and skills required. We cannot warn you of every conceivable hazard that can arise in performing maintenance. Only you can decide whether or not you should perform a given task.

Follow these guidelines when performing maintenance.







- Stop the engine and remove the key.
- Place your motorcycle on a firm, level surface using the side stand or a maintenance stand to provide support.
- Allow the engine, muffler, brakes, and other high-temperature parts to cool before servicing as you can get burned.
- Run the engine only when instructed, and do so in a well-ventilated area.

Maintenance Schedule



The maintenance schedule specifies the maintenance requirements necessary to ensure safe, dependable performance, and proper emission control.

Maintenance work should be performed in accordance with Honda's standards and specifications by properly trained and equipped technicians. Your dealer meets all of these requirements. Keep an accurate record of maintenance to help ensure that your motorcycle is properly maintained. Make sure that whomever performs the maintenance completes this record.

All scheduled maintenance is considered a normal owner operating cost and will be charged to you by your dealer. Retain all receipts. If you sell the motorcycle, these receipts should be transferred with the motorcycle to the new owner.

Items	Frequency*1								Regular Replace	Refer to page		
	× 1,000 mi	0.6	4	8	12	16	20	24				
	× 1,000 km	1.0	6.4	12.8	19.2	25.6	32.0	38.4				
Fuel Line				I		I		I			-	
Throttle Operation				I		I		I			125	
Air Cleaner *2					R			R			94	
Crankcase Breather*3			C	C	C	C	C	C			126	
Spark Plug		Every 16,000 mi (25,600 km): I Every 32,000 mi (51,200 km): R										-
Valve Clearance						I					-	
Engine Oil			R		R		R		R	1 Year	106	
Engine Oil Filter			R				R				106	
Clutch Oil Filter*8			R				R				108	
Engine Idle Speed				I		I		I			-	
Radiator Coolant*7				I		I		I		3 Years	110	
Cooling System				I		I		I			-	
Secondary Air Supply System						I					-	
Evaporative Emission Control System*4						I					-	







Maintenance Level

-  : Intermediate. We recommend service by your dealer, unless you have the necessary tools and are mechanically skilled. Procedures are provided in an official Honda Service Manual (2 P. 177).
-  : Technical. In the interest of safety, have your motorcycle serviced by your dealer.

Maintenance Legend

- I : Inspect (clean, adjust, lubricate, or replace, if necessary)
- L : Lubricate
- R : Replace
- C : Clean

Maintenance Schedule

Items		Frequency*1								Regular Replace	Refer to page	
		× 1,000 mi	0.6	4	8	12	16	20	24			
		× 1,000 km	1.0	6.4	12.8	19.2	25.6	32.0	38.4			
Emission-related Items	Drive Chain*5		Every 600 mi (1,000 km): I L									117
	Drive Chain Slider			I	I	I	I	I	I		120	
	Brake Fluid *7			I	I	I	I	I	I	2 Years	112	
	Brake Pads Wear			I	I	I	I	I	I		113	
	Brake System				I		I		I		79	
	Brake Light Switch				I		I		I		115	
	Brake Lock Operation*8				I	I	I	I	I	I		114
	Headlight Aim				I		I		I		127	
	Clutch System*9				I	I	I	I	I		122	
	Side Stand				I		I		I		116	
	Suspension					I		I		I		-
	Spark Arrester*6				C	C	C	C	C	C		102
	Nuts, Bolts, Fasteners*5					I		I		I		-
Wheels/Tires*5				I	I	I	I	I	I		90,121	
Steering Head Bearings					I		I		I		-	

Notes:

- *1: At higher odometer readings, repeat at the frequency interval established here.
- *2: Service more frequently when riding in unusually wet or dusty areas.
- *3: Service more frequently when riding in rain or at full throttle.
- *4: 50 STATE (meets California).
- *5: Service more frequently when riding OFF-ROAD.
- *6: USA only.
- *7: Replacement requires mechanical skill.
- *8: CRF1000D only
- *9: Except CRF1000D

Pre-ride Inspection

To ensure safety, it is your responsibility to perform a pre-ride inspection and make sure that any problem you find is corrected. A pre-ride inspection is a must, not only for safety, but because having a breakdown, or even a flat tire, can be a major inconvenience.

Before riding on-road, or returning to pavement after riding off-road, take a few moments to walk around your motorcycle and look for any loose parts or anything that appears unusual.

Also check the following.

- Tire tread wear and air pressures are within limits. 2 P. 90
- Lights, horn, and turn signals operate normally.
- Check the condition of the drive chain. Adjust slack and lubricate as needed. 2 P. 87

Check the following items if you are carrying a passenger or cargo:

- Combined weight is within load limits. 2 P. 183
- Cargo is secured properly.
- Suspension is adjusted to suit load. 2 P. 129, 2 P. 132

Check the following items after you get on your motorcycle:

- Throttle action moves smoothly without binding. 2 P. 125
- Brake lever and pedal operate normally.
- Check the fuel level and refuel when needed. 2 P. 15, 2 P. 69
- Engine stop switch functions properly. 2 P. 48

Maintenance Fundamentals

Check the following items at regular intervals:

- Oil level is between the upper and lower level marks. 2 P. 104
- Brake fluid level is
Front: above the LOWER level mark. 2 P. 112
Rear: between the UPPER and LOWER level marks. 2 P. 112
- Engine coolant level is between the UPPER and LOWER level marks. 2 P. 110
- Side stand functions properly. 2 P. 116
- **CRF1000D**
Parking brake works properly. 2 P. 114

Before riding off-road check all of the preceding plus the following:

- Make sure spokes are tight. Check the rims for any damage. 2 P. 121
- Oil level is between the upper and lower marks. 2 P. 104
- Check the fuel level and refuel when needed. 2 P. 15, 2 P. 69
- Be sure the fuel fill cap is securely fastened. 2 P. 69
- **CRF1000A**
Clutch lever operates smoothly. Adjust freeplay if necessary. 2 P. 122
- Check for loose cables and other parts, and anything that appears abnormal.
- Use a wrench to check the tightness of all accessible nuts, bolts and fasteners.

Periodic Checks

You should also perform other periodic maintenance checks at least once a month regardless of how often you ride, or more often if you ride frequently.

Also, check the odometer reading against the Maintenance Schedule and perform all maintenance that is due. 2 P. 76

Tires and wheels	Check the air pressure (2 P. 90), examine tread for wear and damage (2 P. 90), and check the wheels for damage.
Fluid levels	Check the engine oil level (2 P. 104), engine coolant level (2 P. 110), and brake fluid level (2 P. 112).
Lights	Check that the headlight, brake light, taillight turn signals and license plate light are working properly.
Controls	Check the freeplay of the clutch lever (CRF1000A only) (2 P. 122), throttle grip (2 P. 125), front brake lever (2 P. 128) and parking brake (CRF1000D only) (2 P. 114).
Drive chain	Check the slack (2 P. 117), adjust the slack (2 P. 118), and lubricate (2 P. 88) as needed.
Fuses	Check that you have a full supply of spare fuses.
Nuts & bolts	Check the major nuts and bolts, and tighten as needed.
Crankcase Breather	Service the crankcase breather more frequently if your motorcycle is ridden in the rain or often at full throttle. Service the breather if you can see deposits in the transparent section of the drain tube (2 P. 126).

Replacing Parts

Always use Honda Genuine Parts or their equivalents to ensure reliability and safety.

When ordering colored components, specify the model name, color, and code mentioned on the color label. The color label is attached to the rear fender under the front seat. 2 P. 98

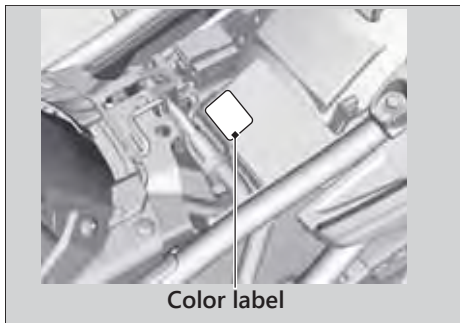

3 WARNING

Installing non-Honda parts may make your motorcycle unsafe and cause a crash in which you can be seriously hurt or killed.

Always use Honda Genuine Parts or equivalents that have been designed and approved for your motorcycle.

Battery

Your motorcycle has a maintenance-free type battery. You do not have to check the battery electrolyte level or add distilled water. Clean the battery terminals if they become dirty or corroded.

Do not remove the battery cap seals. There is no need to remove the cap when charging.

What to do in an emergency

If any of the following occur, immediately see your doctor.

- Electrolyte splashes into your eyes:
 - ⊔ Wash your eyes repeatedly with cool water for at least 15 minutes. Using water under pressure can damage your eyes.
- Electrolyte splashes onto your skin:
 - ⊔ Remove affected clothing and wash your skin thoroughly using water.
- Electrolyte splashes into your mouth:
 - ⊔ Rinse mouth thoroughly with water, and do not swallow.

3 WARNING

The battery gives off explosive hydrogen gas during normal operation.

A spark or flame can cause the battery to explode with enough force to kill or seriously hurt you.

Wear protective clothing and a face shield, or have a skilled mechanic do the battery servicing.

WARNING: Battery posts, terminals, and related accessories contain lead and lead compounds.

Wash your hands after handling.

| Cleaning the Battery Terminals

1. Remove the battery. 2 P. 95
2. If the terminals are starting to corrode and are coated with a white substance, wash with warm water and wipe clean.
3. If the terminals are heavily corroded, clean and polish the terminals with a wire brush or sandpaper. Wear safety glasses.

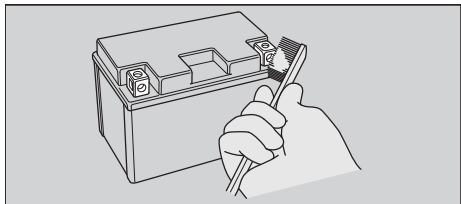

4. After cleaning, reinstall the battery.

The battery has a limited life span. Consult your dealer about when you should replace the battery. Always replace the battery with another maintenance-free battery of the same type.

| Charging

If you use electrical accessories that drain the battery or you do not ride frequently, we recommend that you charge the battery every 30 days using a charger designed specifically for your Honda, which can be purchased from your dealer. Read the information that came with your battery charger and follow the instructions on the battery. Avoid using an automobile-type battery charger, as these can overheat a motorcycle battery and cause permanent damage.

Make sure the ignition switch is in the OFF position before charging the battery.

NOTICE

Improper charging can damage the battery. If you can't charge the battery or it appears unable to hold a charge, contact your dealer.

NOTICE

Jump starting using an automobile battery can damage your motorcycle's electrical system and is not recommended. Bump starting is also not recommended.

NOTICE

Installing non-Honda electrical accessories can overload the electrical system, discharging the battery and possibly damaging the system.

Fuses

Fuses protect the electrical circuits on your motorcycle. If something electrical on your motorcycle stops working, check for and replace any blown fuses. 2 P. 154

Inspecting and Replacing Fuses

Turn the ignition switch to the OFF position to remove and inspect fuses. If a fuse is blown, replace with a fuse of the same rating. For fuse ratings, see "Specifications." 2 P. 185

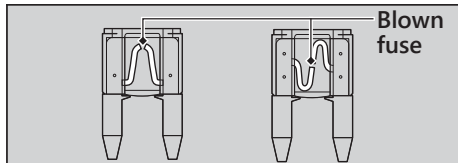
**NOTICE**

Replacing a fuse with one that has a higher rating greatly increases the chance of damage to the electrical system.

If a fuse fails repeatedly, you likely have an electrical fault. Have your motorcycle inspected by your dealer.

Engine Oil

Engine oil consumption varies and oil quality deteriorates according to riding conditions and time elapsed.

Check the engine oil level regularly, and add the recommended engine oil if necessary. Dirty oil or old oil should be changed as soon as possible.

Selecting the Engine Oil

For recommended engine oil, see "Specifications." 2 P. 184

If you use non-Honda engine oil, check the label to make sure that the oil satisfies all of the following standards:

- JASO T 903 standard^{*1}: MA
- SAE standard^{*2}: 10W-30
- API classification^{*3}: SG or higher

^{*1}. The JASO T 903 standard is an index for engine oils for 4-stroke motorcycle engines. There are two classes: MA and MB. For example, the following label shows the MA classification.

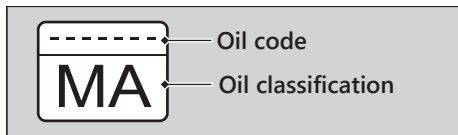

^{*2}. The SAE standard grades oils by their viscosity.

^{*3}. The API classification specifies the quality and performance rating of engine oils. Use SG or higher oils, excluding oils marked as "Energy Conserving" or "Resource Conserving" on the circular API service symbol.

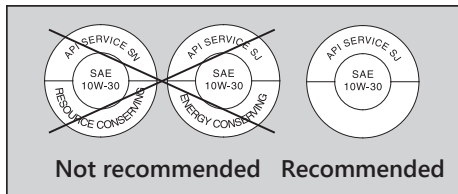

Brake Fluid

Do not add or replace brake fluid, except in an emergency. Use only fresh brake fluid from a sealed container. If you do add fluid, have the brake system serviced by your dealer as soon as possible.

NOTICE

Brake fluid can damage plastic and painted surfaces.

Wipe up spills immediately and wash thoroughly.

Recommended brake fluid:

Honda DOT 4 Brake Fluid or equivalent

3WARNING

Clean filler cap before removing. Use only DOT 4 fluid from a sealed container.

Drive Chain

The drive chain must be inspected and lubricated regularly. Inspect the chain more frequently if you often ride on bad roads, ride at high speed, or ride with repeated fast acceleration. 2 P. 117

If the chain does not move smoothly, makes strange noises, has damaged rollers, has loose pins, has missing O-rings, or kinks, have the chain inspected by your dealer.

Also inspect the drive sprocket and driven sprocket. If either has worn or damaged teeth, have the sprocket replaced by your dealer.

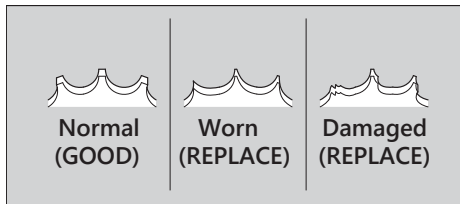

NOTICE

Use of a new chain with worn sprockets will cause rapid chain wear.

Cleaning and Lubricating

After inspecting the slack, clean the chain and sprockets while rotating the rear wheel. Use a dry cloth with chain cleaner designed specifically for O-ring chains, or neutral detergent. Use a soft brush if the chain is dirty.

After cleaning, wipe dry and lubricate with the recommended lubricant.

Recommended lubricant:

Pro Honda HP Chain Lube or equivalent

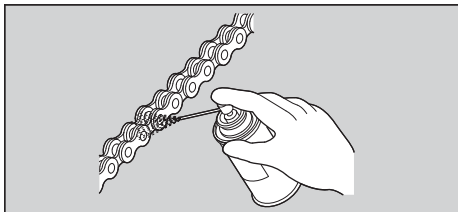

Do not use a steam cleaner, a high pressure cleaner, a wire brush, volatile solvent such as gasoline and benzene, abrasive cleaner, chain cleaner or lubricant NOT designed specifically for O-ring chains as these can damage the rubber O-ring seals.

Avoid getting lubricant on the brakes or tires. Avoid applying excess chain lubricant to prevent spray onto your clothes and the motorcycle.

Recommended Coolant

Pro Honda HP Coolant is a pre-mixed solution of antifreeze and distilled water.

Concentration:

50% antifreeze and 50% distilled water

A concentration of antifreeze below 40% will not provide proper corrosion and cold temperature protection.

A concentration of up to 60% will provide better protection in colder climates.

NOTICE

Using coolant not specified for aluminum engines or tap/mineral water can cause corrosion.

Crankcase Breathers

Service more frequently when riding in rain, at full throttle, or after the motorcycle is washed or overturned. Service if the deposit level can be seen in the transparent section of the drain tube.

If the drain tube overflows, the air filter may become contaminated with engine oil causing poor engine performance. 2 P. 126

Tires (Inspecting/Replacing)

Checking the Air Pressure

Visually inspect your tires and use an air pressure gauge to measure the air pressure before each off-road ride and whenever you return to pavement after riding off-road. If you only ride on pavement, check the pressure at least once a month or any time you think the tires look low. Always check air pressure when your tires are cold.

If you decide to adjust the tire pressure for a particular off-road riding condition, make changes a little at a time.

Inspecting for Damage

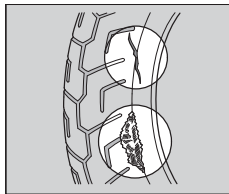

Inspect the tires for cuts, slits, or cracks that exposes fabric or cords, or nails or other foreign objects embedded in the side of the tire or the tread.

Also inspect for any unusual bumps or bulges in the side walls of the tires.

Inspecting for Abnormal Wear

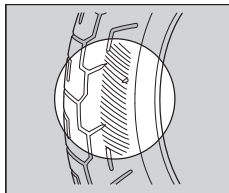

Inspect the tires for signs of abnormal wear on the contact surface.

Inspecting Tread Depth

Inspect the tread wear indicators. If they become visible, replace the tires immediately. For safe riding, you should replace the tires when the minimum tread depth is reached.

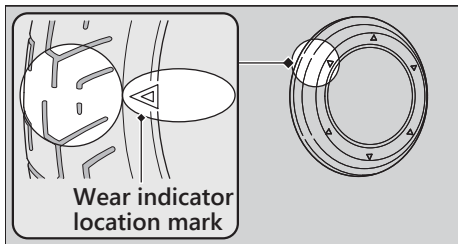

Inspecting Rims and Valve Stems

Inspect the rims for damage and loose spokes. Also inspect the valve stems for their positions. A tilted valve stem indicates the tube is slipping inside the tire or the tire is slipping on the rim. See your dealer.

3 WARNING

Riding on tires that are excessively worn or improperly inflated can cause a crash in which you can be seriously hurt or killed.

Follow all instructions in this owner's manual regarding tire inflation and maintenance.

Have your tires replaced by your dealer. For recommended tires, air pressure and minimum tread depth, see "Specifications."

2 P. 184

Follow these guidelines whenever you replace tires.

- Use the recommended tires or equivalents of the same size, construction, speed rating, and load range.
- Have the wheel balanced with Honda Genuine balance weights or equivalent after the tire is installed.
- Remember to replace the inner tube whenever you replace a tire. The old tube will probably be stretched, and it could fail if installed in a new tire.

3WARNING

Installing improper tires on your motorcycle can adversely affect handling and stability, and can cause a crash in which you can be seriously hurt or killed.

Always use the size and type of tires recommended in this owner's manual.

Tire Service Life

The service life of your tires is dependent on many factors, including, but not limited to, riding habits, road conditions, vehicle loading, tire air pressure, maintenance history, speed, and environmental conditions (even when the tires are not in use).

In addition to your regular inspections and maintenance, it is recommended that you have annual inspections performed once the tires reach 5 years old. It is also recommended that all tires be removed from service after 10 years from the date of manufacture, regardless of their condition or state of wear.

The last four digits of the TIN (tire identification number) indicate the date of manufacture.

Tire Identification Number (TIN)

The tire identification number (TIN) is a group of numbers and letters located on the sidewall of the tire.

a b c

DOT XXXX XXXX 22 09

DOT: This indicates that the tire meets all requirements of the U.S. Department of Transportation.

- a XXXX: Factory code
- b XXXX: Tire type code
- c 22 09: Date of manufacture (week & year).
Example: week 22 in year 09.

Tire Labeling Example

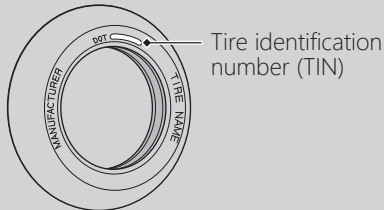

Air Cleaner

This motorcycle is equipped with a viscous type air cleaner element which cannot be cleaned with compressed air or otherwise without degrading its performance.

If the filter becomes dirty, replace it with a new one.

Battery

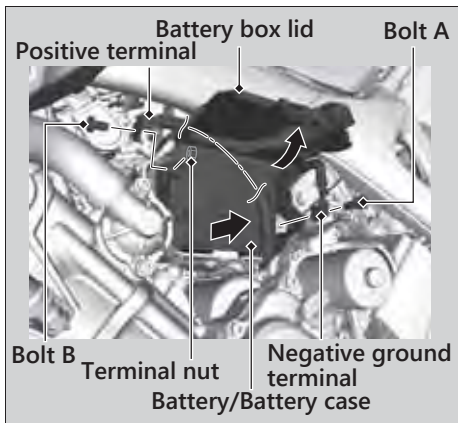

Removal

Make sure the ignition switch is in the OFF position.

1. Remove the tool box. 2 P. 101
2. Open the battery box lid.
3. Disconnect the negative - ground terminal.
4. Disconnect the positive + terminal from the battery.
5. Remove the battery taking care not to drop the terminal nuts.
 - ⊃ Make sure that the negative - ground terminal does not touch the surrounding metal parts while disconnecting the positive + terminal.
 - ⊃ Pull out the battery and battery case together from motorcycle.

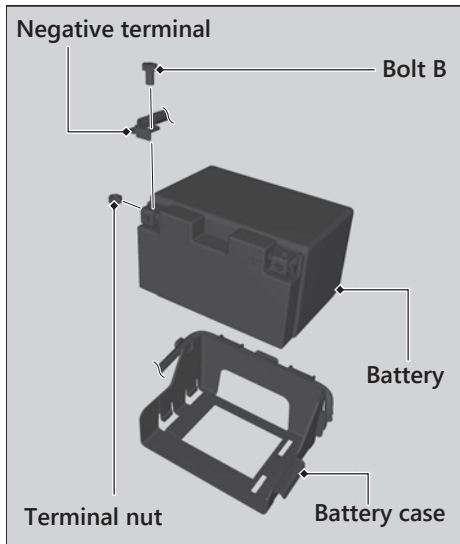

6. Disconnect the negative - terminal from the battery.
7. Remove the battery from the battery case taking care not to drop the terminal nut.

Installation

Install the parts in the reverse order of removal. Connect the positive + terminal first, before connecting the negative - ground terminal. Make sure that the negative - ground terminal does not touch the surrounding metal parts while connecting the positive + terminal. Make sure that bolts and nuts are tight. Make sure the clock information is correct after the battery is reconnected. 2 P. 39

For proper handling of the battery, see "Maintenance Fundamentals." 2 P. 82
 "Battery Goes Dead." 2 P. 151

Battery Box Cover

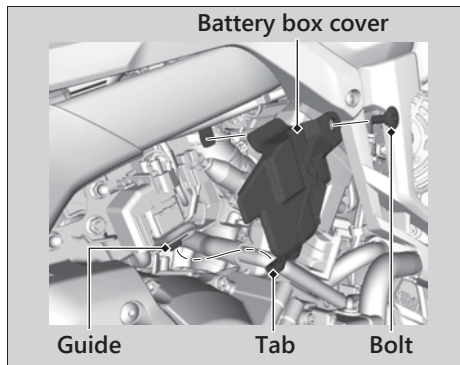

Removal

1. Remove the bolt.
2. Remove the battery box cover by releasing its tab from the guide.

Installation

Install the parts in the reverse order of removal.

Front Seat

Removal

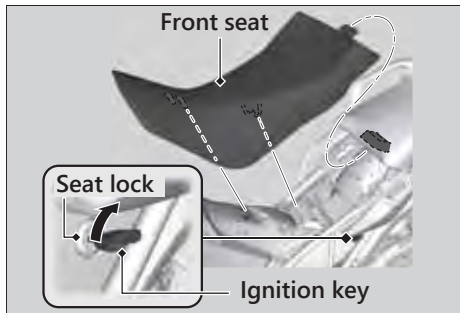

1. Insert the ignition key into the seat lock, and turn and hold the key clockwise to unlock the front seat.
2. Remove the front seat while pulling it forward and upward.

Installation

1. **When setting the high seat position:**
Insert the rear prong into the rear upper slot on the rear carrier.

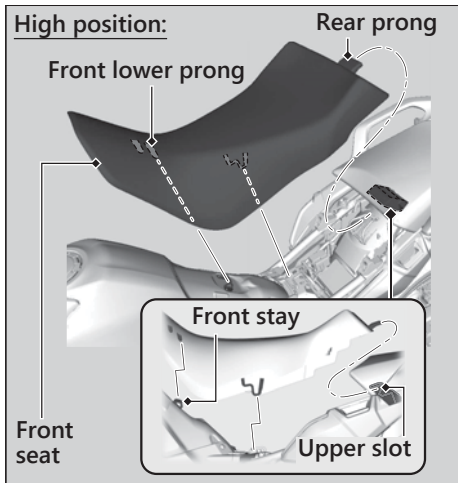

When setting the low seat position:

Insert the rear prong into the rear lower slot on the rear carrier.

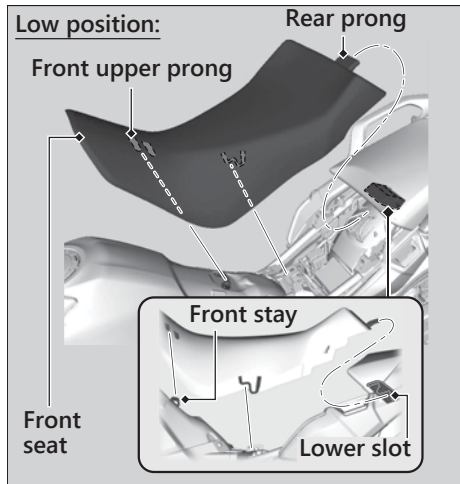
2. When setting the high seat position:

Insert the front lower prong into the front stay.

When setting the low seat position:

Insert the front upper prong into the front stay.

3. Push down on the center of the front seat until it locks in place.

Make sure that the seat is locked securely in position to pull it up lightly.

The seat locks automatically when installed. Take care not to lock your key in the compartment under the front seat.

Skid Plate

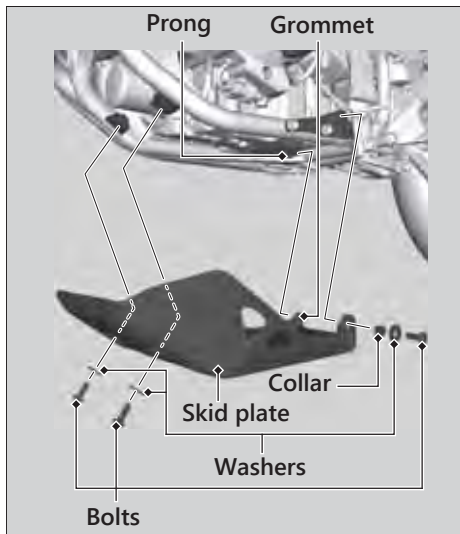

Removal

1. Remove the bolts and washers.
2. Remove the collar.
3. Remove the skid plate by releasing its grommet from the prong.

Installation

1. Install the skid plate in the reverse order of removal.
2. Install the collar.
3. Install the washers onto the bolts. Tighten the bolts.

Torque: 19 lbf-ft (26 N·m, 2.7 kgf·m).

Tool Box

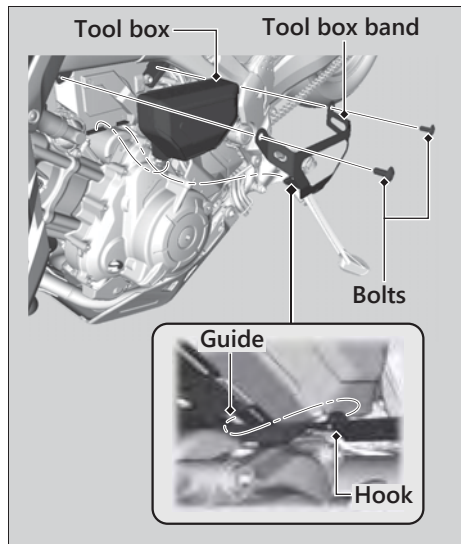

Removal

1. Remove the bolts using the hex wrench provided on the underside of the front seat. 2 P. 71
2. Remove the tool box band by releasing hook from the guide.
3. Remove the tool box.

Installation

Install the parts in the reverse order of removal.

Cleaning the Spark Arrester

Regular servicing prevents carbon buildup (which can diminish engine performance) and also complies with USDA regulations for regular maintenance to assure proper function. The spark arrester prevents random sparks from the combustion process in your engine from reaching the environment.

⚠ Because of possible fire hazard, do not ride with the spark arrester removed. Riding with the spark arrester removed will also damage the surrounding parts.

1. Allow the engine and muffler to cool.
2. Remove the tail cap cover bolts, washers, collars and tail cap from the muffler cover.
3. Remove the pan screws, grommets and muffler cover from the muffler.

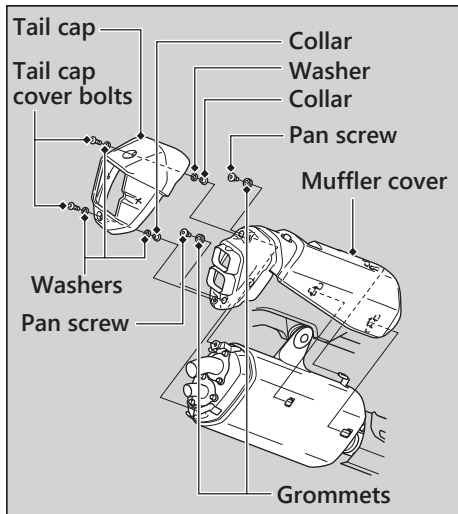

4. Remove the spark arrester mounting bolts, spark arresters and gasket from the muffler.

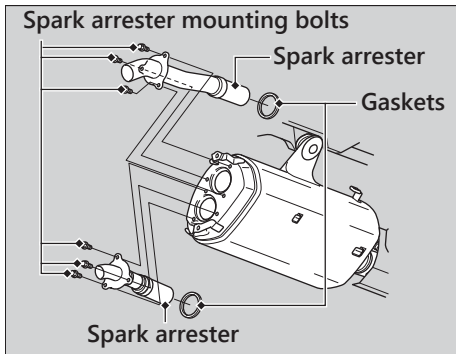

5. Use a brush to remove carbon deposits from the spark arrester screen. Be careful to avoid damaging the spark arrester screen. The spark arrester must be free of breaks and holes. Replace, if necessary. Check the gasket. Replace, if necessary.

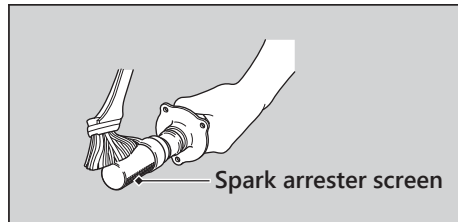

6. Install the gasket and the spark arresters, and tighten the spark arrester mounting bolts.

Torque: 6.6 lbf-ft (9.0 N·m, 0.9 kgf-m)

7. Install the muffler cover, grommets and tighten the pan screws.

Torque: 6.6 lbf-ft (9.0 N·m, 0.9 kgf-m)

8. Install the collars, washers, tail cap and tighten the tail cap cover bolts.

Torque: 6.6 lbf-ft (9.0 N·m, 0.9 kgf-m)

Checking the Engine Oil

1. Place your motorcycle on its side stand on a firm, level surface.
2. Idle the engine for 3 to 5 minutes.
3. Turn the ignition switch to the OFF position and wait for 2 to 3 minutes.
4. Place your motorcycle in an upright position on a firm, level surface.
5. Remove the dipstick and wipe it clean.
6. Insert the dipstick until it seats, but don't screw it in.
7. Check that the oil level is between the upper level and lower level marks in the dipstick.
8. Securely install the dipstick.

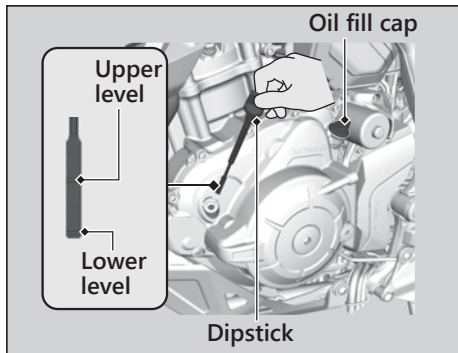

Adding Engine Oil

If the engine oil is below or near the lower level mark, add the recommended engine oil.
≥ P. 86, ≥ P. 184

1. Remove the oil fill cap. Add the recommended oil until it reaches the upper level mark.
 - U Place your motorcycle in an upright position on a firm, level surface when checking the oil level.
 - U Do not overfill above the upper level mark.
 - U Make sure no foreign objects enter the oil filler opening.
 - U Wipe up any spills immediately.
2. Securely reinstall the oil fill cap.

NOTICE

Overfilling with oil or operating with insufficient oil can cause damage to your engine. Do not mix different brands and grades of oil. They may affect lubrication and clutch operation.

For the recommended oil and oil selection guidelines, see “Maintenance Fundamentals.”
≥ P. 86

Changing Engine Oil & Filter

Changing the oil and filter requires special tools. We recommend that you have your motorcycle serviced by your dealer.

Use a new Honda Genuine oil filter or equivalent specified for your model.

NOTICE

Using the wrong oil filter can result in serious damage to the engine.

1. Remove the skid plate. ∪ P. 100
2. If the engine is cold, idle the engine for 3 to 5 minutes.
3. Turn the ignition switch to the OFF position and wait for 2 to 3 minutes.
4. Place your motorcycle on a firm, level surface.
5. Place a drain pan under the drain bolts.

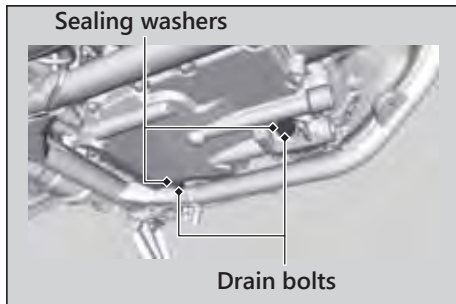

6. Remove the oil fill cap, drain bolts, and sealing washers to drain the oil.
7. Remove the oil filter with a filter wrench and let the remaining oil drain out. Make sure the prior seal is not stuck to the engine.
 - ∪ Discard the oil and oil filter at an approved recycling center.

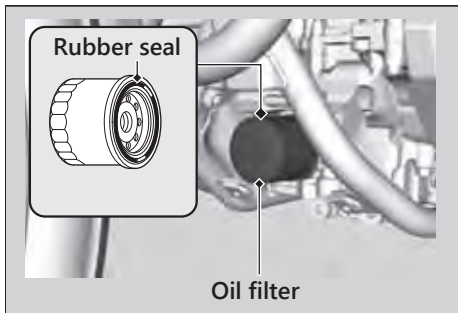

8. Apply a thin coat of engine oil to the rubber seal of a new oil filter.
9. Install the new oil filter and tighten.

Torque: 19 lbf-ft (26 N·m, 2.7 kgf·m)

10. Install new sealing washers onto the drain bolts. Tighten the drain bolts.

Torque: 22 lbf-ft (30 N·m, 3.1 kgf·m)

11. Fill the crankcase with the recommended oil (2 P. 86, 2 P. 184) and install the oil fill cap.

Required oil

When changing oil & engine oil filter:

CRF1000A

4.3 US qt (4.1 L)

CRF1000D

4.4 US qt (4.2 L)

When changing oil only:

CRF1000A

4.1 US qt (3.9 L)

CRF1000D

4.2 US qt (4.0 L)

12. Check the oil level. 2 P. 104
13. Check that there are no oil leaks.
14. Install the skid plate.

Changing Clutch Oil Filter

CRF1000D

Use a new Honda Genuine clutch oil filter or equivalent specified for your model.

NOTICE

Using the wrong clutch oil filter can result in serious damage to the transmission.

1. Follow the steps 1-7 of Changing Engine Oil & Filter. 2 P. 106

2. Remove the clutch oil filter cover, clutch oil filter and spring by removing the clutch oil filter cover bolts.
 - u Discard the oil and clutch oil filter at an approved recycling center.

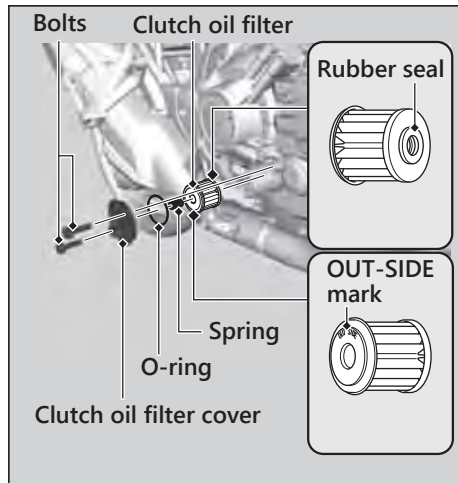

3. Install the new clutch oil filter with the rubber seal facing in, toward the engine. You will see "OUT-SIDE" mark on the clutch oil filter body, toward the filter cover.
4. Replace the O-ring and apply a thin coat of engine oil to the new O-ring when before installing it.
5. Install the spring and the clutch oil filter cover.
6. Install the clutch oil filter cover bolts and tighten.

Torque: 9 lbf·ft (12 N·m, 1.2 kgf·m)

7. Apply a thin coat of engine oil to the rubber seal of a new engine oil filter.
≥ P. 107
8. Install a new engine oil filter and tighten.

Torque: 19 lbf·ft (26 N·m, 2.7 kgf·m)

9. Install a new sealing washers onto the drain bolts. Tighten the drain bolts.

Torque: 22 lbf·ft (30 N·m, 3.1 kgf·m)

10. Fill the crankcase with the recommended oil (≥ P. 86, ≥ P. 184) and install the oil fill cap.

Required oil

When changing oil, engine oil filter & clutch oil filter:

4.4 US qt (4.2 L)

11. Check the oil level. ≥ P. 104
12. Check that there are no oil leaks.
13. Install the skid plate.

Checking the Coolant

Check the coolant level in the reserve tank while the engine is cold.

1. Place your motorcycle on a firm, level surface.
2. Hold your motorcycle in an upright position.
3. Check that the coolant level is between the UPPER level and LOWER level marks in the reserve tank.

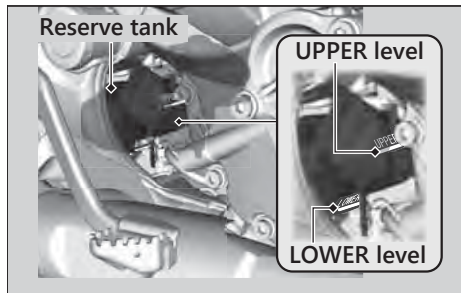

If the coolant level is dropping noticeably or the reserve tank is empty, you likely have a serious leak. Have your motorcycle inspected by your dealer.

Adding Coolant

If the coolant level is below the LOWER level mark, add the recommended coolant (2 P. 89) until the level reaches the UPPER level mark.

Add fluid only from the reserve tank cap and do not remove the radiator cap.

1. Remove the reserve tank cap and add fluid while monitoring the coolant level.
 - U Do not overfill above the UPPER level mark.
 - U Make sure no foreign objects enter the reserve tank opening.
2. Securely reinstall the reserve tank cap.

3WARNING

Removing the radiator cap while the engine is hot can cause the coolant to spray out, potentially scalding you.

Always let the engine and radiator cool down before removing the radiator cap.



Changing Coolant

Have your dealer change the coolant unless you have the proper tools and are mechanically qualified.

Checking Brake Fluid

1. Place your motorcycle in an upright position on a firm, level surface.
2. **Front** Check that the brake fluid reservoir is horizontal and that the fluid level is above the LOWER level mark.
Rear Check that the brake fluid reservoir is horizontal and that the fluid level is between the LOWER level and UPPER level marks.

If the brake fluid level in either reservoir is below the LOWER level mark or the brake lever and pedal freeplay becomes excessive, inspect the brake pads for wear.

If the brake pads are not worn, you most likely have a leak. Have your motorcycle inspected by your dealer.

Front

Front brake fluid reservoir

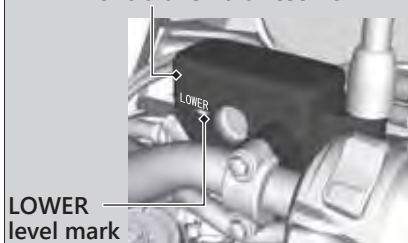

Rear

Rear brake fluid reservoir

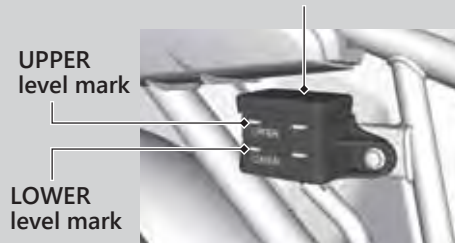

Inspecting the Brake Pads

Check the condition of the brake pad wear indicators.

Front The pads need to be replaced if a brake pad is worn to the bottom of the indicator.

Rear The pads need to be replaced if a brake pad is worn to the indicator.

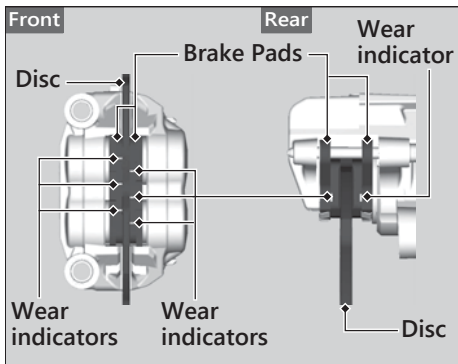

1. **Front** Inspect the brake pads from in front of the brake caliper.
 - U Always inspect both left and right brake calipers.
2. **Rear** Inspect the brake pads from the rear right of the motorcycle.

If necessary have the pads replaced by your dealer.

Always replace both left and right brake pads at the same time.

Checking the Parking Brake

CRF1000D

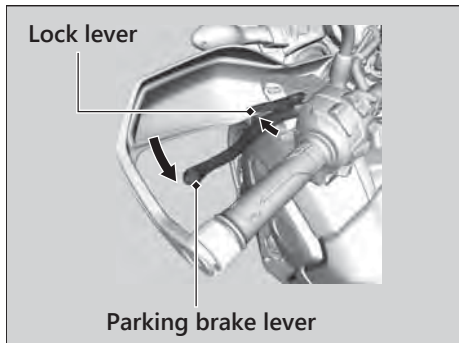

Place your motorcycle on a firm, level surface. Stop the engine and push your motorcycle while set the parking brake to check the efficacy of the parking brake.

If the efficacy of the parking brake becomes weak, have the brake adjusted by your dealer.

Adjusting the Brake Light Switch

Check the operation of the brake light switch. Hold the brake light switch and turn the adjusting nut in the direction A if the switch operates too late, or turn the nut in the direction B if the switch operates too soon.

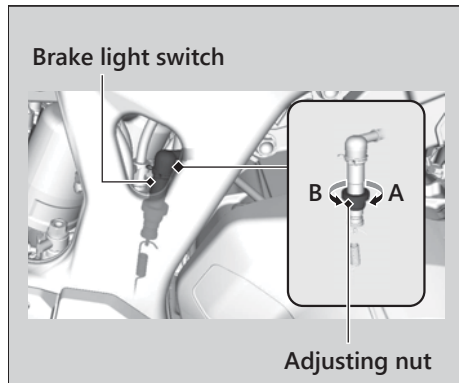

Checking the Side Stand

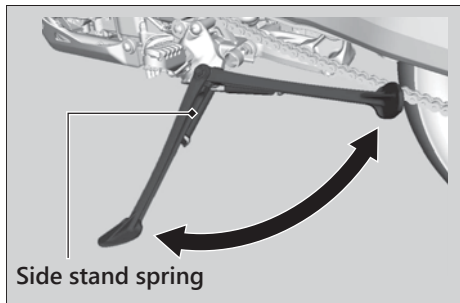

1. Check that the side stand operates smoothly. If the side stand is stiff or squeaky, clean the pivot area and lubricate the pivot bolt with clean grease.
2. Check the spring for damage or loss of tension.

3. **CRF1000A**
Sit on the motorcycle, put the transmission in Neutral, and raise the side stand.
- CRF1000D**
Sit on the motorcycle and raise the side stand.
4. **CRF1000A**
Start the engine, pull the clutch lever in, and shift the transmission into gear.
- CRF1000D**
Start the engine and press the D-S side of N-D switch to switch the transmission into D mode.
5. Lower the side stand all the way. The engine should stop as you lower the side stand. If the engine doesn't stop, have your motorcycle inspected by your dealer.

Inspecting the Drive Chain Slack

Check the drive chain slack at several points along the chain. If the slack is not constant at all points, some links may be kinked and binding.

Have the chain inspected by your dealer.

1. Shift the transmission to Neutral. Stop the engine.
2. Place your motorcycle on its side stand on a firm, level surface.

3. Check the slack in the lower half of the drive chain midway between the sprockets.

Drive chain slack:

1.4 - 1.8 in (35 - 45 mm)

- ⊐ Do not ride your motorcycle if the slack exceeds 2.4 in (60 mm).

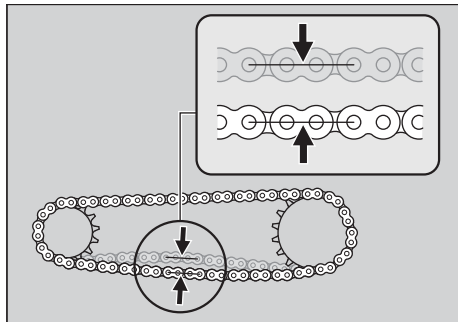

4. Roll the motorcycle forward and check that the chain moves smoothly.

Drive Chain \cup Adjusting the Drive Chain Slack

5. Inspect the sprockets. \geq P. 87
6. Clean and lubricate the drive chain.
 \geq P. 88

Adjusting the Drive Chain Slack

Adjusting the chain requires special tools. Have the drive chain slack adjusted by your dealer.

When adjusting the drive chain slack, be careful not to damage the wheel speed sensor and pulser ring.

1. Shift the transmission to Neutral. Stop the engine.
2. Place your motorcycle on its side stand on a firm, level surface.
3. Loosen the rear axle nut.
4. Loosen the lock nuts on both adjusting bolts.

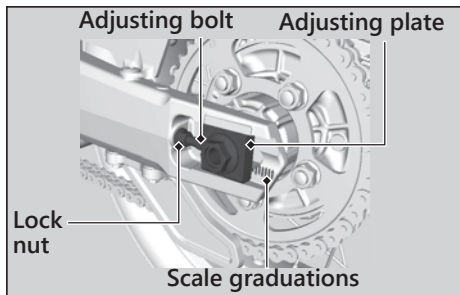
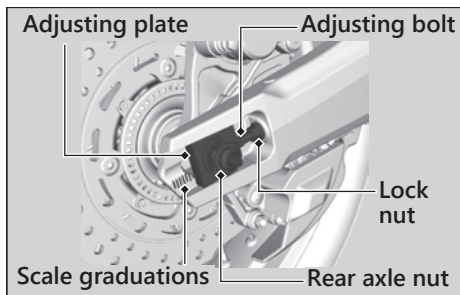

5. Turn both adjusting bolts an equal number of turns until the correct drive chain slack is obtained. Turn the adjusting bolts counterclockwise to tighten the chain. Turn the adjusting bolts clockwise and push the rear wheel toward the front to provide more slack.

Adjust the slack at a point midway between the drive sprocket and the driven sprocket.

Check the drive chain slack. \geq P. 117

6. Check rear axle alignment by making sure the end of the chain adjusting plate aligns with the scale graduations on both sides of the swingarm.

Both marks should correspond. If the axle is misaligned, turn the right or left adjusting bolts until the marks are aligned and recheck chain slack.

7. Tighten the rear axle nut.

Torque: 74 lbf·ft (100 N·m, 10.2 kgf·m)

8. Hold the adjusting bolts and tighten the lock nuts.

Torque: 20 lbf·ft (27 N·m, 2.8 kgf·m)

9. Recheck drive chain slack.

If a torque wrench was not used for installation, see your dealer as soon as possible to verify proper assembly. Improper assembly may lead to loss of braking capacity.

Checking the Drive Chain Wear

Check the chain wear label when adjusting the drive chain. If the indicator groove on the adjusting plate enters the red zone on the label after the chain has been adjusted to the proper slack, the chain is excessively worn and must be replaced.

Chain: DID 525HV3

If necessary have the drive chain replaced by your dealer.

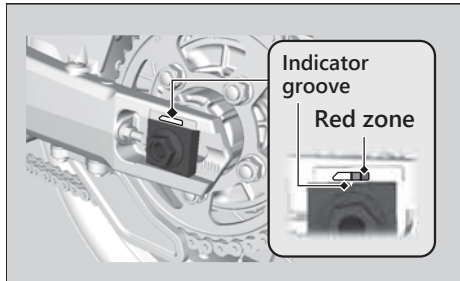

Checking the Drive Chain Slider

Check the condition of the drive chain slider. The drive chain slider will need to be replaced if the chain slider is worn to the wear limit line.

If necessary have the drive chain slider replaced by your dealer.

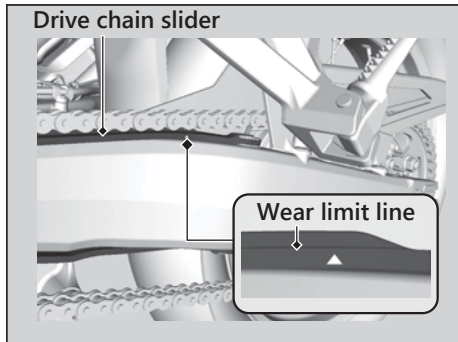

Wheels Rims & Spokes

Keeping the wheels true (round) and maintaining correct spoke tension is critical to safe motorcycle operation.

Excessively loose spokes may result in instability at high speeds and possible loss of control.

It is not necessary to remove the wheels to perform the recommended service in the Maintenance Schedule. However, information for wheel removal is provided for emergency situations. 2 P. 143

1. Inspect the wheel rims and spokes for damage.
2. Tighten any loose spokes.

3. Rotate the wheel slowly to see if it appears to “wobble.” If it does, the rim is out of round or not “true.” If the wobble is noticeable, see your dealer for inspection.

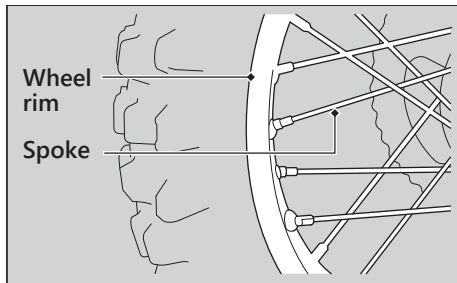

Checking the Clutch

CRF1000A

Checking the Clutch Lever Freeplay

Check the clutch lever freeplay.

Freeplay at the clutch lever:

0.4 - 0.8 in (10 - 20 mm)

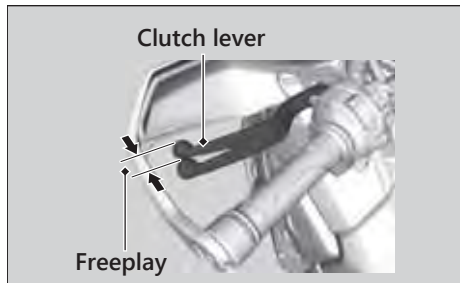

Check the clutch cable for kinks or signs of wear. If necessary have it replaced by your dealer.

Lubricate the clutch cable with a commercially available cable lubricant to prevent premature wear and corrosion.

NOTICE

Improper freeplay adjustment can cause premature clutch wear.

Adjusting the Clutch Lever Freeplay

CRF1000A

Upper Adjustment

Attempt adjustment with the upper clutch cable adjuster first.

1. Loosen the upper lock nut.
2. Turn the upper clutch cable adjuster until the freeplay is 0.4 - 0.8 in (10 - 20 mm).
3. Tighten the upper lock nut and check the freeplay again.

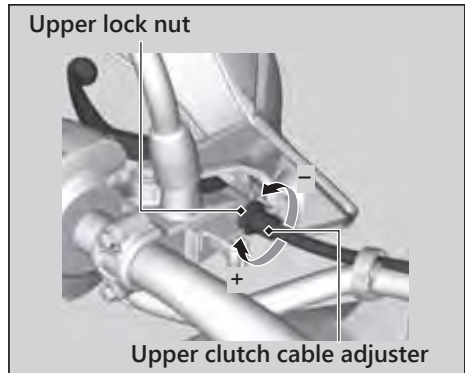

Lower Adjustment

If the upper clutch cable adjuster is threaded out near its limit, or the correct freeplay cannot be obtained, attempt adjustment with the lower clutch cable adjusting nut.

Clutch \cup Adjusting the Clutch Lever Freeplay

1. Loosen the upper lock nut and turn the upper clutch cable adjuster all the way in (to provide maximum freeplay). Tighten the upper lock nut.
2. Loosen the lower lock nut.
3. Turn the lower clutch cable adjusting nut until the clutch lever freeplay is 0.4 - 0.8 in (10 - 20 mm).
4. Tighten the lower lock nut and check the clutch lever freeplay.
5. Start the engine, pull the clutch lever in, and shift into gear. Make sure the engine does not stall and the motorcycle does not creep. Gradually release the clutch lever and open the throttle. Your motorcycle should move smoothly and accelerate gradually.

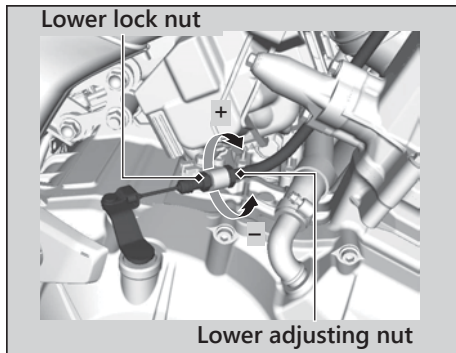

If proper adjustment cannot be obtained or the clutch does not work correctly, see your dealer.

Checking the Throttle

With the engine off, check that the throttle rotates smoothly from fully closed to fully open in all steering positions and throttle freeplay is correct. If the throttle does not move smoothly, close automatically, or if the cable is damaged, have the motorcycle inspected by your dealer.

Freeplay at the throttle grip flange:

0.1 - 0.2 in (2 - 6 mm)

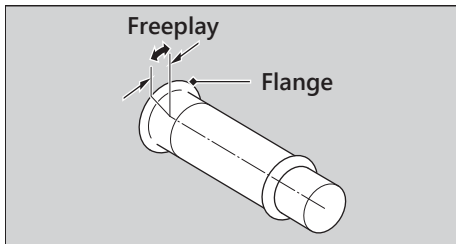

Adjusting the Throttle Freeplay

1. Loosen the lock nut.
2. Turn the adjuster until the freeplay is 0.1 - 0.2 in (2 - 6 mm).
3. Tighten the lock nut and inspect the throttle action again.

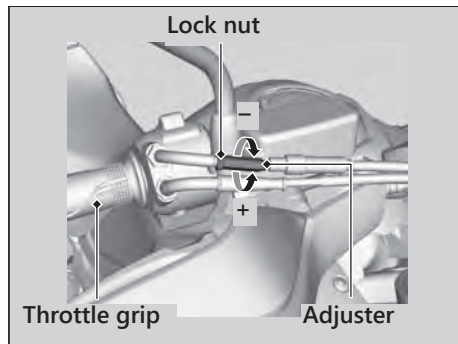

Cleaning the Crankcase Breather

1. Place a suitable container under the crankcase breather tubes.
2. Remove the crankcase breather tube plugs from the tubes.
3. Drain deposits into a suitable container.
4. Install the crankcase breather tube plugs.

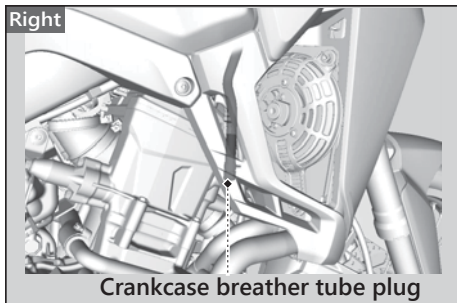
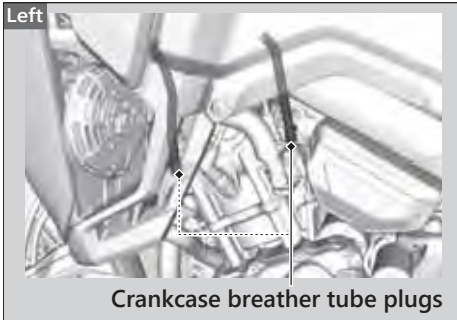

Adjusting the Headlight Aim

You can adjust vertical aim of the headlight for proper alignment. Turn the knob in or out as necessary.

Obey local laws and regulations.

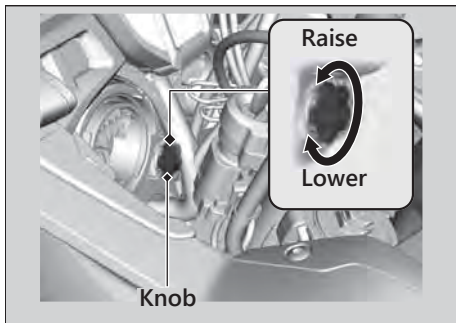

Adjusting the Brake Lever

You can adjust the distance between the tip of the brake lever and handle grip.

Adjustment method

Turn the adjuster until the numbers align with the index mark while pushing the lever forward in the desired position.

After adjustment, check that the lever operates correctly before riding.

NOTICE

Do not turn the adjuster beyond its natural limit.

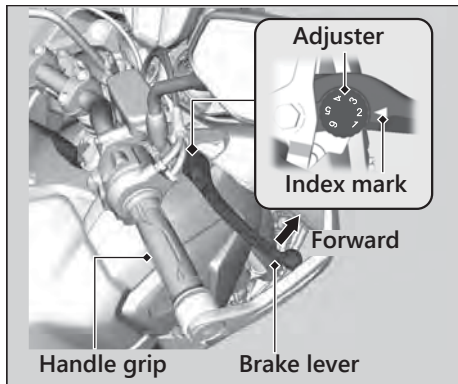

Adjusting the Front Suspension

I Spring Preload

You can adjust the spring preload by the adjuster to suit the load or the road surface. Turn the adjuster using a box end wrench. The spring preload adjuster has 15 turns. Turn clockwise to increase spring preload (hard), or turn counterclockwise to decrease spring preload (soft).

CRF1000A

The standard position is the 5 turns from the full soft position.

CRF1000D

The standard position is the 8.5 turns from the full soft position.

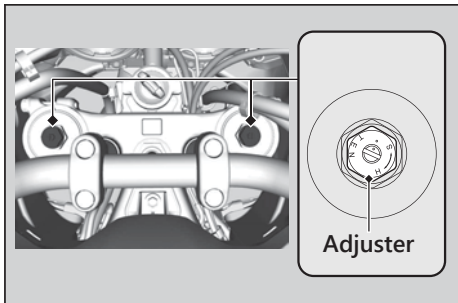

NOTICE

Do not turn the adjuster beyond its limits. Adjust both left and right forks to the same spring preload.

Rebound Damping

You can adjust the rebound damping by the adjuster to suit the load or the road surface. The rebound damping adjuster has 3 turns or more.

Turn clockwise to increase rebound damping (hard), or turn counterclockwise to decrease rebound damping (soft). The standard position is 2 1/4 turns from the maximum setting so that the punch mark on the adjuster aligns with the reference punch mark.

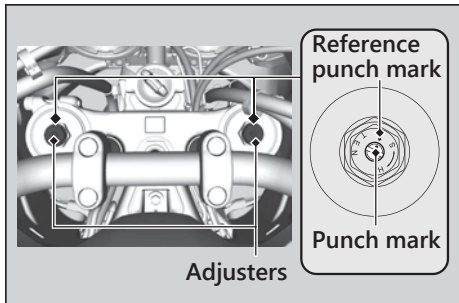

NOTICE

Do not turn the adjuster beyond its limits. Adjust both left and right forks to the same rebound damping.

Compression Damping

You can adjust the compression damping by the adjuster to suit the load or the road surface.

The compression damping adjuster has 12 position or more.

Turn clockwise to increase compression damping (hard), or turn counterclockwise to decrease compression damping (soft). Turn the adjuster clockwise (hard) until it will no longer turn (lightly seat). Turn the adjuster counterclockwise (soft) until it clicks.

The standard position is 8 clicks from the maximum setting.

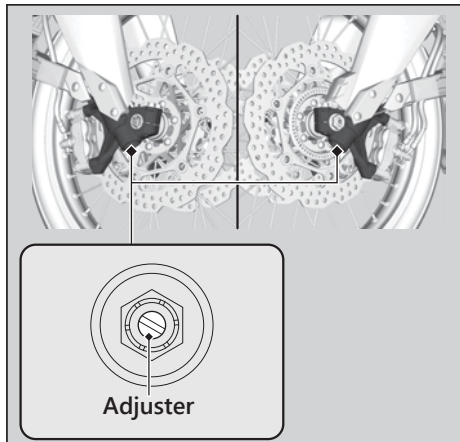

NOTICE

Do not turn the adjuster beyond its limits. Adjust both left and right forks to the same compression damping.

Adjusting the Rear Suspension

Spring Preload

You can adjust the spring preload by the adjuster knob to suit the load or the road surface. The spring preload adjuster has 35 position or more. Turn the clockwise to increase spring preload (high), or turn counterclockwise to decrease spring preload (low).

Turn the adjuster counterclockwise (low) until it will no longer turn (lightly seat). Turn the adjuster clockwise (high) until it clicks. This click is position 0.

The standard position is 7 clicks from the minimum setting.

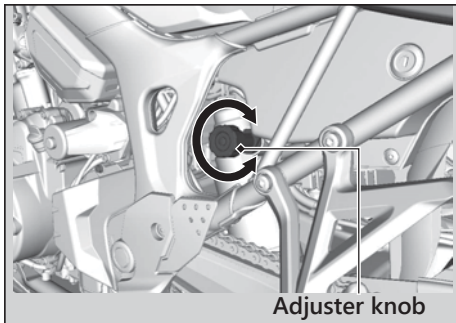

NOTICE

Do not turn the adjuster beyond its limits.

NOTICE

The rear shock absorber damper unit contains high pressure nitrogen gas. Do not attempt to disassemble, service, or improperly dispose of the damper. See your dealer.

Rebound Damping

You can adjust the rebound damping by the adjuster to suit the load or the road surface. Turn clockwise to increase rebound damping (hard), or turn counterclockwise to decrease rebound damping (soft). The standard position is 11 clicks from the maximum setting so that the punch mark on the adjuster aligns with the reference punch mark.

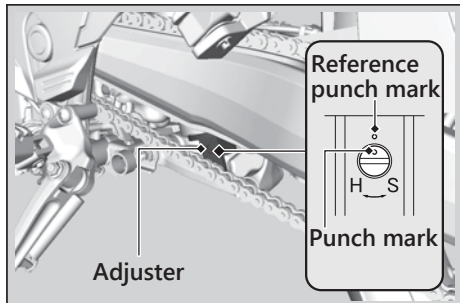

NOTICE

Do not turn the adjuster beyond its limits.

NOTICE

The rear shock absorber damper unit contains high pressure nitrogen gas. Do not attempt to disassemble, service, or improperly dispose of the damper. See your dealer.

Compression Damping

You can adjust the compression damping by the adjuster to suit the load or the road surface.

Turn clockwise to increase compression damping (hard), or turn counterclockwise to decrease compression damping (soft). The standard position is 14 clicks from the maximum setting so that the punch mark on the adjuster aligns with the reference punch mark.

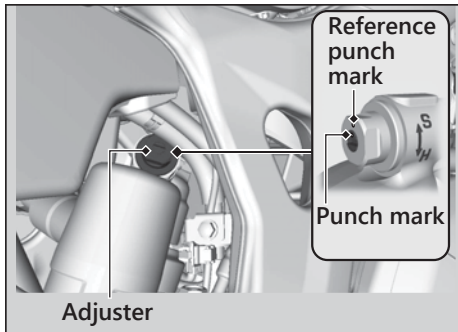

NOTICE

Do not turn the adjuster beyond its limits.

NOTICE

The rear shock absorber damper unit contains high pressure nitrogen gas. Do not attempt to disassemble, service, or improperly dispose of the damper. See your dealer.

Troubleshooting

Engine Will Not Start	P. 136		
Overheating (High coolant temperature indicator is on)	P. 137		
Warning Indicators On or Flashing	P. 138		
Low Oil Pressure Indicator	P. 138		
PGM-FI (Programmed Fuel Injection)			
Malfunction Indicator Lamp (MIL).....	P. 138		
ABS (Anti-lock Brake System) Indicator	P. 139		
Torque Control Indicator.....	P. 140		
If the “-” Indicator is Blinking in the Gear Position Window While Riding	P. 141		
Other Warning Indications	P. 142		
Fuel Gauge Failure Indication.....	P. 142		
		Coolant Temperature Gauge Failure	
		Indication	P. 142
		Tire Puncture	P. 143
		Electrical Trouble	P. 151
		Battery Goes Dead.....	P. 151
		Burned-out Light Bulb	P. 151
		Blown Fuse.....	P. 154

Starter Motor Operates But Engine Does Not Start

Check the following items:

- Check the correct engine starting sequence. 2 P. 58 2 P. 59
- Check that there is gasoline in the fuel tank.
- Check if the PGM-FI malfunction indicator lamp (MIL) is on.
 - u If the indicator light is on, contact your dealer as soon as possible.

Starter Motor Does Not Operate

Check the following items:

- Check the correct engine starting sequence. 2 P. 58
- Make sure engine stop switch is in the (Run) position. 2 P. 49, 2 P. 51
- Check for a blown fuse. 2 P. 154
- Check for a loose battery connection or battery terminal corrosion. 2 P. 82, 2 P. 95
- Check the condition of the battery. 2 P. 151

If the problem continues, have your motorcycle inspected by your dealer.

Overheating (High coolant temperature indicator is on)

The engine is overheating when the following occurs:

- High coolant temperature indicator comes on.
- The 6th (H) segment flashes in the coolant temperature gauge.
- Acceleration becomes sluggish.

If this occurs, pull safely to the side of the road and perform the following procedure.

Extended fast idling may cause the high coolant temperature indicator to come on.

Also the 6th (H) segment to flash.

NOTICE

Continuing to ride with an overheated engine can cause serious damage to the engine.

1. Stop the engine using the ignition switch, and then turn the ignition switch to the ON position.
2. Check that the radiator fan is operating, and then turn the ignition switch to the OFF position.

If the fan is not operating:

Suspect a fault. Do not start the engine. Transport your motorcycle to your dealer.

If the fan is operating:

Allow the engine to cool with the ignition switch in the OFF position.

3. After the engine has cooled, inspect the radiator hose and check if there is a leak.
 2 P. 110

If there is a leak:

Do not start the engine. Transport your motorcycle to your dealer.

4. Check the coolant level in the reserve tank. 2 P. 110
 U Add coolant as necessary.
5. If 1-4 check normal, you may continue riding, but closely monitor the temperature gauge.

Low Oil Pressure Indicator

If the low oil pressure indicator comes on, pull safely to the side of the road and stop the engine.

NOTICE

Continuing to ride with low oil pressure can cause serious damage to the engine.

1. Check the engine oil level, and add oil as necessary. \geq P. 104, \geq P. 105
2. Start the engine.
 - u Only continue riding if the low oil pressure indicator goes off.

Rapid acceleration may momentarily cause the low oil pressure indicator to come on, especially if the oil is at or near the low level. If the low oil pressure indicator stays on when the oil level is at the proper level, stop the engine and contact your dealer.

If the engine oil level goes down rapidly, your motorcycle may have a leak or another serious problem. Have your motorcycle inspected by your dealer.

PGM-FI (Programmed Fuel Injection) Malfunction Indicator Lamp (MIL)

If the indicator comes on while riding, you may have a serious problem with the PGM-FI system. Reduce speed and have your motorcycle inspected by your dealer as soon as possible.

ABS (Anti-lock Brake System) Indicator

If the indicator operates in one of the following ways, you may have a serious problem with the ABS. Reduce your speed and have your motorcycle inspected by your dealer as soon as possible.

- Indicator comes on or starts flashing while riding.
- Indicator does not come on when the ignition switch is in the ON position.
- Indicator does not go off at speeds above 6 mph (10 km/h).

If the ABS indicator stays on, your brakes will continue to work as a conventional system, but without the anti-locking function.

The ABS indicator may flash if you turn the rear wheel while your motorcycle is lifted off the ground. In this case, turn the ignition switch to the OFF position, and then to the ON position again. The ABS indicator will go off after your speed reaches 6 mph (10 km/h).

Torque Control Indicator

If the indicator operates in one of the following ways, you may have a serious problem with the Torque Control. Reduce your speed and have your motorcycle inspected by your dealer as soon as possible.

- Indicator comes and stays on (solid) while riding.
- Indicator does not come on when the ignition switch is turned to the ON position.
- Indicator does not go off at speeds above 6 mph (10 km/h).

Even when the Torque Control indicator is on, your motorcycle will have normal riding ability without Torque Control function.

- U When the indicator comes on while the Torque Control is in operation, you will have to completely close the throttle to regain normal riding ability.

The Torque Control indicator may come on if you rotate the rear wheel while your motorcycle is lifted off the ground. In this case, turn the ignition switch to the OFF position, and then to the ON position again. The Torque Control indicator will go off after your speed reaches 6 mph (10 km/h).

If the “-” Indicator is Blinking in the Gear Position Window While Riding

CRF1000D

If the “-” indicator is blinking while riding, you may have a serious problem with the Dual Clutch Transmission system.

Park your motorcycle in a safe place and have your motorcycle inspected by dealer immediately.

It may be possible to ride your motorcycle by following the steps below.

1. Turn the ignition switch to the OFF position.
2. Turn the ignition switch to the ON position and start the engine.

If you cannot start the engine:

Turn the ignition switch to the OFF position and move the motorcycle back and forth slightly (to disengage the gears).

Turn the ignition switch to the ON position again and start the engine.

If you still cannot start the engine:

Start the engine while applying the brake lever or pressing the brake pedal.

If you can shift from N to D mode:

When a gear position is shown in the gear position indicator, you can ride in that gear. Take your motorcycle to your dealer riding at a safe speed.

If you can't shift from N to D mode and the “-” indicator is blinking:

Damage is preventing you from riding. Have your motorcycle inspected by your dealer immediately.

Fuel Gauge Failure Indication

If the fuel system has an error, the fuel gauge indicators will be displayed as shown in the illustration.

If this occurs, see your dealer as soon as possible.

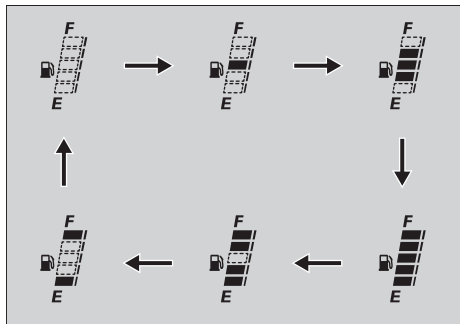

Coolant Temperature Gauge Failure Indication

If the cooling system has an error, all segments will blink or go off as shown in the illustration.

If this occurs, see your dealer as soon as possible.

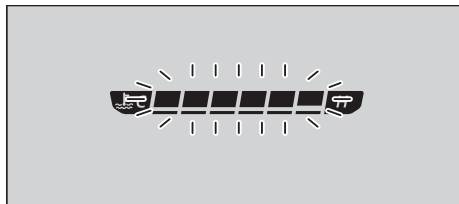

Repairing a puncture or removing a wheel requires special tools and technical expertise. We recommend you have this type of service performed by your dealer.

After an emergency repair, always have the tire inspected/replaced by your dealer.

Tube Repair and Replacement

If a tube is punctured or damaged, you should replace it as soon as possible. A tube that is repaired may not have the same reliability as a new one, and it may fail while you are riding.

If you need to make a temporary repair by patching a tube or using an aerosol sealant, ride cautiously at reduced speed and have the tube replaced before you ride again.

Anytime a tube is replaced, the tire should be carefully inspected as described.

3WARNING

Riding your motorcycle with a temporary tire or tube repair can be risky. If the temporary repair fails, you can crash and be seriously injured or killed.

If you must ride with a temporary tire or tube repair, ride slowly and carefully and do not exceed 30 mph (50 km/h) until the tire or tube is replaced.

Removing Wheels

Follow these procedures if you need to remove a wheel in order to repair a puncture.

When removing and installing the wheel, be careful not to damage the wheel speed sensor and pulser ring.

Front Wheel

Removal

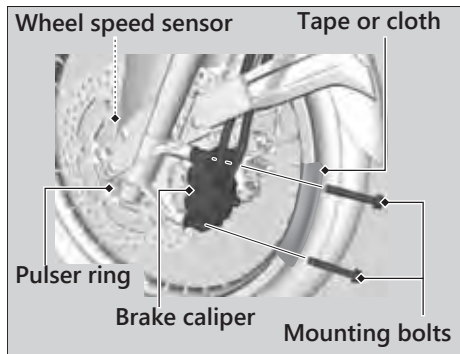

1. Place your motorcycle on a firm, level surface.
2. Cover both sides of the front wheel and brake caliper with protective tape or cloth.
3. On the right side, remove the mounting bolts and remove the brake caliper.
4. On the left side, remove the mounting bolts and remove the brake caliper.
 - ∪ Support the brake caliper assembly so that it doesn't hang from the brake hose. Do not twist the brake hose.
 - ∪ Avoid getting grease, oil, or dirt on the disc or pad surfaces.
 - ∪ Do not pull the brake lever while the brake caliper is removed.
 - ∪ Take care to prevent the brake caliper from scratching the wheel during removal.

5. Remove the front axle nut.
6. Loosen the left axle pinch bolts.
7. Support your motorcycle securely and raise the front wheel off the ground using a maintenance stand or a hoist.

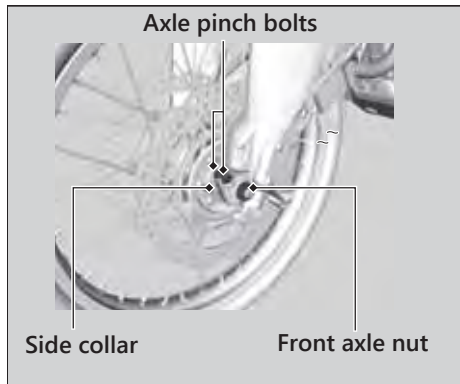

8. Loosen the right axle pinch bolts.
9. On the right side, loosen and withdraw the front axle shaft, and remove the side collars and wheel.

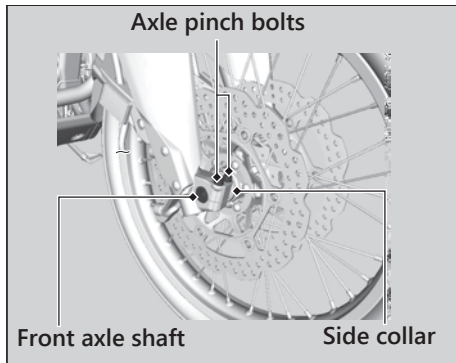

Installation

1. Attach the side collars to the wheel.
2. On the right side, place the wheel between the fork legs and insert the lightly greased front axle shaft to the end, through the right fork leg and wheel hub.
3. Align the end of the front axle shaft with the surface of the fork leg.

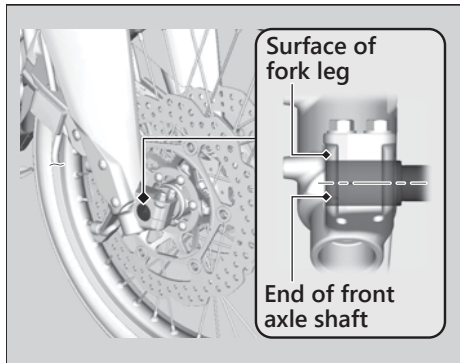

4. Tighten the right axle pinch bolts to hold the axle.
5. Tighten the axle nut.

Torque: 44 lbf·ft (60 N·m, 6.1 kgf·m).

6. Loosen the right axle pinch bolts.
7. Tighten the left axle pinch bolts.

Torque: 16 lbf·ft (22 N·m, 2.2 kgf·m).

8. Install the right brake caliper and tighten the mounting bolts.

Torque: 33 lbf·ft (45 N·m, 4.6 kgf·m).

9. Install the left brake caliper and tighten the mounting bolts.

Torque: 33 lbf·ft (45 N·m, 4.6 kgf·m).

- U Take care to prevent the brake caliper from scratching the wheel during installation.
- U Use new mounting bolts when installing the brake caliper.

NOTICE

When installing a wheel or caliper into original position, carefully fit the brake disc between the pads to avoid scratching them.

10. Lower the front wheel on the ground.
11. Apply the brake lever several times. Then, pump the fork several times.
12. Retighten the right axle pinch bolts.

Torque: 16 lbf·ft (22 N·m, 2.2 kgf·m).

13. Raise the front wheel off the ground again, and check that the wheel rotates freely after you release the brake.
14. Remove the protective tape or cloth.

If a torque wrench was not used for installation, see your dealer as soon as possible to verify proper assembly. Improper assembly may lead to loss of braking capacity.

Rear Wheel

Removal

1. Support your motorcycle securely and raise the rear wheel off the ground using a maintenance stand or a hoist.
2. Loosen the rear axle nut, lock nuts and turn the adjusting bolts so the rear wheel can be moved all the way forward for maximum drive chain slack.
3. Remove the rear axle nut and washer.
4. Remove the drive chain from the driven sprocket by pushing the rear wheel forward.
5. Remove the rear axle shaft and adjusting plates.

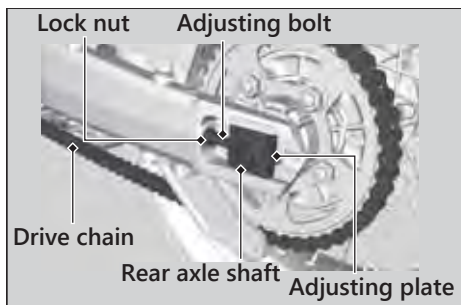
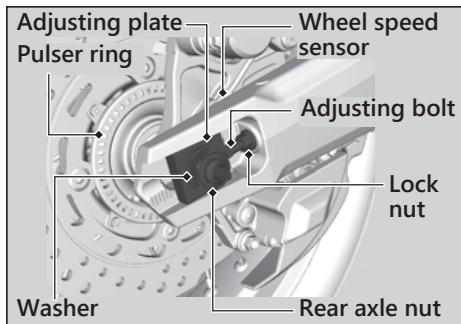

6. Remove the rear wheel and side collars.
 - U Avoid getting grease, oil, or dirt on the disc or pad surfaces.
 - U Do not push the brake pedal while the wheel is removed.
 - U **CRF1000D**
Do not set the parking brake while the wheel is removed.

Installation

1. To install the rear wheel, reverse the removal procedure.
 - U Take care to prevent the brake caliper from scratching the wheel during installation.

NOTICE

When installing a wheel or caliper into original position, carefully fit the brake disc between the pads to avoid scratching them.

2. Make sure that the slot on the brake caliper bracket is positioned in the lug on the swingarm.

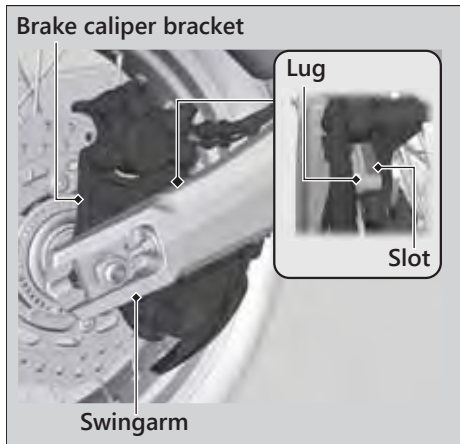

3. Adjust the drive chain. 2 P. 118
4. Install and tighten the rear axle nut.

Torque: 74 lbf·ft (100 N·m, 10.2 kgf·m).

5. After installing the wheel, apply the brake pedal several times, then check if the wheel rotates freely. Recheck the wheel if the brake drags or if the wheel does not rotate freely.

If a torque wrench was not used for installation, see your dealer as soon as possible to verify proper assembly. Improper assembly may lead to loss of braking capacity.

Battery Goes Dead

Charge the battery using a motorcycle battery charger.

Remove the battery from the motorcycle before charging.

Do not use an automobile-type battery charger, as these can overheat a motorcycle battery and cause permanent damage. If the battery does not recover after recharging, contact your dealer.

NOTICE

Jump starting using an automobile battery is not recommended, as this can damage your motorcycle's electrical system.

Burned-out Light Bulb

Follow the procedure below to replace a burned-out light bulb.

Turn the ignition switch to the OFF or LOCK position.

Allow the bulb to cool before replacing it.

Do not use bulbs other than those specified.

Check the replacement bulb for correct operation before riding.

For the light bulb wattage, see "Specifications." 2 P. 185

| Headlight

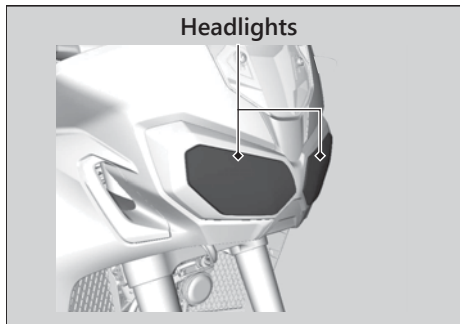

The headlights uses several LEDs. If there is a LED which is not turned on, see your dealer for this service.

| Brake/Taillight

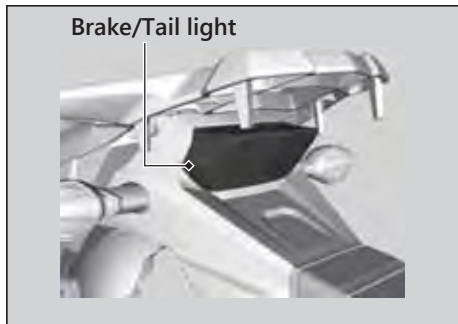

The brake and taillight uses several LEDs. If there is a LED which is not turned on, see your dealer for this service.

Front/Rear Turn Signal Bulb

1. Remove the screw.
2. Remove the turn signal lens and lens packing.
3. Slightly press the bulb and turn it counterclockwise.

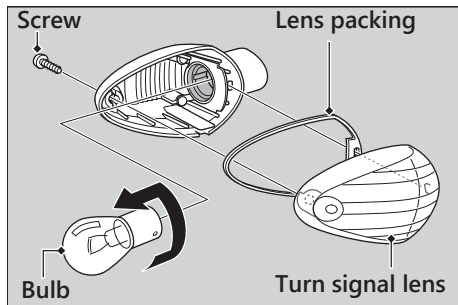

4. Install a new bulb and parts in the reverse order of removal.

License Plate Light Bulb

1. Remove the screws.
2. Remove the license plate light cover and license plate light cover packing.
3. Pull out the bulb without turning.

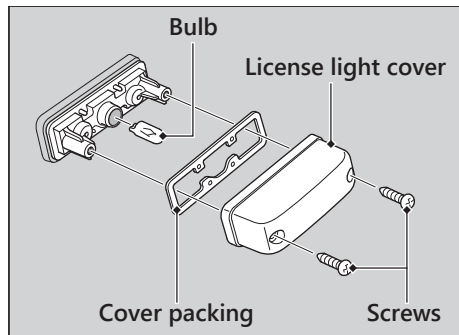

4. Install a new bulb and parts in the reverse order of removal.

Blown Fuse

Before handling fuses, see “Inspecting and Replacing Fuses.” 2 P. 85

Fuse Box Fuses

1. Remove the front seat. 2 P. 98
2. Open the fuse box covers.
3. Pull the fuses out with the fuse puller in the tool kit one by one check for a blown fuse. Always replace a blown fuse with a spare fuse of the same rating.
4. Close the fuse box covers.
5. Reinstall the front seat.

CRF1000A

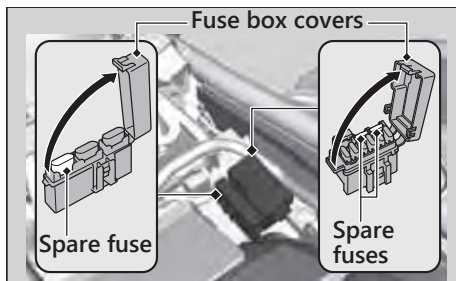

CRF1000D

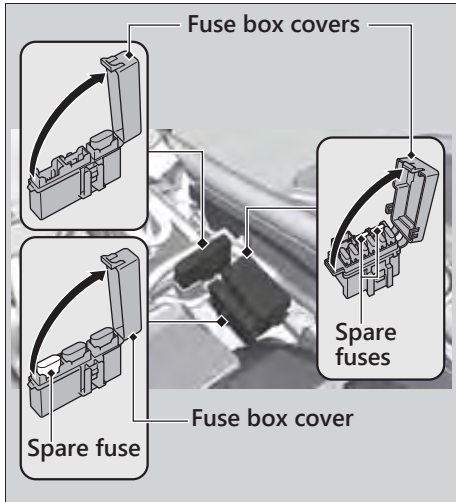

Main Fuse & FI Fuse

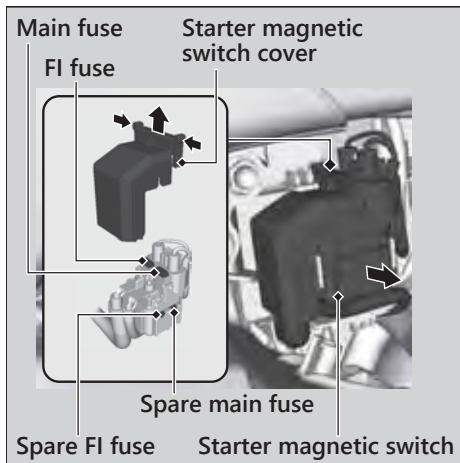

1. Remove the battery box cover. 2 P. 97
2. Pull the starter magnetic switch out.
3. Remove the starter magnetic switch cover.
4. Pull the main fuse and FI fuse out with the fuse puller in the tool kit one by one check for a blown fuse. Always replace a blown fuse with a spare fuse of the same rating.
 - U Spare main fuse is provided in the starter magnetic switch.
5. Reinstall parts in the reverse order of removal.

ABS Main Fuse

CRF1000A

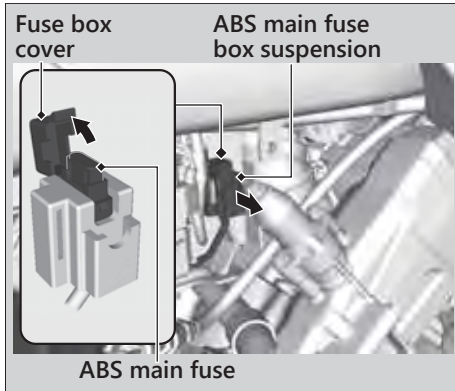

1. Remove the battery box cover. 2 P. 97
2. Pull the ABS main fuse box suspension out.
3. Open the fuse box cover.
4. Pull the ABS main fuses out with the fuse puller in the tool kit and check for a blown fuse. Always replace a blown fuse with a spare fuse of the same rating.
 - ∪ Spare main fuse is provided in the starter magnetic switch.
5. Reinstall parts in the reverse order of removal.

ABS Main Fuse & DCT Main Fuse

CRF1000D

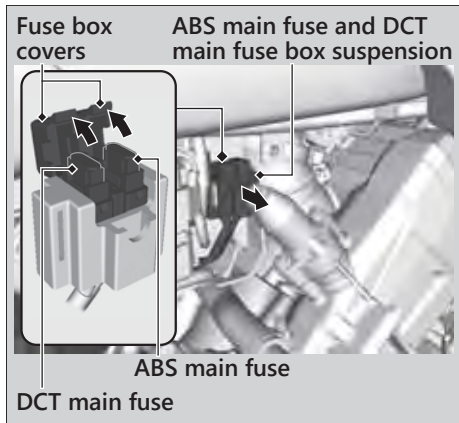

1. Remove the battery box cover. 2 P. 97
2. Pull the ABS main fuse and DCT main fuse box suspension out.
3. Open the fuse box covers.
4. Pull the ABS main fuses and DCT main fuse out with the fuse puller in the tool kit one by one check for a blown fuse. Always replace a blown fuse with a spare fuse of the same rating.
U Spare main fuse is provided in the starter magnetic switch.
5. Reinstall parts in the reverse order of removal.

NOTICE

If a fuse fails repeatedly, you likely have an electrical problem. Have your motorcycle inspected by your dealer.

Information

Keys.....	P. 160
Instruments, Controls, & Other Features...	P. 161
Caring for Your Motorcycle.....	P. 163
Storing Your Motorcycle.....	P. 167
Transporting Your Motorcycle.....	P. 168
You & the Environment.....	P. 169
Vehicle Identification Number.....	P. 170
Emission Control Systems.....	P. 171
Catalytic Converter.....	P. 175
Oxygenated Fuels.....	P. 176
Authorized Manuals.....	P. 177
Warranty Coverage and Service.....	P. 178
Honda Contacts.....	P. 180
USA Reporting Safety Defects.....	P. 182

Keys

Ignition Key

This motorcycle has two ignition keys and a key tag with a key number and a bar code. Store the spare key and the key tag in a safe location. To make a duplicate key, take the spare key and the key tag to your dealer or a locksmith. If you lose all keys and the key tag, the ignition switch assembly will probably have to be removed by your dealer to determine the key number.

A metal key holder may cause damage to the area surrounding the ignition switch.

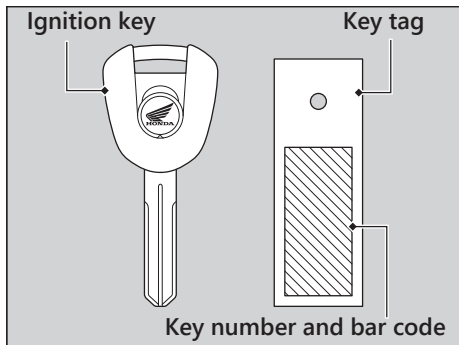

Instruments, Controls, & Other Features

Ignition Switch

Leaving the ignition switch in the ON position with the engine stopped will drain the battery. Do not turn the key while riding.

Engine Stop Switch

Do not use the engine stop switch except in an emergency. Doing so when riding will cause the engine to suddenly turn off, making riding unsafe.

If you stop the engine using the engine stop switch, turn the ignition switch to the OFF position. Failing to do so will drain the battery.

Odometer

The display locks at 999,999 when the read-out exceeds 999,999.

Tripmeter

The tripmeter A and B return to 0.0 when each read-out exceeds 99,999.9. Also average fuel mileage and average speed are reset at the same time.

Document Bag

The owner's manual, registration, and insurance information can be stored in the plastic document bag located on the underside of the front seat. 2 P. 71

Ignition Cut-off System

A banking (lean angle) sensor automatically stops the engine and fuel pump if the motorcycle falls over. To reset the sensor, you must turn the ignition switch to the OFF position and back to the ON position before the engine can be restarted.

Assist-slipper Clutch System

The assist-slipper clutch system helps to prevent the rear tire from locking up when the deceleration of your motorcycle produces a strong engine braking effect. It also makes the clutch lever operation feel lighter.

Use only MA classification engine oil for your motorcycle. Using engine oil other than MA classification oil could result in damage to the assist-slipper clutch system.

Caring for Your Motorcycle

Frequent cleaning and polishing is important to ensure the life of your Honda. A clean motorcycle makes it easier to spot potential problems.

In particular, seawater and salts used to prevent ice on roads promote the formation of corrosion. Always wash your motorcycle thoroughly after riding on coastal or treated roads.

Washing

Allow the engine, muffler, brakes, and other high-temperature parts to cool before washing.

1. Rinse your motorcycle thoroughly using a low pressure garden hose to remove loose dirt.

2. If necessary, use a sponge or a soft towel with mild cleaner to remove road grime.
 - U Clean the windscreen, headlight lens, panels, and other plastic components with extra care to avoid scratching them. Avoid directing water into the air cleaner, muffler, and electrical parts.
3. Thoroughly rinse your motorcycle with plenty of clean water and dry with a soft, clean cloth.
4. After the motorcycle dries, lubricate any moving parts.
 - U Make sure that no lubricant spills onto the brakes or tires. Brake discs, pads, drum or shoes contaminated with oil will suffer greatly reduced braking effectiveness and can lead to a crash.
5. Lubricate the drive chain immediately after washing and drying the motorcycle.

Caring for Your Motorcycle

6. Apply a coat of wax to prevent corrosion.
 - ⊍ Avoid products that contain harsh detergents or chemical solvents. These can damage the metal, paint, and plastic on your motorcycle. Keep the wax clear of the tires and brakes.
 - ⊍ If your motorcycle has any matte painted parts, do not apply a coat of wax to the matte painted surface.

Washing Precautions

Follow these guidelines when washing:

- Do not use high-pressure washers:
 - ⊍ High-pressure water cleaners can damage moving parts and electrical parts, rendering them inoperable.
 - ⊍ Water in the air intake can be drawn into the throttle body and/or enter the air cleaner.
- Do not direct water at the muffler:
 - ⊍ Water in the muffler can prevent starting and causes rust in the muffler.
- Dry the brakes:
 - ⊍ Water adversely affects braking effectiveness. After washing, apply the brakes intermittently at low speed to help dry them.
- Do not direct water under the seat:
 - ⊍ Water in the under seat compartment can damage your documents and other belongings.
- Do not direct water at the air cleaner:
 - ⊍ Water in the air cleaner can prevent the engine from starting.
- Do not direct water near the headlight:
 - ⊍ Any condensation inside the headlight should dissipate after a few minutes of running the engine.

- Do not use wax or polishing compounds on matte painted surface:
 - Use a soft cloth or sponge, plenty of water, and a mild detergent to clean matte painted surfaces. Dry with a soft clean cloth.

Aluminum Components

Aluminum will corrode from contact with dirt, mud, or road salt. Clean aluminum parts regularly and follow these guidelines to avoid scratches:

- Do not use stiff brushes, steel wool, or cleaners containing abrasives.
- Avoid riding over or scraping against curbs.

Panels

Follow these guidelines to prevent scratches and blemishes:

- Wash gently using a soft sponge and plenty of water.
- To remove stubborn stains, use diluted detergent and rinse thoroughly with plenty of water.
- Avoid getting gasoline, brake fluid, or detergents on the instruments, panels, or headlight.

Windscreen

Using plenty of water, clean the windscreen with a soft cloth or sponge. (Avoid using detergents or any kind of chemical cleaner on the windscreen.) Dry with a soft, clean cloth.

NOTICE

To avoid possible scratching or other damage, use only water and a soft cloth or sponge to clean the windscreen.

Caring for Your Motorcycle

For a dirtier windscreen, use a diluted neutral detergent with a sponge and plenty of water. Make sure to wash off all the detergent. (Detergent residue may cause windscreen cracks.)

Replace the windscreen if scratches cannot be removed and they obstruct clear vision.

Take care to keep battery electrolyte, brake fluid, or other chemical solvents off the windscreen and screen garnish. They will damage the plastic.

Exhaust Pipe and Muffler

The exhaust pipe and muffler are stainless steel but may become stained by mud or dust.

To remove mud or dust, use a wet sponge and a liquid kitchen abrasive, then rinse well with clean water. Dry with chamois or a soft towel.

If necessary, remove heat stains by using a commercially available fine texture compound. Then rinse by the same manner as removing mud or dust.

When the exhaust pipe and muffler are painted, do not use a commercially available abrasive kitchen cleaning compound. Use a neutral detergent to clean the painted surface on the exhaust pipe and muffler. If you are not sure if your exhaust pipe and muffler are painted, contact your dealer.

NOTICE

Even though the exhaust is made of stainless steel, it can become stained. Remove all marks and blemishes as soon as they are noticed.

Storing Your Motorcycle

If you store your motorcycle outdoors, you should consider using a full-body motorcycle cover.

If you won't be riding for an extended period, follow these guidelines:

- Wash your motorcycle and wax all painted surfaces (except matte painted surfaces). Coat chrome pieces with rust-inhibiting oil.
- Lubricate the drive chain. 2 P. 88
- Place your motorcycle on a maintenance stand and position a block so that both tires are off the ground.
- After rain, remove the body cover and allow the motorcycle to dry.
- Remove the battery (2 P. 95) to prevent discharge. Charge the battery in a shaded, well-ventilated area.
 - ⌋ If you leave the battery in place, disconnect the negative - terminal to prevent discharge.

After removing your motorcycle from storage, inspect all maintenance items required by the Maintenance Schedule.

USA For more information about storage, refer to the *Honda Winter Storage Guide*, available from your dealer.

Canada For more information about storage, visit our website at www.honda.ca and look up "Storage Tips" under the "Honda Warranty" in the Warranty tab for your Model.

Transporting Your Motorcycle

If your motorcycle needs to be transported, it should be carried on a motorcycle trailer or a flatbed truck or trailer that has a loading ramp or lifting platform, and motorcycle tie-down straps. Never try to tow your motorcycle with a wheel or wheels on the ground.

NOTICE

Towing your motorcycle can cause serious damage to the transmission.

You & the Environment

Owning and riding a motorcycle can be enjoyable, but you must do your part to protect the environment.

Choose Sensible Cleaners

Use a biodegradable detergent when you wash your motorcycle. Avoid aerosol spray cleaners that contain chlorofluorocarbons (CFCs) which damage the atmosphere's protective ozone layer.

Recycle Wastes

Put oil and other toxic wastes in approved containers and take them to a recycling center. Call your local or state office of public works or environmental services to find a recycling center in your area, and to get instructions on how to dispose of non-recyclable wastes. Do not place used engine oil in the trash, or pour it down a

drain or on the ground. Used oil, gasoline, coolant, and cleaning solvents contain poisons that can hurt refuse workers and contaminate drinking water, lakes, rivers, and oceans.

Vehicle Identification Number

The VIN and engine serial number uniquely identify your motorcycle and are required in order to register your motorcycle. They may also be required when ordering replacement parts.

You should record these numbers and keep them in a safe place.

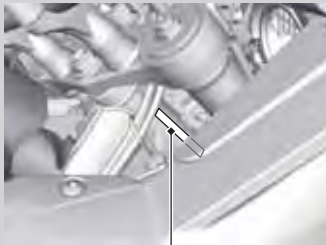

VIN

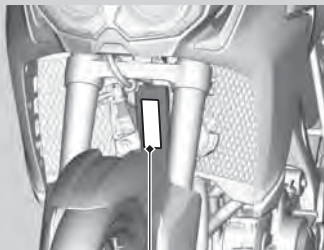

VIN

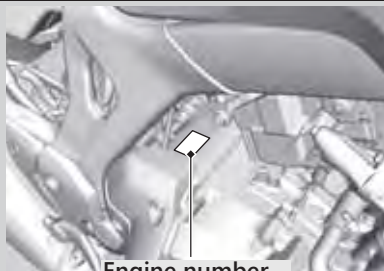

Engine number

Emission Control Systems

Your motorcycle engine emits combustion byproducts, including carbon monoxide (CO), oxides of nitrogen (NO_x), and hydrocarbons (HC). Gasoline evaporation also emits hydrocarbons. Controlling the production of NO_x, CO, and HC is important for the environment.

Exhaust Emission Requirements

The U.S. Environmental Protection Agency (EPA), the California Air Resources Board (CARB), and Environment Canada (EC) require that your motorcycle comply with applicable exhaust, crankcase, and fuel permeation emission standards during its useful life, when operated and maintained according to the instructions provided.

CARB also requires that your motorcycle comply with applicable evaporative emission requirements during its useful life, when

operated and maintained according to the instructions provided.

USA Compliance with the terms of the Distributor's Warranties for Honda Motorcycle Emission Control Systems is necessary in order to maintain a valid emissions system warranty.

The Vehicle Emission Control Information label is located left side of the rear frame.

Canada The Vehicle Emission Control Information label is located right side of the rear frame.

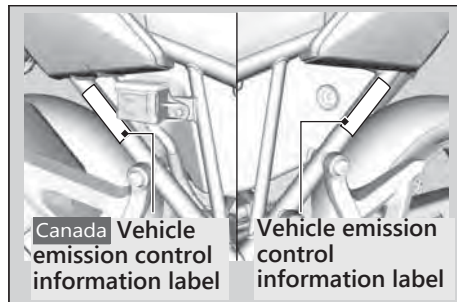

Noise Emission Requirements

The EPA requires that motorcycles built after January 1, 1983 comply with applicable noise emission standards for one year or 3,730 miles (6,000 km) after the time of purchase when operated and maintained according to the instructions provided.

Exhaust Emission Control System

The exhaust emission control system includes the following components that should not need adjustment, although periodic inspection by your dealer is recommended.

PGM-FI System

The PGM-FI (programmed fuel injection) system uses sequential multiport fuel injection, and is comprised of air intake, engine control, fuel control, and exhaust control subsystems. The engine control module (ECM) uses sensors to determine how much air enters the engine, and then controls how much fuel to inject.

Ignition Timing Control System

The ignition timing control system adjusts the ignition timing to reduce the amount of HC, CO, and NO_x produced.

Secondary Air Injection System

The secondary air injection system adds filtered air into the exhaust gas to help improve emission control performance.

Catalytic Converters

The exhaust system contains one or more catalytic converters. Catalytic converters use a catalyst to convert most of the harmful exhaust gas compounds into harmless compounds.

Evaporative Emission Control System

50 STATE (meets California)

An evaporative emissions control system uses a canister filled with charcoal to adsorb fuel vapor from the fuel tank while the engine is off. The vapor is drawn into the engine and burned while riding.

Crankcase Emissions Control System

The engine is equipped with a closed crankcase system to prevent discharging crankcase emissions into the atmosphere. Blow-by gas is returned to the combustion chamber through the crankcase breather hose, air cleaner and throttle body.

Fuel Permeation Emission Control

The fuel tank, fuel hoses, and fuel vapor charge hoses use fuel permeation control technologies to prevent fuel vapor emissions. Tampering with these components to reduce or defeat the effectiveness of the fuel permeation technologies is prohibited.

Noise Emission Control System

TAMPERING WITH THE NOISE CONTROL SYSTEM IS PROHIBITED:

U. S. federal law prohibits, and Canadian provincial laws may prohibit, the following acts or the causing thereof: (1) The removal or rendering inoperative by any person, other than for purposes of maintenance, repair or replacement, of any device or element of design incorporated into any new vehicle for the purpose of noise control prior to its sale or delivery to the ultimate purchaser or while it is in use; or (2) the use of the vehicle after such device or element of design has been removed or rendered inoperative by any person.

AMONG THOSE ACTS PRESUMED TO CONSTITUTE TAMPERING ARE THE FOLLOWING ACTS:

- Removal of, or puncturing the muffler, baffles, header pipes or any other component which conducts exhaust gases.
- Removal of, or puncturing of any part of the intake system.
- Lack of proper maintenance.
- Removing or disabling any emissions compliance component, or replacing any compliance component with a noncompliant component.

Problems Affecting Motorcycle Exhaust Emissions

Have your motorcycle inspected and repaired by your dealer if you experience any of the following symptoms:

- Hard starting or stalling after starting
- Rough idling
- Misfiring or backfiring during acceleration
- Poor engine performance and poor fuel economy

Catalytic Converter

This motorcycle is equipped with a three-way catalytic converter. The catalytic converter contains precious metals that serve as catalysts in high temperature chemical reactions that convert hydrocarbons (HC), carbon monoxide (CO), and oxides of nitrogen (NOx) in the exhaust gasses into safe compounds.

A defective catalytic converter contributes to air pollution and can impair your engine's performance. A replacement unit must be an original Honda part or equivalent.

Follow these guidelines to protect your motorcycle's catalytic converter.

- Always use unleaded gasoline. Leaded gasoline will damage the catalytic converter.
- Keep the engine in good running condition. A poorly running engine can cause the catalytic converter to overheat causing damage to the converter or the motorcycle.
- If your engine is misfiring, backfiring, stalling, or otherwise not running properly, stop riding and turn off the engine. Have your motorcycle serviced as soon as possible.

Oxygenated Fuels

Some conventional fuels blended with alcohol or an ether compound are available in some locales to help reduce emissions to meet clean air standards. These gasolines are collectively referred to as oxygenated fuels. If you plan to use oxygenated fuel, check that it is unleaded and meets the minimum octane rating and blend requirement.

The following fuel blends are EPA-approved and have been approved for use in your motorcycle:

- Ethanol (ethyl alcohol) up to 10% by volume.
 - ⊔ Gasoline containing ethanol may be marketed under the name Gasohol.
- Methanol (methyl alcohol) up to 5% by volume that contain cosolvents and corrosion inhibitors to protect the fuel system. Never use a blend containing more than 5%.

If you accidentally fill your fuel tank with an oxygenated fuel containing higher percentages,

you may experience performance problems. To resolve the problem, have your dealer drain the fuel tank and replace with the correct fuel. Fuel system or performance problems resulting from the use of an oxygenated fuel containing higher percentages are not covered by your warranty.

NOTICE

Improper use of oxygenated fuels can damage metal, rubber, and plastic parts of your fuel system.

Oxygenated fuel can also damage paint.

Damage caused by spilled fuel is not covered by warranty.

If you notice any undesirable operating symptoms or performance problems, try a different brand of gasoline.

Authorized Manuals

USA The Service Manual used by your authorized dealer is available from your Honda dealer or Helm, Inc.

Canada See your dealer to order authorized manuals.

Also available, but not necessary to service your model, is the Honda Common Service Manual, which explains basic service information for various systems on Honda motorcycles, scooters, and ATV.

USA The Winter Storage Guide in conjunction with the Owner's Manual and Service Manual can help you prepare your Honda motorcycle, scooter, ATV, and SxS for winter storage.

These Honda manuals are written for the professional technician. However, if you possess the proper tools, observe the safety standards, and are mechanically capable, you should find them easy to use. Special Honda tools are necessary for some procedures.

USA

Order On-Line: www.helminc.com

Order Toll Free: 1-888-CYCLE93

(1-888-292-5393)

(NOTE: For Credit Card Orders Only)

Monday - Friday 8:00 AM - 6:00 PM EST

Publication Item No.	Description
61MJP01	2017 CRF1000A/D Service Manual
61CSM00	Common Service Manual
S9507	USA Winter Storage Guide
31MJP610	2017 CRF1000A/D Owner's Manual

Warranty Coverage and Service

Coverage

Your new Honda is covered by the following warranties:

- Motorcycle Limited Warranty
- Emission Control System Warranty
- **USA** Noise Control Warranty

The responsibilities, restrictions, and exclusions that apply to these warranties are explained in the Warranties Booklet given to you by your Honda dealer at the time of purchase. Always keep your Honda owner's card with your Warranties Booklet.

Canada Please refer to the Warranty Booklet posted on our website at www.honda.ca.

It is important to realize that your warranty applies only to defects in material or workmanship of your Honda. Your warranty coverage does not apply to the normal wear and deterioration associated with use of the motorcycle.

Your warranty coverage is not voided if you perform your own maintenance. However, failures that occur due directly to improper maintenance are not covered by these warranties.

USA You can extend almost all of your warranty coverage through the Honda Protection Plan. For more information, see your Honda dealer.

Service

Please remember that maintenance recommended in the Maintenance Schedule is not included in your warranty coverage. If you believe you have a problem with your motorcycle, call the service department of your Honda dealer. Make an appointment for an inspection and diagnosis. You will be asked to authorize that inspection, and your dealer will return the results of the inspection. If a problem exists and is covered under warranty, your dealer will perform the warranty repairs. If you have any questions about your warranty coverage or the nature of the repair, talk to the Service Manager of your Honda dealer.

If a misunderstanding occurs and you aren't satisfied with your dealer's handling of the situation, we suggest you discuss your problem with the appropriate member of the dealership's management team. If you are still not satisfied, contact the owner of the dealership or their designated representative.

Honda Contacts

American Honda Motor Co., Inc.

If you wish to contact Honda directly to comment on your experiences with your motorcycle or with your dealer, please send your comments to the following address:

Motorcycle Division,
American Honda Motor Co., Inc.,
P.O. Box 2200, Torrance,
CA 90509-2200
Mailstop: 100-4C-7B,
Telephone: (866) 784-1870.

Canada

Honda Canada Inc.
Customer Relations Department,
180 Honda Boulevard
Markham, Ontario
L6C 0H9
Telephone: (888) 946-6329
Fax: (877) 939-0909
E-mail: honda_cr@ch.honda.com

Please include the following information in your letter:

- Name, address, and telephone number
- Product model, year, and VIN
- Date of purchase
- Dealer name and address

We will likely ask your Honda dealer to respond, or possibly acknowledge your comments directly.

Your Honda Dealer

The service department of your Honda dealer offers trained personnel to perform regular maintenance and most repairs. It has the latest available service information from Honda and also handles warranty inspections and repairs. The parts department offers Honda Genuine Parts, Pro Honda products, Honda Genuine Accessories (USA only), and Honda accessories and products (Canada only) that provide the same quality that went into your motorcycle.

USA The sales department offers the Honda Protection Plan to extend almost all of your warranty coverage.

Your Honda dealer can also supply information about, riding events, and information about safety training available in your local area, and the Honda Rider's Club of America (USA only).

Honda Rider's Club of America (HRCA)

The Honda Rider's Club of America (HRCA) sponsors local riding chapters at Authorized Honda Dealerships across the country.

USA Reporting Safety Defects

If you believe that your vehicle has a defect which could cause a crash or could cause injury or death, you should immediately inform the National Highway Traffic Safety Administration (NHTSA) in addition to notifying American Honda Motor Co., Inc.

If NHTSA receives similar complaints, it may open an investigation, and if it finds that a safety defect exists in a group of vehicles, it may order a recall and remedy campaign. However, NHTSA cannot become involved in individual problems between you, your dealer, or American Honda Motor Co., Inc.

To contact NHTSA, you may call the Vehicle Safety Hotline toll-free at:

1-888-327-4236

(TTY: 1-800-424-9153); go to

<http://www.safercar.gov>;

or write to:

Administrator, NHTSA,
1200 New Jersey Avenue, SE.,
Washington, DC 20590.

You can also obtain other information about motor vehicle safety from:

<http://www.safercar.gov>.

Specifications

■ Main Components

Overall length	91.9 in (2,335 mm)
Overall width	36.6 in (930 mm)
Overall height	58.1 in (1,475 mm)
Wheelbase	62.0 in (1,575 mm)
Minimum ground clearance	9.8 in (250 mm)
Caster angle	27° 30'
Trail	4.4 in (113 mm)
Curb weight	CRF1000A 511 lb (232 kg)
	CRF1000D 534 lb (242 kg)
Maximum weight capacity *1	392 lb (178 kg)
Maximum weight on rear carrier	22 lb (10 kg)
Passenger capacity	Rider and 1 passenger
Minimum turning radius	8.5 ft (2.6 m)
Displacement	60.9 cu-in (998 cm ³)
Bore x stroke	3.62 x 2.96 in (92.0 x 75.1 mm)

*1: Including rider, passenger, all luggage, and accessories

Compression ratio	10.0:1	
Fuel	Unleaded gasoline	
	Recommended: 86 PON or higher	
Tank capacity	4.97 US gal (18.8 L)	
Battery	YTZ14S	
	12V-11.2Ah (10 HR)	
Gear ratios	CRF1000A	
	1st	2.866
	2nd	1.888
	3rd	1.480
	4th	1.230
	5th	1.100
	6th	0.968
	CRF1000D	
	1st	2.562
	2nd	1.761
	3rd	1.375
	4th	1.133
5th	0.972	
6th	0.882	
Reduction ratios (primary / final)	CRF1000A	1.733 / 2.625
	CRF1000D	1.883 / 2.625

Specifications

■ Service Data

Tire size	Front	90/90-21M/C 54H
	Rear	150/70R18M/C 70H
Tire type	Front	Bias-ply, tube
	Rear	Radial, tube
Recommended Tires	Front	DUNLOP D610F
	Rear	DUNLOP D610
Tire air pressure (Driver only)	Front	29 psi (200 kPa, 2.00 kgf/cm ²)
	Rear	36 psi (250 kPa, 2.50 kgf/cm ²)
Tire air pressure (Driver and passenger)	Front	29 psi (200 kPa, 2.00 kgf/cm ²)
	Rear	41 psi (280 kPa, 2.80 kgf/cm ²)
Minimum tread depth	Front	0.06 in (1.5 mm)
	Rear	0.08 in (2.0 mm)
Spark plugs	(standard)	SILMAR8A9S (NGK)
Spark plug gap	(non-adjustable)	0.03 - 0.04 in (0.8 - 0.9 mm)
Idle speed		1,200 ± 100 rpm
Recommended engine oil		API Service Classification SG or higher except oils labeled as energy conserving or resourceconserving on the circular API service label, SAE 10W-30, JASO T 903 standard MA, ProHonda GN4 4-stroke oil (USA & Canada) or Honda 4-stroke oil, or an equivalent motorcycle oil

Engine oil capacity	CRF1000A	
	After draining	4.1 US qt (3.9 L)
	After draining & engine oil filter change	4.3 US qt (4.1 L)
	After disassembly	5.2 US qt (4.9 L)
	CRF1000D	
	After draining	4.2 US qt (4.0 L)
Recommended brake fluid	After draining & engine oil filter change	4.4 US qt (4.2 L)
	After draining, engine & clutch oil filter change	4.4 US qt (4.2 L)
	After disassembly	5.5 US qt (5.2 L)
Recommended cooling system capacity	Honda DOT 4 Brake Fluid	
Recommended coolant	CRF1000A	
	1.72 US qt (1.63 L)	
	CRF1000D	
	1.74 US qt (1.65 L)	

Recommended drive chain lubricant	Pro Honda HP Chain Lube or equivalent	
Drive chain slack	1.4 - 1.8 in (35 - 45 mm)	
Standard drive chain	DID 525HV3	
	No. of links	124
Standard sprocket sizes	Drive sprocket	16T
	Driven sprocket	42T

■ Bulbs

Headlight	LED
Brake/Tail light	LED
Front turn signal lights	12V-21/5W × 2
Rear turn signal lights	12V-21W × 2
License plate light	12V-5W

■ Fuses

Main fuse	30A
Other fuses	30A, 20A, 15A, 10A, 7.5A

■ Torque Specifications

Skid plate bolts	19 lbf-ft (26 N·m, 2.7 kgf·m)
Spark arrester mounting bolts	6.6 lbf-ft (9.0 N·m, 0.9 kgf·m)
Pan screws	6.6 lbf-ft (9.0 N·m, 0.9 kgf·m)
Tail cap cover bolts	6.6 lbf-ft (9.0 N·m, 0.9 kgf·m)
Oil filter	19 lbf-ft (26 N·m, 2.7 kgf·m)
Engine oil drain bolts	22 lbf-ft (30 N·m, 3.1 kgf·m)
Clutch oil filter cover bolts	9 lbf-ft (12 N·m, 1.2 kgf·m)
Rear wheel axle nut	74 lbf-ft (100 N·m, 10.2 kgf·m)
Drive chain adjusting lock nuts	20 lbf-ft (27 N·m, 2.8 kgf·m)
Front wheel axle nut	44 lbf-ft (60 N·m, 6.1 kgf·m)
Front wheel axle pinch bolts	16 lbf-ft (22 N·m, 2.2 kgf·m)
Front wheel brake caliper mounting bolts	33 lbf-ft (45 N·m, 4.6 kgf·m)

Information Record

VIN	
Engine No.	
Color Label & Code	
Owner's Name	
Address	
City/State	
Phone	
Dealer's Name	
Address	
City/State	
Phone	
Service Manager	

- A**
- A/M Switch..... 51
 - ABS (Anti-lock Brake System)..... 13
 - ABS (Anti-lock Brake System)
 - Indicator 47, 139
 - ABS Function on the Rear Wheel..... 53
 - Accessories 17
 - Air Cleaner..... 94
 - AT MODE..... 28, 63, 65, 66, 67
 - Authorized Manuals..... 177
- B**
- Battery..... 82, 95
 - Battery Box Cover..... 97
 - Brake Lever..... 128
 - Brake Light Switch..... 115
 - Brakes
 - Fluid 87, 112, 184
 - Lever Adjustment..... 128
 - Pad Wear 113
 - Parking..... 55
 - Braking 12
 - Bulb
 - Brake/Taillight..... 152
 - Front/Rear Turn Signal 153
 - Headlight 152
 - License Plate Light..... 153
- C**
- Caring for Your Motorcycle 163
 - Catalytic Converter..... 175
 - Clutch Oil Filter 108
 - Color Label 82
 - Coolant..... 110
 - Crankcase Breather 126
 - Crash 6
- D**
- D Indicator..... 28
 - D Mode 28, 63, 65, 66
 - Digital Clock Adjustment..... 39
 - Drive Chain 87, 117
 - Drive Chain Slider 120
- E**
- Electrical Trouble 151
 - Emission Control Systems 171

Engine

Number	170
Oil	86
Oil Filter	106
Overheats	137
Starting	58
Stop Switch	49, 51, 58, 59, 161
Stopping	161
Will Not Start	136

Environment 169**Equipment**

Helmet Holder	70
Helmet Set Wire	71
Hex Wrench.....	71
Owner's Manual	71
Rear Carrier	72
Tool Kit.....	72
U-shaped Lock.....	71

F**Flooded Engine** 58**Front Seat** 98**Front Suspension**..... 129**Fuel**

Gauge	25
Recommended	69
Remaining	25
Tank Capacity	69

Fuses..... 85, 154**G****G Indicator**..... 28**G Switch**..... 51, 54**Gasohol**..... 176**Gasoline**..... 69**Gear Position Indicator** 29**Gear Shift Operation**..... 68**H****Hazard Switch** 49, 51**Headlight Aim** 127**Headlight Dimmer Switch**..... 48, 50**Helmet Holder**..... 70**High Beam Indicator**..... 44**High Coolant Temperature****Indicator**..... 45, 137**Honda Contacts** 180**Horn Button**..... 48, 50

I	
Ignition Cut-off System	
Banking Sensor.....	162
Side Stand	116
Ignition Key	160
Ignition Switch	49, 51, 58, 59, 161
Indicators	44
Information Record	186
Instruments	24
Instruments, Controls, & Other	
Features	161
L	
Labels	8
Load Limits	19
Loading Guidelines	19
Low Oil Pressure Indicator	44, 138
M	
Maintenance	
Fundamentals	79
Importance	74
Safety	75
Schedule.....	76
Maximum Weight Limit	19
Modifications	17
MT MODE	29, 63, 65, 66, 68
N	
N-D Switch	50
Neutral Indicator	45
O	
Odometer	27, 36, 161
Off-Road Safety	18
Oil	
Engine.....	86, 104
Overheating	137
Oxygenated Fuels	176
P	
Parking	14
Parking Brake	55
Parking Brake Indicator	45
Parking Brake Lever	55
Parts Location	20
Passing Light Control Switch	48, 50

PGM-FI (Programmed Fuel Injection)

- Malfunction Indicator Lamp (MIL).... 44, 138
- Protective Apparel..... 10

R**Rear ABS (Anti-lock Brake System) OFF**

- Indicator..... 47
- Rear ABS Switch..... 49, 51
- Rear Suspension 132

Recommended

- Coolant..... 89
- Engine Oil 86, 104
- Fuel..... 69
- Oil..... 86

Refueling..... 69**Removal**

- Battery..... 95
- Battery Box Cover 97
- Front Seat..... 98
- Skid Plate 100
- Tool Box..... 101

Reporting Safety Defects (U.S.)..... 182**Riding Precautions 12****S**

- S Indicator 28
- S Mode..... 28, 63, 65, 66, 67
- Safety Guidelines 3
- Safety Labels 8
- Safety Precautions..... 10
- Shift Switch 50
- Shifting Gears 61
- Side Stand 116
- Side Stand Ignition Cut-off System 116
- Spark Arrester..... 102
- Specifications..... 183
- Speedometer 25
- Start Button..... 49, 51, 58, 59
- Starting the Engine 58
- Steering Lock..... 52
- Stopping Engine 161

Storage	
Equipment	70
Helmet Holder	70
Helmet Set Wire	71
Hex Wrench.....	71
Owner's Manual	71
Rear Carrier	72
Tool Kit.....	72
U-shaped Lock.....	71
Storing Your Motorcycle	167
Switches	48
T	
Torque Control Switch	48
Tachometer	25
Throttle	125
Tires	
Air Pressure	90
Puncture.....	143
Replacing	90, 143
Tool Kit	72
Torque Control	16, 56
Torque Control Indicator	46, 140
Torque Control OFF Indicator	46
Transporting Your Motorcycle	168
Tripmeter	27, 36, 161
Troubleshooting	135
Turn Signal Indicators	44, 45
V	
Vehicle Identification Number	170
W	
Warning Indicators On or Flashing	138
Warranty Coverage and Service	178
Washing Your Motorcycle	163
Weight Limit	19, 183
Wheels	
Front Removal	144
Rear Removal.....	148
Rims & Spokes.....	121

Free Manuals Download Website

<http://myh66.com>

<http://usermanuals.us>

<http://www.somanuals.com>

<http://www.4manuals.cc>

<http://www.manual-lib.com>

<http://www.404manual.com>

<http://www.luxmanual.com>

<http://aubethermostatmanual.com>

Golf course search by state

<http://golfingnear.com>

Email search by domain

<http://emailbydomain.com>

Auto manuals search

<http://auto.somanuals.com>

TV manuals search

<http://tv.somanuals.com>