

This manual should be considered a permanent part of the motorcycle and should remain with the motorcycle when it is resold.

This Owner's Manual covers the CBR1000RR and CBR1000RR ABS models. You may find descriptions of equipment and features that are not on your particular model. All illustrations are based on the CBR1000RR model, unless noted otherwise.

This publication includes the latest production information available before printing. Honda Motor Co., Ltd. reserves the right to make changes at any time without notice and without incurring any obligation.

No part of this publication may be reproduced without written permission.

© 2008 Honda Motor Co., Ltd.

**2009**

**Honda CBR1000RR/**

**CBR1000RR ABS  
OWNER'S MANUAL**

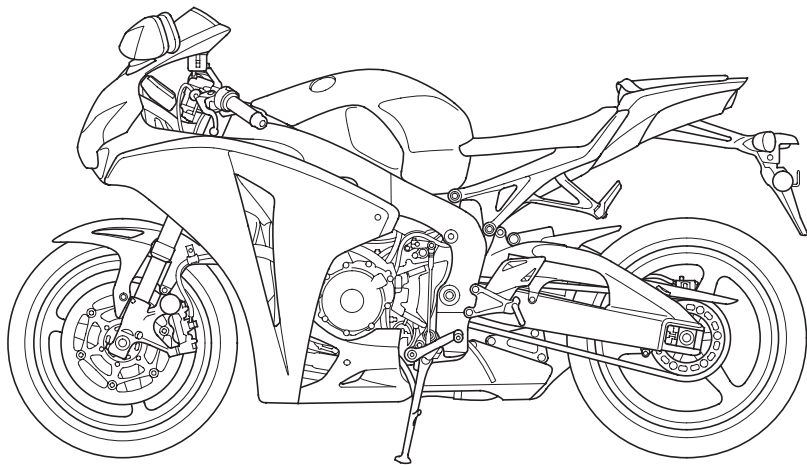

# Introduction

---

Congratulations on choosing your Honda motorcycle.

When you own a Honda, you're part of a worldwide family of satisfied customers — people who appreciate Honda's reputation for building quality into every product.

Before riding, take time to get acquainted with your motorcycle and how it works. To protect your investment, we urge you to take responsibility for keeping your motorcycle well maintained. Scheduled service is a must, of course. But it's just as important to observe the break-in guidelines, and perform all pre-ride and other periodic checks detailed in this manual.

## Introduction

We also recommend that you read this owner's manual before you ride. It's full of facts, instructions, safety information, and helpful tips. To make it easy to use, the manual contains a detailed list of topics at the beginning of each section, and both an in-depth table of contents and an index at the back of the book.

As you read this manual, you will find information that is preceded by a **NOTICE** symbol. This information is intended to help you avoid damage to your Honda, other property, or the environment.

Read the Warranties Booklet (page 249 ) thoroughly so you understand the coverages that protect your new Honda and are aware of your rights and responsibilities.

If you have any questions, or if you ever need special service or repairs, remember that your Honda dealer knows your motorcycle best and is dedicated to your complete satisfaction.

Please report any change of address or ownership to your Honda dealer so we will be able to contact you concerning important product information.

You may also want to visit our website at [www.honda.com](http://www.honda.com).

Happy riding!

### California Proposition 65 Warning

**WARNING:** This product contains or emits chemicals known to the State of California to cause cancer and birth defects or other reproductive harm.

# A Few Words About Safety

---

Your safety, and the safety of others, is very important. And operating this motorcycle safely is an important responsibility.

To help you make informed decisions about safety, we have provided operating procedures and other information on labels and in this manual. This information alerts you to potential hazards that could hurt you or others.

Of course, it is not practical or possible to warn you about all hazards associated with operating or maintaining a motorcycle. You must use your own good judgment.

You will find important safety information in a variety of forms, including:

- **Safety Labels** — on the motorcycle.
- **Safety Messages** — preceded by a safety alert symbol  and one of three signal words: **DANGER**, **WARNING**, or **CAUTION**.

These signal words mean:

## Safety Messages

## A Few Words About Safety

---

### **DANGER**

You **WILL** be **KILLED** or **SERIOUSLY HURT** if you don't follow instructions.

### **WARNING**

You **CAN** be **KILLED** or **SERIOUSLY HURT** if you don't follow instructions.

### **CAUTION**

You **CAN** be **HURT** if you don't follow instructions.

- **Safety Headings** — such as Important Safety Reminders or Important Safety Precautions.
- **Safety Section** — such as Motorcycle Safety.
- **Instructions** — how to use this motorcycle correctly and safely.

This entire manual is filled with important safety information — please read it carefully.

# Contents

---

These pages give an overview of the contents of your owner's manual. The first page of each section lists the topics covered in that section.

**Motorcycle Safety..... 1**

Important safety information you should know, plus a look at the safety-related labels on your motorcycle.

**Instruments & Controls..... 9**

The location and function of indicators, gauges, and controls on your motorcycle and operating instructions for various controls and features.

**Before Riding..... 55**

The importance of wearing a helmet and other protective gear, how to make sure you and your motorcycle are ready to ride, and important information about loading.

**Basic Operation & Riding ..... 65**

How to start and stop the engine, shift gears, and brake. Also, riding precautions and important information about riding with a passenger or cargo.

# Contents

---

## **Servicing Your Honda ..... 87**

Why your motorcycle needs regular maintenance, what you need to know before servicing your Honda, an owner maintenance schedule, and instructions for specific maintenance and adjustment items.

## **Tips ..... 183**

How to store and transport your motorcycle and how to be an environmentally responsible rider.

## **Taking Care of the Unexpected ..... 189**

What to do if you have a flat tire, your engine won't start, etc.

## **Technical Information ..... 223**

ID numbers, technical specifications, and other technical facts.

## **Consumer Information ..... 245**

Information on warranties, emission controls, how to get Honda service manuals, and...

### **“Reporting Safety Defects” ..... 254**

## **Table of Contents ..... 256**

Sequential listing of topics in this owner's manual.

## **Index ..... 262**

## **Quick Reference**

Handy facts about fuel, engine oil, tire sizes, and air pressures.





# Motorcycle Safety

---

This section presents some of the most important information and recommendations to help you ride your motorcycle safely. Please take a few moments to read these pages. This section also includes information about the location of safety labels on your motorcycle.

Important Safety Information .....	2
Accessories & Modifications.....	5
Safety Labels .....	7

# Important Safety Information

---

Your motorcycle can provide many years of service and pleasure — if you take responsibility for your own safety and understand the challenges you can meet while riding.

There is much that you can do to protect yourself when you ride. You'll find many helpful recommendations throughout this manual. The following are a few that we consider to be most important.

## **Always Wear a Helmet**

It's a proven fact: helmets significantly reduce the number and severity of head injuries. So always wear an approved motorcycle helmet and make sure your passenger does the same. We also recommend that you wear eye protection, sturdy boots, gloves, and other protective gear (page 56).

# Important Safety Information

---

## **Take Time to Learn & Practice**

Even if you have ridden other motorcycles, take time to become familiar with how this motorcycle works and handles.

Practice in a safe area until you build your skills and get accustomed to the motorcycle's size and weight.

Because many accidents involve inexperienced or untrained riders, we urge all riders to take a certified course approved by the Motorcycle Safety Foundation (MSF). See page 58.

## **Ride Defensively**

The most frequent motorcycle collision happens when a car turns left in front of a motorcycle. Another common situation is a car moving suddenly into your lane.

Always pay attention to other vehicles around you, and do not assume that other drivers see you. Be prepared to stop quickly or make an evasive maneuver. For other riding tips, see the booklet, *You and Your Motorcycle Riding Tips*, which came with your new motorcycle (USA only).

## **Make Yourself Easy to See**

Some drivers do not see motorcycles because they are not looking for them. To make yourself more visible, wear bright reflective clothing, position yourself so other drivers can see you, signal before turning or changing lanes, and use your horn when it will help others notice you.

# Important Safety Information

---

## **Ride within Your Limits**

Pushing limits is another major cause of motorcycle accidents. Never ride beyond your personal abilities or faster than conditions warrant. Remember that alcohol, drugs, fatigue, and inattention can significantly reduce your ability to make good judgments and ride safely.

## **Don't Drink and Ride**

Alcohol and riding don't mix. Even one drink can reduce your ability to respond to changing conditions, and your reaction time gets worse with every additional drink. So don't drink and ride, and don't let your friends drink and ride either.

## **Keep Your Honda in Safe Condition**

It's important to keep your motorcycle properly maintained and in safe riding condition. To help avoid problems, inspect your motorcycle before every ride and perform all recommended maintenance. Never exceed load limits (page 63 ), and do not modify your motorcycle (page 6 ) or install accessories that would make your motorcycle unsafe (page 5 ).

Modifying your motorcycle or using non-Honda accessories can make your motorcycle unsafe. Before you consider making any modifications or adding an accessory, be sure to read the following information.

### **WARNING**

Improper accessories or modifications can cause a crash in which you can be seriously hurt or killed.

Follow all instructions in this owner's manual regarding accessories and modifications.

### Accessories

We strongly recommend that you use only Honda Genuine Accessories that have been specifically designed and tested for your motorcycle. Because Honda cannot test all other accessories, you must be personally responsible for proper selection, installation, and use of non-Honda accessories.

Check with your Honda dealer for assistance and always follow these guidelines:

- Make sure the accessory does not obscure any lights, reduce ground clearance and lean angle, limit suspension travel or steering travel, alter your riding position, or interfere with operating any controls. (cont'd)

## Accessories & Modifications

---

- Do not add any electrical equipment that will exceed the motorcycle's electrical system capacity (page 232 ). A blown fuse can cause a loss of lights or engine power (page 213).
- Do not pull a trailer or sidecar with your motorcycle. This motorcycle was not designed for these attachments, and their use can seriously impair your motorcycle's handling.

### Modifications

We strongly advise you not to remove any original equipment or modify your motorcycle in any way that would change its design or operation. Such changes could seriously impair your motorcycle's handling, stability, and braking, making it unsafe to ride.

Removing or modifying your lights, exhaust system, emission control system, or other equipment can also make your motorcycle illegal.

# Safety Labels

Safety labels on your motorcycle either warn you of potential hazards that could cause serious injury or they provide important safety information. Read these labels carefully and don't remove them.

If a label comes off or becomes hard to read, contact your Honda dealer for a replacement.

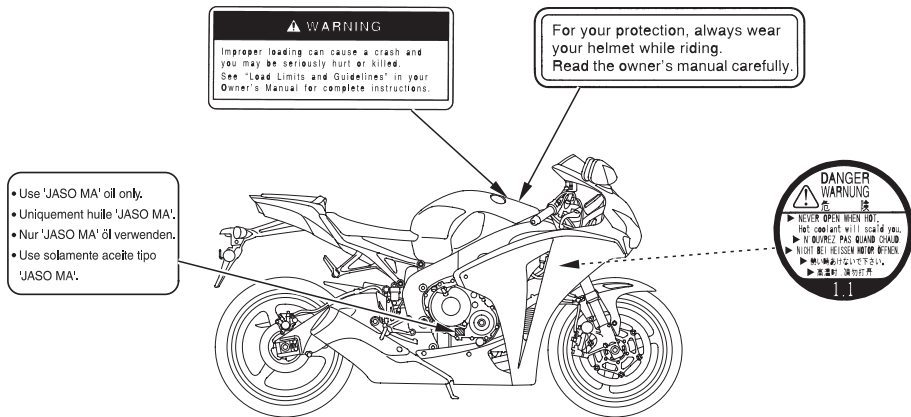



# Safety Labels

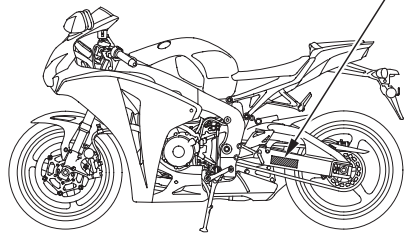

TIRE INFORMATION	
<b>Cold tire pressures :</b> [Up to maximum weight capacity] Front 250kPa 2.50kg/cm <sup>2</sup> 36psi Rear 290kPa 2.90kg/cm <sup>2</sup> 42psi [Up to 90kg(200lbs) load] Front 250kPa 2.50kg/cm <sup>2</sup> 36psi Rear 290kPa 2.90kg/cm <sup>2</sup> 42psi Maximum weight capacity : 166kg(366lbs) Tire size : Front 120/70ZR17M/C (58W) Rear 190/50ZR17M/C (73W)	<b>Tire brand</b> Front Rear <b>BRIDGESTONE</b> BT015F RADIAL F BT015R RADIAL F <b>DUNLOP</b> Qualifier PTK Qualifier NK Min. recommend tire center tread depth. Front 1.5mm (0.06in.) Rear 2.0mm (0.08in.) <b>Read owner's manual.</b> <b>This motorcycle is equipped with tubeless tires.</b>

## Instruments & Controls

---

This section shows the location of all gauges, indicators, and controls you would normally use before or while riding your motorcycle.

The items listed on this page are described in this section. Instructions for other components are presented in other sections of this manual where they will be most useful.

Operation Component Locations .....	11
Gauges, Indicators & Displays.....	14
Multi-function Display.....	25
Coolant Temperature Meter.....	26
Low Fuel Indicator and Reserve	
Fuel Consumption .....	28
Low Oil Pressure Indicator and	
Warning Indicator .....	30
High Coolant Temperature Indicator	
and Warning Indicator.....	31
HESD Indicator .....	32
Changing the Indication of	
Multi-function Display.....	33
Speedometer .....	34
Odometer/Tripmeter A & B.....	35
Fuel Mileage Meter .....	37

(cont'd)

# Instruments & Controls

---

Gauges, Indicators & Displays	
Changing the Speed, Mileage and Fuel Mileage Unit.....	40
Changing the Temperature Unit .....	41
Changing the Indication Mode of Fuel Mileage.....	42
Digital Clock .....	43
Presetting the Shift Indicator and Selecting the Display.....	46
Controls & Features.....	49
Ignition Switch .....	49
Start Button.....	50
Engine Stop Switch .....	50
Headlight Dimmer Switch .....	51
Turn Signal Switch.....	51
Horn Button.....	52
Control Button A.....	52
Control Button B .....	53
HESD (Honda Electronic Steering Damper).....	54

# Operation Component Locations

---

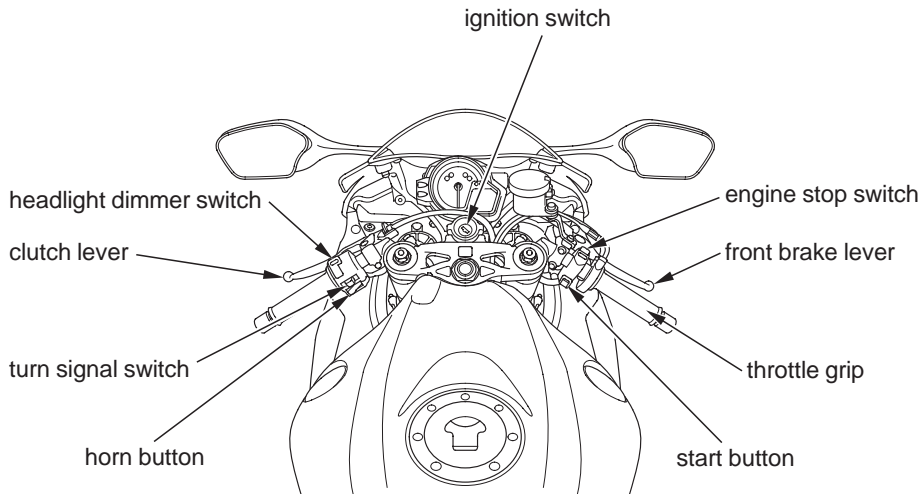

# Operation Component Locations

---

storage compartment for U-shaped lock

helmet holders

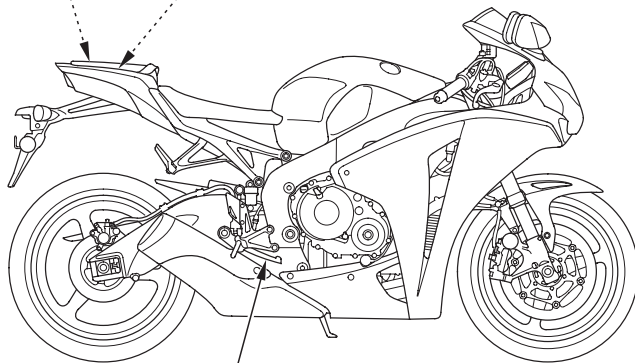

rear brake pedal

# Operation Component Locations

---

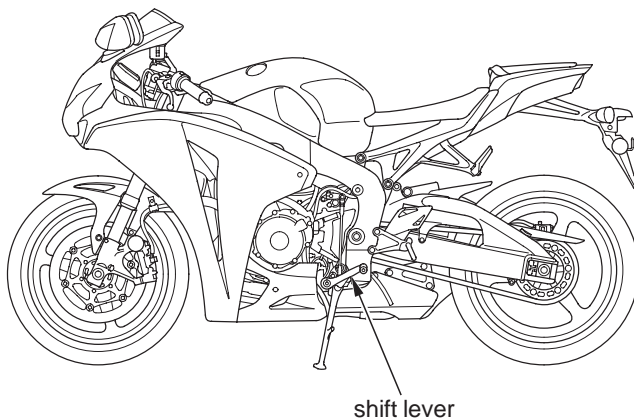

# Gauges, Indicators & Displays

The gauges, indicators and displays on your motorcycle keep you informed, alert you to possible problems, and make your riding safer and more enjoyable. Refer to the gauges, indicators and displays frequently. Their functions are described on the following pages.

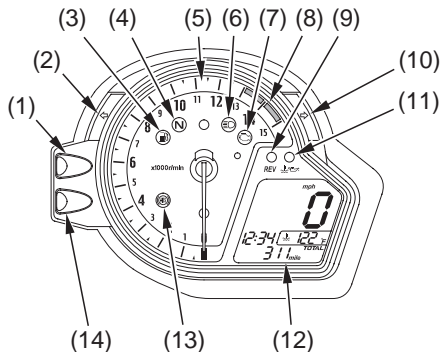

- (1) control button A
- (2) left turn signal indicator
- (3) low fuel indicator
- (4) neutral indicator
- (5) tachometer
- (6) high beam indicator
- (7) PGM-FI malfunction indicator lamp (MIL)
- (8) tachometer red zone
- (9) shift indicator
- (10) right turn signal indicator
- (11) warning indicator
- (12) multi-function display
- (13) Combined ABS indicator (CBR1000RR ABS only)
- (14) control button B

## Gauges, Indicators & Displays

---

### Lamp Check

The warning indicator comes on when you turn the ignition switch ON so you can check that it is working. The indicator remains on until after the engine is started.

The PGM-FI malfunction indicator lamp (MIL), low fuel indicator, shift indicator, high beam indicator, left turn signal indicator, and right turn signal indicator light for a few seconds and then go off when you turn the ignition switch ON.

(CBR1000RR ABS only)

The Combined ABS indicator comes on when you turn the ignition switch ON. This indicator goes off after you ride the motorcycle at a speed above 6 mph (10 km/h).

When applicable, the high beam and neutral indicators come on when you turn the ignition switch ON and remain on until you select the low beam or shift out of neutral.

These indicators are identified in the table on pages 18 – 21 with the words: *Lamp Check*.

If one of these indicators does not come on when it should, have your Honda dealer check for problems.



# Gauges, Indicators & Displays

---

## Meter Check

The tachometer needle will swing to the end of the red zone once when you turn the ignition switch ON.

The meter is identified in the table on page 19 with the words: *Meter Check*.

If the tachometer needle does not swing to the end of the red zone when it should, have your Honda dealer check for problems.

# Gauges, Indicators & Displays

## Display Check

When the ignition switch is turned ON, the multi-function display ( 1 ) will temporarily show all the modes and digital segments so you can make sure the liquid crystal display is functioning properly.

The displays are identified in the table on pages 22 – 23 with the words: *Display Check*.

If any part of these displays does not come on when it should, have your Honda dealer check for problems.

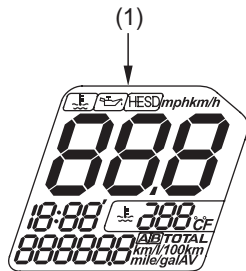

(1) multi-function display

## Gauges, Indicators & Displays

---

1	control button A	<p>Use this button for the following purposes:</p> <ul style="list-style-type: none"><li>• To change indication of odometer, tripmeter A, and tripmeter B (pages 33 , 35 )</li><li>• To change unit of speedometer, odometer, tripmeter and fuel mileage meter (page 40 )</li><li>• To change indication mode of fuel mileage (page 42 )</li><li>• To reset tripmeter A and fuel mileage meter (page 36 )</li><li>• To reset tripmeter B (page 36 )</li><li>• To change the reset mode of tripmeter A and fuel mileage meter (page 39 )</li><li>• To adjust time (page 43 )</li><li>• To change the setting of the shift indicator and selection of the display (pages 46 – 48 )</li><li>• To change unit of the temperature meter (page 41 )</li></ul>
2	left turn signal indicator (green)	<p>Flashes when the left turn signal operates. <i>Lamp Check.</i></p>

## Gauges, Indicators & Displays

3	low fuel indicator (amber)	When this indicator comes on while riding, fuel reserved in the tank is about: <b>0.92 US gal (3.5 l)</b> <i>Lamp Check.</i>  When this indicator comes on, the lower segment of the multi-function display switches to the reserve fuel consumption (page 28 ).
4	neutral indicator (green)	Lights when the transmission is in neutral.
5	tachometer	Shows engine speed in revolutions per minute (rpm). <i>Meter Check.</i>
6	high beam indicator (blue)	Lights when the headlight is on high beam. <i>Lamp Check.</i>

## Gauges, Indicators & Displays

---

7	PGM-FI malfunction indicator lamp (MIL) (amber)	Lights when there is any abnormality in the PGM-FI (Programmed Fuel Injection) system. If the indicator comes on at any other time, reduce speed and take your motorcycle to a Honda dealer as soon as possible. <i>Lamp Check.</i>
8	tachometer red zone	Shows excessive engine rpm range (indicated from the beginning of the tachometer red zone) in which operation may damage the engine. Do not let the tachometer needle enter the red zone.
9	shift indicator (amber)	Flashes when the tachometer needle enters the red zone or reaches your selected shift point (page 46 ). <i>Lamp Check.</i>

## Gauges, Indicators & Displays

---

10	right turn signal indicator (green)	Flashes when the right turn signal operates. <i>Lamp Check.</i>
11	warning indicator (red)	Lights when coolant is over the specified temperature, and/or engine oil pressure is below normal operating range. If the indicator lights, pull safely to the side of the road. (pages 30 – 31 ). <i>Lamp Check.</i> See pages 210 – 212 for instructions and cautions.

## Gauges, Indicators & Displays

---

12	multi-function display	The display includes the following functions: <i>Display Check.</i>
	low oil pressure indicator/high coolant temperature indicator/HESD indicator	Lights the low oil pressure indicator and/or high coolant temperature indicator to notify that there is an abnormality in engine oil pressure and/or coolant temperature when the warning indicator lights (pages 30 , 31 ). Also, lights the HESD indicator to notify when there is an abnormality in the HESD (Honda Electronic Steering Damper) (page 32 ).
	speedometer	Shows riding speed in miles or kilometers per hour (page 34 ).
	digital clock	Shows hour and minute (page 43 ).
	coolant temperature meter	Shows coolant temperature (page 26 ). Fahrenheit (°F) or Centigrade (°C).

## Gauges, Indicators & Displays

12	odometer/tripmeter display	The display includes the following functions: <i>Display Check.</i>
	odometer	Shows the total miles or kilometers ridden (page 35 ).
	tripmeter A & B	Shows the number of miles or kilometers ridden since you last reset the meter. The tripmeter has two sub modes, “A” and “B.” To zero (0) the tripmeter, push and hold control button A (pages 35 – 36 ).
	fuel mileage meter	Shows current fuel mileage, average fuel mileage, or fuel consumption. See pages 37 – 39 . When the low fuel indicator comes on, the display is changed to the reserve fuel consumption (page 28 ).



## Gauges, Indicators & Displays

---

13	Combined ABS indicator (amber) (CBR1000RR ABS)	Lights when there is any abnormality in the Combined ABS (Combined Anti-lock Brake System). Normally, this indicator comes on when the ignition switch is turned ON, and goes off after you ride the motorcycle at a speed above 6 mph (10 km/h). If the indicator comes on while riding, stop the motorcycle in a safe place and turn off the engine. Refer to <i>Combined ABS Indicator</i> , page 78 . For information about Combined ABS, see pages 76 – 78 . <i>Lamp Check.</i>
14	control button B	Use this button for the following purposes: <ul style="list-style-type: none"><li>• To change indication of current fuel mileage, average fuel mileage, and fuel consumption (pages 33 , 37 )</li><li>• To change unit of speedometer, odometer, tripmeter and fuel mileage meter (page 40 )</li><li>• To change indication mode of fuel mileage (page 42 )</li><li>• To change the reset mode of tripmeter A and fuel mileage meter (page 39 )</li><li>• To adjust time (page 43 )</li><li>• To change the setting of the shift indicator and selection of the display (pages 46 – 48 )</li><li>• To change unit of the temperature meter (page 41 )</li></ul>

# Gauges, Indicators & Displays

## Multi-function Display

The multi-function display (1) includes the following functions:

- low oil pressure indicator
- high coolant temperature indicator
- HESD indicator
- speedometer
- digital clock
- coolant temperature meter
- odometer
- tripmeter
- fuel mileage meter

The digital clock will reset if the battery is disconnected.

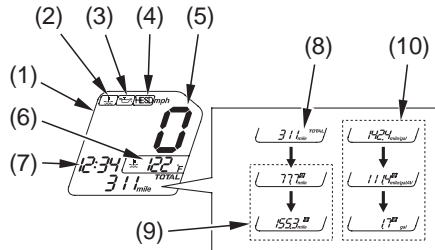

- (1) multi-function display
- (2) high coolant temperature indicator
- (3) low oil pressure indicator
- (4) HESD indicator
- (5) speedometer
- (6) coolant temperature meter
- (7) digital clock
- (8) odometer
- (9) tripmeter
- (10) fuel mileage meter

# Gauges, Indicators & Displays

## Coolant Temperature Meter

The coolant temperature meter (1) shows the coolant temperature digitally.

### Temperature Display

Below 94 °F (34 °C)	“--” is displayed
Between 95 °F – 250 °F (35 °C – 121 °C)	Actual coolant temperature is displayed.
Between 251 °F – 269 °F (122 °C – 131 °C)	Actual coolant temperature is displayed and flashed.
Above 270 °F (132 °C)	The display remains on and flashes “270 °F (132 °C)”

USA : Fahrenheit (°F), or  
Centigrade (°C).

Canada : Centigrade (°C), or  
Fahrenheit (°F).

< Fahrenheit (°F) >



< Centigrade (°C) >



(1)

(1) coolant temperature meter

## Gauges, Indicators & Displays

### Overheating Message:

When the coolant temperature reaches 251°F (122°C), the numbers in the temperature display start flashing. At the same time, the high coolant temperature indicator (2) and the warning indicator (3) light.

If this occurs, stop the engine and check the reverse tank coolant level. Read pages 125 – 128 and do not ride the motorcycle until the problem has been corrected.

### **NOTICE**

*Continuing to ride with an overheated engine can cause serious engine damage.*

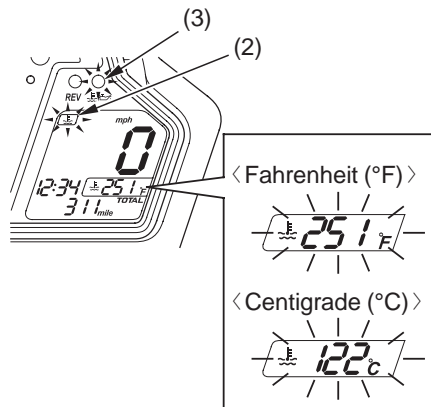

- (2) high coolant temperature indicator
- (3) warning indicator

# Gauges, Indicators & Displays

---

## Low Fuel Indicator and Reserve Fuel Consumption

When the remaining fuel reaches the reserve supply level, the low fuel indicator (1) comes on and the amount of reserve fuel used is displayed with blinking to show that you should refuel.

The amount of fuel left in the tank when the low fuel indicator lights with the vehicle set upright is approximately:

0.92 US gal (3.5 ℓ)

The reserve fuel consumption (2) is displayed in the lower segment of the multi-function display (3) from 0.0 “gal (gallon)” or “l (liter).”.

When the amount of consumed fuel is more than 0.26 US gal (1.0 Liter) the display blinks faster.

If you change the display to odometer, tripmeter and so on (page 33 ), it will return to the reserve fuel consumption after about 10 seconds.

## Gauges, Indicators & Displays

When the reserve fuel consumption is displayed you should refill the tank as soon as possible.

After refueling more than the reserve amount, the display returns to normal when the ignition switch has been ON for about a minute.

The unit of the indication depends on the unit which you select (page 40 ).

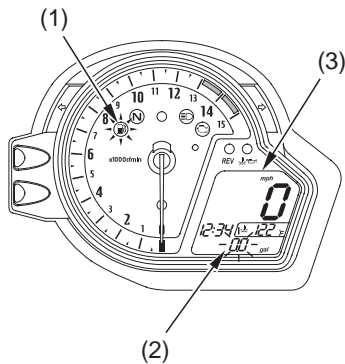

- (1) low fuel indicator
- (2) reserve fuel consumption
- (3) multi-information display

# Gauges, Indicators & Displays

## Low Oil Pressure Indicator and Warning Indicator

The low oil pressure indicator (1) and the warning indicator (2) light when engine oil pressure is low enough to cause engine damage.

The low oil pressure indicator and warning indicator should also light when the ignition switch is turned ON. The warning indicator and the low oil pressure indicator stay on until after the engine is started.

If the low oil pressure indicator and the warning indicator light, pull safely to the side of the road.

See page 212 for instructions and cautions.

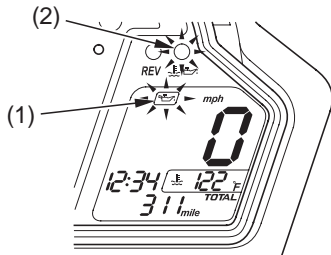

(1) low oil pressure indicator

(2) warning indicator

## Gauges, Indicators & Displays

### High Coolant Temperature Indicator and Warning Indicator

The high coolant temperature indicator (1) and the warning indicator (2) light when the coolant temperature reaches 251°F (122°C). At the same time, the numbers in the coolant temperature meter display start flashing.

If this occurs, stop the engine and check the reserve tank coolant level. Read pages 125 — 128 and do not ride the motorcycle until the problem has been corrected.

#### NOTICE

*Continuing to ride with an overheated engine can cause serious engine damage.*

The high coolant temperature indicator should also go on for a few seconds and then go off when the ignition switch is turned ON.

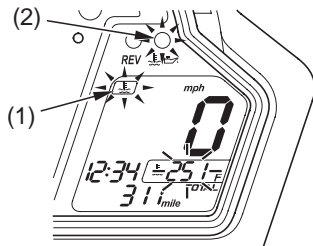

- (1) high coolant temperature indicator
- (2) warning indicator



# Gauges, Indicators & Displays

---

## HESD Indicator

The HESD indicator (1) lights when there is any abnormality in the HESD (Honda Electronic Steering Damper).

The HESD indicator should also go on for a few seconds and then go off when the ignition switch is turned ON.

If the HESD indicator lights at any other time, reduce speed and take your motorcycle to a Honda dealer as soon as possible.

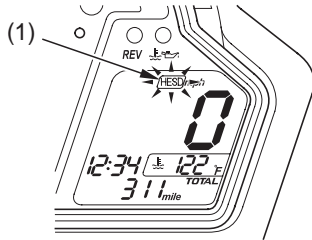

(1) HESD indicator

# Gauges, Indicators & Displays

## Changing the Indication of Multi-function Display

Change the indication between the odometer (1), the tripmeter (2), and the fuel mileage meter (3) by pressing control button A (4) or B (5).

The fuel mileage meter includes the following functions:

- current fuel mileage
- average fuel mileage
- fuel consumption

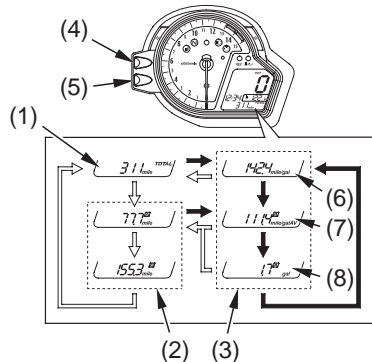

⇨ :press control button A

➔ :press control button B

(1) odometer

(2) tripmeter

(3) fuel mileage  
meter

(4) control button A

(5) control button B

(6) current fuel mileage

(7) average fuel  
mileage

(8) fuel consumption

# Gauges, Indicators & Displays

---

## Speedometer

The speedometer ( 1 ) shows riding speed in miles or kilometers per hour.

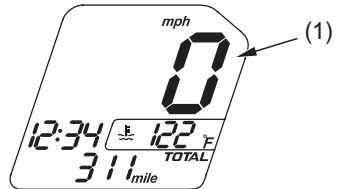

(1) speedometer

# Gauges, Indicators & Displays

## Odometer/Tripmeter A & B

The odometer (1) shows the total miles or kilometers ridden.

The tripmeter A (2) and tripmeter B (3) show number of miles or kilometers ridden since you last reset the meter.

To select the odometer, tripmeter A or tripmeter B, push control button A (4).

Tripmeter A can be displayed from 0 to 999.9 miles (kilometers). Tripmeter B can be displayed up to 9,999.9 miles (kilometers). If Tripmeter A exceeds 999.9 miles (kilometers), or if Tripmeter B exceeds 9,999.9 miles (kilometers), it will return to 0 automatically.

The odometer can be displayed from 0 to 999,999 miles (kilometers).

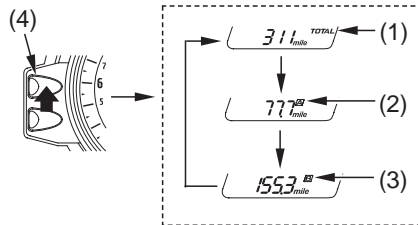

(1) odometer  
(2) tripmeter A

(3) tripmeter B  
(4) control button A

(cont'd)

# Gauges, Indicators & Displays

## To Reset the Tripmeter

To reset the tripmeter A (2), average fuel mileage (5), and fuel consumption (6) together, push and hold control button A (4) when either indication is displayed. When they are reset, “0.0” is displayed at each indication. Then, the display returns to the last selected indication.

To reset the tripmeter B (3), push and hold control button A with the display in the tripmeter B.

Also, after refueling more than the reserve amount, the tripmeter A, average fuel mileage, and fuel consumption can be automatically reset.

You can activate or deactivate the automatic reset mode by refueling (page 39 ).

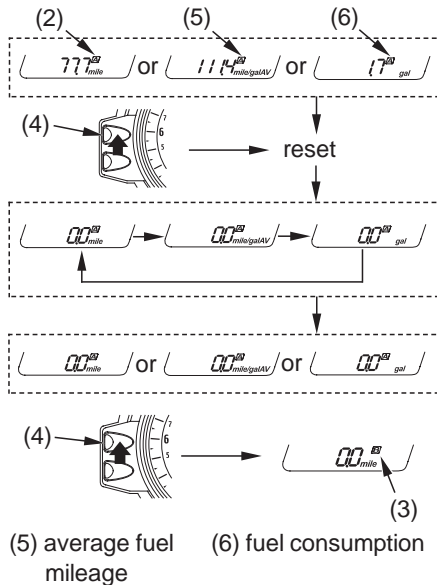

# Gauges, Indicators & Displays

## Fuel Mileage Meter

The fuel mileage meter includes the following functions:

- current fuel mileage
- average fuel mileage
- fuel consumption

The unit of the indication depends on the unit which you select (page 40).

If the speed and mileage unit is set to “km/h”/“km,” the indication mode of the current and average fuel mileage can be selected km/l or l/100 km (page 42).

When the odometer (5) or tripmeter A (6) is displayed, press control button B (7) to select any mode of the fuel mileage meter. Press control button A (8) to change the indication to the odometer or tripmeter A.

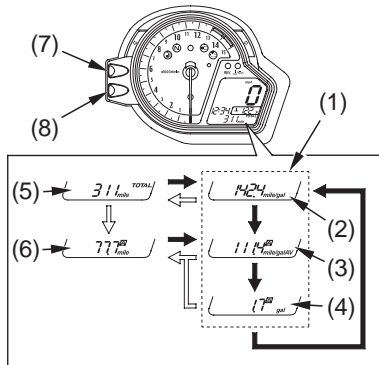

⇨ :press control button A

➔ :press control button B

- (1) fuel mileage meter
  - (2) current fuel mileage
  - (3) average fuel mileage
  - (4) fuel consumption
  - (5) odometer
  - (6) tripmeter A
  - (7) control button A
  - (8) control button B
- (cont'd)

# Gauges, Indicators & Displays

---

## Current Fuel Mileage

This display shows the current, or instant fuel mileage you are getting.

When your motorcycle speed is 0.6 mph (1 km/h) or below, “— — . —” is displayed.

## Average Fuel Mileage

This number is updated once per 15 seconds since you last reset the tripmeter A.

When “— — . —” is displayed, go to your Honda dealer for service.

## Fuel Consumption

This display shows the fuel consumption since you last reset the tripmeter A.

When “— — — . —” is displayed, go to your Honda dealer for service.

## To Reset Average Fuel Mileage and Fuel Consumption

When the tripmeter A is reset, the average fuel mileage and fuel consumption are reset together (page 36).

Also, after refueling more than the reserve amount, the tripmeter A, average fuel mileage, and fuel consumption can be automatically reset.

You can activate or deactivate the automatic reset mode by refueling (page 39).

# Gauges, Indicators & Displays

## To Activate/Deactivate the Automatic Reset Mode

You can activate or deactivate the automatic reset by refueling mode. Initial setting is deactivated.

1. Press and hold control button B (1), and turn on the ignition switch. Keep control button B pressed until the lower segment (2) of the multi-function display starts to blink.

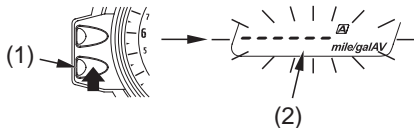

(1) control button B (2) lower segment

2. Press control button A (3) to activate or deactivate the automatic reset mode.

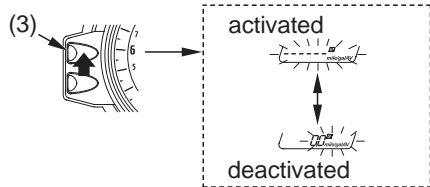

(3) control button A

3. To end the selection, press control button B. The display will return to the ordinary conditions.

The display will stop blinking automatically and return to the ordinary conditions if the button is not pressed for about 30 seconds.

As you turn off the ignition switch during the presetting procedures, the preset data just before turning off the ignition switch will be registered.



# Gauges, Indicators & Displays

## Changing the Speed, Mileage and Fuel Mileage Unit

The speedometer can display “mph” or “km/h.”

The odometer/tripmeter can also display “mile” or “km.”

The fuel mileage meter can display “mile/gal”/“gal” or “km/l”/“l/100 km”/“l.”

1. Turn the ignition switch ON.
2. Press and hold both control button A (1) and control button B (2) for more than 2 seconds.

The unit you are setting in the multi-function display starts to blink.

3. Press control button A to select “mile”/“mph”/“gal” or “km”/“km/h”/“l.”

4. To end the selection, press control button B.

The display will stop blinking automatically if the button is not pressed for about 30 seconds.

As you turn off the ignition switch during the presetting procedures, the preset data just before turning off the ignition switch will be registered.

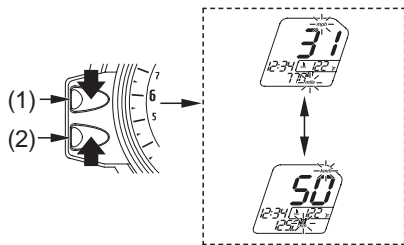

- (1) control button A (2) control button B

### Changing the Temperature Unit

This function can be operated after the speed, mileage, and fuel mileage unit change mode (page 40 ).

The coolant temperature meter displays both “°F” (Fahrenheit) and “°C” (Centigrade).

Press control button A (1) to select “°F” or “°C.”

To end the selection, press control button B (2).

The display will stop blinking automatically if the button is not pressed for about 30 seconds.

As you turn off the ignition switch during the presetting procedures, the preset data just before turning off the ignition switch will be registered.

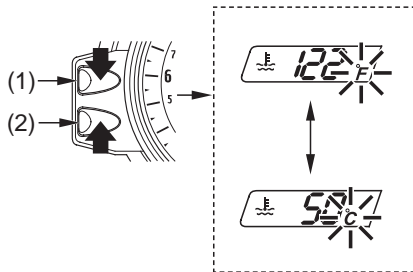

(1) control button A

(2) control button B

# Gauges, Indicators & Displays

## Changing the Indication Mode of Fuel Mileage

When the speedometer is displayed in “km/h,” either “km/l” or “l/100 km” can be the set unit for current and average fuel mileage.

If the ordinary indication is tripmeter B, fuel consumption or reserve fuel consumption, this function becomes invalid, and returns to the ordinary indication.

This function can be operated after the temperature unit is selected.

Press control button A (1) to select “km/l” or “l/100 km.”

If the ordinary indication is the odometer or tripmeter A, it automatically changes to current or average fuel mileage.

To end the selection, press control button B (2).

The display will stop blinking automatically if the button is not pressed for about 30 seconds.

As you turn off the ignition switch during the presetting procedures, the preset data just before turning off the ignition switch will be registered.

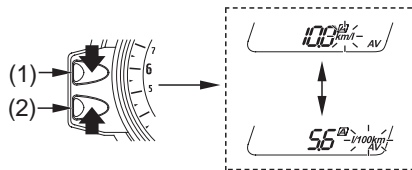

(1) control button A (2) control button B

### Digital Clock

Shows hour and minute. To adjust the time, proceed as follows:

1. Turn the ignition switch ON.
2. Press and hold control button B (2) for more than 2 seconds. The clock will be set in the adjust mode with the hour display blinking.

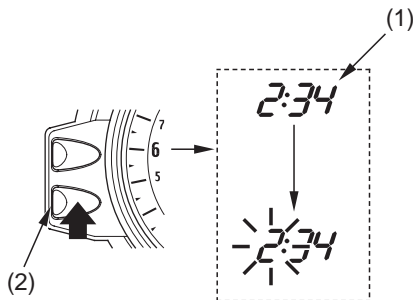

- (1) digital clock  
(2) control button B

(cont'd)

## Gauges, Indicators & Displays

---

3. To set the hour, press control button A (3) until the desired hour is displayed.
- The time is advanced by one hour each time the button is pressed.
  - Quick setting — press and hold the button until the desired hour appears.

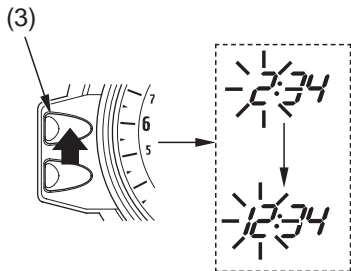

(3) control button A

4. Press control button B. The minute display will start blinking.

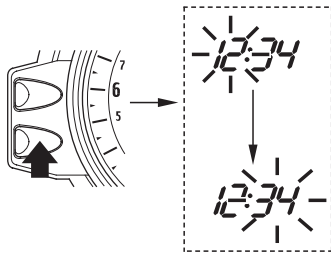

## Gauges, Indicators & Displays

5. To set the minute, press control button A until the desired minute is displayed. The minute display will return to “00” when “60” is reached without affecting the hour display.
- The time advances by one minute, each time the button is pushed.
  - Quick setting — press and hold the button until the desired minute appears.

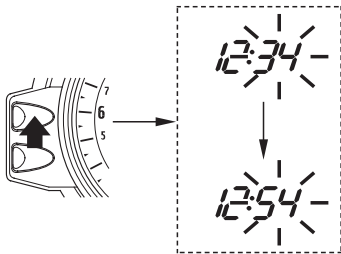

6. To end the adjustment, press control button B or turn the ignition switch OFF. The display will stop blinking automatically and the adjustment will be cancelled if the button is not pressed for about 30 seconds.

# Gauges, Indicators & Displays

## Presetting the Shift Indicator and Selecting the Display

You may select the rpm activation point (in the 2,000 rpm to 13,000 rpm range) for the shift indicator and select the display used to alert you.

To set the shift indicator:

1. Press and hold control button A (1), then turn on the ignition switch. Keep control button A pressed in until the initial display is completed. The tachometer needle moves to its preset position.
2. Each time you press control button A, the tachometer needle (2) will move by an increment of 500 rpm.

By pushing and holding control button A for more than 1 second, the tachometer needle will move by an increment of 1,000 rpm.

When the needle exceeds the allowable range, it will automatically return to 2,000 rpm.

After completing the selection, press control button B (3), and proceed to the selecting the display for the indicator.

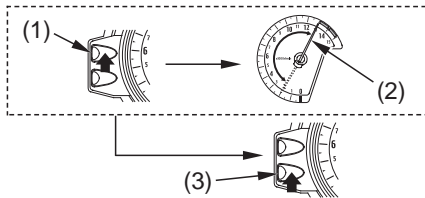

- (1) control button A
- (2) tachometer needle
- (3) control button B

## Gauges, Indicators & Displays

To select the indicator display:

You may choose from 9 different indicator displays (page 48 ).

Press control button A ( 1 ) repeatedly to view available displays.

Once you reach the display you want, press control button B ( 2 ). Then turn off the ignition switch to register your selection.

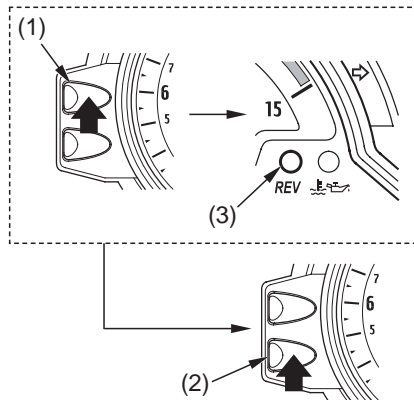

- (1) control button A
- (2) control button B
- (3) shift indicator



# Gauges, Indicators & Displays

---

## Available displays

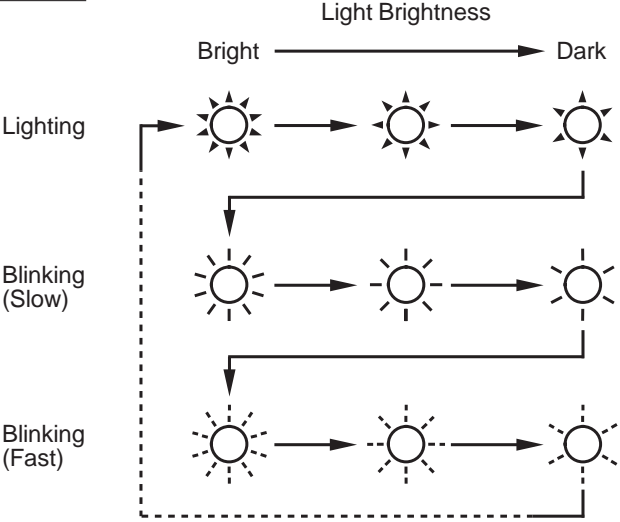

### Ignition Switch

The ignition switch (1) is used for starting and stopping the engine (page 67) and to lock the steering for theft prevention (page 81). Insert the key and turn it to the right for the ON position. Push down on the key and turn it to the left to the LOCK (steering lock) position.

Key Position	Function
ON	Electrical circuits on.
OFF	No electrical circuits function.
LOCK (steering lock)	No electrical circuits function. Locks the steering head.

FRONT

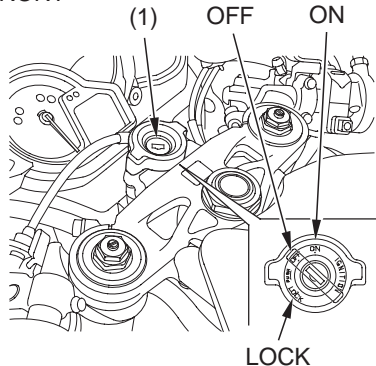

(1) ignition switch

To unlock the steering lock, insert and push down on the key and turn it to the right to the OFF position.

# Controls & Features

## Start Button



The start button (1) is used for starting the engine. Pushing the button in starts the engine. See *Starting Procedure*, page 69.

When the start button is pushed, the starter motor will crank the engine; the headlight will automatically go out, but the running light, taillight and license light will stay on.

The engine will not operate if the engine stop switch is in the OFF position when the start button is pushed.

## Engine Stop Switch



### RIGHT HANDLEBAR

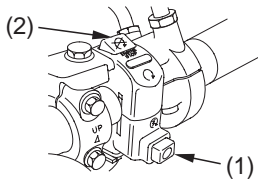

(1) start button



OFF

(2) engine stop switch



RUN

The engine stop switch (2) is used to stop the engine in an emergency. To operate, push the switch to the OFF position. The switch must be in the RUN position to start the engine, and it should normally remain in the RUN position even when the engine is OFF.

If your motorcycle is stopped with the ignition switch ON and the engine stop switch OFF, the headlight, running light, taillight and license light will remain on, resulting in battery discharge.

### Headlight Dimmer Switch



The headlight dimmer switch (1) is used to change between the high and low beams of the headlight. To operate, turn the switch to HI for high beam, LO for low beam.

### Turn Signal Switch

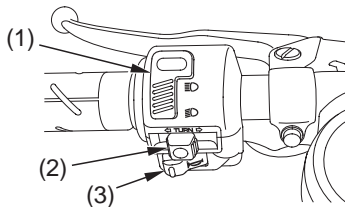

The turn signal switch (2) is used to signal a turn or a lane change. To operate, move the switch all the way in the proper direction and release it. The appropriate turn signal lights will start blinking. To cancel the light, push the switch in.



- (1) headlight dimmer switch  HI
- (2) turn signal switch  LO
- (3) horn button

# Controls & Features

---

## Horn Button



The horn is used to alert other motorists. To operate, push the horn button (3).

## Control Button A

Control button A is used to:

- select the indication of the multi-function display (pages 33 , 35 )
- to reset the tripmeter to zero (0) (page 36 )
- to change the reset mode of tripmeter A and the fuel mileage meter (page 39 )

- to change the speed, mileage and fuel mileage unit for the speedometer/odometer/tripmeter/fuel mileage meter (page 40 )
- to change the temperature unit for the coolant temperature meter (page 41 )
- to change the indication mode of the fuel mileage (page 42 )
- to change the shift indicator and its display (pages 46 – 48 )
- to set the digital clock (page 43 )

### Control Button B

Control button B is used to:

- select the indication of the fuel mileage meter (pages 33 , 37 )
  - to change the reset mode of tripmeter A and the fuel mileage meter (page 39 )
  - to change the speed, mileage and fuel mileage unit for the speedometer/odometer/tripmeter/fuel mileage meter (page 40 )
- to change the temperature unit for the coolant temperature meter (page 41 )
  - to change the indication mode of the fuel mileage (page 42 )
  - to change the shift indicator and its display (pages 46 – 48 )
  - to set the digital clock (page 43 )

## Controls & Features

---

### HESD (Honda Electronic Steering Damper)

This motorcycle is equipped with the electronically-controlled steering damper.

The HESD (1) automatically controls the steering damper characteristics in accordance with vehicle speed and acceleration.

If the HESD indicator (2) lights at any other time, reduce speed and take your motorcycle to a Honda dealer as soon as possible.

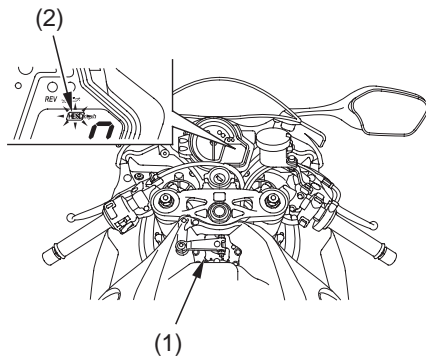

- (1) HESD
- (2) HESD indicator

Before each ride, you need to make sure you and your Honda are both ready to ride. To help get you prepared, this section discusses how to evaluate your riding readiness, what items you should check on your motorcycle, and adjustments to make for your comfort, convenience, or safety. This section also includes important information about loading.

For information about adjusting the suspension on your Honda, see page 135 .

Are You Ready to Ride? .....	56
Protective Apparel.....	56
Rider Training .....	58
Is Your Motorcycle Ready to Ride? .....	59
Pre-ride Inspection .....	59
Load Limits & Guidelines.....	62
Loading.....	62
Load Limits .....	63
Loading Guidelines .....	63



# Are You Ready to Ride?

---

Before you ride your motorcycle for the first time, we urge you to:

- Read this owner's manual.
- Make sure you understand all the safety messages.
- Know how to operate all the controls.

Before each ride, be sure:

- You feel well and are in good physical and mental condition.
- You are wearing an approved motorcycle helmet (with chin strap tightened securely), eye protection, and other protective clothing.
- You don't have any alcohol or drugs in your system.

Make sure your passenger is ready to ride, too, and is wearing proper gear including a helmet.

If you must carry an extra helmet while riding, use a commercially available elastic cord, strap, or net to secure the helmet to the seat.

## Protective Apparel

For your safety, we strongly recommend that you always wear an approved motorcycle helmet, eye protection, boots, gloves, long pants, and a long-sleeved shirt or jacket whenever you ride. Although complete protection is not possible, wearing proper gear can reduce the chance of injury when you ride. Following are suggestions to help you choose the proper gear.

## Are You Ready to Ride?

### Helmets and Eye Protection

Your helmet is your most important piece of riding gear because it offers the best protection against head injuries. A helmet should fit your head comfortably and securely. A bright-colored helmet and reflective strips can make you more noticeable in traffic.

An open-face helmet offers some protection, but a full-face helmet offers more. Regardless of the style, look for a DOT (Department of Transportation) sticker on any helmet you buy (USA only). Always wear a face shield or goggles to protect your eyes and help your vision.

### **⚠ WARNING**

Not wearing a helmet increases the chance of serious injury or death in a crash.

Be sure you and your passenger always wear a helmet, eye protection, and other protective apparel when you ride.

### Additional Riding Gear

In addition to a helmet and eye protection, we also recommend:

- Sturdy boots with non-slip soles to help protect your feet and ankles.
- Leather gloves to help protect your hands.

(cont'd)

# Are You Ready to Ride?

---

- A motorcycle riding suit or jacket for comfort as well as protection. Bright-colored and reflective clothing can help make you more noticeable in traffic. Avoid loose clothes that could get caught on any part of your motorcycle.

## Rider Training

Developing your riding skills is an ongoing process. Even if you have ridden other motorcycles, take time to become familiar with how this motorcycle works and handles. Practice riding the motorcycle in a safe area to build your skills. Do not ride in traffic until you get accustomed to the motorcycle's controls, and feel comfortable with its size and weight.

We urge all riders to take a certified course approved by the Motorcycle Safety Foundation (MSF). New riders should start with the basic course, and even experienced riders will find the advanced course beneficial. For information about the MSF training course nearest you, call the national toll-free number: (800) 446-9227.

Other riding tips can be found in the *Riding Tips* booklet that came with your motorcycle (USA only).

# Is Your Motorcycle Ready to Ride?

Before each ride, it's important to inspect your motorcycle and make sure any problem you find is corrected. A pre-ride inspection is a must, not only for safety, but because having a breakdown, or even a flat tire, can be a major inconvenience.

## **WARNING**

Improperly maintaining this motorcycle or failing to correct a problem before riding can cause a crash in which you can be seriously hurt or killed.

Always perform a pre-ride inspection before every ride and correct any problems.

## Pre-ride Inspection

Check the following items before you get on the motorcycle:

- |                           |  |
|---------------------------|--|
| <i>Tires &amp; Wheels</i> | Look at the tires. If a tire appears low, use an air pressure gauge to check its pressure. Also look for signs of excessive wear (page 152) or damage to the tires and wheels. |
| <i>Chain</i>              | Check the condition of the chain. Adjust slack and lubricate as needed (page 161).   |

(cont'd)

## Is Your Motorcycle Ready to Ride?

---

*Leaks,  
Loose  
Parts*

Walk around your motorcycle and look for anything that appears unusual, such as a leak or loose cable.

*Lights*

Make sure the headlight, running light, brakelight, taillight, license light and turn signals are working properly.

If you are carrying a passenger or cargo, also check the following:

*Load Limits* Make sure you do not exceed the load limits (page 63).

*Cargo* Check that all cargo is secure.

*Adjustments* Adjust the suspension (pages 136, 140) according to your load.

## Is Your Motorcycle Ready to Ride?

---

Check these items after you get on the motorcycle:

- Throttle*      Rotate the throttle to check it moves smoothly without binding.
- Brakes*        Pull the brake lever and press on the brake pedal to check that they operate normally.
- Gauge  
&  
Indicators*    Turn the ignition on and check for normal operation of the gauge and indicators (page 14 ).

If you haven't ridden the motorcycle in over a week, you should also check other items, such as the oil level and other fluids. See *Periodic Maintenance* (page 95 ). Periodic maintenance should also be done at least once a month, no matter how often you ride.

Remember, be sure to take care of any problem you find, or have your Honda dealer correct it before you ride.

## Load Limits & Guidelines

---

Your motorcycle has been designed to carry you and one passenger. When you carry a passenger, you may feel some difference during acceleration and braking. But so long as you keep your motorcycle well-maintained, with good tires and brakes, you can safely carry loads within the given limits and guidelines.

However, exceeding the weight limit or carrying an unbalanced load can seriously impair your motorcycle's handling, braking, and stability. Non-Honda accessories, improper modifications, and poor maintenance can also reduce your safety margin.

### Loading

How much weight you put on your motorcycle, and how you load it, are important to your safety. Anytime you ride with a passenger or cargo, you should be aware of the following information.

#### **WARNING**

Overloading or improper loading can cause a crash and you can be seriously hurt or killed.

Follow all load limits and other loading guidelines in this manual.

## Load Limits & Guidelines

---

### Load Limits

Following are the load limits for your motorcycle:

**maximum weight capacity:**

366 lbs (166 kg)

includes the weight of the rider, passenger, all cargo, and all accessories.

**maximum cargo weight:**

31 lbs (14 kg)

The weight of added accessories will reduce the maximum cargo weight you can carry.

### Loading Guidelines

Your motorcycle is primarily intended for transporting you and a passenger. You may wish to secure a jacket or other small items to the seat when you are not riding with a passenger.

If you wish to carry more cargo, check with your Honda dealer for advice, and be sure to read the information regarding accessories on page 5 .

Improperly loading your motorcycle can affect its stability and handling. Even if your motorcycle is properly loaded, you should ride at reduced speeds and never exceed 80 mph (130 km/h) when carrying cargo. (cont'd)



## Load Limits & Guidelines

---

Follow these guidelines whenever you carry a passenger or cargo:

- Check that both tires are properly inflated (page 150).
- If you change your normal load, you may need to adjust the front suspension (page 136 ) and the rear suspension (page 140 ).
- To prevent loose items from creating a hazard, make sure that all cargo is tied down securely before you ride.
- Place cargo weight as low and close to the center of your motorcycle as possible.
- Balance cargo weight evenly on both sides.

## Basic Operation & Riding

This section gives basic riding instructions, including how to start and stop your engine, and how to use the throttle, clutch, and brakes. It also provides important information on riding with a passenger or cargo.

To protect your new engine and enjoy optimum performance and service life, refer to Break-in Guidelines (page 234 ).

To protect the catalytic converter in your motorcycle's exhaust system, avoid extended idling and the use of leaded gasoline.

Safe Riding Precautions .....	66
Starting & Stopping the Engine .....	67
Preparation.....	68
Starting Procedure .....	69
Flooded Engine .....	70
Bank Angle Sensor Ignition Cut-off System .....	70
How to Stop the Engine .....	71
Shifting Gears.....	72
Braking .....	74
Combined ABS ( CBR1000RR ABS ).....	76
Combined ABS Indicator ( CBR1000RR ABS ).....	78
Parking.....	80
Theft-prevention Tips .....	83
Riding with a Passenger or Cargo.....	85

## Safe Riding Precautions

---

Before riding your motorcycle for the first time, please review the *Motorcycle Safety* section beginning on page 1, and the *Before Riding* section beginning on page 55.

Even if you have ridden other motorcycles, take time to become familiar with how this motorcycle works and handles. Practice in a safe area until you build your skills and get accustomed to the motorcycle's size and weight.

Make sure flammable materials such as dry grass or leaves do not come in contact with the exhaust system when riding, idling, or parking your motorcycle.

## Starting & Stopping the Engine

---

Always follow the proper starting procedure described below.

For your safety, avoid starting or operating the engine in an enclosed area such as a garage. Your motorcycle's exhaust contains poisonous carbon monoxide gas which can collect rapidly in an enclosed area and cause illness or death.

Your motorcycle can be started with the transmission in gear by pulling in the clutch lever before operating the starter.

Your motorcycle is equipped with a side stand ignition cut-off system. If the side stand is down — the engine cannot be started unless the transmission is in neutral. If the side stand is up — the engine can be started in neutral, or in gear with the clutch lever pulled in. After starting with the side stand down, the engine will stop if the transmission is put in gear before raising the side stand.

# Starting & Stopping the Engine

---

## Preparation

Before starting, insert the key, turn the ignition switch ON, and confirm the following:

- The transmission is in neutral (neutral indicator is ON).
- The engine stop switch is set to RUN.
- The warning indicator is ON.
- The low oil pressure indicator is ON.
- The PGM-FI malfunction indicator lamp (MIL) is OFF.
- The high coolant temperature indicator is OFF.
- The HESD indicator is OFF.
- The Combined ABS indicator is ON.  
(CBR1000RR ABS only)

The warning indicator and low oil pressure indicator should go off a few seconds after the engine starts. If the warning indicator and the low oil pressure indicator light, stop the engine immediately and check the engine oil level.

(CBR1000RR ABS only)

The Combined ABS indicator should go off after you ride the motorcycle at a speed above 6 mph (10 km/h).

# Starting & Stopping the Engine

---

## Starting Procedure

This motorcycle has a fuel-injected engine with an automatic fast idle. Follow the procedure indicated below.

### Any Air Temperature

- Press the start button with the throttle completely closed.

The engine will not start if the throttle is fully open (because the electronic control module cuts off the fuel supply).

Even if the engine coolant stays below the specified temperature, the cooling fan sometimes starts up running when you rev up the engine, but this is normal.

The operation temperature of each cooling fan is different. Therefore, it is normal when only one of the fans operate.

Snapping the throttle or fast idling for more than about 5 minutes at normal air temperature may cause exhaust pipe discoloration.

# Starting & Stopping the Engine

---

## Flooded Engine

If the engine fails to start after repeated attempts, it may be flooded with excess fuel. To clear a flooded engine:

1. Leave the engine stop switch set to RUN.
2. Open the throttle fully.
3. Press the start button for 5 seconds.
4. Follow the normal starting procedure.
5. If the engine starts, then open the throttle slightly if idling is unstable. If the engine does not start, wait 10 seconds, then follow steps 1 – 4 again.

If the engine still won't start, refer to *If Your Engine Quits or Won't Start*, page 191 .

## Bank Angle Sensor Ignition Cut-off System

Your motorcycle's banking (lean angle) sensor system is designed to automatically stop the engine and fuel pump if the motorcycle is overturned.

Before restarting the engine, you must turn the ignition switch to the OFF position and then back to ON. The engine will not restart until you perform this procedure.

# Starting & Stopping the Engine

---

## How to Stop the Engine

### Normal Engine Stop

To stop the engine, shift into neutral and turn the ignition switch OFF.

The engine stop switch should normally remain in the RUN position even when the engine is OFF.

If your motorcycle is stopped with the engine stop switch OFF and the ignition switch ON, the headlight and taillight will remain on, resulting in battery discharge.

### Emergency Engine Stop

To stop the engine in an emergency, use the engine stop switch. To operate, press the switch to the OFF position.



# Shifting Gears

---

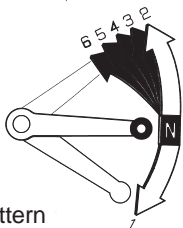

shifting pattern

Your motorcycle has six forward gears in a one-down, five-up shift pattern which is coordinated with a cable-operated clutch system.

Learning when to shift gears comes with experience. Keep the following tips in mind:

- As a general rule, shift while moving in a straight line.

- Close the throttle and pull the clutch lever in completely before shifting. Improper shifting may damage the engine, transmission, and drive train.
- Learn to recognize the engagement point as you release the clutch lever. It is at this point the transmission of power to the rear wheel resumes.
- Upshift to a higher gear or reduce throttle before engine rpm (speed) gets too high. Learn the relationship between engine sound and the normal shifting points.
- Downshift to a lower gear before you feel the engine laboring (lugging) at low rpm.

- Avoid downshifting to help slow your motorcycle when engine rpm is near its allowable maximum (near the tachometer red zone). In this situation, the rev limiter in the engine ignition control module may not prevent excessive engine speed which could damage the engine.
- To prevent transmission damage, do not coast or tow the motorcycle for long distances with the engine off.

### Recommended Shift Points

Ride in the highest gear that lets the engine run and accelerate smoothly. This will give you good fuel economy and effective emissions control. When changing gears under normal conditions, use these recommended shift points:

### *Shifting Up:*

From 1st to 2nd:	12 mph (20 km/h)
From 2nd to 3rd:	19 mph (30 km/h)
From 3rd to 4th:	25 mph (40 km/h)
From 4th to 5th:	31 mph (50 km/h)
From 5th to 6th:	37 mph (60 km/h)

### *Shifting Down:*

From 6th to 5th:	28 mph (45 km/h)
From 5th to 4th:	22 mph (35 km/h)
From 4th to 3rd:	16 mph (25 km/h)

Pull the clutch lever in when speed drops below 12 mph (20 km/h), when engine roughness is evident, or when engine stalling is imminent; and shift down to 1st gear for acceleration.

# Braking

---

Your motorcycle is equipped with disc braking systems which are hydraulically activated. Operating the brake lever applies the two front disc brakes. Depressing the brake pedal applies the rear disc brake.

As a general rule, the front braking system provides about 70 percent of total stopping power.

For full braking effectiveness, use both the pedal and lever simultaneously. Using both braking systems will stop your motorcycle faster with greater stability.

To slow or stop, apply the brake lever and brake pedal smoothly, while downshifting to match your speed.

Gradually increase braking as you feel the brakes slowing your speed. The increase in engine compression from downshifting will help slow your motorcycle.

To prevent stalling the engine, pull the clutch lever in before coming to a complete stop. For support, put your left foot down first, then your right foot when you have finished braking.

Applying the brakes too hard may cause the wheels to lock and slide, reducing control of your motorcycle. If this happens, release the brake controls, steer straight ahead until you regain control, then reapply the brakes more gently.

When possible, reduce your speed or complete braking before entering a turn. Avoid braking or closing the throttle quickly while turning. Either action may cause one or both wheels to slip and reduce your control of your motorcycle.

Your ability to brake in a turn and to brake hard in an emergency situation are important riding skills. We suggest attending a Motorcycle Safety Foundation experienced rider training course (page 58 ) to retain these skills.

When riding in wet or rainy conditions, or on loose surfaces, the ability to maneuver and stop will be reduced. All of your actions should be smooth under these conditions. Rapid acceleration, braking or turning may cause loss of control.

For your safety, exercise extreme caution when braking, accelerating or turning.

When descending a long, steep grade, use engine compression braking by downshifting, with intermittent use of both brakes. Continuous brake application can overheat the brakes and reduce their effectiveness.

Riding with your foot resting on the brake pedal or your hand on the brake lever may actuate the brakelight, giving a false indication to other drivers. It may also overheat the brakes, reducing effectiveness.

# Braking

---

## Combined ABS

(CBR1000RR ABS)

This model is equipped with Combined ABS (Combined Anti-lock Brake System). When the ignition switch is turned ON, the system performs a self-analysis and when the vehicle speed reaches 6 mph (10 km/h) the system starts to operate and remains on while riding. Combined ABS is self-checking.

Combined ABS is an electrically integrated system consisting of the Combined Brake System and Anti-lock Brake System. Combined ABS controls braking force by accurately monitoring the amount of force applied to the brakes and wheel speed. It balances the front-to-rear

braking distribution, and has an anti-lock function designed to help prevent wheel lock up during hard braking. Moreover, Combined ABS helps provide more riding stability when braking hard and suddenly. Although the wheel may not lock up, if you are braking too hard in a turn, the motorcycle can still lose traction causing a loss of control. In general, you'll achieve the best results by braking while running in a straight line.

Even if the front brake lever and the rear brake pedal are operated independently, the brake force is distributed appropriately to the front and the rear. However, for full braking effectiveness, use both the lever and pedal simultaneously, as you would with a conventional motorcycle braking system.

In some situations, a motorcycle with Combined ABS may require a longer stopping distance to stop on loose or uneven surfaces than an equivalent motorcycle without Combined ABS.

Combined ABS cannot make up for road conditions, bad judgment, or improper operation of the brakes, and cannot stop rear wheel lift completely. It is still your responsibility to ride at reasonable speeds for weather, road surface, and traffic conditions, and to leave a margin of safety.

- The anti-lock brake function of the Combined ABS may be activated by riding over a sharp drop or rise in the road level while operating the brake.
- It is important to follow the tire recommendations (page 157 ). The Combined ABS computer works by comparing wheel speed. Non-recommended tires can affect wheel speed and may confuse the Combined ABS computer.
- Combined ABS does not function at low speeds (approximately 4 mph (6 km/h) or below).
- Combined ABS does not function if the battery is discharged.
- Combined ABS does not function if the ABS main or the ABS motor fuses are blown.

# Braking

---

- When Combined ABS does not function, the brakes work like a conventional braking system. On conventional braking systems, operating the front brake lever applies the front brake and operating the rear pedal applies the rear brake.

You may feel a change in the way the brake lever/pedal reacts when it is operated under the following conditions:

- Immediately after turning the ignition switch ON
- After braking to a stop

## Combined ABS Indicator

(CBR1000RR ABS)

Normally, this indicator comes on when the ignition is turned ON, and goes off after you ride the motorcycle at a speed above 6 mph (10 km/h). If there is a problem with Combined ABS, the indicator lights or flashes and remains on. Combined ABS does not operate when the Combined ABS indicator is on.

If the Combined ABS indicator lights or flashes and remains on while riding, stop the motorcycle in a safe place and turn off the engine.

Turn the ignition ON again. The indicator should come on, and go off after you ride the motorcycle at a speeds above 6 mph (10 km/h). If it does not go off, Combined ABS is not functioning, but the brakes still provide normal stopping ability like a conventional braking system. However, you should have the system checked by your Honda dealer as soon as possible.

The Combined ABS indicator may flash if:

- The front wheel leaves the ground for 1 second or more.
- Either brake is applied continuously from 0 mph (0 km/h) to 31 mph (50 km/h).
- You turn the rear wheel while the motorcycle is upright on the stand.

This is normal but the Combined ABS is not in operation. To activate the system again, turn the ignition OFF, then ON again.



# Parking

---

1. Look for a level parking area. If you can't park on a paved surface, make sure the ground surface is firm, especially under the side stand. If you must park on a hill, leave the transmission in gear and position the rear tire against the curb at a 45 degree angle.

Make sure flammable materials such as dry grass or leaves do not come in contact with the exhaust system when parking your motorcycle. Refer to *Catalytic Converter*, page 242.

To avoid possible heat damage to your motorcycle or personal belongings, do not cover the exhaust muffler with a protective cover or any clothing within 20 minutes after shutting off the engine.

2. Use the side stand to support the motorcycle while parked.
  - To lower the side stand, use your foot to guide it down. Remember that lowering the side stand with the transmission in gear will stop the engine, even if the clutch lever is pulled in. That is a function of the side stand ignition cut-off system.
  - Check that the side stand is down all the way so that the side stand ignition cut-off system (page 67 ) is activated.
  - If you have to park on a soft surface, insert something solid under the side stand for support.

FRONT

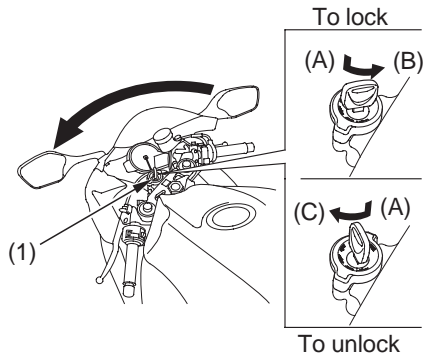

(1) ignition key

- (A) push in
- (B) turn to LOCK
- (C) turn to OFF

3. Use the steering lock, which locks the handlebar in place. Turn the handlebar all the way to the left. Push in on the ignition key (1) and turn it to LOCK. Remove the key.

To unlock the steering lock, insert and push down on the key and turn it to the right to the OFF position.

## Parking

### LEFT REAR

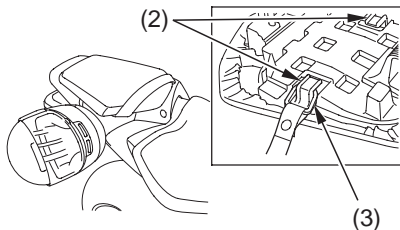

(2) helmet holders

(3) D-ring

4. Use the helmet holders (2) to secure your and your passengers helmets to your motorcycle:
  - Remove the rear seat (page 110).
  - Hook the D-ring (3) of the helmet onto the helmet holder and install the rear seat to lock it.

### **⚠ WARNING**

Riding with a helmet attached to the holder can interfere with the rear wheel or suspension and could cause a crash in which you can be seriously hurt or killed.

Use the helmet holder only while parked. Do not ride with a helmet secured by the holder.

## Theft-prevention Tips

- Park your motorcycle in a locked garage whenever possible. If a garage isn't available, park in a concealed area or in a well-lit area with enough pedestrian traffic to discourage a thief.
  - Always take the ignition key with you.
  - Always use the steering lock (page 81 ), even if you're parking for just a minute or two. A thief can easily push an unlocked motorcycle to a waiting truck.
  - In addition to the steering lock, use a good quality anti-theft device made specifically to lock a motorcycle to a secure object.
- If you decide to use an anti-theft device, select one of good quality and be sure to follow the manufacturer's instructions.
  - The rear fender has a storage compartment to store a U-shaped lock under the rear seat. Some U-shaped locks may not be stored in the compartment due to their size or design.

(cont'd)

## Parking

---

UNDER REAR SEAT  
(CBR1000RR)

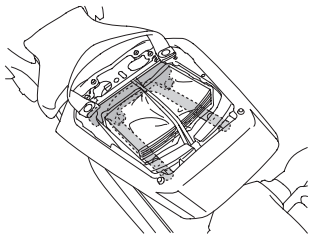

(CBR1000RR ABS)

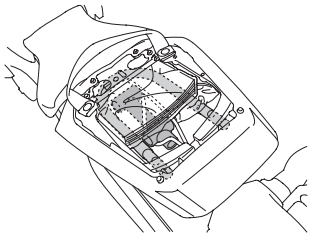

- Keep your owner's manual, current registration, and insurance information with your motorcycle. This will make it easier for the authorities to find you if your motorcycle is stolen and recovered.

## Riding with a Passenger or Cargo

---

Your motorcycle is a high-performance sport model designed to carry you and one passenger. Whenever you add a passenger or cargo, you must be careful not to exceed the total load limits for this vehicle (*Load Limits*, page 63 ). Make sure your cargo is properly secured (*Loading Guidelines*, page 63 ).

Also consider adjusting the suspension (page 135 ) for the extra load.

Be aware that carrying a passenger or heavy cargo can affect acceleration, braking, and handling.

Before riding with a passenger, make sure your passenger is wearing the proper protective apparel (page 56 ). Also check that your passenger is not wearing any loose apparel that might get caught in the drive chain.

Tell your passenger to hold the seat strap or your waist, lean with you in the turns, and keep their feet on the passenger footpegs at all times, even when the motorcycle is stopped at a traffic light.



To help keep your motorcycle in good shape, this section includes a Maintenance Schedule for required service, a list of periodic checks you should perform at least once a month, and step-by-step instructions for specific maintenance tasks. You'll also find important safety precautions, information on fuels and oils, and tips for keeping your Honda looking great.

For information about the exhaust emission and noise emission requirements of the U.S. Environmental Protection Agency (EPA), the California Air Resources Board (CARB), and Environment Canada (EC), see page 235 .

For information about replacing fuses, see page 213 .

USA only

**Maintenance, replacement or repair of the emission control devices and systems may be performed by any motorcycle repair establishment or individual using parts that are “certified” to EPA standards.**

### *Before You Service Your Honda*

The Importance of Maintenance.....	90
Maintenance Safety.....	91
Important Safety Precautions.....	92
Periodic Maintenance.....	94
Maintenance Schedule .....	96
Maintenance Record .....	101

(cont'd)



# Servicing Your Honda

---

## *Service Preparations*

Maintenance Component Locations ...	103
Tool Kit.....	106
Owner's Manual Storage .....	107
Seat Removal.....	109
Lower Cowl Removal .....	111

## *Service Procedures*

### Fluids & Filters

Fuel .....	112
Engine Oil & Filter.....	115
Coolant.....	125

### Engine

Throttle .....	129
Clutch System.....	131

### Chassis

Suspension .....	135
Brakes .....	144
Tires .....	150
Side Stand.....	159
Drive Chain .....	160

### Electrical

Battery .....	168
---------------	-----

Appearance Care .....	174
-----------------------	-----

## Servicing Your Honda

---

The following table summarizes the three types of inspections and servicing recommendations for your motorcycle. Both the pre-ride inspection and the scheduled maintenance at the recommended intervals are necessary to assure safe and dependable performance. The periodic checks provide additional confidence in your motorcycle's performance.

Type of Inspection/Service	Refer to page:	When Performed	Who Performs
Pre-ride Inspection	59	before every ride	you
Periodic Maintenance	94	monthly*	you
Maintenance Schedule	96	interval on schedule	your Honda dealer**

\* more often if you ride frequently or long distances; or anytime you clean your motorcycle

\*\* unless you have the proper tools and service data and are mechanically qualified

## The Importance of Maintenance

---

Keeping your motorcycle well-maintained is absolutely essential to your safety. It's also a good way to protect your investment, get maximum performance, avoid breakdowns, and have more fun. A properly maintained motorcycle will also help to reduce air pollution.

Remember, proper maintenance is the owner's responsibility. Be sure to inspect your motorcycle before each ride, perform the periodic checks, and follow the Maintenance Schedule in this section.

### **WARNING**

Improperly maintaining this motorcycle or failing to correct a problem before you ride can cause a crash in which you can be seriously hurt or killed.

Always follow the inspection and maintenance recommendations and schedules in this owner's manual.

If your motorcycle overturns or is involved in a crash, be sure your Honda dealer inspects all major parts, even if you are able to make some of the repairs yourself.

This section includes instructions on how to perform some important maintenance tasks. If you have basic mechanical skills, you can perform many of these tasks with the tools provided with your motorcycle.

Other tasks that are more difficult and require special tools are best performed by professionals. Wheel removal should normally be handled only by a Honda technician or other qualified mechanic. Instructions are included in this manual only to assist in emergency service.

Some of the most important safety precautions follow. However, we cannot warn you of every conceivable hazard that can arise in performing maintenance. Only you can decide whether or not you should perform a given task.

### **WARNING**

Failure to properly follow maintenance instructions and precautions can cause you to be seriously hurt or killed.

Always follow the procedures and precautions in this owner's manual.

# Maintenance Safety

---

## Important Safety Precautions

- Make sure the engine is off before you begin any maintenance or repairs. This will help eliminate several potential hazards:

**Carbon monoxide poisoning from engine exhaust.** Be sure there is adequate ventilation whenever you operate the engine.

**Burns from hot motorcycle parts.** Let the engine and exhaust system cool before touching.

**Injury from moving parts.** Do not run the engine unless instructed to do so.

- Read the instructions before you begin, and make sure you have the tools and skills required.
- To help prevent the motorcycle from falling over, park it on a firm, level surface, using the side stand or a maintenance stand to provide support.
- To reduce the possibility of a fire or explosion, be careful when working around gasoline. Use only non-flammable solvent, not gasoline, to clean parts. Keep cigarettes, sparks, and flames away from all fuel-related parts.

Remember that your Honda dealer knows your motorcycle best and is fully equipped to maintain and repair it. To ensure the best quality and reliability, use only new Honda Genuine Parts or their equivalents for repair and replacement. If you have the tools and skills required for additional maintenance jobs, you can purchase an official Honda Service Manual (page 246 ).

## Periodic Maintenance

---

In addition to the regularly scheduled maintenance (page 96) and daily pre-ride inspection (page 59), consider performing the periodic checks on the following page at least once a month, even if you haven't ridden your motorcycle, or as often as once a week if you ride frequently or for long distances. It's a good idea to perform this maintenance any time you clean your motorcycle.

Check the odometer reading and perform any scheduled maintenance checks that are needed (page 96). Remember, more frequent checks may be needed for riding in severe conditions.

## Periodic Maintenance

---

<i>Tires &amp; Wheels</i>	<p>Check the air pressure with a gauge and add air if needed (page 150 ).</p> <p>Examine the tread for wear (page 152 ).</p> <p>Look closely for nails, embedded objects, cuts, and other types of damage (page 152 ). Roll your motorcycle so you can inspect the entire surface.</p> <p>Check the condition of the wheels.</p>
Fluids	<p>Check the levels of the engine oil (page 119 ), coolant (page 126 ), and brake fluid (page 146 ). Add the correct fluid as necessary, and investigate the cause of any low fluid level.</p>
Lights	<p>Make sure the headlight, running light, brakelight, taillight, license light and turn signals are working properly.</p>
Freeplay	<p>Check the freeplay of the clutch lever (page 131 ) and throttle grip (page 129 ).</p>
Drive Chain	<p>Check condition, adjust slack, and lubricate as needed (page 160 ).</p>
Fuses	<p>Make sure you have a full supply of spare fuses.</p>
Nuts & Bolts	<p>Check the major fasteners and tighten as needed.</p>



## Maintenance Schedule

---

The required Maintenance Schedule that follows specifies how often you should have your motorcycle serviced, and what things need attention. It is essential to have your motorcycle serviced as scheduled to maintain safe, dependable performance and proper emission control.

The service intervals in this Maintenance Schedule are based on average riding conditions. Some items will need more frequent service if you ride in unusually wet or dusty areas or at full throttle. Consult your Honda dealer for recommendations applicable to your individual needs and use.

Some items in the Maintenance Schedule can be performed with basic mechanical skills and hand tools. Procedures for these items are provided in this manual. Other items involve more extensive procedures and may require special training, tools, and equipment. We recommend that you have your Honda dealer perform these tasks unless you have advanced mechanical skills and the required tools and equipment. Procedures for such items in this schedule are provided in an official Honda Service Manual available for purchase (page 246).

## Maintenance Schedule

---

If you do not feel capable of performing a given task or need assistance, remember that your Honda dealer knows your motorcycle best and is fully equipped to maintain and repair it. If you decide to do your own maintenance, use only Honda Genuine Parts or their equivalents for repair or replacement to ensure the best quality and reliability.

Perform the pre-ride inspection (page 59) and owner maintenance (page 98) at each scheduled maintenance period.

Each item on the maintenance schedule requires some mechanical knowledge. Certain items (particularly those marked \* and \*\*) may require more technical information and tools. Consult your Honda dealer.

- \* Should be serviced by your Honda dealer, unless you have the proper tools and service data and are mechanically qualified. Refer to the official Honda Service Manual (page 246).
- \*\*In the interest of safety, we recommend these items be serviced only by your Honda dealer.

# Maintenance Schedule

---

## *Summary of Maintenance Schedule Notes & Procedures:*

### NOTES:

1. At higher odometer readings, repeat at the frequency interval established here.
2. Service more frequently when riding in unusually wet or dusty areas.
3. California type only.
4. Replace every 2 years, or at indicated odometer interval, whichever comes first. Replacement requires mechanical skill. Refer to the official Honda Service Manual.

### Maintenance Procedures:

I: inspect and clean, adjust, lubricate,  
or replace, if necessary

C: clean

A: adjust

L: lubricate

R: replace

# Maintenance Schedule

ITEM		FREQUENCY	NOTE	ODOMETER READING (Note 1)							Refer to page	
				× 1,000 mi	0.6	4	8	12	16	20		24
				× 1,000 km	1.0	6.4	12.8	19.2	25.6	32.0		38.4
EMISSIONS-RELATED ITEMS	* FUEL LINE					I		I		I	—	
	* THROTTLE OPERATION					I		I		I	129	
	* AIR CLEANER	2					I			I	—	
	* SPARK PLUGS			EVERY 16,000 mi (25,600 km) I, EVERY 32,000 mi (51,200 km) R							—	
	* VALVE CLEARANCE							I			—	
	ENGINE OIL			INITIAL = 600 mi (1,000 km) or 1 month: R REGULAR = EVERY 8,000 mi (12,800 km), or 12 months: R							115	
	ENGINE OIL FILTER			R		R		R		R	120	
	RADIATOR COOLANT	4				I		I		R	125	
	* COOLING SYSTEM					I		I		I	—	
	* SECONDARY AIR SUPPLY SYSTEM					I		I		I	—	
	* EVAPORATIVE EMISSION CONTROL SYSTEM	3					I			I	—	
	** EXHAUST GAS CONTROL ACTUATOR CABLE			EVERY 16,000 mi (25,600 km) I							—	

\* Should be serviced by your Honda dealer, unless you have the proper tools and service data and are mechanically qualified. Refer to the official Honda Service Manual (page 246).

\*\*In the interest of safety, we recommend these items be serviced only by your Honda dealer.

# Maintenance Schedule

ITEM		FREQUENCY	NOTE	ODOMETER READING (Note 1)								Refer to page
				× 1,000 mi	0.6	4	8	12	16	20	24	
				× 1,000 km	1.0	6.4	12.8	19.2	25.6	32.0	38.4	
NON-EMISSION-RELATED ITEMS		DRIVE CHAIN		EVERY 500 mi (800 km) I, L								160
		BRAKE FLUID	4		I	I	R	I	I	R	145	
		BRAKE PAD WEAR			I	I	I	I	I	I	148	
		BRAKE SYSTEM		I		I		I		I	144	
	*	BRAKE LIGHT SWITCH				I		I		I	—	
	*	HEADLIGHT AIM				I		I		I	—	
		CLUTCH SYSTEM		I	I	I	I	I	I	I	131	
		SIDE STAND				I		I		I	159	
	*	SUSPENSION				I		I		I	—	
	*	NUTS, BOLTS, FASTENERS		I		I		I		I	—	
	**	WHEELS/TIRES				I		I		I	—	
	**	STEERING HEAD BEARINGS		I		I		I		I	—	

\* Should be serviced by your Honda dealer, unless you have the proper tools and service data and are mechanically qualified. Refer to the official Honda Service Manual (page 246).

\*\*In the interest of safety, we recommend these items be serviced only by your Honda dealer.

## Maintenance Record

---

Keeping an accurate maintenance record will help ensure that your motorcycle is properly maintained. Retain detailed receipts to verify the maintenance was performed. If the motorcycle is sold, these receipts should be transferred with the motorcycle to the new owner. Make sure whoever performs the maintenance completes this record. All scheduled maintenance, including the 600 mile (1,000 km) initial maintenance, is considered a normal owner operating cost and will be charged for by your dealer. Use the space under Notes to record anything you want to remind yourself about or mention to your dealer.

<b>Miles (km)</b>	<b>Odometer</b>	<b>Date</b>	<b>Performed By:</b>	<b>Notes</b>
600 (1,000)				
4,000 (6,400)				
8,000 (12,800)				
12,000 (19,200)				
16,000 (25,600)				
20,000 (32,000)				

## Maintenance Record

---

<b>Miles (km)</b>	<b>Odometer</b>	<b>Date</b>	<b>Performed By:</b>	<b>Notes</b>
24,000 (38,400)				
28,000 (44,800)				
32,000 (51,200)				
36,000 (57,600)				
40,000 (64,000)				
44,000 (70,400)				
48,000 (76,800)				
52,000 (83,200)				
56,000 (89,600)				
60,000 (96,000)				
64,000 (102,400)				
68,000 (108,800)				

# Maintenance Component Locations

---

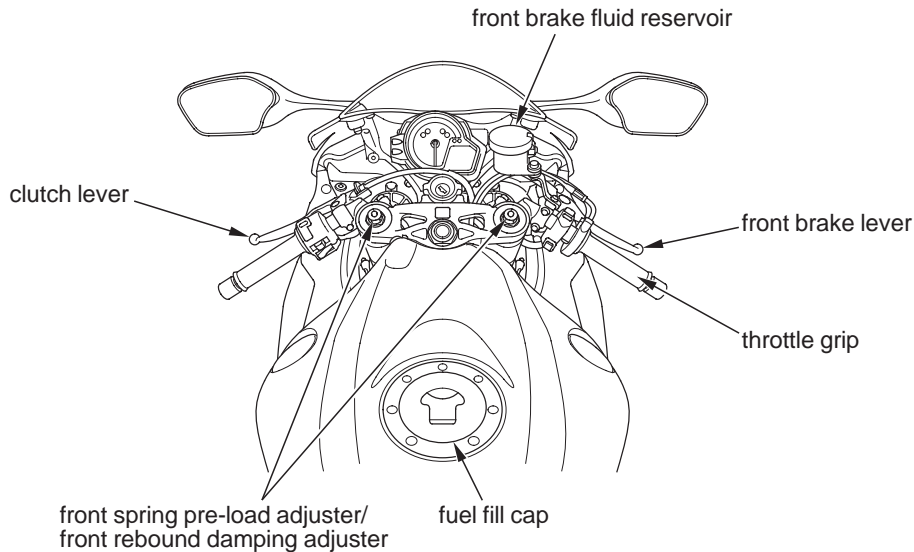



# Maintenance Component Locations

---

tool kit/  
owner's manual storage compartment

coolant reserve tank

rear brake caliper

rear brake fluid reservoir

rear brake pedal

engine oil filler cap

dipstick

engine oil drain bolt

engine oil filter

front suspension  
compression  
damping adjuster

front brake caliper

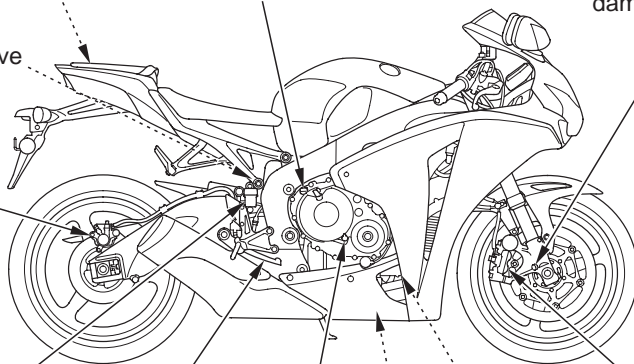

# Maintenance Component Locations

---

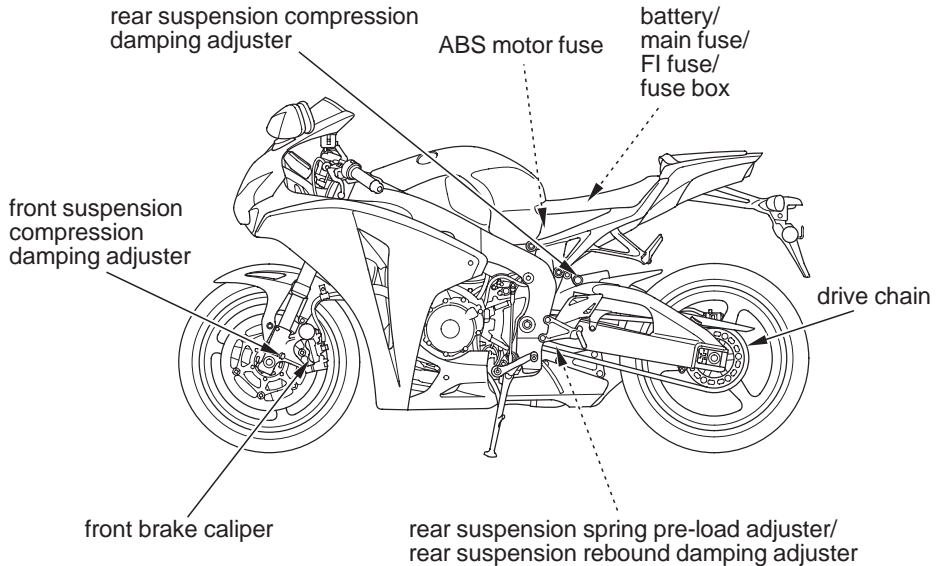

## Tool Kit

---

The tool kit (1) is stored under the rear seat (page 110).

An optional, larger tool kit may be available. Check with your Honda dealer's parts department.

UNDER REAR SEAT  
(CBR1000RR)

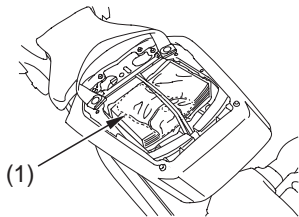

(CBR1000RR ABS)

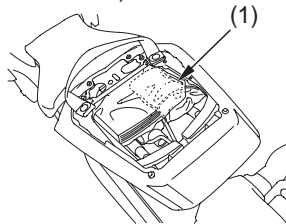

(1) tool kit

## Owner's Manual Storage

Your motorcycle provides storage for the owner's manual so you'll have it with you for easy reference. Store your owner's manual (and other documents) in the plastic storage bag (1) in the owner's manual storage compartment (2) under the rear seat (page 110).

Be careful not to flood this area when washing your motorcycle.

### UNDER REAR SEAT (CBR1000RR)

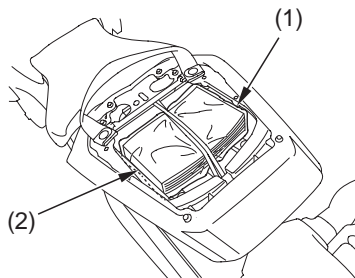

- (1) storage bag
- (2) owner's manual storage compartment

(cont'd)

# Owner's Manual Storage

---

(CBR1000RR ABS)

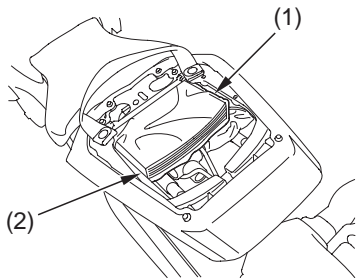

# Seat Removal

Refer to *Safety Precautions* on page 92 .

## Front Seat Removal

The front seat must be removed for battery or fuse maintenance.

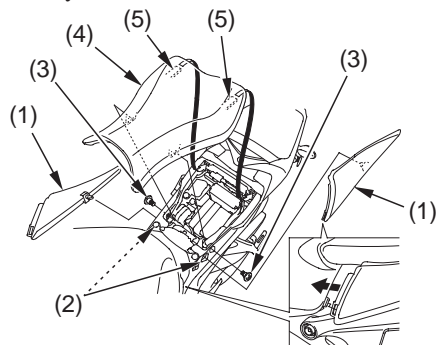

- (1) side covers
- (2) grommets
- (3) screws

- (4) front seat
- (5) prongs

## Removal:

1. To remove the right and left side covers (1), release the tabs from the guides, and carefully pull the cover out from the grommets (2).  
The right and left side covers can be removed in the same manner.
2. Remove the screws (3), and then pull the front seat (4) forward and up.

## Installation:

1. Insert the prongs (5) into the seat hooks and tighten the mounting bolts securely.
2. Insert the tabs into the guides, and align the side covers prong with the rubber grommets.

# Seat Removal

## Rear Seat Removal

The rear seat must be removed to access the tool kit and owner's manual.

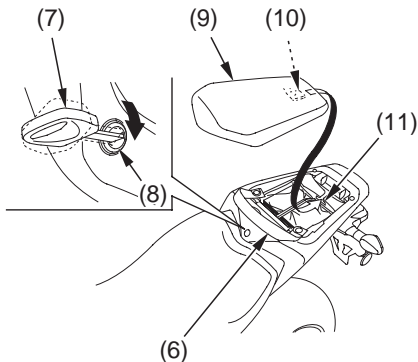

- |                  |                |
|------------------|----------------|
| (6) seat strap   | (9) rear seat  |
| (7) ignition key | (10) prong     |
| (8) seat lock    | (11) seat hook |

## *Removal:*

1. Move the seat strap (6) forward.
2. Insert the ignition key (7) into the seat lock (8). Turn it clockwise, then pull the rear seat (9) up and forward.

## *Installation:*

1. To install the seat, insert the prong (10) into the seat hook (11), and then push down on the front of the seat.
2. Return the seat strap to its normal position.  
Be sure the seat is locked securely in position after installation.

## Lower Cowl Removal

Refer to *Safety Precautions* on page 92 .

The lower cowl must be removed to adjust the clutch lever freeplay and to change the oil filter.

### Removal

1. Remove the bolt A (1) and bolts B (2).
2. Remove the lower cowl (3) carefully in the procedure shown in the illustration, then pull out the tubes (4).

### Installation

- Installation can be done in the reverse order of removal.
- Route the tubes through the opening of the lower cowl.

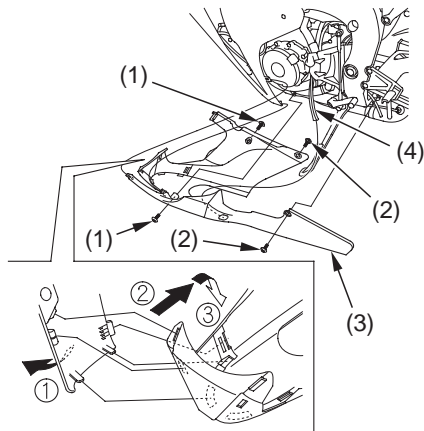

(1) bolts A  
(2) bolts B

(3) lower cowl  
(4) tubes



# Fuel

---

Refer to *Safety Precautions* on page 92 .

## Fuel Recommendation

type	premium unleaded
pump octane number	91 (or higher)

We recommend that you use premium unleaded fuel because it produces fewer engine deposits and extends the life of exhaust system components.

The use of leaded gas will damage the catalytic converter.

Your engine is designed to use any premium gasoline that has a pump octane number of 91 or higher. Gasoline pumps at service stations normally display the pump octane number. For information on the use of oxygenated fuels, see page 243 .

Use of lower octane gasoline can cause persistent “pinging” or “spark knock” (a loud rapping noise) which, if severe, can lead to engine damage. Light pinging experienced while operating under a heavy load, such as climbing a hill, is no cause for concern.

If pinging or spark knock occurs at a steady engine speed under normal load, change brands of gasoline. If pinging or spark knock persists, consult your Honda dealer.

Never use stale or contaminated gasoline or an oil/gasoline mixture. Avoid getting dirt, dust, or water in the fuel tank.

## Fuel Capacity

Fuel tank capacity:  
4.68 US gal (17.7 ℓ)

The tank should be refilled as soon as possible when the low fuel indicator comes on.

## Refueling Procedure

Refer to *Safety Precautions* on page 92 .

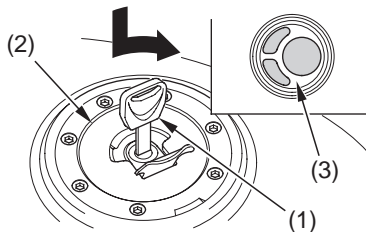

- (1) ignition key      (3) level plate  
(2) fuel fill cap

1. Insert the ignition key (1) in the fuel fill cap (2) and turn it clockwise.

(cont'd)

# Fuel

---

2. Open the fuel fill cap.
3. Add fuel until the level reaches the level plate (3). Avoid overfilling the tank. There should be no fuel above the level plate.

## **WARNING**

Gasoline is highly flammable and explosive. You can be burned or seriously injured when handling fuel.

- Stop the engine and keep heat, sparks and flame away.
- Handle fuel only outdoors.
- Wipe up spills immediately.

4. After refueling, push the fuel fill cap closed until it snaps and locks.
5. Remove the ignition key from the fuel fill cap.

## Engine Oil & Filter

---

Engine oil quality is a major factor that affects both the performance and the service life of the engine.

Using the proper oil (page 116 ) and filter, and regularly checking, adding, and changing oil will help extend your engine's life. Even the best oil wears out. Changing oil helps get rid of dirt and deposits in the engine. Operating the engine with old or dirty oil can damage your engine. Running the engine with insufficient oil can cause serious damage to the engine and transmission.

Change the engine oil as specified in the maintenance schedule on page 99.

When running in very dusty conditions, oil changes should be performed more frequently than specified in the maintenance schedule.

# Engine Oil & Filter

---

## Oil Recommendation

API classification	SG or higher except oils labeled as energy conserving on the circular API service label
viscosity (weight)	SAE 10W-30
JASO T 903 standard	MA

### suggested oil\*

Pro Honda GN4 4-stroke oil (USA & Canada), or Honda 4-stroke oil (Canada only), or an equivalent motorcycle oil.

- \* Suggested oils are equal in performance to SJ oils that are not labeled as energy conserving on the circular API service label.

## Engine Oil & Filter

- Your motorcycle does not need oil additives. Use the recommended oil.
- Do not use oils with graphite or molybdenum additives. They may adversely affect clutch operation.
- Do not use API SH or higher oils displaying a circular API “energy conserving” service label on the container. They may affect lubrication and clutch performance.



NOT RECOMMENDED



OK

- Do not use non-detergent, vegetable, or castor based racing oils.

Other viscosities shown in the following chart may be used when the average temperature in your riding area is within the indicated range.

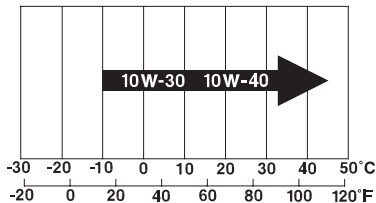

# Engine Oil & Filter

---

## JASO T 903 standard

The JASO T 903 standard is an index for engine oils for 4-stroke motorcycle engines.

There are two classes: MA and MB.

Oil conforming to the standard is labeled on the oil container. For example, the following label shows the MA classification.

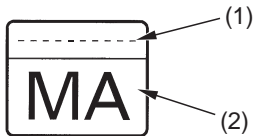

PRODUCT MEETING JASO T 903  
COMPANY GUARANTEEING THIS MA PERFORMANCE:

- (1) code number of the sales company of the oil
- (2) oil classification

Use only MA classification engine oil for your motorcycle. Using engine oil other than MA classification oil could result in damage to the assist-slipper clutch system.

The assist-slipper clutch system helps to prevent the rear tire from locking up when the deceleration of your motorcycle produces a strong engine braking effect. It also makes the clutch lever operation feel lighter.

## Checking & Adding Oil

Refer to *Safety Precautions* on page 92 .

RIGHT SIDE

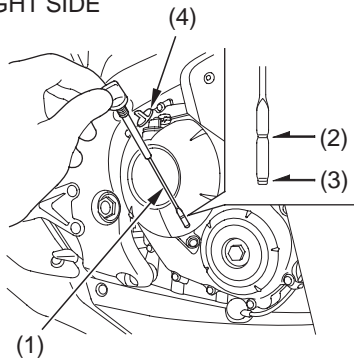

- (1) dipstick                      (3) lower level mark  
(2) upper level mark      (4) oil filler cap

1. Park your motorcycle on its side stand on a firm, level surface.
2. Start the engine and let it idle for 3–5 minutes. Make sure the warning indicator and low oil pressure indicator go off. If the indicators remains on, stop the engine immediately.
3. Stop the engine and wait 2–3 minutes.
4. Remove the dipstick (1) and wipe it clean.
5. Hold the motorcycle in an upright position.
6. Insert the dipstick until it seats, but don't screw it in.

(cont'd)



## Engine Oil & Filter

---

7. Remove the dipstick and check the oil level.
  - If the oil is at or near the upper level mark (2) — you do not have to add oil.
  - If the oil is below or near the lower level mark (3) — remove the oil filler cap (4) and add the recommended oil until it reaches the upper level mark. (Do not overfill.)
8. Reinstall the oil filler cap.
9. Reinstall the dipstick.
10. Check for oil leaks.

### Changing Engine Oil & Filter

Refer to *Safety Precautions* on page 92 .

Your motorcycle's oil filter has very specific performance requirements. Use a new Honda Genuine oil filter or a filter of equal quality specified for your model.

#### NOTICE

*Using the wrong oil filter may result in leaks or engine damage.*

## Engine Oil & Filter

This procedure requires mechanical skill and professional tools such as a torque wrench and oil filter wrench, as well as a means for disposing of the drained fluid (page 188 ). If you do not have the skills or the tools, see your Honda dealer.

### *Drain the Engine Oil:*

1. Park the motorcycle on its side stand on a firm, level surface.
2. Remove the lower cowl (page 111 ).
3. If the engine is cold, start it and let it idle for 3–5 minutes. Turn the engine off. Wait 2–3 minutes for the oil to settle.
4. Place a drain pan under the crankcase.

5. To drain the oil, remove the oil filler cap, engine oil drain bolt ( 1 ), and sealing washer ( 2 ).

### FRONT, UNDER ENGINE

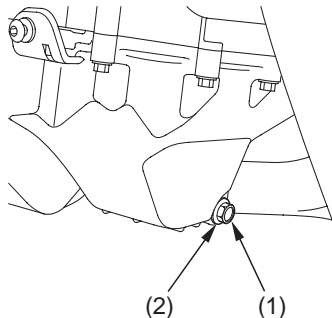

- (1) engine oil drain bolt  
(2) sealing washer

(cont'd)

# Engine Oil & Filter

---

*Install a New Oil Filter:*

6. Remove the screw (3) on the right middle cowl (4) and pull it outwards.

RIGHT SIDE

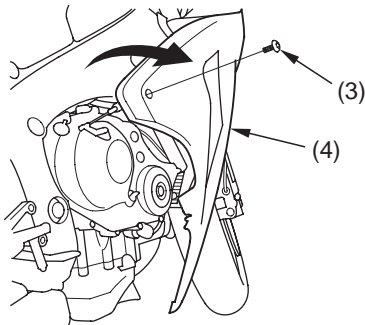

- (3) screw
- (4) middle cowl

7. Remove the oil filter (5) with a filter wrench and let the remaining oil drain out. Discard the oil filter in an approved manner (page 188).

RIGHT SIDE

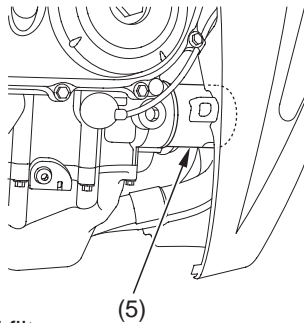

- (5) oil filter

## Engine Oil & Filter

- Pour the drained oil into a suitable container and dispose of it in an approved manner (page 188).

### NOTICE

*Improper disposal of drained fluids is harmful to the environment.*

- Apply a thin coat of engine oil to the rubber seal (6) of a new oil filter.

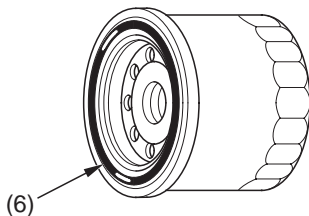

(6) rubber seal

- Install the new oil filter and tighten it by hand.
- Using an oil filter wrench attachment and a torque wrench, tighten the new oil filter to the specified torque:  
19 lbf·ft (26 N·m , 2.7 kgf·m)

(cont'd)

## Engine Oil & Filter

---

12. Check the condition of the sealing washer on the engine oil drain bolt. Replace the washer every other time the oil is changed.  
Install the engine oil drain bolt and tighten it to the specified torque:  
**22 lbf·ft (30 N·m , 3.0 kgf·m)**

### *Add Engine Oil:*

13. Fill the crankcase with the recommended oil (page 116 ), approximately:  
**3.2 US qt (3.0 ℓ)**
14. Install the oil filler cap.

15. Start the engine and let it idle for 3 – 5 minutes.
16. Stop the engine and wait 2 – 3 minutes.
17. Hold the motorcycle upright and check that the oil level is at the upper level mark on the dipstick (page 119).
18. Check that there are no oil leaks.
19. Install the right middle cowl with screw.
20. Install the lower cowl (page 111).

If a torque wrench is not used for installation, see your Honda dealer as soon as possible to verify proper assembly.

Your motorcycle's liquid cooling system dissipates engine heat through the coolant jacket that surrounds the cylinder and cylinder head.

Maintaining the coolant will allow the cooling system to work properly and prevent freezing, overheating, and corrosion.

## Coolant Recommendation

Use Pro Honda HP coolant or an equivalent high quality ethylene glycol antifreeze containing corrosion protection inhibitors specifically recommended for use in aluminum engines. Check the antifreeze container label.

Use only distilled water as a part of the coolant solution. Water that is high in mineral content or salt may be harmful to the aluminum engine.

### NOTICE

*Using coolant with silicate inhibitors may cause premature wear of water pump seals or blockage of radiator passages. Using tap water may cause engine damage.*

The factory provides a 50/50 solution of antifreeze and water in this motorcycle. This coolant solution is recommended for most operating temperatures and provides good corrosion protection.

# Coolant

Decreasing the concentration of antifreeze to less than 40% will not provide proper corrosion protection.

Increasing the concentration of antifreeze is not recommended because it decreases cooling system performance. Higher concentrations of antifreeze (up to 60%) should only be used to provide additional protection against freezing. Check the cooling system frequently during freezing weather.

## Checking & Adding Coolant

Refer to *Safety Precautions* on page 92 .

### RIGHT SIDE

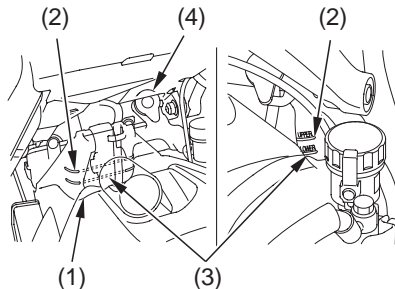

- (1) reserve tank
- (2) UPPER level mark
- (3) LOWER level mark
- (4) reserve tank cap

1. With the engine at normal operating temperature, check the coolant level in the reserve tank ( 1 ). It should be between the UPPER ( 2 ) and LOWER ( 3 ) level marks.

If the reserve tank is empty, or if coolant loss is excessive, check for leaks and see your Honda dealer for repair.

2. Remove the reserve tank cap ( 4 ). Always add coolant to the reserve tank. Do not attempt to add coolant by removing the radiator cap.
3. Add coolant to the reserve tank as required to bring the coolant level to the UPPER level mark.
4. Install the reserve tank cap.

## Coolant Replacement

Refer to *Safety Precautions* on page 92 .

Coolant should be replaced by your Honda dealer, unless you have the proper tools and service data and are mechanically qualified. Refer to the official Honda Service Manual (page 246 ).



# Coolant

---

## **WARNING**

Removing the radiator cap while the engine is hot can cause the coolant to spray out, seriously scalding you.

Always let the engine and radiator cool down before removing the radiator cap.

To properly dispose of drained coolant, refer to *You & the Environment*, page 188 .

## **NOTICE**

*Improper disposal of drained fluids is harmful to the environment.*

## Throttle Freeplay

Refer to *Safety Precautions* on page 92 .

### RIGHT HANDLEBAR

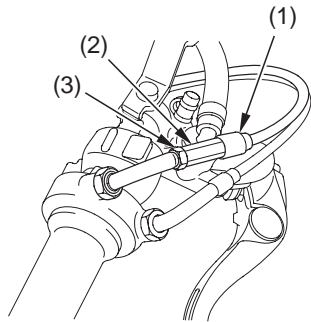

- (1) throttle cable boot
- (2) adjuster
- (3) lock nut

### Inspection

Check freeplay at the throttle grip flange.

Freeplay:

1/16 – 1/4 in (2 – 6 mm)

If necessary, adjust to the specified range.

### Adjustment

1. Slide the throttle cable boot (1) off the adjuster (2).
2. Loosen the lock nut (3).
3. Turn the adjuster.
4. After adjustment, check for smooth rotation of the throttle grip from fully closed to fully open in all steering positions.
5. Tighten the lock nut and return the throttle cable boot securely over the adjuster.

# Throttle

---

## Throttle Inspection

Refer to *Safety Precautions* on page 92 .

1. Check that the throttle assembly is positioned properly and the securing bolts are tight.
2. Check for smooth rotation of the throttle from fully open to fully closed in all steering positions. If there is a problem, see your Honda dealer.

Your motorcycle's manually activated, wet, multiplate clutch is part of the primary drive system. Proper freeplay adjustment allows a smooth, gradual engagement when shifting gears.

Improper freeplay adjustment can cause premature clutch wear.

## Clutch Freeplay

Refer to *Safety Precautions* on page 92 .

### LEFT HANDLEBAR

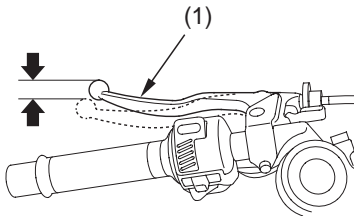

(1) clutch lever

# Clutch System

---

## Inspection

1. Check freeplay:  
3/8 – 13/16 in (10 – 20 mm)  
If necessary, adjust to the specified range.

## Upper Adjustment

Attempt adjustment with the upper clutch cable adjuster first.

## LEFT HANDLEBAR

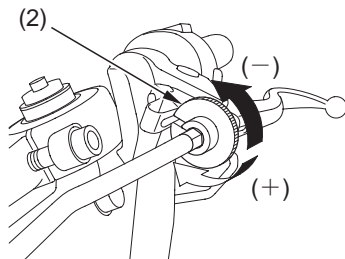

- (2) upper clutch cable adjuster  
(+) increase freeplay  
(-) decrease freeplay
2. Turn the upper clutch cable adjuster (2) to obtain the specified freeplay.
  3. Check the freeplay again.

# Clutch System

## Lower Adjustment

If the upper clutch cable adjuster is threaded out near its limit, or the correct freeplay cannot be obtained, attempt adjustment with the lower clutch cable adjuster.

1. Remove the lower cowl (page 111 ).
2. Remove the screw (3) on the right middle cowl (4) and pull it outwards.

RIGHT SIDE

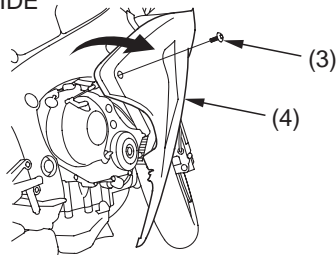

(3) screw

(4) middle cowl

3. Turn the upper clutch cable adjuster (2) all the way in (to provide maximum freeplay).
4. Loosen the lower lock nut (5).
5. Turn the lower adjusting nut (6) to obtain the specified freeplay.
6. Tighten the lower lock nut and check the adjustment.

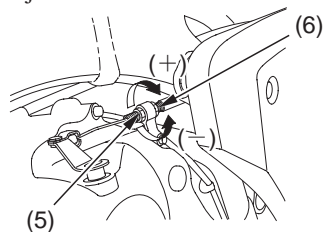

(5) lower lock nut

(6) lower adjusting nut

(+) increase freeplay

(-) decrease freeplay

(cont'd)

## Clutch System

---

7. Install the right middle cowl with screw.
8. Install the lower cowl (page 111).
9. Start the engine, pull the clutch lever in, and shift into gear. Make sure the engine does not stall and the motorcycle does not creep. Gradually release the clutch lever and open the throttle. Your motorcycle should move smoothly and accelerate gradually.

If you cannot get proper adjustment, or the clutch does not work properly, the cable or clutch friction discs may be worn. See your Honda dealer or refer to the official Honda Service Manual (page 246 ).

### Other Inspections & Lubrication

- Check that the clutch lever assembly is positioned properly and the securing bolts are tight.
- Check the clutch cable for kinks or signs of wear. If necessary, have it replaced.
- Lubricate the clutch cable with a commercially available cable lubricant to prevent premature wear and corrosion.

Your front and rear suspension systems use springs, hydraulic damping devices, and linkages (rear only) that suspend your weight and most of the weight of your motorcycle.

The spring pre-loads for your front and rear suspension systems adjust the amount of force required to begin compression of the spring.

The oil damper systems hydraulically control the natural compression and rebound of the suspension springs so that traction and comfort are maintained as the wheels ride over road surfaces.

Consider adjusting your suspension whenever you change your normal load, by adding or subtracting a passenger, cargo, or accessories, or when the road or riding conditions change.

The way you ride your motorcycle and the type of ride you want to experience can also influence your suspension needs.

You may adjust the spring pre-load and the rebound and compression damping of both suspension systems.



# Suspension

---

Lower spring pre-load and softer damping provide a softer ride and are usually preferred for light loads and smooth roads. Higher spring pre-load and firmer damping provide a firmer ride and are recommended for heavy loads, rough road conditions, and faster, more challenging riding.

## Front Suspension Adjustment

The front suspension can be adjusted for rider (and passenger) weight and riding conditions by changing the spring pre-load and rebound and compression damping.

To adjust, use an appropriate tool or see your Honda dealer.

## Front Suspension Spring Pre-load

Refer to *Safety Precautions* on page 92 .

FRONT

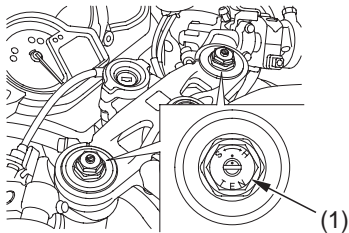

(1) pre-load adjuster

Adjust the spring pre-load by turning the pre-load adjuster ( 1 ).

To adjust to the standard position:

1. Turn the pre-load adjuster ( 1 ) counterclockwise until it will no longer turn (lightly seats). This is the full soft setting.
2. Turn the adjuster clockwise 6 turns. This is the standard position.
3. Make sure that both fork legs are adjusted to the same position.

*To Reduce Spring Pre-load (SOFT):*

For a light load and smooth road conditions, turn the adjuster counterclockwise toward SOFT.

*To Increase Spring Pre-load (HARD):*

For a firmer ride and rough road conditions, turn the adjuster clockwise toward HARD.

# Suspension

## Front Suspension Damping

Refer to *Safety Precautions* on page 92 .

### Rebound Damping

#### FRONT

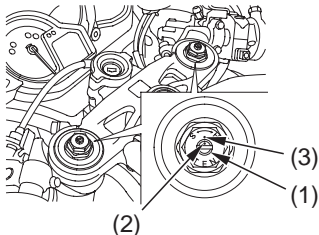

(1) damping adjuster    (3) reference punch  
(2) punch mark            mark

To adjust to the standard position:

1. Turn the damping adjuster (1) clockwise until it will no longer turn

(lightly seats). This is the full hard setting.

2. Turn the adjuster counterclockwise approximately 2 1/4 turns so that the punch mark (2) on the adjuster aligns with the reference punch mark (3). This is the standard position.
3. Make sure that both fork legs are adjusted to the same position.

#### *To Reduce Rebound Damping (SOFT):*

For a light load and smooth road conditions, turn the adjuster counterclockwise toward SOFT (S).

#### *To Increase Rebound Damping (HARD):*

For a firmer ride and rough road conditions, turn the adjuster clockwise toward HARD (H).

## Compression Damping

### RIGHT SIDE

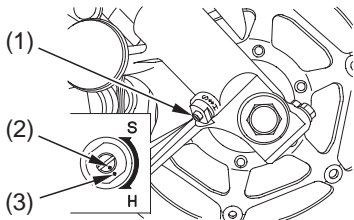

- (1) damping adjuster
- (2) punch mark
- (3) reference punch mark

To adjust to the standard position:

1. Turn the damping adjuster (1) clockwise until it will no longer turn (lightly seats). This is the full hard setting.

2. Turn the adjuster counterclockwise approximately 2 turns (CBR1000RR) or 2 1/4 turns (CBR1000RR ABS) so that the punch mark (2) on the adjuster aligns with the reference punch mark (3). This is the standard position.
3. Make sure that both fork legs are adjusted to the same position.

### *To Reduce Compression Damping (SOFT):*

For a light load and smooth road conditions, turn the adjuster counterclockwise toward SOFT (S).

### *To Increase Compression Damping (HARD):*

For a firmer ride and rough road conditions, turn the adjuster clockwise toward HARD (H).

# Suspension

---

## Rear Suspension Adjustment

The rear suspension can be adjusted for rider (and passenger) weight and riding conditions by changing the spring pre-load and rebound and compression damping.

To adjust, use an appropriate tool or see your Honda dealer.

The rear shock absorber includes a damper unit that contains high pressure nitrogen gas. Do not attempt to disassemble, service, or dispose of the damper; see your Honda dealer. The instructions found in this owner's manual are limited to adjustments of the shock assembly only.

## Rear Suspension Spring Pre-load

Refer to *Safety Precautions* on page 92 .

### LEFT SIDE

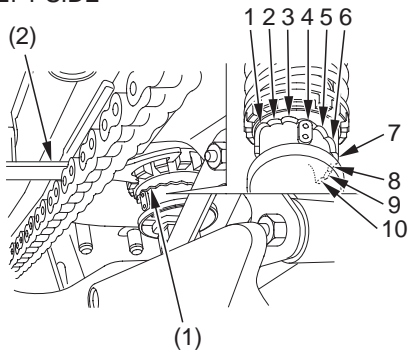

- (1) spring pre-load adjuster  
(2) pin spanner

The spring pre-load adjuster (1) has 10 positions for different load or riding conditions.

Use a pin spanner (2) to adjust the rear shock spring pre-load.

Positions 1 to 3: for a light load and smooth road conditions.

Position 4: standard position.

Positions 5 to 10: for when the motorcycle is more heavily loaded. (Also increase spring pre-load for stiffer rear suspension.)

Always adjust the shock absorber position in sequence (1-2-3-4-5-6-7-8-9-10 or 10-9-8-7-6-5-4-3-2-1). Attempting to adjust directly from 1 to 10 or 10 to 1 may damage the shock absorber.

# Suspension

## Rear Suspension Damping

Refer to *Safety Precautions* on page 92 .

### Rebound Damping

#### LEFT SIDE

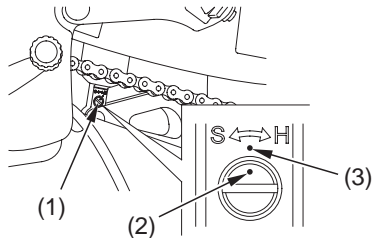

- (1) damping adjuster
- (2) punch mark
- (3) reference punch mark

To adjust to the standard position:

1. Turn the damping adjuster (1) clockwise until it will no longer turn (lightly seats). This is the full hard setting.
2. Turn the adjuster counterclockwise approximately 2 1/4 turns or 2 turns (CBR1000RR Canada model only) so that the punch mark (2) on the adjuster aligns with the reference mark (3). This is the standard position.

*To Reduce Rebound Damping (SOFT):*

For a light load and smooth road conditions, turn the adjuster counterclockwise toward SOFT (S).

*To Increase Rebound Damping (HARD):*

For a firmer ride and rough road conditions, turn the adjuster clockwise toward HARD (H).

## Compression Damping

### LEFT SIDE

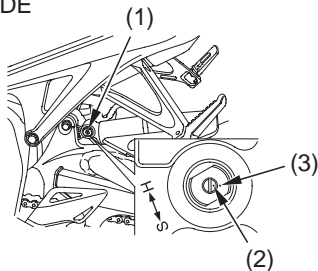

- (1) damping adjuster
- (2) punch mark
- (3) reference punch mark

To adjust to the standard position:

1. Turn the damping adjuster (1) clockwise until it will no longer turn (lightly seats). This is the full hard setting.

2. Turn the adjuster counterclockwise approximately 2 turns (CBR1000RR) or 2 1/2 turns ( CBR1000RR ABS ) so that the punch mark (2) on the adjuster aligns with the reference punch mark (3). This is the standard position.

### *To Reduce Compression Damping (SOFT):*

For a light load and smooth road conditions, turn the adjuster counterclockwise toward SOFT (S).

### *To Increase Compression Damping (HARD):*

For a firmer ride and rough road conditions, turn the adjuster clockwise toward HARD (H).



# Brakes

---

The hydraulic braking systems on your motorcycle dissipate the heat generated by the friction of the brake pads on the brake discs as the wheels are slowed.

As the brake pads wear, the brake fluid level will drop. A leak in the system will also cause the level to drop.

Frequently inspect the system to ensure there are no fluid leaks. Periodically inspect the brake fluid level and the brake pads for wear.

If the brake lever or brake pedal freeplay does not feel within the normal range while riding, check the brake pads for wear (page 148 ). Worn pads should be replaced. If the pads are not worn beyond the recommended limit, there is probably

air in the brake system. See your Honda dealer to have the air bled from the system.

## Front Brake Lever Adjustment

Refer to *Safety Precautions* on page 92 .

The distance between the tip of the brake lever and the grip may be adjusted.

## RIGHT HANDLEBAR

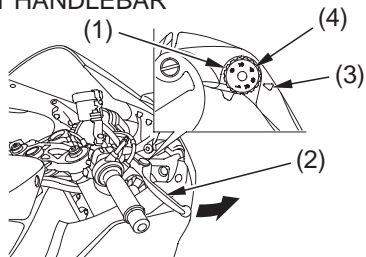

- (1) adjuster dial      (3) index mark  
(2) brake lever      (4) numbers

1. Turn the adjuster dial (1) while pushing the brake lever (2) forward.
2. Align the index mark (3) on the brake lever with the numbers (4) on the adjuster dial.
3. Apply the brake, release it, then spin the wheel and check that it rotates freely. Repeat this procedure several times.

## Brake Fluid Recommendation

brake fluid	Honda DOT 4 Brake Fluid
-------------	-------------------------

The recommended brake fluid is Honda DOT 4 Brake Fluid, or any brake fluid of equal quality and performance. Use fresh brake fluid from a sealed container. Be sure to read the label before opening the sealed container. An opened container may be contaminated or may have absorbed moisture from the air.

# Brakes

## Fluid Level Inspection

Refer to *Safety Precautions* on page 92 .

If your inspection indicates a low fluid level, have your Honda dealer add the recommended brake fluid.

Do not add or replace brake fluid, except in an emergency. If you do add fluid, have your Honda dealer check the system as soon as possible.

### NOTICE

*Brake fluid can damage plastic and painted surfaces. Handle with care.*

Wipe up spills immediately. Avoid brake fluid contact with skin or eyes. If it comes in contact with your eyes, wash them out with clean water and immediately call a doctor. If it comes in contact with your skin, wash with clean water and, if necessary, call a doctor.

### RIGHT FRONT

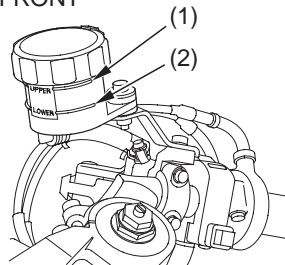

- (1) UPPER level mark
- (2) LOWER level mark

## RIGHT SIDE

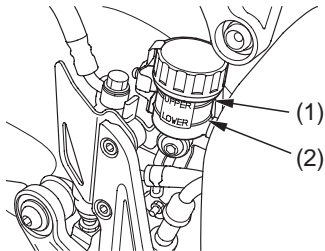

- (1) UPPER level mark
- (2) LOWER level mark

1. Place your motorcycle in an upright position on a firm, level surface.
2. Check the fluid level. It should be between the UPPER ( 1 ) and LOWER ( 2 ) level marks. If the level is at or below the LOWER level mark, check the brake pads for wear (page 149 ).

Worn pads should be replaced. If the pads are not worn beyond the recommended limit, have your brake system inspected for leaks.

### Other Inspections

- Make sure there are no fluid leaks.
- Check for deterioration or cracks in the hoses and fittings.

# Brakes

---

## Brake Pad Wear

Refer to *Safety Precautions* on page 92 .

Brake pad wear depends upon the severity of usage, the type of riding, and road conditions. Generally, the pads will wear faster on wet and dirty roads. Inspect the pads at each regular maintenance interval (page100).

Always inspect both pads in both the right and left front brake calipers.

### Front Brake

LEFT FRONT (Right side similar)

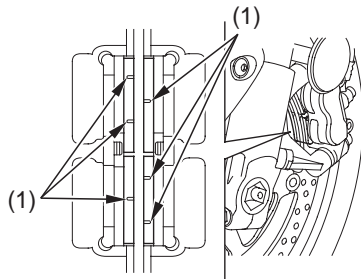

(1) wear indicator grooves

Check the wear indicator grooves ( 1 ) in each pad. If either pad is worn to the bottom of the grooves, replace both pads as a set. See your Honda dealer for this service.

## Rear Brake

RIGHT REAR

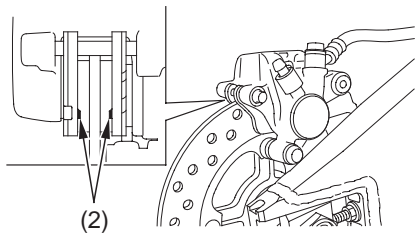

(2) cutouts

Check the cutouts (2) in each pad. If either pad is worn to the cutout, replace both pads as a set. See your Honda dealer for this service.

# Tires

---

To safely operate your motorcycle, your tires must be the proper type and size, in good condition with adequate tread, and correctly inflated for the load you are carrying.

## **⚠ WARNING**

Using tires that are excessively worn or improperly inflated can cause a crash in which you can be seriously hurt or killed.

Follow all instructions in this owner's manual regarding tire inflation and maintenance.

The following pages give detailed information on how and when to check

your air pressure, how to inspect your tires for wear and damage, and our recommendations for tire repair and replacement.

## **Air Pressure**

Refer to *Safety Precautions* on page 92 .

Properly inflated tires provide the best combination of handling, tread life, and riding comfort. Generally, underinflated tires wear unevenly, adversely affect handling, and are more likely to fail from being overheated. Overinflated tires make your motorcycle ride harshly, are more prone to damage from road hazards, and wear unevenly.

We recommend that you visually check your tires before every ride and use an air pressure gauge to measure the air pressure at least once a month or any time you think the tires might be low. Even tires that are in good condition may lose one to two psi per month if not checked and adjusted regularly.

Tubeless tires have some degree of self-sealing ability if they are punctured. However, because leakage is often very slow, you should look closely for punctures whenever a tire is not fully inflated.

Always check air pressure when your tires are “cold”, after the motorcycle has been parked for at least three hours. If you check air pressure when your tires are

“warm” — even if your motorcycle has only been ridden for a few miles — the readings will be higher. If you let air out of warm tires to match the recommended cold pressures, the tires will be underinflated.

The recommended “cold” tire pressures are:

front	36 psi (250 kPa , 2.50 kgf/cm <sup>2</sup> )
rear	42 psi (290 kPa , 2.90 kgf/cm <sup>2</sup> )



# Tires

## Inspection

Refer to *Safety Precautions* on page 92 .

Whenever you check the tire pressures, you should also look for:

- Bumps or bulges in the side of the tire or the tread. Replace any tire that has a bump or bulge.
- Cuts, slits, or cracks in the tires. Replace the tire if you can see fabric or cord.
- Nails or other foreign objects embedded in the side of the tire or tread.
- Excessive tread wear.

Also, if you hit a pothole or hard object while riding, pull to the side of the road as soon as you safely can and carefully inspect the tires for damage.

## Tread Wear

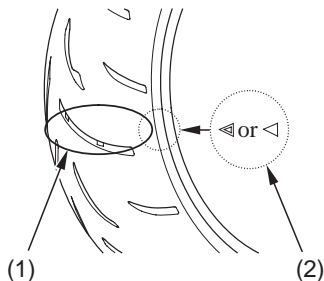

- (1) wear indicator  
(2) wear indicator location mark

For the best performance, you should replace a tire before the tread depth at the center reaches the following limits:

front	0.06 in (1.5 mm)
rear	0.08 in (2.0 mm)

If the wear indicators are visible, replace the tire immediately as it is no longer safe.

## Tire Service Life

The service life of your tires is dependent on many factors, including, but not limited to, riding habits, road conditions, vehicle loading, tire pressure, maintenance history, speed, and environmental conditions (even when the tires are not in use).

In addition to your regular inspections and tire pressure maintenance, it is recommended that you have annual

inspections performed once the tires reach 5 years old. It is also recommended that all tires be removed from service after 10 years from the date of manufacture, regardless of their condition or state of wear.

The last four digits of the TIN (tire identification number) (1) are found on the sidewall of the tire, and indicate the date of manufacture.

### Tire Identification Number (TIN)

The tire identification number (TIN) is a group of numbers and letters that look like the following example. TIN is located on the sidewall of the tire.

DOT  $\frac{\times \times \times \times}{(2)}$   $\frac{\times \times \times \times}{(3)}$   $\frac{22\ 07}{(4)}$

(cont'd)

# Tires

DOT — This indicates that the tire meets all requirements of the U.S. Department of Transportation.

(2) × × × × — Factory code

(3) × × × × — Tire type code

(4) 22 07 — Date of manufacture

└──┬──  
    └── Year  
    └── Week

## TIRE LABELING EXAMPLE

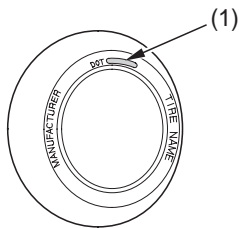

(1) tire identification number (TIN)

## Tire Repair

Refer to *Safety Precautions* on page 92 .

We strongly recommend that you replace, not repair, any tire that is punctured or damaged. As discussed below, a tire that is repaired, either temporarily or permanently, will have lower speed and performance limits than a new or undamaged tire.

A temporary repair can sometimes be made in an emergency situation. However, since a temporary repair may not hold, you must ride very slowly, preferably without any cargo or passenger, and have the tire replaced or permanently repaired as soon as possible. (For more information on temporary repairs, see *If You Have a Flat Tire*, page 196 .)

A permanent repair, such as an internal plug patch, can be made if a tire has only a small puncture in the tread area. With such a repair, you should not exceed 50 mph (80 km/h) for the first 24 hours, or 80 mph (130 km/h) at any time thereafter. In addition, you may not be able to safely carry as much weight. If you choose to have a tire repaired, be sure the repair work is performed by a professional and that the wheel is balanced before you ride.

# Tires

---

If you have a tire professionally repaired at a non-Honda facility, we recommend that you have the work checked by your Honda dealer.

## Tire Replacement

Refer to *Safety Precautions* on page 92 .

The tires that came on your motorcycle were designed to match the performance capabilities of your motorcycle and provide the best combination of handling, braking, durability, and comfort.

When replacing, use the original equipment tires or equivalent tires of the same size, construction, speed rating, and load range as the originals.

## **⚠ WARNING**

Installing improper tires on your motorcycle can affect handling and stability. This can cause a crash in which you can be seriously hurt or killed.

Always use the size and type of tires recommended in this owner's manual.

The recommended tires for your motorcycle are:

front	120/70ZR17M/C (58W) BRIDGESTONE BT015F RADIAL F DUNLOP Qualifier PTK
rear	190/50ZR17M/C (73W) BRIDGESTONE BT015R RADIAL F DUNLOP Qualifier NK
type	radial-ply, tubeless

# Tires

---

Whenever you replace a tire, remember:

- Have the wheel balanced after the tire is installed.
- Have the tire replaced by your Honda dealer if possible.

If you have a tire professionally replaced at a non-Honda facility, we recommend that you have the work checked by your Honda dealer.

## Important Safety Reminders

- Do not install a tube inside a tubeless tire on this motorcycle. Excessive heat build-up can cause the tube to burst.
- Use only tubeless tires on this motorcycle. The rims are designed for tubeless tires, and during hard acceleration or braking, a tube-type tire could slip on the rim and cause the tire to rapidly deflate.

Refer to *Safety Precautions* on page 92 .

### LEFT SIDE

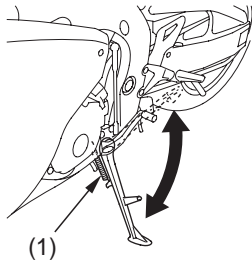

(1) side stand spring

- Check that the side stand assembly is working properly. If the side stand is stiff or squeaky, clean the pivot area and lubricate the pivot bolt with clean grease.

- Check the side stand spring ( 1 ) for damage or loss of tension.
- Check the side stand ignition cut-off system:
  1. Sit on the motorcycle and put the transmission in neutral.
  2. Raise the side stand.
  3. Start the engine.
  4. Pull the clutch lever in.
  5. Shift the transmission into gear.
  6. Lower the side stand all the way.The engine should stop as you lower the side stand. If the engine doesn't stop, see your Honda dealer for service.



## Drive Chain

---

An endless (riveted master link) chain connects the countershaft and rear wheel sprockets. The O-ring chain uses rubber rings between the side plates of the pin and roller links to seal in the manufacturer-installed lubricating grease and keep out moisture and dirt.

The service life of the chain depends on proper lubrication and adjustment. Poor maintenance can cause premature wear or damage to the drive chain or sprockets.

The drive chain should be checked, adjusted, and lubricated as part of the pre-ride inspection (page 59 ).

Under severe usage, or when the motorcycle is ridden in unusually dusty or muddy areas, more frequent maintenance will be necessary.

Before servicing your drive chain, turn the engine OFF, lower the side stand, and check that your transmission is in neutral.

It is not necessary to remove or replace the drive chain to perform the recommended service in the Maintenance Schedule.

## Inspection

Refer to *Safety Precautions* on page 92 .

1. Check slack in the lower drive chain (1) run midway between the sprockets. Drive chain slack should allow the following vertical movement by hand:  
1—1 3/8 in (25—35 mm)
2. Check drive chain slack at several points along the chain. The slack should remain constant. If it isn't, some links may be kinked and binding. Lubricating the chain will often eliminate binding and kinking.

LEFT SIDE

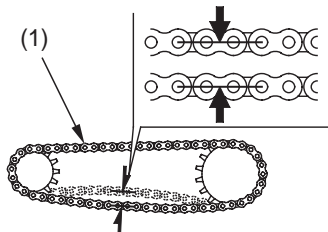

(1) drive chain

3. Inspect the drive chain for:
  - damaged rollers
  - dry or rusted links
  - kinked or binding links
  - excessive wear
  - improper adjustment
  - damaged or missing O-rings

(cont'd)

## Drive Chain

---

Replace the drive chain (page 167 ) if it has damaged rollers, loose pins, or kinks that cannot be freed. Lubricate the drive chain (page 166 ) if it appears dry or shows signs of rust. Lubricate any kinked or binding links and work them free. Adjust chain slack if needed.

4. Inspect the front and rear wheel sprocket teeth for excessive wear or damage. If necessary, have your Honda dealer replace a worn sprocket.

damaged  
sprocket  
teeth

worn  
sprocket  
teeth

REPLACE

REPLACE

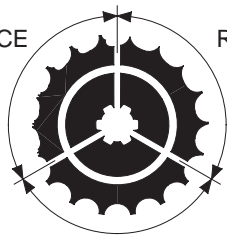

normal sprocket teeth  
GOOD

### NOTICE

*Use of a new chain with worn sprockets will cause rapid chain wear.*

## Wear Inspection

### LEFT SIDE

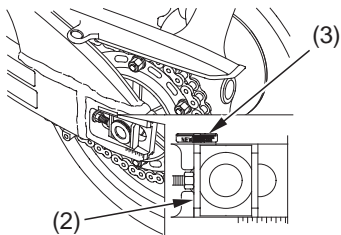

(2) adjustment plate      (3) red zone

Check the chain wear label when adjusting the chain. If the front edge of the chain adjustment plate (2) enters the red zone (3) on the label after the chain has been adjusted to the proper slack, the chain is excessively worn and must be replaced.

The proper slack is:

1 – 1 3/8 in (25 – 35 mm)

The bottom part of the frame may be damaged by excessive drive chain slack of more than:

1 15/16 in (50 mm)

## Adjustment

Refer to *Safety Precautions* on page 92.

Drive chain slack should be checked and adjusted, if necessary, every 500 miles (800 km). When operated at sustained high speeds or under conditions of frequent rapid acceleration, the chain may require more frequent adjustments.

# Drive Chain

## RIGHT SIDE

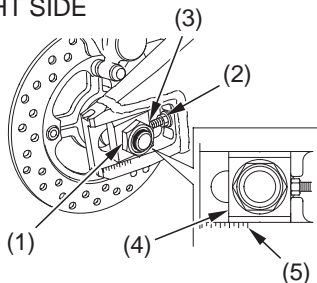

- |                                |                            |
|--------------------------------|----------------------------|
| (1) rear axle nut              | (4) chain adjustment plate |
| (2) lock nut                   | (5) scale                  |
| (3) drive chain adjusting bolt |                            |

1. Place the motorcycle on its side stand with the transmission in neutral and the ignition switch OFF.
2. Loosen the rear axle nut (1).

3. Loosen the lock nuts (2) on both sides of the swingarm.
4. Turn both drive chain adjusting bolts (3) an equal number of turns until the correct drive chain slack is obtained. Turn the drive chain adjusting bolts counterclockwise to tighten the chain. Turn the drive chain adjusting bolts clockwise and push the rear wheel toward the front to provide more slack. Adjust the chain slack at a point midway between the front sprocket and the rear wheel sprocket. Roll the motorcycle forward. Stop and place it on its side stand. Recheck chain slack. Chain slack should allow the following vertical movement by hand:  
1 – 1 3/8 in (25 – 35 mm)

5. Check rear axle alignment by making sure the end of the chain adjustment plate (4) aligns with the scale graduations (5) on both sides of the swingarm.

Both marks should correspond. If the axle is misaligned, turn the right or left adjusting bolt until the marks are aligned and recheck chain slack.

6. Torque the rear axle nut to:  
**83 lbf·ft (113 N·m , 11.5 kgf·m)**  
If a torque wrench is not used for this installation, see your Honda dealer as soon as possible to verify proper assembly. Improper assembly may lead to a loss of braking capacity.

7. Tighten the drive chain adjusting bolts lightly by turning it counterclockwise, then tighten the lock nuts by holding the drive chain adjusting bolts with a wrench.
8. Recheck drive chain slack (page 161 ).

# Drive Chain

---

## Lubrication

Refer to *Safety Precautions* on page 92 .

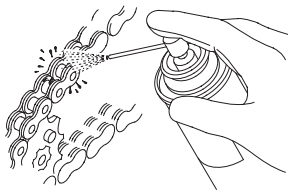

Lubricate every 500 miles (800 km) or sooner if chain appears dry. Lubricant: Pro Honda HP Chain Lube or an equivalent chain lubricant designed specifically for use on O-ring chains

Commercial chain lubricants not designed for motorcycle drive chains may contain solvents which could damage the O-rings.

### Removal, Cleaning & Replacement

Refer to *Safety Precautions* on page 92 .

Your motorcycle has an endless (riveted master link) type chain. It should only be removed or replaced by your Honda dealer.

The O-rings can be damaged by steam cleaning, high pressure washers, and certain solvents.

1. Clean the side surfaces of the chain with a dry cloth. Use a high flashpoint solvent such as kerosene — not gasoline.

Do not brush the rubber O-rings.

Brushing will damage them. Use of a solvent may also damage the O-rings.

2. Inspect the drive chain for possible wear or damage.

Replace the drive chain if it has damaged rollers, loose fitting links, damaged O-rings, or otherwise appears unserviceable.

Replacement Chain:

DID 50VA11

or

RK 50HFOZ6



# Battery

---

Your motorcycle has a maintenance-free type battery. You do not have to check the battery electrolyte level or add distilled water as you would with a conventional-type battery.

## NOTICE

*Your battery is a maintenance-free type and can be permanently damaged if the cap strip is removed.*

Electrical accessories use current from the battery, even when the ignition is OFF. Limited operation also allows the battery to discharge. If you have electrical accessories on your motorcycle or do not ride frequently, we recommend that you charge the battery frequently (see *Battery Charging*, page 173 ).

If you do not expect to ride your motorcycle for at least two weeks, we recommend you remove the battery, or at least disconnect the battery cables (negative cable first).

If you plan to store your motorcycle, see *Battery Storage*, page 169 .

If your battery seems weak and/or is leaking electrolyte (causing slow starting or other electrical problems), see your Honda dealer.

**WARNING:** Battery posts, terminals and related accessories contain lead and lead compounds. **Wash your hands after handling.**

## Battery Storage

Refer to *Safety Precautions* on page 92 .

If you plan to store your motorcycle, we recommend you remove the battery and store it where it can be charged at least every 30 days to maintain its service life.

If you do not remove the battery, we recommend disconnecting the battery cables (negative cable first).

You will get the best storage results from removing the battery and slow (trickle) charging it every 30 days (see *Battery Charging*, page 173).

Before you remove the battery, be sure to read all the information that follows, as well as the information on the battery label.

### **WARNING**

The battery gives off explosive hydrogen gas during normal operation.

A spark or flame can cause the battery to explode with enough force to kill or seriously hurt you.

Wear protective clothing and a face shield, or have a skilled mechanic do the battery maintenance.

# Battery

---

The battery is located in the battery box below the front seat.

## Removal

1. Make sure the ignition switch is OFF.
2. Remove the front seat (page 109).
3. Release the rings (1) and remove the rubber band (2).
4. Disconnect the negative (−) terminal lead (3) from the battery first, then disconnect the positive (+) terminal lead (4).
5. Pull the battery (5) out of the battery box.

## UNDER FRONT SEAT (CBR1000RR)

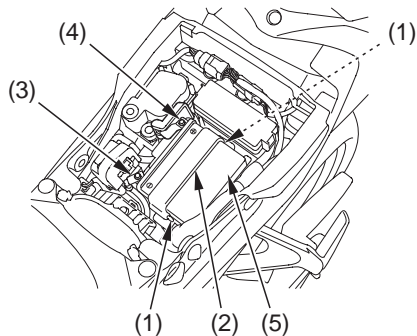

- (1) rings
- (2) rubber band
- (3) negative (−) terminal lead
- (4) positive (+) terminal lead
- (5) battery

(CBR1000RR ABS)

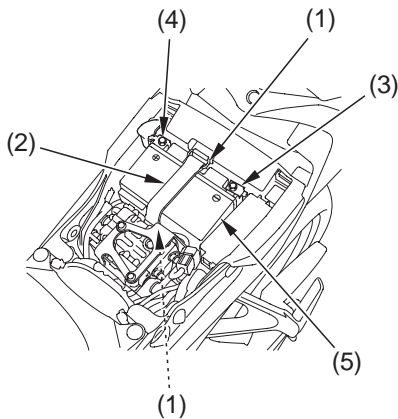

6. Charge the battery (see following section), unless you have been riding regularly.
7. Store your battery in an easy-to-reach location off the floor, in an area protected from freezing temperatures and direct sunlight.
8. Clean the battery box after removing the battery for storage. Dry the battery box and, if paint is missing, re-paint the area.
9. Slow charge the battery (see following section) once every 30 days.

# Battery

---

## Installation

1. Reinstall in the reverse order of removal.  
Be sure to connect the positive (+) terminal first, then the negative (-) terminal.
2. Check all bolts and other fasteners are secure.

## Battery Charging

Refer to *Safety Precautions* on page 92 .

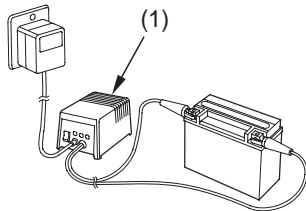

(1) “trickle” charger

Be sure to read the information that came with your battery charger and follow the instructions on the battery. Improper charging may damage the battery.

We recommend using a “trickle” charger (1) for home charging. These units can be left connected for long periods without risking damage to the battery. However, do not intentionally leave the charger connected longer than the time period recommended in the charger’s instructions.

Avoid using an automotive-type battery charger. An automotive charger can overheat a motorcycle battery and cause permanent damage.

## Appearance Care

---

Frequent cleaning and polishing will keep your Honda looking newer longer. Frequent cleaning also identifies you as an owner who values your motorcycle. A clean motorcycle is also easier to inspect and service.

### General Recommendations

Refer to *Safety Precautions* on page 92 .

- To clean your motorcycle, you may use:
  - water
  - a mild, neutral detergent and water
  - a mild spray and wipe cleaner/polisher
  - a mild spray and rinse cleaner/degreaser and water

- Avoid products that contain harsh detergents or chemical solvents that could damage the metal, paint, and plastic on your motorcycle.
- If your motorcycle is still warm from recent operation, give the engine and exhaust system time to cool off.
- Park in a shady area. Washing your motorcycle in bright sunlight may cause the finish to fade because water droplets intensify the sun's brightness. Spotting is also more likely because surface water can dry before you have time to wipe it off.
- Clean your motorcycle regularly to protect surface finishes.

- We recommend the use of a garden hose to wash your motorcycle. High pressure washers (like those at coin-operated car washes) can damage certain parts of your motorcycle.
- Do not direct water at the air intakes (1). The water could enter the air cleaner or be drawn into the throttle body.

### NOTICE

*High pressure water (or air) can damage certain parts of your motorcycle.*

FRONT

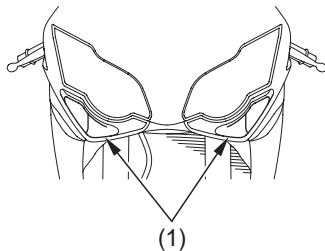

(1) air intakes

- After cleaning, inspect for damage, wear, and leaks (fuel, oil, coolant, brake, and clutch fluid).



## Appearance Care

---

### Washing Your Motorcycle with a Mild Detergent

Refer to *Safety Precautions* on page 92 .

1. Rinse your motorcycle thoroughly with cool water to remove loose dirt.
2. Fill a bucket with cool water. Mix in a mild, neutral detergent, such as dish washing liquid or a product made especially for washing motorcycles or automobiles.
3. Wash your motorcycle with a sponge or a soft towel. As you wash, check for heavy grime. If necessary, use a mild cleaner/degreaser to remove the grime.
4. Clean the windscreen with a soft cloth or sponge and plenty of water. Dry with a soft clean cloth. Remove minor scratches with a commercially available plastic polishing compound. Take care to keep brake fluid or chemical solvents off the fairing. They will damage the plastic.
5. Clean the headlight, fairing, meter lens and other plastic parts using a cloth or sponge dampened with a solution of mild detergent and water. When cleaning the plastic headlight lens, use more care because it will scratch easier than a glass lens. Rub any soiled area, gently rinsing it frequently with fresh water.

6. After washing, rinse your motorcycle thoroughly with plenty of clean water to remove any residue. Detergent residue can corrode alloy parts.
7. Dry your motorcycle with a chamois or a soft towel. Leaving water on the surface to air dry can cause dulling and water spots. As you dry, inspect for chips and scratches.
8. Lubricate the drive chain to prevent rusting.
9. Start the engine and let it idle for several minutes. The engine heat will help dry moist areas.
10. As a precaution, ride your motorcycle at a slow speed and apply the brakes several times. This will help dry the brakes and restore normal braking performance.

### Spray Cleaning Your Motorcycle

Refer to *Safety Precautions* on page 92 .

Avoid using spray cleaner products on the tires or suspension components.

Suggestions for using spray cleaner(s) follow:

## Appearance Care

---

<b>Motorcycle Condition</b>	<b>Recommended Cleaning</b>
Dust and fingerprint smudges.	Apply a spray cleaner/polish and wipe the paint, chrome, glass, and clear plastic.
Light road grime.	Spray any difficult-to-reach or very dirty areas with a spray cleaner/degreaser. Rinse and dry. Apply a spray cleaner/polish and wipe with a non-abrasive cloth.
Heavy grime. Oil leaks. Brake dust.	Use a spray cleaner/degreaser. If necessary, rub with a sponge. Rinse and dry. Apply a spray cleaner/polish and wipe with a non-abrasive cloth.
Dull, corroded chrome or aluminum.	Apply a high quality chrome/aluminum polish and wipe with a non-abrasive cloth.

### Painted Aluminum Wheel Maintenance

Refer to *Safety Precautions* on page 92 .

Aluminum may corrode from contact with dirt, mud, or road salt. Clean the wheels after riding through any of these substances. Use a wet sponge and mild detergent. Avoid stiff brushes, steel wool, or cleaners containing abrasives or chemical compounds.

After washing, rinse with plenty of water and dry with a clean cloth.

If the paint is chipped, apply touch-up paint.

### Clean the Matte Painted Surface

Refer to *Safety Precautions* on page 92 .

Use a soft cloth or sponge, plenty of water, and a mild detergent to clean the matte paint. Dry with a soft, clean cloth.

Do not use polishing compounds or wax containing polishing compounds. These can damage or discolor the paint.

To keep your Honda looking new, clean and polish it frequently.

## Appearance Care

---

### Exhaust Pipe and Muffler Maintenance

Refer to *Safety Precautions* on page 92 .

The exhaust pipe and muffler are stainless steel but may become stained by mud or dust.

To remove mud or dust, use a wet sponge and a liquid kitchen abrasive, then rinse well with clean water. Dry with chamois or a soft towel.

If necessary, remove heat stains by using a commercially available fine texture compound. Then rinse by the same manner as removing mud or dust.

### Finishing Touches

Refer to *Safety Precautions* on page 92 .

After washing your motorcycle, consider using a commercially available spray cleaner/polish or quality liquid or paste wax to finish the job. Use only a non-abrasive polish or wax made specifically for motorcycles or automobiles. Apply the polish or wax according to the instructions on the container.

If a surface on your motorcycle is chipped or scratched, your Honda dealer has touch-up paint to match your motorcycle's color. Be sure to use your motorcycle's color code (page 226 ) when you buy touch-up paint.

If the frame has a chip that exposes the metal, first apply primer (to prevent corrosion) and then apply the touch-up paint. Several thin layers of touch-up paint are better than one thick coat.



Here's a few helpful tips on how to store and transport your Honda, and how to be an environmentally responsible motorcycle owner.

Storing Your Honda .....	184
Transporting Your Motorcycle .....	187
You & the Environment .....	188



## Storing Your Honda

---

If you won't be riding for an extended period, such as during the winter, thoroughly inspect your motorcycle and correct any problem before storing it. That way, needed repairs won't be forgotten and it will be easier to get your motorcycle running again.

For more information about storage, refer to the *Honda Motorcycle Winter Storage Guide*, available from your Honda dealer (USA only).

We suggest you perform the following procedures to keep your motorcycle in top condition. These storage procedures will reduce the deterioration that can occur during storage.

### Preparation for Storage

Refer to *Safety Precautions* on page 92 .

1. Change the engine oil and filter (page 120 ).
2. Make sure the cooling system is filled with a 50/50% antifreeze solution (page 125 ).
3. Fill the fuel tank. Make sure the fuel fill cap is properly installed.

## Storing Your Honda

---

4. To prevent rusting in the cylinders, contact your Honda dealer.
5. Remove the battery and charge it fully. Store it in an area protected from freezing temperatures and direct sunlight. Slow charge the battery (page 173 ) once a month.
6. Wash and dry your motorcycle. Wax all painted surfaces (except matte painted surfaces). Apply rust-inhibiting oil to the chrome pieces.
7. Lubricate the drive chain (page 166 ).
8. Inflate the tires to their recommended pressures (page 150 ).
9. Store your motorcycle in an unheated area, free of dampness, away from sunlight, with a minimum of daily temperature variation.
10. Place your motorcycle on blocks to lift both tires off the floor.
11. Cover your motorcycle with a porous material. Avoid using plastic or similar non-breathing, coated materials that restrict air flow and allow heat and moisture to accumulate.

# Storing Your Honda

---

## Removal from Storage

Refer to *Safety Precautions* on page 92 .

1. Uncover and clean your motorcycle.
2. If your motorcycle has been stored for more than four months — change the engine oil (page 120 ).
3. If your motorcycle has been stored for more than two months — ask your Honda dealer to drain and replace the fuel.
4. Charge the battery (page 172 ) as required. Install the battery.
5. Lubricate the drive chain (page 166 ).
6. Perform a pre-ride inspection (page 59 ), then test-ride your motorcycle at low speeds.

## Transporting Your Motorcycle

---

If your motorcycle needs to be transported, it should be carried on a motorcycle trailer, or a truck or trailer with a flatbed area. Do not tow your motorcycle, as towing can seriously damage the transmission.

When contacting a towing or transporting service, be sure to ask if they have a flatbed area, a loading ramp or power ramp to safely lift the motorcycle, and motorcycle tie-down straps.

## You & the Environment

---

Owning and riding a motorcycle can be enjoyable, but you must do your part to protect nature.

Following are tips on how you can be an environmentally responsible motorcycle owner.

- **Choose Sensible Cleaners.** Use a biodegradable detergent when you wash your motorcycle. Avoid aerosol spray cleaners that contain chlorofluorocarbons (CFCs) which damage the atmosphere's protective ozone layer. Don't throw cleaning solvents away; see the following guidelines for proper disposal.

- **Recycle Wastes.** It's illegal and thoughtless to put used engine oil in the trash, down a drain, or on the ground. Used oil, gasoline, coolant, and cleaning solvents contain poisons that can hurt refuse workers and contaminate our drinking water, lakes, rivers, and oceans. Before changing your oil, make sure you have the proper containers. Put oil and other toxic wastes in separate sealed containers and take them to a recycling center. Call your local or state office of public works or environmental services to find a recycling center in your area, and to get instructions on how to dispose of non-recyclable wastes.

## Taking Care of the Unexpected

---

This section discusses the more common problems that can occur with your motorcycle while you're riding. It tells you how to evaluate each problem and what actions you can take to try to resume riding. If the problem cannot be safely solved, this section also gives instructions on the proper way to have your motorcycle transported.

For information about transporting your motorcycle, see page 187 .

General Guidelines.....	190
If Your Engine Quits or Won't Start ..	191
If You Have a Flat Tire.....	196
If Your Engine Overheats.....	210
If the Low Oil Pressure Indicator Lights.....	212
If a Fuse Blows.....	213
If You Crash.....	220
If You Lose Your Key.....	221
If Your Battery Is Low (or Dead).....	222

# Taking Care of the Unexpected

---

## General Guidelines

Keeping your motorcycle well-maintained is the best way to reduce the possibility of having a problem on the road.

Remember to take along your owner's manual, the tool kit that came with your motorcycle, and any other items (such as tire repair supplies and additional tools) that might help you solve a problem on your own.

Should you ever have a problem while riding, please follow these guidelines:

- Always put personal safety first.
- Take time to assess the situation and your options before deciding what to do.
- If the problem is relatively minor and you have the tools, supplies, and skills to make a temporary repair, be sure to have permanent repairs made as soon as possible.
- Do not continue riding if you are hurt or your motorcycle is not in safe riding condition.

Additional recommendations for specific problems follow.

## If Your Engine Quits or Won't Start

---

Proper operation and maintenance can prevent starting and engine performance problems. In many cases, the cause of the problem may be a simple operational oversight.

If you have a problem starting the engine — or experience poor engine performance — the following information may help you. If you can't correct the problem, see your Honda dealer.

If your motorcycle won't start, listen as you press the start button. If you don't hear the starter motor turning, refer to the *Starter motor doesn't operate* symptom. If you can hear the starter motor working normally, refer to the *Starter motor works, but the engine won't start* symptom.



## If Your Engine Quits or Won't Start

---

SYMPTOM: <b>Starter motor doesn't operate.</b>	
POSSIBLE CAUSE	WHAT TO DO
ignition switch OFF	Turn the ignition switch ON.
transmission not in neutral	Shift into neutral.
side stand down (when transmission not in neutral)	Put the transmission in neutral or raise the side stand and pull the clutch lever in.
blown fuse	Replace with a new fuse of the same rating (page 213).
battery lead loose	Tighten the battery lead.
low (or dead) battery	Charge the battery (page 172). If charging doesn't help, see your Honda dealer.
faulty starter motor	If all possible causes are negative, the starter motor may be faulty. See your Honda dealer.

## If Your Engine Quits or Won't Start

SYMPTOM: <b>Starter motor works, but the engine won't start.</b>	
POSSIBLE CAUSE	WHAT TO DO
engine stop switch OFF	Turn the engine stop switch to RUN.
out of fuel	Fill the fuel tank.
flooded engine	See <i>Flooded Engine</i> (page 70 ).
loose or unconnected ignition coil connectors and ignition coils	See your Honda dealer.
loose battery cables	Tighten the battery terminal bolts.
weak battery	Charge the battery (page 172 ). If charging doesn't help, see your Honda dealer.

## If Your Engine Quits or Won't Start

---

SYMPTOM: <b>Engine starts, but stalls as you shift into gear.</b>	
POSSIBLE CAUSE	WHAT TO DO
side stand down	Raise the side stand. Start again.

SYMPTOM: <b>Engine starts, but runs poorly.</b>	
POSSIBLE CAUSE	WHAT TO DO
idles roughly, too fast, stalls	See your Honda dealer.
overheating	Check the coolant temperature meter. Refer to <i>If Your Engine Overheats</i> , page 210.
low oil pressure	Check the low oil pressure indicator. Refer to <i>If the Low Oil Pressure Indicator Lights</i> , page 212.
runs erratically, misfires	May damage catalytic converter. See your Honda dealer.
blubbers (rich fuel mixture)	See your Honda dealer.

## If Your Engine Quits or Won't Start

SYMPTOM: <b>Engine starts, but runs poorly (cont'd).</b>	
POSSIBLE CAUSE	WHAT TO DO
sooty exhaust (rich fuel mixture)	See your Honda dealer.
detonates or pings under load	If applicable, switch to the recommended octane gasoline (page 112 ) or change your brand of gasoline. If the problem persists, see your Honda dealer.
afterfires (backfires)	May damage catalytic converter. See your Honda dealer.
pre-ignition (runs on after ignition switched OFF)	May damage catalytic converter. See your Honda dealer.

## If You Have a Flat Tire

---

A flat tire is always unwelcome, especially if you are far from help. If you think you are losing air, or you hit a pothole or hard object, pull safely to the side of the road so you can inspect the tires and assess the situation. (Be sure to park on a firm, level surface and use the side stand for support.) You should examine the tire treads and sidewalls for foreign objects or damage. If you find a tire that has been punctured or damaged, you have two options.

### Option 1:

#### Have Your Motorcycle Transported

If a tire has a major puncture or a cut in the tread or sidewall, or the bead has come loose from the rim, there is probably not much you can do except have your motorcycle transported to a Honda dealer

or other qualified service facility. Even with a simple puncture, this may be the safest and least troublesome solution. For transporting instructions, see page 187 .

### Option 2:

#### Make a Temporary Roadside Repair

If a tire has only a minor nail puncture and is not completely flat, you may be able to make an emergency repair that could allow you to continue riding to where you can get the tire replaced or permanently repaired.

## If You Have a Flat Tire

### **WARNING**

Riding your motorcycle with a temporary tire repair can be risky. If the temporary repair fails, you can crash and be seriously injured or killed.

If you must ride with a temporary tire repair, ride slowly and carefully and do not exceed 30 mph (50 km/h) until the tire is permanently repaired or replaced.

Due to the uncertainty of any temporary repair, you should ride slowly (not over 30 mph, 50 km/h) and carefully (preferably without a passenger or cargo) until the tire is replaced or permanently

repaired. Stop frequently and check the air pressure. If the tire is losing pressure, it may be unsafe to continue riding. As the tire gets low, it will affect the handling of your motorcycle (especially with a passenger and cargo), and it may overheat and blow out.

### **Types of Temporary Repairs**

The following types of temporary repairs generally require a source of air to inflate the tire. Possible sources include CO<sub>2</sub> cartridges or cans of compressed air designed to inflate a tire.

## If You Have a Flat Tire

---

- **Inflate the tire:** Tubeless tires have some self-sealing ability if they are punctured and the result is usually just a slow leak. If this is the case, you can try inflating the tire to see if it will hold air pressure. If you can see a nail or other object embedded in the tire tread, do not remove it at this time.
- **Plug the hole:** The idea here is to do something to temporarily stop the leak. If you have a tubeless tire repair kit, you can pull out the nail and try inserting an external plug in the puncture. Follow the instructions that came with the repair kit and be sure to inflate the tire to the correct pressure.

### Should You Repair or Replace a Tire?

We strongly recommend that you replace, not permanently repair, any tire that is punctured or damaged, even if the tire has only a minor puncture. For a full discussion of repairs and replacement, see page 154.

## If You Have a Flat Tire

### Emergency Front Wheel Removal/Installation

Refer to *Safety Precautions* on page 92 .

We recommend wheel removal be done only by your Honda dealer or another qualified mechanic. Do not attempt to remove the wheel on your own. Wheel removal requires mechanical skill and professional tools.

(CBR1000RR ABS only)

When removing and installing the wheel, be careful not to damage the wheel speed sensor and pulser ring.

#### RIGHT SIDE

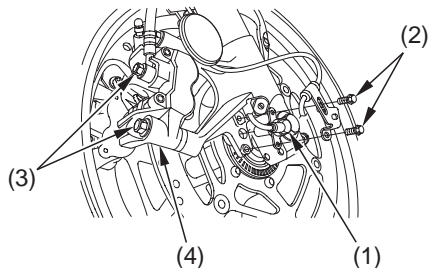

- (1) wheel speed sensor  
(CBR1000RR ABS only)
- (2) bolts (CBR1000RR ABS only)
- (3) fixing bolts
- (4) brake caliper assembly

#### Removal

1. Park your motorcycle on a firm, level surface.

(cont'd)



## If You Have a Flat Tire

---

2. Support the motorcycle securely and raise the front wheel off the ground using a safety stand or a hoist.
3. (CBR1000RR ABS only)  
Remove the wheel speed sensor (1) by removing the bolts (2).
4. Remove the fixing bolts (3) and remove the right and left caliper assemblies (4) from the fork legs.
  - To avoid damage to the brake hose during removal, support the caliper assembly so that it doesn't hang from the hose. Do not twist the brake hose.
  - Avoid getting grease, oil, or dirt on the disc or pad surfaces. Any contamination can cause poor brake performance or rapid pad wear after reassembly.

5. Loosen the right and left axle pinch bolts (5) and remove the front axle bolt (6).

### RIGHT FRONT

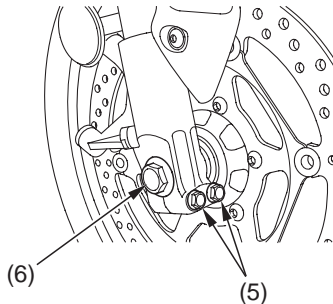

- (5) axle pinch bolts  
(6) front axle bolt

## If You Have a Flat Tire

- Remove the front axle shaft (7), wheel and side collars.
  - Avoid pressing the brake lever when the wheel is off the motorcycle. This will force the caliper pistons out of the cylinders. The result will be loss of brake fluid. If this occurs, the brake system will require service. See your Honda dealer for this service.

LEFT FRONT

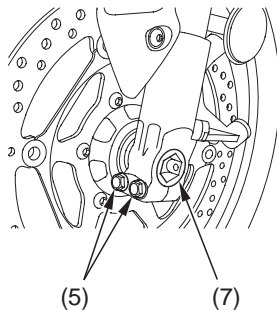

- (5) axle pinch bolts
- (7) front axle shaft

# If You Have a Flat Tire

## Installation

1. Install the side collars and position the wheel between the fork legs. Insert the front axle shaft from the left side, through the left fork leg and wheel hub.
2. Align the end of axle shaft (8) with the surface of fork leg (9).

### LEFT FRONT

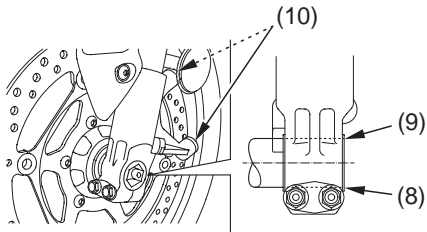

(8) end of axle shaft  
(9) surface of fork leg

(10) front fork  
spacers

3. Tighten the axle pinch bolts on the left fork leg to the specified torque:  
**16 lbf·ft (22 N·m , 2.2 kgf·m)**
4. Tighten the front axle bolt to the specified torque:  
**58 lbf·ft (79 N·m , 8.0 kgf·m)**
5. Make sure that the front fork spacers (10) are installed into the caliper bracket properly.
6. Install the right and left brake calipers onto the fork legs.  
To avoid damaging the brake pads, carefully fit the brake disc (11) between the pads.
7. Install the caliper fixing bolts and tighten to the specified torque:  
**33 lbf·ft (45 N·m , 4.6 kgf·m)**

## If You Have a Flat Tire

8. Operate the front brake and pump the fork several times. Check for free wheel rotation after the brake is released. Recheck the wheel if the brake drags or the wheel does not rotate freely.
9. If the clearances between each surface of the brake disc and the brake caliper body (12) (not the brake pads) are symmetrical, follow next step. If the clearances are not symmetrical, loosen the left axle pinch bolts and pull the left fork outward or push inward to adjust the clearance. Then follow the next step.

- Visually check that the clearances between each surface of the brake disc and the brake caliper body (not the brake pads) are symmetrical.

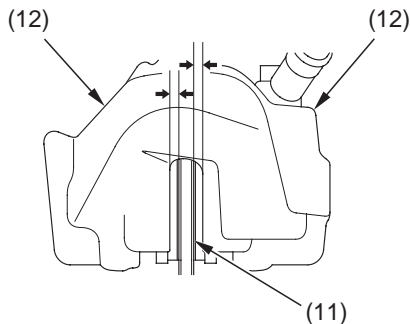

(11) brake disc    (12) brake caliper body

(cont'd)

## If You Have a Flat Tire

---

10. Tighten the axle pinch bolts on the right fork leg to the specified torque:  
**16 lbf·ft (22 N·m , 2.2 kgf·m)**
11. (CBR1000RR ABS only)  
Install the wheel speed sensor and tighten the bolts, then check the clearance between the wheel speed sensor and the pulser ring.

If a torque wrench was not used for installation, see your Honda dealer as soon as possible to verify proper assembly. Improper assembly may lead to loss of braking capability.

## If You Have a Flat Tire

### Emergency Rear Wheel Removal/Installation

Refer to *Safety Precautions* on page 92 .

We recommend wheel removal be done only by your Honda dealer or another qualified mechanic. Do not attempt to remove the wheel on your own. Wheel removal requires mechanical skill and professional tools.

(CBR1000RR ABS only)

When removing and installing the wheel, be careful not to damage the wheel speed sensor and pulser ring.

#### RIGHT REAR

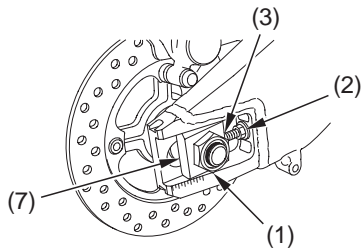

- (1) rear axle nut
- (2) drive chain lock nut
- (3) drive chain adjusting bolt
- (7) right chain adjustment plate

#### Removal

1. Park your motorcycle on a firm, level surface.

(cont'd)

## If You Have a Flat Tire

---

2. Support the motorcycle securely, raise the rear wheel off the ground.
3. Loosen the rear axle nut (1).
4. Loosen the drive chain lock nuts (2) and turn the drive chain adjusting bolts (3) so the rear wheel can be moved all the way forward for maximum drive chain slack.
5. Remove the rear axle nut and washer.

6. Remove the drive chain (4) from the rear wheel sprocket by pushing the rear wheel forward.

### LEFT REAR

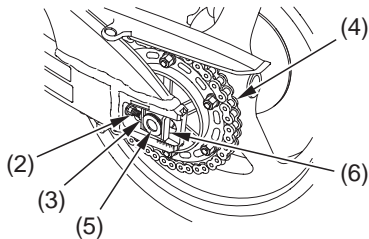

- (4) drive chain  
(5) rear axle shaft  
(6) left chain adjustment plate

## If You Have a Flat Tire

---

7. Remove the rear axle shaft (5), rear wheel, left chain adjustment plate (6), right chain adjustment plate (7), rear brake bracket and side collars from the swingarm.
- To avoid damage to the brake hose during removal, support the caliper assembly so that it doesn't hang from the hose. Do not twist the brake hose.
  - Avoid depressing the brake pedal when the wheel is off the motorcycle. This will force the caliper pistons out of the cylinders. The result will be a loss of brake fluid. If this occurs, the brake system will require service. See your Honda dealer for this service.

### Installation

1. Install the side collars and position the wheel and rear brake bracket.
  - While installing the wheel, carefully fit the brake disc between the brake pads to avoid damaging the pads.
  - Avoid getting grease, oil, or dirt on the disc or pad surfaces. Any contamination can cause poor brake performance or rapid pad wear after reassembly.

(cont'd)



## If You Have a Flat Tire

---

2. Make sure that the lug (8) on the rear brake bracket is positioned in the slot (9) on the swingarm (10).

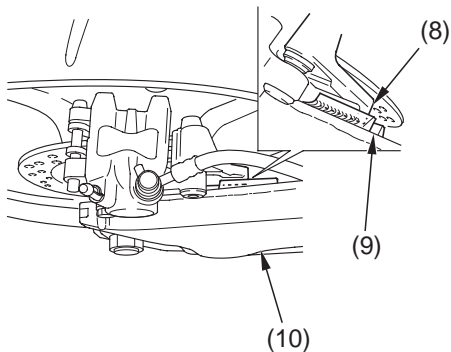

(8) lug  
(9) slot

(10) swingarm

3. Insert the rear axle shaft from the left side, through the left swingarm, wheel hub and rear brake bracket.
4. Install the drive chain by pushing the rear wheel forward.
5. Install the rear axle nut and tighten the drive chain adjusting bolts. Refer to drive chain adjustment (page 163 ).
6. Tighten the rear axle nut to the specified torque:  
83 lbf·ft (113 N·m , 11.5 kgf·m)  
Failure to provide adequate disc-to-rear brake bracket clearance may damage the brake discs and impair braking efficiency.

## If You Have a Flat Tire

---

7. After installing the wheel, apply the brakes several times, then recheck both discs for caliper holder to disc clearance. Do not operate the motorcycle without adequate clearance.

If a torque wrench was not used for installation, see your Honda dealer as soon as possible to verify proper assembly. Improper assembly may lead to loss of braking capability.

## If Your Engine Overheats

---

Normally, the coolant temperature on your temperature meter will rise and then level off. Hot weather may cause the temperature to rise higher than normal. So will temporary stress such as climbing a hill. If you're stuck in stop-and-go traffic, the temperature may climb some, but the radiator fan is designed to prevent overheating. Be aware of these variations as you monitor the meter.

If the coolant temperature display begins to flash, and the high coolant temperature indicator/warning indicator go on for no apparent reason, pull safely to the side of the road. If possible, park in a shady area.

### NOTICE

*Continuing to ride with an overheated engine can cause serious engine damage.*

- A steaming engine indicates a coolant leak. Shut the engine off and wait until the steaming stops. Look for a leak, but don't touch the engine or radiator system. Let everything cool off first.
- If there's no obvious problem, leave the engine on so the fan and coolant circulating system can continue working. Monitor the temperature meter. The temperature may drop to the normal range after a brief stop with no load on the engine.

## If Your Engine Overheats

- Check the radiator fans.

If either or both are not working, turn the engine off. Open the fuse box (page 216 ) and check the radiator fan fuses. If the fuse is blown, replace it with the proper (same rating) spare fuse. Start the engine. If the warning indicator and the high coolant temperature indicator go on, turn the engine off.

If the radiator fans are working, visually check the coolant level in the reserve tank, located behind the rear brake fluid reservoir. It isn't necessary to touch the radiator system.

### NOTICE

*The operation temperature of each cooling fan is different. Therefore, it is normal when only one of the fans operate.*

- If the reserve tank is low or empty, don't ride without adding coolant (page 126). After adding coolant, turn the engine on and check the temperature meter. If the temperature doesn't drop, do not ride. The engine needs repair. Transport your motorcycle to a Honda dealer (page 187 ). If the temperature drops to normal, check the coolant level. If it has gone down, add more coolant.

If you are able to resume riding, continue to monitor the meter frequently.

If there's a mild leak, you can ride for awhile, carefully watching the meter. Be prepared to stop and add more coolant or water. If the leak is bad, transport your motorcycle to a Honda dealer (page 187 ).

## If the Low Oil Pressure Indicator Lights

---

If you check your engine oil level regularly, you should never see the low oil pressure indicator and the warning indicator go on while riding. Normally, both will only light momentarily when you turn the ignition switch ON. Occasionally, it may flicker at or near idling speed.

Low oil pressure may be caused by an oil leak, a low oil level, or some problem in the engine's lubrication system.

If the warning indicator and the low oil pressure indicator light while you're riding, don't ignore them. Pull safely to the side of the road. If possible, pull in the clutch lever and coast to a stop. Stop the engine as soon as it's safe to do so.

### NOTICE

*Continuing to ride with low oil pressure can cause serious engine damage.*

- Check for an oil leak.
- Then check the oil level. If necessary, add the recommended oil (page 116) to the upper level mark. If you must leave your motorcycle to get oil, secure it as much as possible.
- After adding oil, start the engine, and check that the low oil pressure indicator and warning indicator go off. Check for a possible leak.

If the indicators go off and there is no leak — resume riding. If there is a leak — do not ride the motorcycle until the leak is repaired by a Honda dealer.

## If a Fuse Blows

All of the electrical circuits on your motorcycle have fuses to protect them from damage caused by excess current flow (short circuit or overload).

If something electrical on your motorcycle stops working, the first thing you should check for is a blown fuse.

Determine from the chart on the circuit fuse box cover which fuse or fuses control that component. Check those fuses first, but check all the fuses before looking elsewhere for another possible cause of the problem. Replace any blown fuses and check component operation.

- The main fuse and the FI fuse are located on the starter motor magnetic switch (3) under the front seat.
- The circuit fuse box is located under the front seat.
- The spare fuses are located in the fuse box.

### Recommended Fuses

main fuse	30A
FI fuse	20A
other fuses	10A, 20A
ABS motor fuses (CBR1000RR ABS)	30A

1. To prevent an accidental short circuit, turn the ignition switch OFF before checking or replacing the fuses.
2. Remove the front seat (page 109).

## If a Fuse Blows

---

UNDER FRONT SEAT  
(CBR1000RR)

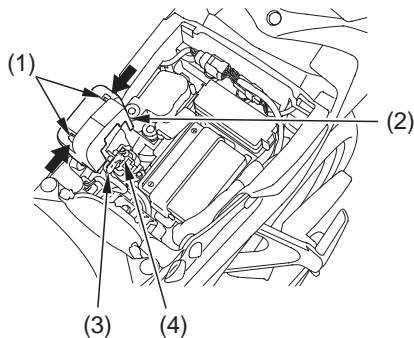

- (1) tabs
- (2) starter motor magnetic switch
- (3) main fuse
- (4) FI fuse

(CBR1000RR ABS)

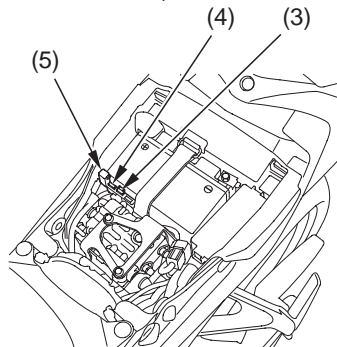

- (5) main and FI fuse box cover

## If a Fuse Blows

### Main Fuse and FI Fuse Access:

(CBR1000RR)

3. Release the tabs (1), then remove the starter motor magnetic switch cover (2).
4. To check or replace the main fuse (3) and FI fuse (4), pull out the old fuse. Look for a burned wire inside the fuse. If the fuse is blown (6), replace it with a spare fuse (7) of the same rating. The spare fuses are located in the fuse box (page 217).

MAIN FUSE,  
FI FUSE

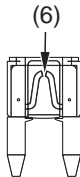

(6) blown fuse

5. Install the starter motor magnetic switch cover.

(CBR1000RR ABS)

3. Open the main and FI fuse box cover (5).
4. To check or replace the main fuse (3) and FI fuse (4), pull out the old fuse. Look for a burned wire inside the fuse. If the fuse is blown (6), replace it with a spare fuse (7) of the same rating. The spare fuses are located in the fuse box (page 217).
5. Close the main and FI fuse box cover.

(cont'd)



## If a Fuse Blows

---

### *Circuit Fuse Access:*

#### 6. (CBR1000RR)

Release the tabs ( 8 ), then remove the fuse box cover ( 9 ).

(CBR1000RR ABS)

Release the tabs by pushing the front tab backward, then remove the fuse box cover.

7. To check or replace a circuit fuse, pull the old fuse out of its retaining clips. Look for a burned wire inside the fuse. If the fuse is blown ( 10 ), replace it with a spare fuse ( 7 ) of the same rating.

If you do not have a replacement fuse with the proper rating for the circuit, install one with a lower rating.

### **NOTICE**

*Replacing a fuse with one that has a higher rating greatly increases the chance of damage to the electrical system.*

## If a Fuse Blows

UNDER FRONT SEAT  
(CBR1000RR)

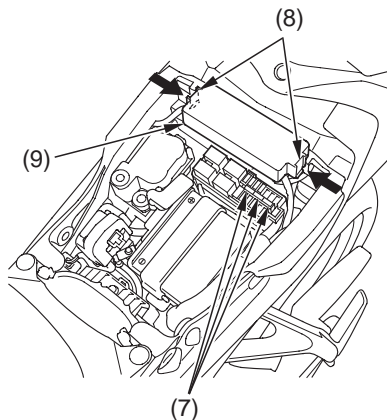

- (7) spare fuses
- (8) tabs
- (9) fuse box cover

(CBR1000RR ABS)

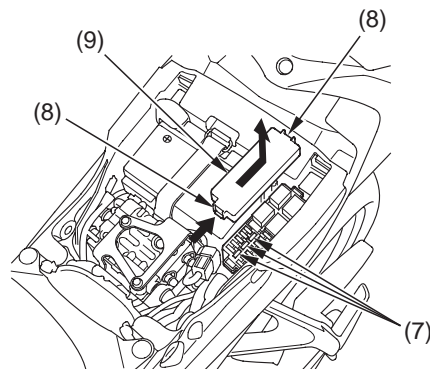

(cont'd)

## If a Fuse Blows

---

### CIRCUIT FUSE

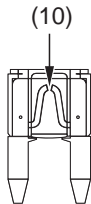

(10) blown fuse

8. Install the fuse box cover.
9. Install the front seat.

If you do not have a spare fuse and you cannot ride the motorcycle without fixing the problem, take a fuse of the same rating or a lower rating from one of the other circuits that you can do without temporarily.

If you replace a blown fuse with a spare fuse that has a lower rating, replace the fuse with the correct rating as soon as you can. Also remember to replace any spare fuses that were installed.

If the replacement fuse of the same rating burns out in a short time, there is probably a serious electrical problem on your motorcycle. Leave the blown fuse in that circuit and have your motorcycle checked by your Honda dealer.

## If a Fuse Blows

### *ABS motor fuses:*

(CBR1000RR ABS only)

The ABS motor fuses (11) are located on the starter magnetic switch.

To replace these fuses, the fuel tank must be removed.

The ABS motor fuses should be inspected by a Honda dealer, unless the owner has proper tools and service data and is mechanically qualified. Refer to an official Honda Service Manual.

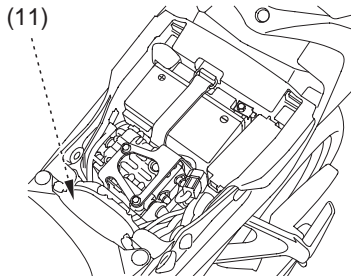

(11) ABS motor fuses

## If You Crash

---

Personal safety is your first priority after a crash. If you or anyone else has been injured, take time to assess the severity of the injuries and whether it is safe to continue riding. Call for emergency assistance if needed. Also follow applicable laws and regulations if another person or vehicle is involved in the crash.

If you decide that you are capable of riding safely, first evaluate the condition of your motorcycle. If the engine is still running, turn it off and look it over carefully; inspect it for fluid leaks, check the tightness of critical nuts and bolts, and secure such parts as the handlebar, control levers, brakes, and wheels.

If there is minor damage, or you are unsure about possible damage, ride slowly and cautiously. Sometimes, crash damage is hidden or not immediately apparent, so you should have your motorcycle thoroughly checked at a qualified service facility as soon as possible. Also, be sure to have your Honda dealer check the frame and suspension after any serious crash.

If your motorcycle cannot be ridden, see *Transporting Your Motorcycle*, page 187.

## If You Lose Your Key

You should receive a key number plate (1) with your keys. Store this plate in a safe place.

Be sure to record your key number in the Quick Reference section at the rear of the manual. You'll need this number to have a duplicate key made.

A lost key won't be a problem if you take preventative action. Store one duplicate key in a safe place at home and carry a second duplicate in your wallet.

If you lose your key and aren't carrying a duplicate, either get your spare or have one made. If you don't know your key number, call the dealer where you purchased your Honda. They may have it listed in their records. If they don't,

transport your motorcycle to them or the nearest Honda dealer. The dealer will probably have to remove the ignition switch assembly to find the key number so they can make a key for you.

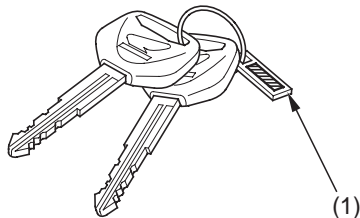

(1) key number plate

## If Your Battery Is Low (or Dead)

---

Jump starting is not recommended, especially if you use an automobile battery. The greater amperage of an automobile battery when the car engine is running can damage your motorcycle's electrical system.

Bump starting is also not recommended.

If you can't charge the battery or it appears unable to hold a charge, contact your Honda dealer.

## Technical Information

---

This section contains dimensions, capacities, and other technical data, plus information on government requirements and how to break-in your motorcycle.

Vehicle Identification.....	224
Specifications .....	227
Break-in Guidelines .....	234
Emission Control Systems .....	235
Catalytic Converter .....	242
Oxygenated Fuels .....	243



# Vehicle Identification

---

## Serial Numbers

The VIN and engine serial number are required when you register your motorcycle. They may also be required when ordering replacement parts. You may record these numbers in the Quick Reference section at the rear of this manual.

The VIN (vehicle identification number) is stamped on the right side of the steering head and also appears on the Safety Certification Label attached to the left side of the frame.

LEFT SIDE

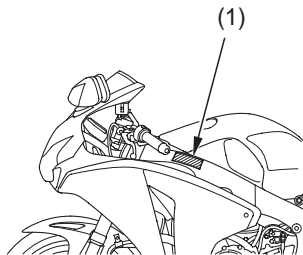

(1) VIN

# Vehicle Identification

RIGHT SIDE

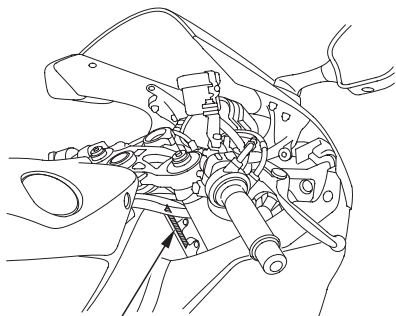

(2)

(2) VIN

The engine number (3) is stamped on the front of the crankcase.

LEFT SIDE

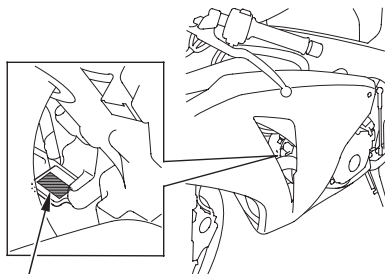

(3)

(3) engine number

# Vehicle Identification

---

## Color Label & Code

The color label (1) is attached on the rear fender under the rear seat. Remove the rear seat (page 110) to check the label.

The color code is helpful when ordering replacement parts. You may record the color and code in the Quick Reference section at the rear of this manual.

### UNDER REAR SEAT

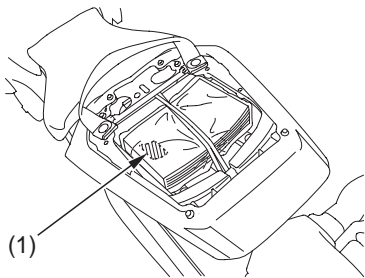

(1) color label

## Specifications

---

<b>Dimensions</b>	
overall length	81.9 in (2,080 mm)
overall width	27.0 in (685 mm)
overall height	44.5 in (1,130 mm)
wheelbase	55.5 in (1,410 mm)
ground clearance	5.1 in (130 mm)

# Specifications

---

<b>Fuel &amp; Lubricants</b>	
fuel recommendation	premium unleaded gasoline, pump octane number of 91 or higher
fuel tank capacity	4.68 US gal (17.7 ℓ)
engine oil capacity	after disassembly: 3.9 US qt (3.7 ℓ) after draining: 3.0 US qt (2.8 ℓ) after draining & oil filter change: 3.2 US qt (3.0 ℓ)
engine oil recommendation	API Service Classification SG or higher except oils labeled as energy conserving on the circular API service label, SAE 10W-30, JASO T 903 standard MA, Pro Honda GN4 4-stroke oil (USA & Canada) or Honda 4-stroke oil (Canada only), or an equivalent motorcycle oil
drive chain lubricant	Pro Honda HP Chain Lube or an equivalent chain lubricant designed specifically for use on O-ring chains
cooling system, recommendation	Pro Honda HP Coolant or an equivalent high quality ethylene glycol antifreeze containing corrosion protection inhibitors specifically recommended for use in aluminum engines
cooling system, capacity	3.2 US qt (3.0 ℓ)

## Specifications

<b>Capacities</b>	
passenger capacity	operator, one passenger
maximum weight capacity	366 lbs (166 kg) rider, passenger, all cargo and accessories

<b>Engine Specifications</b>	
displacement	61.0 cu-in (1,000 cm <sup>3</sup> )
bore & stroke	2.99 × 2.17 in (76.0 × 55.1 mm)
compression ratio	12.3 : 1
spark plug (standard)	IMR9E-9HES (NGK) VUH27ES (DENSO)
valve clearance (cold)	intake 0.006 in (0.16 mm) exhaust 0.012 in (0.30 mm)
idle speed	1,200 ± 100 rpm

## Specifications

---

<b>Power Transmission</b>	
primary reduction	1.717
gear ratio, 1st	2.285
2nd	1.777
3rd	1.500
4th	1.333
5th	1.214
6th	1.137
final reduction	2.625
standard sprocket sizes	drive (engine) sprocket: 16 teeth driven (rear wheel) sprocket: 42 teeth
final drive	chain DID 50VA11 or RK 50HFOZ6

<b>Chassis &amp; Suspension</b>	
caster	23°30'
trail	3.79 in (96.3 mm)
tire size, front	120/70ZR17M/C (58W) BRIDGESTONE BT015F RADIAL F DUNLOP Qualifier PTK
tire size, rear	190/50ZR17M/C (73W) BRIDGESTONE BT015R RADIAL F DUNLOP Qualifier NK
tire type	radial, tubeless
tire pressure, front (cold)	36 psi (250 kPa , 2.50 kgf/cm <sup>2</sup> )
tire pressure, rear (cold)	42 psi (290 kPa , 2.90 kgf/cm <sup>2</sup> )



# Specifications

---

<b>Electrical</b>	
battery	12V-6 Ah (CBR1000RR) 12V-8.6 Ah (CBR1000RR ABS)
generator	0.4 kW/5,000 rpm

<b>Lights</b>	
headlight	12V-55W (2 bulbs)
brake/tail light	LED
turn signal lights	12V-21W (front) 12V-21W (rear)
license light	12V-5W
running light	LED

<b>Fuses</b>	
main	30A
FI	20A
other fuses	10A, 20A
ABS motor fuses (CBR1000RR ABS)	30A

<b>Torque Specifications</b>	
engine oil drain bolt	22 lbf·ft (30 N·m , 3.0 kgf·m)
engine oil filter	19 lbf·ft (26 N·m , 2.7 kgf·m)
front wheel axle bolt	58 lbf·ft (79 N·m , 8.0 kgf·m)
front wheel caliper fixing bolts	33 lbf·ft (45 N·m , 4.6 kgf·m)
front wheel axle pinch bolts	16 lbf·ft (22 N·m , 2.2 kgf·m)
rear wheel axle nut	83 lbf·ft (113 N·m , 11.5 kgf·m)

## Break-in Guidelines

---

Help assure your motorcycle's future reliability and performance by paying extra attention to how you ride during the first 300 miles (500 km).

During this period, avoid full-throttle starts and rapid acceleration.

# Emission Control Systems

## Exhaust Emission Requirements

The U.S. Environmental Protection Agency (EPA), the California Air Resources Board (CARB), and Environment Canada (EC) require that your motorcycle comply with applicable exhaust emissions standards during its useful life, when operated and maintained according to the instructions provided.

The Vehicle Emission Control Information label (1) (2) is attached on the rear fender under the rear seat.

## UNDER REAR SEAT

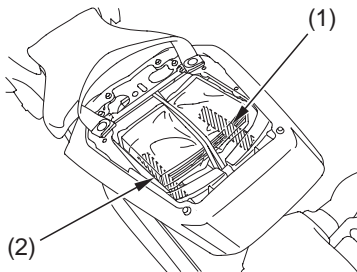

- (1) vehicle emission control information label
- (2) vehicle emission control information label (Canada only)

# Emission Control Systems

---

## Noise Emission Requirements

The EPA also requires that motorcycles built after January 1, 1983 comply with applicable noise emission standards for one year or 3,730 miles (6,000 km) after the time of sale to the ultimate purchaser, when operated and maintained according to the instructions provided.

## Warranty Compliance

Compliance with the terms of the Distributor's Warranties for Honda Motorcycle Emission Control Systems is necessary in order to keep the emissions system warranty in effect. (USA only)

## Source of Exhaust Emissions

The combustion process produces carbon monoxide (CO), oxides of nitrogen (NOx) and hydrocarbons (HC). Control of hydrocarbons and oxides of nitrogen is very important because, under certain conditions, they react to form photochemical smog when subjected to sunlight. Carbon monoxide does not react in the same way, but it is toxic.

Honda Motor Co., Ltd. utilizes various systems to reduce carbon monoxide, oxides of nitrogen and hydrocarbons.

# Emission Control Systems

---

## **Exhaust Emission Control System**

The exhaust emission control system includes an oxidation catalyst, a secondary air supply system, and a PGM-FI system.

No adjustment to these systems should be made although periodic inspection of all components is recommended.

## ***PGM-FI System***

The PGM-FI system uses dual sequential fuel injection. It has four subsystems: Air Intake, Engine Control, Fuel Control, and Exhaust Control.

The Engine Control Module (ECM) uses various sensors to determine how much air is going into the engine. It then controls how much fuel to inject under all operating conditions.

## ***Ignition Timing Control System***

The system constantly adjusts the ignition timing, reducing the amount of HC, CO and NO<sub>x</sub> produced.

# Emission Control Systems

---

## ***Secondary Air Injection System***

The secondary air injection system introduces filtered air into the exhaust gases in the exhaust port. The secondary air injection system helps improve emission control performance.

## ***Oxidation Catalytic Converter***

The oxidation catalytic converter is in the exhaust system. Through chemical reactions, they convert HC and CO in the engine's exhaust to carbon dioxide (CO<sub>2</sub>) and water vapor.

## **Evaporative Emission Control System (California only)**

This motorcycle complies with the requirements of the California Air Resources Board (CARB) evaporative emission regulations. Fuel vapor from the fuel tank is directed into the charcoal canister and air cleaner where it is adsorbed and stored while the engine is stopped. When the engine is running and the purge control solenoid valve is open, fuel vapor in the charcoal canister and air cleaner is drawn into the engine through the throttle body.

## **Crankcase Emission Control System**

The engine is equipped with a closed crankcase system to prevent discharging crankcase emissions into the atmosphere. Blow-by gas is returned to the combustion chamber through the air cleaner and the intake manifold.

## **Problems That May Affect Motorcycle Exhaust Emissions**

If you are aware of any of the following symptoms, have the vehicle inspected and repaired by your authorized Honda motorcycle dealer.

Symptoms:

1. Hard starting or stalling after starting
2. Rough idle
3. Misfiring or backfiring during acceleration
4. After-burning (backfiring)
5. Poor performance (driveability) and poor fuel economy



# Emission Control Systems

---

## Noise Emission Control System

TAMPERING WITH THE NOISE CONTROL SYSTEM IS PROHIBITED:

U. S. federal law prohibits, or Canadian provincial laws may prohibit the following acts or the causing thereof: ( 1 ) The removal or rendering inoperative by any person, other than for purposes of maintenance, repair or replacement, of any device or element of design incorporated into any new vehicle for the purpose of noise control prior to its sale or delivery to the ultimate purchaser or while it is in use; or ( 2 ) the use of the vehicle after such device or element of design has been removed or rendered inoperative by any person.

AMONG THOSE ACTS PRESUMED TO CONSTITUTE TAMPERING ARE THE FOLLOWING ACTS:

1. Removal of, or puncturing the muffler, baffles, header pipes or any other component which conducts exhaust gases.
2. Removal of, or puncturing of any part of the intake system.
3. Lack of proper maintenance.
4. Replacing any moving parts of the vehicle, or parts of the exhaust or intake system, with parts other than those specified by the manufacturer.

## **Fuel Permeation Emission Control System**

This vehicle complies with the Fuel Permeation Emission Control regulations of the U.S. Environmental Protection Agency (EPA), the California Air Resources Board (CARB), and Environment Canada (EC). The fuel tank, fuel hoses, and fuel vapor charge hoses used on this vehicle incorporate fuel permeation control technologies. Tampering with the fuel tank, fuel hoses, or fuel vapor charge hoses to reduce or defeat the effectiveness of the fuel permeation technologies is prohibited by federal regulations.

# Catalytic Converter

---

This motorcycle is equipped with an oxidation catalytic converter.

The catalytic converter contains precious metals that serve as catalysts, promoting chemical reactions to convert the exhaust gasses without affecting the metals.

The catalytic converter acts on HC and CO. A replacement unit must be an original Honda part or its equivalent.

The catalytic converter must operate at a high temperature for the chemical reactions to take place. It can set fire to any combustible materials that come near it. Park your motorcycle away from high grasses, dry leaves, or other flammables.

A defective catalytic converter contributes to air pollution, and can impair your

engine's performance. Follow these guidelines to protect your motorcycle's catalytic converter.

- Always use unleaded gasoline. Even a small amount of leaded gasoline can contaminate the catalyst metals, making the catalytic converter ineffective.
- Keep the engine in good running condition. A poorly running engine can cause the catalytic converter to overheat causing damage to the converter or the motorcycle.
- If your engine is misfiring, backfiring, stalling, or otherwise not running properly, stop riding and turn off the engine. Have your motorcycle serviced as soon as possible.

## Oxygenated Fuels

---

Some conventional gasolines are being blended with alcohol or an ether compound. These gasolines are collectively referred to as oxygenated fuels. To meet clean air standards, some areas of the United States and Canada use oxygenated fuels to help reduce emissions. If you use an oxygenated fuel, be sure it is unleaded and meets the minimum octane rating requirement.

Before using an oxygenated fuel, try to confirm the fuel's contents. Some states/provinces require this information to be posted on the pump.

The following are the EPA-approved percentages of oxygenates:

ETHANOL (ethyl or grain alcohol) 10% by Volume

You may use gasoline containing up to 10% ethanol by volume. Gasoline containing ethanol may be marketed under the name "Gasohol".

MTBE (Methyl Tertiary Butyl Ether) 15% by Volume

You may use gasoline containing up to 15% MTBE by volume.

(cont'd)

## Oxygenated Fuels

---

METHANOL (methyl or wood alcohol)  
5% by Volume

You may use gasoline containing methanol containing up to 5% methanol by volume as long as it also contains cosolvents and corrosion inhibitors to protect the fuel system. Gasoline containing more than 5% methanol by volume may cause starting and/or performance problems. It may also damage metal, rubber, and plastic parts of your fuel system.

If you notice any undesirable operating symptoms, try another service station or switch to another brand of gasoline.

Fuel system damage or performance problems resulting from the use of an oxygenated fuel containing more than the percentages of oxygenates mentioned above are not covered under warranty.

Oxygenated fuels can damage paint and plastic. Be careful not to spill fuel when filling the fuel tank. Wipe up any spills immediately.

### NOTICE

*Oxygenated fuels can damage paint and plastic. Damage caused by spilled fuel is not covered by warranty.*

## Consumer Information

---

This section contains information on your warranty and how to get an official Honda Service Manual.

Authorized Manuals .....	246
Warranty Coverage .....	249
Warranty Service .....	250
Contacting Honda.....	251
Your Honda Dealer .....	252
The Honda Rider's Club (USA only) .....	253
Reporting Safety Defects (USA only) .....	254

## Authorized Manuals

---

The Service Manual used by your authorized Honda dealer is available from Helm, Inc. (USA only, Canada: See your Honda dealer to order authorized manuals.)

Also available but not necessary to service your model is the Honda Common Service Manual which explains theory of operation and basic service information for various systems common to all Honda motorcycles, motor scooters and ATVs.

These Honda manuals are written for the professional technician, but most mechanically capable owners should find them easy to use if they have the proper tools and observe proper safety standards. Special Honda tools are necessary for some procedures.

Publication Item No.	Description	Price Each*
61MFL01	2009 CBR1000RR/A Service Manual	\$60.00
61CM002	Common Service Manual	\$48.00
31MFL610	2009 CBR1000RR/A Owner's Manual	\$16.00
<i>* Prices are subject to change without notice and without incurring obligation.</i>		

**Order On-Line: [www.helminc.com](http://www.helminc.com)**

**Order Toll Free: 1-888-CYCLE93 (1-888-292-5393)**

*(NOTE: For Credit Card Orders Only)*

**Monday — Friday 8:00 AM — 6:00 PM EST**

**OR**

By completing this form you can order the materials desired. You can pay by check or money order, or charge to your credit card. Mail to Helm, Inc. at the address shown on the back of this order form (USA only).

Canada: See your Honda dealer to order authorized manuals.

<b>Publication Item No.</b>	<b>Item Description</b>	<b>Qty.</b>	<b>Price Each*</b>	<b>Total Price</b>
*Prices are subject to change without notice and without incurring obligation.  Orders are mailed within 10 days. Please allow adequate time for delivery.	<b>Sub Total</b>			
	<b>Purchaser's Sales Tax</b>			
	<b>Mich. add 6 %</b>			
	<b>Calif. add 7.25 %</b>			
			<b>Handling Charge</b>	<b>\$3.75</b>
			<b>Grand Total</b>	



**S  
H  
I  
P  
T  
O**

NOTE: Dealers and Companies please provide dealer or company name, and also the name of the person to whose attention the shipment should be sent.

Customer Name \_\_\_\_\_ Attention \_\_\_\_\_

Street address/P. O. BOX \_\_\_\_\_ Apartment Number \_\_\_\_\_

City \_\_\_\_\_ State \_\_\_\_\_ Zip Code \_\_\_\_\_

Daytime Telephone Number (      ) \_\_\_\_\_

**P  
A  
Y  
M  
E  
N  
T**

Check or money order enclosed payable to Helm Inc.  
U.S. funds only. Do not send cash.

Check here if your billing address is different from the  
shipping address shown above.

MasterCard

Account Number

--	--	--	--	--

--	--	--	--	--	--

--	--	--	--	--	--

--	--	--	--	--	--

Expiration: Mo. Yr.

--	--	--	--

VISA

Discover

Security Code

--	--	--

Customer Signature \_\_\_\_\_ Date \_\_\_\_\_

These Publications cannot be returned for credit without receiving advance authorization within 14 days of delivery. For returns, a restocking fee may be applied against the original order.

**HELM** P.O. BOX 07280, DETROIT, MICHIGAN 48207

## Warranty Coverage

---

Your new Honda is covered by these warranties:

- Motorcycle Limited Warranty
- Emission Control System Warranty
- Noise Control Warranty

There are responsibilities, restrictions, and exclusions which apply to these warranties. Please read the Warranties Booklet given to you by your Honda dealer at the time of purchase. Be sure to keep your Honda owner's card with your Warranties Booklet (USA only).

It is important to realize that your warranty applies to defects in material or workmanship of your Honda. Your warranty coverage does not apply to normal wear or deterioration associated with using the motorcycle.

Your warranty coverage will not be voided if you choose to perform your own maintenance. However, you should have the proper tools and service information and be mechanically qualified. Failures that occur due directly to improper maintenance are not covered.

Almost all of your warranty coverage can be extended through the Honda Protection Plan (USA only). For more information, see your Honda dealer.

## Warranty Service

---

Please remember that recommended maintenance interval servicing is not included in your warranty coverage. Additionally, your warranty does not apply to the normal wear of items (such as brakes, tires, etc.).

If you believe you have a problem with your motorcycle, call the service department of your Honda dealer. Make an appointment for an inspection and diagnosis. Remember, as the owner of the motorcycle, you will be asked to authorize that inspection. Your dealer will give you the results of the inspection. If the problem is covered under warranty, your dealer will perform the warranty repairs for you.

If you have questions about warranty coverage or the nature of the repair, it is best to talk to the Service Manager of your Honda dealer.

Sometimes, in spite of the best intentions of all concerned, a misunderstanding may occur. If you aren't satisfied with your dealer's handling of the situation, we suggest you discuss your problem with the appropriate member of the dealership's management team. If the problem has already been reviewed with the Service Manager, Parts Manager, Sales Manager, etc., contact the Owner of the dealership or their designated representative.

## Contacting Honda

---

Your owner's manual was written to cover most of the questions you might ask about your Honda. Any questions not answered in the owner's manual can be answered by your Honda dealer. If your dealer doesn't have the answer right away, they will get it for you.

If you have a difference of opinion with your dealer, please remember that each dealership is independently owned and operated. That's why it's important to work to resolve any differences at the dealership level.

If you wish to comment on your experiences with your Honda or with your dealer, please send your comments to the following address (USA only):

Motorcycle Division, American Honda Motor Co., Inc., P.O. Box 2200, Torrance, CA 90509-2200, mailstop: 100-4C-7B, telephone: (866) 784-1870.

Canada: Refer to the Warranties Booklet that was supplied with your vehicle.

Please include the following information in your letter:

- name, address, and telephone number
- product model, year, and VIN
- date of purchase
- dealer name and address

We will likely ask your Honda dealer to respond, or possibly acknowledge your comments directly.

## Your Honda Dealer

---

Once you purchase your new Honda, get familiar with the organization of your Honda dealer so you can utilize the full range of services available.

The service department is there to perform regular maintenance and unexpected repairs. It has the latest available service information from Honda. The service department will also handle warranty inspections and repairs.

The parts department offers Honda Genuine Parts, Pro Honda products, Honda Genuine Accessories (USA only), and Honda accessories and products (Canada only). The same quality that went into your Honda can be found in Honda Genuine replacement parts. You'll also find comparable quality in the accessories

and products available from the parts department.

The sales department offers the Honda Protection Plan to extend almost all of your warranty coverage (USA only). Your Honda dealer can inform you about competition and other riding events in your area. You'll also find that your dealer is a source of information about safety training available in your local area and the Honda Rider's Club of America (USA only).

We're sure you'll be as pleased with the service your Honda dealer continues to provide after the sale as you are with the quality and dependability of your Honda.

## The Honda Rider's Club (USA only)

---

You may be eligible for a Honda Rider's Club of America (HRCA) membership with the purchase of your new Honda. You can log on to the HRCA Clubhouse website for details at *www.hrca.honda.com*.

## Reporting Safety Defects (USA only)

---

If you believe that your vehicle has a defect which could cause a crash or could cause injury or death, you should immediately inform the National Highway Traffic Safety Administration (NHTSA) in addition to notifying American Honda Motor Co., Inc.

If NHTSA receives similar complaints, it may open an investigation, and if it finds that a safety defect exists in a group of vehicles, it may order a recall and remedy campaign. However, NHTSA cannot become involved in individual problems between you, your dealer, or American Honda Motor Co., Inc.

To contact NHTSA, you may call the Vehicle Safety Hotline toll-free at 1-888-327-4236 (TTY: 1-800-424-9153); go to <http://www.safercar.gov>; or write to: Administrator, NHTSA, 1200 New Jersey Avenue, SE., Washington, DC 20590.

You can also obtain other information about motor vehicle safety from <http://www.safercar.gov>.





# Table of Contents

---

The following presents the contents of each section of your owner's manual.

<b>MOTORCYCLE SAFETY .....</b>	<b>1</b>
Important Safety Information .....	2
Accessories & Modifications.....	5
Safety Labels .....	7
<b>INSTRUMENTS &amp; CONTROLS .....</b>	<b>9</b>
Operation Component Locations .....	11
Gauges, Indicators & Displays.....	14
Multi-function Display.....	25
Coolant Temperature Meter.....	26
Low Fuel Indicator and Reserve Fuel Consumption .....	28
Low Oil Pressure Indicator and Warning Indicator .....	30
High Coolant Temperature Indicator and Warning Indicator.....	31

HESD Indicator .....	32
Changing the Indication of Multi-function Display.....	33
Speedometer .....	34
Odometer/Tripmeter A & B.....	35
Fuel Mileage Meter .....	37
Changing the Speed, Mileage and Fuel Mileage Unit.....	40
Changing the Temperature Unit .....	41
Changing the Indication Mode of Fuel Mileage.....	42
Digital Clock .....	43
Presetting the Shift Indicator and Selecting the Display.....	46

# Table of Contents

---

## **INSTRUMENTS & CONTROLS (cont'd)**

Controls & Features.....	49
Ignition Switch .....	49
Start Button.....	50
Engine Stop Switch .....	50
Headlight Dimmer Switch .....	51
Turn Signal Switch.....	51
Horn Button .....	52
Control Button A.....	52
Control Button B .....	53
HESD (Honda Electronic Steering Damper) .....	54

<b>BEFORE RIDING.....</b>	<b>55</b>
Are You Ready to Ride? .....	56
Protective Apparel.....	56
Rider Training .....	58
Is Your Motorcycle Ready to Ride? .....	59
Pre-ride Inspection .....	59
Load Limits & Guidelines.....	62
Loading.....	62
Load Limits .....	63
Loading Guidelines .....	63

(cont'd)

# Table of Contents

---

## **BASIC OPERATION & RIDING.....65**

Safe Riding Precautions .....	66
Starting & Stopping the Engine .....	67
Preparation.....	68
Starting Procedure .....	69
Flooded Engine .....	70
Bank Angle Sensor Ignition Cut-off System .....	70
How to Stop the Engine .....	71
Shifting Gears.....	72
Braking .....	74
Combined ABS (CBR1000RR ABS ).....	76
Combined ABS Indicator (CBR1000RR ABS ).....	78
Parking .....	80
Theft-prevention Tips .....	83
Riding with a Passenger or Cargo.....	85

## **SERVICING YOUR HONDA .....87**

<i>Before You Service Your Honda</i>	
The Importance of Maintenance.....	90
Maintenance Safety.....	91
Important Safety Precautions.....	92
Periodic Maintenance.....	94
Maintenance Schedule .....	96
Maintenance Record .....	101
 <i>Service Preparations</i>	
Maintenance Component Locations ...	103
Tool Kit.....	106
Owner's Manual Storage .....	107
Seat Removal.....	109
Lower Cowl Removal .....	111

# Table of Contents

---

## SERVICING YOUR HONDA (cont'd)

### *Service Procedures*

#### Fluids & Filters

Fuel .....	112
Engine Oil & Filter.....	115
Coolant.....	125

#### Engine

Throttle .....	129
Clutch System.....	131

#### Chassis

Suspension.....	135
Brakes .....	144
Tires .....	150
Side Stand.....	159
Drive Chain .....	160

#### Electrical

Battery .....	168
---------------	-----

Appearance Care .....	174
-----------------------	-----

#### **TIPS .....**

<b>183</b>	
Storing Your Honda .....	184
Transporting Your Motorcycle .....	187
You & the Environment.....	188

(cont'd)

# Table of Contents

---

<b>TAKING CARE OF THE UNEXPECTED .....</b>	<b>189</b>
General Guidelines .....	190
If Your Engine Quits or Won't Start ..	191
If You Have a Flat Tire .....	196
If Your Engine Overheats .....	210
If the Low Oil Pressure Indicator Lights .....	212
If a Fuse Blows.....	213
If You Crash .....	220
If You Lose Your Key .....	221
If Your Battery Is Low (or Dead) .....	222

<b>TECHNICAL INFORMATION .....</b>	<b>223</b>
Vehicle Identification.....	224
Specifications .....	227
Break-in Guidelines .....	234
Emission Control Systems .....	235
Catalytic Converter .....	242
Oxygenated Fuels.....	243

# Table of Contents

---

<b>CONSUMER INFORMATION .....</b>	<b>245</b>
Authorized Manuals .....	246
Warranty Coverage .....	249
Warranty Service.....	250
Contacting Honda.....	251
Your Honda Dealer .....	252
The Honda Rider's Club (USA only) .....	253
Reporting Safety Defects (USA only) .....	254
<b>TABLE OF CONTENTS .....</b>	<b>256</b>
<b>INDEX .....</b>	<b>262</b>
<b>QUICK REFERENCE</b>	

# Index

---

## A

ABS main fuse.....	77
ABS motor fuse.....	77, 213, 219
accessories .....	5
air pressure, tires.....	150
American Honda, contacting.....	251
apparel, protective .....	56
appearance care .....	174
average fuel mileage .....	38

## B

bank angle sensor .....	70
battery .....	168
brakes,	
fluid.....	145
front lever adjustment .....	144
pad wear.....	148
braking .....	74
break-in guidelines .....	234
button,	
control button A.....	14, 52
control button B.....	14, 53

## C

- capacity, fuel ..... 113
- care, appearance ..... 174
- catalytic converter ..... 242
- chain, drive ..... 160
- cleaning,
  - appearance care .....174
  - matte color painted surface ..... 179
- clock, digital .....43
- clutch system ..... 131
- color label ..... 226
- Combined ABS..... 76
- Combined ABS indicator ..... 78
- compartment,
  - owner's manual ..... 107
  - U-shaped lock..... 83
- consumer information ..... 245
- control button A..... 14, 52

- control button B ..... 14, 53
- coolant..... 125
- coolant temperature meter..... 26
- cowl removal,
  - lower cowl ..... 111
- current fuel mileage..... 38
- customer service ..... 251

## D

- damping, suspension,
  - front ..... 138
  - rear ..... 142
- defects, reporting safety ..... 254
- digital clock ..... 43
- display,
  - check ..... 17
  - multi-function..... 25
- drive chain ..... 160



# Index

---

## E

emission control systems.....	235
engine,	
flooded.....	70
low oil pressure.....	212
number.....	225
oil.....	115
overheats.....	210
pinging.....	112
starting.....	67
stop switch.....	50
stopping.....	71
won't start.....	191
environment.....	188

## F

flat tire.....	196
flooded engine.....	70
fuel,	
consumption.....	38
mileage meter.....	37
oxygenated.....	243
recommendation.....	112
reserve consumption.....	28
tank capacity.....	113
fuel mileage,	
average.....	38
current.....	38
fuses.....	213

## G

- gasohol ..... 243
- gasoline ..... 112
- gauges, indicators & displays..... 14

## H

- headlight dimmer switch ..... 51
- helmet holders..... 82
- high beam indicator ..... 14, 19
- Honda,
  - contacting ..... 251
  - dealer..... 252
  - Rider's Club..... 253
- Honda service manual ..... 246
- horn button..... 52

## I

- identification, vehicle ..... 224
- ignition cutoff system,
  - bank angle..... 70
  - side stand ..... 67
- ignition switch ..... 49
- indicators..... 14
- inspection, pre-ride ..... 59

# Index

---

## K

- key, lost..... 221
- kit, tool..... 106

## L

- labels, safety ..... 7
- lamp check..... 15
- limit, weight..... 63
- load limits ..... 63
- loading guidelines..... 63
- lock, steering..... 81
- low fuel indicator ..... 14, 19

## M

- maintenance,
  - component locations..... 103
  - importance ..... 90
  - periodic ..... 94
  - record ..... 101
  - safety..... 91
  - schedule ..... 96
- malfunction indicator lamp (MIL)... 14, 20
- manual, service ..... 246
- maximum weight limit ..... 63
- matte painted surface, clean..... 179
- meter check..... 16
- modifications ..... 6

## N

- neutral indicator..... 14, 19
- numbers, serial..... 224

## O

- odometer ..... 14, 23, 35
- oil,
  - engine..... 115
  - low pressure..... 212
- operating controls ..... 49
- operation component locations ..... 11
- overheat, engine..... 210
- owner's manual storage..... 107
- oxygenated fuels..... 243

## P

- parking ..... 80
- PGM-FI indicator ..... 14, 20
- pinging, engine ..... 112
- pre-load, suspension,
  - front ..... 137
  - rear ..... 141
- pre-ride inspection ..... 59
- problems, unexpected..... 189
- protective apparel ..... 56

# Index

---

## R

- removal,
  - lower cowl ..... 111
  - seat ..... 109
- reporting safety defects ..... 254
- reserve fuel consumption ..... 28
- rider training ..... 3, 58
- Rider's Club, Honda ..... 253
- riding,
  - basic operation ..... 65
  - clothing ..... 56
  - precautions ..... 66
  - safety ..... 2
  - safety precautions ..... 66
  - with passenger or cargo ..... 85

## S

- safety,
  - important precautions ..... 92
  - labels ..... 7
  - reporting defects ..... 254
  - riding precautions ..... 66
- schedule, maintenance ..... 96
- seat removal ..... 109
- sensor, bank angle ..... 70
- serial numbers ..... 224
- service,
  - customer ..... 251
  - manuals ..... 246
  - warranty ..... 250
- shifting gears ..... 72
- shift indicator ..... 14, 46
- side stand ..... 159
- side stand ignition cutoff system ..... 67

- 
- spark knock ..... 112
  - specifications ..... 227
  - speedometer ..... 14, 29, 34
  - stand, side ..... 159
  - start button ..... 50
  - starting,
    - engine ..... 67
    - troubleshooting ..... 192
  - steering lock ..... 81
  - stop switch, engine ..... 50
  - stopping engine ..... 71
  - storage,
    - motorcycle ..... 184
    - owner's manual ..... 107
    - U-shaped lock ..... 83
  - suspension,
    - front suspension adjustment ..... 136
    - front suspension damping ..... 138
    - front suspension spring pre-load ..... 137
    - rear suspension adjustment ..... 140
    - rear suspension damping ..... 142
    - rear suspension spring pre-load ..... 141
  - switch,
    - engine stop ..... 50
    - headlight dimmer ..... 51
    - ignition ..... 49
    - turn signal ..... 51

# Index

---

## T

- tachometer ..... 14, 19
- temperature meter, coolant..... 26
- theft-prevention tips ..... 83
- throttle..... 129
- tire identification no.(TIN) ..... 153, 154
- tires,
  - air pressure..... 150
  - flat..... 196
  - replacing ..... 156
- tool kit..... 106
- training, rider ..... 3, 58
- transporting your motorcycle ..... 187
- tripmeter..... 14, 23, 35
- trouble, unexpected ..... 189
- troubleshooting, starting..... 192
- turn signal indicators ..... 14, 18, 21

## V

- vehicle identification no. (VIN)..... 224

## W

- warning indicator..... 14, 21
- warranty,
  - coverage..... 249
  - extended..... 249
  - service ..... 250
- washing your motorcycle ..... 174
- weight limit..... 63
- wheels,
  - front removal ..... 199
  - rear removal..... 205





## Quick Reference

---

The following is a brief, but important collection of information you need to know about your Honda. You'll also find space to record important notes.

### How to Avoid Costly Repairs

The engine of your Honda can be the most expensive component to repair. Proper maintenance, especially the use of the recommended fluids and filters, prevents premature wear and damage.

Frequent causes of costly repairs are:

- Engine oil — insufficient quantity, improper oil.
- Air cleaner — dirty, leaking because of improper installation (poor seal).

Record important information on the following page:

## Quick Reference

---

VIN	
Engine No.	
Ignition Key No.	
Color Label	
Owner's Name	
Address	
City/State	
Phone	
Dealer's Name	
Address	
City/State	
Phone	
Service Mgr.	

## Quick Reference

---

Scheduled Maintenance	Initial: 600 miles (1,000 km) Regular: every 4,000 miles (6,400 km)
Pre-ride Inspection	Check the following items each time before you ride (page 59): tires & wheels, chain, leaks, loose parts, lights, throttle, brakes, indicators.
Periodic Checks	Check the following items monthly (page 95 ): tires & wheels, fluids, lights, freeplay, drive chain, fuses, nuts & bolts.
Fuel/Capacity	premium unleaded gasoline, pump octane number 91 or higher <b>4.68 US gal (17.7 ℓ)</b>
Engine Oil	API Service Classification SG or higher except oils labeled as energy conserving on the circular API service label, SAE 10W-30, JASO T 903 standard MA, Pro Honda GN4 4-stroke oil or equivalent
Maximum Weight Capacity	<b>366 lbs (166 kg)</b> rider, passenger, all cargo and accessories







## Quick Reference

Tires	Front: 120/70ZR17M/C (58W) BRIDGESTONE BT015F RADIAL F or DUNLOP Qualifier PTK Rear: 190/50ZR17M/C (73W) BRIDGESTONE BT015R RADIAL F or DUNLOP Qualifier NK Type: radial, tubeless
Tire Pressure (cold)	Front: 36 psi (250 kPa , 2.50 kgf/cm <sup>2</sup> ) Rear: 42 psi (290 kPa , 2.90 kgf/cm <sup>2</sup> )
Spark Plugs	standard: IMR9E-9HES (NGK) VUH27ES (DENSO)
Coolant	ethylene glycol antifreeze (silicate-free) for aluminum engines in 50/50 solution with Pro Honda HP Coolant or an equivalent distilled water
Fuses	main: 30A FI: 20A other: 10A, 20A ABS motor (CBR1000RR ABS): 30A

## Quick Reference

---

These symbols are used in Controls & Features section:

SYMBOL	COMPONENT	SEE PAGE
	START button	50
	RUN — engine stop switch	50
	OFF — engine stop switch	50
	HI — headlight dimmer switch	51
	LO — headlight dimmer switch	51
	turn signal switch	51
	horn button	52

## Free Manuals Download Website

<http://myh66.com>

<http://usermanuals.us>

<http://www.somanuals.com>

<http://www.4manuals.cc>

<http://www.manual-lib.com>

<http://www.404manual.com>

<http://www.luxmanual.com>

<http://aubethermostatmanual.com>

Golf course search by state

<http://golfingnear.com>

Email search by domain

<http://emailbydomain.com>

Auto manuals search

<http://auto.somanuals.com>

TV manuals search

<http://tv.somanuals.com>