



10/11/05 11:18:54 32KYJE00_001



Honda CBR250R/RA

OWNER'S MANUAL



© Honda Motor Co., Ltd. 2010

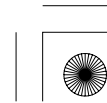



IMPORTANT INFORMATION

- **OPERATOR AND PASSENGER**

This motorcycle is designed to carry the operator and one passenger. Never exceed the maximum weight capacity.

- **ON-ROAD USE**

This motorcycle is designed to be used only on the road.

- **READ THIS OWNER'S MANUAL CAREFULLY**

Pay special attention to the safety messages that appear throughout the manual. These messages are fully explained in the "A Few Words About Safety" section which appears before the Contents page.

This manual should be considered a permanent part of the motorcycle and should remain with the motorcycle when resold.

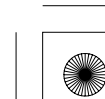



Honda CBR250R/RA OWNER'S MANUAL

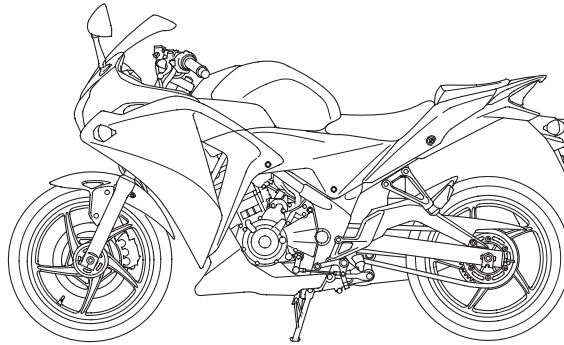

All information in this publication is based on the latest production information available at the time of approval for printing. Honda Motor Co.,Ltd. reserves the right to make changes at any time without notice and without incurring any obligation.

No part of this publication may be reproduced without written permission.

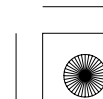



WELCOME

The motorcycle presents you a challenge to master the machine, a challenge to adventure. You ride through the wind, linked to the road by a vehicle that responds to your commands as no other does. Unlike an automobile, there is no metal cage around you. Like an airplane, a pre-ride inspection and regular maintenance are essential to your safety. Your reward is freedom.

To meet the challenges safely, and to enjoy the adventure fully, you should become thoroughly familiar with this owner's manual BEFORE YOU RIDE THE MOTORCYCLE.

As you read this manual, you will find information that is preceded by a **NOTICE** symbol. This information is intended to help you avoid damage to your motorcycle, other property, or the environment.

When service is required, remember that your Honda dealer knows your motorcycle best. If you have the required mechanical "know-how" and tools, your dealer can supply you with an official Honda Shop Manual to help you perform many maintenance and repair tasks.

Pleasant riding, and thank you for choosing a Honda !

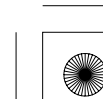



10/11/05 11:19:10 32KYJE00_005



- The following code in this manual indicates the country.
- The illustrations herein are based on the CBR250RA type.

MA	Malaysia
----	----------

- The specifications may vary with each locale.

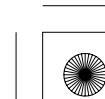
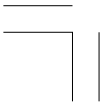



A FEW WORDS ABOUT SAFETY

Your safety, and the safety of others, is very important. And operating this motorcycle safely is an important responsibility.

To help you make informed decisions about safety, we have provided operating procedures and other information on labels and in this manual. This information alerts you to potential hazards that could hurt you or others.

Of course, it is not practical or possible to warn you about all hazards associated with operating or maintaining a motorcycle. You must use your own good judgment.

You will find important safety information in a variety of forms, including:

- **Safety Labels** — on the motorcycle.
- **Safety Messages** — preceded by a safety alert symbol  and one of three signal words: **DANGER**, **WARNING**, or **CAUTION**.

These signal words mean:

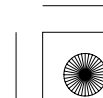



⚠ DANGER

You WILL be KILLED or SERIOUSLY HURT if you don't follow instructions.

⚠ WARNING

You CAN be KILLED or SERIOUSLY HURT if you don't follow instructions.

⚠ CAUTION

You CAN be HURT if you don't follow instructions.

- **Safety Headings** — such as Important Safety Reminders or Important Safety Precautions.
- **Safety Section** — such as Motorcycle Safety.
- **Instructions** — how to use this motorcycle correctly and safely.

This entire manual is filled with important safety information — please read it carefully.

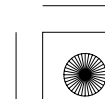



OPERATION

page

1 MOTORCYCLE SAFETY

- 1 IMPORTANT SAFETY INFORMATION
- 2 PROTECTIVE APPAREL
- 4 LOAD LIMITS AND GUIDELINES
- 8 IMAGE LABELS

page

43 ESSENTIAL INDIVIDUAL COMPONENTS

- 43 IGNITION SWITCH
- 44 RIGHT HANDLEBAR CONTROLS
- 45 LEFT HANDLEBAR CONTROLS

10 PARTS LOCATION

- 13 INSTRUMENTS AND INDICATORS

26 MAJOR COMPONENTS

(Information you need to operate this motorcycle)

- 26 SUSPENSION
- 27 BRAKES
- 29 CLUTCH
- 31 COOLANT
- 33 FUEL
- 36 ENGINE OIL
- 37 TUBELESS TYRES

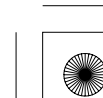



page

46 FEATURES

(Not required for operation)

- 46 STEERING LOCK
- 47 SEAT
- 49 HELMET HOLDER
- 50 DOCUMENT BAG
- 51 STORAGE COMPARTMENT FOR
U-SHAPED ANTI-THEFT LOCK
- 52 RIGHT UNDER COWL
- 54 HEADLIGHT AIM VERTICAL
ADJUSTMENT



page

55 OPERATION

- 55 PRE-RIDE INSPECTION
- 56 STARTING THE ENGINE
- 59 RUNNING-IN
- 60 RIDING
- 62 BRAKING
- 65 PARKING
- 66 ANTI-THEFT TIPS

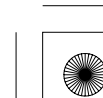
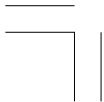



MAINTENANCE

page

67 MAINTENANCE

- 67 THE IMPORTANCE OF MAINTENANCE
- 68 MAINTENANCE SAFETY
- 69 SAFETY PRECAUTIONS
- 70 MAINTENANCE SCHEDULE
- 73 TOOL KIT
- 74 SERIAL NUMBERS
- 76 AIR CLEANER
- 78 CRANKCASE BREATHER
- 79 ENGINE OIL
- 84 THROTTLE OPERATION
- 85 COOLANT
- 86 DRIVE CHAIN
- 92 DRIVE CHAIN SLIDER
- 93 FRONT AND REAR SUSPENSION INSPECTION
- 94 SIDE STAND
- 95 WHEEL REMOVAL
- 100 BRAKE PAD WEAR

page

- 102 BATTERY
- 104 FUSE REPLACEMENT
- 108 BRAKELIGHT SWITCH ADJUSTMENT
- 109 BULB REPLACEMENT

115 CLEANING

119 STORAGE GUIDE

- 119 STORAGE
- 121 REMOVAL FROM STORAGE

122 TAKING CARE OF THE UNEXPECTED

123 SPECIFICATIONS

127 CATALYTIC CONVERTER

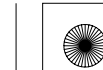



MOTORCYCLE SAFETY

IMPORTANT SAFETY INFORMATION

Your motorcycle can provide many years of service and pleasure — if you take responsibility for your own safety and understand the challenges that you can meet on the road.

There is much that you can do to protect yourself when you ride. You'll find many helpful recommendations throughout this manual. Following are a few that we consider to be most important.

Always Wear a Helmet

It's a proven fact: helmets significantly reduce the number and severity of head injuries. So always wear an approved motorcycle helmet and make sure your passenger does the same. We also recommend that you wear eye protection, sturdy boots, gloves, and other protective gear (page 2).

Make Yourself Easy to See

Some drivers do not see motorcycles because they are not looking for them. To make yourself more visible, wear bright reflective clothing, position yourself so other drivers can see you, signal before turning or changing lanes, and use your horn when it will help others notice you.

Ride Within Your Limits

Pushing the limits is another major cause of motorcycle crashes. Never ride beyond your personal abilities or faster than conditions warrant. Remember that alcohol, drugs, fatigue and inattention can significantly reduce your ability to make good judgements and ride safely.

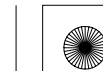



Don't Drink and Ride

Alcohol and riding don't mix. Even one drink can reduce your ability to respond to changing conditions, and your reaction time gets worse with every additional drink. So don't drink and ride, and don't let your friends drink and ride either.

Keep Your Bike in Safe Condition

For safe riding, it's important to inspect your motorcycle before every ride and perform all recommended maintenance. Never exceed load limits, and only use accessories that have been approved by Honda for this motorcycle. See page 4 for more details.

PROTECTIVE APPAREL

For your safety, we strongly recommend that you always wear an approved motorcycle helmet, eye protection, boots, gloves, trousers, and a long-sleeved shirt or jacket whenever you ride. Although complete protection is not possible, wearing proper gear can reduce the chance of injury when you ride.

Following are suggestions to help you choose proper gear.

⚠ WARNING

Not wearing a helmet increases the chance of serious injury or death in a crash.

Be sure you and your passenger always wear a helmet, eye protection and other protective apparel when you ride.

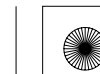



Helmets and Eye Protection

Your helmet is your most important piece of riding gear because it offers the best protection against head injuries. A helmet should fit your head comfortably and securely. A bright-coloured helmet can make you more noticeable in traffic, as can reflective strips.

An open-face helmet offers some protection, but a full-face helmet offers more. Always wear a face shield or goggles to protect your eyes and help your vision.

Additional Riding Gear

In addition to a helmet and eye protection, we also recommend:

- Sturdy boots with non-slip soles to help protect your feet and ankles.
- Leather gloves to keep your hands warm and help prevent blisters, cuts, burns and bruises.
- A motorcycle riding suit or jacket for comfort as well as protection. Bright-coloured and reflective clothing can help make you more noticeable in traffic. Be sure to avoid loose clothes that could get caught on any part of your motorcycle.

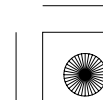
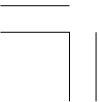



LOAD LIMITS AND GUIDELINES

Your motorcycle has been designed to carry you and one passenger. When you carry a passenger, you may feel some difference during acceleration and braking. But so long as you keep your motorcycle well-maintained, with good tyres and brakes, you can safely carry loads within the given limits and guidelines.



However, exceeding the weight limit or carrying an unbalanced load can seriously affect your motorcycle's handling, braking and stability. Non-Honda accessories, improper modifications, and poor maintenance can also reduce your safety margin.

The following pages give more specific information on loading, accessories and modifications.

4

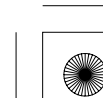
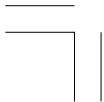

Loading

How much weight you put on your motorcycle, and how you load it, are important to your safety. Anytime you ride with a passenger or cargo you should be aware of the following information.

WARNING

Overloading or improper loading can cause a crash and you can be seriously hurt or killed.

Follow all load limits and other loading guidelines in this manual.





Load Limits

Following are the load limits for your motorcycle:

Maximum weight capacity:

140 kg (309 lb)

Includes the weight of the rider, passenger, all cargo and all accessories



Loading Guidelines

Your motorcycle is primarily intended for transporting you and a passenger. You may wish to secure a jacket or other small items to the seat when you are not riding with a passenger.

If you wish to carry more cargo, check with your dealer for advice, and be sure to read the information regarding accessories on page 6 .

Improperly loading your motorcycle can affect its stability and handling. Even if your motorcycle is properly loaded, you should ride at reduced speeds whenever carrying cargo.

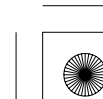
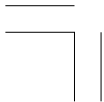



Follow these guidelines whenever you carry a passenger or cargo:

- Check that both tyres are properly inflated (page 37).
- To prevent loose items from creating a hazard, make sure that all cargo is securely tied down before you ride away.
- Place cargo weight as close to the center of the motorcycle as possible.
- Balance cargo weight evenly on both sides.



Accessories and Modifications

Modifying your motorcycle or using non-Honda accessories can make your motorcycle unsafe. Before you consider making any modifications or adding an accessory, be sure to read the following information.

WARNING

Improper accessories or modifications can cause a crash in which you can be seriously hurt or killed.

Follow all instructions in this owner's manual regarding accessories and modifications.

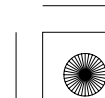



Accessories

We strongly recommend that you use only Honda Genuine Accessories that have been specifically designed and tested for your motorcycle. Because Honda cannot test all other accessories, you must be personally responsible for proper selection, installation and use of non-Honda accessories. Check with your dealer for assistance and always follow these guidelines:

- Make sure the accessory does not obscure any lights, reduce ground clearance and banking angle, limit suspension travel or steering travel, alter your riding position or interfere with operating any controls.
- Be sure electrical equipment does not exceed the motorcycle's electrical system capacity (page 126). A blown fuse can cause a loss of lights or engine power.

- Do not pull a trailer or sidecar with your motorcycle. This motorcycle was not designed for these attachments, and their use can seriously impair your motorcycle's handling.

Modifications

We strongly advise you not to remove any original equipment or modify your motorcycle in any way that would change its design or operation. Such changes could seriously impair your motorcycle's handling, stability and braking, making it unsafe to ride.

Removing or modifying your lights, mufflers, emission control system or other equipment can also make your motorcycle illegal.

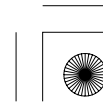
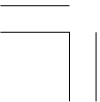

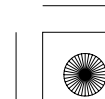

IMAGE LABELS

The following pages describe the label meanings. Some labels warn you of potential hazards that could cause serious injury. Others provide important safety information. Read this information carefully and don't remove the labels.

There is a specific symbol on each label. The meanings of each symbol and label are as follows.

If a label comes off or becomes hard to read, contact your dealer for a replacement.





	Read instructions contained in Owner's Manual carefully.
--	--

	<p>DRIVE CHAIN LABEL Keep chain adjusted and lubricated. 20 – 30 mm (0.8 – 1.2 in) Freeplay</p>
	<p>TYRE INFORMATION LABEL Cold tyre pressure: [Driver only] Front 200 kPa (2.00 kgf/cm², 29 psi) Rear 200 kPa (2.00 kgf/cm², 29 psi) [Driver and passenger] Front 200 kPa (2.00 kgf/cm², 29 psi) Rear 225 kPa (2.25 kgf/cm², 33 psi) Tyre size: Front 110/70 – 17M/C 54S Rear 140/70 – 17M/C 66S Tyre brand: IRC Front RX – 01FD Rear RX – 01RZ</p>

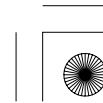



PARTS LOCATION

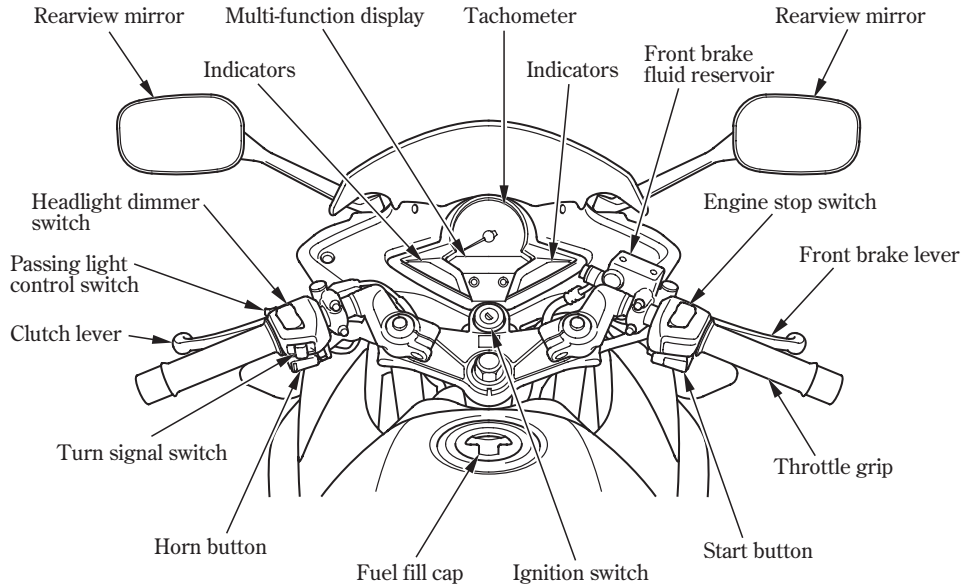

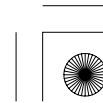
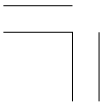
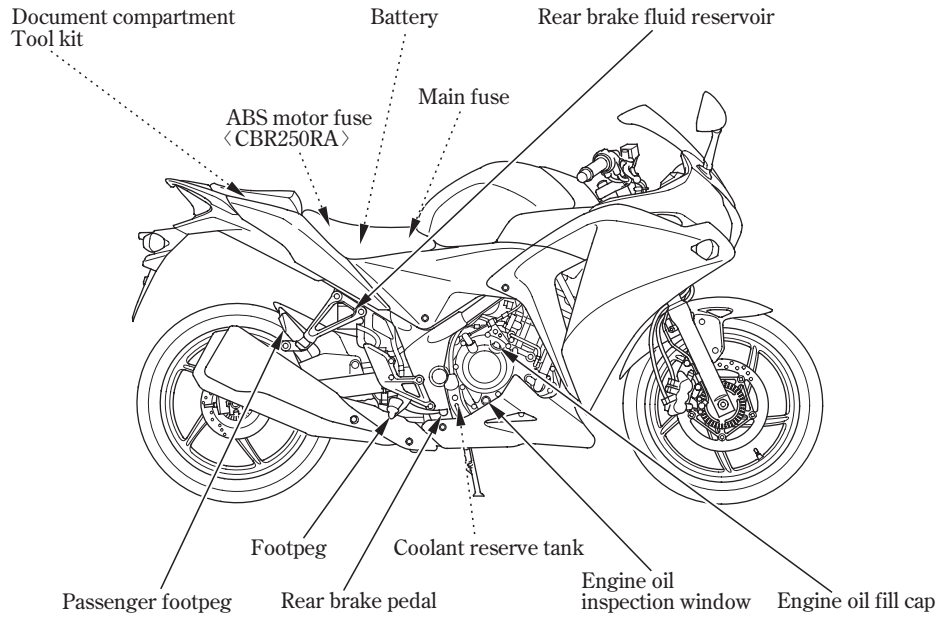

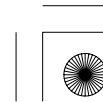
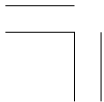
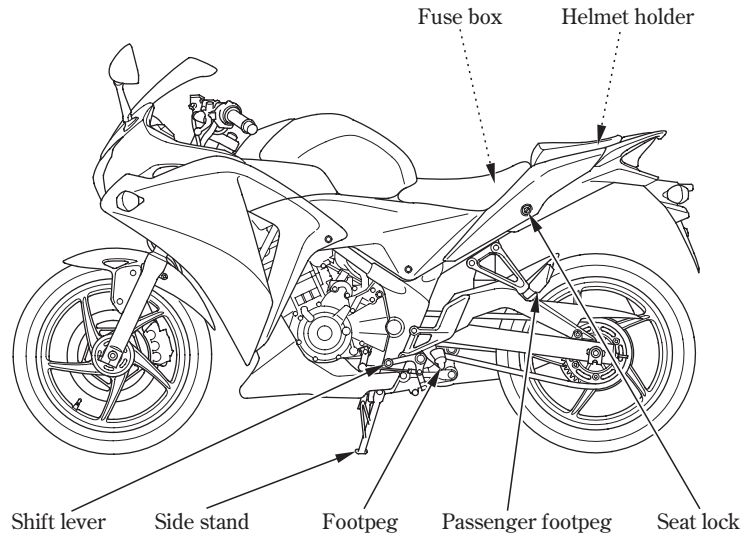



INSTRUMENTS AND INDICATORS

The indicators are contained in the instrument panel. Their functions are described in the tables on the following pages.

- (1) Multi-function display
- (2) Tachometer
- (3) Tachometer red zone
- (4) Neutral indicator
- (5) Right turn signal indicator
- (6) High beam indicator
- (7) RESET button
- (8) MODE button
- (9) PGM-FI malfunction indicator lamp (MIL)
- (10) Left turn signal indicator
- (11) Anti-lock Brake System (ABS) indicator (CBR250RA)

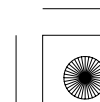
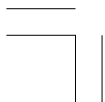
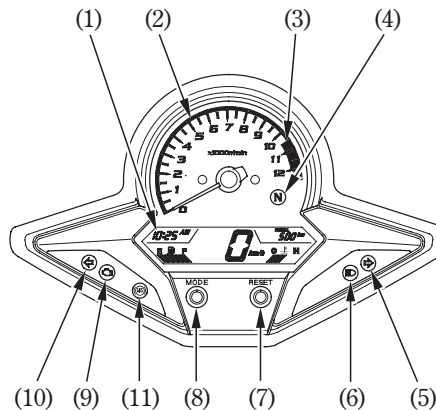



(Ref.No.) Description	Function
(1) Multi-function display	The display includes the following functions; This display shows the initial display (page 17).
Speedometer	Shows riding speed (page 19).
Odometer	Shows accumulated mileage (page 19).
Tripmeter	Shows mileage per trip (page 19).
Coolant temperature gauge	Shows coolant temperature (page 20).
Fuel gauge	Shows approximate fuel supply available (page 22).
Digital clock	Shows hour and minute (page 24).
(2) Tachometer	Shows engine revolutions per minute. The tachometer needle will swing to the maximum scale on the dial once when the ignition switch is turned ON.

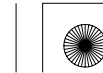



(Ref.No.) Description	Function
(3) Tachometer red zone	Never allow the tachometer needle to enter the red zone, even after the engine has been broken in. NOTICE Running the engine beyond recommended maximum engine speed (the beginning of the tachometer red zone) can damage the engine.
(4) Neutral indicator (green)	Lights when the transmission is in neutral.
(5) Right turn signal indicator (green)	Flashes when the right turn signal operates.
(6) High beam indicator (blue)	Lights when the headlight is on high beam.
(7) RESET button	This button is used to reset the tripmeter (page 19) or to set the digital clock (page 24).

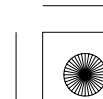



(Ref.No.) Description	Function
(8) MODE button	This button is used to select the odometer and tripmeter (page 19) or to set the digital clock (page 24).
(9) PGM-FI malfunction indicator lamp (MIL) (amber)	Lights when there is any abnormality in the PGM-FI (Programmed Fuel Injection) system. Should also light for a few seconds and then go off when the ignition switch is turned ON. If it comes on at any other time, reduce speed and take the motorcycle to your dealer as soon as possible.
(10) Left turn signal indicator (green)	Flashes when the left turn signal operates.
(11) Anti-lock Brake System (ABS) indicator (amber) (CBR250RA)	This indicator normally comes on when the ignition switch is turned ON, and goes off after you ride the motorcycle at speed above 10 km/h (6 mph). If there is a problem with the Anti-lock Brake System, this indicator flashes and remains on (page 64).

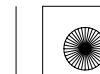



Initial Display

When the ignition switch is turned ON, the multi-function display (1) will temporarily show all the modes and digital segments. Thereafter, the speedometer (2) starts a countdown to 0 km/h so that you can make sure the liquid crystal display is functioning properly.

Digital clock (3) will reset if the battery is disconnected.

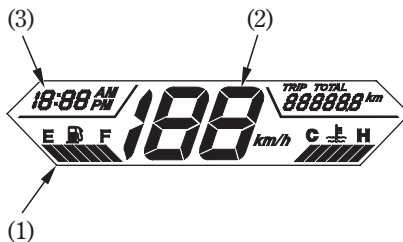

- (1) Multi-function display
- (2) Speedometer
- (3) Digital clock

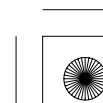
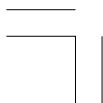



Multi-function Display

Multi-function display (1) includes the following functions:

- Speedometer
- Odometer/Tripmeter
- Coolant temperature gauge
- Fuel gauge
- Digital clock

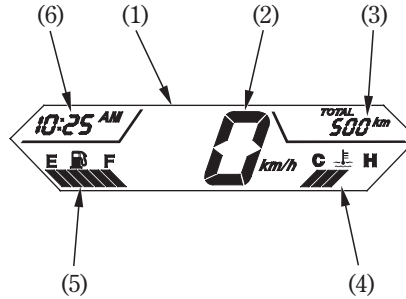

- (1) Multi-function display
- (2) Speedometer
- (3) Odometer/Tripmeter
- (4) Coolant temperature gauge
- (5) Fuel gauge
- (6) Digital clock

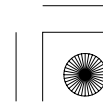
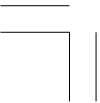

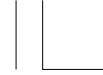

Speedometer
Shows riding speed.

Odometer/Tripmeter

The odometer (2) shows accumulated mileage.

The tripmeter (3) shows mileage per trip.
Push the MODE button (4) to select the odometer and tripmeter.

To reset the tripmeter, push and hold the RESET button (5) for more than 2 seconds when the display is in the tripmeter.

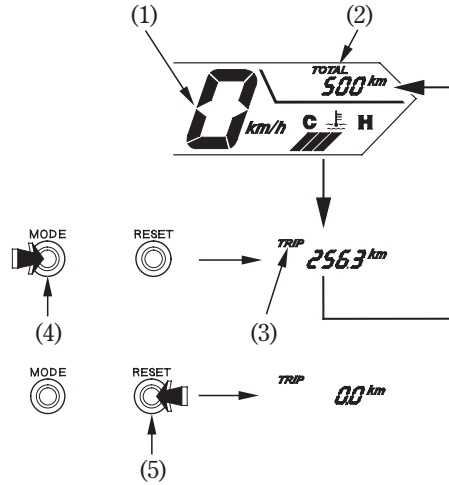

- (1) Speedometer
- (2) Odometer
- (3) Tripmeter
- (4) MODE button
- (5) RESET button

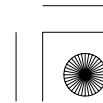
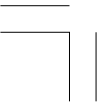



Coolant Temperature Gauge

The coolant temperature gauge (1) shows coolant temperature.

The normal operating temperature range is within the section between the segment C (2) and segment H (3).

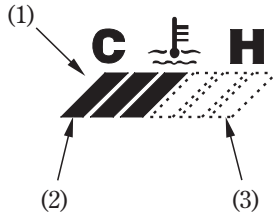

- (1) Coolant temperature gauge
- (2) Segment C
- (3) Segment H

Overheating Message:

When the coolant is over specified temperature, the segment H flashes.

If this occurs, stop the engine and check the reserve tank coolant level. Read pages 31 – 32 and do not ride the motorcycle until the problem has been corrected.

NOTICE

Exceeding maximum running temperature may cause serious engine damage.

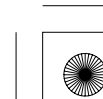
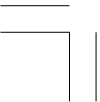
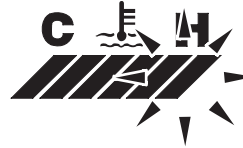



Coolant Temperature Gauge Failure

Indication:

If the cooling system has an error, the coolant temperature gauge will flash or will turn off.

If this occurs, see your dealer as soon as possible.

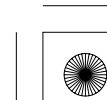
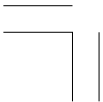



Fuel Gauge

The fuel gauge liquid crystal display (1) shows the approximate available fuel in a graduated display. When all segments up to F (2) are on, the fuel tank is full.

The fuel tank capacity is:

13.0 ℓ (3.43 US gal , 2.86 Imp gal)

When there is only one segment (3) left, fuel will be low and you should refuel as soon as possible.

The amount of fuel left in the tank with the vehicle set upright is approximately:

2.5 ℓ (0.66 US gal , 0.55 Imp gal)

This segment flashes when the fuel decreases further.

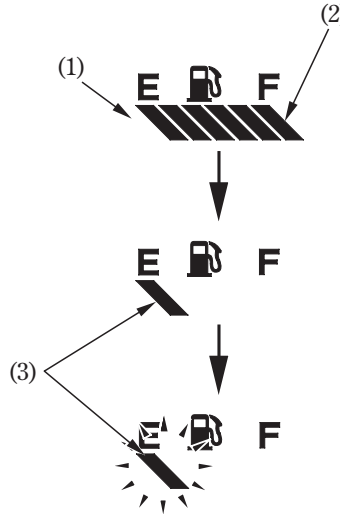

- (1) Fuel gauge
- (2) Segment F
- (3) Segment E

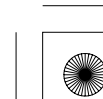
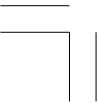

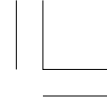

Fuel Gauge Failure Indication:

If the fuel system has an error, the fuel gauge will flash.

If this occurs, see your dealer as soon as possible.

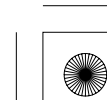
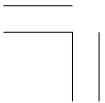
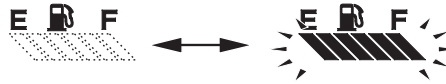



Digital Clock

Shows hour and minute. To set the digital clock, proceed as follows:

1. Turn the ignition switch ON.
2. Push and hold both the MODE button (2) and RESET button (3) for more than 2 seconds. The clock will be set in the adjust mode with the hour display flashing.

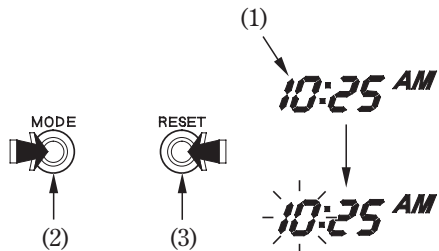

- (1) Digital clock
- (2) MODE button
- (3) RESET button

3. To set the hour, push the RESET button until the desired hour and AM/PM are displayed.
 - The time is advanced by one hour, each time the button is pushed.
 - The time advances fast when the button is pushed and held.

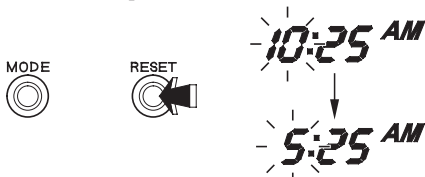

4. Push the MODE button. The minute display will start flashing.

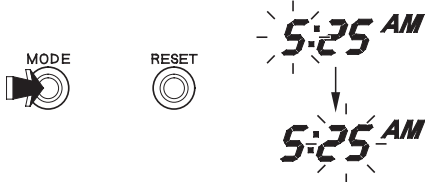



5. To set the minute, push the RESET button until the desired minute. The minute display will return to "00" when "60" is reached without affecting the hour display.

- The time advances by one minute, each time the button is pushed.
- The time advances fast when the button is pushed and held.

6. To end the adjustment, push the MODE button or turn the ignition switch OFF. The display will stop flashing automatically and the adjustment will be cancelled if the button is not pushed for about 30 seconds.

The clock will be reset AM 1:00 if the battery is disconnected.

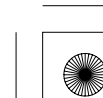
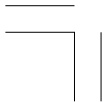



MAJOR COMPONENTS (Information you need to operate this motorcycle)

SUSPENSION

The shock absorber (1) has 5 adjustment positions for different load or riding conditions.

Use a pin spanner (2) and extension bar (3) to adjust the rear shocks.

Always adjust the shock absorber position in sequence (1-2-3-4-5 or 5-4-3-2-1).

Attempting to adjust directly from 1 to 5 or 5 to 1 may damage the shock absorber.

Position 1 is for light loads and smooth road conditions. Positions 3 to 5 increase spring preload for a stiffer rear suspension, and can be used when the motorcycle is heavily loaded.

Standard position: 2

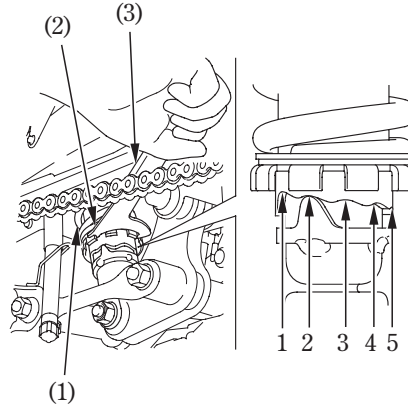

- (1) Shock absorber
- (2) Pin spanner
- (3) Extension bar

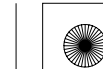



BRAKES

Both the front and rear brakes are the hydraulic disc types.

As the brake pads wear, the brake fluid level drops.

There are no adjustments to perform, but fluid level and pad wear must be inspected periodically. The system must be inspected frequently to ensure there are no fluid leaks. If the brake lever or pedal free travel becomes excessive and the brake pads are not worn beyond the recommended limit (page 100), there is probably air in the brake system and it must be bled. See your dealer for this service.

Front Brake Fluid Level:

With the motorcycle in an upright position, check the fluid level. It should be above the LOWER level mark (1). If the level is at or below the LOWER level mark, check the brake pads for wear (page 100).

Worn pads should be replaced. If the pads are not worn, have your brake system inspected for leaks.

The recommended brake fluid is Honda DOT 3 or DOT 4 brake fluid from a sealed container, or an equivalent.

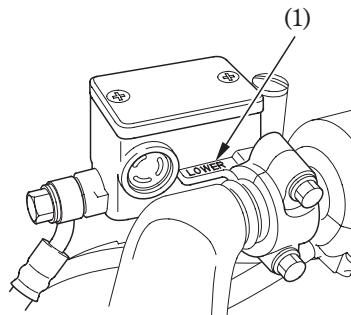

(1) LOWER level mark

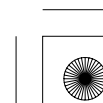



Rear Brake Fluid Level:

With the motorcycle in an upright position, check the fluid level. It should be between the UPPER (1) and LOWER (2) level marks. If the level is at or below the LOWER level mark, check the brake pads for wear (page101).

Worn pads should be replaced. If the pads are not worn, have your brake system inspected for leaks.

The recommended brake fluid is Honda DOT 3 or DOT 4 brake fluid from a sealed container, or an equivalent.

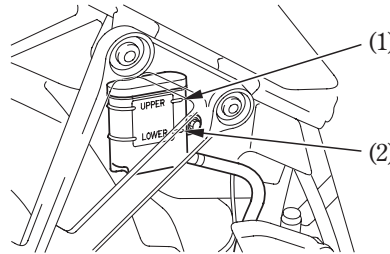

- (1) UPPER level mark
- (2) LOWER level mark

Other Checks:

Make sure there are no fluid leaks. Check for deterioration or cracks in the hoses and fittings.

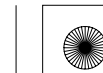



CLUTCH

Clutch adjustment may be required if the motorcycle stalls when shifting into gear or tends to creep; or if the clutch slips, causing acceleration to lag behind engine speed. Minor adjustments can be made with the clutch cable adjuster (1) at the clutch lever (2).

Normal clutch lever freeplay is:
10–20 mm (0.4–0.8 in)

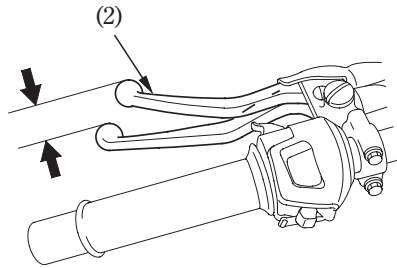

(2) Clutch lever

1. Pull back the rubber dust cover (3).
2. Loosen the lock nut (4) and turn the clutch cable adjuster. Tighten the lock nut and check the adjustment.
3. If the adjuster is threaded out near its limit or if the correct freeplay cannot be obtained, using the clutch cable adjuster, loosen the lock nut and turn in the clutch cable adjuster completely. Tighten the lock nut and install the rubber dust cover.

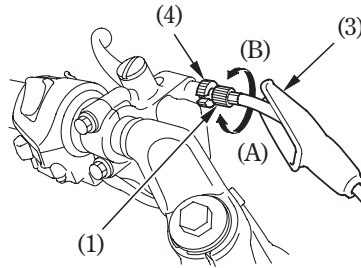

- | | |
|---------------------------|-----------------------|
| (1) Clutch cable adjuster | (A) Increase freeplay |
| (3) Rubber dust cover | (B) Decrease freeplay |
| (4) Lock nut | |





4. Loosen the lock nut (5) at the lower end of the cable. Turn the adjusting nut (6) to obtain the specified freeplay. Tighten the lock nut and check the adjustment.
5. Start the engine, pull in the clutch lever and shift into gear. Make sure the engine does not stall and the motorcycle does not creep. Gradually release the clutch lever and open the throttle. The motorcycle should begin to move smoothly and accelerate gradually.

If proper adjustment cannot be obtained or the clutch does not work correctly, see your dealer.

Other Checks:

Check the clutch cable for kinks or signs of wear that could cause sticking or failure. Lubricate the clutch cable with a commercially available cable lubricant to prevent premature wear and corrosion.

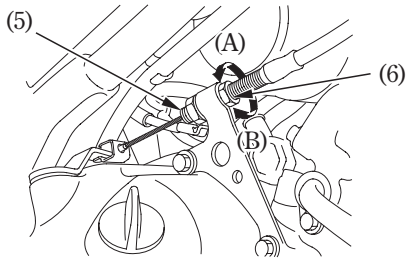

- | | |
|-------------------|-----------------------|
| (5) Lock nut | (A) Increase freeplay |
| (6) Adjusting nut | (B) Decrease freeplay |





COOLANT

Coolant Recommendation

Use only genuine HONDA PRE-MIX COOLANT containing corrosion inhibitors, specifically recommended for aluminum engines when adding or replacing the coolant.

Genuine HONDA PRE-MIX COOLANT is excellent at preventing corrosion and overheating. The effects last for up to 2 years.

The coolant should be inspected and replaced properly by following the maintenance schedule (page 71).

Use any genuine HONDA PRE-MIX COOLANT without diluting with water.

NOTICE

Do not use non-ethylene glycol coolant, tap water, nor mineral water when adding or replacing the coolant.

Use of improper coolant may cause damage, such as corrossions in the engine, blockage of the cooling passage or radiator and premature wear of the water pump seal.

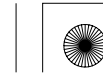



Inspection

The reserve tank is located under the right side of the crankcase.

Check the coolant level in the reserve tank (1) while the engine is at the normal operating temperature with the motorcycle in an upright position. If the coolant level is below the LOWER level mark (2), remove the screw (3). Pull out the prong (4) from the hole (5). Remove the cover (6) and reserver tank cap (7). Add coolant mixture until it reaches the UPPER level mark (8). Always add coolant to the reserve tank. Do not attempt to add coolant by removing the radiator cap.

If the reserve tank is empty, or if coolant loss is excessive, check for leaks and see your dealer for repair.

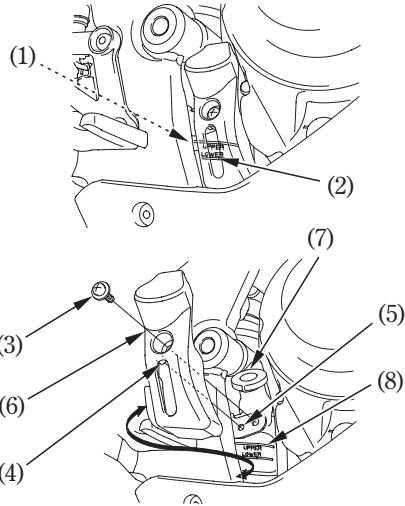

- | | |
|----------------------|-----------------------|
| (1) Reserve tank | (5) Hole |
| (2) LOWER level mark | (6) Cover |
| (3) Screw | (7) Reserver tank cap |
| (4) Prong | (8) UPPER level mark |





FUEL Fuel Tank

The fuel tank capacity including the reserve supply is:

13.0 l (3.43 US gal , 2.86 Imp gal)

To open the fuel fill cap (1), open the lock cover (2), insert the ignition key (3) and turn it clockwise. The fuel fill cap will pop up and can be lifted off.

Do not overfill the tank. There should be no fuel above the level plate (4).

After refueling, to close the fuel fill cap, align the latch in the cap with the slot in the filler neck. Push the fuel fill cap into the filler neck until it snaps closed and locks. Remove the key and close the lock cover.



WARNING

Petrol is highly flammable and explosive. You can be burned or seriously injured when handling fuel.

- Stop the engine and keep heat, sparks, and flame away.
- Refuel only outdoors.
- Wipe up spills immediately.

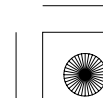
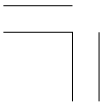

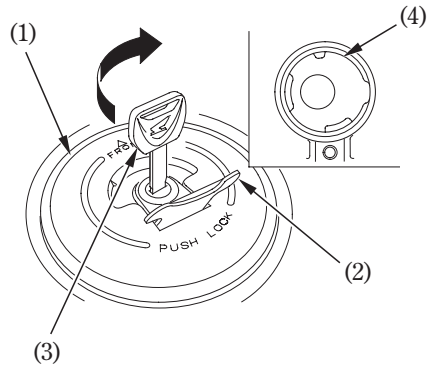

(1) Fuel fill cap
(2) Lock cover

(3) Ignition key
(4) Level plate

Use unleaded petrol with a research octane number of 91 or higher. The use of leaded petrol will cause premature damage to the catalytic converter.

NOTICE

If “spark knock” or “pinking” occurs at a steady engine speed under normal load, change brands of petrol. If spark knock or pinking persists, consult your dealer. Failure to do so is considered misuse, and damage caused by misuse is not covered by Honda’s Limited Warranty.

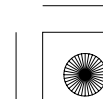



Petrol Containing Alcohol

If you decide to use a petrol containing alcohol (gasohol), be sure it's octane rating is at least as high as that recommended by Honda. There are two types of "gasohol": one containing ethanol, and the other containing methanol. Do not use petrol that contains more than 10 % ethanol. Do not use petrol containing methanol (methyl or wood alcohol) that does not also contain cosolvents and corrosion inhibitors for methanol. Never use petrol containing more than 5 % methanol, even if it has cosolvents and corrosion inhibitors.

The use of petrol containing more than 10 % ethanol (or more than 5 % methanol) may:

- Damage the painting of the fuel tank.
- Damage the rubber tubes of the fuel line.
- Cause corrosion of the fuel tank.
- Cause poor drivability.

Before buying fuel from an unfamiliar station, try to find out if the fuel contains alcohol. If it does, confirm the type and percentage of alcohol used. If you notice any undesirable operating symptoms while using a petrol that contains alcohol, or one that you think contains alcohol, switch to a petrol that you know does not contain alcohol.

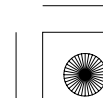



ENGINE OIL

Engine Oil Level Check

Check the engine oil level each day before riding the motorcycle.

The level must be maintained between the upper (1) and lower (2) level marks in the inspection window (3).

1. Start the engine and let it idle for 3–5 minutes.
2. Stop the engine and hold the motorcycle in an upright position on firm, level ground.
3. After 2–3 minutes, check that the oil level is between the upper and lower level marks in the inspection window.
4. If required, remove the oil fill cap (4) and add the specified oil (page 79) up to the upper level mark. Do not overfill.

5. Reinstall the oil fill cap. Check for oil leaks.

NOTICE

Running the engine with insufficient oil pressure may cause serious engine damage.

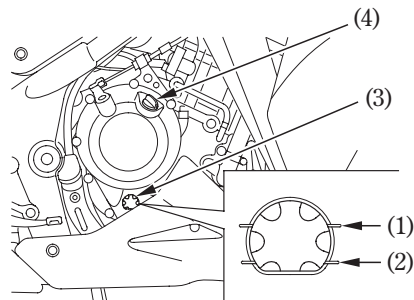

- | | |
|----------------------|-----------------------|
| (1) Upper level mark | (3) Inspection window |
| (2) Lower level mark | (4) Oil fill cap |

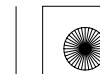

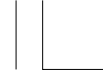

TUBELESS TYRES

To safely operate your motorcycle, your tyres must be the proper type and size, in good condition with adequate tread, and correctly inflated for the load you are carrying. The following pages give more detailed information on how and when to check your air pressure, how to inspect your tyres for damage, and what to do when your tyres need to be repaired or replaced.

WARNING

Using tyres that are excessively worn or improperly inflated can cause a crash in which you can be seriously hurt or killed.

Follow all instructions in this owner's manual regarding tyre inflation and maintenance.

Air Pressure

Keeping your tyres properly inflated provides the best combination of handling, tread life and riding comfort. Generally, underinflated tyres wear unevenly, adversely affect handling, and are more likely to fail from being overheated. Overinflated tyres make your motorcycle ride harshly, are more prone to damage from road hazards, and wear unevenly.

We recommend that you visually check your tyres before every ride and use a gauge to measure air pressure at least once a month or any time you think the tyres might be low.

Tubeless tyres have some self-sealing ability if they are punctured. However, because leakage is often very slow, you should look closely for punctures whenever a tyre is not fully inflated.

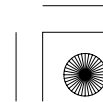
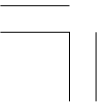



Always check air pressure when your tyres are “cold” – when the motorcycle has been parked for at least three hours. If you check air pressure when your tyres are “warm” – when the motorcycle has been ridden for even a few miles – the readings will be higher than if the tyres were “cold”. This is normal, so do not let air out of the tyres to match the recommended cold air pressures given below. If you do, the tyres will be underinflated.

The recommended “cold” tyre pressures are:

kPa (kgf/cm ² , psi)		
Driver only	Front	200 (2.00 , 29)
	Rear	200 (2.00 , 29)
Driver and one passenger	Front	200 (2.00 , 29)
	Rear	225 (2.25 , 33)

Inspection

Whenever you check the tyre pressures, you should also examine the tyre treads and sidewalls for wear, damage, and foreign objects:

Look for:

- Bumps or bulges in the side of the tyre or the tread. Replace the tyre if you find any bumps or bulges.
- Cuts, splits or cracks in the tyre. Replace the tyre if you can see fabric or cord.
- Excessive tread wear.

Also, if you hit a pothole or hard object, pull to the side of the road as soon as you can safely and carefully inspect the tyres for damage.

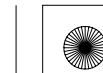



Tread Wear

Replace tyres before tread depth at the center of the tyre reaches the following limit:

Minimum tread depth	
Front:	1.5 mm (0.06 in)
Rear:	2.0 mm (0.08 in)

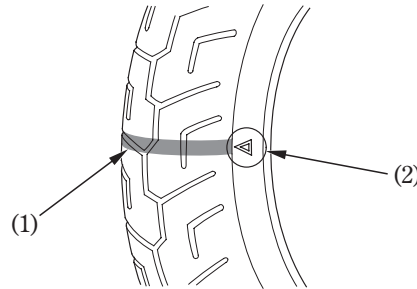

- (1) Wear indicator
- (2) Wear indicator location mark

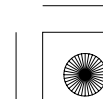
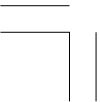



Tyre Repair

If a tyre is punctured or damaged, you should replace it, not repair it. As discussed below, a tyre that is repaired, either temporarily or permanently, will have lower speed and performance limits than a new tyre.

A temporary repair, such as an external tubeless tyre plug, may not be safe for normal speeds and riding conditions. If a temporary or emergency repair is made to a tyre, you should ride slowly and cautiously to a dealer and have the tyre replaced. If possible, you should not carry a passenger or cargo until a new tyre is installed.

Even if a tyre is professionally repaired with a permanent internal patch plug, it will not be as good as a new tyre. You should not exceed 80 km/h (50 mph) for the first 24 hours, or 120 km/h (75 mph) at any time thereafter. In addition, you may not be able to safely carry as much weight as with a new tyre. Therefore, we strongly recommend that you replace a damaged tyre. If you choose to have a tyre repaired, be sure the wheel is balanced before you ride.

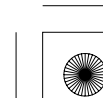
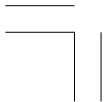



Tyre Replacement

The tyres that came on your motorcycle were designed to match the performance capabilities of your motorcycle and provide the best combination of handling, braking, durability and comfort.

WARNING

Installing improper tyres on your motorcycle can affect handling and stability. This can cause a crash in which you can be seriously hurt or killed.

Always use the size and type of tyres recommended in this owner's manual.

The recommended tyres for your motorcycle are:

Front: 110/70-17M/C 54S
IRC
RX-01FD

Rear: 140/70-17M/C 66S
IRC
RX-01RZ

Type: bias-ply, tubeless

Whenever you replace a tyre, use one that is equivalent to the original and be sure the wheel is balanced after the new tyre is installed.

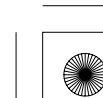
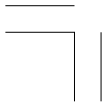



Important Safety Reminders

- Do not install a tube inside a tubeless tyre on this motorcycle. Excessive heat build-up can cause the tube to burst.
- Use only tubeless tyres on this motorcycle. The rims are designed for tubeless tyres, and during hard acceleration or braking, a tube-type tyre could slip on the rim and cause the tyre to rapidly deflate.

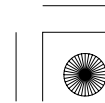
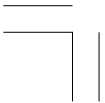



ESSENTIAL INDIVIDUAL COMPONENTS

IGNITION SWITCH

The ignition switch (1) is below the instrument panel.

The headlight, position lights, taillight and license light will come on whenever you turn the ignition switch ON. If your motorcycle is stopped with the ignition switch ON and the engine is not running, the headlight, position lights, taillight and license light will still be on, resulting in battery discharge.

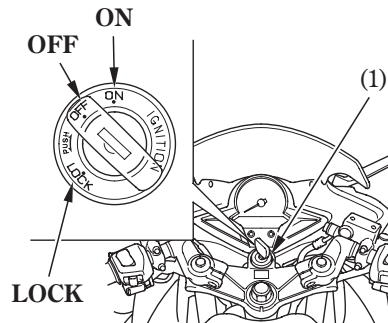

(1) Ignition switch



Key Position	Function	Key Removal
LOCK (Steering lock)	Steering is locked. Engine and lights cannot be operated.	Key can be removed
OFF	Engine and lights cannot be operated.	Key can be removed
ON	Engine and lights can be operated.	Key cannot be removed





RIGHT HANDLEBAR CONTROLS

Engine Stop Switch

The engine stop switch (1) is next to the throttle grip. When the switch is in the  (RUN) position, the engine will operate. When the switch is in the  (OFF) position, the engine will not operate. This switch is intended primarily as an emergency switch and should normally remain in the  (RUN) position.

If your motorcycle is stopped with the ignition switch ON and the engine stop switch  (OFF), the headlight, position lights, taillight and license light will still be on, resulting in battery discharge.

Start Button

The start button (2) is below the engine stop switch.

The start button is used for starting the engine. Pushing the button in starts the engine. See Starting Procedure, page 57 .

When the start button is pushed, the starter motor will crank the engine and the headlight, position lights, taillight and license light will stay on.

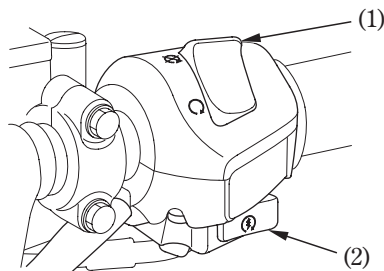

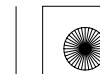

(1) Engine stop switch (2) Start button

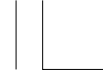



LEFT HANDLEBAR CONTROLS



Headlight Dimmer Switch (1)

Push the headlight dimmer switch to  (HI) to select high beam or to  (LO) to select low beam.

Passing Light Control Switch (2)

When this switch is pressed, the headlight flashes on to signal approaching cars or when passing.

Turn Signal Switch (3)

Move to  (L) to signal a left turn,  (R) to signal a right turn. Press to turn signal off.

Horn Button (4)

Press the button to sound the horn.

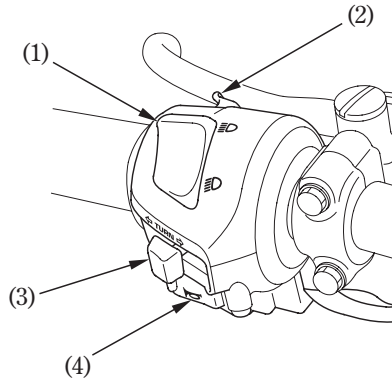

- (1) Headlight dimmer switch
- (2) Passing light control switch
- (3) Turn signal switch
- (4) Horn button

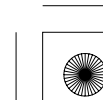
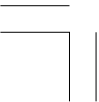



FEATURES (Not required for operation)

STEERING LOCK

To lock the steering, turn the handlebar all the way to the left, turn the ignition key (1) to LOCK while pushing in. Remove the key. To unlock the steering, turn the key to OFF.

Do not turn the key to LOCK while riding the motorcycle; loss of vehicle control will result.

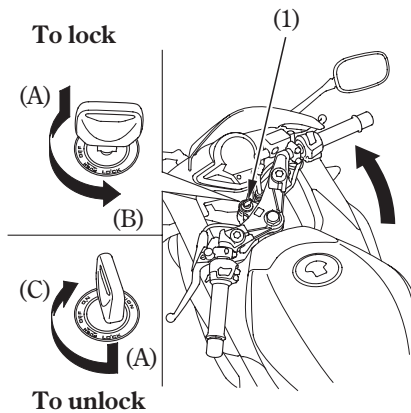

(1) Ignition key

(A) Push in
(B) Turn to LOCK
(C) Turn to OFF





SEAT

Rear seat

To remove the rear seat (1), insert the ignition key (2) into the seat lock (3). Turn it clockwise, then pull the rear seat up and back.

To install the rear seat, insert the prongs (4) into the rear stays (5) on the frame, and then push down on the rear of the rear seat.

Be sure the seat is locked securely in position after installation.

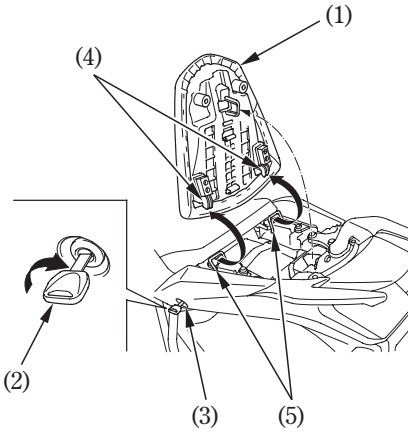

- (1) Rear seat
- (2) Ignition key
- (3) Seat lock

- (4) Prongs
- (5) Rear stays

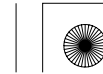



Front seat

To remove the front seat (1), remove the rear seat (page 47) and mounting bolts (2), and then pull the seat back and up.

To install the front seat, insert the tab (3) into the recess under the frame and tighten the mounting bolts securely.

Install the rear seat.

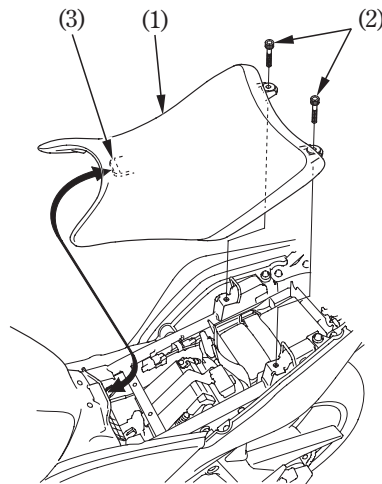

(1) Front seat
(2) Mounting bolts

(3) Tab

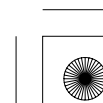
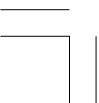



HELMET HOLDER

The helmet holder is located below the rear seat.

Remove the rear seat (page 47). Route the helmet wire (1) through the helmet D-ring (2) and hook the loops of the helmet wire onto the helmet holder (3). Install the rear seat and lock it securely.

WARNING

Riding with a helmet attached to the holder can interfere with the rear wheel or suspension and could cause a crash in which you can be seriously hurt or killed.

Use the helmet holder only while parked. Do not ride with a helmet secured by the holder.

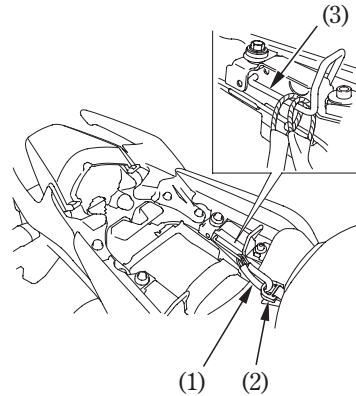

(1) Helmet wire
(2) Helmet D-ring

(3) Helmet holder

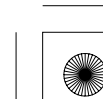
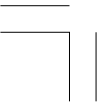



DOCUMENT BAG

The document bag (1) is in the document compartment (2) under the rear seat (page 47).

This owner's manual and other documents should be stored in the document bag. When washing your motorcycle, be careful not to flood this area with water.

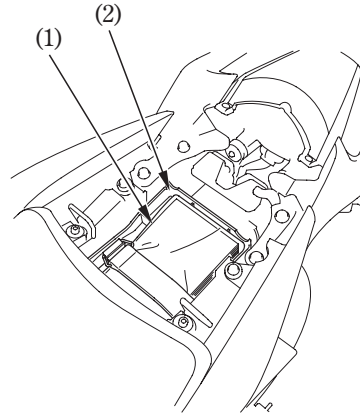

- (1) Document bag
- (2) Document compartment

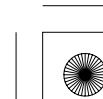
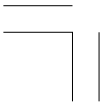



STORAGE COMPARTMENT FOR U-SHAPED ANTI-THEFT LOCK

The rear fender has a storage compartment to store a U-shaped anti-theft lock under the seat (page 47). After storing, be sure to fasten the lock with the rubber band (1) securely.

Some U-shaped locks may not be stored in the compartment due to their size or design.

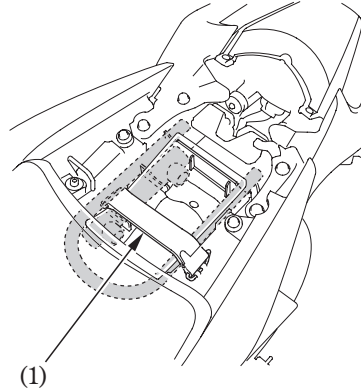

(1) Rubber band

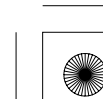
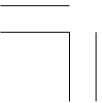



RIGHT UNDER COWL

The right under cowl must be removed to service the oil filter.

Removal:

1. Remove the bolt A (1) and bolts B (2).
2. Remove the hooks (3) from the slots (4).
3. Remove the middle cowl (5) and disconnect the front turn signal connectors (6).
 - Be careful not to apply weight to the middle cowl.
 - Carefully release the hooks.

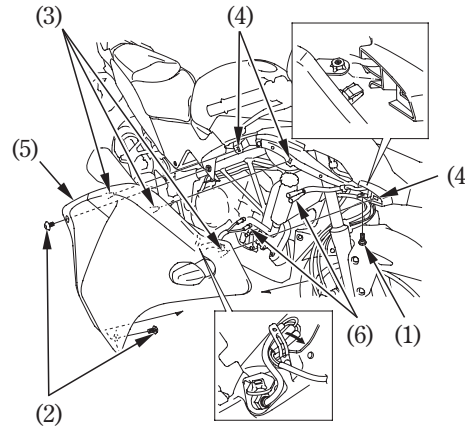

- | | |
|-------------|----------------------------------|
| (1) Bolt A | (4) Slots |
| (2) Bolts B | (5) Middle cowl |
| (3) Hooks | (6) Front turn signal connectors |

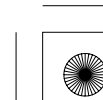
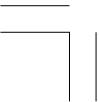



4. Remove the right under cowl (7) by removing the bolt C (8), bolt D (9) and screw (10).

Installation:

- Installation can be done in the reverse order of removal.

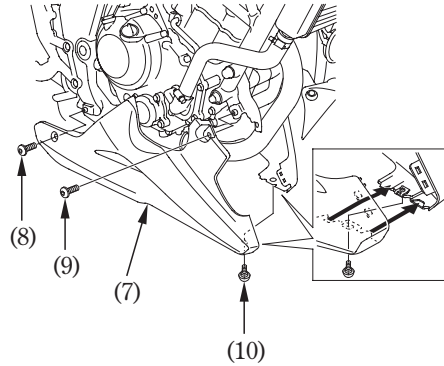

- | | |
|----------------------|------------|
| (7) Right under cowl | (9) Bolt D |
| (8) Bolt C | (10) Screw |

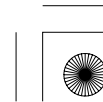
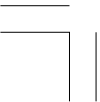



HEADLIGHT AIM VERTICAL ADJUSTMENT

Vertical adjustment can be made by turning
the pinion (1) in or out as necessary.
Obey local laws and regulations.

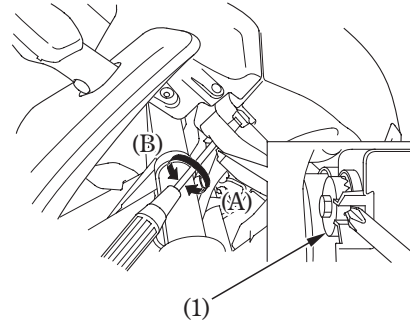

(1) Pinion

(A) Up
(B) Down

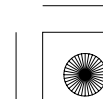
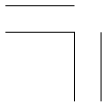



OPERATION

PRE-RIDE INSPECTION

For your safety, it is very important to take a few moments before each ride to walk around your motorcycle and check its condition. If you detect any problem, be sure you take care of it, or have it corrected by your dealer.

WARNING

Improperly maintaining this motorcycle or failing to correct a problem before riding can cause a crash in which you can be seriously hurt or killed.

Always perform a pre-ride inspection before every ride and correct any problems.

1. Engine oil level—add engine oil if required (page 36). Check for leaks.
2. Fuel level—fill fuel tank when necessary (page 33). Check for leaks.
3. Coolant level—add coolant if required. Check for leaks (pages 31 – 32).
4. Front and rear brakes—check operation; make sure there is no brake fluid leakage (pages 27 – 28).
5. Tyres—check condition and pressure (pages 37 – 42).
6. Drive chain—check condition and slack (page 86 – 87). Adjust and lubricate if necessary.
7. Throttle—check for smooth opening and full closing in all steering positions (page 84).
8. Lights and horn—check that headlight, brake/tail light, position lights, license light, turn signals, indicators and horn function properly.
9. Engine stop switch—check for proper function (page 44).

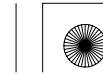



STARTING THE ENGINE

Always follow the proper starting procedure described below.

Your motorcycle's exhaust contains poisonous carbon monoxide gas. High levels of carbon monoxide can collect rapidly in enclosed areas such as a garage. Do not run the engine with the garage door closed. Even with the door open, run the engine only long enough to move your motorcycle out of the garage.

Do not use the electric starter for more than 5 seconds at a time. Release the start button for approximately 10 seconds before pressing it again.

To protect the catalytic converter in your motorcycle's exhaust system, avoid extending idling and the use of leaded petrol.

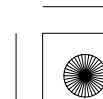



Preparation

Before starting, insert the key, turn the ignition switch ON and confirm the following:

- The transmission is in neutral (neutral indicator is ON).
- The engine stop switch is at  (RUN).
- The ABS indicator is ON. (CBR250RA).
- The PGM-FI malfunction indicator lamp (MIL) is OFF.

< CBR250RA >

The ABS indicator should go off after you ride the motorcycle at a speed above 10 km/h (6 mph).

Starting Procedure

This motorcycle has a fuel-injected engine with an automatic choke. Follow the procedure indicated below.

Any Air Temperature:

- With the throttle completely closed, press the start button.

The engine will not start if the throttle is fully open (because the electronic control module cuts off the fuel supply).

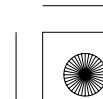
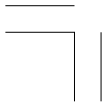



Flooded Engine

If the engine fails to start after repeated attempts, it may be flooded.

1. Open the throttle fully.
2. Press the start button for 5 seconds.
3. Follow the normal starting procedure.
4. If the engine starts with unstable idle, open the throttle slightly.

If the engine does not start, wait for 10 seconds, then follow steps 1–3 again.

Ignition Cut Off

Your motorcycle is designed to automatically stop the engine and fuel pump if the motorcycle is over-turned (a banking sensor cuts off the ignition system). Before restarting the engine, you must turn the ignition switch to the OFF position and then back to ON.

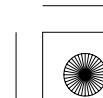



RUNNING-IN

Help assure your motorcycle's future reliability and performance by paying extra attention to how you ride during the first 500 km (300 miles). During this period, avoid full-throttle starts and rapid acceleration.

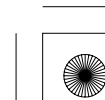
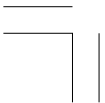



RIDING

Review Motorcycle Safety (pages 1 – 7) before you ride.

Make sure the side stand is fully retracted before riding the motorcycle. If the stand is extended, it may interfere with control during a left turn.

Make sure flammable materials such as dry grass or leaves do not come in contact with the exhaust system when riding, idling, or parking your motorcycle.

1. After the engine has been warmed up, the motorcycle is ready for riding.
2. While the engine is idling, pull in the clutch lever and depress the shift lever to shift into 1st (low) gear.

3. Slowly release the clutch lever and at the same time gradually increase engine speed by opening the throttle. Coordination of the throttle and clutch lever will assure a smooth positive start.
4. When the motorcycle attains a moderate speed, close the throttle, pull in the clutch lever and shift to 2nd gear by raising the shift lever.

This sequence is repeated to progressively shift to 3rd, 4th, 5th and 6th (top) gear.

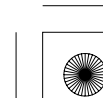
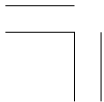



5. Coordinate the throttle and brakes for smooth deceleration.
6. Both front and rear brakes should be used at the same time and should not be applied strongly enough to lock the wheel, or braking effectiveness will be reduced and control of the motorcycle be difficult.

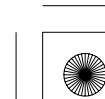
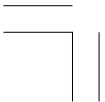
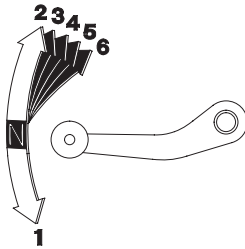



BRAKING

For normal braking, apply both the brake pedal and lever while down-shifting to match your road speed. For maximum braking, close the throttle and firmly apply the pedal and lever; pull in the clutch lever before coming to a complete stop to prevent stalling the engine.

Important Safety Reminders:

- Independent operation of only the brake lever or brake pedal reduces stopping performance.
- Extreme application of the brake controls may cause wheel lock, reducing control of the motorcycle.
- When possible, reduce speed or brake before entering a turn; closing the throttle or braking in mid-turn may cause wheel slip. Wheel slip will reduce control of the motorcycle.
- When riding in wet or rainy conditions, or on loose surfaces, the ability to maneuver and stop will be reduced. All of your actions should be smooth under these conditions. Rapid acceleration, braking or turning may cause loss of control. For your safety, exercise extreme caution when braking, accelerating or turning.
- When descending a long, steep grade, use engine compression braking by down-shifting, with intermittent use of both brakes. Continuous brake application can overheat the brakes and reduce their effectiveness.
- Riding with your foot resting on the brake pedal or your hand on the brake lever may actuate the brakelight, giving a false indication to other drivers. It may also overheat the brakes, reducing effectiveness.

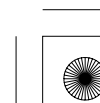
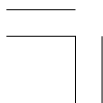



Combined ABS

< CBR250RA >

This motorcycle is equipped with a Combi Brake. Operating the front brake lever applies the front brake. Operating the rear brake pedal applies the rear brake and a portion of the front brake. For full braking effectiveness, use both the lever and pedal simultaneously, as you would with a conventional motorcycle braking system.

As with a conventional motorcycle braking system, excessively hard application of the brake controls may cause wheel lock, reducing control of the motorcycle.

This model is also equipped with an Anti-lock Brake System (ABS) designed to help prevent wheel lock up during hard braking on uneven or other poor surfaces while running straight. Although the wheel may not lock up—if you are braking too hard in a turn the motorcycle can still lose traction, causing a loss of control.

In some situations, a motorcycle with ABS may require a longer stopping distance to stop on loose or uneven surfaces than an equivalent motorcycle without ABS.

ABS cannot make up for road conditions, bad judgment, or improper operation of the brakes. It is still your responsibility to ride at reasonable speeds for weather, road surface, and traffic conditions, and to leave a margin of safety.

- ABS is self-checking and always on.
- ABS may be activated by riding over a sharp drop or rise in the road level.

It is important to follow the tyre recommendations (page 37). The ABS computer works by comparing wheel speed. Non-recommended tyres can affect wheel speed and may confuse the ABS computer.

- ABS does not function at low speeds (approximately 10 km/h (6 mph) or below).
- ABS does not function if the battery is discharged.





ABS Indicator

< CBR250RA >

Normally, this indicator comes on when the ignition is turned ON, and goes off after you ride the motorcycle at speed above 10 km/h (6 mph). If there is an ABS problem, the indicator flashes and remains on. The ABS system does not operate when the ABS indicator is on.

The ABS indicator may flash if you turn the rear wheel while the motorcycle is upright on the stand. This is normal. Turn the ignition OFF, then turn it ON. The indicator should come on, then go off after you run the motorcycle above 30 km/h (19 mph).



If the ABS indicator comes on while riding, stop the motorcycle in a safe place and turn off the engine.

Turn the ignition ON again. The indicator should come on, and go off after you ride the motorcycle at speeds above 10 km/h (6 mph). If it does not go off, ABS is not functioning, but the brakes still work a Combined Brake System and provide normal stopping ability. However, you should have the system checked by your dealer as soon as possible.

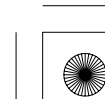



PARKING

1. After stopping the motorcycle, shift the transmission into neutral, turn the handlebar fully to the left, turn the ignition switch OFF and remove the key.
2. Use the side stand to support the motorcycle while parked.

Park the motorcycle on firm, level ground to prevent it from falling over.

If you must park on a slight incline, aim the front of the motorcycle uphill to reduce the possibility of rolling off the side stand or overturning.

3. Lock the steering to help prevent theft (page 46).

The exhaust pipe and muffler become very hot during operation and remain sufficiently hot to inflict burns if touched even after shutting off the engine.

Make sure flammable materials such as dry grass or leaves do not come in contact with the exhaust system when parking your motorcycle.

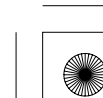
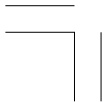



ANTI-THEFT TIPS

1. Always lock the steering and never leave the key in the ignition switch. This sounds simple but people do forget.
2. Be sure the registration information for your motorcycle is accurate and current.
3. Park your motorcycle in a locked garage whenever possible.
4. Use an additional anti-theft device of good quality.
5. Put your name, address, and phone number in this Owner's Manual and keep it on your motorcycles at all times. Many times stolen motorcycles are identified by information in the Owner's Manuals that are still with them.

NAME: _____

ADDRESS: _____

PHONE NO: _____

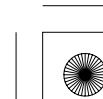
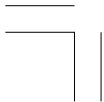



MAINTENANCE

THE IMPORTANCE OF MAINTENANCE

A well-maintained motorcycle is essential for safe, economical and trouble-free riding. It will also help reduce air pollution.

To help you properly care for your motorcycle, the following pages include a Maintenance Schedule and a Maintenance Record for regularly scheduled maintenance.

These instructions are based on the assumption that the motorcycle will be used exclusively for its designed purpose. Sustained high speed operation or operation in unusually wet or dusty conditions will require more frequent service than specified in the Maintenance Schedule. Consult your dealer for recommendations applicable to your individual needs and use.

If your motorcycle overturns or becomes involved in a crash, be sure your dealer inspects all major parts, even if you are able to make some repairs.

⚠ WARNING

Improperly maintaining this motorcycle or failing to correct a problem before you ride can cause a crash in which you can be seriously hurt or killed.

Always follow the inspection and maintenance recommendations and schedules in this owner's manual.

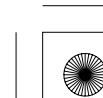
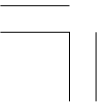



MAINTENANCE SAFETY

This section includes instructions on some important maintenance tasks. You can perform some of these tasks with the tools provided — if you have basic mechanical skills.

Other tasks that are more difficult and require special tools are best performed by professionals. Wheel removal should normally be handled only by a Honda technician or other qualified mechanic; instructions are included in this manual only to assist in emergency service.

Some of the most important safety precautions follow. However, we cannot warn you of every conceivable hazard that can arise in performing maintenance. Only you can decide whether or not you should perform a given task.

WARNING

Failure to properly follow maintenance instructions and precautions can cause you to be seriously hurt or killed.

Always follow the procedures and precautions in this owner's manual.

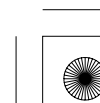
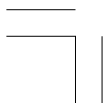



SAFETY PRECAUTIONS

- Make sure the engine is off before you begin any maintenance or repairs. This will help eliminate several potential hazards:

- * **Carbon monoxide poisoning from engine exhaust.**

Be sure there is adequate ventilation whenever you operate the engine.

- * **Burns from hot parts.**

Let the engine and exhaust system cool before touching.

- * **Injury from moving parts.**

Do not run the engine unless instructed to do so.

- Read the instructions before you begin, and make sure you have the tools and skills required.
- To help prevent the motorcycle from falling over, park it on a firm, level surface, using the side stand or a maintenance stand to provide support.

- To reduce the possibility of a fire or explosion, be careful when working around petrol or batteries. Use only nonflammable solvent, not petrol, to clean parts. Keep cigarettes, sparks and flames away from the battery and all fuel-related parts.

Remember that your Honda dealer knows your motorcycle best and is fully equipped to maintain and repair it.

To ensure the best quality and reliability, use only new Honda Genuine Parts or their equivalents for repair and replacement.

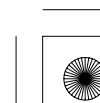
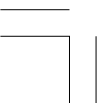



MAINTENANCE SCHEDULE

Perform the Pre-ride Inspection (page 55) at each scheduled maintenance period.

E: INSPECT AND CLEAN, ADJUST, LUBRICATE OR REPLACE IF NECESSARY

C: CLEAN R: REPLACE A: ADJUST L: LUBRICATE

The following items require some mechanical knowledge. Certain items (particularly those marked * and * *) may require more technical information and tools. Consult your dealer.

* Should be serviced by your dealer, unless the owner has proper tools and service data and is mechanically qualified. Refer to the Official Honda Shop Manual.

** In the interest of safety, we recommend these items be serviced only by your dealer.

Honda recommends that your dealer should road test your motorcycle after each periodic maintenance is carried out.

NOTES: (1) At higher odometer readings, repeat at the frequency interval established here.

(2) Service more frequently when riding in unusually wet or dusty areas.

(3) Service more frequently when riding in rain or at full throttle.

(4) Replacement requires mechanical skill.

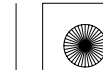



ITEM	FREQUENCY	WHICHEVER → COMES FIRST ↓ NOTE	ODOMETER READING [NOTE (1)]								Refer to Page
			× 1,000 km	1	6	12	18	24	30	36	
			× 1,000 mi	0.6	4	8	12	16	20	24	
* FUEL LINE					I		I		I	—	
* THROTTLE OPERATION					I		I		I	84	
AIR CLEANER	NOTE (2)					R			R	76	
CRANKCASE BREATHER	NOTE (3)			C	C	C	C	C	C	78	
* SPARK PLUG			EVERY 24,000 km I, EVERY 48,000 km R								—
* VALVE CLEARANCE			I				I			—	
ENGINE OIL			R		R		R		R	79	
ENGINE OIL FILTER			R		R		R		R	81	
* ENGINE IDLE SPEED			I	I	I	I	I	I	I	—	
RADIATOR COOLANT	NOTE (4)				I		I		R	31, 85	
* COOLING SYSTEM					I		I		I	—	
* SECONDARY AIR SUPPLY SYSTEM					I		I		I	—	





ITEM	FREQUENCY	WHICHEVER → COMES FIRST ↓ NOTE	ODOMETER READING [NOTE (1)]								Refer to Page	
			× 1,000 km	1	6	12	18	24	30	36		
			× 1,000 mi	0.6	4	8	12	16	20	24		
		NOTE	MONTH	6	12	18	24	30	36			
				EVERY 1,000 km (600 mi) I, L								86
					I		I		I		92	
		NOTE (4)			I	I	R	I	I	R	27, 28	
					I	I	I	I	I	I	100	
					I		I		I		27, 100	
*							I		I		108	
*							I		I		54	
					I	I	I	I	I	I	29	
							I		I		94	
*							I		I		93	
*					I		I		I		—	
**							I		I		—	
**					I		I		I		—	

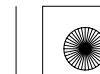



TOOL KIT

The tool kit (1) is in the tool kit compartment (2) under the rear seat (page 47).

Some roadside repairs, minor adjustments and parts replacement can be performed with the tools contained in the kit.

- Helmet holder wire
- 8 × 10 mm Open end wrench
- 12 × 14 mm Open end wrench
- Standard/Phillips screwdriver
- Extension bar
- 19 mm Box end wrench
- 24 mm Box end wrench
- Tool bag
- Screwdriver handle
- 5 mm Hex wrench
- Pin spanner

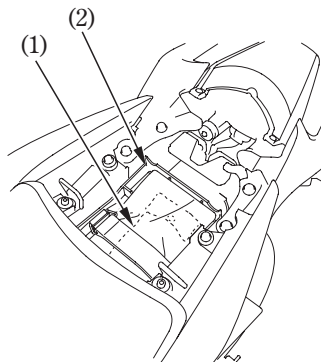

- (1) Tool kit
- (2) Tool kit compartment

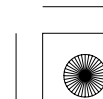



SERIAL NUMBERS

The frame and engine serial numbers are required when registering your motorcycle. They may also be required by your dealer when ordering replacement parts. Record the numbers here for your reference.

The frame number (1) is stamped on the right side of the steering head.

The engine number (2) is stamped on the left side of the crankcase.

FRAME NO. _____

ENGINE NO. _____

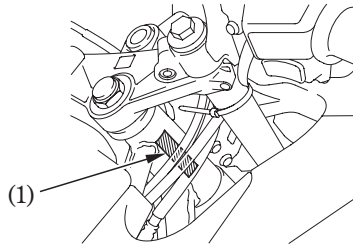

(1) Frame number
74

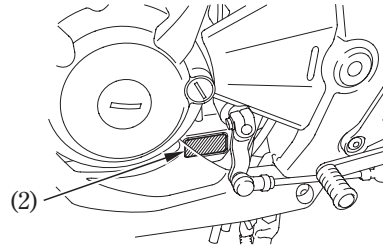

(2) Engine number

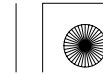



This motorcycle has two ignition keys (1) and a key number plate (2).

You will need the key number if you ever have to replace a key. Store the plate in a safe place.

To reproduce keys, bring all keys, key number plate and motorcycle to your dealer.

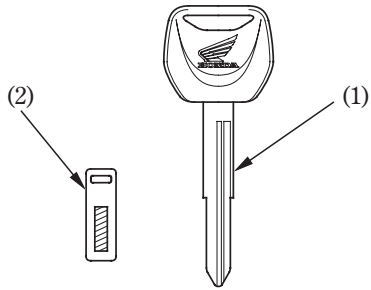

(1) Ignition key

(2) Key number plate

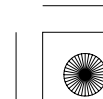
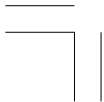



AIR CLEANER

Refer to the Safety Precautions on page 69 .

The air cleaner should be serviced at regular intervals (page 71). Service more frequently when riding in unusually wet or dusty areas.

1. Remove the air cleaner case cover (1) by removing the screws (2).
2. Remove the air cleaner element (3) by pushing the tabs (4).
3. Install the new air cleaner element. Make sure the air cleaner element is fixed.

Use the Honda Genuine air cleaner element or an equivalent air cleaner element specified for your model. Using the wrong Honda air cleaner element or a non-Honda air cleaner element which is not of equivalent quality may cause premature engine wear or performance problems.

4. Install the removed parts in reverse order of removal.

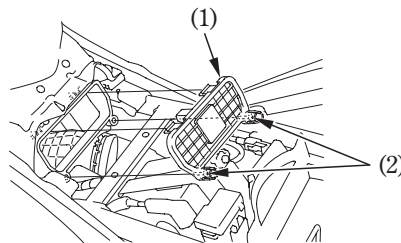

(1) Air cleaner case cover (2) Screws

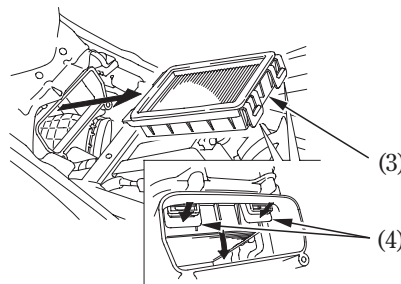

(3) Air cleaner element (4) Tabs



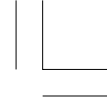

This motorcycle is equipped with a viscous type air cleaner element.
Air blow cleaning or any other cleaning can degrade the viscous element performance and cause the intake of dust.
Do not perform the maintenance.

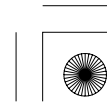
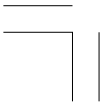
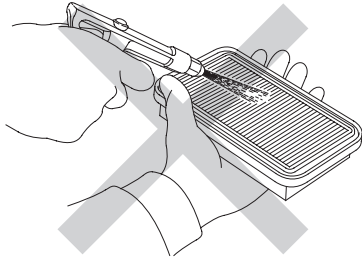



CRANKCASE BREATHER

Refer to the Safety Precautions on page 69 .

1. Remove the crankcase breather tube plug (1) from the tube and drain deposits into a suitable container.
2. Reinstall the crankcase breather tube plug.

Service more frequently when ridden in rain, at full throttle, or after the motorcycle is washed or overturned.
Service if the deposit level can be seen in the transparent section of the crankcase breather tube.

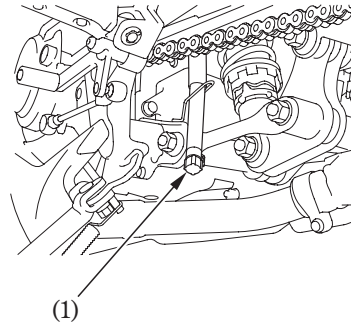

(1) Crankcase breather tube plug

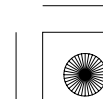



ENGINE OIL

Refer to the Safety Precautions on page 69 .

Oil Recommendation

API classification	SG or higher except oils labeled as energy conserving on the circular API service label
Viscosity	SAE 10W-30
JASO T 903 standard	MA

Suggested Oil
Honda "4-STROKE MOTORCYCLE OIL" or equivalent.

Your motorcycle does not need oil additives. Use the recommended oil.

Do not use oils with graphite or molybdenum additives. They may adversely affect clutch operation.

Do not use API SH or higher oils displaying a circular API "energy conserving" service label on the container. They may affect lubrication and clutch performance.



NOT RECOMMENDED

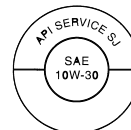

OK

Do not use non-detergent, vegetable, or castor based racing oils.

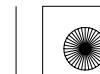



Viscosity:

Viscosity grade of engine oil should be based on average atmospheric temperature in your riding area. The following provides a guide to the selection of the proper grade or viscosity of oil to be used at various atmospheric temperatures.

JASO T 903 standard

The JASO T 903 standard is an index for engine oils for 4-stroke motorcycle engines. There are two classes: MA and MB. Oil conforming to the standard is labeled on the oil container. For example, the following label shows the MA classification.

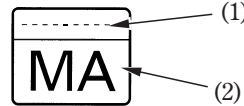
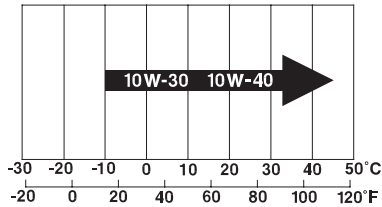

PRODUCT MEETING JASO T 903
COMPANY GUARANTEEING THIS MA PERFORMANCE:

- (1) Code number of the sales company of the oil
- (2) Oil classification

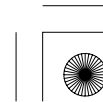
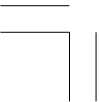



Engine Oil and Filter

Engine oil quality is the chief factor affecting engine service life. Change the engine oil as specified in the maintenance schedule (page 71).

When running in very dusty conditions, oil changes should be performed more frequently than specified in the maintenance schedule.

Please dispose of used engine oil in a manner that is compatible with the environment. We suggest you take it in a sealed container to your local recycling center or service station for reclamation. Do not throw it in the trash or pour it on the ground or down a drain.

Used engine oil may cause skin cancer if repeatedly left in contact with the skin for prolonged periods. Although this is unlikely unless you handle used oil on a daily basis, it is still advisable to thoroughly wash your hands with soap and water as soon as possible after handling used oil.

Changing the oil filter requires a torque wrench. If you do not have it and the necessary skill, we recommend that you have your dealer perform this service.

If a torque wrench is not used for this installation, see your dealer as soon as possible to verify proper assembly.

Change the engine oil with the engine at normal operating temperature and the motorcycle on its side stand to assure complete and rapid draining.

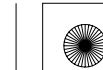



1. Place a drain pan under the crankcase.
2. To drain the oil, remove the oil fill cap, oil drain bolt (1) and sealing washer (2).
3. Remove the right under cowl (page 52).
4. Remove the oil filter cover (3), oil filter (4), spring (5) and gasket (6) by removing the oil filter cover bolt (7).

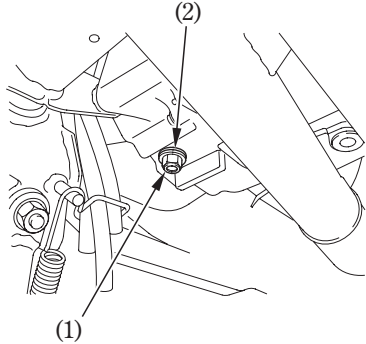

- (1) Oil drain bolt
- (2) Sealing washer

5. Install the new oil filter with the “OUT-SIDE” mark (8) facing out.
Use only the Honda Genuine oil filter or a filter of equivalent quality specified for your model. Using the wrong Honda filter or a non-Honda filter which is not of equivalent quality may cause engine damage.

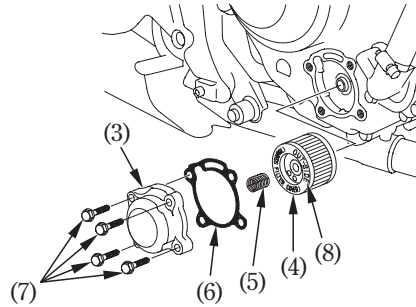

- (3) Oil filter cover
- (4) Oil filter
- (5) Spring
- (6) Gasket
- (7) Oil filter cover bolt
- (8) “OUT-SIDE” mark

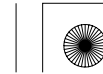



NOTICE

Improper installation of the oil filter can cause serious engine damage.

6. Install the oil filter spring into the oil filter cover. Then, install the new gasket and oil filter cover.

Make sure the oil filter cover bolts are tightened securely to the specified torque.

Oil filter cover bolts torque:

12 N·m (1.2 kgf·m , 9 lbf·ft)

7. Check that the sealing washer on the drain bolt is in good condition and install the bolt. Replace the sealing washer every other time the oil is changed, or each time if necessary.

Engine oil drain bolt torque:

24 N·m (2.4 kgf·m , 18 lbf·ft)

8. Fill the crankcase with the recommended grade oil; approximately:
1.5 ℓ (1.6 US qt , 1.3 Imp qt)

9. Install the oil fill cap.
10. Start the engine and let it idle for 3–5 minutes.
11. 2–3 minutes after stopping the engine, check that the oil level is at the upper level mark in the inspection window with the motorcycle upright on firm, level ground. Make sure there are no oil leaks.

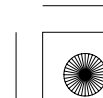
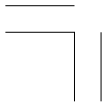



THROTTLE OPERATION

Refer to the Safety Precautions on page 69 .

1. Check for smooth rotation of the throttle grip from the fully open to the fully closed position at both full steering positions.
2. Measure the throttle grip freeplay at the throttle grip flange.
The standard freeplay should be approximately:
2 – 6 mm (0.1 – 0.2 in)

To adjust the freeplay, slide the throttle cable boot (1), then loosen the lock nut (2) and turn the adjuster (3).

After adjustment, tighten the lock nut and return the throttle cable boot securely.

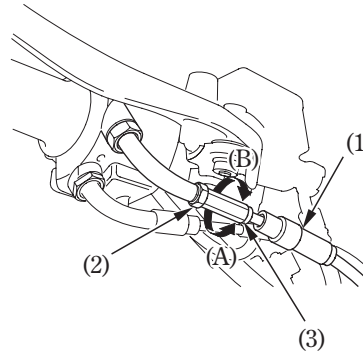

- | | |
|-------------------------|--------------|
| (1) Throttle cable boot | (A) Increase |
| (2) Lock nut | (B) Decrease |
| (3) Adjuster | |

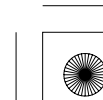



COOLANT

Refer to the Safety Precautions on page 69 .

Coolant Replacement

Coolant should be replaced by your dealer, unless the owner has proper tools and service data and is mechanically qualified. Refer to an official Honda Shop Manual.

Always add coolant to the reserve tank. Do not attempt to add coolant by removing the radiator cap.



<p>⚠ WARNING</p> <p>Removing the radiator cap while the engine is hot can cause the coolant to spray out, seriously scalding you.</p> <p>Always let the engine and radiator cool down before removing the radiator cap.</p>
--

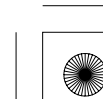
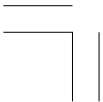



DRIVE CHAIN

Refer to the Safety Precautions on page 69 .

The service life of the drive chain (1) is dependent upon proper lubrication and adjustment. Poor maintenance can cause premature wear or damage to the drive chain and sprockets.

The drive chain should be checked, adjusted and lubricated as part of the Pre-ride Inspection (page 55). Under severe usage, or when the motorcycle is ridden in unusually dusty or muddy areas, more frequent maintenance will be necessary.

Inspection:

1. Turn the engine off, place the motorcycle on its side stand and shift the transmission into neutral.
2. Check slack in the lower drive chain run midway between the sprockets.
Drive chain slack should be adjusted to allow the following vertical movement by hand:
20–30 mm (0.8–1.2 in)

3. Roll the motorcycle forward. Stop. Check the drive chain slack. Repeat this procedure several times. Drive chain slack should remain constant. If the chain is slack only in certain sections, some links are kinked and binding. Binding and kinking can frequently be eliminated by lubrication.

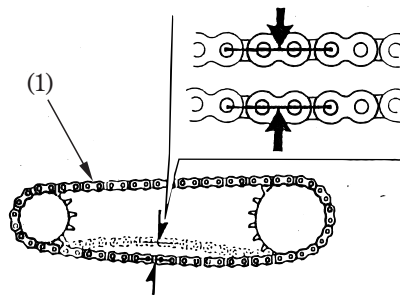

(1) Drive chain





4. Roll the motorcycle forward. Stop and place it on its side stand. Inspect the drive chain and sprockets for any of the following conditions:

DRIVE CHAIN

- *Damaged Rollers
- *Loose Pins
- *Dry or Rusted Links
- *Kinked or Binding Links
- *Excessive Wear
- *Improper Adjustment
- *Damaged or Missing O-rings

SPROCKETS

- *Excessively Worn Teeth
- *Broken or Damaged Teeth

A drive chain with damaged rollers, loose pins, or missing O-rings must be replaced. A chain which appears dry, or shows signs of rust, requires supplementary lubrication. Kinked or binding links should be thoroughly lubricated and worked free. If links cannot be freed, the chain must be replaced.

Damaged Sprocket Teeth

Worn Sprocket Teeth

REPLACE

REPLACE

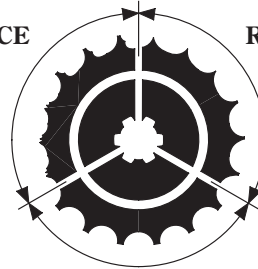

Normal Sprocket Teeth

GOOD

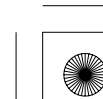
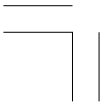



Adjustment:

Drive chain slack should be checked and adjusted, if necessary, every 1,000 km (600 miles). When operated at sustained high speeds or under conditions of frequent rapid acceleration, the chain may require more frequent adjustment.

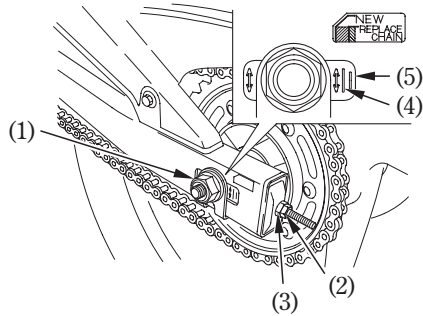

- | | |
|-------------------------------|---------------------------------|
| (1) Rear axle nut | (4) Chain adjuster index mark |
| (2) Drive chain lock nut | (5) Rear edge of adjusting slot |
| (3) Drive chain adjusting nut | |

88

If the drive chain requires adjustment, the procedure is as follows:

1. Place the motorcycle on its side stand on a firm, level surface with the transmission in neutral and the ignition switch OFF.
2. Loosen the rear axle nut (1).
3. Loosen the drive chain lock nuts (2) on both sides of the swingarm.
4. Turn both drive chain adjusting nuts (3) an equal number of turns until the correct drive chain slack is obtained. Turn the drive chain adjusting nuts clockwise to tighten the chain, or counterclockwise to provide more slack. Adjust the chain slack at a point midway between the drive sprocket and the rear wheel sprocket. Roll the motorcycle forward. Stop and place it on its side stand. Recheck chain slack.

Chain slack should be:

20–30 mm (0.8–1.2 in)

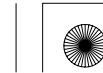



5. Check rear axle alignment by making sure the chain adjuster index marks (4) align with the rear edge (5) of the adjusting slots.
Both left and right marks should correspond. If the axle is misaligned, turn the left or right adjusting nut until the marks correspond on the rear edge of the adjusting slots and recheck chain slack.
6. Tighten the rear axle nut to the specified torque.
Rear axle nut torque:
88 N·m (9.0 kgf·m , 65 lbf·ft)
7. Tighten the drive chain adjusting nuts lightly, then tighten the drive chain lock nuts by holding the drive chain adjusting nuts with a spanner.
8. Recheck drive chain slack.



If a torque wrench is not used for this installation, see your dealer as soon as possible to verify proper assembly.

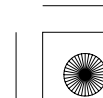
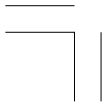



Wear Inspection:

Check the chain wear label when adjusting the chain. If the red zone (6) on the label aligns with the arrow mark (7) on the chain adjuster plates after the chain has been adjusted to the proper slack, the chain is excessively worn and must be replaced. The proper slack is:

20–30 mm (0.8–1.2 in)

Damage to the bottom part of the frame may be caused by excessive drive chain slack of more than:

50 mm (2.0 in)

Chain:

RK 520KLO–108LE

or

DID 520VF–108LE

If necessary, have the drive chain replaced by your dealer.

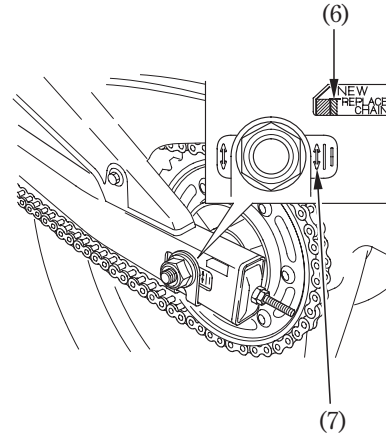

- (6) Red zone
- (7) Arrow mark

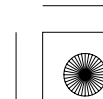



Lubrication and Cleaning:

Lubricate every 1,000 km (600 miles) or sooner if chain appears dry.

After inspecting the slack, clean the chain and sprockets while rotating the rear wheel. Use dry cloth with chain cleaner designed specifically for O-ring chains, or neutral detergent. Use a soft brush if the chain is dirty.

After cleaning, wipe dry and lubricate with drive chain lubricant designed specifically for O-ring chains. If not available, use SAE 80 or 90 gear oil.

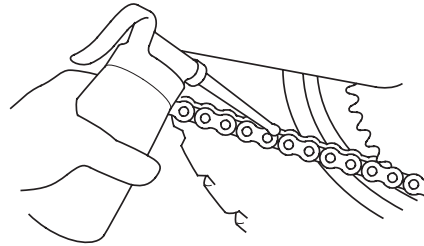

Do not use a steam cleaner, a high pressure cleaner, a wire brush, volatile solvent such as gasoline and benzene, abrasive cleaner, chain cleaner or lubricant not designed specifically for O-ring chains as these can damage the rubber O-ring seals.

Avoid getting lubricant on the brakes or tyres. Avoid applying excess chain lubricant to prevent spray onto your clothes and the motorcycle.

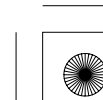
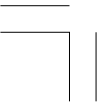



DRIVE CHAIN SLIDER

Refer to the Safety Precautions on page 69 .

Check the chain slider (1) for wear.
The chain slider must be replaced if it is worn to the wear limit line (2). For replacement, see your dealer.

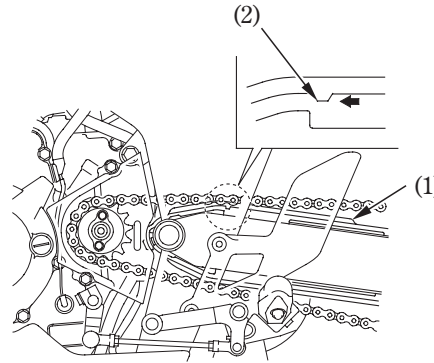

(1) Chain slider

(2) Wear limit line

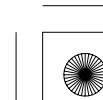



FRONT AND REAR SUSPENSION INSPECTION

Refer to the Safety Precautions on page 69 .

1. Check the front fork assembly by locking the front brake and pumping the fork up and down vigorously. Suspension action should be smooth and there must be no oil leakage.
2. Rear fork bushing—this can be checked by pushing hard against the side of the rear wheel while the motorcycle is on a support block. Feeling for looseness of the fork bushings.
3. Carefully inspect all front and rear suspension fasteners for tightness.

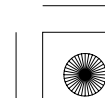



SIDE STAND

Refer to the Safety Precautions on page 69 .

Check the side stand spring (1) for damage and loss of tension, and the side stand assembly for freedom of movement.

If the side stand is squeaky or stiff, clean the pivot area and lubricate the pivot bolt with clean engine oil.

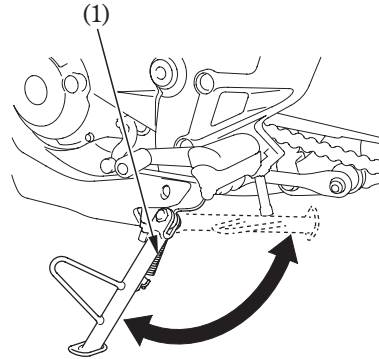

(1) Side stand spring

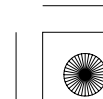
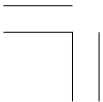



WHEEL REMOVAL

Refer to the Safety Precautions on page 69 .

This motorcycle is equipped with a side stand only. Therefore, if front or rear wheel removal is required, it will be necessary to raise the center of the motorcycle with a jack or other firm support. If none is available, see your dealer for this service.

(CBR250RA only)

When removing and installing the wheel, be careful not to damage the wheel speed sensor and pulser ring.

Front Wheel Removal

1. Support the motorcycle securely and raise the front wheel off the ground using a safety stand or a hoist.
2. Remove the front axle nut (1).
3. Loosen the axle pinch bolt (2).
4. Remove the front axle shaft (3), front wheel and side collar.

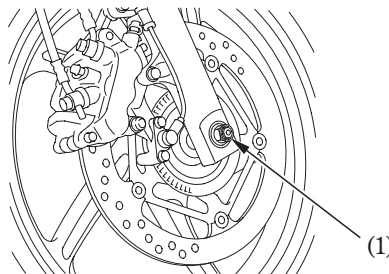

(1) Front axle nut

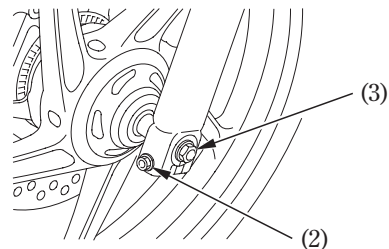

(2) Axle pinch bolt
(3) Front axle shaft





Avoid getting grease, oil, or dirt on the disc or pad surfaces. Any contamination can cause poor brake performance or rapid pad wear after reassembly.

Do not depress the brake lever when the wheel is off the motorcycle. The caliper pistons will be forced out of the cylinders with subsequent loss of brake fluid. If this occurs, servicing of the brake system will be necessary. See your dealer for this service.

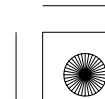



Front Wheel Installation

1. Install the side collars into the left and right side wheel hub.
2. Position the wheel between the fork legs and insert the front axle shaft from the left side, through the right fork leg and wheel hub.

To avoid damaging the brake pads while installing the wheel, carefully fit the brake disc between the pads.

3. Tighten the front axle nut to the specified torque.

Front axle nut torque:

59 N·m (6.0 kgf·m , 44 lbf·ft)

4. Tighten the axle pinch bolt on the left fork leg to the specified torque.

Axle pinch bolt torque:

22 N·m (2.2 kgf·m , 16 lbf·ft)

5. After installing the wheel, apply the brake several times and then check if the wheel rotates freely. Recheck the wheel if the brake drags or if the wheel does not rotate freely.

If a torque wrench is not used for installation, see your dealer as soon as possible to verify proper assembly. Improper assembly may lead to loss of braking capacity.

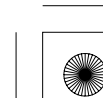



Rear Wheel Removal

1. Support the motorcycle securely, raise the rear wheel off the ground.
2. Loosen the drive chain lock nuts (1) and drive chain adjusting nuts (2).
3. Remove the rear axle nut (3).
4. Remove the drive chain (4) from the driven sprocket by pushing the rear wheel forward.

5. Remove the rear axle shaft (5), side collars and rear wheel from the swingarm.

Do not depress the brake pedal while the wheel is off the motorcycle. The caliper piston will be forced out of the cylinder with subsequent loss of brake fluid. If this occurs, servicing of the brake system will be necessary. See your dealer for this service.

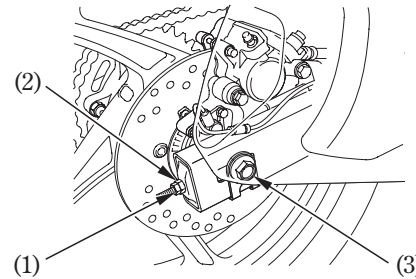
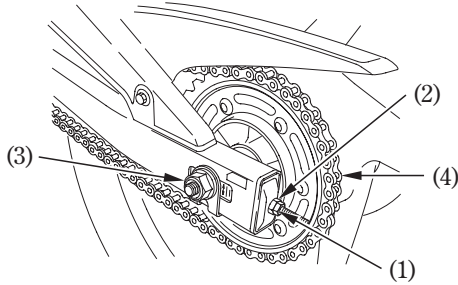

- | | |
|--------------------------------|---------------------|
| (1) Drive chain lock nuts | (4) Drive chain |
| (2) Drive chain adjusting nuts | (5) Rear axle shaft |

- (3) Rear axle nut

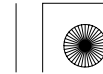

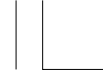

Rear Wheel Installation

To install the rear wheel, reverse the removal procedure.

1. Install the rear axle shaft, side collars and rear wheel to the swingarm.
- Make sure that the lug (1) on the brake caliper bracket (2) is located in the slot (3) in the swingarm (4).

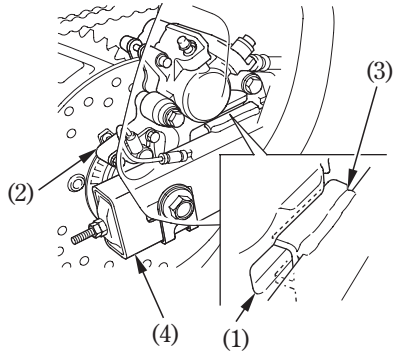

- (1) Lug
(2) Brake caliper bracket
(3) Slot
(4) Swingarm

2. Install the drive chain over the driven sprocket.
3. Install the rear axle nut.
4. Adjust the drive chain (page 88).
5. Tighten the rear axle nut to the specified torque:
88 N·m (9.0 kgf·m , 65 lbf·ft)

When installing the wheel, carefully fit the brake disc between the brake pads to avoid damaging the pads.

After installing the wheel, apply the brake several times and then check if the wheel rotates freely. Recheck the wheel if the brake drags or if the wheel does not rotate freely.

If a torque wrench is not used for installation, see your dealer as soon as possible to verify proper assembly. Improper assembly may lead to loss of braking capacity.

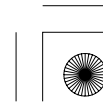
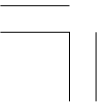



BRAKE PAD WEAR

Refer to the Safety Precautions on page 69 .

Brake pad wear depends upon the severity of usage, the type of riding, and road conditions. (Generally, the pads will wear faster on wet and dirty roads.) Inspect the pads at each regular maintenance interval (page 72).

Front Brake

< CBR250R >

Check the wear indicator grooves (1) in each pad.

If either pad is worn to the bottom of the grooves, replace both pads as a set. See your dealer for this service.

< CBR250RA >

Check the cutouts (2) in each pad.

If either pad is worn to the cutout, replace both pads as a set. See your dealer for this service.

< CBR250R >

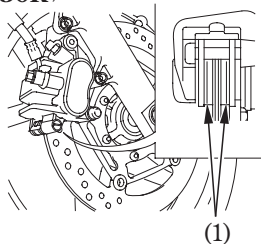

< CBR250RA >

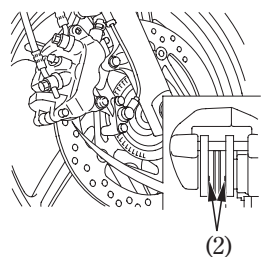

(1) Wear indicator grooves

(2) Cutouts

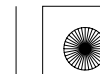



Rear Brake

Check the wear indicator grooves (1) in each pad.

If either pad is worn to the bottom of the grooves, replace both pads as a set. See your dealer for this service.

< REAR BRAKE >

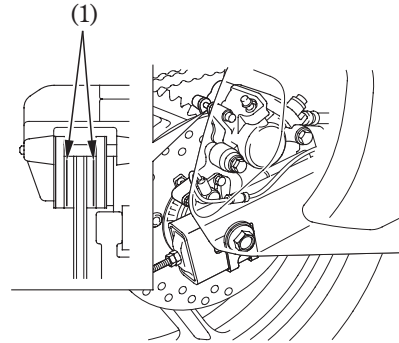

(1) Wear indicator grooves

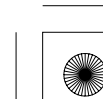
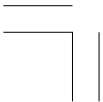



BATTERY

Refer to the Safety Precautions on page 69 .

It is not necessary to check the battery electrolyte level or add distilled water as the battery is a maintenance-free (sealed) type. If your battery seems weak and/or is leaking electrolyte (causing hard starting or other electrical troubles), contact your dealer.

NOTICE

Your battery is a maintenance-free type and can be permanently damaged if the cap strip is removed.

⚠ WARNING

The battery gives off explosive hydrogen gas during normal operation.

A spark or flame can cause the battery to explode with enough force to kill or seriously hurt you.

Wear protective clothing and a face shield, or have a skilled mechanic do the battery maintenance.

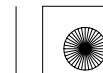



The battery (1) is in the battery box under the front seat.

Removal:

1. Make sure the ignition switch is OFF.
2. Remove the rear and front seats (pages 47, 48).
3. Remove the battery holder (2) by removing the bolt (3).
4. Disconnect the negative (-) terminal lead (4) from the battery first, then disconnect the positive (+) terminal lead (5).
5. Pull out the battery from the battery box.

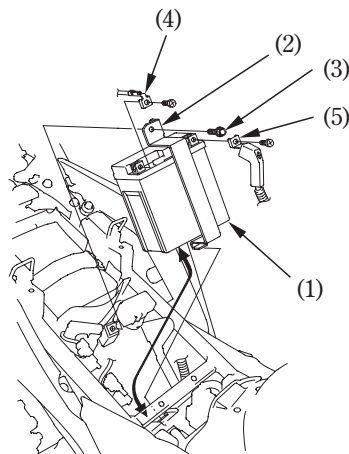

Installation:

1. Reinstall in the reverse order of removal. Be sure to connect the positive (+) terminal first, then the negative (-) terminal.
2. Check all bolts and other fasteners are secure.

- | | |
|--------------------|--------------------------------|
| (1) Battery | (4) Negative (-) terminal lead |
| (2) Battery holder | (5) Positive (+) terminal lead |
| (3) Bolt | |

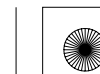



FUSE REPLACEMENT

Refer to the Safety Precautions on page 69 .

When frequent fuse failure occurs, it usually indicates a short circuit or an overload in the electrical system. See your dealer for repair.

NOTICE

Never use a fuse with a different rating from that specified. Serious damage to the electrical system or a fire may result, causing a dangerous loss of lights or engine power.

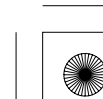
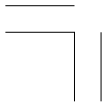
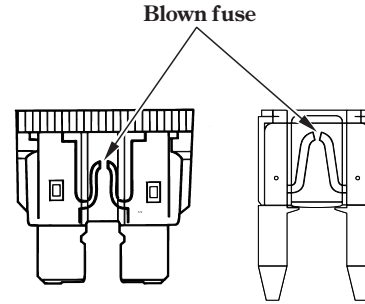



Fuse Boxes:
(CBR250RA)

The fuse boxes (1) are located under the seat.

The specified fuses are:

10 A, 30 A

1. Remove the rear and front seats (pages 47, 48).
2. Open the fuse box covers (2).
3. Pull out the old fuse. If the fuse is blown, install a spare fuse.
The spare fuses (3) are located in the fuse boxes.
4. Close the fuse box covers and install the seat.

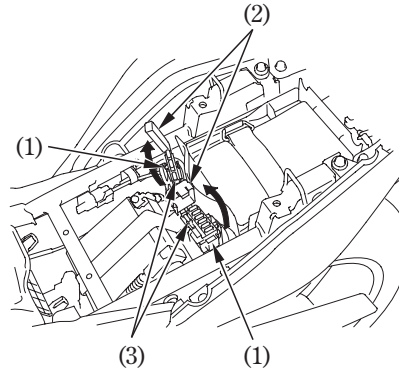

(1) Fuse boxes
(2) Fuse box covers

(3) Spare fuses

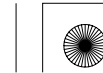



Fuse Box:
(CBR250R)

The fuse box is located under the front seat.

The specified fuses are:

10 A

1. Turn the ignition switch OFF before checking or replacing the fuses to prevent an accidental short-circuit.
2. Remove the rear and front seats (pages 47, 48).
3. Open the fuse box cover (1).
4. Pull out the old fuse and install a new fuse. The spare fuse (2) is located in the fuse box.
5. Close the fuse box cover and install the seats.

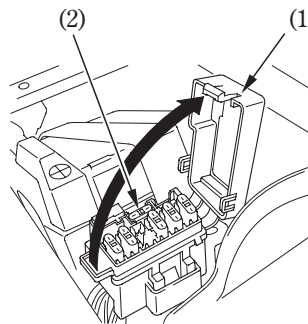

(1) Fuse box cover

(2) Spare fuse

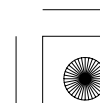
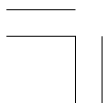



Main Fuse:

The main fuse (1) is located on the starter magnetic switch near the battery.

The specified fuse is:

30 A

1. Turn the ignition switch OFF before checking or replacing the fuse to prevent an accidental short-circuit.
2. Remove the rear and front seats (pages 47 , 48).
3. Disconnect the wire connector (2) of the starter magnetic switch.
4. Pull out the old fuse and install a new fuse.
The spare main fuse (3) is attached to the battery cover.
5. Reconnect the connector.
6. Install the remaining parts in the reverse order of removal.

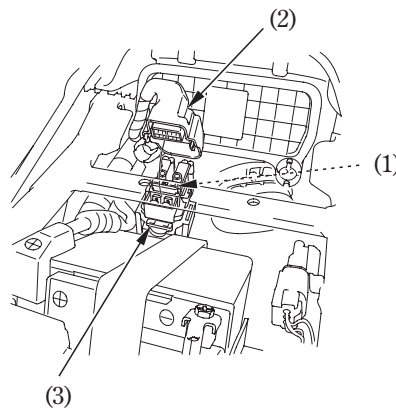

(1) Main fuse
(2) Wire connector

(3) Spare main fuse

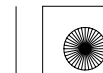



BRAKELIGHT SWITCH ADJUSTMENT

Refer to the Safety Precautions on page 69 .

Check the operation of the rear brakelight switch (1) at the right side behind the engine from time to time.

Adjustment is done by turning the adjusting nut (2). Turn the nut in the direction (A) if the switch operates too late and in direction (B) if the switch operates too soon.

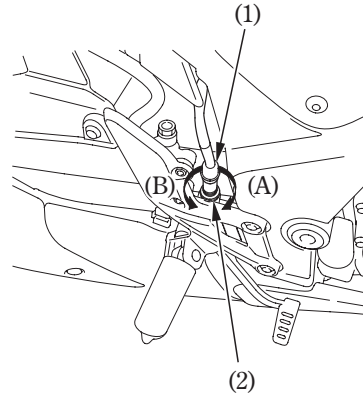

- (1) Brakelight switch
- (2) Adjusting nut

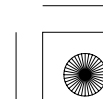



BULB REPLACEMENT

Refer to the Safety Precautions on page 69 .

The light bulb becomes very hot while the light is ON, and remains hot for a while after it is turned OFF. Be sure to let it cool down before servicing.

Do not put finger prints on the headlight bulb, as they may create hot spots on the bulb and cause it to break.

Wear clean gloves while replacing the bulb. If you touch the bulb with your bare hands, clean it with a cloth moistened with alcohol to prevent its early failure.

- Be sure to turn the ignition switch OFF when replacing the bulb.
- Do not use bulbs other than those specified.
- After installing a new bulb, check that the light operates properly.

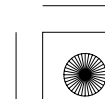
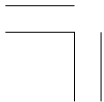

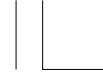

Headlight Bulb

1. Pull off the connector (1) without turning.
2. Remove the dust cover (2).
3. Press the pin (3) down and pull out the bulb (4) without turning it.
4. Install a new bulb in the reverse order of removal.

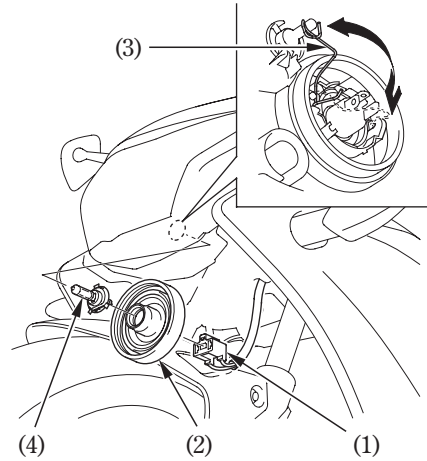

(1) Connector
(2) Dust cover

(3) Pin
(4) Bulb

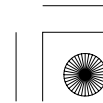



Position Light Bulb

The right and left position light bulbs replacement can be done in the same way.

1. Turn the socket (1) counterclockwise, and remove it.
2. Pull out the bulb (2) without turning.
3. Install a new bulb in the reverse order of removal.



- (1) Socket
(2) Bulb

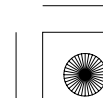
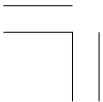



Brake/Tail Light Bulb

1. Remove the rear seat (page 47).
2. Turn the socket (1) counterclockwise, and remove it.
3. Slightly press the bulb (2) and turn it counterclockwise.
4. Install a new bulb in the reverse order of removal.
5. Install the rear seat.

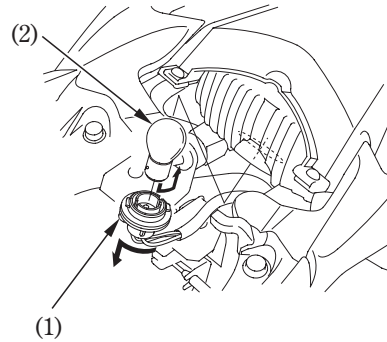

- (1) Socket
- (2) Bulb

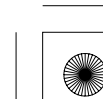



Front/Rear Turn Signal Bulb

The right and left turn signal bulbs replacement can be done in the same way.

1. Remove the turn signal lens (1) and the lens packing (2) by removing the screw A (3) and screw B (4).
2. Slightly press the bulb (5) and turn it counterclockwise.
3. Install a new bulb in the reverse order of removal.
 - Use only the amber bulb.

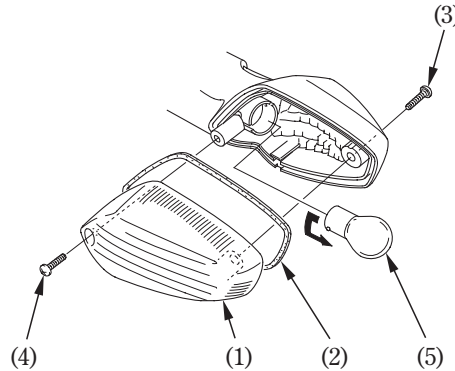

- (1) Lens
- (2) Lens packing
- (3) Screw A

- (4) Screw B
- (5) Bulb

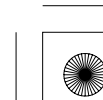
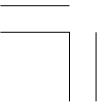



License Light Bulb

1. Remove the license light cover (1) by removing the screws (2).
2. Pull out the bulb (3) without turning.
3. Install a new bulb in the reverse order of removal.

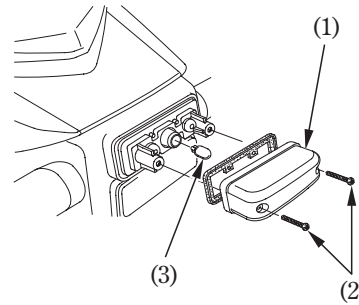

- (1) License light cover
- (2) Screws
- (3) Bulb

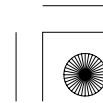
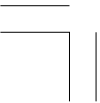

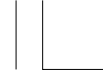

CLEANING

Clean your motorcycle regularly to protect the surface finishes and inspect for damage, wear, and oil, coolant or brake fluid leakage.

Avoid cleaning products that are not specifically designed for motorcycle or automobile surfaces.

They may contain harsh detergents or chemical solvents that could damage the metal, paint, and plastic on your motorcycle.

If your motorcycle is still warm from recent operation, give the engine and exhaust system time to cool off.

We recommend avoiding the use of high pressure water spray (typical in coin-operated car washes).

NOTICE

High pressure water (or air) can damage certain parts of the motorcycle.

Washing the Motorcycle

1. Rinse the motorcycle thoroughly with cool water to remove loose dirt.
2. Clean the motorcycle with a sponge or soft cloth using cool water.
Avoid directing water to muffler outlets and electrical parts.
3. Clean the plastic parts using a cloth or sponge dampened with a solution of mild detergent and water. Rub the soiled area gently rinsing it frequently with fresh water.
Take care to keep brake fluid or chemical solvents off the motorcycle.
They will damage the plastic and painted surfaces.

The inside of the headlight lens may be clouded immediately after washing the motorcycle. Moisture condensation inside the headlight lens will disappear gradually by lighting the headlight in high beam. Run the engine while keeping the headlight on.

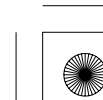
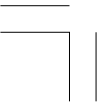



4. After cleaning, rinse the motorcycle thoroughly with plenty of clean water. Strong detergent residue can corrode alloy parts.
5. Dry the motorcycle, start the engine, and let it run for several minutes.
6. Test the brakes before riding the motorcycle. Several applications may be necessary to restore normal braking performance.
7. Lubricate the drive chain immediately after washing and drying the motorcycle.

Finishing Touches

After washing your motorcycle, consider using a commercially-available spray cleaner/polish or quality liquid or paste wax to finish the job. Use only a non-abrasive polish or wax made specifically for motorcycles or automobiles. Apply the polish or wax according to the instructions on the container.

Braking efficiency may be temporarily impaired immediately after washing the motorcycle. Anticipate longer stopping distance to avoid a possible accident.

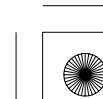



Removing Road Salt

Seawater can be found on the road near the seaside.

The salt in seawater causes rust.

Wash your motorcycle as follows after it has run through salty water.

1. Clean the motorcycle using cool water (page 115).

Do not use warm water.

This worsens the effect of the salt.

2. Dry the motorcycle and make sure the metal is protected with the wax.

Painted Aluminum Wheel Maintenance

Aluminum may corrode from contact with dirt, mud, or road salt. Clean the wheels after riding through any of these substances. Use a wet sponge and mild detergent. Avoid stiff brushes, steel wool, or cleaners containing abrasives or chemical compounds.

After washing, rinse with plenty of water and dry with a clean cloth.

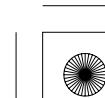
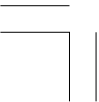



Clean the Mat Painted Surface

Using plenty of water, clean the mat painted surface with a soft cloth or sponge. Dry with a soft, clean cloth.

Use neutral detergent to clean mat painted surface.

Do not use waxes containing compounds.

Exhaust Pipe and Muffler Maintenance

When the exhaust pipe and muffler are painted, do not use a commercially available abrasive kitchen cleaning compound. Use a neutral detergent to clean the painted surface on the exhaust pipe and muffler. If you are not sure if your exhaust pipe and muffler are painted, contact your dealer.

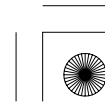
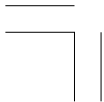



STORAGE GUIDE

Extended storage, requires that you take certain steps to reduce the effects of deterioration from non-use of the motorcycle. In addition, necessary repairs should be made BEFORE storing the motorcycle; otherwise, these repairs may be forgotten by the time the motorcycle is removed from storage.

STORAGE

1. Change the engine oil.
2. Make sure the cooling system is filled with a genuine HONDA PRE-MIX COOLANT.
3. Empty the fuel tank into an approved petrol container using a commercially available hand siphon or an equivalent method. Spray the inside of the tank with an aerosol rust-inhibiting oil.
Reinstall the fuel fill cap on the tank.

WARNING

Petrol is highly flammable and explosive. You can be burned or seriously injured when handling fuel.

- Stop the engine and keep heat, sparks, and flame away.
- Refuel only outdoors.
- Wipe up spills immediately.

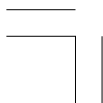



4. To prevent rusting in the cylinder, perform the following:
 - Remove the spark plug cap from the spark plug. Using tape or string, secure the cap to any convenient plastic body part so that it is positioned away from the spark plug.
 - Remove the spark plug from the engine. Do not connect the spark plug to the spark plug cap.
 - Pour a tablespoon (15–20 cm³) of clean engine oil into the cylinder and cover the spark plug hole with a piece of cloth.
 - Crank the engine several times to distribute the oil.
 - Reinstall the spark plug and spark plug cap.
5. Remove the battery. Store in an area protected from freezing temperatures and direct sunlight.
Slow charge the battery once a month.
6. Wash and dry the motorcycle. Wax all painted surfaces. Coat chrome with rustinhibiting oil.
7. Lubricate the drive chain (page 91).
8. Inflate the tyres to their recommended pressures. Place the motorcycle on blocks to raise both tyres off the ground.
9. Cover the motorcycle (don't use plastic or other coated materials) and store in an unheated area, free of dampness with a minimum of daily temperature variation. Do not store the motorcycle in direct sunlight.

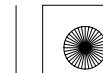



REMOVAL FROM STORAGE

1. Uncover and clean the motorcycle.
2. Change the engine oil if more than 4 months have passed since the start of storage.
3. Charge the battery as required. Install the battery.
4. Drain any excess aerosol rust-inhibiting oil from the fuel tank. Fill the fuel tank with fresh petrol.
5. Perform all Pre-ride Inspection checks (page 55).
Test ride the motorcycle at low speeds in a safe riding area away from traffic.

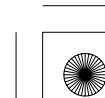



TAKING CARE OF THE UNEXPECTED

IF YOU CRASH

Personal safety is your first priority after a crash. If you or anyone else has been injured, take time to assess the severity of the injuries and whether it is safe to continue riding. Call for emergency assistance if needed. Also follow applicable laws and regulations if another person or vehicle is involved in the crash.

If there is minor damage, or you are unsure about possible damage, ride slowly and cautiously. Sometimes, crash damage is hidden or not immediately apparent, so you should have your motorcycle thoroughly checked at a qualified service facility as soon as possible. Also, be sure to have your dealer check the frame and suspension after any serious crash.

If you decide that you are capable of riding safely, first evaluate the condition of your motorcycle. If the engine is still running, turn it off and look it over carefully; inspect it for fluid leaks, check the tightness of critical nuts and bolts, and secure such parts as the handlebar, control levers, brakes, and wheels.

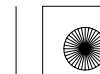



SPECIFICATIONS

DIMENSIONS

Overall length	2,030 mm (79.9 in)
Overall width	720 mm (28.3 in)
Overall height	1,127 mm (44.4 in)
Wheelbase	1,369 mm (53.9 in)

CAPACITIES

Engine oil	After draining	1.4 ℓ (1.5 US qt , 1.2 Imp qt)
	After draining and oil filter change	1.5 ℓ (1.6 US qt , 1.3 Imp qt)
	After disassembly	1.8 ℓ (1.9 US qt , 1.6 Imp qt)
Fuel tank		13.0 ℓ (3.43 US gal , 2.86 Imp gal)
Cooling system capacity		1.1 ℓ (1.2 US qt , 1.0 Imp qt)
Passenger capacity		Operator and one passenger
Maximum weight capacity		140 kg (309 lb)

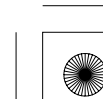
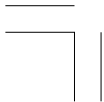



10/11/05 11:32:33 32KYJE00_134

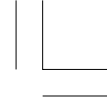

ENGINE

Bore and stroke
Compression ratio
Displacement
Spark plug
Standard

76.0 × 55.0 mm (2.99 × 2.17 in)
10.7 : 1
249.6 cm³ (15.23 cu-in)

SIMR8A9 (NGK)

Spark plug gap
Idle speed

0.80 – 0.90 mm (0.031 – 0.035 in)
1,400 ± 100 min⁻¹ (rpm)

Valve clearance (Cold)

Intake 0.16 mm (0.006 in)
Exhaust 0.27 mm (0.011 in)

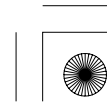



CHASSIS AND SUSPENSION

Caster	25°
Trail	95 mm (3.7 in)
Tyre size, front	110/70-17M/C 54S IRC RX-01FD
Tyre size, rear	140/70-17M/C 66S IRC RX-01RZ
Tyre type	bias-ply, tubeless



POWER TRANSMISSION

Primary reduction	2.808
Gear ratio, 1st	3.333
2nd	2.117
3rd	1.571
4th	1.304
5th	1.115
6th	0.962
Final reduction	2.714

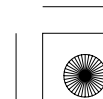



ELECTRICAL

Battery
Generator

12V – 6Ah (10HR)
0.34 kW/5,000 min⁻¹ (rpm)

LIGHTS

Headlight
Brake/Tail light
Turn signal light

Front
Rear

12V – 60/55W
12V – 21/5W
12V – 21W
12V – 21W
12V – 5W
12V – 5W
12V – 1.7W

Position light
License light
Neutral indicator



FUSE

Main fuse
Other fuses

30 A
10 A (CBR250R)
10 A, 30 A (CBR250RA)

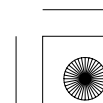
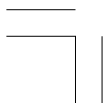



CATALYTIC CONVERTER

This motorcycle is equipped with a catalytic converter.

The catalytic converter contains precious metals that serve as catalysts, promoting chemical reactions to convert the exhaust gasses without affecting the metals.

The catalytic converter acts on HC, CO, and NOx. A replacement unit must be an original Honda part or its equivalent.

The catalytic converter must operate at a high temperature for the chemical reactions to take place. It can set on fire any combustible materials that come near it. Park your motorcycle away from high grasses, dry leaves, or other flammables.

A defective catalytic converter contributes to air pollution, and can impair your engine's performance. Follow these guidelines to protect your motorcycle's catalytic converter.

- Always use unleaded petrol. Even a small amount of leaded petrol can contaminate the catalyst metals, making the catalytic converter ineffective.
- Keep the engine in good running condition.
A poorly running engine can cause the catalytic converter to overheat causing damage to the converter or the motorcycle.
- If your engine is misfiring, backfiring, stalling, or otherwise not running properly, stop riding and turn off the engine. Have your motorcycle serviced as soon as possible.

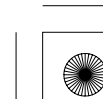
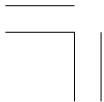

Free Manuals Download Website

<http://myh66.com>

<http://usermanuals.us>

<http://www.somanuals.com>

<http://www.4manuals.cc>

<http://www.manual-lib.com>

<http://www.404manual.com>

<http://www.luxmanual.com>

<http://aubethermostatmanual.com>

Golf course search by state

<http://golfingnear.com>

Email search by domain

<http://emailbydomain.com>

Auto manuals search

<http://auto.somanuals.com>

TV manuals search

<http://tv.somanuals.com>