

2022



GOLDWING

OWNER'S MANUAL

GL1800



This manual should be considered a permanent part of the vehicle and should remain with the vehicle when it is resold.

This publication includes the latest production information available before printing. Honda Motor Co., Ltd. reserves the right to make changes at any time without notice and without incurring any obligation.

For Navigation System operating instructions, refer to the Navigation System manual.

No part of this publication may be reproduced without written permission.

The vehicle pictured in this owner's manual may not match your actual vehicle.

Welcome

Congratulations on your purchase of a new Honda vehicle. Your selection of a Honda makes you part of a worldwide family of satisfied customers who appreciate Honda's reputation for building quality into every product.

To ensure your safety and riding pleasure:

- Read this owner's manual carefully.
- Follow all recommendations and procedures contained in this manual.
- Pay close attention to safety messages contained in this manual and on the vehicle.

To protect your investment, we urge you to take responsibility for keeping your vehicle well serviced and maintained.

Also, observe the break-in guidelines, and always perform the pre-ride inspection and other periodic checks in this manual.

When service is required, remember that your Honda dealer knows your vehicle best. If you have the required mechanical "know-how" and tools, you can purchase an official Honda Service Manual to help you perform many maintenance and repair tasks. ➤ P. 237

Read the warranty information thoroughly so that you understand the warranty coverage and that you are aware of your rights and responsibilities. ➤ P. 238

You may also want to visit our website at www.powersports.honda.com.

Canada www.honda.ca.
Happy riding!

California Perchlorate Contamination Prevention Act

CR type batteries in this vehicle may contain perchlorate materials - special handling may apply. See www.dtsc.ca.gov/hazardouswaste/perchlorate/

A Few Words About Safety

Your safety, and the safety of others, is very important. Operating this vehicle safely is an important responsibility.

To help you make informed decisions about safety, we have provided operating procedures and other information on safety labels and in this manual. This information alerts you to potential hazards that could hurt you or others.

Of course, it is not practical or possible to warn you about all hazards associated with operating or maintaining a vehicle. You must use your own good judgment.

You will find important safety information in a variety of forms, including:

- Safety labels on the vehicle
- Safety Messages preceded by a safety alert symbol  and one of three signal words: DANGER, WARNING, or CAUTION.

These signal words mean:

DANGER

You **WILL** be **KILLED** or **SERIOUSLY HURT** if you don't follow instructions.

WARNING

You **CAN** be **KILLED** or **SERIOUSLY HURT** if you don't follow instructions.

CAUTION

You **CAN** be **HURT** if you don't follow instructions.

Other important information is provided under the following titles:

NOTICE

Information to help you avoid damage to your vehicle, other property, or the environment.

Contents

Vehicle Safety P. 2

Operation Guide P. 18

Maintenance P. 152

Troubleshooting P. 185

Information P. 215

Specifications P. 244

Vehicle Safety

This section contains important information for safe riding of your vehicle.
Please read this section carefully.

Safety Guidelines	P. 3
Safety Labels	P. 6
Safety Precautions	P. 10
Riding Precautions	P. 13
Accessories & Modifications	P. 17
Loading	P. 17

Safety Guidelines

Follow these guidelines to enhance your safety:

- Perform all routine and regular inspections specified in this manual.
- Stop the engine and keep sparks and flame away before filling the fuel tank.
- Do not run the engine in enclosed or partly enclosed areas. Carbon monoxide in exhaust gases is toxic and can kill you.
- Do not ride the vehicle with the mirrors folded inward, as the mirrors can interfere with the handlebar controls.

⚠ WARNING

Riding the vehicle with the mirrors folded inward can interfere with your ability to safely operate the vehicle and could lead to a crash which you can be seriously hurt or killed.

Make sure the mirrors are fully extended outward and secured in place before riding the vehicle.

Always Wear a Helmet

It's a proven fact: helmets and protective apparel significantly reduce the number and severity of head and other injuries. So always wear an approved helmet and protective apparel.  P. 10

Before Riding

Make sure that you are physically fit, mentally focused and free of alcohol and drugs.

Check that you and your passenger are both wearing an approved helmet and protective apparel. Instruct your passenger on holding onto the grab rails or your waist, leaning with you in turns, and keeping their feet on the step boards, even when the vehicle is stopped.

Take Time to Learn & Practice

Even if you have ridden other vehicles, practice riding in a safe area to become familiar with how this vehicle works and handles, and to become accustomed to the vehicle's size and weight.

We recommend that all riders take a certified course approved by the Motorcycle Safety Foundation (MSF) or a state approved training course. New riders should start with the basic course, and even experienced riders will find the advanced course beneficial.

For information about the MSF training course nearest you, call the national toll-free number: (800) 446-9227.

USA Other riding tips can be found in the *You and Your Motorcycle Riding Tips* booklet that came with your vehicle.

Ride Defensively

Always pay attention to other vehicles around you, and do not assume that other drivers see you. Be prepared to stop quickly or perform an evasive maneuver.

Make Yourself Easy to See

Make yourself more visible, especially at night, by wearing bright reflective clothing, positioning yourself so other drivers can see you, signaling before turning or changing lanes, and using your horn when necessary.

Ride within Your Limits

Never ride beyond your personal abilities or faster than conditions warrant. Fatigue and inattention can impair your ability to use good judgment and ride safely.

Don't Drink or Use Drugs and Ride

Alcohol or drugs and riding don't mix. Even one alcoholic drink can reduce your ability to respond to changing conditions, and your reaction time gets worse with every additional drink. The same is true for drug use. Don't drink or use and ride, and don't let your friends do it either.

Keep Your Honda in Safe Condition

It's important to keep your vehicle properly maintained and in safe riding condition. Inspect your vehicle before every ride and perform all recommended maintenance. Never exceed load limits (➤ P. 17), and do not modify your vehicle or install accessories that would make your vehicle unsafe (➤ P. 17).

If You are Involved in a Crash

Personal safety is your first priority. If you or anyone else has been injured, take time to assess the severity of the injuries and whether it is safe to continue riding. Call for emergency assistance if needed. Also follow applicable laws and regulations if another person or vehicle is involved in the crash.

If you decide to continue riding, first turn the ignition switch to OFF, and evaluate the condition of your vehicle. Inspect for fluid leaks, check the tightness of critical nuts and bolts, and check the handlebars, control levers, brakes, and wheels. Ride slowly and cautiously. Your vehicle may have suffered damage that is not immediately apparent. Have your vehicle thoroughly checked at a qualified service facility as soon as possible.

Emergency Shut-down Procedure for Vehicles Equipped with Dual Clutch Transmission

GL1800BD/D/DA

Unlike standard vehicles, or its manual transmission sibling, the GL1800BD/D/DA with dual clutch transmission does not have a clutch lever that would provide you with an additional means to control the engine power being transmitted to the rear wheel. Thus, in the unlikely event that you experience a stuck throttle or other unintended application of power to the rear wheel, you should shut down the engine by use of the engine stop switch (▶ P. 52).

By moving this switch to the  (Stop) position, you will immediately stop the engine but maintain all electrical system functions, including lights and indicators.

Carbon Monoxide Hazard

Exhaust contains poisonous carbon monoxide, a colorless, odorless gas. Breathing carbon monoxide can cause loss of consciousness and may lead to death.

If you run the engine in confined or even partly enclosed area, the air you breathe could contain a dangerous amount of carbon monoxide. Never run your vehicle inside a garage or other enclosure.

WARNING

Running the engine of your vehicle while in an enclosed or even partially enclosed area can cause a rapid build-up of toxic carbon monoxide gas.

Breathing this colorless, odorless gas can quickly cause unconsciousness and lead to death.

Only run your vehicle's engine when it is located in a well ventilated area outdoors.

Safety Labels

Safety and information labels on your vehicle provide important safety information and may warn you of potential hazards that could cause serious injury. Read these labels carefully and don't remove them. If a label comes off or becomes hard to read, contact your dealer for a replacement.

GL1800/D/DA

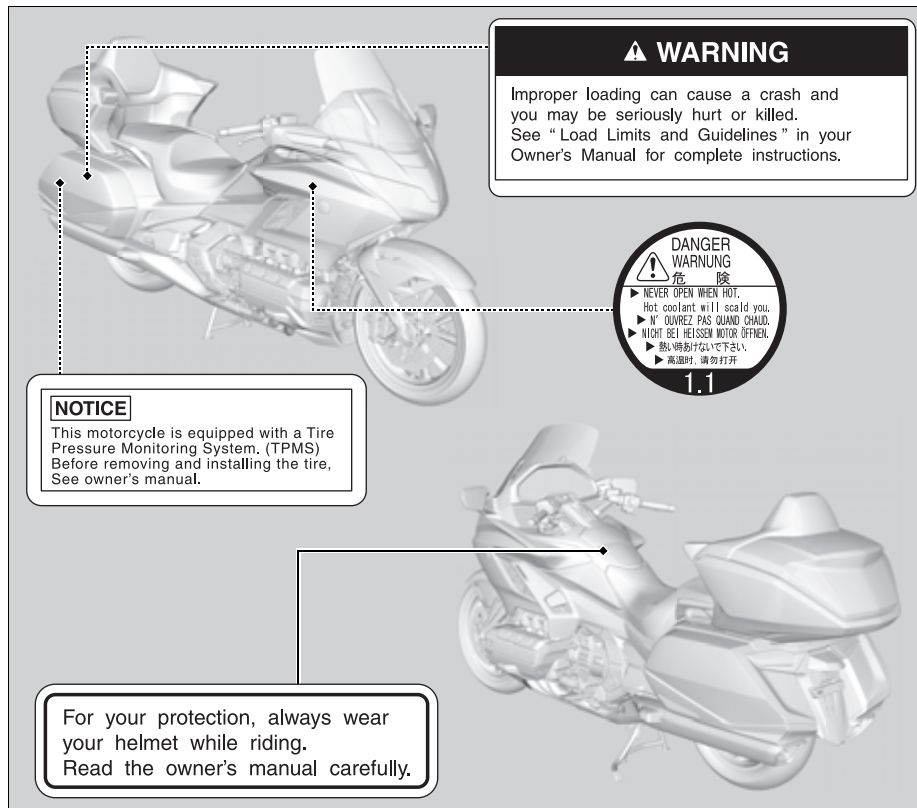

GL1800DA

CARGO LIMIT

2.0kg / 4.5lbs

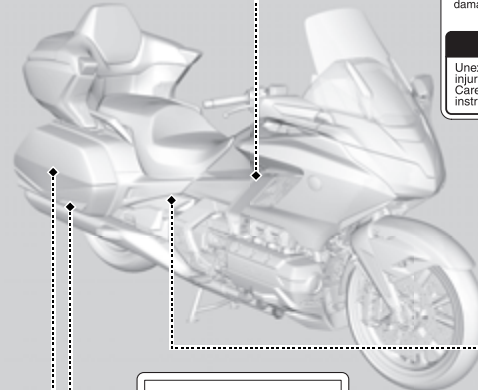

EQUIPPED WITH AIRBAGS

All airbag system wires/connectors are yellow. Disconnecting, tampering with, or using test equipment on any yellow wires or connectors can cause system damage or accidental deployment.

⚠️ WARNING

Unexpected deployment could cause serious injury to you or others. Carefully follow the Service Manual instructions.

CARGO LIMIT

9.0kg / 20.0lbs

GL1800/D

TIRE INFORMATION

		kPa	kgf/cm ²	psi
Cold tire pressures	Front	250	2.50	36
	Rear	280	2.80	41
Up to maximum weight capacity	Front	250	2.50	36
	Rear	280	2.80	41
Up to 90kg(200lbs) load	Front	250	2.50	36
	Rear	280	2.80	41
Tire size	Front	180VZ18M/C 65H		
	Rear	200/55R16M/C 77H		
Min. recommend tire center tread depth.	Front	1.5mm(0.06in.)		
	Rear	2.0mm(0.08in.)		
Maximum weight capacity		192kg(423lbs)		
Read owner's manual.				

GL1800/D

Cargo Limit

3.0kg / 6.6lbs

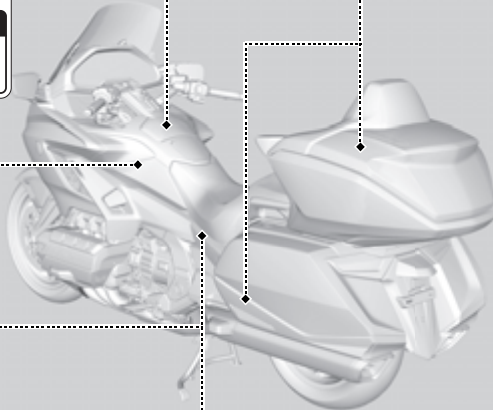

CARGO LIMIT

9.0kg / 20.0lbs

GL1800DA

TIRE INFORMATION

		kPa	kgf/cm ²	psi
Cold tire pressures	Front	250	2.50	36
	Rear	280	2.80	41
Up to maximum weight capacity	Front	250	2.50	36
	Rear	280	2.80	41
Up to 90kg(200lbs) load	Front	250	2.50	36
	Rear	280	2.80	41
Tire size	Front	180VZ18M/C 65H		
	Rear	200/55R16M/C 77H		
Min. recommend tire center tread depth.	Front	1.5mm(0.06in.)		
	Rear	2.0mm(0.08in.)		
Maximum weight capacity		189kg(417lbs)		
Read owner's manual.				

⚠️ WARNING

Airbag system wires and connectors are yellow. Tampering with, cutting, splicing, or disconnecting yellow wires/connectors could cause airbag deployment or a system failure resulting in serious injury or death.

GL1800B/BD

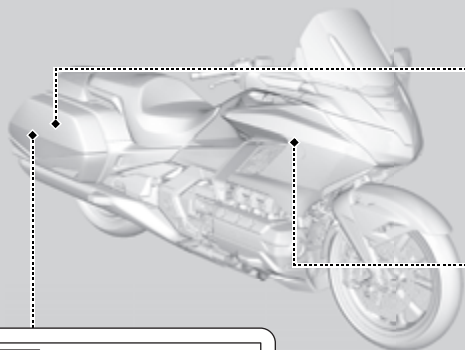

⚠ WARNING

Improper loading can cause a crash and you may be seriously hurt or killed. See "Load Limits and Guidelines" in your Owner's Manual for complete instructions.

NOTICE

This motorcycle is equipped with a Tire Pressure Monitoring System. (TPMS) Before removing and installing the tire, See owner's manual.

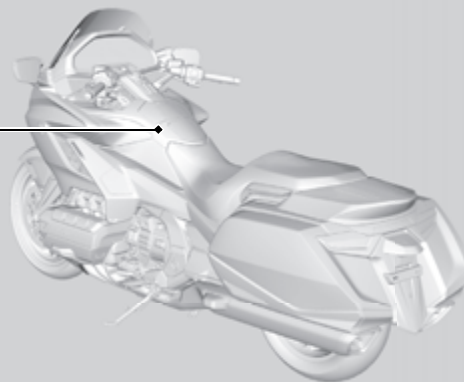

For your protection, always wear your helmet while riding. Read the owner's manual carefully.

CARGO LIMIT

2.0kg / 4.5lbs

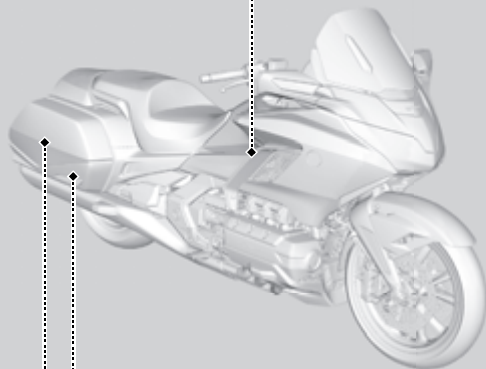

CARGO LIMIT

9.0kg / 20.0lbs



Cargo Limit

3.0kg / 6.6lbs

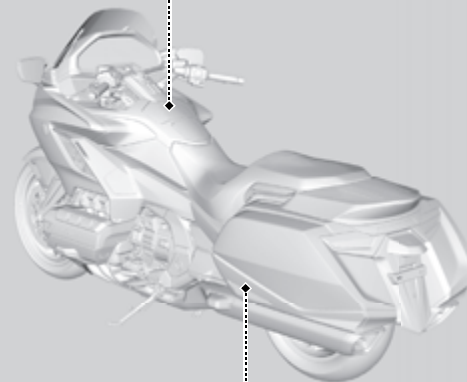

CARGO LIMIT

9.0kg / 20.0lbs



TIRE INFORMATION

Cold tire pressures		kPa	kg/cm ²	psi
Up to maximum weight capacity	Front	250	2.50	36
	Rear	280	2.80	41
Up to 90kg(200lbs) load	Front	250	2.50	36
	Rear	280	2.80	41
Tire size	Front	180/70R16M/C 65H		
	Rear	200/55R16M/C 77H		
Min. recommend tire center tread depth	Front	1.5mm(0.06in.)		
	Rear	2.0mm(0.08in.)		
Maximum weight capacity		191kg(421lbs)		

Read owner's manual.

Safety Precautions

- Ride cautiously and keep your hands on the handlebars and feet on the footpegs.
- Keep passenger's hands onto the grab rails or your waist, passenger's feet on the step boards while riding.
- Always consider the safety of your passenger, as well as other drivers and riders.

Protective Apparel

Make sure that you and any passenger are wearing an approved helmet, eye protection, and high-visibility protective clothing. Avoid wearing loose clothes that could get caught on any part of the vehicle. Ride defensively in response to weather and road conditions.

■ Helmet

Should be safety-standard certified, high-visibility, and correct size for your head

- Must fit comfortably but securely, with the chin strap fastened
- Face shield with unobstructed field of vision or other approved eye protection

USA Look for a DOT (Department of Transportation) certification label on any helmet you buy.

WARNING

Not wearing a helmet increases the chance of serious injury or death in a crash.

Make sure that you and any passenger always wear an approved helmet and protective apparel.

■ Gloves

Full-finger leather gloves with high abrasion resistance

■ Boots or Riding Shoes

Sturdy boots with non-slip soles and ankle protection

■ Jacket and Pants

Protective, highly visible, long-sleeved jacket and durable long pants for riding (or a protective suit)

Airbag System

GL1800DA

This section describes some important safety precautions. For airbag system components and features, see “Airbag System.” ➤ P. 64

The airbag system is an integral part of your vehicle and is covered by your new vehicle warranty.

The most important things you need to know about your airbag are:

- The airbag has a limited but very important role.
The airbag can reduce the severity of injuries and help save your life in certain severe frontal impacts. It cannot prevent all injuries or deaths that can occur in a crash, and some crashes are too severe for any safety feature or system to prevent death.
- The airbag is designed to deploy in a severe head-on or nearly head-on frontal impact. The impact can be with another vehicle or an object, such as a concrete highway barrier. A severe frontal impact is one in which the rider would be thrown forward off the front of the vehicle.

- The airbag might deploy in a severe angled frontal collision, or in a sideswipe, or if the vehicle underrides the rear of another vehicle.
However, because there are many variables in a collision, the airbag might not be able to reduce the severity of injuries to the rider.
- The airbag might deploy if the front tire drops into a sharp depression, such as a pothole, or strikes a hard raised object, such as a curb.
A brief high rate of deceleration can cause the airbag to deploy, even though it would not be needed.
- The airbag is designed to help protect the rider.
It is not designed to help protect a passenger.
- The airbag is not intended to replace a helmet.
Helmets have proven effective in reducing the severity of head injuries in all types of crashes. So always wear a helmet, and make sure a passenger wears one as well.

There are several situations in which the vehicle airbag should not deploy. Four of the more common situations are discussed here.

- If a rider is traveling at a moderate speed and has a minor frontal collision, such as running into the rear of a car slowing down ahead, or stopped at a traffic light, the rate of deceleration should be low enough for the rider to either stay on the vehicle or receive less than severe injuries to the head or chest.
- Being struck in the side or rear by another vehicle can result in very serious injuries. But since the sensors are attached to the frame, such a crash cannot be detected by the sensors. Therefore, the airbag should not deploy, and it would not be helpful to the rider even if it did deploy.
- Another situation that should not result in airbag deployment is if the vehicle slides out and goes down on a slippery surface. Again, the crash would not be detected or determined to be a severe frontal impact, and the airbag would not benefit the rider even if it did deploy.

Safety Precautions

- Finally, if the vehicle is involved in a sideswipe with a stationary object, such as a concrete median barrier, or with another vehicle traveling in the same direction, as illustrated here, the airbag should not deploy.

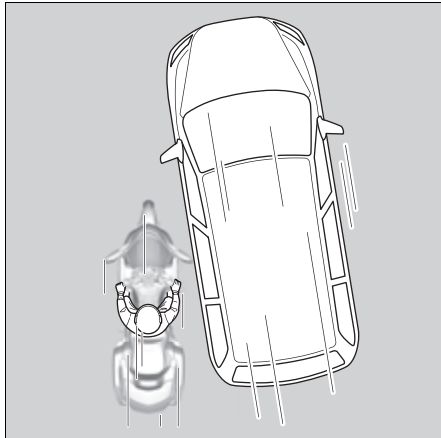

Important Safety Precautions

- Do not install or temporarily attach any items, such as a map holder, over the airbag cover or in the area between the rider's seat and the handlebars. This could prevent the airbag from deploying properly, or cause items to be propelled by the airbag and possibly hurt someone.
- Do not tamper with any system components, including the wires or connectors. Doing so could prevent the airbag system from operating properly or cause unintended airbag deployment and possibly serious injury.
- Do not attempt to remove any airbag components — even temporarily. This could result in unintended airbag deployment and injury.

What you should do: Follow all recommendations in this owner's manual.

Riding Precautions

Break-in Period

During the first 300 miles (500 km) of running, follow these guidelines to ensure your vehicle's future reliability and performance.

- Avoid full-throttle starts and rapid acceleration.
- Avoid hard braking and rapid downshifts.
- Ride conservatively.

Brakes

Observe the following guidelines:

- Avoid excessively hard braking and downshifting.
 - ▶ Sudden braking can reduce the vehicle's stability.
 - ▶ Where possible, reduce speed before turning; otherwise you risk sliding out.
- Exercise caution on low traction surfaces.
 - ▶ The tires slip more easily on such surfaces and braking distances are longer.
- Avoid continuous braking.
 - ▶ Repeated braking, such as when descending long, steep slopes can seriously overheat the brakes, reducing their effectiveness. Use engine braking with intermittent use of the brakes to reduce speed.
- For full braking effectiveness, operate both the front and rear brakes together.

Combined ABS

Your vehicle is equipped with a brake system that distributes the braking force between the front and rear brakes. The distribution of the braking force is applied to both front and rear brakes when operating the lever and/or pedal. For full braking effectiveness, operate both the front and rear brakes together.

The brake feel changes according to the selected riding mode.

➤ P. 134

This model is also equipped with an Anti-lock Brake System (ABS) designed to help prevent the brakes from locking up during hard braking.

- ABS does not reduce braking distance. In certain circumstances, ABS may result in a longer stopping distance.
- ABS does not function at speeds below 3 mph (5 km/h).
- The brake lever and pedal may recoil slightly when applying the brakes. This is normal.
- Always use the recommended tires to ensure correct ABS operation.

Riding Precautions

■ Engine Braking

Engine braking helps slow your vehicle down when you release the throttle. For further slowing action, downshift to a lower gear. Use engine braking with intermittent use of the brakes to reduce speed when descending long, steep slopes.

■ Wet or Rainy Conditions

Road surfaces are slippery when wet, and wet brakes further reduce braking efficiency.

Exercise extra caution when braking in wet conditions.

If the brakes get wet, apply the brakes while riding at low speed to help them dry.

Riding in Bad Weather

If you decide to ride your vehicle in the rain, fog, or other bad-weather conditions, ride carefully. Wet road surfaces reduce traction, especially in turns, and increase stopping distances when you brake.

If the weather turns bad while you are riding, take extra care and do not use cruise control.

When riding in the rain, we recommend you adjust your windscreen height below eye level, if possible, for better visibility.

➤ P. 150

Parking

- Park on a firm, level surface.
- If you must park on a slight incline or loose surface, park so that the vehicle cannot move or fall over.
- Make sure that high-temperature parts cannot come into contact with flammable materials.
- Do not touch the engine, muffler, brakes and other high-temperature parts until they cool down.
- To reduce the likelihood of theft, always lock the handlebars (➤ P. 55) and leave your vehicle while taking the Honda SMART Key with you. Deactivate the Honda SMART Key system if necessary. ➤ P. 56
Use of an anti-theft device is also recommended.

Parking with the Side Stand or Center Stand

1. Stop the engine.
2. **Using the side stand**
Push the side stand down.
Slowly lean the vehicle to the left until its weight rests on the side stand.

Using the center stand

GL1800/D/DA

- To lower the center stand, stand on the left side of the vehicle. Hold the left handle grip and the left grab rail. Press down on the tip of the center stand with your right foot and, simultaneously, pull up and back.
3. Turn the handlebars fully to the left.
 - ▶ Turning the handlebars to the right reduces stability and may cause the vehicle to fall.
 4. Turn the ignition switch to  (Lock).
➤ P. 55
Then, leave your vehicle while taking the Honda SMART Key with you. Deactivate the Honda SMART Key system if necessary. ➤ P. 56

Refueling and Fuel Guidelines

Follow these guidelines to protect the engine, fuel system and catalytic converter:

- Use only unleaded gasoline.
- Use the recommended octane number.
Using lower octane gasoline will result in decreased engine performance.
- Do not use fuels containing a high concentration of alcohol. ➤ P. 236
- Do not use stale or contaminated gasoline or an oil/gasoline mixture.
- Avoid getting dirt or water in the fuel tank.

Honda Selectable Torque Control

GL1800/D/DA

When the Honda selectable torque control (Torque Control) detects rear wheel spin during acceleration, the system will limit the amount of torque applied to the rear wheel based on the Torque Control level set according to the selected riding mode.

Torque Control will allow some wheel spin during acceleration at the lower Torque Control levels settings. Select a riding mode that is appropriate for riding conditions.

➤ P. 134

Torque Control does not work during deceleration and will not prevent the rear wheel from skidding due to engine braking. Do not close the throttle suddenly, especially when riding on slippery surfaces.

Torque Control may not compensate for rough road conditions or rapid throttle operation. Always consider road and weather conditions, as well as your skills and condition, when applying throttle. If your vehicle gets stuck in mud, snow or sand, it may be easier to free it with the Torque Control temporarily switched off.

➤ P. 31

Temporarily turning off Torque Control also may help you maintain control and balance when riding on off-road terrain.

Always use the recommended tires to ensure correct Torque Control operation.

Accessories & Modifications

We strongly advise that you do not add any accessories that were not specifically designed or approved for your vehicle by Honda or make modifications to your vehicle from its original design. Doing so can make it unsafe.

Modifying your vehicle may also void your warranty and make your vehicle illegal to operate on public roads. Before deciding to install accessories on your vehicle, be certain the modification is safe and legal.

WARNING

Improper accessories or modifications can cause a crash in which you can be seriously hurt or killed.

Follow all instructions in this owner's manual regarding accessories and modifications.

Do not pull a trailer with, or attach a sidecar to, your vehicle. Your vehicle was not designed for these attachments, and their use can seriously impair your vehicle's handling.

Loading

- Carrying extra weight affects your vehicle's handling, braking and stability. Always ride at a safe speed for the load you are carrying.
- Avoid carrying an excessive load and keep within specified load limits.
Maximum weight capacity / Maximum luggage weight  P. 244, 246
- Tie all luggage securely, evenly balanced, and close to the center of the vehicle.
- Do not place objects near the lights or the muffler.

WARNING

Overloading or improper loading can cause a crash and you can be seriously hurt or killed.

Follow all load limits and other loading guidelines in this manual.

Parts Location

GL1800/D/DA

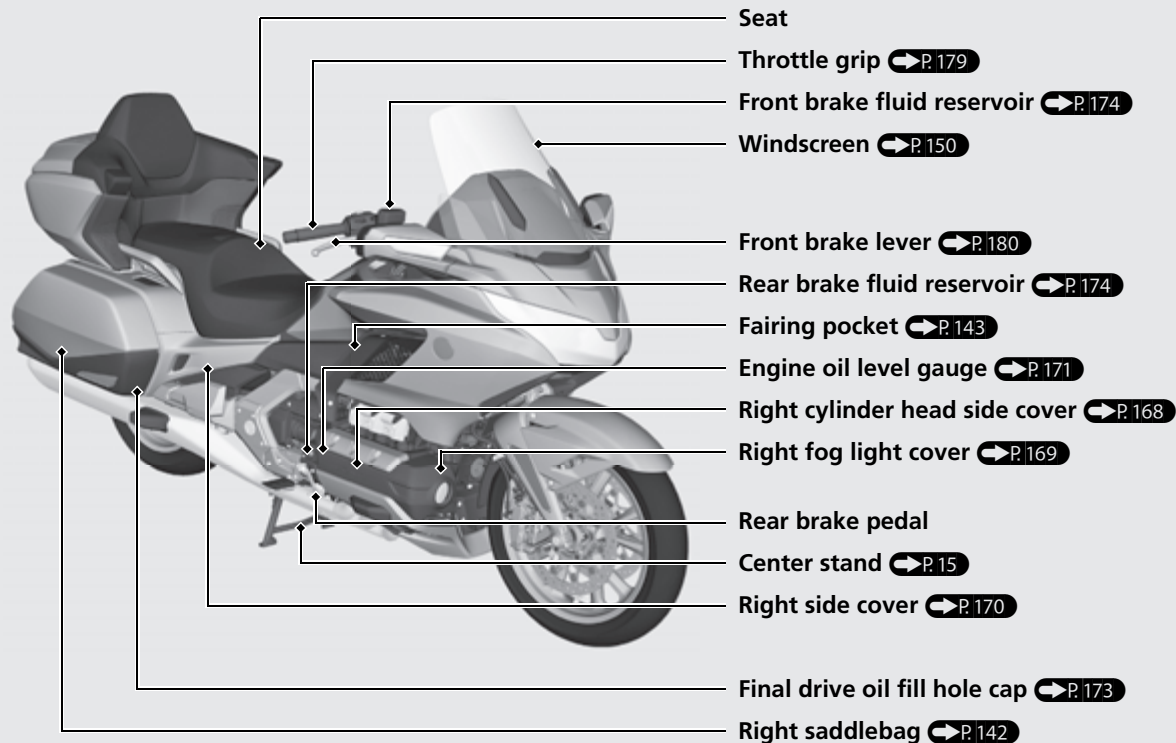

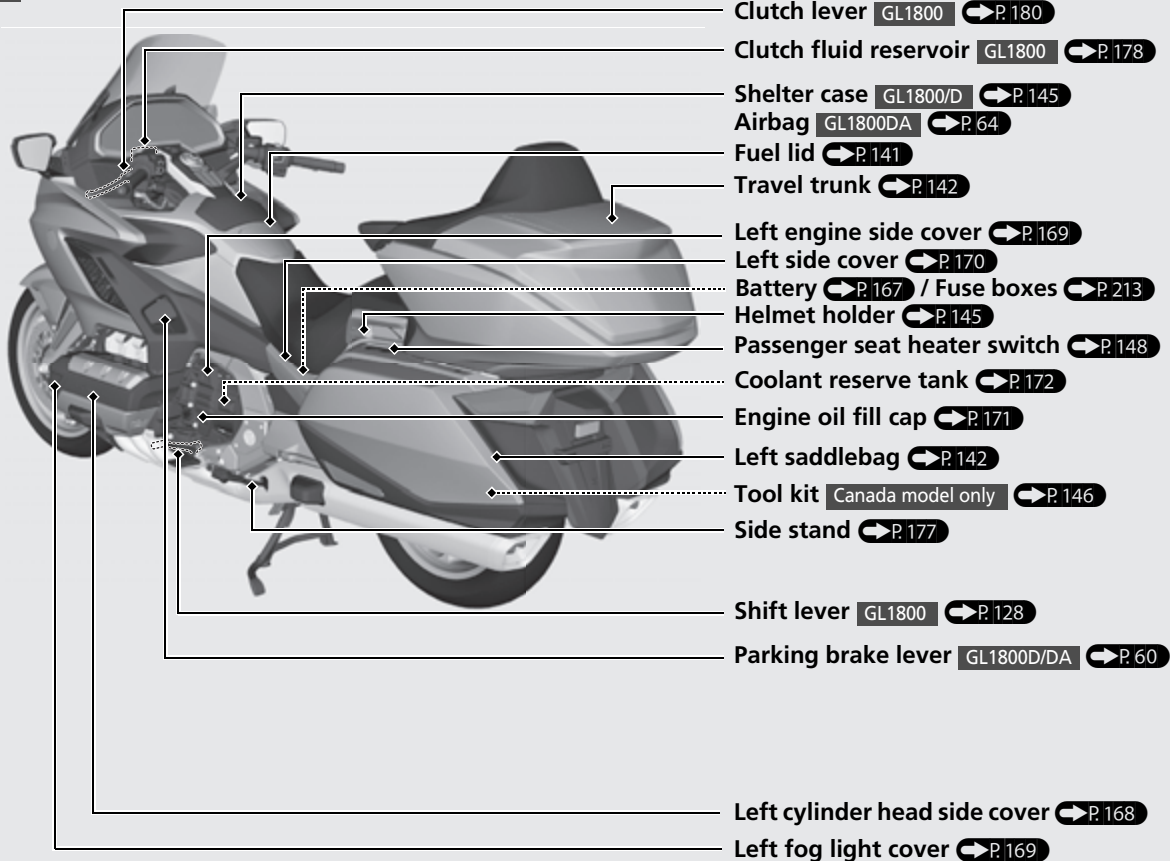

Parts Location *(Continued)*

GL1800B/BD

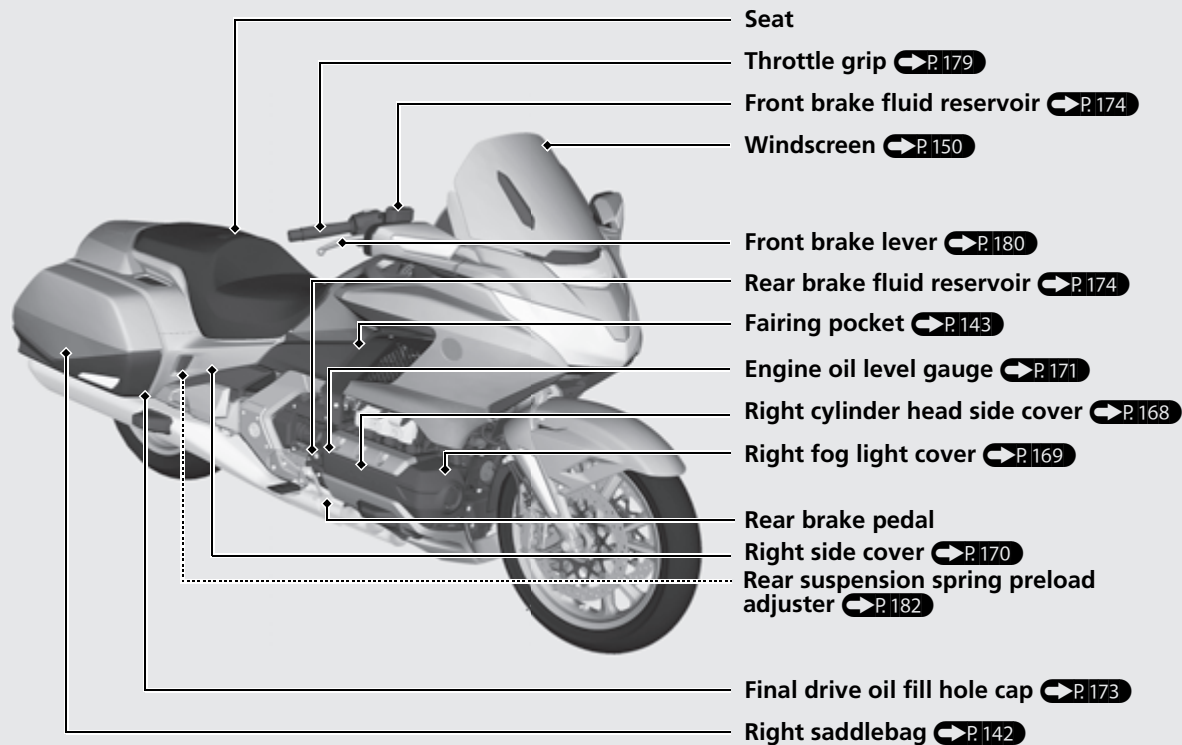

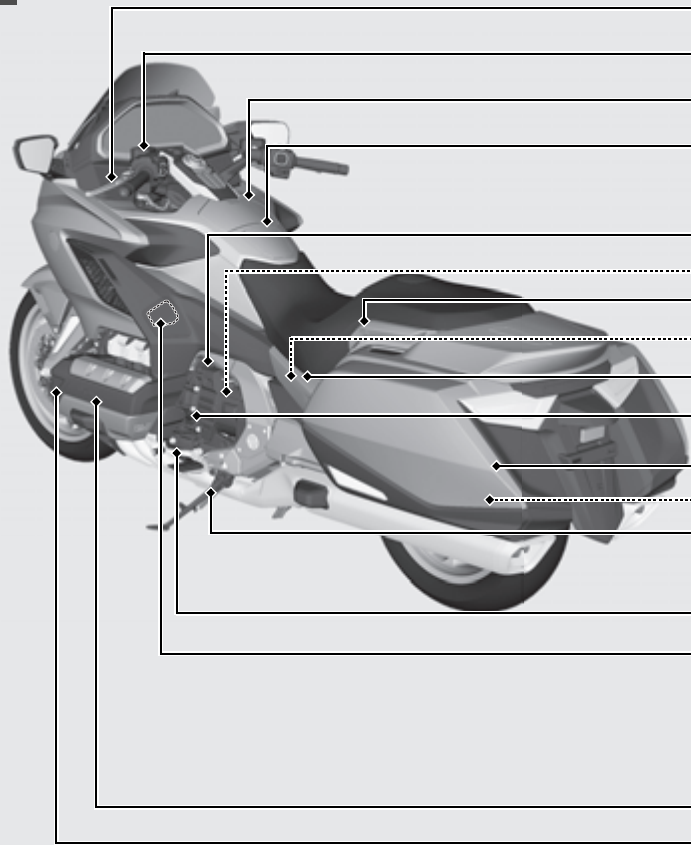

- Clutch lever **GL1800B** ➔ P. 180
- Clutch fluid reservoir **GL1800B** ➔ P. 178
- Shelter case ➔ P. 145
- Fuel lid ➔ P. 141
- Left engine side cover ➔ P. 169
- Coolant reserve tank ➔ P. 172
- Helmet holder ➔ P. 145
- Battery ➔ P. 167 / Fuse boxes ➔ P. 213
- Left side cover ➔ P. 170
- Engine oil fill cap ➔ P. 171
- Left saddlebag ➔ P. 142
- Tool kit **Canada model only** ➔ P. 146
- Side stand ➔ P. 177
- Shift lever **GL1800B** ➔ P. 128
- Parking brake lever **GL1800BD** ➔ P. 60
- Left cylinder head side cover ➔ P. 168
- Left fog light cover ➔ P. 169

Instruments

Multi-information display [↔ P. 23](#)

Speedometer

Shows riding speed in miles per hour (mph) and kilometers per hour (km/h).

Tachometer

NOTICE

Do not operate the engine in the tachometer red zone. Excessive engine speed can adversely affect engine life.

Tachometer red zone

(excessive engine rpm range)

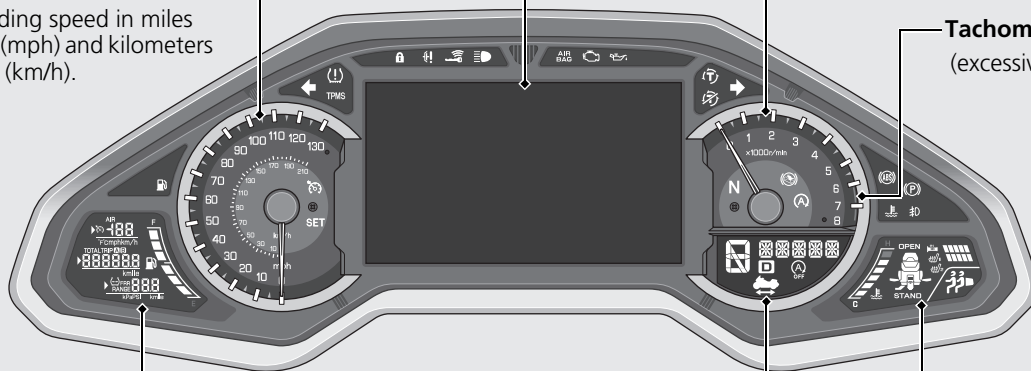

INFO 1 display [↔ P. 34](#)

INFO 2 display [↔ P. 39](#)

INFO 3 display [↔ P. 41](#)

Display Check

When the ignition switch is turned ON, all of the modes and digital segments will show on the INFO 1, INFO 2 and INFO 3 displays, and the opening symbol will show on the multi-information display.

If the displays do not show when they should, have your dealer check for problems.

Multi-information Display

Your vehicle is equipped with a multi-information display that presents various functions and settings.

- Certain manual functions and settings are disabled or inoperable while the vehicle is in motion. You cannot select a grayed-out menu until the vehicle is stopped.

When the ignition switch is turned ON or ACC, the Notice message appears on the screen for a few second.

Read the Notice message.

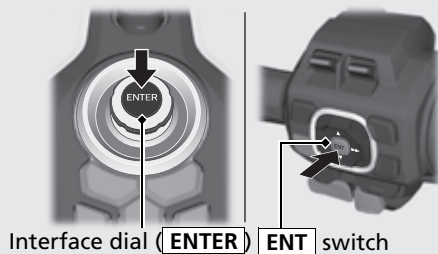
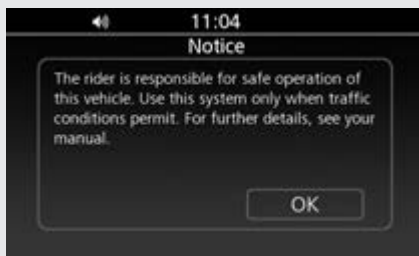

Home Screen

From this screen, you can go to various functions and setup options. When the ignition switch is turned ON or ACC, you will see the screen you used last.

To return to the Home screen: ➔ P.24

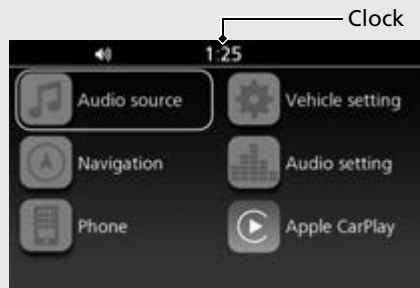

Clock (12-hour display)

To set the clock: ➔ P.79

Audio Source

Enters the current audio mode. ➔ P.71

Vehicle Setting

Enters the vehicle setting menu screen.

➔ P.28

Navigation

Displays the navigation screen. (Refer to the Navigation System manual.)

Audio Setting

Enters the audio setting menu screen.

➔ P.73

Phone

Enters the phone screen. ➔ P.118

Apple CarPlay™

Appears the menu icon when Apple CarPlay is available. ➔ P.111

Android Auto™

Appears the menu icon when Android Auto is available. ➔ P.114



To select a desired setting menu: ➔ P.24

Instruments *(Continued)*





Basic Operations

You can operate and set the various functions of your vehicle using the interface dial and buttons on the center panel and/or switches on the left handlebar. However, you cannot operate some functions by the center panel switches/Interface dial while the vehicle is in motion.

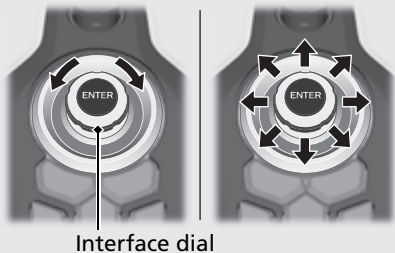
To Select a Desired Setting Menu

To operate with the interface dial on the center panel:
Rotate  (Interface dial) or move  in the eight possible directions to select the available choices.



To operate with the 4-way key switch on the left handlebar:
Press  /  /  /  to select the available choices. Some menu will only use the up and down function.

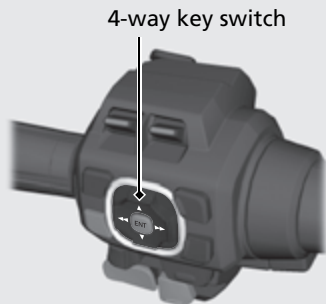



To Set Your Selection

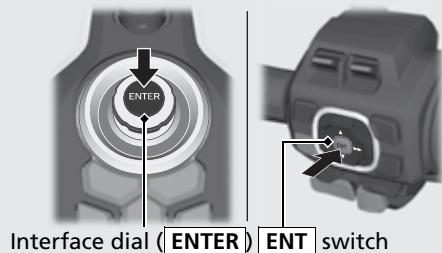

To operate with the interface dial on the center panel:
Press  (**ENTER**) to set your selection.

To operate with the 4-way key switch on the left handlebar:
Press **ENT** switch located at the center of the 4-way key switch to set your selection.



To End the Setting Menu

To return the previous screen:
Press  (Back) button on the center panel or  (Back) switch on the left handlebar.

To return to the Home screen:
Press  (Home) button on the center panel or  (Home) switch on the left handlebar.

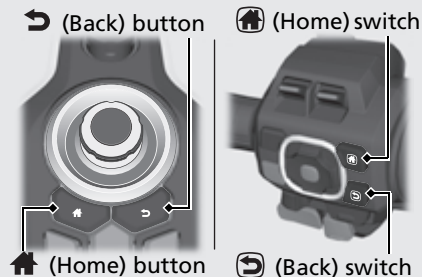

Information Bar

Displays various information (current audio source info., vehicle info., help info., or system info.) on the information bar.



Information bar

Normally, when you press **INFO** button, the current audio source information or vehicle information is displayed.

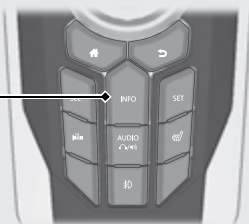

INFO button

To change the current audio source information or vehicle information, press **INFO** button until the desired information is displayed.

The information bar cycles through the information as follows:

No indication



Current audio source information



Trip A fuel consumption



Trip B fuel consumption

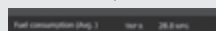

Current Fuel Mileage



Elapsed Time



➡ Press **INFO** button.

In the following cases, the information bar will appear or change from the current indication.

- Helpful information (➡ P.27):
When your vehicle has helpful information to notify you of.
- System information (➡ P.27):
When your vehicle has system information to notify you of.

When your vehicle has information to notify you of, only the highest priority information is displayed. Once you close an interrupt information by pressing **INFO** button, it will not be displayed again until the ignition switch is turned ON again.

Instruments (Continued)

Vehicle Information

Average Fuel Mileage (Trip A/Trip B) [Fuel Consumption (Avg.)]

Displays the average fuel mileage since the individual tripmeter was reset.

The average fuel mileage will be calculated based on the mileage of the individual tripmeter.



Display range: 0.1 to 99.9 MPG (L/100 km or km/L)

- If less than 0.1 MPG (L/100 km or km/L) or more than 99.9 MPG (L/100 km or km/L): "--.-" is displayed.
- When tripmeter A or B is reset: "--.-" is displayed.

When "--.-" is displayed except for the above-mentioned cases, go to your dealer for service.

To change the unit: P.30

To reset the average fuel mileage: P.36

Current Fuel Mileage [Fuel Consumption (Inst.)]

Displays the instantaneous fuel mileage as a bar graph in MPG, L/100 km or km/L.



Bar graph

- When your speed is less than 2 mph (3 km/h): The bar graph is not activated.

When the bar graph is not activated except for the above-mentioned cases, go to your dealer for service.

To change the unit: P.30

Elapsed Time

Displays operating time since the engine was started. (hours : minutes)





- Above 99:59: returns to 00:00.



When the ignition switch is turned OFF, the elapsed time is reset.

Helpful Information

GL1800BD/D/DA

Indication	Explanation	Remedy
	Appears when pressing the Walking Speed mode switch without applying the brake.	Before pressing the Walking Speed mode, apply the brake. For more information, refer to “Walking Speed mode.” ➡ P. 131
	Appears when pressing the start button without applying the brake while the transmission is in gear.	Before pressing the start button, put the gear to Neutral (N indicator comes on) or apply the brake. For more information, refer to “Starting the Engine.” ➡ P. 126

System Information

Indication	Explanation	Remedy
	Appears when communication between your vehicle and Honda SMART Key is interrupted after turning on the electrical system.	Refer to “When the Honda SMART Key System Does Not Operate Properly.” ➡ P. 197
	Appears when the battery of Honda SMART Key is weak.	Refer to “Replacing the Honda SMART Key Battery.” ➡ P. 183



Instruments *(Continued)*

Vehicle Setting

You can configure the vehicle settings.





The vehicle settings are enabled with the ignition switch in ON.

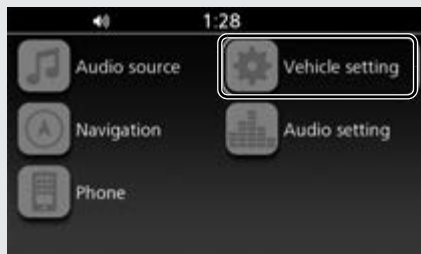



The vehicle settings are disabled while the vehicle is in motion.

Rotate  or press ▲ / ▼ / ◀▶ on the 4-way key switch to select a setting menu. Press  or **ENT** switch to set your selection.



The vehicle settings contain the following:



- [Auto cancel turn signal]  P. 28
- [Idling stop] **GL1800BD/D/DA Canada model only**
 P. 28
- [Suspension preload] **GL1800/D/DA**
 P. 29
- [Units]  P. 30
- [HSTC] **GL1800/D/DA**  P. 31

- [Auto Dimmer Meter Illumination]  P. 32
- [Day / Night]  P. 32
- [Ext. Amp]  P. 33
- [EQ1/EQ2] (Equalizer)  P. 33
- [Head light opening]  P. 33

Auto Cancel Turn Signal

You can enable/disable turn signal automatic cancellation.





- 1 Select [Auto cancel turn signal], and then press  or **ENT** switch to select (enable) or deselect (disable) the function.
- 2 Return to the previous screen or the Home screen.  P. 24

Default: On (selected)

Idling Stop **GL1800BD/D/DA Canada model only**

You can enable/disable the Idling Stop system.



- 1 Select [Idling stop], and then press  or **ENT** switch to change to select (enable) or deselect (disable) the function.
- 2 Return to the previous screen or the Home screen.  P. 24

Default: Off (deselected)

Suspension Preload GL1800/D/DA

You can automatically adjust the rear suspension spring preload according to the riding conditions by selecting from the four pre-programmed settings.

The rear suspension spring preload adjustment can be changed only when your vehicle is stopped.



- 1 Select [Suspension preload], and then press or **ENT** switch.
- 2 Rotate or press **▲ / ▼** on the 4-way key switch to select the setting according to the riding conditions.

The rear suspension adjustment provides the following settings.

Status icon	Riding condition
	Rider only (Minimum preload)
	Rider and luggage
	Rider and passenger
	Rider, passenger and luggage (Maximum preload)

- 3 Press or **ENT** switch to set your selection.
 - ▶ The selected status icon on the INFO 3 display flashes while transitioning between setting modes.The status icon comes on when the suspension adjustment is completed.

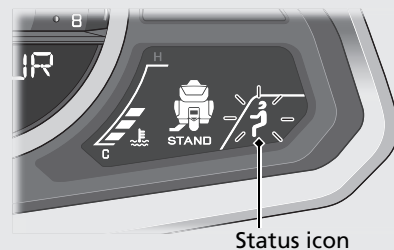

- 4 Return to the previous screen or the Home screen. **P.24**

Electrical Adjustable Suspension:

P.181

Instruments (Continued)

Units

You can change the units used for fuel consumption, distance, temperature and air pressure.

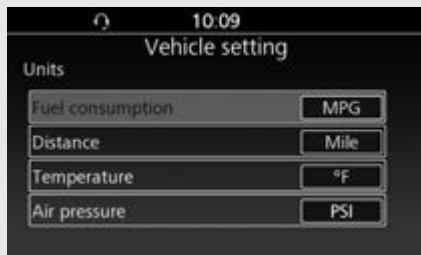

To Change the Unit for Fuel Consumption [Fuel consumption]

If you want to select "L/100 km" or "km/L" for fuel consumption, "km" must be selected in the [Distance] menu in advance. When "Mile" for distance is selected, only "MPG" can be selected.

- 1 Select [Units], and then press or **ENT** switch.
- 2 With [Fuel consumption] selected, press or **ENT** switch until the desired unit is displayed.

Selectable units: L/100 km, km/L or MPG

Default: MPG (USA model) / L/100 km (Canada model)

- 3 Return to the previous screen or the Home screen. P.24

The units for average fuel mileage [Fuel consumption (Avg.)] and current fuel mileage [Fuel consumption (Inst.)] are changed in the information bar.

To Change the Unit for Distance [Distance]

- 1 Select [Units], and then press or **ENT** switch.
- 2 Rotate or press \blacktriangle / \blacktriangledown on the 4-way key switch to select [Distance].
- 3 With [Distance] selected, press or **ENT** switch to select the unit.
▶ In conjunction with the change of the unit for distance, the unit for fuel consumption switches to "L/100 km or km/L" or "MPG" automatically.

Selectable unit: km or Mile

Default: Mile (USA model) / km (Canada model)

- 4 Return to the previous screen or the Home screen. P.24

The units for the cruise control set speed (), odometer [TOTAL], tripmeter A/B [TRIP A/B] and available driving distance [RANGE] are changed in the INFO 1 display. In addition, the units for average fuel mileage [Fuel consumption (Avg.)] and current fuel mileage [Fuel consumption (Inst.)] are changed in the information bar.

To Change the Unit for Air Temperature Gauge [Temperature]

- 1 Select [Units], and then press or **ENT** switch.
- 2 Rotate or press \blacktriangle / \blacktriangledown on the 4-way key switch to select [Temperature].
- 3 With [Temperature] selected, press or **ENT** switch to select the unit.



Selectable unit: °F or °C

Default: °F (USA model) / °C (Canada model)

- 4 Return to the previous screen or the Home screen. P.24

The unit for air temperature gauge [AIR] is changed in the INFO 1 display.

To Change the Unit for Tire Pressure Gauge [Air pressure] GL1800/D/DA

- 1 Select [Units], and then press  or **[ENT]** switch.
- 2 Rotate  or press \blacktriangle / \blacktriangledown on the 4-way key switch to select [Air pressure].
- 3 With [Air pressure] selected, press  or **[ENT]** switch to select the unit.

Selectable unit: PSI or kPa

Default: PSI (USA model) / kPa (Canada model)



- 4 Return to the previous screen or the Home screen.  **P.24**

The unit for air pressure gauge [Air Pressure] is changed in the INFO 1 display.

HSTC (Honda Selectable Torque Control) GL1800/D/DA

You can enable/disable the HSTC function.



- 1 Select [HSTC], and then press  or **[ENT]** switch to select (enable) or deselect (disable) the function.
- 2 Return to the previous screen or the Home screen.  **P.24**



Default: On (selected)

Honda Selectable Torque Control (Torque Control): **P.136**

Auto Dimmer Meter Illumination

You can select the backlight brightness.



- 1 Select [Auto dimmer meter illumination], and then press  or **[ENT]** switch.
- 2 Rotate  or press \blacktriangle / \blacktriangledown on the 4-way key switch to select [AUTO] (Auto adjustment) or your preferred level.



Instruments *(Continued)*

- Return to the previous screen or the Home screen.  [P.24](#)

Setting range: Level 1 to 8 or [AUTO]
Default: [AUTO]

The display can become dark when the display is very hot. If it does not restore the original brightness, contact your dealer.

Automatic Brightness Control:  [P.218](#)

Day / Night

You can adjust the settings for daytime mode and nighttime mode of the navigation map or applications such as Maps (Apple CarPlay and Android Auto).



Changing of Setting Value

When the setting of [Auto dimmer meter illumination] is [Auto]:

If you set to a higher value, the screen will switch to nighttime mode at brighter ambient lighting conditions.

If you set to a lower value, the screen will switch to nighttime mode at darker ambient lighting conditions.

When the setting of [Auto dimmer meter illumination] is not [Auto]:

When the setting value of [Day / Night] is higher than the setting value of [Auto dimmer meter illumination], the screen will switch to nighttime mode.

For example, when the setting value of [Auto dimmer meter illumination] is 5, the screen will switch to nighttime mode if [Day / Night] is set to 6 or higher.



Auto Dimmer Meter Illumination:

 [P.31](#)

Holding the Mode

When [Hold day mode] is selected, the screen is always displayed in daytime mode.

When [Hold night mode] is selected, the screen is always displayed in nighttime mode.

- Select [Day / Night], and then press  or [ENT] switch.
- Rotate  or press ▲ / ▼ on the 4-way key switch to select [Hold day mode], [Hold night mode] or your preferred level.

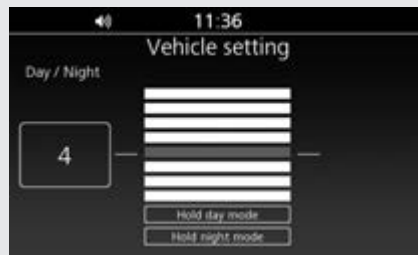

- Return to the previous screen or the Home screen.  [P.24](#)



Default: Level 4

Ext. Amp

You can enable/disable audio output when an external amplifier is connected.

If you want to install an external amplifier, contact your dealer.



- 1 Select [Ext. Amp], and then press  or **ENT** switch to select (enable) or deselect (disable) the function.
- 2 Return to the previous screen or the Home screen.  P.24

Default: Off (deselected)

EQ1/EQ2 (Equalizer)

You can select from two equalizer curves according to the specifications of your vehicle.

- [EQ 1] is an equalizer curve suitable for the front speakers and rear speakers mounted on the travel trunk.
- [EQ 2] is an equalizer curve suitable for the front speakers only or the front speakers and optional rear speakers mounted on the saddlebags.



- 1 Select [EQ1] or [EQ2], and then press  or **ENT** switch to change the equalizer curve.

Default:

GL1800/D/DA : [EQ1]

GL1800B/BD : [EQ2]



- 2 Return to the previous screen or the Home screen.  P.24

Head Light Opening

You can enable/disable the headlight startup lighting when the ignition switch is turned ON.

When the setting is enabled, the headlight gradually lights up.



- 1 Select [Headlight opening], and then press  or **ENT** switch to select (enable) or deselect (disable) the function.
- 2 Return to the previous screen or the Home screen.  P.24

Default: On (selected)

Instruments (Continued)

INFO 1 Display

Odometer & Tripmeter display

Cruise control set speed &
Air temperature gauge display

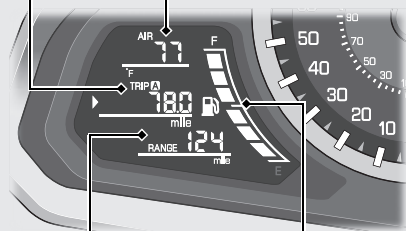

Fuel gauge

GL1800/D/DA Available driving distance
& Tire pressure gauge display

GL1800B/BD Available driving distance
display

INFO 1 display contains the following:

- Cruise control set speed () and Air temperature gauge [AIR] display ➔ P.35
- Odometer [TOTAL] & Tripmeter [TRIP A/ TRIP B] display ➔ P.36

- **GL1800/D/DA** Available driving distance [RANGE] & Tire pressure gauge [() FR/ RR] display ➔ P.37
- **GL1800B/BD** Available driving distance [RANGE] display ➔ P.37
- Fuel gauge ➔ P.38

Changing the INFO 1 Display

Press **SEL** button to move the cursor to a desired display.

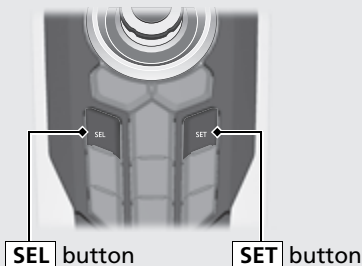

GL1800/D/DA

Odometer & Tripmeter display

Cruise control set speed &
Air temperature gauge display



Available driving distance &
Tire pressure gauge display

➔ Press **SEL** button.

Cruise control set speed & Air temperature gauge display

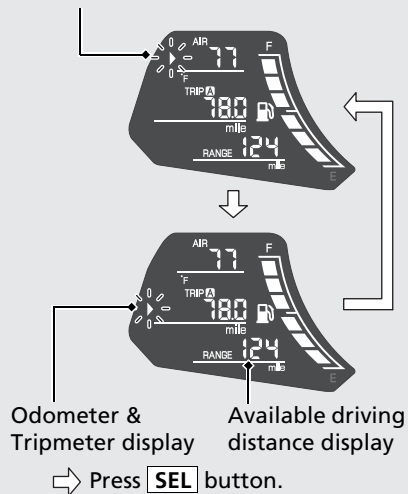

1 Cruise Control Set Speed (🚗) & Air temperature Gauge [AIR] Display

To select cruise control set speed or Air temperature gauge, Press **SET** button when the cursor is at cruise control set speed and Air temperature gauge display.

Cruise control set speed (🚗)

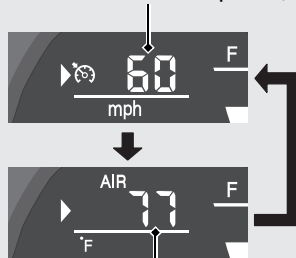

Air temperature gauge

Press **SET** button.

- 1 Press **SEL** button to move the cursor to the cruise control set speed and air temperature gauge display.
- 2 Press **SET** button to select the cruise control set speed or air temperature gauge.

Cruise Control Set Speed (🚗)

The speed set for the cruise control is displayed.

If the cruise control set speed does not memorized, "----" is displayed.

Cruise Control: ➡ P.137

Air Temperature Gauge [AIR]

Displays ambient temperature.

Display range: 14 to 122°F (-10 to 50°C)

- Below 13°F (-11°C): "----" is displayed
- Above 122°F (50°C): 122°F or 50°C flashes

The temperature readout may be incorrect at low speeds due to reflected heat.

Instruments *(Continued)*

■ Odometer [TOTAL] & Tripmeter [TRIP A/B] Display

To select Odometer or Tripmeter A or B, Press **SET** button when the cursor is at the Odometer and Tripmeter display.

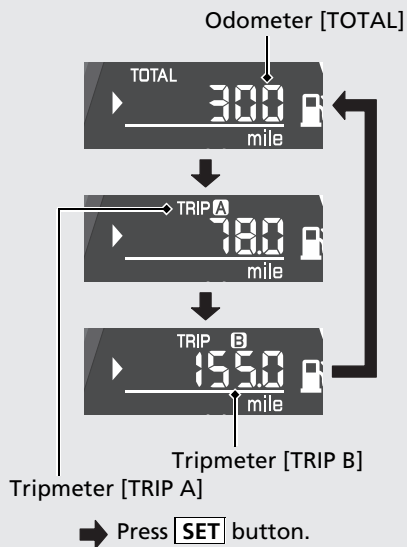

- 1 Press **SEL** button to move the cursor to the odometer, tripmeter A and tripmeter B display.
- 2 Press **SET** button to select the odometer, tripmeter A or tripmeter B.

Odometer [TOTAL]

Total distance ridden.

When "-----" is displayed, go to your dealer for service.

Tripmeter A/B [TRIP A/B]

Distance ridden since the tripmeter was reset.

When "----.-" is displayed, go to your dealer for service.

To reset the tripmeter: **→ P. 36**

■ To Reset the Tripmeter and Average Fuel Mileage

To reset tripmeter A and average fuel mileage (based on tripmeter A), press and hold the **SET** button while tripmeter A is displayed.

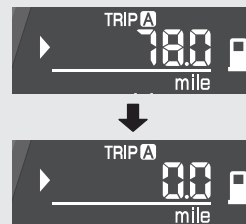

To reset tripmeter B and average fuel mileage (based on tripmeter B), press and hold the **SET** button while tripmeter B is displayed.

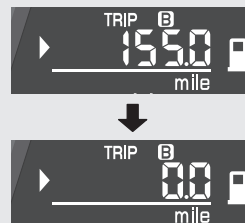

Available Driving Distance [RANGE] & Tire Pressure Gauge [(---) FR/RR] Display

GL1800B/BD

Available driving distance is only displayed.

GL1800/D/DA

To select available driving distance, tire pressure gauge FR or RR, press **SET** button when the cursor is at the available driving distance and tire pressure gauge display.

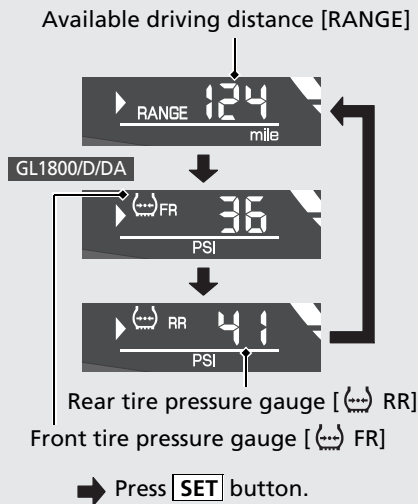

- 1 Press **SEL** button to move the cursor to the available driving distance and tire pressure gauge display.
- 2 Press **SET** button to select the available driving distance, front tire pressure gauge or rear tire pressure gauge.

Available Driving Distance [RANGE]

Displays the estimated distance you can travel on the remaining fuel.

The indicated available driving distance is calculated based on the driving conditions, and the indicated figure may not always be the actual available distance.

- Initial display (factory shipped): “---” is displayed until riding for 4 minutes at 2 mph (3 km/h) or more.
- After the second time, when the amount of remaining fuel does not change, the last driving distance is displayed. When the amount of remaining fuel is changed, recalculate and update the available driving distance.
- When the calculated distance is below 3 mile (5 km) or the amount of remaining fuel is below 0.26 US gal (1.0 liters): “---” is displayed.

When “---” is displayed except for the above-mentioned cases, go to your dealer for service.

Instruments *(Continued)*

Tire Pressure Gauge [] FR/RR

GL1800/D/DA

Displays tire pressure for the selected tire. The system does not monitor the tire pressure at speed below about 16 mph (25 km/h). “---” is displayed until the specified speed is reached.

Display range: 0 to 59 PSI (0 to 405 kPa)

Always use the recommended front/rear tires to ensure correct the tire pressure reading.

The indicated tire pressures may fluctuate when riding because the tire pressure varies according to the temperature. The tire pressure shown on the display may be slightly different from the actual tire pressure as measured by a tire gauge. If there is a significant difference between the two values, or if the low tire pressure indicator and TPMS indicator do not go off after you have inflated the tire to the specified pressure, have the system checked by a dealer.

When “---” is displayed except for the above-mentioned cases, go to your dealer for service.

Fuel Gauge

Remaining fuel when only 1st (E) segment starts flashing: approximately 0.92 US gal (3.5 liters)

At the same time, the low fuel indicator comes on.  P. 44

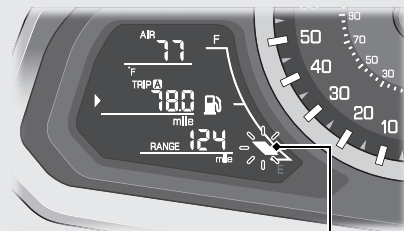

1st (E) segment

If the fuel gauge flashes in a repeat pattern or turns off:  P. 192

INFO 2 Display

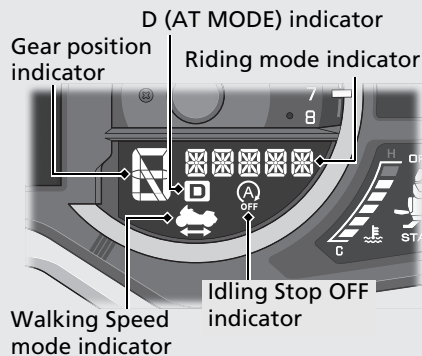

INFO 2 display contains the following:

- Gear position indicator (→ P.39)
- Riding mode indicator (→ P.40)
- **GL1800BD/D/DA**
D (AT MODE) indicator () (→ P.40)
- **GL1800BD/D/DA Canada model only**
Idling Stop OFF indicator () (→ P.40)
- **GL1800BD/D/DA**
Walking Speed mode indicator () (→ P.40)

Gear Position Indicator

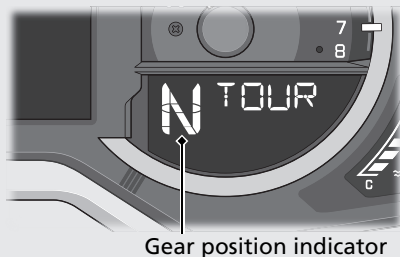

The gear position is shown in the gear position indicator as follows:

GL1800BD/D/DA

Indication	Gear position
1	1st gear
2	2nd gear
3	3rd gear
4	4th gear
5	5th gear
6	6th gear
7	7th gear
N	Neutral
R	Reverse
F	Forward
-	Shifting failure

- ▶ “ - ” flashes when the engine stop switch position is changed from (Run) to (Stop) position with the ignition switch in ON.
- ▶ “ - ” flashes when the ignition switch is turned ON with the engine stop switch in the (Stop) position.

The indicator may flash if:

- ▶ The front wheel leaves the ground.
- ▶ You turn the wheel while the vehicle is upright on the stand.

This is normal. To operate the system again, turn the ignition switch to OFF, and then to ON again.

If “ - ” is blinking in the gear position indicator while riding: (→ P.194)

Instruments *(Continued)*

GL1800/B

Indication	Gear position
I	1st gear
II	2nd gear
III	3rd gear
IV	4th gear
V	5th gear
VI	6th gear
N	Neutral
R	Reverse*
-	Shifting failure

* Except GL1800B USA model

" - " flashes when the transmission is not shifted properly.

Riding Mode Indicator

Refer to "Riding Mode"  P.134

D (AT MODE) Indicator ()

GL1800BD/D/DA

Comes on when AT MODE is selected.

 P.130

Idling Stop OFF Indicator ()

GL1800BD/D/DA Canada model only

Comes on briefly when the ignition switch is turned ON.

Comes on when the Idling Stop system is off.

Idling Stop system:  P.61

Walking Speed Mode Indicator ()

GL1800BD/D/DA

Comes on when in Walking Speed mode.

Walking Speed Mode:  P.131

INFO 3 Display

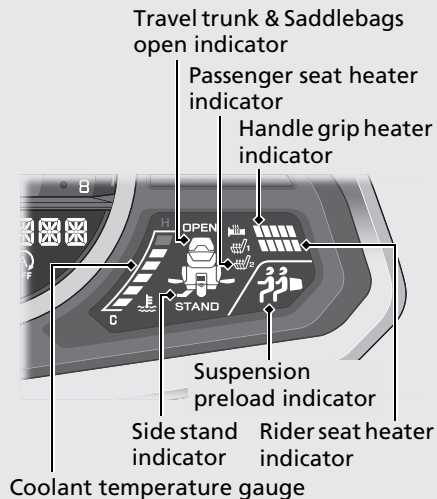

INFO 3 display contains the following:

- Coolant temperature gauge (🌡️) → P. 41
- Travel trunk **GL1800/D/DA** & Saddlebags open indicator → P. 41
- Side stand indicator → P. 42
- Handle grip heater indicator (🔥) → P. 42

- **GL1800/D/DA**
Rider seat heater indicator (🔥) → P. 42
- **GL1800/D/DA**
Passenger seat heater indicator (🔥) → P. 43
- **GL1800/D/DA**
Suspension preload indicator (🚲) → P. 43

Coolant Temperature Gauge (🌡️)

When the coolant is over the specified temperature, the 6th (H) segment flashes and the high coolant temperature indicator comes on.

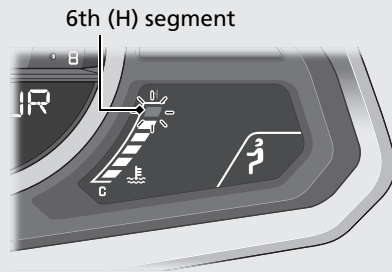

If the 6th (H) segment flashes while riding: → P. 187

If the all segments flashes: → P. 193

Travel Trunk **GL1800/D/DA** & Saddlebags Open Indicator

The segment(s) of open component(s) flashes with the "OPEN" indicator when your vehicle's travel trunk and/or saddlebags are open.

Travel trunk open **GL1800/D/DA**

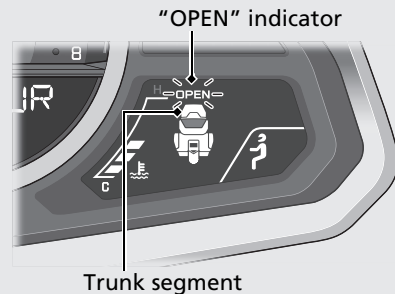

Saddlebag open

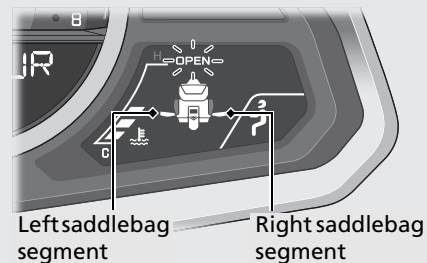

Instruments (Continued)

Side Stand Indicator

The side stand segment flashes with the "STAND" when the side stand is put down. It goes off when the side stand is raised.

Side stand segment

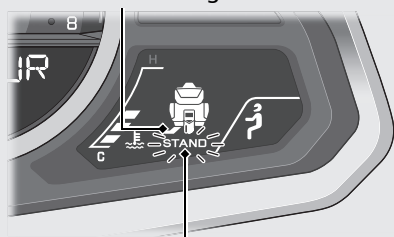

"STAND" indicator

Handle Grip Heater Indicator ()

Comes on when the handle grip heater is on and indicates the selected heater level. The handle grip heater has 5 levels.

Handle grip heater indicator ()

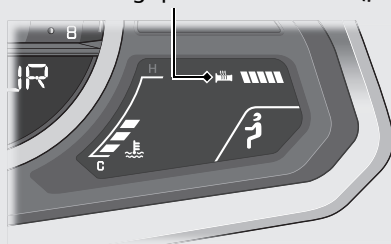

When the handle grip heater indicator flashes, go to your dealer for service.

To operate the handle grip heater:

 **P.147**

If the handle grip heater indicator

blinks:  **P.192**

Rider Seat Heater Indicator ()

GL1800/D/DA

Comes on when the rider seat heater is on and indicates the selected heater level. The rider seat heater has 5 levels.

Rider seat heater indicator ()

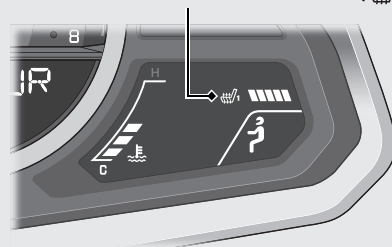

When the rider seat heater indicator flashes, go to your dealer for service.

To operate the rider seat heater:

 **P.148**

If the rider seat heater indicator blinks:

 **P.193**

Passenger Seat Heater Indicator ()

GL1800/D/DA

Comes on when the passenger seat heater is on.

Passenger seat heater indicator ()

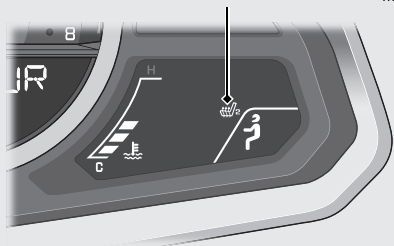

When the passenger seat heater indicator flashes, go to your dealer for service.

To operate the passenger seat heater:

 **P. 149**

If the passenger seat heater indicator blinks:  **P. 193**

Suspension Preload Indicator ()

GL1800/D/DA

Shows selected rear suspension spring preload.

The indicator flashes while transitioning between setting modes.

When the indicator flashes except for the above mentioned cases, go to your dealer for service.

Electrical Adjustable Suspension:

 **P. 181**

Indicators

If one of these indicators does not come on when it should, have your dealer check for problems.

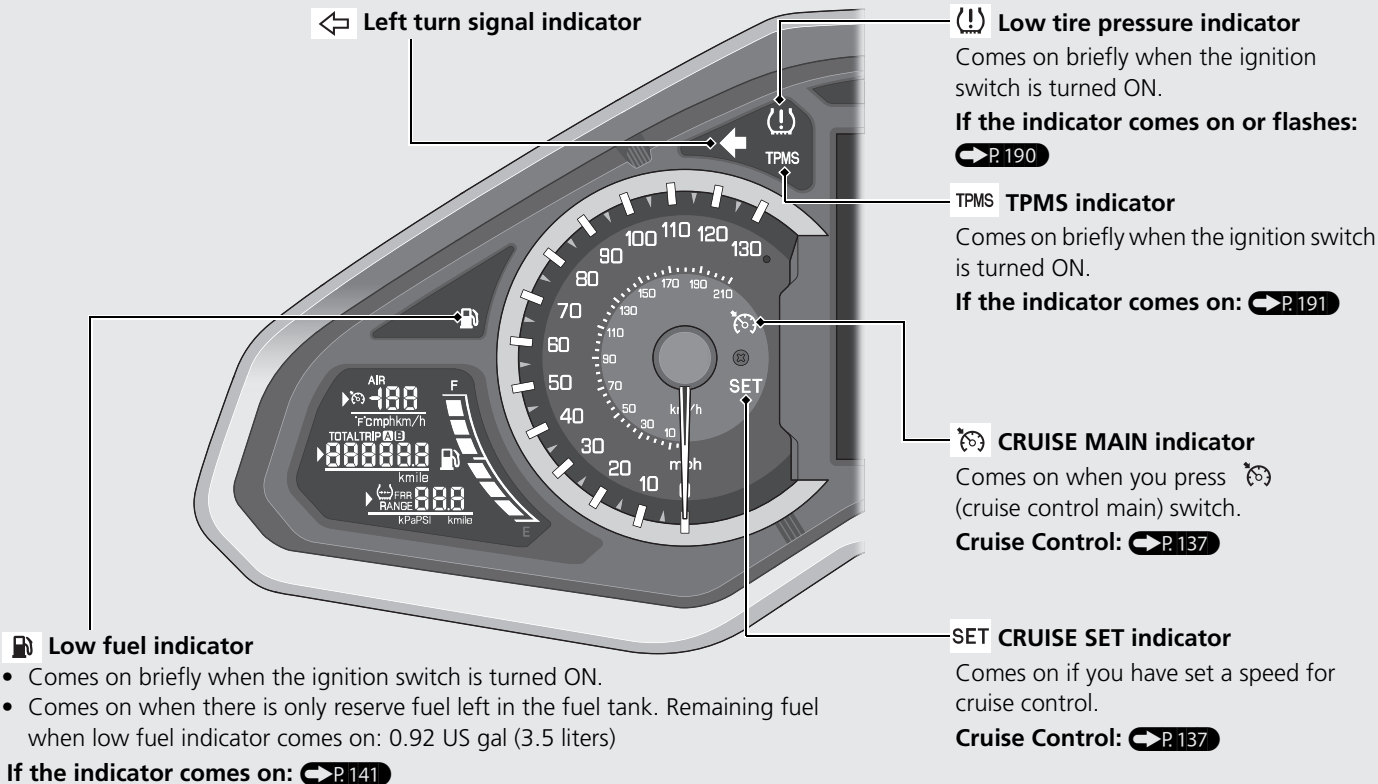

Steering lock indicator

Comes on briefly while the steering lock is activating.

Steering lock:  P.55

Clutch temperature indicator

GL1800BD/D/DA

Comes on briefly when the ignition switch is turned ON.

If the indicator flashes on while riding:  P.190

Honda SMART Key indicator

Comes on briefly when the ignition switch is turned ON.

When the Honda SMART Key Indicator Flashes:  P.189

AIRBAG indicator GL1800DA

Comes on briefly when the ignition switch is turned ON.

If the indicator comes on while riding:  P.191

Low oil pressure indicator

Comes on when the ignition switch is turned ON. Goes off when the engine starts.

If the indicator comes on while engine is running:  P.188

PGM-FI (Programmed Fuel Injection) malfunction indicator lamp (MIL)

Comes on briefly when the ignition switch is turned ON.

If the indicator comes on while engine is running:  P.188

High beam indicator

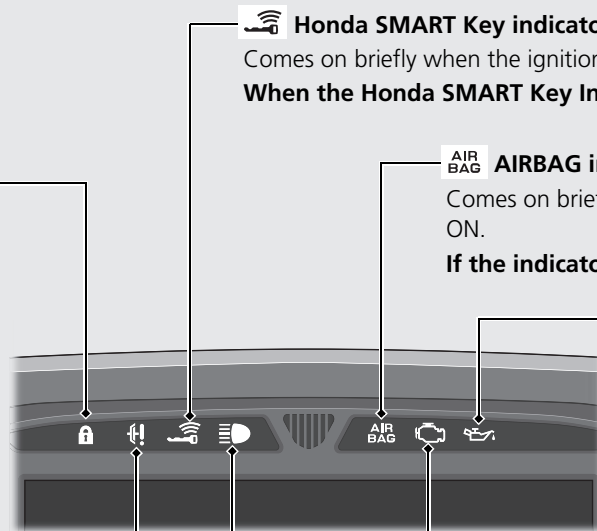

Indicators *(Continued)*

Torque Control indicator

GL1800/D/DA

- Comes on when the ignition switch is turned ON. Goes off when your speed reaches approximately 3 mph (5 km/h) to indicate Torque Control is ready to work.
- Blinks when Torque Control is operating.

If the indicator comes on while riding:

 P.189

Torque Control OFF indicator

GL1800/D/DA

Comes on when Torque Control is turned off.

Neutral indicator

Comes on when the transmission is in Neutral.

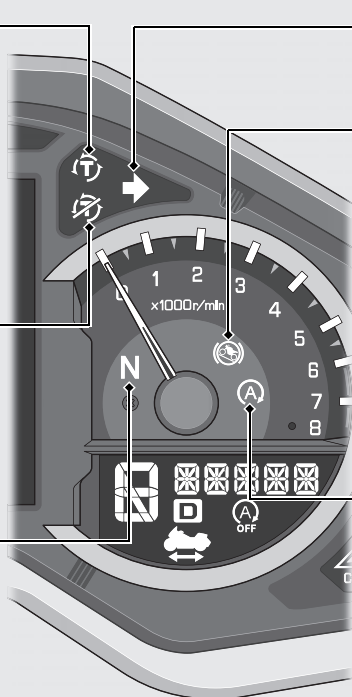

Right turn signal indicator

Hill start assist (HSA) indicator

Comes on in white to amber when the ignition switch is turned ON. Goes off when your speed reaches approximately 3 mph (5 km/h).

Hill start assist:  P.140

If the indicator comes on in amber while riding:  P.191

Idling Stop indicator

GL1800BD/D/DA Canada model only

Comes on briefly when the ignition switch is turned ON.

Idling Stop system:  P.61

(ABS) Combined ABS indicator

Comes on when the ignition switch is turned ON. Goes off when your speed reaches approximately 3 mph (5 km/h).

If the indicator comes on while riding:

➔ P.188

(P) Parking brake indicator

GL1800BD/D/DA

Comes on as a reminder that you have not released the parking brake lever. ➔ P.60

High coolant temperature indicator

Comes on briefly when the ignition switch is turned ON.

If the indicator comes on while riding:

➔ P.187

⊠ Fog light indicator GL1800/D/DA

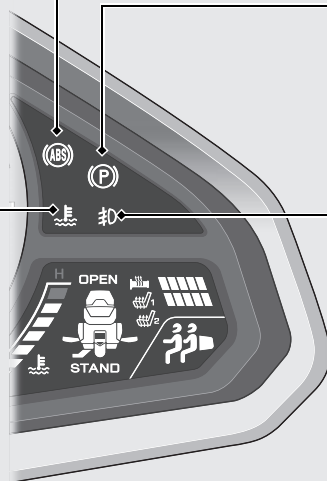

Comes on when the fog lights are on.



Switches

Center Panel

Interface dial (ENTER)

- Rotate  (Interface dial) or move  in the eight possible directions to select the available choices.
- Press  (Enter) to set your selection.

Basic Operations: P.24

(Home) button

Press to return to the Home screen.  P.24

SEL button

Press to move the cursor on the INFO 1 display.  P.34

(Handle grip heater) button

Press to adjust the handle grip heater level.  P.147

Fog light button

Press to turn the fog lights on or off.

AUDIO button

Press to switch the audio output source.  P.71



INFO button

Press to display the information bar on the multi-information display.  P.25



(Back) button

Press to return the previous screen.  P.24

SET button

Press to select the desired display  P.34 or to reset the tripmeter.  P.36

(Rider seat heater) button

 Press to adjust the rider seat heater level.  P.148

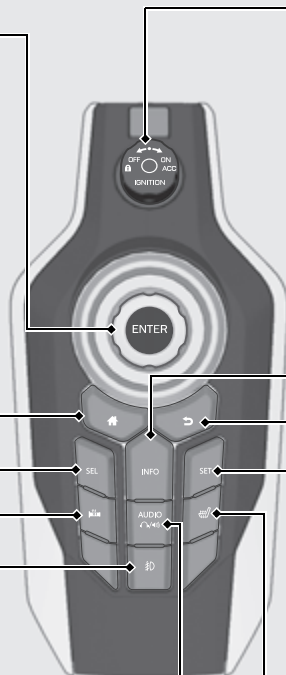

Ignition switch

Switches the electrical system on/off, locks the steering.

Make sure that the Honda SMART Key is activated  P.56

and enter the operating range.  P.57

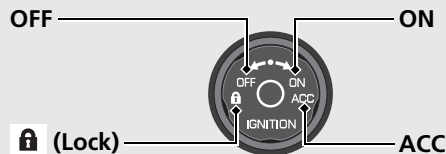

(Lock)

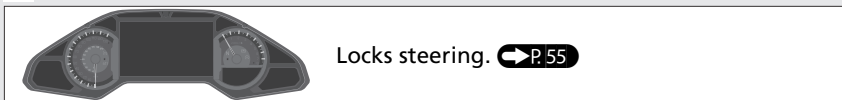

OFF

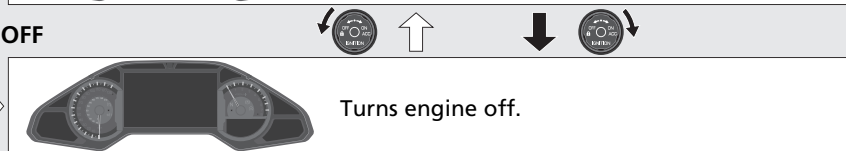



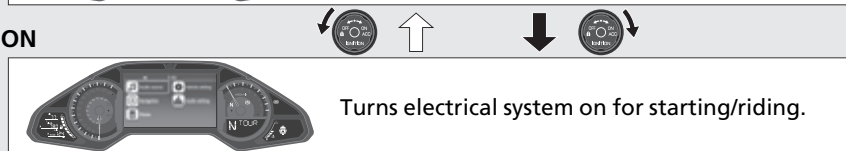

ON

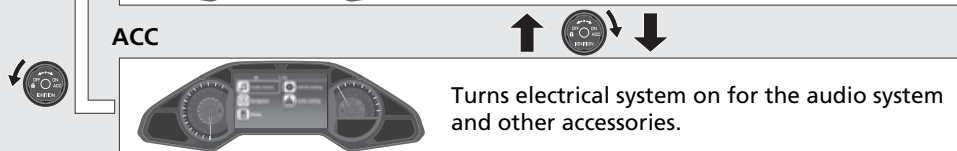

ACC



  : Turning the ignition switch clockwise.

  : Turning the ignition switch counterclockwise.

Switches (Continued)

Left handlebar

GL1800BD/D/DA

Headlight dimmer switch

- ▲☉ : High beam
- ▼☉ : Low beam
- ☉PASS : Flashes the high beam headlight.

VOL lever

Push up or down to adjust the audio system volume. ➡ P.71

(Voice control) switch

- Press to receive, reject or end a call. ➡ P.118
- Starts Siri® or voice search if Apple CarPlay or Android Auto is available. ➡ P.113

Horn button

Turn signal switch

- The turn signal will automatically stop when you complete the turn.
- When used for a lane change, the turn signal automatically stops after 7.5 seconds or after riding 153 yards (140 m).
- ▶ You can manually cancel the turn signal by pressing the switch in.
- ▶ In some cases, the timing at which the turn signal stops is changed.
- ▶ Always use the recommended tires to ensure correct automatic cancellation operation.

To enable or disable the turn signal automatic cancellation: ➡ P.28

4-way key/ENT switch

- Press the 4-way key switch in the ▲ / ▼ / ◀ / ▶ directions to select the available choices.
- Press ENT switch to set your selection. ➡ P.24

Windscreen adjusting lever

Push up or down to adjust the windscreen height. ➡ P.150

(Home) switch

Press to return to the Home screen. ➡ P.24

(Back) switch

Press to return to the previous screen. ➡ P.24

(Source/Private Mode) switch

- Press to change the audio mode. ➡ P.71
- Press and hold to enable/disable the private mode. ➡ P.92

Walking Speed mode switch

Press to enter the Walking Speed mode. ➡ P.131

Shift up switch (+)

- Pull to shift up a gear. ➡ P.130
- Pull to move the vehicle forward during the Walking Speed mode. ➡ P.131

➡ P.131

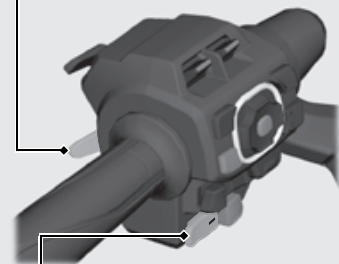

Shift down switch (-)

- Press to shift down a gear. ➡ P.130
- Press to move the vehicle backward during the Walking Speed mode. ➡ P.131

➡ P.131

GL1800/B

Headlight dimmer switch

- ▲☰☽ : High beam
- ▼☰☽ : Low beam
- ☰PASS : Flashes the high beam headlight.

VOL lever

Push up or down to adjust the audio system volume. ➡ P.71

(Voice control) switch

- Press to receive, reject or end a call. ➡ P.118
- Starts Siri or voice search if Apple CarPlay or Android Auto is available. ➡ P.113

Horn button

4-way key/ENT switch

- Press the 4-way key switch in the ▲ / ▼ / ◀◀ / ▶▶ directions to select the available choices.
- Press ENT switch to set your selection. ➡ P.24

Windscreen adjusting lever

Push up or down to adjust the windscreen height. ➡ P.150

(Home) switch

Press to return to the Home screen. ➡ P.24

(Back) switch

Press to return to the previous screen. ➡ P.24

(Source/Private Mode) switch

- Press to change the audio mode. ➡ P.71
- Press and hold to enable/disable the private mode. ➡ P.92

R Reverse mode switch GL1800 and GL1800B Canada model

Press to enter the reverse mode. ➡ P.133

Reverse button GL1800 and GL1800B Canada model

Turn signal switch

While pressing the switch, your vehicle will back up in the reverse mode. ➡ P.133

- The turn signal will automatically stop when you complete the turn.
- When used for a lane change, the turn signal automatically stops after 7.5 seconds or after riding 153 yards (140 m).
- ▶ You can manually cancel the turn signal by pressing the switch in.
- ▶ In some cases, the timing at which the turn signal stops is changed.
- ▶ Always use the recommended tires to ensure correct automatic cancellation operation.

To enable or disable the turn signal automatic cancellation: ➡ P.28

Switches (Continued)

Right handlebar

GL1800BD/D/DA

A/M switch

Shifts between AT MODE and MT MODE. ➔ P.130

Hazard switch

Switchable when the ignition switch is ON. Can be turned off regardless of the ignition switch position.

- ▶ The signals continue flashing with the ignition switch in OFF or  (Lock) after the hazard switch is on.

MODE button

Changes the riding mode. ➔ P.134

Engine stop switch/ Start button

Should normally remain in the  (Run) position.

- ▶ In an emergency, switch to the  (Stop) position to stop the engine.
- ▶ Press the start button to start the engine. ➔ P.126

N-D switch

To shift between Neutral and AT MODE. ➔ P.130

Idling stop button

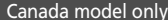
 Canada model only

- ▶ Press to switch the Idling Stop system on or off while engine is running. ➔ P.61

Cruise control lever

Push up or down to set the speed or adjust the set speed. ➔ P.137

Cruise control main switch

Press to activate the cruise control system.

➔ P.137

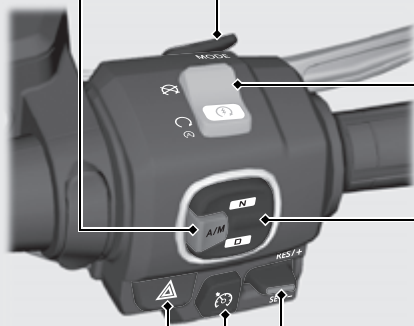

MODE button

Changes the riding mode. ➔ P.134

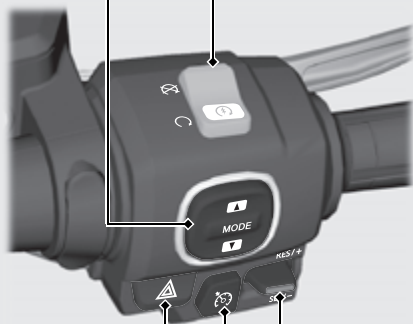
**Engine stop switch/ Start button**

Should normally remain in the  (Run) position.

- ▶ In an emergency, switch to the  (Stop) position to stop the engine.
- ▶ Press the start button to start the engine. ➔ P.126

 **Hazard switch**

Switchable when the ignition switch is ON. Can be turned off regardless of the ignition switch position.

- ▶ The signals continue flashing with the ignition switch in OFF or  (Lock) after the hazard switch is on.

Cruise control lever

Push up or down to set the speed or adjust the set speed.

➔ P.137

 **Cruise control main switch**

Press to activate the cruise control system. ➔ P.137

Switches (Continued)

Passenger seat



(Passenger seat heater) switch

GL1800/D/DA

Turn to adjust the passenger seat heater level.

 P.149

Honda SMART Key

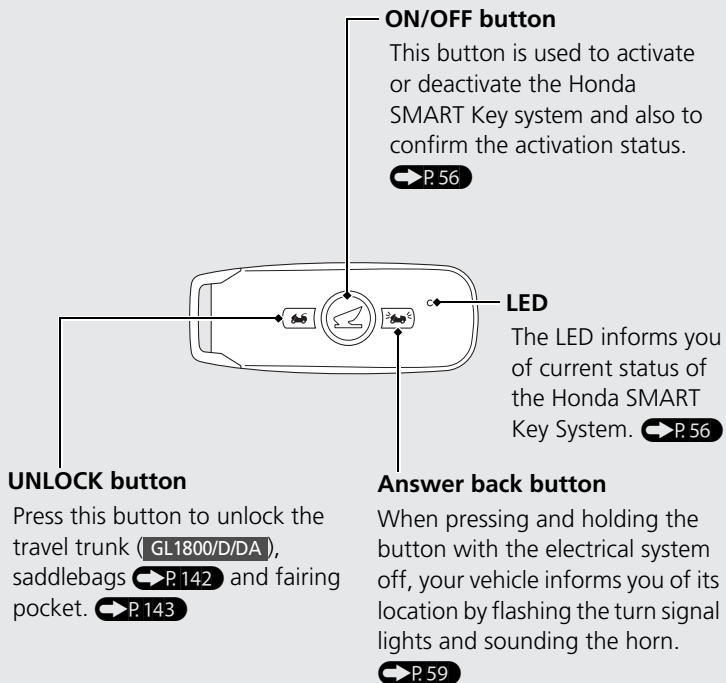

Steering Lock

Lock the steering when parked to help prevent theft.

A U-shaped wheel lock or similar device is also recommended.

- ▶ When using a U-shaped wheel lock or similar device, be careful not to damage the wheels.

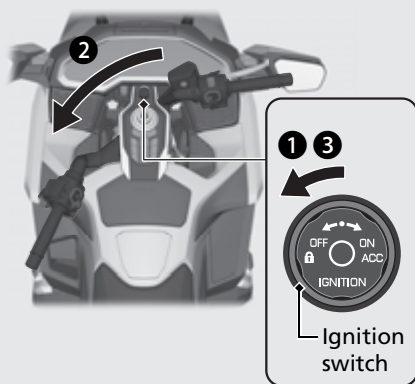

Locking

- 1 Turn the ignition switch to OFF. [➔ P. 49](#)
- 2 Turn the handlebars all the way to the left or right.
- 3 Turn the ignition switch counterclockwise.
 - ▶ The steering lock indicator comes on briefly and the steering is automatically locked.
 - ▶ If the steering lock indicator blinks and the alarm sounds, the steering has not been locked completely because the steering was not positioned all the way to the left or right. If this occurs, reposition the handlebars all the way to the left or right, then turn the ignition switch counterclockwise (The steering can also be locked by positioning it all the way to the left or right while the alarm is sounding).

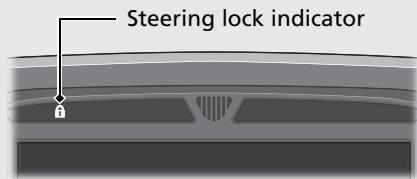

Unlocking

- 1 Make sure that the Honda SMART Key is activated [➔ P. 56](#) and enter the operating range. [➔ P. 57](#)
- 2 Turn the ignition switch clockwise.
 - ▶ The steering is unlocked automatically.

Honda SMART Key System

The Honda SMART Key system allows you to operate the vehicle.

The system runs a two-way authentication between the vehicle and the Honda SMART Key to verify it is the registered Honda SMART Key.

The Honda SMART Key system uses low-intensity radio waves. It may affect medical equipment such as a cardiac pacemaker.

Activate or Deactivate the Honda SMART Key System

To Switch the Honda SMART Key System to Activation or Deactivation

Press and hold the ON/OFF button for more than 1 second.

To Check the Honda SMART Key System Status

Press the ON/OFF button for less than 1 second. The Honda SMART Key LED will show the status.

When the Honda SMART Key LED:

- | | |
|-------------------------------|--|
| Blinks 3 times:
(active) | Honda SMART Key system authentication can be performed. |
| Lights briefly:
(inactive) | Honda SMART Key system authentication cannot be performed. |

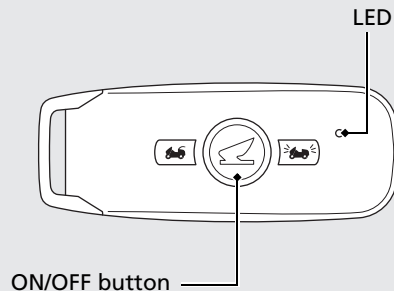

Operating Range

The Honda SMART Key system uses low-intensity radio waves. Therefore, the operating range may be wider or narrower, or the Honda SMART Key system may not work properly in the following situations:

- When the Honda SMART Key battery is low or depleted.
- When there are facilities nearby that generate strong radio waves or noise, such as TV towers, power stations, radio stations, or airports.
- When you carry the Honda SMART Key with a laptop or wireless communication device such as a radio or mobile phone.
- When the Honda SMART Key comes into contact with or is covered by metal objects.

The system can be operated when the Honda SMART Key is within the shaded area shown in the illustration.

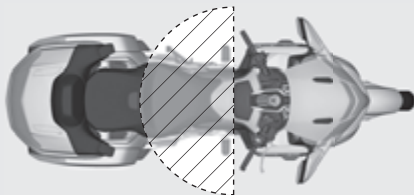
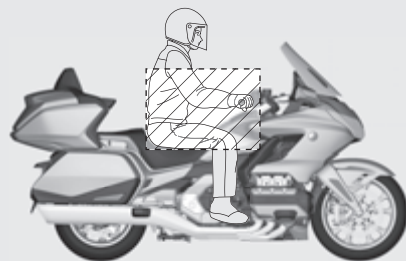

Anyone can operate the ignition switch and start the engine if your Honda SMART Key is within operating range of your vehicle, even if you are on the other side of a wall or window. If you will be away from your vehicle but your Honda SMART Key will still be within the system's operating range, deactivate the Honda SMART Key system.

Activate or Deactivate the Honda SMART Key System P.56

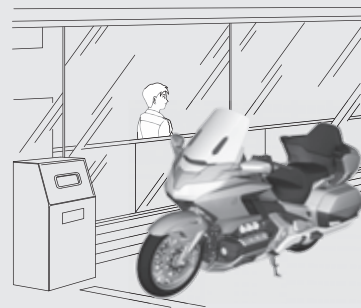

Honda SMART Key System *(Continued)*

Anyone in possession of the Honda SMART Key can perform the following operations if the Honda SMART Key is within the system's operating range:

- Unlocking the steering lock ➔P.55
- Activating the electrical system ➔P.58
- Starting the engine ➔P.126
- Operating the audio system ➔P.67 and other accessories.
- Opening the travel trunk, saddlebags and fairing pocket ➔P.142

You should always keep the Honda SMART Key on your person when you get on and off the vehicle or while riding.

Do not place the Honda SMART Key in the travel trunk (GL1800/D/DA), saddlebags, shelter case (Except GL1800DA) or fairing pocket.

If the ignition switch is ON, the vehicle can be operated even by a person who does not have a verified Honda SMART Key.

Whenever you leave your vehicle, turn the ignition switch to OFF and lock the steering. ➔P.58

Operating the Ignition Switch

I To Activate the Electrical System

- 1 Make sure that the Honda SMART Key is activated and enter the operating range for the vehicle. ➔P.57
- 2 Turn the ignition switch to ON. ➔P.49
 - ▶ The electrical system activates and the engine can be started.

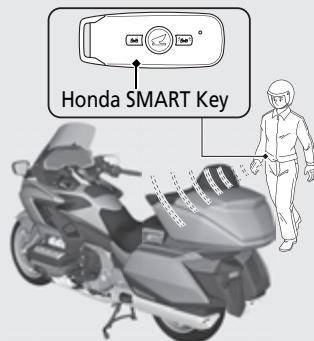

I To Turn Off the Electrical System

- 1 Turn the ignition switch to OFF or **i** (Lock). ➔P.49
 - ▶ The windscreen moves to the lowest position automatically.
- 2 Leave the operating range with the Honda SMART Key ➔P.57 or switch the Honda SMART Key system to inactive. ➔P.56

Always make sure the ignition switch is OFF.

If the Honda SMART Key System Does Not Work Properly ➔P.197

Answer Back System

The answer back system is a device to find the location of your vehicle. When the immobilizer is active and you press and hold the answer back button on the Honda SMART Key with the ignition switch OFF or  (Lock), the turn signals light and the horn sounds three times, informing you of your vehicle's location.

The answer back system uses low-intensity radio waves. It may affect medical equipment such as a cardiac pacemaker.

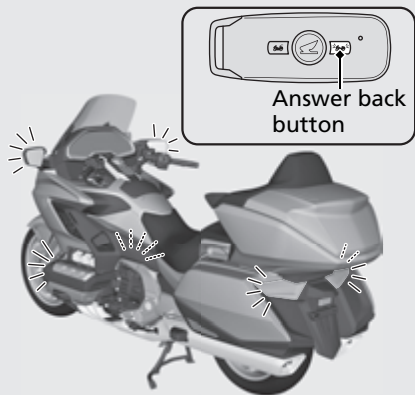

Operation

Press and hold the answer back button on the Honda SMART Key.

▶ The answer back system will not function when the ignition switch is ON.

If the ignition switch is left in OFF or  (Lock) for more than 30 days, the answer back system will no longer operate.

When the system is active and the vehicle receives a signal from pressing the answer back button, system activation will be extended for 30 days.

To reset the system, turn the ignition switch ON once and then OFF.

To turn the ignition switch ON  **P. 49**

When the battery in the vehicle is weak, the answer back system may not function.

Parking Brake

Parking Brake Lever

GL1800BD/D/DA

Be sure the parking brake is applied when parked and warming up the engine.

- ▶ Make sure the parking brake lever is released before riding.

To apply the parking brake:

Squeeze the front brake lever and pull the parking brake lever back to lock the rear wheel.

- ▶ The parking brake lock will not function if the parking brake is not adjusted properly. [➔ P. 176](#)

To release the parking brake:

Release the parking brake lever by lightly pulling in the lever.

- ▶ Before riding, check that the parking brake indicator is turned off and make sure that the parking brake is fully released so the rear wheel does not drag.

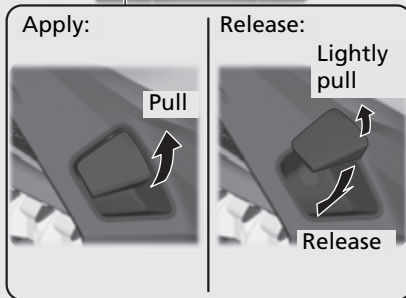
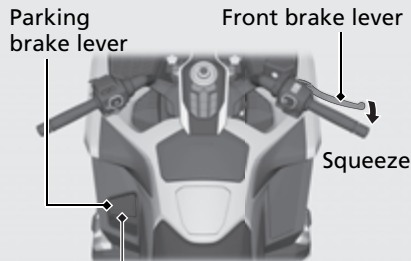

Idling Stop System

GL1800BD/D/DA Canada model only

The Idling Stop system is designed to help reduce fuel consumption and noise by stopping the engine from idling when stopped, such as when waiting at an intersection.

Switching the Idling Stop System On or Off

Switch the Idling Stop system on or off using the start/Idling Stop button or by the setting menu in the multi-information display. ➔ P.28

Each time the start/Idling Stop button is pressed, the Idling Stop system is switched on or off.

The status of the Idling Stop system (on or off) is maintained when the ignition switch is turned to OFF and then back to ON.

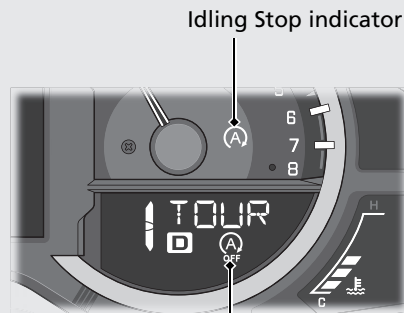
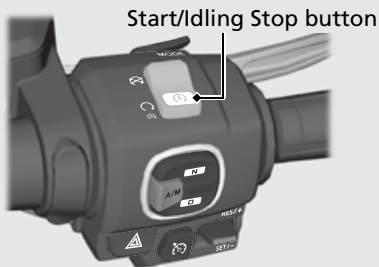

Idling Stop OFF indicator

- ON: Idling Stop OFF indicator does not come on.
 - ▶ Idling Stop indicator comes on when the Idling Stop system becomes ready to stop the engine while riding. Idling Stop indicator flashes when the engine is stopped by the Idling Stop system.
- OFF: Idling Stop OFF indicator comes on.
 - ▶ Idling Stop OFF indicator comes on when the Idling Stop system is off.

Idling Stop System *(Continued)*

Activating the Idling Stop System

The Idling Stop system becomes ready to stop the engine and the Idling Stop indicator comes on when the following conditions are satisfied with the Idling Stop system on.

- Engine is sufficiently warmed up
- Vehicle has been ridden at a speed of over 6 mph (10 km/h).

Idling Stop Indicator Does Not Come On: P.195

Stopping the engine by the Idling Stop System

The engine stops and the Idling Stop indicator flashes after you close the throttle completely and stop the vehicle while the Idling Stop system is on.

Idling Stop indicator

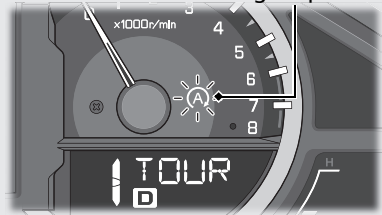

- ▶ While the engine is stopped by the Idling Stop system, if you press the start/Idling Stop button, the Idling Stop system is deactivated and the engine will restart.
- ▶ If the following conditions occur while the engine is stopped by the Idling Stop system, the engine will be restarted.
 - Hill Start Assist (HSA) is activated.
 - Transmission is shifted in Neutral (N side of the N-D switch is pressed).
 - Vehicle moves at about 3 mph (5 km/h) or more.
 - Battery is discharged more than specified.
- ▶ In the following conditions, the engine will not stop by the Idling Stop system.
 - Rider is not sitting astride the vehicle.
 - Transmission is in Neutral (N).
 - Battery is weak or temperature of battery is low.
 - Hill Start Assist (HSA) is operated.

Safety Precautions for the Idling Stop System

Do not go away from the vehicle while the Idling Stop indicator is flashing. When you go away from the vehicle, always turn the ignition switch to OFF.

- ▶ While the engine is stopped by the Idling Stop system, do not press against the seat with your hands or body, and do not put a load on the seat other than that of the rider sitting astride the vehicle. Even if the rider does not get on the vehicle, the engine will restart unexpectedly when the throttle is opened or when the battery becomes weak with a load on the seat.

Engine is Not Stopped by the Idling Stop System While the Idling Stop Indicator is On: P.195

NOTICE

Stopping by the Idling Stop system for a long time may cause battery discharge.

Restarting the Engine

Check that the Idling Stop indicator is flashing, and then open the throttle.

The engine will not restart if the rider is not sitting astride the vehicle.

When restarting on a slope, release the brakes after you feel the vehicle begin to move.

- ▶ If the indicator is not flashing, you cannot restart the engine with the Idling Stop system, even if you open the throttle.
- ▶ In the following conditions while the engine is stopped by the Idling Stop system, the Idling Stop indicator changes from flashing to off and you cannot restart the engine, even if you open the throttle.
 - When the side stand is lowered
 - When the vehicle has fallen over
 - When the rider has not been sitting astride the vehicle for approx. 3 minutes

To restart the engine when the Idling Stop indicator not flashing, shift the transmission into neutral and press the start/Idling Stop button. (To restart except in Neutral, apply the brake lever firmly, and then press the start/Idling Stop button.)

- ▶ The engine starts in the following conditions without opening the throttle grip.
 - When changing the Idling Stop system from on to off
 - When the gear position is changed to Neutral (N)
 - When the vehicle moves by releasing the brakes while stopped on a slope
 - When the battery is weak
 - A few seconds before restarting the engine, the Idling Stop indicator flashes quickly. After restarting, the Idling Stop indicator turns off and the system does not operate until the battery voltage has recovered.
 - See your dealer for checking the battery.
 - When the Hill Start Assist (HSA) system is activated with the brakes applied firmly

Engine Does Not Start Even If the Throttle is Opened: P.196

Airbag System

GL1800DA

The Airbag System can help cushion the impact force to the rider's head and upper body in certain severe frontal impacts. For safety precautions, see "Airbag system." 

How Rider Injuries Occur in a Frontal Crash

"SPEED KILLS," a saying goes. But not all vehicle injuries occur at high speeds, and speed alone does not cause injuries. In fact, the main cause of injuries in a collision is a rapid decrease in speed, caused by the rider impacting an object, such as another vehicle or the ground. As another saying goes, "It's not how fast you go, it's how hard you hit."

Consider, for example, what happens when a vehicle and rider crash into a parked car at 30 mph (50 km/h).

- In a 30 mph (50 km/h), head-on crash into the side of a stationary car, the vehicle will come to a stop in about 1/10th of a second—nearly as fast as the blink of an eye.
- A crash into a solid barrier at 30 mph (50 km/h) may not seem very serious, but for the rider it would be similar to falling from a third-story building directly onto pavement.

Without an airbag, the rider would continue forward at 30 mph (50 km/h) until he strikes the car or the ground with a force that could cause very serious or fatal injuries.

- In the same situation with an airbag-equipped vehicle, the bag would slow the rider's forward movement and absorb some of his kinetic energy.*

As a result, the rider would impact the car and/or the ground at a lower speed and with less force, and have a better chance of surviving the crash.

*Kinetic energy (KE) is the energy of motion. For a rider, it's a combination of the rider's mass (m) or weight, and his speed (v).

Mathematically, $KE = (m \times v^2)/2$. At 30 mph (50 km/h), a rider's kinetic energy is four times greater than at 15 mph (24 km/h). At 45 mph (72 km/h), it would be nine times greater.

At 60 mph (100 km/h), it would be sixteen times greater.

Airbag System Components

Your vehicle airbag system includes:
An airbag that is stored forward of the rider's seat, under a cover marked **AIRBAG**.

The impact sensors that measure the rate of deceleration during a frontal impact are located on the left and right of the main frame under the rider seat.

The control unit evaluates data from the impact sensors and determines whether or not the airbag should deploy.

The system continually monitors information about the sensors, the control unit, and the airbag inflator whenever the ignition is in the ON position.

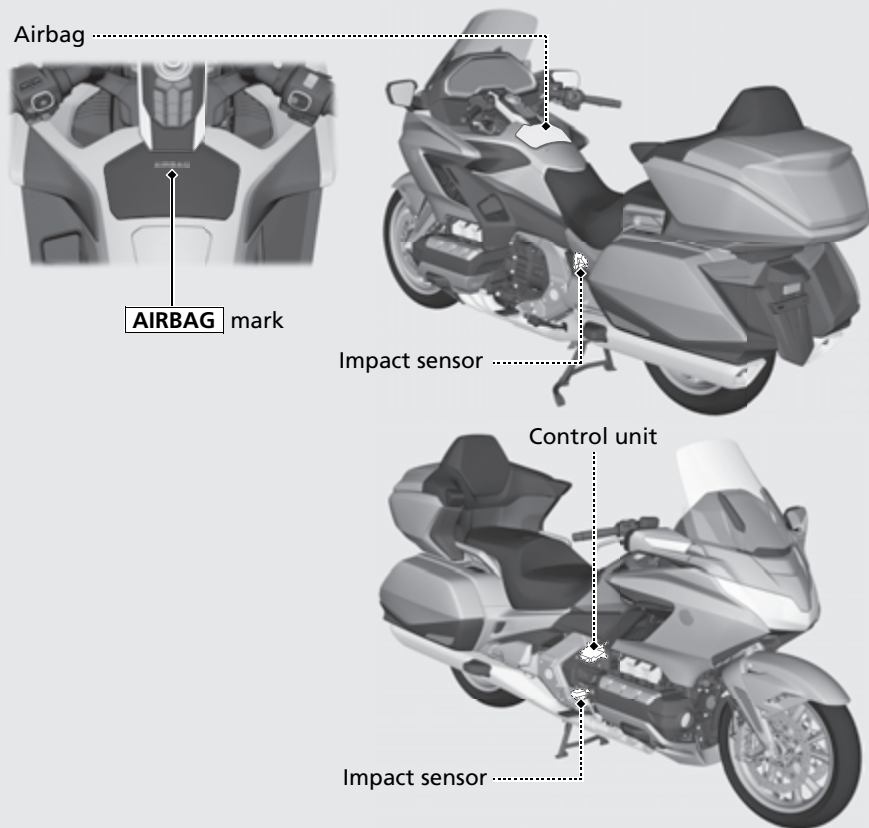

Airbag System *(Continued)*

How The Airbag System Works

If you ever have a frontal impact, the impact sensors will detect the vehicle's deceleration and send that information to the control unit.

If the rate of deceleration is high enough, the control unit will signal the airbag to instantly inflate.

As the rider's head and upper body press into the airbag, the bag immediately begins deflating, through vents located at the bottom of the bag.

The airbag slows down the rider's forward movement and absorbs some of the rider's kinetic energy.

When the rider eventually separates from the vehicle and contacts the opposing object or the ground, the forward speed of the rider and the resulting force of the impact will be much lower than they would be without the airbag.

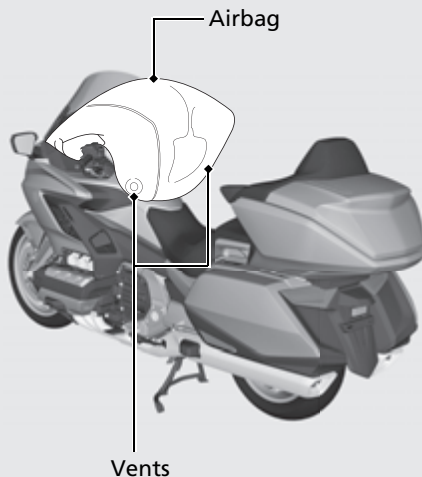

Airbag System Service

Your airbag system is well protected from the elements. There is no need to take any special precautions to protect it from rain, snow, or temperature extremes.

The airbag system is also virtually maintenance free, and there are no parts you can safely service. However, you must have your vehicle checked by a Honda dealer if:

- The AIRBAG indicator alerts you to a potential problem with the system. The indicator, located in the instrument panel, should come on briefly when you turn the ignition switch to ON. If it does not come on, or it comes on and stays on, or it comes on while you are riding, the airbag may not deploy when you need it.
- The airbag ever inflates. Any airbag that has deployed must be replaced along with the control unit and other related parts. Do not try to remove or replace the airbag by yourself. This must be done by a Honda dealer.

Audio System

About Your Audio System

The audio system features AM/FM/SiriusXM® radio.

It can also play USB flash drives and iPod®, iPhone®, Android™ phone and *Bluetooth*® devices.

You can operate the audio system from the switches on the left handlebar and buttons on the center panel. However, you cannot operate some functions by the center panel switches/Interface dial while the vehicle is in motion.

- State or local laws may prohibit the operation of handheld electronic devices while operating a vehicle.
 - Only operate audio buttons and switches when safe to do so.
 - Set the volume at a level that still allows horns and emergency vehicles to be heard.
 - Some audio devices, USB flash drives and *Bluetooth*® audio devices may not be compatible.
 - Use any audio devices, USB flash drives and *Bluetooth*® audio devices at your own risk.
- In no event shall Honda be liable for any damages or troubles that occur in the use of audio devices and USB flash drives.
 - iPhone, iPad, iPad Air, iPad Mini, iPod, iPod touch, iPod classic, iPod shuffle and iPod nano are trademarks of Apple Inc.
 - Google™, Android, Google Maps™, Google Play™, and Android Auto are trademarks of Google LLC.
 - The *Bluetooth*® word mark and logos are registered trademarks owned by Bluetooth SIG, Inc., and any use of such marks by Honda Motor Co., Ltd., is under license.
 - Other trademarks and trade names are those of their respective owners.
 - To prevent any potential issues, be sure to use an Apple MFi Certified Lightning Connector for Apple CarPlay, and for Android Auto, the USB cables should be certified by USB-IF to be compliant with USB 2.0 Standard.

Audio System (Continued)

Audio System Component Locations

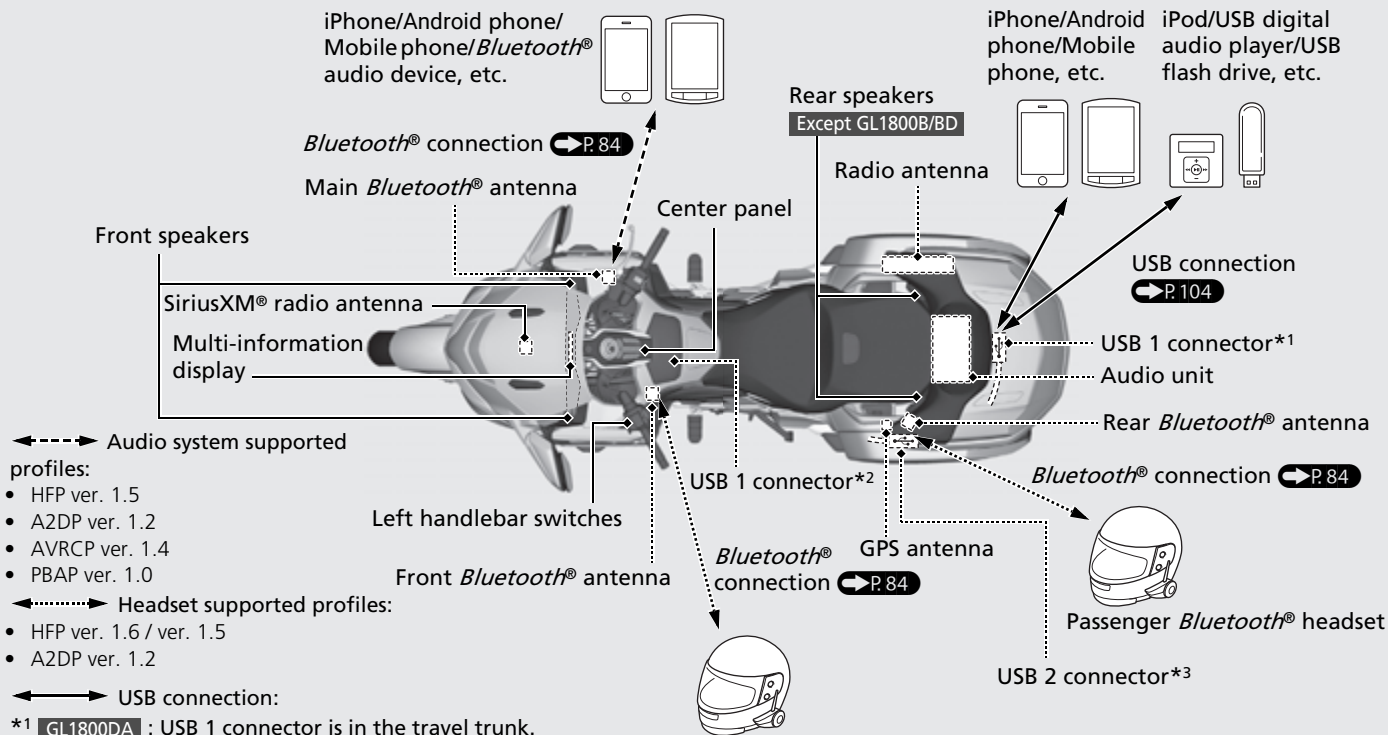

*1 **GL1800DA** : USB 1 connector is in the travel trunk.

*2 **Except GL1800DA** : USB 1 connector is in the shelter case.

*3 : Apple CarPlay and Android Auto cannot be used with USB connection via USB 2 connector.

Basic Operations

You can operate and set the various functions of the audio system using the interface dial and buttons on the center panel and/or switches on the left handlebar. However, you cannot operate some functions by the center panel switches/Interface dial while the vehicle is in motion.

Center Panel

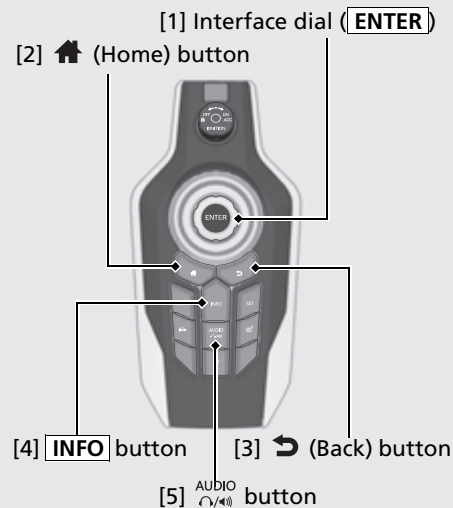

[1] (Interface dial): Rotate or move in the eight possible directions to select the available choices. Press to set your selection.

- When listening to the radio
 - Rotate or move : Switches to a higher frequency
 - Rotate or move : Switches to a lower frequency
 - Move and hold: Selects the next station with strong reception.
 - Move and hold: Selects the previous station with strong reception.
 - Move : Selects the next preset radio station.
 - Move : Selects the previous preset radio station.
- When listening to an iPod, USB flash drive or *Bluetooth*[®] audio
 - Move : Skips to the next song.
 - Move : Goes back to the beginning of the current or previous song.
- While the vehicle is in motion
 - Rotate : Adjusts a volume of the current audio mode and navigation mode.

- [2] (Home) button: Select to go to the home screen.
- [3] (Back) button: Press to go return the previous screen.
- [4] (INFO) button: Press to switch the information displayed on the information bar.
- [5] (AUDIO) button: Press to switch the audio output between the paired *Bluetooth*[®] headsets and the speakers.

Audio System (Continued)

Left Handlebar

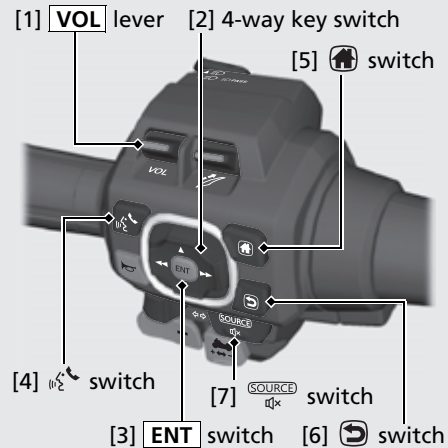

[1] **VOL** (volume control) lever: Push the lever up to increase the volume.

- To increase the volume: Push the lever up.
- To decrease the volume: Push the lever down.
- To increase the volume rapidly: Push up and hold the lever.
- To decrease the volume rapidly: Push down and hold the lever.

[2] 4-way key switch: Press right, left, up or down to select a menu item.

- When listening to the radio
 - Press **▲** : Switches to a higher frequency.
 - Press **▼** : Switches to a lower frequency.
 - Press and hold **▲** : Selects the next station with strong reception.
 - Press and hold **▼** : Selects the previous station with strong reception.
 - Press **▶▶** : Selects the next preset radio station.
 - Press **◀◀** : Selects the previous preset radio station.
- When listening to an iPod, USB flash drive or *Bluetooth*® audio
 - Press **▶▶** : Skips to the next song.
 - Press **◀◀** : Goes back to the beginning of the current or previous song.

[3] **ENT** switch: Press to set your selection.

[4] **voice control** switch: Press to receive, reject or end a call. Starts Siri or voice search if Apple CarPlay or Android Auto is available.

[5] **Home** switch: Select to go to the home screen.

[6] **Back** switch: Press to return to the previous screen.

[7] **SOURCE** (Source/Private Mode) switch: Press to change the audio mode. Cycles through the audio modes as follows:

[FM] → [AM] → [SXM] → [USB] → [iPod] → [Bluetooth] → [AUX] (option)



- When playing an audio
 - Press and hold **SOURCE** switch to mute the volume and to pause a track
- When receiving a call
 - Press and hold **SOURCE** switch to enable/disable the private mode.

To Change the Audio Mode

Press  switch to change the audio mode. Cycles through the audio modes on the information bar as follows:
 [FM] → [AM] → [SXM] → [USB] → [iPod] → [Bluetooth] → [AUX] (option)





Information bar

- [FM]  P. 94
- [AM]  P. 94
- [SXM]  P. 96

Subscription of SiriusXM® is required.

SiriusXM® is a registered trademark of SiriusXM Radio, Inc.

- [USB]  P. 108
- [iPod]  P. 108
- [Bluetooth]  P. 108
- [AUX]

This function is optional. Contact your dealer for details.

To Select the Audio Output Device

You can switch the audio output between the paired *Bluetooth*® headsets and the speakers by pressing  button on the center panel.

The selected device is displayed by the audio output status icon on the screen.

 : Audio output is from the *Bluetooth*® headsets.

 : Audio output is from the speakers.



Audio output status icon

To Adjust the Volume

You can adjust the volume settings for the speakers and headsets separately.

The system has following unique volume levels. Adjust the volume while in the individual modes.

[Audio vol.]/[Navi vol.]/[Ring tone vol.]/
 [Phone vol.]/[CB vol. (option)]/[Smartphone assistant]/[Smartphone navi]

Each volume can also be set from the menu.  P. 76

While the vehicle is in motion, you can adjust the volume of the current audio mode by rotating the interface dial.

 P. 69

Audio System *(Continued)*

When you push **VOL** lever up or down, the volume control level appears on the information bar.



Information bar

To increase the volume: push **VOL** lever up.

▶ To increase the volume rapidly, push up and hold **VOL** lever.

To decrease the volume: push **VOL** lever down.

▶ To decrease the volume rapidly, push down and hold **VOL** lever.

VOLUME level range: Level 0 to 30

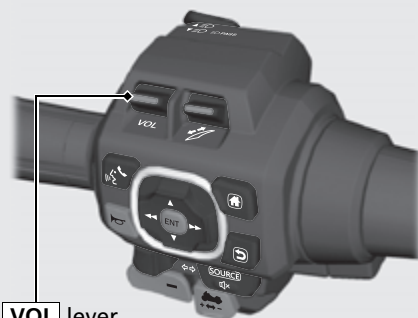

VOL lever

To mute the volume: Press and hold **SOURCE** switch.

▶ A diagonal line appears in the audio output status icon on the screen.



Audio output status icon

To resume the volume: Operate **VOL** lever while volume is muted.

Audio Setting

From this screen, you can go to various setup options for the audio system.



- [Sound setting] ➔ P.73
- [General setting] ➔ P.78
- [Bluetooth setting] ➔ P.84
- [Phone setting] ➔ P.92

Sound Setting

You can adjust the sound to fit your preferences. Rotate or press \blacktriangle / \blacktriangledown on the 4-way key switch to select a setting menu. Press or [ENT] switch to set your selection.



The sound settings contain the following:

- [Bass] ➔ P.73
- [Treble] ➔ P.74
- [Bass boost] ➔ P.74
- [Fader] ➔ P.74
- [Auto volume (Speaker)] ➔ P.75
- [Auto volume (Headset)] ➔ P.75
- [Navi auto volume (Speaker)] ➔ P.76
- [Navi auto volume (Headset)] ➔ P.76
- [Volume] ➔ P.76
- [CB roger beep] ➔ P.77

Bass

Adjusts lower-frequency sound level.

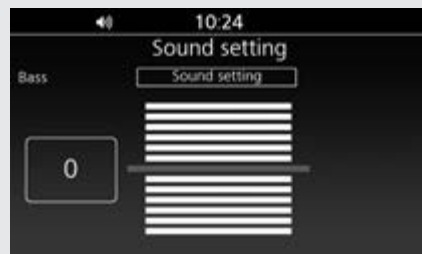

- 1 Select [Bass], and then press or [ENT] switch.
- 2 Rotate or press \blacktriangle / \blacktriangledown on the 4-way key switch to select your preferred level.
- 3 Return to the previous screen or the Home screen. ➔ P.24

Available setting range: Level -6 to +6

Default: Level 0



The Bass control is automatically adjusted in accordance with the vehicle speed.

Audio System *(Continued)*

Treble

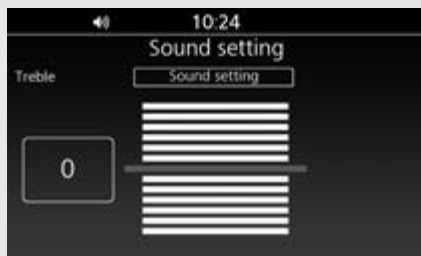
Adjusts higher-frequency sound level.



- 1 Select [Treble], and then press  or **ENT** switch.
- 2 Rotate  or press \blacktriangle / \blacktriangledown on the 4-way key switch to select your preferred level.
- 3 Return to the previous screen or the Home screen.  **P.24**

Available setting range: Level -6 to +6



Default: Level 0

The Treble control is automatically adjusted in accordance with the vehicle speed.

Bass Boost

Enables/disables bass boost.





- 1 Select [Bass boost], and then press  or **ENT** switch to select (enable) or deselect (disable) the function.
- 2 Return to the previous screen or the Home screen.  **P.24**

Default: Off (deselected)

Fader

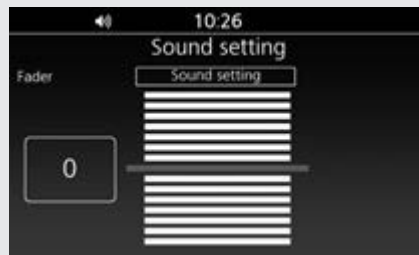
Adjusts the front and rear speaker output balance.



- 1 Select [Fader], and then press  or **ENT** switch.
- 2 Rotate  or press \blacktriangle / \blacktriangledown on the 4-way key switch to select your preferred level.
 - ▶ Positive levels increase front output level and decrease rear output level. If fader level is set to +7, the rear speakers are muted.
 - ▶ Negative levels decrease front output level and increase rear output level. If fader level is set to -7, the front speakers are muted.

▶ **GL1800B/BD** On models equipped with the front speakers only, setting the fader level to a negative level means the output sound gradually becomes smaller.

▶ The fader setting does not affect the headsets output.

- 3 Return to the previous screen or the Home screen.  P.24







Available setting range: Level -7 to +7

Default: Level 0

Auto Volume (Speaker)

Selects the volume setting to automatically increase volume from the speakers as the speed of the vehicle increases.



- 1 Select [Auto volume (Speaker)], and then press  or **[ENT]** switch.
- 2 Rotate  or press  /  on the 4-way key switch, and then press  or **[ENT]** switch to set your selection.
- 3 Return to the previous screen or the Home screen.  P.24







Available settings: [OFF]/[LOW]/[MID]/[HIGH]

Default: [OFF]

Auto Volume (Headset)

Selects the volume setting to automatically increase volume from the headsets as the speed of the vehicle increases.



- 1 Select [Auto volume (Headset)], and then press  or **[ENT]** switch.
- 2 Rotate  or press  /  on the 4-way key switch, and then press  or **[ENT]** switch to set your selection.
- 3 Return to the previous screen or the Home screen.  P.24

Available settings: [OFF]/[LOW]/[HIGH]

Default: [OFF]

Audio System (Continued)

Navi Auto Volume (Speaker)

Selects the volume setting to automatically increase volume of navigation from the speakers as the speed of the vehicle increases.



- 1 Select [Navi auto volume (Speaker)], and then press or **ENT** switch.
- 2 Rotate or press \blacktriangle / \blacktriangledown on the 4-way key switch, and then press or **ENT** switch to set your selection.
- 3 Return to the previous screen or the Home screen. P.24

Available settings: [OFF]/[LOW]/[MID]/[HIGH]

Default: [OFF]

Navi Auto Volume (Headset)

Selects the volume setting to automatically increase volume of navigation from the headsets as the speed of the vehicle increases.



- 1 Select [Navi auto volume (Headset)], and then press or **ENT** switch.
- 2 Rotate or press \blacktriangle / \blacktriangledown on the 4-way key switch, and then press or **ENT** switch to set your selection.
- 3 Return to the previous screen or the Home screen. P.24

Available settings: [OFF]/[LOW]/[HIGH]

Default: [OFF]

Volume

Adjusts the volumes in the following modes individually.

[Audio vol.]/[Navi vol.]/[Ring tone vol.]/
[Phone vol.]/[CB vol. (option)]/[Smartphone
assistant]/[Smartphone navi]

This setting is reflected as each volume of the audio output device (speakers and headsets) at that time. Select the audio output device before settings. P.71



- 1 Select [Volume], and then press or **ENT** switch.
- 2 Rotate or press \blacktriangle / \blacktriangledown on the 4-way key switch to select the mode that you want to adjust the volume, and then press or **ENT** switch to set your selection.



- 3 Rotate  or press ▲ / ▼ on the 4-way key switch to select your preferred level.



- 4 Return to the previous screen or the Home screen.  P.24

VOLUME level range: Level 0 to 30

Default: Level 7

Each volume can also be adjusted in individual modes.  P.71

CB Roger Beep

Roger Beep is a beep sound that is sent to notify you of the end of transmission.

This function is optional. Contact your dealer for details.

Audio System (Continued)

General Setting









Configures system settings.

Rotate , or press \blacktriangle / \blacktriangledown on the 4-way key switch to select a setting menu.

Press  or [ENT] switch to set your selection.





The general settings contain the following:

- [Beep]  P.78
- [Language]  P.78
- [TTS Language]  P.79
- [Clock]  P.79
- [System Information]  P.81
- [Apple CarPlay/iPod]  P.81
- [System Reset]  P.82
- [Restore Apple CarPlay Settings]  P.82
- [Restore Android Auto Settings]  P.83

Beep

Enables/disables the beep sound when operating keys.







- 1 Select [Beep], and then press  or [ENT] switch to select (enable) or deselect (disable) the function.
 \blacktriangleright You cannot deactivate the beep sound for error or caution messages.
- 2 Return to the previous screen or the Home screen.  P.24

Default: On (selected)

Language

Changes the system language.



- 1 Select [Language], and then press  or [ENT] switch.
- 2 Rotate  or press \blacktriangle / \blacktriangledown on the 4-way key switch to select the display language that you want to use on the screen, and then press  or [ENT] switch to set your selection.
- 3 Return to the previous screen or the Home screen.  P.24

Available languages: [US English]/
[CA Francois]/[NA Espanol]

Default: [US English]

TTS Language

Changes the TTS (text-to-speech) language.



- 1 Select [TTS language], and then press or [ENT] switch.
- 2 Rotate or press ▲ / ▼ on the 4-way key switch to select the TTS language to use the navigation, and then press or [ENT] switch to set your selection.
- 3 Return to the previous screen or the Home screen.

Available languages: [US English]/
[CA Francois]/[NA Espanol]

Default: [US English]

Clock

The audio system receives signals from GPS satellites, updating the clock automatically. You can also adjust the clock manually.



To enable/disable GPS adjustment function:

- 1 With [GPS adjustment] selected, press or [ENT] switch to select (enable) or deselect (disable) the function.
- 2 Return to the previous screen or the Home screen.





Default: On (selected)



To adjust the clock manually:



- 1 Select [Manual setting], and then press or [ENT] switch.
- 2 The month section is selected. Rotate or press ▲ / ▼ on the 4-way key switch until the desired month is displayed. Move or press ► on the 4-way key switch to set the month. The selector moves to the day section.
- 3 Rotate or press ▲ / ▼ on the 4-way key switch until the desired day is displayed. Move or press ► on the 4-way key switch to set the day. The selector moves to the year section.
- 4 Rotate or press ▲ / ▼ on the 4-way key switch until the desired year is displayed. Move or press ► on the 4-way key switch to set the year. The selector moves to the hour section.

Audio System (Continued)

- Rotate  or press $\blacktriangle / \blacktriangledown$ on the 4-way key switch until the desired hour is displayed. Move  or press \blacktriangleright on the 4-way key switch to set the hour. The selector moves to the minute section.
- Rotate  or press $\blacktriangle / \blacktriangledown$ on the 4-way key switch until the desired minute is displayed. Move  or press \blacktriangleright on the 4-way key switch to set the minute.
- Return to the previous screen or the Home screen.  P.24

Quick setting: Move  /  and hold, or press and hold $\blacktriangle / \blacktriangledown$ on the 4-way key switch until the desired number appears.



The clock setting is 24-hour indication, but the clock display is 12-hour indication. The call history is 24-hours indication.

The clock will be reset to 12:00 when the battery is reconnected.

Time Zone

Selects the offset of local time from UTC (Coordinated Universal Time). This function is disabled when [Manual setting] is selected. If you are in an area outside the range of the navigation map, or if there is no GPS signal, such as in a tunnel, [Auto] is disabled.



- Select [Time zone], and then press  or **ENT** switch.
- Rotate  or press $\blacktriangle / \blacktriangledown$ on the 4-way key switch to select the time zone, and then press  or **ENT** switch to set your selection.





Setting range: [Auto] or [UTC-12:00] to [UTC +13:00]

- Return to the previous screen or the Home screen.  P.24

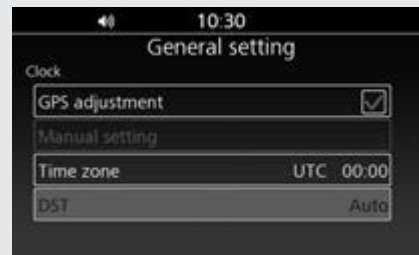
DST

Sets the DST (Daylight Saving Time). This function is disabled when [Manual setting] is selected. If you are in an area outside the range of the navigation map, or if there is no GPS signal, such as in a tunnel, [Auto] is disabled.





- Select [DST], and then press  or **ENT** switch.
- Rotate  or press $\blacktriangle / \blacktriangledown$ on the 4-way key switch to select [Auto], ON (enable) or OFF (disable), and then press  or **ENT** switch to set your selection.
- Return to the previous screen or the Home screen.  P.24

System Information

Shows various information of the audio system.



- 1 Select [System information], and then press  or **ENT** switch.
- 2 The following information is displayed.
 - Software version
 - Hardware version
 - GPS reception status
 - OSS Regulated Information
 - SiriusXM® Subscriptions: Displays information about SiriusXM® subscriptions.
- 3 Return to the previous screen or the Home screen.  P.24

Apple CarPlay/iPod

Selects whether Apple CarPlay connection or iPod (USB) connection is used when connecting your iPhone to the system with a USB cable.

To change the connection setting, disconnect the USB cable from your iPhone once, change the setting menu, and then connect the USB cable to your iPhone again.



- 1 Select [Apple CarPlay] or [iPod], and then press  or **ENT** switch to change the connection.

Default: [Apple CarPlay]

- 2 Return to the previous screen or the Home screen.  P.24

Apple CarPlay:  P.111

Playing audio:  P.108

Audio System *(Continued)*

System Reset

Resets the audio system to the factory defaults. All settings including preset data will be reset default values.





- 1 Select [System reset], and then press  or **ENT** switch.
 - ▶ A confirmation message appears on the screen.
- 2 Select [YES] to reset the settings.
 - ▶ After selecting [YES], the system will reboot.

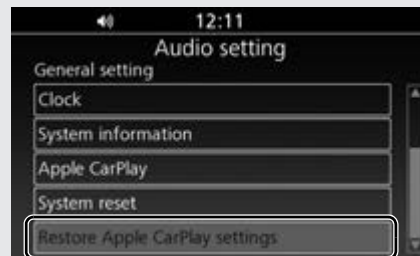

Restore Apple CarPlay Settings

Resets your selection on the Apple CarPlay disclaimer screen.



- 1 Select [Restore Apple CarPlay settings], and then press  or **ENT** switch.
 - ▶ A confirmation message appears on the screen.
- 2 Select [YES] to reset your Apple CarPlay setting.





- 3 Return to the previous screen or the Home screen. ➡ P.24

Apple CarPlay: ➡ P.111

Restore Android Auto Settings

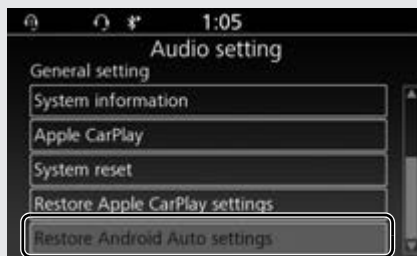
Resets your selection on the Android Auto disclaimer screen.



- 1 Select [Restore Android Auto settings], and then press  or **ENT** switch.
▶ A confirmation message appears on the screen.
- 2 Select [YES] to reset your Android Auto setting.

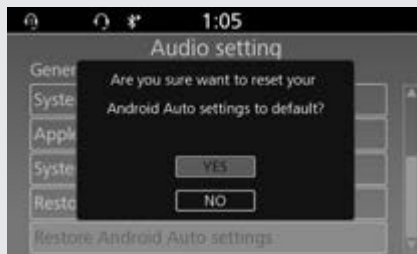

- 3 Return to the previous screen or the Home screen. ➡ P.24

Android Auto: ➡ P.114

Audio System *(Continued)*

Bluetooth Setting

You can connect with your iPhone, Android phone or other mobile phone and/or *Bluetooth*® headsets via *Bluetooth*®.

Your vehicle can establish up to 3

Bluetooth® connections at the same time.

Available devices are as follows:

- [Phone pairing] (For iPhone, Android phone or mobile phone) ➔ P.85
- [Rider HS pairing] (For rider headset) ➔ P.90
- [Passenger HS pairing] (For passenger headset) ➔ P.90



Supported *Bluetooth*® version/profiles

<i>Bluetooth</i> ® version	Bluetooth 2.1 + EDR
<i>Bluetooth</i> ® profiles (For iPhone, Android phone, mobile phone or <i>Bluetooth</i> ® device)	HFP (Hands Free Profile) ver. 1.5 A2DP (Advanced Audio Distribution Profile) ver. 1.2 AVRCP (Audio/Video Remote Control Profile) ver. 1.4 PBAP (Phone Book Access Profile) ver. 1.0
<i>Bluetooth</i> ® profiles (For rider and passenger headsets)	HFP (Hands Free Profile) ver. 1.6 (recommendation) / ver. 1.5 A2DP (Advanced Audio Distribution Profile) ver. 1.2

- You cannot pair an iPhone/Android phone/mobile phone/*Bluetooth*® device while the vehicle is moving. When pairing, park your vehicle in a safe place.
- *Bluetooth*® connection cannot be established while launching Apple CarPlay.
- Your vehicle is not equipped with intercom function. If you want to use intercom function, use the intercom function of your headset.
- Some local governments prohibit the use of a headset by the operator of a motor vehicle. Always obey applicable laws and regulations.

Phone Pairing

You can establish a *Bluetooth*® connection in two ways.

- [From phone]: Search from the device.
- [Inquiry]: Search from the system.

This function is disabled while the vehicle is in motion.

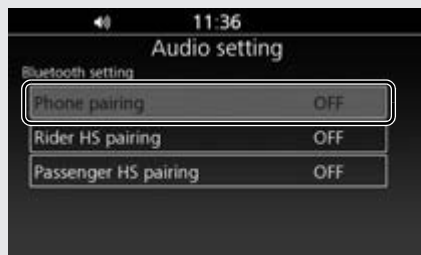

- 1 Enable the *Bluetooth*® function on your device.
 - ▶ For details, refer to the instruction manual of your device.
- 2 Select [Bluetooth setting], and then press or **ENT** switch.
- 3 Select [Phone pairing], and then press or **ENT** switch to enter the setting menu.

[From phone]



- 4 Select [From phone], and then press or **ENT** switch.
 - ▶ The system waits for a response from a target device for 2 minutes.



- 5 Tap "Honda Goldwing (default name)" on the *Bluetooth*® setting menu of the target device.

- 6 When a request message appears on the target device, tap "Pair."
- 7 The device name and PIN code appear on the screen. Select [Pair], and then press or **ENT** switch.



- 8 When the pairing is complete, a message to inform you that pairing was successful appears on the screen. Press or **ENT** switch.
- 9 (*Bluetooth*® icon) and (device icon) appear on the upper part of the screen, and icons of available functions appear next to the name of the device and turn on in light blue.
 - : Phone
 - : Music
- 10 Return to the previous screen or the Home screen. **P.24**



Audio System (Continued)

[Inquiry]







- 4 Select [Inquiry], and then press  or **ENT** switch.
▶The system waits for a response from a target device.



- 5 The names of the devices detected are displayed on the background screen. Press  or **ENT** switch to exit the search mode.
▶If many *Bluetooth*® devices are detected, the target device may be detected under the list, so exit the search screen and scroll down the list.
- 6 Select a target device name, and then press  or **ENT** switch.







- 7 When a request message appears on the target device, tap "Pair."
- 8 When the pairing is complete, a message to inform you that pairing was successful appears on the screen. Press  or **ENT** switch.





- 9  (*Bluetooth*® icon) and  (device icon) appear on the upper part of the screen, and icons of available functions appear next to the name of the device and turn on in light blue.
 : Phone
 : Music
- 10 Return to the previous screen or the Home screen. ➔P.24



To Connect the Paired Device Manually

Icon status:

-  (light blue) : phone function connected
-  : phone function disconnected
-  (light blue) : music function connected
-  : music function disconnected



- 1 Select [Bluetooth setting], and then press  or **ENT** switch.
- 2 Select [Phone pairing], [Rider HS pairing] or [Passenger HS pairing], and then press  or **ENT** switch to enter the setting menu.
- 3 Select the device you want to connect, and then press  or **ENT** switch.
- 4 When the connection is established, a message to inform you that pairing was successful appears on the screen. Press  or **ENT** switch.

- 5  (*Bluetooth*[®] icon) and  (device icon) appear on the upper part of the screen, and icons of available functions appear next to the name of the device and turn on in light blue.

▶ The battery status of the device icon is displayed only when Phone connection is established.





To Reconnect a Paired Device Automatically

When the ignition switch is turned ON or ACC, the system reconnects with registered device automatically.

- ▶ If the system finds multiple paired devices, the system will reconnect with the device that was connected last.
- ▶ After reconnecting, the song that was last played will be played automatically.

Audio System *(Continued)*

To Delete the Paired Device

- 1 Select [Bluetooth setting], and then press  or **ENT** switch.
- 2 Select [Phone pairing], [Rider HS pairing] or [Passenger HS pairing], and then press  or **ENT** switch to enter the setting menu.
- 3 Select the paired device, and then press  or **ENT** switch.
- 4 Select [Delete pairing], and then press  or **ENT** switch.

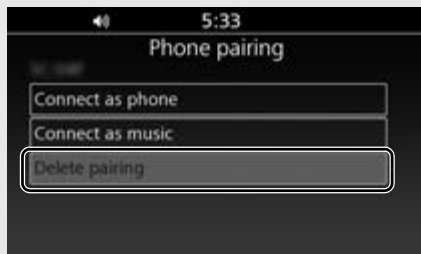

- 5 A confirmation message appears on the screen. Select [YES], and then press  or **ENT** switch.

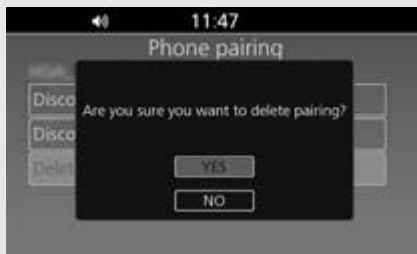



- 6  (Bluetooth® icon) disappears from the screen.

To Connect/Disconnect Available Functions Individually

Depending on the connected device, this function may not be able to establish a connection.



- 1 Select [Bluetooth setting], and then press  or **ENT** switch.
- 2 Select [Phone pairing], [Rider HS pairing] or [Passenger HS pairing], and then press  or **ENT** switch to enter the setting menu.
- 3 Select the paired device, and then press  or **ENT** switch.

To connect functions:

- 4 [Phone pairing]
 Select [Connect as phone] or [Connect as music], and then press  or [ENT] switch.

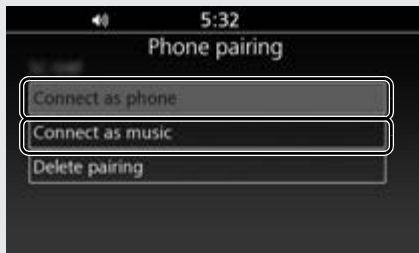

[Rider HS pairing] / [Passenger HS pairing]
 Select [Connect], and then press  or [ENT] switch.

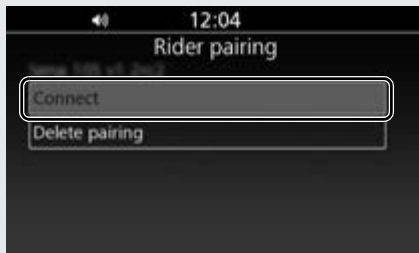

- 5 Icon of selected function next to the name of the device turns on.

To disconnect functions:

- 4 [Phone pairing]
 Select [Disconnect as phone] or [Disconnect as music], and then press  or [ENT] switch.

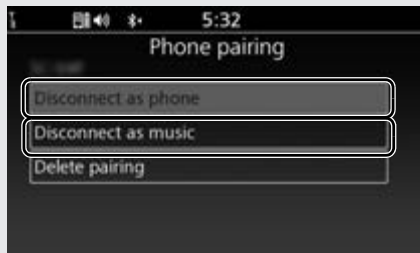

[Rider HS pairing] / [Passenger HS pairing]
 Select [Disconnect], and then press  or [ENT] switch.





- 5 Icon of selected function next to the name of the device turns off.

Audio System (Continued)

Rider HS Pairing/Passenger HS Pairing

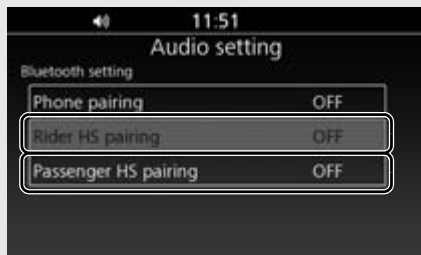
This function is disabled while the vehicle is in motion.



- 1 Enable the *Bluetooth*® function on your device.
▶ For details, refer to the instruction manual of your device.
- 2 Select [Bluetooth setting], and then press  or **ENT** switch.
- 3 Select [Rider HS pairing] or [Passenger HS pairing], and then press  or **ENT** switch to enter the setting menu.

- 4 Select [Inquiry], and then press  or **ENT** switch.







- ▶ The system searches for a target device.

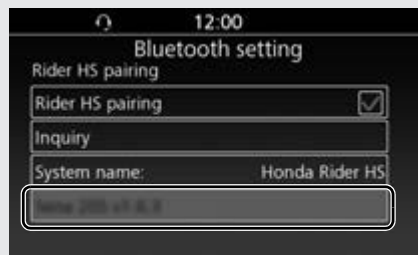

- 5 The names of the devices detected are displayed on the background screen. Press  or **ENT** switch to exit the search mode.

- 6 Select a target device name, and then press  or **ENT** switch.



- 7 When the pairing is complete, a message to inform you that pairing was successful appears on the screen. Depending on the connection, the following icon appears on the upper part of the screen, and icons of available functions appear next to the name of the device and turn on in light blue.
 /  : when pairing rider headset
 /  : when pairing passenger headset
- 8 Return to the previous screen or the Home screen. **➡ P.24**

To connect/disconnect the headset:

➡ P.87

To Edit the System Name

You can edit the system name to be displayed on a target device.



- 1 Select [System name:], and then press  or **ENT** switch.
- 2 The edit screen appears. Delete the current name, and then enter the new name.







System default name: Honda Goldwing
Headset default name: Honda Rider HS /
Honda Passenger HS

- 3 Select [OK], and then press  or **ENT** switch.



Audio System (Continued)

Phone Setting

You can configure the phone settings. Rotate  or press  /  on the 4-way key switch to select a setting menu item. Press  or [ENT] switch to set your selection.





The phone settings contain the following:

- [Private mode]  P.92
- [Phonebook download]  P.92
- [Mic. level]  P.93

Private Mode

Enables/disables a call with the passenger's headset.

- 1 Select [Private mode], and then press  or [ENT] switch to select (enable) or deselect (disable) the function.
- 2 Return to the previous screen or the Home screen.  P.24

Default: On (selected)

This setting can also be configured by pressing and holding  switch on the left handlebar during a call.

Phonebook Download





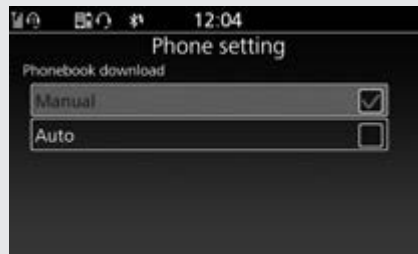

Enables/disables automatic import of your phonebook and call history when your phone is paired.

Up to 1,000 phonebook entries can be stored.

- For each person, you can store up to 4 numbers (home, office, cell phone and other) in the phonebook.

Phonebook is updated after every connection. Call history is updated after every connection or call.







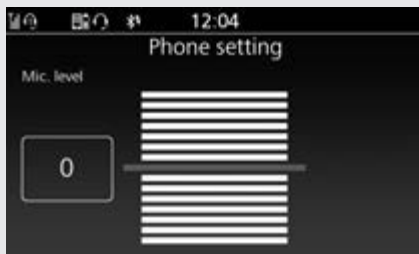

- 1 Select [Phonebook download], and then press  or [ENT] switch.
- 2 Rotate  or press  /  on the 4-way key switch to select [Auto] or [Manual], and then press  or [ENT] switch.
- 3 Return to the previous screen or the Home screen.  P.24

Default: Auto

Mic. Level

Adjusts the microphone volume.





- 1 Select [Mic. level], and then press  or **ENT** switch.
- 2 Rotate  or press  /  on the 4-way key switch to select your preferred level.
- 3 Return to the previous screen or the Home screen.  **P.24**

Available setting range: Level -7 to +7

Default: Level 0

Audio System (Continued)

Playing the FM/AM Radio

The audio system features FM/AM radio. Press  (Source/Private Mode) switch to select to FM/AM radio. 

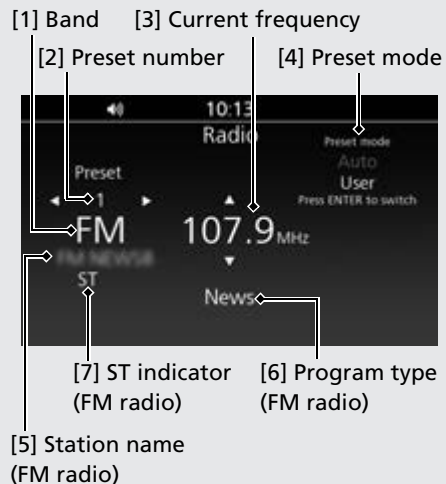







Screen Information









- [1] Band
- [2] Preset number
- [3] Current frequency
- [4] Preset mode ([Auto]/[User])
- [5] Station name **USA model only**
Displays that the station name of the current station when available (FM radio only).
- [6] Program type **USA model only**
Displays the program type of the current station when available (FM radio only).
- [7] ST (stereo) indicator
 - Reception of a stereo signal is indicated when the ST indicator appears in the display. (Stereo reception is available only for FM stereo broadcasts.)
As FM stereo reception becomes weaker, special circuits in the radio gradually blend the sound toward mono to maintain some sound quality, even though the ST indicator remains on.

Select Station

You can tune the radio frequency one step at a time.
The FM frequency moves in 200 kHz steps.
The AM frequency moves in 10 kHz steps.

To go up in frequency, rotate , move  or press  on the 4-way key switch.
To go down in frequency, rotate , move  or press  on the 4-way key switch.

Seek Mode:

Start the auto seek: when you move  /  and hold or press and hold  /  on the 4-way key switch for more than 1 second and less than 1.5 seconds, the auto seek starts. The audio system will seek until a broadcasting station with a strong signal is detected.
Stop the auto seek: when you move  /  and hold or press and hold  /  on the 4-way key switch for more than 1.5 seconds during the auto seeking, a beep sounds once and return to the manual tuning. The tuning stops at the frequency when the switch is released.

If the beep setting is disabled, no beep sounds.







To enable the beep sound: 

▮ Preset Stations

To Store a Station Manually:

You can store the frequencies of your favorite radio stations.



You can store 12 AM stations and 12 FM stations in user preset mode.

- 1 Press  or **ENT** switch to select [User] preset mode.
- 2 Tune in to a station you want to store.
- 3 Press and hold  or **ENT** switch.
- 4 Move  /  or press  /  on the 4-way key switch to select a preset number (1 to 12).
- 5 Press and hold  or **ENT** switch.





To Store a Station Automatically:

If you are traveling far from home and can no longer receive the stations you preset, you can use the auto select function to find stations in the local area.

You can store 12 AM stations and 12 FM stations in auto preset mode.

- 1 Press  or **ENT** switch to select [Auto] preset mode.
- 2 Press and hold  or **ENT** switch.
The audio system will seek and store stations with strong signal automatically.
 - ▶ To cancel the scan, select [Abort].
 - ▶ If you are in a remote area, the auto select function may not find 12 stations.
 - ▶ If no available station is detected at all, the stored preset stations are kept.
 - ▶ If even one station is detected, all the preset stations are overwritten.

To Select a Preset Station:

- 1 Move  /  or press  /  on the 4-way key switch to select a preset station.
- 2 Press and hold  or **ENT** switch.

Audio System (Continued)

SiriusXM® Radio

Your vehicle is capable of receiving SiriusXM® Radio anywhere in the United States, except Hawaii, Alaska and Puerto Rico. SiriusXM® is a registered trade mark of SiriusXM® Radio, Inc.

SiriusXM® Radio receives signals from two satellites to produce clear, high-quality digital reception. It offers many channels in several categories. Along with a large selection of different types of music, SiriusXM® Radio also allows you to view channel and category selections in the audio display.

Receiving SiriusXM® Radio Service

If your SiriusXM® Radio service has expired or you purchased your vehicle from a previous owner, you can listen to a sampling of the broadcasts available on SiriusXM® Radio. With the ignition switch in the ACC or the ON position, press the  switch to select to [SXM]. A variety of music types and styles will play.

If you decide to purchase SiriusXM® Radio service, contact SiriusXM® Radio at www.siriusxm.com, or telephone the number on the subscription display. You will need to give them your Radio ID number, which may be found on SiriusXM® Channel 0, and your credit card number.

To get your Radio ID number, select the General Setting/System information/SiriusXM Subscription or Navigation Menu/Information/SiriusXM® Subscriptions.



Radio ID number

Contact SiriusXM® Radio at www.siriusxm.com, or telephone the number on the subscription display.

After you've registered with SiriusXM® Radio, keep your audio system in the SiriusXM® Radio mode while you wait for activation. This should take about 30 minutes.

Traffic And Weather Information

- Add the Traffic and Weather information in the function of navigation system.
- Subscription is needed for adding Traffic and Weather functions.
- Contact SiriusXM® Radio for details.
- If SiriusXM® traffic and/or weather are unsubscribed, "unsubscribed" is displayed.

While waiting for activation, make sure your vehicle remains in an open area with good reception.

SiriusXM® Radio will continue to send an activation signal to your vehicle for at least 3 hours from the activation request. If you miss that window, simply log onto www.siriusxm.com refresh with your Radio ID and follow the steps to refresh the signal.



The SiriusXM® satellites are in orbit over the equator; therefore, objects south of the vehicle may cause satellite reception interruptions. To help compensate for this, ground-based repeaters are placed in major metropolitan areas.

Satellite signals are more likely to be blocked by tall buildings and mountains the farther north you travel from the equator.

Depending on where you ride, you may experience reception problems. Interference can be caused by any of these conditions:

- Riding on the north side of an east/west mountain road.
- Riding on the north side of a large commercial truck on an east/west road.
- Riding in tunnels.
- Riding on a road beside a vertical wall, steep cliff, or hill to the south of you.
- Riding on the lower level of a multi-tiered road.
- Riding on a single-lane road alongside dense trees taller than 50 ft. (15 m) to the south of you.

- There may be other geographic situations, parking conditions, and also installing metallic or metalized accessories near the windshield could affect SiriusXM® Radio reception.
- As required by the FCC: Changes or modifications not expressly approved by the party responsible for compliance could void the user's authority to operate the equipment.

Signal may be blocked by mountains or large obstacles to the south. Ground repeater

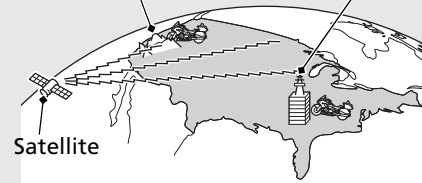

Signal is weaker in these areas.
SiriusXM® Radio Antenna

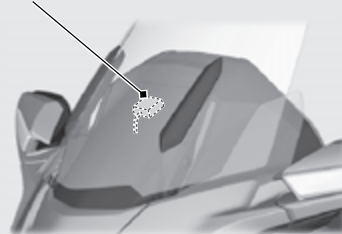

Display Message

Display Message	Status
Check Tuner	<ol style="list-style-type: none"> 1. In SXM main screen: Channel, Artist, Category and Song meta data shall be blank. Channel meta data shall be displayed as "Check Tuner". 2. In Travel Link screen: Popup shall be displayed. Popup screen remains on screen until tuner fixed. 3. If not in SXM main screen but SXM audio source: Channel meta data on the information bar shall be displayed as "Check Tuner".
Loading	<ol style="list-style-type: none"> 1. In SXM main screen: Channel, Artist, Category and Song meta data shall be blank. Channel meta data shall be displayed as "Loading". 2. In Travel Link screen: Popup shall be displayed. Popup screen remains on screen until loading finished. 3. If not in SXM main screen but SXM audio source: Channel meta data on the information bar shall be displayed as "Loading".
Check Antenna Antenna Disconnected or Antenna Shorted	<ol style="list-style-type: none"> 1. In SXM main screen: Channel, Artist, Category and Song meta data shall be displayed as blank. Channel meta data shall be displayed as "Check Antenna". Show Artist meta data as "Antenna Disconnected" or "Antenna Shorted". 2. In Travel Link screen: Popup shall be displayed. Popup screen remains on screen until error fixed. 3. If not in SXM main screen but SXM audio source: Channel meta data on the information bar shall be displayed as "Check Antenna".
No Signal	<ol style="list-style-type: none"> 1. In SXM main screen: Channel, Artist, Category and Song meta data shall be displayed as blank. Channel meta data shall be displayed as "No Signal". 2. In Travel Link screen: Popup shall be displayed. Popup screen remains on screen until error fixed. 3. If not in SXM main screen but SXM audio source: Channel meta data on the information bar shall be displayed as "No Signal".
Subscription Updated	<ol style="list-style-type: none"> 1. In SXM main screen: Popup shall be displayed. Popup screen remains on screen until user select [OK] button. 2. In Travel Link screen: Popup shall be displayed. Popup screen remains on screen until user select [OK] button. 3. If not in SXM main screen but SXM audio source: Popup shall be displayed. Popup screen remains on screen until user select [OK] button.
Replay Memory Almost Full	<ol style="list-style-type: none"> 1. In SXM main screen: Popup shall be displayed. Popup screen remains on screen until user select [OK] button. 2. If not in SXM main screen but SXM audio source: Popup shall be displayed. Popup screen remains on screen until user select [NO] or [YES] button.

Playing the SiriusXM® Radio

To listen to SiriusXM® Radio, press  switch to select to [SXM]. The last channel you listened to will show in the display.

SXM main screen



Channel art

Channel name

Select Channel

Operate with the interface dial ( / ) or 4-way key switch ( / ).

In the channel mode, you can select all of the available channels. In the category mode, such as Jazz, Rock, Classical, etc., you can select all of the channels within that category. You may experience periods when SiriusXM® Radio does not transmit the artist's name and song title information. If this happens, there is nothing wrong with your system.

Interface dial  4-way key switch 





Replay

The system can record the current broadcasting channel so you can rewind and replay the broadcast.

To replay:

- 1 Press and hold  or [ENT] switch.





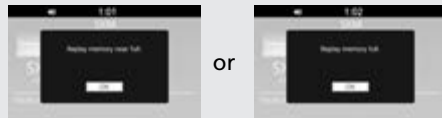



- 2 Rewind the buffered radio contents while pressing  on the 4-way key switch. When reaching the start of buffered contents, the rewind finishes, and the playback starts automatically. Fast-forward the buffered contents while pressing  on the 4-way key switch. Pop-up which is displayed if replay is paused and buffer nearest being filled.



- ▶ 'Forward' is not available as long as replay is on live position.
- ▶ Press  or [ENT] switch to return to the current broadcast program.

Selecting a channel from the list

- 1 Press  or [ENT] switch to display the list screen in the SiriusXM® mode.
- 2 Press and hold  or [ENT] switch to change the list menu. Each time you press and hold  or [ENT] switch, change the menu screen as follows:
[Preset list] → [Favorite song] → [Channel list] → [Game zone]
- 3 Select a desired channel, then press  or [ENT] switch.

To go back to the SXM main screen, press  (BACK) switch or  button.

Preset List



You can store 18 channels in the preset list.
To store a channel:

- 1 Tune to the selected channel.
- 2 Press and hold switch or button.
- 3 Press on the 4-way key switch to select [Preset], then press or **[ENT]** switch.



- 4 Select the preset number and press or **[ENT]** switch for the channel you want to store.



Favorite Artist or Songs

Favorite alert



Remove favorite

You can store 10 favorite artists and/or songs in the list.

To register your favorite:

- 1 When your favorite artist or song is broadcasting, press and hold switch or button.
- 2 Press on the 4-way key switch to select [Favorite artist] or [Favorite song], then press or **[ENT]** switch. A confirmation message appears on the screen.

▶When storing your favorite, the star icon appears beside the artist or song name.

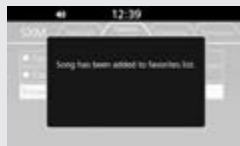

Remove favorite:

To remove the registered artist or song:

- 1 Select [Favorite songs] screen.
- 2 Press on the 4-way key switch to select [Remove favorites], then press or **[ENT]** switch.



- 3 Select the list you want to remove, then press or **[ENT]** switch.
- 4 A confirmation message appears on the screen. Select [Yes].



To enable/disable an alert message:
You can display an alert message when the registered artist or song is broadcasting.

- 1 Select [Favorite Songs] screen.
- 2 Press ◀/▶ on the 4-way key switch to select [Favorite alert], then press  or **ENT** switch to select add/remove [Favorite alert] check box.



An alert message will be displayed when the registered artist or song are broadcasting.
If you want to change to the broadcast channel, select [Yes] on the alert message.



Channel List

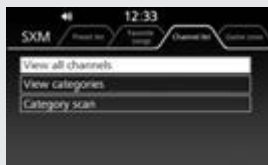

You can select a channel list.



View all channels:

You can show the all channels that are available now.

To select the favorite channel in the list:

- 1 Select [Channel list] screen.
- 2 Press ◀/▶ on the 4-way key switch to select [View all channels], then press  or **ENT** switch.
- 3 Press ◀/▶ on the 4-way key switch to select a favorite channel, then press  or **ENT** switch.



View categories:

You can select a channel within a category (Jazz, Rock, Classical, etc.).

To select the category:

- 1 Select [Channel list] screen.



- 2 Press ◀/▶ on the 4-way key switch to select [View categories], then press  or **ENT** switch.



- 3 Press ◀/▶ on the 4-way key switch to select a favorite category, then press  or **ENT** switch.



Category scan:

You can listen to each channel on the selected category list for 10 seconds.

- 1 Select [Channel list] screen.



- 2 Press **◀/▶** on the 4-way key switch to select [Category scan], then press **👉** or **ENT** switch.



- 3 Press **◀/▶** on the 4-way key switch to select the category you want to scan, then press **👉** or **ENT** switch. The system starts scanning.
 - ▶ To stop scanning, press **👉** or **ENT** switch.

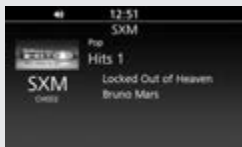

Game Zone

While listening to other channels, you can receive sports alerts such as scores from the games of your favorite teams.

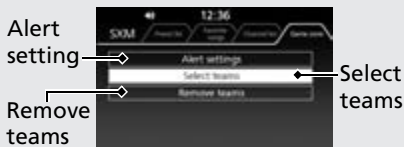

You can store 10 channels related to your favorite teams in the list.

To set up a favorite team:

- 1 Select [Game zone] screen.
- 2 Press **◀/▶** on the 4-way key switch to select [Select teams], then press **👉** or **ENT** switch.
- 3 Press **◀/▶** on the 4-way key switch to select the league, then press **👉** or **ENT** switch.



- 4 Press **◀/▶** on the 4-way key switch to select a favorite team then press **👉** or **ENT** switch.
 - ▶ When storing the team, the star icon appears beside the team name.

To remove the favorite team:

- 1 Press **◀/▶** on the 4-way key switch to select [Remove teams], then press **👉** or **ENT** switch.
- 2 Press **◀/▶** on the 4-way key switch to select the league, then press **👉** or **ENT** switch.
- 3 Press **◀/▶** on the 4-way key switch to select the team you want to remove, then press **👉** or **ENT** switch.
- 4 A confirmation message appears on the screen. Select [Yes].

To enable/disable an alert message:

- 1 Press ◀/▶ to select [Alert settings], then press 📶 or **ENT** switch.
- 2 Press 📶 or **ENT** switch to add/remove [Game starts] check box.



An alert message will be displayed when the registered team's game is broadcasting. You can check the game information or change to the broadcast channel. If you want to change to the broadcast channel, select [Yes] on the alert message.



Audio System *(Continued)*

Connecting your iPhone/iPod/Android Phone/USB device

You can connect your iPhone/iPod/Android phone/USB device using a certified cable to the USB connector or connect a USB flash drive, etc. to the USB connector directly. Make sure to use the factory USB cable that came with your device.

- Some USB flash drives maybe unsupported or incompatible and will cause abnormal audio function, such as skipping or playing delays.
- Do not use hard disks, card readers, and memory readers which may damage the device and data. If you accidentally connect the one of them, turn the ignition switch OFF and remove it.

Compatible Devices

iPhone, iPod, Android phone and other devices compatible with your audio system are:

USB flash drive	Standard File systems	USB 2.0/3.0 FAT32 (recommendation), FAT16, HFS+
	Storage capacities	From 256 MB to 64 GB
	Maximum hierarchies	8 hierarchies
	Maximum folders	512 folders
	Maximum files	65,524 files (same limitation in one folder)
	Maximum file/ folder name size	255 characters
	Maximum file size	2 GB (in single file)
	iPhone® 5 or later	iOS 10 or later
iPod touch® (5th generation or later)	iOS 9 or later	
iPod nano® (7th generation or later)		
iPad®/iPad Air®/iPad Mini® (all model)	Not supported	
iPod classic®/iPod shuffle® (all model)	Not supported	
Android phone	Android 5.0 or later	
Hard disk drive	Not supported	
Card reader/Memory reader	Not supported	
CD/DVD/FD drive	Not supported	
USB hub	Not supported	

The audio system may not be compatible with the latest model and the latest OS version.

Audio Files on Device

MP3/WMA/WAV files in your device can be played on the following specifications.

MP3	Standard	MPEG1 Audio Layer 3
	File extension	.mp3
	Sample rate (kHz)	32/44.1/48
	Bit rates (kbps)	32/40/48/56/64/80/96/112/128/160/192/224/256/320/VBR
	Available tags	ID3v2 (v2.2/v2.3/v2.4) ID3v1 (v1.0/v1.1)
WMA	Standard	Windows Media Audio Version 7/8/9
	File extension	.wma
	Digital rights management (DRM)	Not supported
	Sample rate (kHz)	16/22.05/32/44.1/48
	Bit rates (kbps)	5 to 320/VBR
	Available tags	ASF
WAV	Standard	WAVE
	File extension	.wav
	Sample rate (kHz)	16/22.05/32/44.1/48

- Do not edit other type of extension. Playing a device containing these kind of files can cause troubles such as the device or speakers failure.
- Depending on the type of the character code used for the music information of audio files, the music information may not be displayed correctly.

Windows Media is registered trademarks of Microsoft Corporation. in the U.S. and other countries.

Audio System *(Continued)*

■ To Connect Your iPhone/iPod/Android Phone/USB Device

USB 1 connector (1.5A)

- To prevent any potential issues, be sure to use an Apple MFi Certified Lightning Connector for Apple CarPlay, and for Android Auto, the USB cables should be certified by USB-IF to be compliant with USB 2.0 Standard.

1 **GL1800DA**

Open the travel trunk. ➔ P. 142

Except GL1800DA

Open the shelter case. ➔ P. 145

- #### 2
- Connect your iPhone/iPod/Android phone/USB device using a certified cable to the USB 1 connector or connect a USB flash drive, etc. to the USB 1 connector directly.

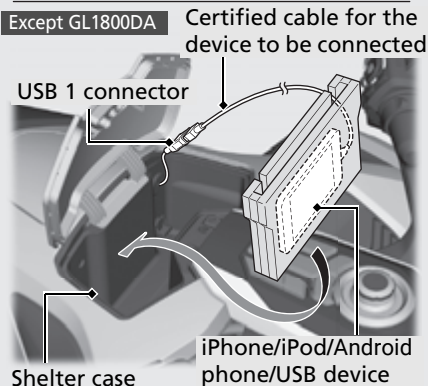
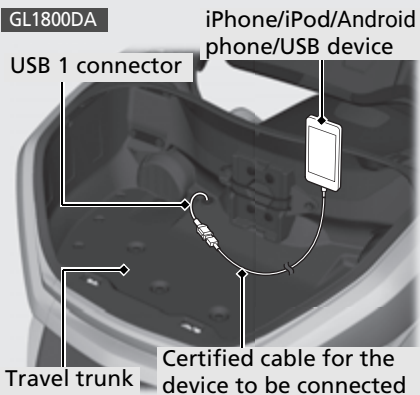

After connecting, the USB icon appears on the screen.

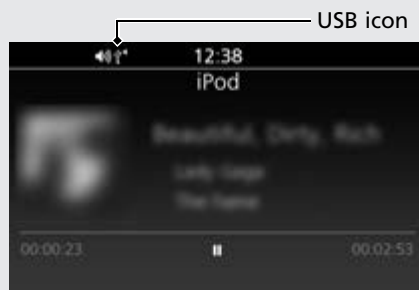

- #### 3
- Store your device in the travel trunk (**GL1800DA**) or shelter case (**Except GL1800DA**).
- #### 4
- Close the travel trunk or shelter case.

USB 2 connector (1.0A)

- Apple CarPlay/Android Auto cannot be used with USB connection via USB 2 connector.

- 1 Open the left saddlebag.  P.142
- 2 Release the USB 2 connector from the connector cap.
- 3 Connect your iPhone/iPod/Android phone/USB device using a certified cable to the USB 2 connector or connect a USB flash drive, etc. to the USB 2 connector directly.

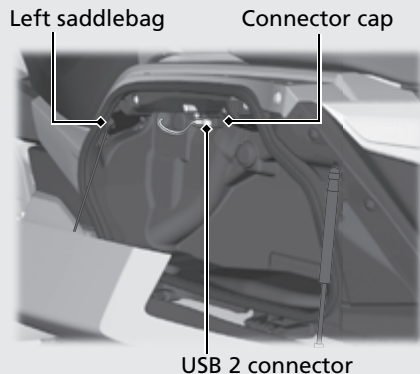

After connecting, the USB icon appears on the screen.

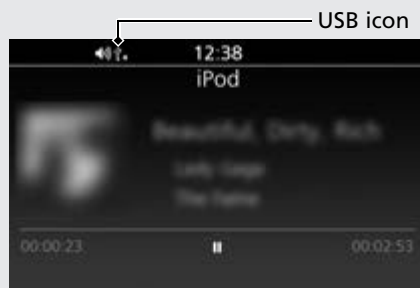

- 4 Store your device in the left saddlebag.
- 5 Close the left saddlebag.

After using the USB connector, return the USB connector to the connector cap.

▮ To Disconnect Your iPhone/iPod/Android Phone/USB Device

You can disconnect your iPhone/iPod/Android phone/USB device at any time. Make sure to follow the device's instructions on how to disconnect the device from the cable.

When you disconnect your device, the USB icon will disappear from the screen.

- Do not leave your device in the vehicle (travel trunk, shelter case or saddlebag etc.). High heat will damage it.
- Read precaution statements on the provided instructions of your device.
- Some USB flash drives (such as devices with security lockout features, etc.) may not be used or restricted to its function.
- We recommend backing up your data before playing it.
- iPhone, iPod, Android phone or some of USB devices can be charged with the USB cable when the ignition switch is in the ON or ACC position. The charging time may be longer than usual.
- We recommend covering your devices with an audio pouch, or soft fabric or cover to protect from damage.
- Be careful to not get the USB connector wet.
- Do not connect with a hub.
- Do not connect incompatible devices.
- If the audio system does not recognize the device, try reconnecting it a few times or reboot the device.

Audio System (Continued)

Playing Audio

The audio system can play music stored on a device connected via USB or *Bluetooth*®.

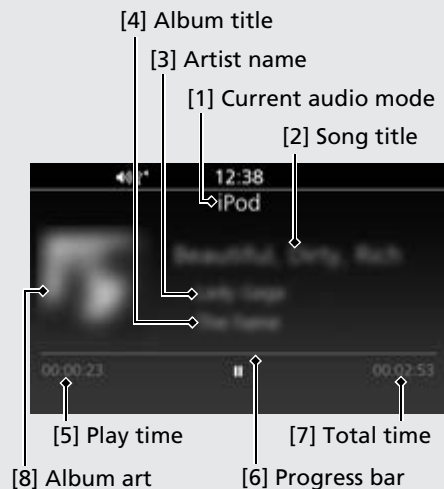

Screen Information

The information displayed on the screen differs depending on the connected device and the type of file being played back.

The system supports ID3 tag information. If a track does not have an ID3 tag, the song title or file name is displayed.

- [1] Current audio mode
- [2] Song title
- [3] Artist name
- [4] Album title (Folder name)
- [5] Play time
- [6] Progress bar
- [7] Total time
- [8] Album art (Displayed only when the device is connected via USB and the track contains artwork.)



To Play a Track

- 1 Connect the device you want to play from.

Bluetooth setting: ➔ P.84

Connecting your iPhone/iPod/

Android phone/USB device: ➔ P.106

- 2 Select the audio output device. ➔ P.71
- 3 Press  switch to select [USB], [iPod] or [Bluetooth].
- 4 Press  or **ENT** switch to display the playlist. ➔ P.110
- 5 Select the supported audio file you want to play. ➔ P.105
- 6 Press  or **ENT** switch to play a track.

■ To Pause a Track

Push and hold  switch to pause a track and mute the volume.

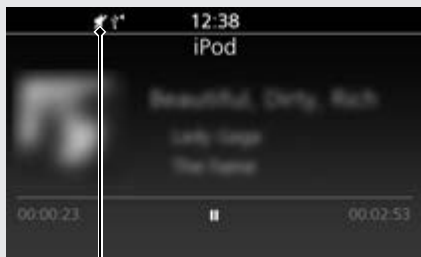

- ▶ A diagonal line appears in the audio output status icon on the screen.





Audio output status icon

To resume a track, operate **VOL** lever while volume is muted.

■ To Change a Track

To skip to the next track, move  or press  on the 4-way key switch.

To go back to the beginning of the current or previous track, move  or press  on the 4-way key switch.

■ To Select the Play Mode

You can select repeat and random modes. To switch the mode, press and hold  or **ENT** switch.



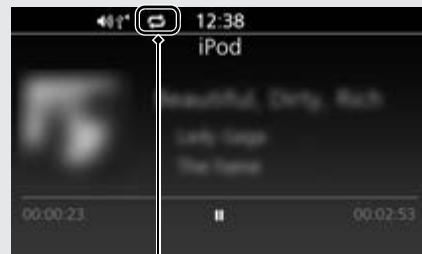

The audio play mode status icon appears on the upper part of the screen.

Cycles through the play modes as follows:
 Normal play mode (blank) → Repeat all play mode → Track repeat play mode →
 Random play mode → Random & Repeat all play mode → Random & track play mode



Audio play mode status icon



Audio System *(Continued)*

-  Repeat all play mode: Repeats all tracks in the current playlist ([Artists], [Albums] or [Folders], etc.).
-  Track repeat play mode: Repeats the current track.
-  Random play mode: Plays tracks randomly from the current playlist.
-  Random & Repeat all play mode: Plays tracks randomly and repeats all tracks in the current playlist.
-  Random & track play mode: Plays tracks randomly and repeats the current track.

To Select a Track from the Playlist

You can select a track from various playlists depending on the connected device.



- 1 Press  or **ENT** switch to display the playlist.
- 2 Press  on the 4-way key switch to change the playlist tab.

When iPod or *Bluetooth*® device is

connected: [Artists] → [Albums] → [Playlist] → [Songs] → [Genres]

When USB device is connected:

[Folders] → [Songs]

- 3 Select a desired item from the playlist, and then press  or **ENT** switch.

- Available operating functions may differ depending on the connected device and the type of file being played back.
- If an iPhone is connected via Apple CarPlay, the iPod/USB source is unavailable and audio files on the phone can only be played within Apple CarPlay.
- If an Android phone is connected via Android Auto, the USB source is unavailable and audio files on the phone can only be played within Android Auto.

Apple CarPlay™

If you connect an Apple CarPlay-compatible iPhone to the system via USB, you can use the multi-information display, instead of the iPhone display, to make a phone calls, listen to music, view maps (navigation), and access messages.

- Only iPhone 5 or newer versions with iOS 10 or later are compatible with Apple CarPlay.
- Park your vehicle in a safe place before connecting your iPhone to Apple CarPlay and when launching any compatible apps.
- In no event shall Honda be liable for any damages or troubles that occur in the use of iPhone.
- If a mobile network communication is unstable due to surrounding conditions or signal strength conditions, Apple CarPlay functions may not be available.
- To use Apple CarPlay, a headset connection is necessary. If headset connection is broken due to headset battery depletion or communication failure, Apple CarPlay cannot be used until the connection is restored.
- You cannot operate Apple CarPlay by

the center panel switches/Interface dial while the vehicle is in motion.

- Application and menu items displayed on the screen may differ depending on the connected device and iOS version.
- While connected to Apple CarPlay, calls are only made through Apple CarPlay. If you want to make a call with *Bluetooth®* handsfree calling, disconnect the USB cable from your iPhone and connect your iPhone via *Bluetooth®*.

To connect the paired device:



- For details on countries and regions where Apple CarPlay is available, as well as information pertaining to function, refer to the Apple homepage.
- Apple CarPlay cannot be used with USB connection via USB 2 connector.
- Apple CarPlay is a trademark of Apple Inc.

Apple CarPlay Operating Requirements & Limitations

Apple CarPlay requires a compatible iPhone with an active cellular connection and data plan. Your carrier's rate plans will apply.

Changes in operating systems, hardware, software, and other technology integral to providing Apple CarPlay functionality, as well as new or revised governmental regulations, may result in a decrease or cessation of Apple CarPlay functionality and services.

Honda cannot and does not provide any warranty or guarantee of future Apple CarPlay performance or functionality.

It is possible to use 3rd party apps if they are compatible with Apple CarPlay. Refer to the Apple homepage for information on compatible apps.

Use of User and Vehicle Information

The use and handling of user and vehicle information transmitted to/from your iPhone by Apple CarPlay is governed by the Apple iOS terms and conditions and Apple's Privacy Policy.

Audio System *(Continued)*

To Setup Apple CarPlay

Use of Apple CarPlay will result in the transmission of certain user and vehicle information (such as vehicle location, speed, and status) to your iPhone to enhance the Apple CarPlay experience. You will need to consent to the sharing of this information on the screen.

- 1 Enable the Apple CarPlay setting.

➡ P. 81

- 2 Pair the headsets. ➡ P. 90

- 3 Connect your iPhone to the USB port located in the travel trunk **GL1800DA** or shelter case **Except GL1800DA**. ➡ P. 106

▶ When connecting your iPhone, if it is recognized as iPod, disconnect the USB cable once, enable the Apple CarPlay ➡ P. 81, and then reconnect the USB cable again.

- 4 When the disclaimer message appears on the screen, select [Enable once] or [Always enable], and then press  or **ENT** switch.



[Enable once]: Allows only once. (Prompt shows again next time.)

[Always enable]: Allows anytime. (Prompt does not show again.)

[Cancel]: Does not allow this consent. If select [Cancel] and do not allow this consent, need to reconnect as iPod.

- 5 Apple CarPlay menu screen appears.

Apple CarPlay Menu

Apple CarPlay menu screen

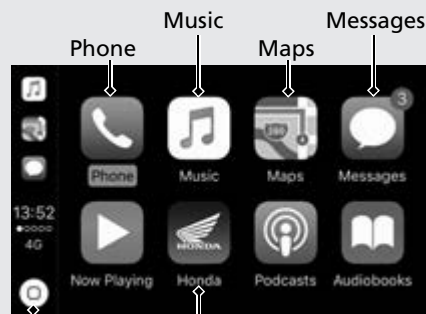

Go back to Home screen

Go back to Apple CarPlay menu screen



Home screen

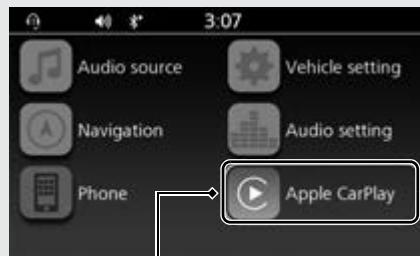

Go to Apple CarPlay menu screen

Phone

Access the contact list, make phone calls, or listen to voice mail.

Music

Play music stored on your iPhone.

Maps

Display Apple CarPlay map and use the navigation function just as you would on your iPhone.

- ▶ Only one navigation system (pre-installed navigation or Apple CarPlay) can give directions at a time. When you are using one system, directions to any prior destination set on the other system will be canceled, and the system you are currently using will direct you to your destination.

Messages

Check and reply to text messages, or have messages read to you.

HONDA

Go back to the Home screen.



Go back to the Apple CarPlay menu screen.

Operating Apple CarPlay with Siri

To activate Siri, pairing with device such as a headset must be paired. ➡ P.90

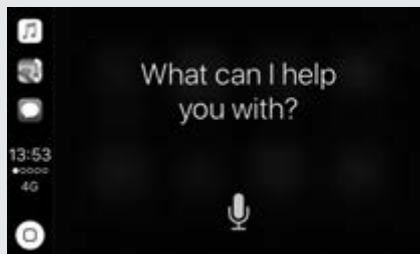

To Activate Siri

- 1 Start Apple CarPlay. ➡ P.112
- 2 Unlock your iPhone and enable Siri.
 - ▶ For details, refer to the iPhone User Guide, etc.
- 3 Press and hold «» switch on the left handlebar.
- 4 Say a voice command through the paired headset.

Siri may not be recognized correctly due to the effect of wind noise during running or external noise. In that case, try to change the position of the microphone or to adjust the windscreen height. ➡ P.150

Below Are Examples of Questions and Commands for Siri

- Call dad at work.
- What song is this?
- How's the weather tomorrow?
- Read my latest email.
- Find a table for four tonight in Chicago.

For more information, please visit www.apple.com/ios/siri.

To Deactivate Siri

Press and hold «» switch on the left handlebar.

Siri is a trademark of Apple Inc.

Audio System (Continued)

Android Auto

If you connect an Android Auto compatible Android phone to the system via 1.5A USB port, you can use the multi-information display, instead of the Android phone display, to access the Phone, Google Maps (Navigation), Notification center, and voice search functions.

When you first use Android Auto, you will be required to complete initial setting on your phone screen. We recommend that you complete this initial setting while safely parked before using Android Auto.

- To use Android Auto, you need to download the Android Auto app from Google Play to your smartphone.
- Only Android 5.0 or later versions are compatible with Android Auto. Bluetooth A2DP cannot be used with Android phone.
- Park your vehicle in a safe place before connecting your Android phone to Android Auto and when launching any compatible apps.
- In no event shall Honda be liable for any damages or troubles that occur in the use of Android phone.

- If a mobile network communication is unstable due to surrounding conditions or signal strength conditions, Android Auto functions may not be available.
- To use Android Auto, a headset connection is necessary.

To connect the paired device:



- You cannot operate Android Auto by the center panel switches/Interface dial while the vehicle is in motion.
- Application and menu items displayed on the screen may differ depending on the connected device setting and Android version.
- When your Android phone is connected to Android Auto, it is not possible to use the *Bluetooth*® Audio.
- For details on countries and regions where Android Auto is available, as well as information pertaining to function, refer to the Android Auto homepage.
- Android Auto cannot be used with USB connection via USB 2 connector.
- Google, Android, Google Maps, Google Play and Android Auto are trademarks of Google LLC.

Android Auto Operating Requirements & Limitations

Android Auto requires a compatible Android phone with an active cellular connection and data plan. Your carrier's rate plans will apply.

Changes in operating systems, hardware, software, and other technology integral to providing Android Auto functionality, as well as new or revised governmental regulations, may result in a decrease or cessation of Android Auto functionality and services.

Honda cannot and does not provide any warranty or guarantee of future Android Auto performance or functionality.

It is possible to use 3rd party apps if they are compatible with Android Auto. Refer to the Android Auto homepage for information on compatible apps.

Use of User and Vehicle Information

The use and handling of user and vehicle information transmitted to /from your phone by Android Auto is governed by the Google's Privacy Policy.

To Setup Android Auto

When you connect an Android phone to the unit via the 1.5A USB port, Android Auto is automatically initiated.

Use of Android Auto will result in the transmission of certain user and vehicle information (such as vehicle location, speed, and status) to your Android phone to enhance the Android Auto experience. You will need to consent to the sharing of this information on the screen.

- 1 Pair the headsets. ➔ P.90
- 2 Connect your Android phone to the USB 1 connector located in the travel trunk or shelter case. ➔ P.106
 - ▶ Only initialize Android Auto when you safely parked. When Android Auto first detects your phone, you will need to set up your phone so that auto pairing is possible. Refer to the instruction manual that came with your phone.

- 3 When the disclaimer message appears on the screen, select [Enable once] or [Always enable], and then press  or **[ENT]** switch.



[Enable once]: Allows only once.

(Prompt shows again next time.)

[Always enable]: Allows anytime.

(Prompt does not show again.)

[Cancel]: Does not allow this consent.

- 4 Android Auto screen appears.

- 5 To appear App launcher screen, select  and then press  or **[ENT]** switch.

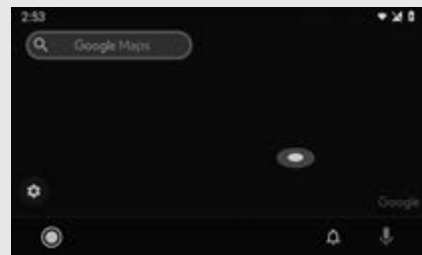

Audio System *(Continued)*

App launcher screen

App launcher screen

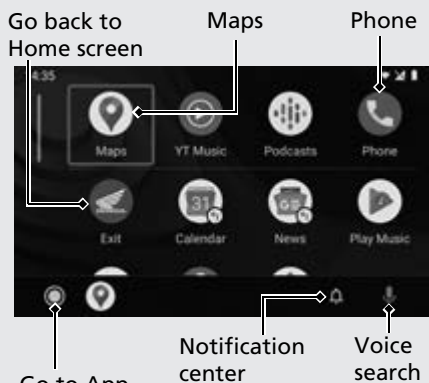

Maps (Navigation)

Display Google Maps and use the navigation function just as you would with your Android phone. When the vehicle is in motion, it is not possible to make keyboard entries. Stop the vehicle in a safe location to undertake a search or provide other inputs.

- ▶ Only one navigation system (pre-installed navigation or Android Auto) can give directions at a time. When you are using one system, directions to any prior destination set on the other system will be canceled, and the system you are currently using will direct you to your destination.

Phone (Communication)

Make and receive phone calls as well as listen to voice mail.

Voice search

Operate voice search.

Notification center

See recent calls, messages, and alerts.

Go to App launcher screen

The app launcher opens.

Exit

Go back to the Home Screen.

Operating Voice Search

To activate the voice search, pairing with device such as a headset must be paired.

➔ P. 90



Press and hold  switch on the left handlebar to operate Android Auto with your voice.

You can also activate the voice search by selecting the  icon.

Voice search may not be recognized correctly due to the effect of wind noise during running or external noise. In that case, try to change the position of the microphone or to adjust the windscreen height. ➔ P. 150

Below are examples of commands you can give with voice recognition:

- Reply to text.
- Call my mother.
- Navigate to Honda.
- Play my music.
- Send a text message to my brother.
- Call restaurant.

For more information, please refer to the Android Auto homepage.

Audio System *(Continued)*

Using **Bluetooth®** Handsfree Calling

Bluetooth® handsfree calling allows you to make and receive phone calls using your vehicle's audio system, without handling your mobile phone.

To use the handsfree calling, you need a *Bluetooth®* compatible mobile phone and *Bluetooth®* headsets.

- You cannot operate the handsfree calling functions by the center panel switches/Interface dial while the vehicle is in motion.
- If *Bluetooth®* connection is unstable due to surrounding conditions or radio wave conditions, the handsfree calling functions may not be available.
- While talking, you may be hard to hear due to wind noise during running or external noise. In that case, try to change the position of the microphone or to adjust the windscreen height. **➔P.150**
- The audio output will switch from speaker to headset automatically when making or receiving a phone call. (Even if the headset is not connected).

Preparation

- 1 Connect with the paired mobile phone. **➔P.84**
 - ▶ When the phonebook import function is enabled, the contents of the mobile phone's phonebook and call history are automatically imported to the system. The phonebook is updated after every connection. Call history is updated after every connection or call.

Phonebook Download: **➔P.92**

- 2 Connect the paired headsets (for rider and passenger if necessary). **➔P.90**
- 3 Enter the phone screen. **➔P.23**

Making a Call

You can make calls by inputting any phone number or by using the imported phonebook, call history or speed dial entries.

To change the call mode, press **◀/▶** on the 4-way key switch.

Changes the call modes as follows:

[Speed Dial] **➔P.119** → [Phonebook] **➔P.122** → [Call History] **➔P.122** → [Dial by Number] **➔P.119**

To adjust the phone volume: **➔P.71**







To enable/disable a call with passenger's headset: **➔P.92**

- Certain manual functions are disabled while the vehicle is in motion. You cannot select a grayed-out option until the vehicle is stopped.
- Only previously stored speed dial entries and call history can be called while the vehicle is in motion. However, if CarPlay or Android Auto is running, you can make a call using the Siri/voice search while the vehicle is in motion. **➔P.113**

To Make a Call Using a Phone Number [Dial by number]

This function is disabled while the vehicle is in motion.



- 1 Select [Dial by number].
- 2 Rotate  or press  /  on the 4-way key switch to enter a number, and then press  or [ENT] switch to set the number.
- 3 Select [Dial], and then press  or [ENT] switch to make a call.
▶To cancel the call, press  or [ENT] switch.

- 4 To end the call, press and hold  (Voice control) switch on the left handlebar.
▶The same action can be done by selecting [End call] on the screen.





To Make a Call Using a Speed Dial Entry [Speed dial]

You can make a call using the speed dial while the vehicle is in motion.

To make a call using the speed dial, you need to store the speed dial number in advance. 

Up to 20 speed dial numbers can be stored.

- 1 Select [Speed dial].
- 2 Select the phone number you want to call, and then press  or [ENT] switch. Dialing starts automatically.
- 3 To end the call, press and hold  (Voice control) switch on the left handlebar.
▶The same action can be done by selecting [End call] on the screen.

Audio System *(Continued)*

To Store a Phone Number in the Speed Dial List

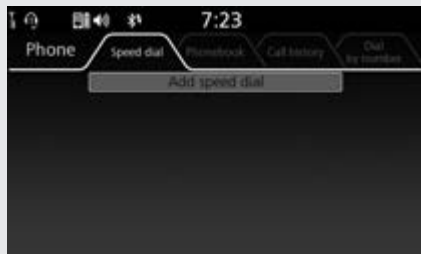

Speed dial numbers can be stored in three ways.





From [Speed Dial]:

- 1 Select [Speed dial].
- 2 Select [Add speed dial], and then press  or **ENT** switch.
- 3 The phonebook appears.
 - ▶ If the phonebook import function is disabled, select [YES] to import the phonebook manually.



- 4 Select the phone number you want to store, and then press and hold  (Home) button/ (Home) switch. The phone number will be stored in the speed dial list.

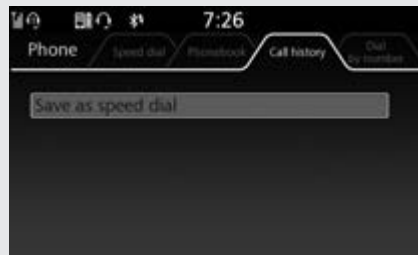

From [Call history]/[Phonebook]:

- 1 Select [Call history] or [Phonebook].
- 2 Select the phone number you want to store, and then press and hold  (Home) button/ (Home) switch.
- 3 Select [Save as Speed Dial], and then press  or **ENT** switch.





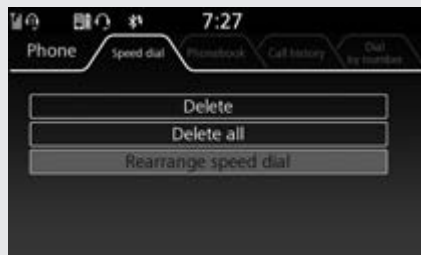

The phone number will be stored in the speed dial list.

To Rearrange the Order of the Speed Dial List

- 1 Select [Speed dial], and then press and hold  (Home) button/ (Home) switch.
- 2 Select [Rearrange speed dial], and then press  or **ENT** switch.







- 3 Select the phone number you want to arrange, and then press  or **ENT** switch.

- 4 Rotate  or press  /  on the 4-way key switch to change the order of the speed dial list.



- 5 Press  or **ENT** switch to set your selection.

To Delete a Stored Speed Dial Number

- 1 Select [Speed dial].
- 2 Select the phone number you want to delete, and then press and hold  (Home) button/ (Home) switch.
- 3 Select [Delete] or [Delete all], and then press  or **ENT** switch.
- 4 A confirmation message appears on the screen. Select [YES], and then press  or **ENT** switch.



Audio System (Continued)

To Make a Call Using the Imported Phonebook [Phonebook]

This function is disabled while the vehicle is in motion.

When the phonebook import function is enabled, the contents of the phone's phonebook is automatically imported to the system.

Phonebook Download: P.92



If the phonebook import function is disabled, a popup message will be displayed on the screen.

To import the phonebook manually, select [YES], and then press or **ENT** switch.



- 1 Select [Phonebook].
- 2 The phonebook is stored alphabetically. Select a name, and then press or **ENT** switch.
- 3 Select the phone number you want to call, and then press or **ENT** switch. Dialing starts automatically.
- 4 To end the call, press and hold (Voice control) switch on the left handlebar.
 - ▶ The same action can be done by selecting [End call] on the screen.

To Make a Call Using the Call History [Call history]

You can make a call using the call history while the vehicle is in motion.

Call history displays the last 30 dialed, received, or missed calls.



- 1 Select [Call history].
- 2 Select the phone number you want to call, and then press or **ENT** switch.
 - : Dialed call
 - : Received call
 - (red): Missed call
- 3 To end the call, press and hold (Voice control) switch on the left handlebar.
 - ▶ The same action can be done by selecting [End call] on the screen.

Receiving a Call

When there is an incoming call, an audible notification sounds and the Incoming Call screen appears.

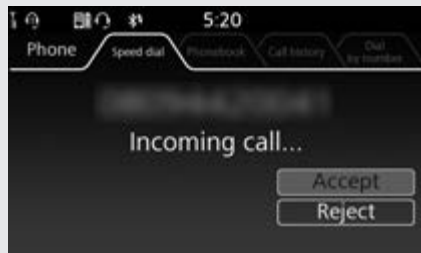

Ring Tone

If the connected mobile phone supports "in band ring tone", the ring tone stored on the phone sounds automatically while receiving a call automatically.

If "in band ring tone" is not supported, the ring tone stored in the audio system sounds.

To Receive a Call

When a call comes in, press  switch on the left handlebar to receive the call.

► The same action can be done by selecting [Accept] on the screen.

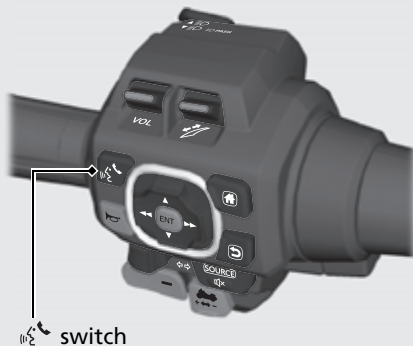

To adjust the phone volume:  P. 71

To enable/disable a call with passenger's headset:  P. 92

To Reject a Call

When a call comes in, press and hold  switch on the left handlebar to reject a call.

► The same action can be done by selecting [Reject] on the screen.

To End a Call

While talking, press and hold  switch on the left handlebar to end the call.

► The same action can be done by selecting [End call] on the screen.



Audio System *(Continued)*

■ Making Multiple Calls

You can handle multiple calls at the same time if the connected mobile phone supports the call waiting function.

To Receive a Second Call

When a call comes in, press  switch on the left handlebar to receive the call. If the recipient answers, the first call is put on hold.

► The same action can be done by selecting [Accept] on the screen.

To Make a Second Call



- 1 During a call, select [Dial], and then press  or **ENT** switch.
- 2 Select a phone number from [Speed dial], [Phonebook] or [Call history] or

enter a phone number in [Dial by number].

► To change the call mode, press  on the 4-way key switch.

- 3 The second outgoing call will start. If the recipient answers, the first call is put on hold.

To Switch Between Multiple Calls



Select [Switch calls], and then press  or **ENT** switch.

To End a Call in Progress

- 1 Press and hold  switch on the left handlebar to end the second call.
► The same action can be done by selecting [End call] on the screen.
- 2 The system will return to the first call on hold.



■ Sending DTMF tones during a call

You can send DTMF (Dual Tone Multi Frequency) tones during a call.

This is useful when you call a menu-driven phone system.

This function is disabled while the vehicle is in motion.



- 1 During a call, select [Touch tones], and then press  or **ENT** switch.
- 2 To send a DTMF tone, select a number key, and then press  or **ENT** switch.
 - ▶ To return to the previous screen, select [Quit] and press  or **ENT** switch.

Starting the Engine

Start your engine using the following procedure, regardless of whether the engine is cold or warm.

This vehicle is equipped with a Honda SMART Key system. Always keep Honda SMART Key on you when you ride the vehicle. ➔ P.56

NOTICE

- If the starter operates but the engine does not start, turn the ignition switch to OFF and wait 10 seconds before trying to start the engine again to recover battery voltage.
- Extended fast idling and revving the engine can damage the engine, and the exhaust system.
- Snapping the throttle or fast idling for more than about 5 minutes may cause exhaust pipe discoloration.
- The engine will not start if the throttle is fully open.

GL1800/B

- 1 Make sure the engine stop switch is in the (Run) position.
- 2 Unlock the steering. ➔ P.55
- 3 Turn the ignition switch to ON. ➔ P.49
- 4 Shift the transmission to Neutral (N indicator comes on). Alternatively, pull in the clutch lever to start your vehicle

with the transmission in gear so long as the side stand is raised.

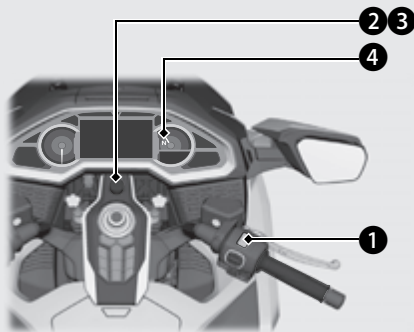

- 5 Press the start button with the throttle completely closed.



GL1800BD/D/DA

- 1 Check the parking brake ((P) parking brake indicator comes on).
- 2 Make sure the engine stop switch is in the (Run) position.
- 3 Unlock the steering. ➔ P.55
- 4 Turn the ignition switch to ON. ➔ P.49
 - ▶ Make sure the (N) indicator comes on. If the (N) indicator does not come on. ➔ P.129

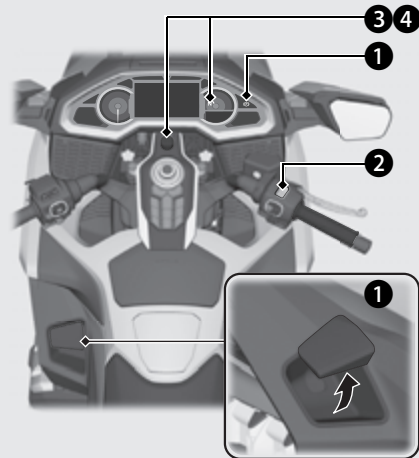

- 5 Press the start button with the throttle completely closed.
- 6 Make sure the parking brake lever is released before riding.



If the engine does not start:

- 1 Open the throttle fully and press the start button once.
- 2 Repeat the normal starting procedure.
- 3 If the engine starts, open the throttle slightly if idling is unstable.
- 4 If the engine does not start, wait 10 seconds before trying steps 1 & 2 again.

If Engine Will Not Start ➔ P.186

Quick Engine Starting

You can also start the engine by the following procedure.

- 1 Make sure the status of the Honda SMART Key is active ➔ P.56 and enter the operating range. ➔ P.57
- 2 While applying the brake lever or pedal firmly, press and hold the start button until engine starts.
 - ▶ The steering lock is automatically unlocked at the same time.
 - ▶ The quick engine starting will not operate if the transmission is in gear. The process will stop with the ignition switch ON. Start the engine with normal starting procedure. ➔ P.126
 - ▶ The engine will not start unless you perform the quick starting with correct conditions such as applying the brake. The process will stop with the ignition switch ON. Start the engine with normal starting procedure. ➔ P.126

When You Stop the Engine

- 1 To stop the engine, put the gear to Neutral (N indicator comes on).
- 2 Turn the ignition switch to OFF.
 - ▶ GL1800BD/D/DA If you turn the ignition switch to OFF when the vehicle is in gear, the engine will shut off with the clutch disengaged.
- 3 GL1800BD/D/DA Set the parking brake when you park the vehicle. ➔ P.60

Shifting Gears

GL1800/B

Your vehicle transmission has 6 forward gears in a one-down, five-up shift pattern.

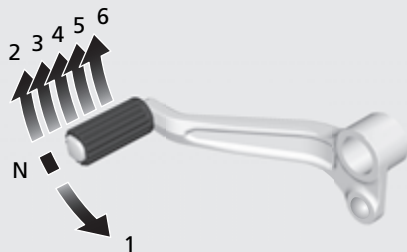

If you put the vehicle in gear with the side stand down, the engine will shut off.

Recommended Shift Points

Shifting Up

From 1st to 2nd	12 mph (20 km/h)
From 2nd to 3rd	19 mph (30 km/h)
From 3rd to 4th	25 mph (40 km/h)
From 4th to 5th	31 mph (50 km/h)
From 5th to 6th	37 mph (60 km/h)

Shifting Down

From 6th to 5th	28 mph (45 km/h)
From 5th to 4th	22 mph (35 km/h)
From 4th to 3rd	16 mph (25 km/h)

NOTICE

Improper shifting can damage the engine, transmission, and drive train. Also, coasting or towing the vehicle for long distances with the engine off can damage the transmission.

GL1800BD/D/DA

Your vehicle is equipped with an automatically controlled 7-speed transmission. It can be shifted automatically (by AT MODE) or manually (by MT MODE).

Recommended Shift Points

Shifting Up

From 1st to 2nd	15 mph (24 km/h)
From 2nd to 3rd	20 mph (32 km/h)
From 3rd to 4th	27 mph (43 km/h)
From 4th to 5th	35 mph (56 km/h)
From 5th to 6th	45 mph (72 km/h)
From 6th to 7th	55 mph (88 km/h)

Shifting Down

From 7th to 6th	45 mph (72 km/h)
From 6th to 5th	35 mph (56 km/h)
From 5th to 4th	25 mph (40 km/h)
From 4th to 3rd	18 mph (29 km/h)
From 3rd to 2nd	13 mph (21 km/h)
From 2nd to 1st	10 mph (16 km/h)

NOTICE

Improper shifting can damage the engine, transmission, and drive train. Also, coasting or towing the vehicle for long distances with the engine off can damage the transmission.

Dual Clutch Transmission

In order to respond to rider demands in a broad range of situations, the transmission is equipped with two operating modes, AT MODE (D) (automatic shift for regular operation); and MT MODE (for 7-speed manual operation), which delivers the same shift feel as a manual transmission.

- ▶ Always use the recommended tires to ensure correct Dual Clutch Transmission operation.

The Dual Clutch Transmission system runs a self check immediately after starting the engine.

"-" appears in the gear position indicator for a few seconds, then goes out. While "-" appears, you cannot shift into gear.

- ▶ Press the D side of the N-D switch
- ▶ Press the A/M switch
- ▶ Press the N side of the N-D switch

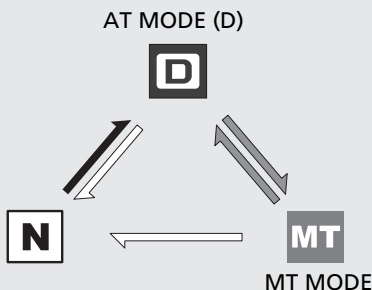

Neutral (N): Neutral is selected automatically when you turn the ignition switch to ON.

If neutral is not selected when you turn the ignition switch to ON:

- ▶ Turn the ignition OFF and ON again. You may hear (click) noises when the transmission shifts to Neutral (N). This is normal.
- ▶ If the Neutral (N) is still not selected after turning the ignition switch on, start the engine while applying the brake with side stand raised. If Neutral (N) is still not selected. ➔ P 194

When you can change between Neutral (N) and AT MODE (D):

- ▶ Vehicle is stopped and the engine is idling.
- ▶ Throttle is completely closed. It is not possible to change from Neutral (N) to AT mode (D) while the throttle is applied.
- ▶ You cannot change between Neutral (N) and AT MODE (D) while the wheels are rotating.
- ▶ Side stand is raised.

NOTICE

To prevent clutch damage, do not use the throttle to keep the vehicle stopped uphill.

AT MODE (D): In this mode the gears are shifted automatically according to your riding conditions.

And also using the shift up switch (+) or shift down switch (-), you can temporarily shift up or down. These switches are convenient when you want to temporarily down-shift in front of a curve, etc. ➔ P 130

MT MODE: You can choose between 7 gears in this mode.

Shifting Gears *(Continued)*

Changing between Neutral and AT MODE/MT MODE

Changing from Neutral (N) to AT MODE (D)

Press the D side of the N-D switch (1).

The D (AT MODE) indicator comes on, "1" is shown in the gear position indicator and first gear is selected.

Changing from AT MODE or MT MODE to Neutral (N)

Press the N side of the N-D switch (2).

Changing between AT MODE and MT MODE

Press the A/M switch (3).

The D (AT MODE) indicator goes out while MT MODE is selected (4).

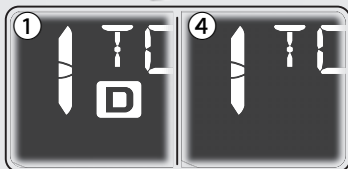
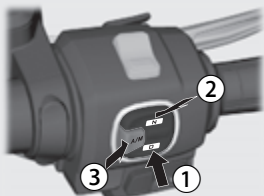

Riding in MT MODE

Shift up and down with the shift up switch (+) and shift down switch (-).

The selected gear is shown on the gear position indicator.

- ▶ If the MT MODE is selected, the transmission does not shift up automatically. Do not allow the engine revs to go into the red zone.
- ▶ The transmission automatically shifts down when you slow down, even in MT MODE.
- ▶ You will start from 1st gear even if MT MODE is selected.

Downshifting Blipping Control

In MT MODE, this system controls down shifting with the throttle completely closed by increasing engine revs automatically to match the gear ratio.

- ▶ This system may not increase engine revs in some running conditions.

Gear shift operation

Shifting Up:

Press the shift up switch (+) (5).

Shifting Down:

Press the shift down switch (-) (6).

You cannot continue shifting gear by keeping the shift switch pressed.

To continue shifting gear release the switch and press it again.

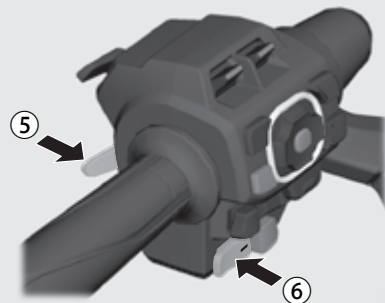

Shift Limit

You cannot downshift if the engine will exceed the rev limit.

Walking Speed Mode

GL1800BD/D/DA

The Walking Speed mode assists the rider with getting the vehicle into or out of tight areas by maneuvering the vehicle at slow speed.

► Operate the vehicle's engine only in a well-ventilated area.

Make sure there are no obstacles or people in the area. Avoid steep or uneven surfaces. Carrying a passenger while in Walking Speed mode is not recommended because it makes balance and control more difficult to maintain.

- 1 Sit astride the vehicle, in your normal riding position, with both feet on the ground.
- 2 Make sure the transmission is in neutral (N) indicator comes on) and the side stand is up.
- 3 Start the engine. ➔ P.126

- 4 Press the Walking Speed mode switch while applying the brake lever or pedal. The Walking Speed mode indicator is displayed.

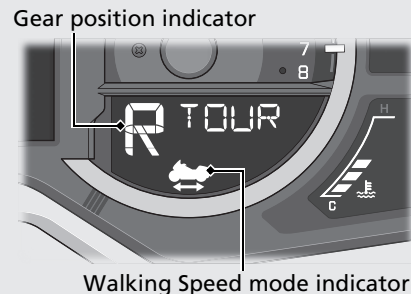

Walking Speed Mode *(Continued)*

- 5 To move the vehicle backward, press and hold the shift down switch (-), and then release the brakes. To move the vehicle forward, press and hold the shift up switch (+), and then release the brakes.
- ▶ The vehicle will move forward/backward as long as you hold the switch down.
 - ▶ When the shift up switch (+) (forward) is pressed, "F" is displayed on the gear position indicator. When the shift down switch (-) (backward) is pressed, "R" is displayed on the gear position indicator.
 - ▶ It may take a few seconds before the vehicle starts to move.
 - ▶ When operating the vehicle in Walking Speed mode, be sure to sit on the vehicle in your normal riding position.
 - ▶ When the engine is stopped in Walking Speed mode, the clutch will disengage. This will cause the vehicle to abruptly lose traction.

- ▶ While in Walking Speed mode, do not press the engine stop switch except in an emergency. This will cause the vehicle to abruptly lose traction.

Shift up switch (+)

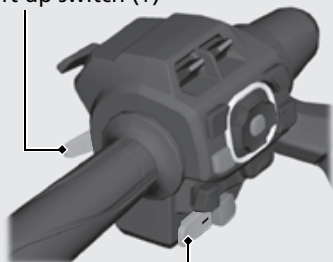

Shift down switch (-)

Guide the vehicle cautiously, using your legs to maintain balance. Use extreme care to maintain balance while in Walking Speed mode on loose surfaces (sand, dirt, gravel) or slick pavement.

- 6 To stop the vehicle, apply the brake lever or pedal.
- 7 To end Walking Speed mode, apply the brake lever or pedal. After the vehicle has stopped, press the Walking Speed mode switch while operating the brake lever or pedal, or press the N side of the N-D switch. Make sure the Walking Speed mode indicator turns off and the **N** indicator comes on.

Moving in Reverse

GL1800 and GL1800B Canada model

Your vehicle's reverse system allows you to back out of a parking space at slow speed. Make sure there are no obstacles or people in the direction of travel. Avoid steep or uneven surfaces. Carrying a passenger while reversing is not recommended because it makes balance and control more difficult to maintain.

- 1 Sit astride the vehicle, in your normal riding position, with both feet on the ground.
- 2 Make sure the transmission is in neutral (**N** indicator comes on) and the side stand is up.
- 3 Start the engine. 
- 4 Press the Reverse mode switch to turn on the reverse mode.
 - ▶ If the engine is not running, the reverse system cannot be activated.

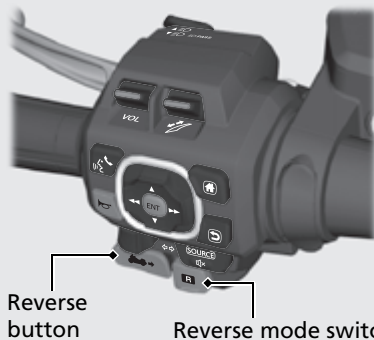

- 5 When you are ready to back up, press and hold the Reverse button. The vehicle will move in reverse as long as you hold the button down. ("R" is displayed on the gear position indicator.)

To prevent battery discharge, do not press the Reverse button for more than 1 minute.
- 6 Guide the vehicle backward cautiously, using your legs to maintain balance. Use extreme care to maintain balance while reversing on loose surfaces (sand, dirt, gravel) or slick pavement.

- 7 Release the Reverse button, and the vehicle will stop.
- 8 After your vehicle has stopped, press the Reverse mode switch to turn off the system. Make sure the **N** indicator comes on.

NOTICE

To avoid damaging the reverse system, do not engage or disengage reverse when the vehicle is moving.

Reverse System Overload

The Reverse mode is designed to move the vehicle at a constant slow speed. If the vehicle begins moving slower or faster than this speed because of obstacles or a steep pavement angle, press the Reverse mode switch to turn off the system and carefully roll the vehicle to a more level, unobstructed surface, and then start again.

Riding Mode

You can change the riding mode. The following parameters change according to each riding mode.

- Engine output characteristic
- Brake feel
- **GL1800BD/D/DA** DCT characteristic
- **GL1800/D/DA** Torque Control operating level
- **GL1800/D/DA** Suspension damping characteristic

Riding mode indicator

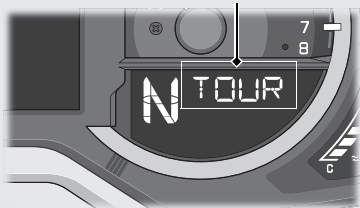

The following riding modes are available:

TOUR mode:

TOUR mode provides an engine and braking feel and suspension damping characteristics optimized for comfortable riding in situations such as long distance touring.

SPORT mode:

SPORT mode has a quicker and more powerful engine feel, harder braking feel, and harder suspension damping characteristics than with TOUR mode. For models equipped with DCT, shifting characteristics are oriented to maintain middle and high engine speeds.

ECON mode:

ECON mode has a gentler engine feel than with TOUR mode. For models equipped with DCT, shifting characteristics are oriented to maintain low and middle engine speeds.

RAIN mode:

RAIN mode has a gentler engine feel and softer suspension damping characteristics than with TOUR mode. For models equipped with DCT, shifting characteristics are gentler than those with TOUR mode.

Selecting the Riding Mode

GL1800BD/D/DA

Press the **MODE** button while the throttle is fully closed.

- ▶ The riding mode indicator blinks until the riding mode is changed.
- ▶ The riding mode does not change until the throttle is fully closed.
- ▶ Each time the ignition switch is turned to ON, the riding mode will automatically be set to **TOUR** mode.

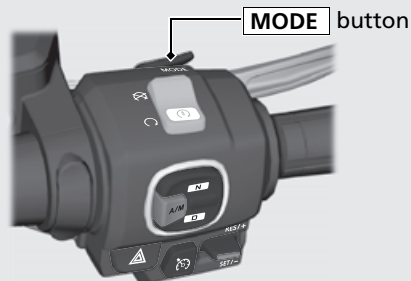

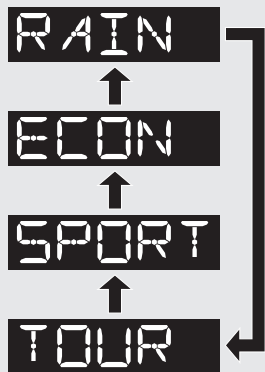

➔ : Press the **MODE** button

GL1800/B

Press one of the **MODE** buttons (▲ or ▼) while the throttle is fully closed.

- ▶ The riding mode indicator blinks until the riding mode is changed.
- ▶ The riding mode does not change until the throttle is fully closed.
- ▶ Each time the ignition switch is turned to ON, the riding mode will automatically be set to **TOUR** mode.

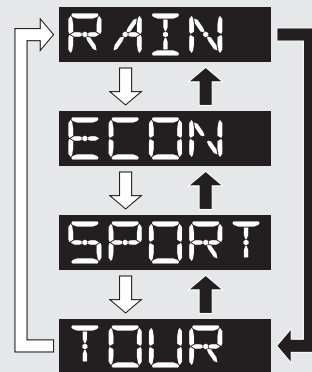
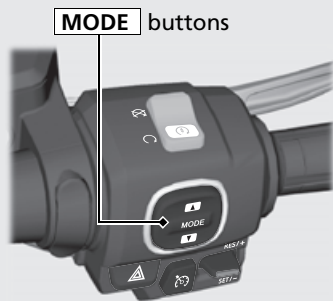

➔ : Press the **MODE** (▲) button

➞ : Press the **MODE** (▼) button

If all the segments of the riding mode indicator are displayed, see your dealer for servicing.

Honda Selectable Torque Control

GL1800/D/DA

Torque Control will limit the amount of torque applied to the rear wheel when the system detects the rear wheel spin during acceleration.

Torque Control can be turned on or off in the multi-information display. ➔ P.31



HSTC (Honda Selectable Torque Control)

- ▶ Torque Control mode (on/off) cannot be changed while riding.
- ▶ Stop the vehicle first and select the Torque Control mode (on/off) in the multi-information display.
- ▶ Each time the ignition switch is turned ON, the Torque Control is automatically turned to on.
- ▶ When the Riding mode is changed, the Torque Control characteristic also changes according to each mode.

Torque Control indicator

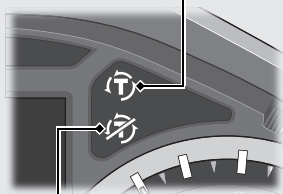

Torque Control OFF indicator

Cruise Control

The cruise control system allows you to maintain a steady speed within specified range.

The available speed setting range and operating gear are listed below:

	GL1800BD/D/DA	GL1800/B
Available speed setting range	20 - 100 mph (30 - 160 km/h)	30 - 100 mph (50 - 160 km/h)
Operating gear	From 3rd to 7th gear	From 3rd to 6th gear

When cruise control is on, your speed will still vary slightly, particularly going up and down hills.

Cruise control is intended for use only on straight, uncongested highways. Do not use cruise control on city streets, winding roads, during bad weather, or at any other time when you need total control of the throttle.

⚠ WARNING

Improper use of the cruise control can lead to a crash in which you could be seriously hurt or killed.

Use the cruise control only when traveling on open highways in good weather.

To Set Cruise Control

- 1 Make sure the traveling speed and operating gear are conformed to requirement of the system. Any speed other than available range will not be memorized.
- 2 Press the cruise control main switch. (The CRUISE MAIN indicator will come on.)
- 3 Accelerate to the desired speed.
- 4 Push the cruise control lever to [SET/-] side. (The CRUISE SET indicator will come on.)
Your current traveling speed is memorized.

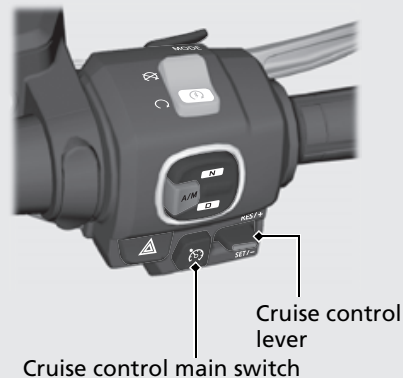
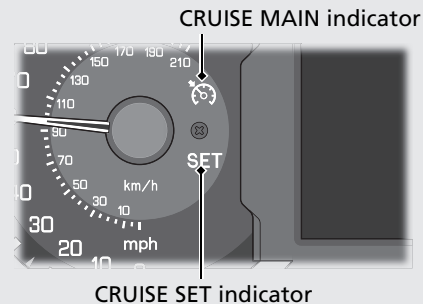

Cruise Control *(Continued)*

To Change the Set Speed

To Fine Tune the Set Speed

Display the cruise control set speed on the INFO 1 display. [▶ P. 34](#)

- To increase the set speed: tap the cruise control lever to [RES/+] side.
- To decrease the set speed: tap the cruise control lever to [SET/-] side.

The set speed is displayed in the INFO 1 display.

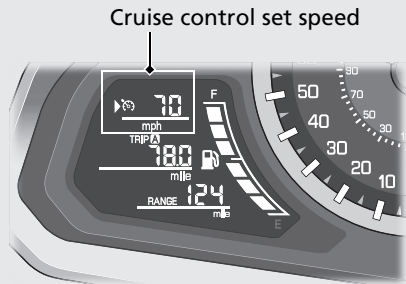

Each quick tap (brief push and release) on either side will change your speed by 1 mph or 1 km/h (depending on mileage meter set unit).

Any speed other than possible setting range will not be indicated (stops at the upper or lower limit speed).

To Change the Set Speed Continuously

- To increase the set speed: push and hold the cruise control lever to [RES/+] side. The system will accelerate your vehicle automatically. When you reach the desired speed, release the cruise control lever.

If the cruise control lever is pushed and held to [RES/+] side continuously, the set speed indicated in the INFO 1 display stops at the upper limit of the possible setting range.

- To decrease speed: push and hold the cruise control lever to [SET/-] side. The system will automatically slow your vehicle. When you reach the desired speed, release the cruise control lever. If the cruise control lever is pushed and held to [SET/-] side continuously, the set speed indicated in the INFO 1 display stops at the lower limit of the possible setting range.

To Manually Increase the Set Speed

- 1 Use the throttle to accelerate until you reach the desired speed.
- 2 Push and release the cruise control lever to [SET/-] side.

To Manually Increase Vehicle Speed

- 1 Use the throttle in the normal manner to accelerate.
- 2 To return to the set speed, close the throttle and coast without applying the brakes. The cruise system will maintain the speed you previously set.

To Cancel Cruise Control

To Disengage the System

- Press the cruise control main switch. (The CRUISE MAIN indicator goes off and the set speed will be erased from memory.)

To Temporarily Disengage the System

- 1 Perform one of the following operations to disengage the system temporarily. (CRUISE SET indicator temporarily goes off but the set speed remains in memory.)
 - Apply the brake lever or pedal.
 - Rotate the throttle grip past the automatically closed position in the deceleration direction.
 - **GL1800/B** Disengage the clutch or operate the shift lever.
- 2 To resume cruise control:
 - **GL1800BD/D/DA** If you are still over 20 mph (30 km/h), push and release the cruise control lever to [RES/+] side.
 - **GL1800/B** If you are still over 30 mph (50 km/h), push and release the cruise control lever to [RES/+] side.
 - **GL1800BD/D/DA** If you are under 20 mph (30 km/h), use the throttle to increase road speed above 20 mph (30 km/h) and then push and release the cruise control lever to [RES/+] side.
 - **GL1800/B** If you are under 30 mph (50 km/h), use the throttle to increase road speed above 30 mph (50 km/h) and then push and release the cruise control lever to [RES/+] side.

Hill Start Assist

The hill start assist (HSA) temporarily keeps the vehicle from rolling backward (or forward) if the brake lever or pedal (or forward) if the brake lever or pedal is released when stopped on an incline such as a hill or parking lot slope. Brake hydraulic pressure is maintained for about 3 seconds after releasing the brake lever or pedal. This helps keep the vehicle from rolling backward (or forward) when first opening the throttle grip, thereby assisting smooth movement and lessening the burden placed on the rider.

HSA is not a replacement for the parking brake.

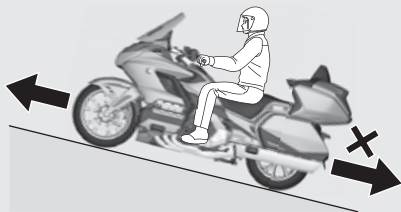

Hill start assist (HSA) indicator



 Hill start assist (HSA) indicator: Comes on in white when the HSA is ready to work, and flashes while the HSA is working.

The HSA is activated in the following conditions:

- Combined ABS indicator goes off
- Vehicle is stopped completely
- Throttle grip is closed
- Clutch lever is pulled **GL1800/B**
- Transmission is in gear (**N** indicator goes off)
- Side stand is retracted

Activating the HSA

To activate the HSA, squeeze the brake lever quickly until the hill start assist (HSA) indicator comes on in white and hold the brake lever.

Releasing the HSA

GL1800BD/D/DA

To start the vehicle, release the brake lever and gently open the throttle. (The HSA works about 3 seconds after releasing the brake lever)

GL1800/B

To start the vehicle, release the brake lever, and then open the throttle grip while releasing the clutch lever. (The HSA works about 3 seconds after releasing the brake lever)

If you lower the side stand or shift the transmission to neutral while the HSA is working, the HSA will be cancelled.

HSA may not prevent the vehicle from rolling backward (or forward) if the vehicle is on a steep slope.

If the hill start assist (HSA) indicator comes on in amber while riding

 **P.191**

Refueling

Opening the Fuel Fill Cap

- 1 Open the fairing pocket. ➔ P.143
- 2 Slide the fuel lid opener to open the fuel lid.
- 3 Turn the fuel fill cap counterclockwise and remove it.

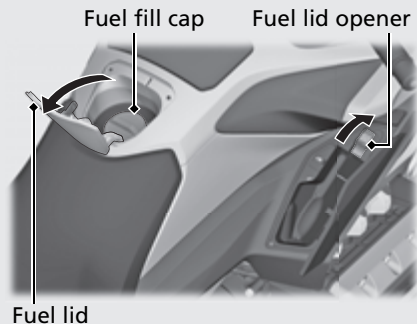

Do not fill with fuel above the lower edge of the filler neck.

Fuel type: Unleaded gasoline only

Recommended fuel octane number:

Pump Octane Number (PON) 86 or higher.

Tank capacity: 5.5 US gal (21 liters)

▮ Refueling and Fuel Guidelines ➔ P.15

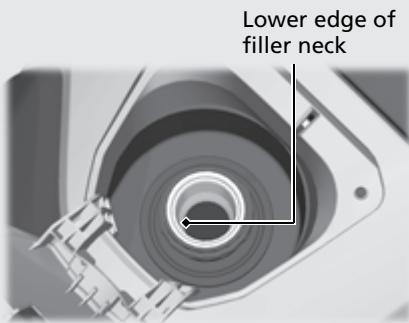

Closing the Fuel Fill Cap

- 1 After refueling, be sure to tighten the fuel fill cap firmly by tighten it clockwise until it clicks.
- 2 Close the fuel lid by pushing it until it locks.
- 3 Close the fairing pocket.

⚠ WARNING

Gasoline is highly flammable and explosive. You can be burned or seriously injured when handling fuel.

- Stop the engine, and keep heat, sparks, and flames away.
- Only handle fuel outdoors.
- Wipe up spills immediately.

Storage Equipment

Travel Trunk, Saddlebags and Fairing Pocket

- **GL1800/D/DA** equipped with the travel trunk, saddlebags and fairing pocket.
- **GL1800B/BD** equipped with the saddlebags and fairing pocket.

When you enter the operating range of the Honda SMART Key system with the Honda SMART Key on you, the travel trunk, saddlebags and fairing pocket can be opened.

Using the UNLOCK button on the Honda SMART Key, you can enable those who don't possess the key to open the compartments.

Each compartment can be opened when the Honda SMART Key is within the shaded area shown in the illustration.

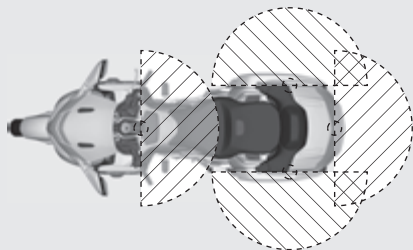

|| To Open the Travel Trunk and Saddlebags

The travel trunk and saddlebags are for lightweight items.

Cargo in the travel trunk and both saddlebags should not exceed:

20.0 lb (9.0 kg) each

However, regardless of compartment capacity, be sure you do not exceed the maximum load and cargo weight limits.

➡ P.244, 246

Make sure the Honda SMART Key is activated (➡ P.56), and then enter the operating range with the Honda SMART Key.

GL1800/D/DA

To open the travel trunk, press the travel trunk release button.

▶ The travel trunk unlocks and can be opened.

To open the saddlebags, press the saddlebag release button.

▶ Each saddlebag unlocks and opens.

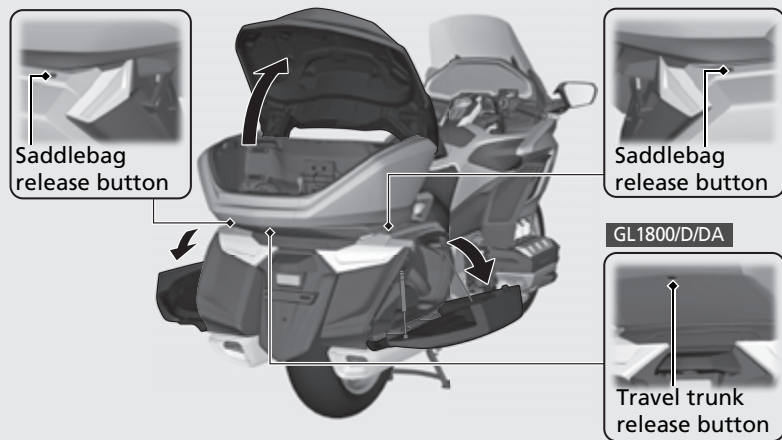

▮ To Close the Travel Trunk and Saddlebags

To close a compartment, place your hands on the edges of its lid and press down until it is firmly closed. Make sure the travel trunk and saddlebags “OPEN” indicator is not blinking before riding.

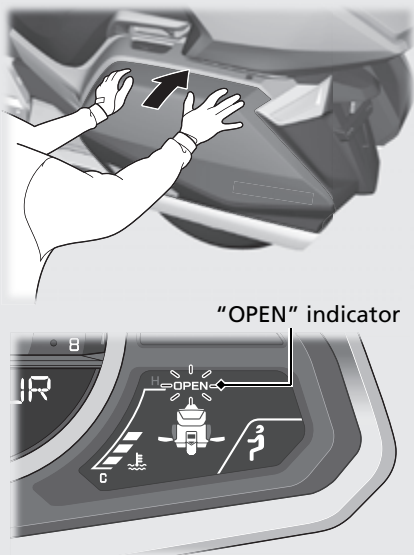

If the Saddlebags or Travel Trunk Won't Open ➔ P.200

GL1800/D/DA

You can store rider and passenger helmets in the travel trunk.

Store helmets as shown in the illustration.

- ▶ Make sure the front of the helmets are facing rearward.
- ▶ Some helmets may not fit in the compartment due to their size or design.

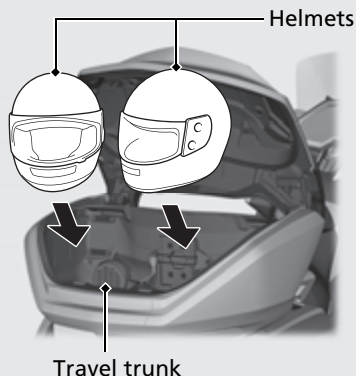

▮ To Open the Fairing Pocket

Make sure the Honda SMART Key is activated ➔ P.56, and then enter the operating range with the Honda SMART Key.

Take care not to store the deactivated Honda SMART Key in the fairing pocket.

The fairing pocket is for lightweight items. Cargo in the fairing pocket should not exceed:

4.5 lb (2.0 kg)

To open the fairing pocket, press the fairing pocket opener.

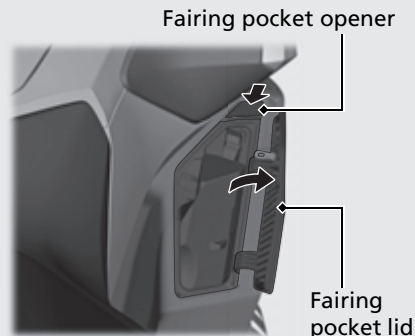

Storage Equipment *(Continued)*

■ To Close the Fairing Pocket

To close the fairing pocket, push the lid until it is firmly closed.

- ▶ Do not store valuables in the fairing pocket.
- ▶ Make sure the fairing pocket is closed before riding.
- ▶ Be careful not to flood this area when washing your vehicle.

Using the remote transmitter

To allow a person who does not possess the Honda SMART Key to open compartments, press the UNLOCK button on the Honda SMART Key (Turn signals blink 2 times).

When the UNLOCK button is pressed, the compartments can be opened by someone who does not have the Honda SMART Key.

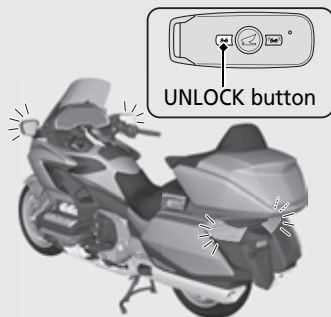

If you press the UNLOCK button, but nobody opens any of the compartments within about 30 seconds or about 30 seconds have passed after an opened compartment is closed, the compartments automatically will relock (Turn signals blink once).

- ▶ When the 30 days have passed after the ignition switch is turned to OFF or after the buttons of the Honda SMART Key is operated, the remote transmitter will no longer operate. To reset the system, turn the ignition switch ON once and then OFF.

Shelter Case Except GL1800DA

The shelter case is for lightweight items.

Cargo should not exceed:

6.6 lb (3.0 kg)

Press the shelter case opener, the shelter case lid opens.

To close the shelter case, push the lid until it is firmly closed.

- ▶ Do not store valuables in the shelter case.
- ▶ Make sure the shelter case is closed before riding.
- ▶ Be careful not to flood this area when washing your vehicle.

Shelter case opener

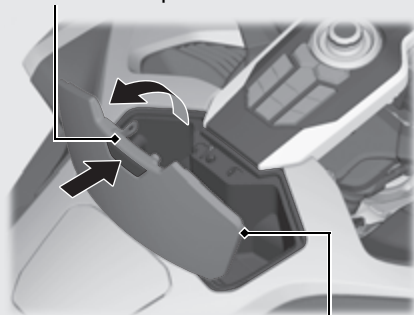

Shelter case lid

Helmet Holder

The helmet holder is located on the left grab rail.

▶ Use the helmet holder only when parked.

- 1 Open the left saddlebag P.142 and take up the helmet holder hanger. P.146
- 2 Pull the helmet holder release lever backward to unlock the helmet holder pin.

Helmet holder pin

Helmet holder release lever

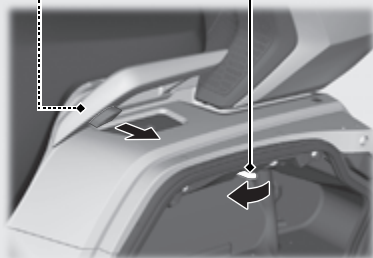

- 3 Insert the helmet holder hanger into the helmet D-ring.

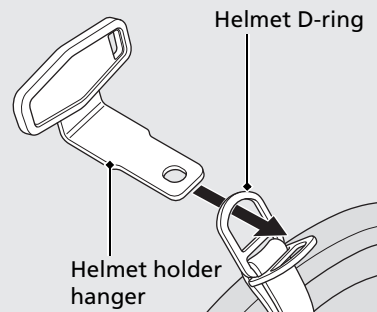

Storage Equipment *(Continued)*

- 4 Insert the helmet holder hanger in the direction shown into the slit on the left grab rail.
- 5 To lock the helmet holder, push the helmet holder button while putting the helmet holder pin through the hole of the helmet holder hanger.
- 6 Close the left saddlebag.

After using the helmet holder hanger, make sure to store it in the left saddlebag.

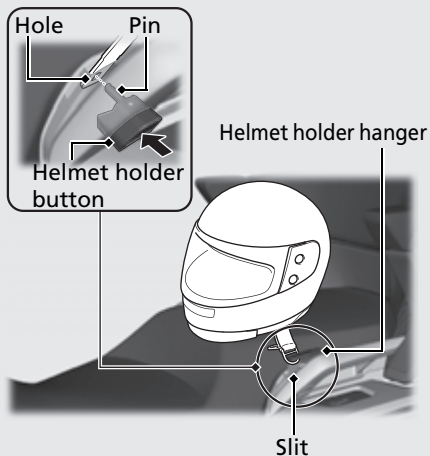

⚠ WARNING

Riding with a helmet attached to the holder can interfere with your ability to safely operate the vehicle and could lead to a crash in which you can be seriously hurt or killed.

Use the helmet holder only while parked. Do not ride with a helmet secured by the holder.

Tool Kit Canada model only, Owner's Manual and Helmet Holder Hanger

The tool kit (Canada model only), owner's manual and helmet holder hanger are stored in the left saddlebag.

Secure them with the rubber strap.

Store the Navigation System manual with the owner's manual.

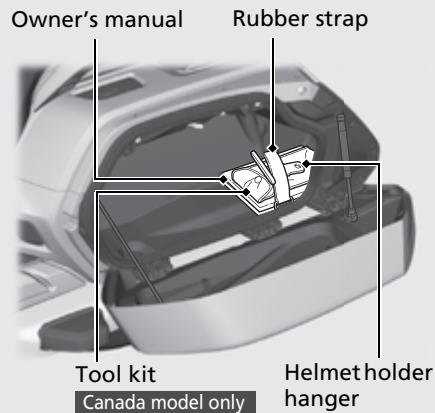

Opening the Left Saddlebag ➔ P.142

Comfort & Convenience Adjustment

Handle Grip Heater

This vehicle is equipped with a handle grip heater that warms up your hands during ride.

Wear gloves to protect your hands from the heated grips.

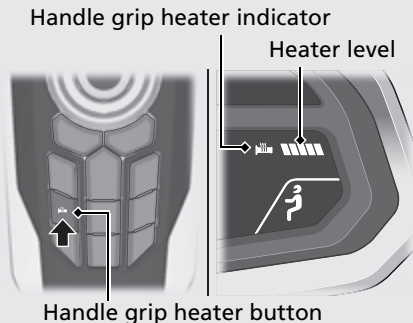

Heater Level:

The selected heater level is changed each time the handle grip heater button is pressed.

Handle Grip Heater Indicator:

Displayed when the handle grip heater is on.

If the handle grip heater indicator

blinks: → P.192

To Operate the Handle Grip Heater

- 1 Start the engine. → P.126
- 2 Press the handle grip heater button. The handle grip heater is on.
- 3 Select the heater level by pressing the switch.
▶ Do not leave the handle grip heater in the high position for a long time on a warm day.

To Turn Off the Handle Grip Heater

Press and hold the handle grip heater button until the handle grip heater indicator and heater level display goes off.

Do not use the handle grip heater with the engine at idle for a long time. It may result in a low (or dead) battery.

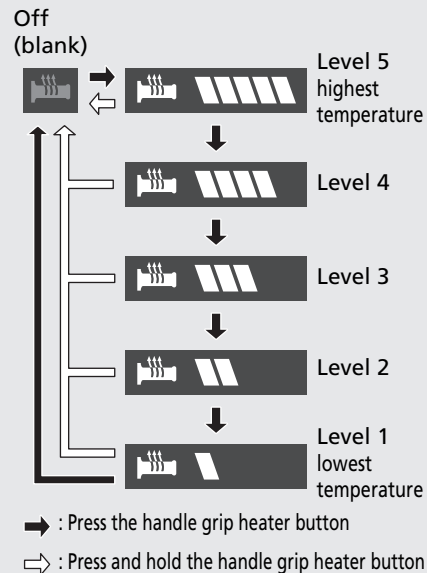

Maintains the selected level when the ignition switch is turned OFF and back to ON.

Comfort & Convenience Adjustment *(Continued)*

Seat Heater GL1800/D/DA

This vehicle is equipped with the seat heaters that warms up the rider's seat and passenger's seat for comfortable riding on a cold day.

To operate, adjust the seat heater buttons with the engine started.

Do not use the seat heaters with the engine at idle for a long time. It may result in a low (or dead) battery.

Rider Seat Heater Button

The rider seat heater button is located on the center panel.

The selected heater level is changed each time the seat heater button is pressed.

Rider seat heater indicator

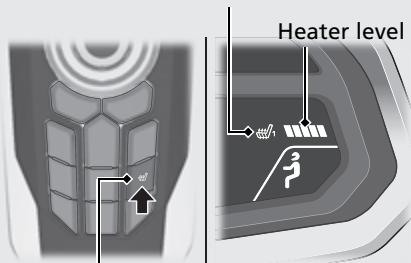

Rider seat heater button

To Operate the Rider Seat Heater

- 1 Start the engine. P.126
- 2 Press the rider seat heater button. The rider seat heater is on.
- 3 Select the heater level by pressing the rider seat heater button.
 - ▶ Do not leave the seat heater in the high position for a long time on a warm day.

To Turn Off the Rider Seat Heater

Press and hold the rider seat button until rider seat heater indicator and heater level display goes off.

Maintains the selected level when the ignition switch is turned OFF and then back ON.

Do not use the seat heaters with the engine at idle for a long time. It may result in a low (or dead) battery.

Do not use the seat heater when the seat is torn, cut or damaged as you can get burned.

Do not apply excessive stress to the seat, e.g. by securing articles to it with tie-down straps during transportation.

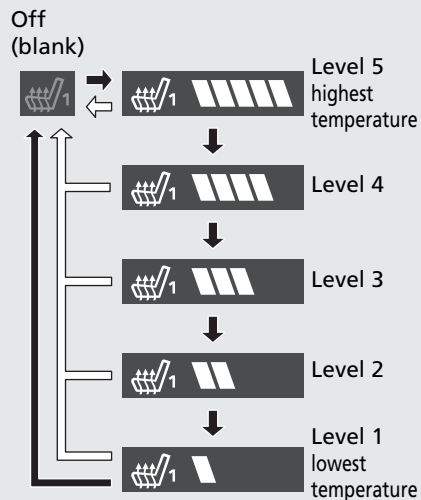

: Press the rider seat heater button

: Press and hold the rider seat heater button

Passenger Seat Heater Switch

The passenger seat heater switch is located on the left saddlebag.

The passenger seat heater switch has 6 positions (OFF, 1, 2, 3, 4, 5 indicated on the switch).

To Operate the Passenger Seat Heater

- 1 Start the engine.  P.126
- 2 Select the heater level by rotating the passenger seat heater switch. To set the desired heater level, align the number on the switch with the ► mark nearby the switch.
 - The highest temperature is 5 and the lowest temperature is 1.
 - Do not leave the seat heater in the high position for a long time on a warm day.

To Turn Off the Passenger Seat Heater

Rotate the passenger seat heater switch and align the OFF on the switch with the ► mark.

The passenger seat heater indicator goes off.

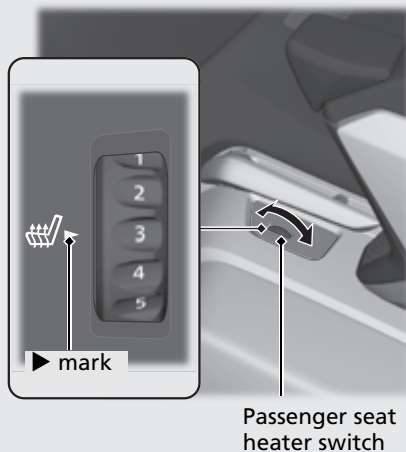

Do not use the seat heater with the engine at idle for a long time. It may result in a low (or dead) battery.

Do not use the seat heater when the seat is torn, cut or damaged as you can get burned.

Do not apply excessive stress to the seat, e.g. by securing articles to it with tie-down straps during transportation.

Seat Heater Indicators

Displayed when each seat heater is on. If the seat heater indicator blinks, see your dealer for servicing.

Rider seat heater indicator

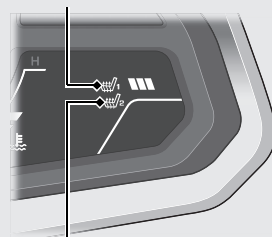

Passenger seat heater indicator

If the seat heater indicators blink:

 P.193

Comfort & Convenience Adjustment *(Continued)*

Adjustable Windscreen

You can adjust your windscreen height higher or lower according to your preference.

If possible, you should adjust your windscreen height to below eye level for better visibility.

■ To Adjust Windscreen Height

Turn the ignition switch to ON. When traveling faster than 3 mph (5 km/h), the windscreen automatically adjusts to the position it was at when the ignition switch was last turned to OFF.

Pushing the windscreen adjusting lever upwards raises the windscreen, and pushing it downwards lowers the windscreen.

The windscreen will be raised or lowered while the adjusting lever is being pressed. When you lower the windscreen, make sure the new position will allow safe operation of the vehicle.

Windscreen adjusting lever



Turning the ignition switch to OFF will automatically lower the windscreen to its original position.

To keep the windscreen raised after turning off the electrical system, such as when washing it, turn the ignition switch to OFF while pushing the windscreen adjusting lever upwards.

Pushing lever upward Pushing lever downward

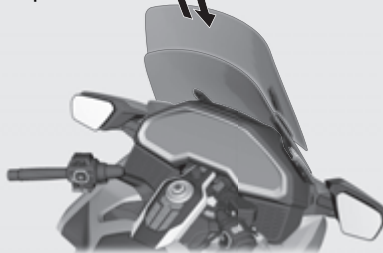

Windscreen Ventilation Louver

You can utilize the windscreen ventilation louver to direct the flow of fresh air.

To Operate the Windscreen Ventilation Louver

Press the release button, then the windscreen ventilation louver pops-up.

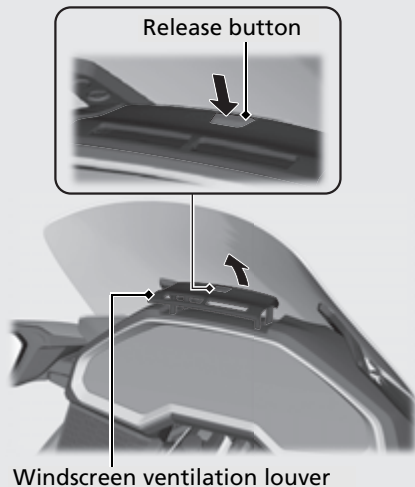

To Close the Windscreen Ventilation Louver

Push the center of the louver until the louver is firmly closed.

Maintenance

Please read “Importance of Maintenance” and “Maintenance Fundamentals” carefully before attempting any maintenance. Refer to “Specifications” for service data.

An optional larger tool kit may be available. Check with your Honda dealer’s parts department.

Importance of Maintenance	P. 153	Final Drive Oil	P. 173	Other Replacement	P. 183
Maintenance Schedule	P. 154	Brakes	P. 174	Honda SMART Key Battery.....	P. 183
Maintenance Fundamentals	P. 157	Side Stand	P. 177		
Removing & Installing Body Components ...	P. 167	Clutch	P. 178		
Battery	P. 167	Throttle	P. 179		
Cylinder Head Side Cover	P. 168	Other Adjustments	P. 180		
Fog Light Cover.....	P. 169	Clutch and Brake Levers	P. 180		
Left Engine Side Cover	P. 169	Electrical Adjustable Suspension			
Side Cover.....	P. 170	GL1800/D/DA	P. 181		
Engine Oil	P. 171	Rear Suspension GL1800B/BD	P. 182		
Coolant	P. 172				

Importance of Maintenance

Keeping your vehicle well-maintained is absolutely essential to your safety and to protect your investment, obtain maximum performance, avoid breakdowns, and reduce air pollution. Maintenance is the owner's responsibility. Be sure to inspect your vehicle before each ride, and perform the periodic checks specified in the Maintenance Schedule. ➤ P. 154

⚠ WARNING

Improperly maintaining your vehicle or failing to correct a problem before you ride can cause a crash in which you can be seriously hurt or killed.

Always follow the inspection and maintenance recommendations and schedules in this owner's manual.

For information about the exhaust emission and noise emission requirements of the U.S. Environmental Protection Agency (EPA), the California Air Resources Board (CARB), and the Environment and Climate Change Canada (ECCC). ➤ P. 232

USA

Maintenance, replacement or repair of the emission control devices and systems may be performed by any vehicle repair establishment or individual using parts that are "certified" to EPA standards.

Maintenance Safety

Always read the maintenance instructions before you begin each task, and make sure that you have the tools, parts, and skills required.

We cannot warn you of every conceivable hazard that can arise in performing maintenance. Only you can decide whether or not you should perform a given task.

Follow these guidelines when performing maintenance.

- Stop the engine and turn the ignition switch to OFF.
- Place your vehicle on a firm, level surface using the side stand, center stand (GL1800/D/DA) or a maintenance stand to provide support.
- Allow the engine, muffler, brakes, and other high-temperature parts to cool before servicing as you can get burned.
- Run the engine only when instructed, and do so in a well-ventilated area.

Maintenance Schedule

The maintenance schedule specifies the maintenance requirements necessary to ensure safe, dependable performance, and proper emission control.

Maintenance work should be performed in accordance with Honda's standards and specifications by properly trained and equipped technicians. Your dealer meets all of these requirements. All scheduled maintenance is considered a normal owner operating cost and will be charged to you by your dealer. Keeping an accurate maintenance record will help ensure your vehicle is properly maintained. ■ P. 156

Make sure whoever performs the scheduled maintenance completes the maintenance record. Retain all service documents. If you sell your vehicle, these service documents should be transferred with the vehicle to the new owner.

Items	Frequency*1								Regular Replace	Refer to page
	x 1,000 mi	0.6	4	8	12	16	20	24		
	x 1,000 km	1.0	6.4	12.8	19.2	25.6	32.0	38.4		
Emission-related Items	Fuel Line			I		I		I		-
	Throttle Operation			I		I		I		179
	Air Cleaner*2						R			-
	Crankcase Breather*3			C	C	C	C	C	C	-
	Spark Plug						R			-
	Valve Clearance							I		-
	Engine Oil			R		R		R		1 Year 171
	Engine Oil Filter			R				R		-
	Clutch Oil Filter (GL1800BD/D/DA)			R				R		-
	Engine Idle Speed				I		I		I	-
	Radiator Coolant*5				I		I		I	3 Years 172
	Cooling System				I		I		I	-
	Secondary Air Supply System						I			-
Evaporative Emission Control System*4						I			-	
Non-Emission-Related Items	Final Drive Oil									3 Years 173
	Brake Fluid*5			I	I	I	I	I	I	2 Years 174
	Brake Pads Wear			I	I	I	I	I	I	175
	Brake System				I		I		I	157
	Brake Light Switch				I		I		I	176
	Brake Lock Operation (GL1800BD/D/DA)			I	I	I	I	I	I	176
	Headlight Aim				I		I		I	-
	Clutch System (GL1800/B)				I		I		I	180
	Clutch Fluid*5 (GL1800/B)			I	I	I	I	I	I	2 Years 178
	Reverse Operation (GL1800/B)				I		I		I	-
	Side Stand				I		I		I	177
	Suspension				I		I		I	-
	Nuts, Bolts, Fasteners				I		I		I	-
	Wheels/Tires				I		I		I	-
Steering Head Bearings				I		I		I	-	

Maintenance Level

 : Intermediate. We recommend service by your dealer, unless you have the necessary tools and are mechanically skilled. Procedures are provided in an official Honda Service Manual. (P. 237)

 : Technical. In the interest of safety, have your vehicle serviced by your dealer.

Maintenance Legend

- I** : Inspect (clean, adjust, lubricate, or replace, if necessary)
- C** : Clean
- R** : Replace

Notes:

- *1 : At higher odometer reading, repeat at the frequency interval established here.
- *2 : Service more frequently when riding in unusually wet or dusty areas.
- *3 : Service more frequently when riding in rain or at full throttle.
- *4 : 50 STATE (meets California)
- *5 : Replacement requires mechanical skill.

Maintenance Record

Distance	Odometer	Date	Performed By:	Notes
600 miles (1,000 km)				
4,000 miles (6,400 km)				
8,000 miles (12,800 km)				
12,000 miles (19,200 km)				
16,000 miles (25,600 km)				
20,000 miles (32,000 km)				
24,000 miles (38,400 km)				
28,000 miles (44,800 km)				
32,000 miles (51,200 km)				
36,000 miles (57,600 km)				
40,000 miles (64,000 km)				
44,000 miles (70,400 km)				
48,000 miles (76,800 km)				
52,000 miles (83,200 km)				
56,000 miles (89,600 km)				
60,000 miles (96,000 km)				
64,000 miles (102,400 km)				
68,000 miles (108,800 km)				

Pre-ride Inspection

To ensure safety, it is your responsibility to perform a pre-ride inspection and make sure that any problem you find is corrected. A pre-ride inspection is a must, not only for safety, but because having a breakdown, or even a flat tire, can be a major inconvenience.

Check the following items before you get on your vehicle:

- Tire tread wear and air pressures are within limits ➤ P. 164
- Lights, horn, and turn signals operate normally

Check the following items if you are carrying a passenger or cargo:

- Combined weight is within load limits ➤ P. 244, 246
- Cargo is secured properly
- Suspension is adjusted to suit load ➤ P. 181, 182

Check the following items after you get on your vehicle:

- Throttle action moves smoothly without binding ➤ P. 179
- Brake lever and pedal operate normally
- Check the fuel level and refuel when needed ➤ P. 15, 141
- Engine stop switch functions properly ➤ P. 48

Check the following items at regular intervals:

- Oil level is between the upper and lower level marks ➤ P. 171
- Brake fluid level is
Front: above the LWR mark ➤ P. 174
Rear: above the LWR mark ➤ P. 174
- **GL1800/B** Clutch fluid level is above the LWR mark ➤ P. 178
- Engine coolant level is between the UPPER and LOWER level marks ➤ P. 172
- Side stand functions properly ➤ P. 177
- **GL1800BD/D/DA** Parking brake works properly ➤ P. 176

Periodic Checks

You should also perform other periodic maintenance checks at least once a month regardless of how often you ride, or more often if you ride frequently.

Also, check the odometer reading against the Maintenance Schedule and perform all maintenance that is due. ➤ P. 154

Tires and wheels	Check the air pressure (➤ P. 164), examine tread for wear and damage (➤ P. 164), and check the wheels for damage.
Fluid levels	Check the engine oil level (➤ P. 171), engine coolant level (➤ P. 172), clutch fluid level (GL1800/B) (➤ P. 178), final drive oil level (➤ P. 173) and brake fluid level (➤ P. 174).
Lights	Check that the headlight, brake lights, taillights, turn signals and license plate light are working properly.
Controls	Check the freeplay of the throttle grip (➤ P. 179). Check the clutch lever (GL1800/B) (➤ P. 180), front brake lever (➤ P. 180), rear brake pedal, and parking brake (GL1800BD/D/DA) (➤ P. 176) operate properly.
Fuses	Check that you have a full supply of spare fuses.
Nuts & bolts	Check the major nuts and bolts, and tighten as needed.

Replacing Parts

Always use Honda Genuine Parts or their equivalents to ensure reliability and safety. When ordering colored components, specify the model name, color and code mentioned on the color label.

The color label is attached on the reverse side of the fuel lid.  P. 141

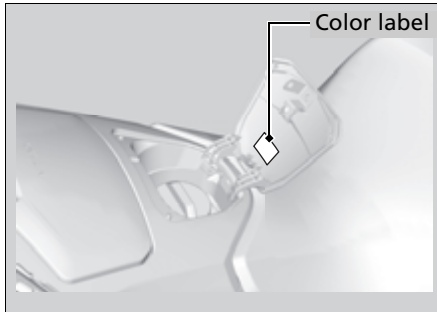

WARNING

Installing non-Honda parts may make your vehicle unsafe and cause a crash in which you can be seriously hurt or killed.

Always use Honda Genuine Parts or equivalents that have been designed and approved for your vehicle.

Battery

Your vehicle has a maintenance-free type battery. You do not have to check the battery electrolyte level or add distilled water. Clean the battery terminals if they become dirty or corroded.

Do not remove the battery cap seals. There is no need to remove the cap when charging.

NOTICE

An improperly disposed of battery can be harmful to the environment and human health. Always confirm local regulations for proper battery disposal instruction.

What to do in an emergency

If any of the following occur, immediately see your doctor.

- Electrolyte splashes into your eyes:
 - ▶ Wash your eyes repeatedly with cool water for at least 15 minutes. Using water under pressure can damage your eyes.
- Electrolyte splashes onto your skin:
 - ▶ Remove affected clothing and wash your skin thoroughly using water.
- Electrolyte splashes into your mouth:
 - ▶ Rinse mouth thoroughly with water, and do not swallow.

WARNING

The battery gives off explosive hydrogen gas during normal operation.

A spark or flame can cause the battery to explode with enough force to kill or seriously hurt you.

Wear protective clothing and a face shield, or have a skilled mechanic do the battery servicing.

WARNING: Battery posts, terminals, and related accessories contain lead and lead compounds.

Wash your hands after handling.

■ Cleaning the Battery Terminals

1. Remove the battery. ➤ P. 167
2. If the terminals are starting to corrode and are coated with a white substance, wash with warm water and wipe clean.
3. If the terminals are heavily corroded, clean and polish the terminals with a wire brush or sandpaper. Wear safety glasses.

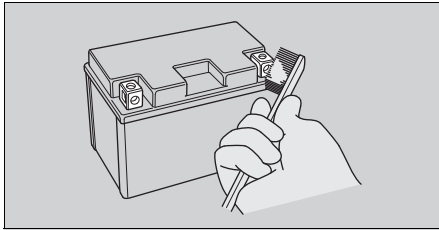

4. After cleaning, reinstall the battery.

The battery has a limited life span. Consult your dealer about when you should replace the battery. Always replace the battery with another maintenance-free battery of the same type.

■ Charging

If you use electrical accessories that drain the battery or you do not ride frequently, we recommend that you charge the battery every 30 days using a charger designed specifically for your Honda, which can be purchased from your dealer. Read the information that came with your battery charger and follow the instructions on the battery. Avoid using an automobile-type battery charger, as these can overheat a vehicle battery and cause permanent damage.

Make sure the ignition switch is turned to OFF before charging the battery.

NOTICE

Improper charging can damage the battery. If you can't charge the battery or it appears unable to hold a charge, contact your dealer.

NOTICE

Jump starting using an automobile battery can damage your vehicle's electrical system and is not recommended. Bump starting is also not recommended.

NOTICE

Installing non-Honda electrical accessories can overload the electrical system, discharging the battery and possibly damaging the system.

Fuses

Fuses protect the electrical circuits on your vehicle. If something electrical on your vehicle stops working, check for and replace any blown fuses. ➤ P. 213

Inspecting and Replacing Fuses

Turn the ignition switch OFF to remove and inspect fuses. If a fuse is blown, replace with a fuse of the same rating. For fuse ratings, see “Specifications.” ➤ P. 245, 247

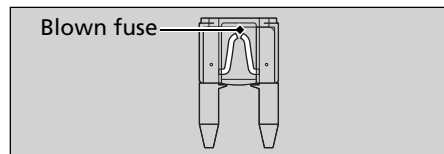

NOTICE

Replacing a fuse with one that has a higher rating greatly increases the chance of damage to the electrical system.

If a fuse fails repeatedly, you likely have an electrical fault. Have your vehicle inspected by your dealer.

Engine Oil

Engine oil consumption varies and oil quality deteriorates according to riding conditions and time elapsed.

Check the engine oil level regularly, and add the recommended engine oil if necessary. Dirty oil or old oil should be changed as soon as possible.

Selecting the Engine Oil

For recommended engine oil, see “Specifications.” ➤ P. 244, 246

If you use non-Honda engine oil, check the label to make sure that the oil satisfies all of the following standards:

- JASO T 903 standard*1: MA
- SAE standard*2: 10W-30
- API classification*3: SJ or higher

*1. The JASO T 903 standard is an index for engine oils for 4-stroke motorcycle engines. There are two classes: MA and MB. For example, the following label shows the MA classification.

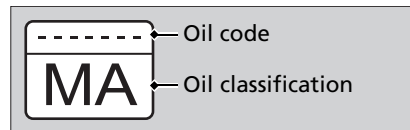

*2. The SAE standard grades oils by their viscosity.

*3. The API classification specifies the quality and performance rating of engine oils. Use SJ or higher oils, excluding oils marked as “Energy Conserving” or “Resource Conserving” on the circular API service symbol.

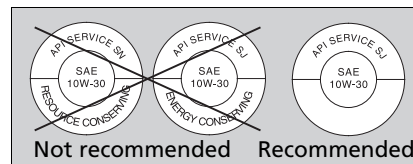

Brake Fluid (Clutch Fluid)

Do not add or replace brake fluid, except in an emergency. Use only fresh brake fluid from a sealed container. If you do add fluid, have the brake and clutch system serviced by your dealer as soon as possible.

NOTICE

Brake fluid can damage plastic and painted surfaces. Wipe up spills immediately and wash thoroughly.

Recommended brake fluid:

Honda DOT 4 Brake Fluid or equivalent

⚠ WARNING

Clean filler cap before removing.
Use only DOT 4 fluid from a sealed container.

Final Drive Oil

Recommended final drive oil:

Hypoid gear oil SAE 80

Recommended Coolant

Pro Honda HP Coolant is a pre-mixed solution of antifreeze and distilled water.

Concentration:

50% antifreeze and 50% distilled water

A concentration of antifreeze below 40% will not provide proper corrosion and cold temperature protection.

A concentration of up to 60% will provide better protection in colder climates.

NOTICE

Using coolant not specified for aluminum engines or tap/mineral water can cause corrosion.

Crankcase Breather

Service more frequently when riding in rain, at full throttle, or after the vehicle is washed or overturned. Service if the deposit level can be seen in the transparent section of the drain tube.

If the drain tube overflows, the air filter may become contaminated with engine oil causing poor engine performance.

Tires (Inspecting/Replacing)

Checking the Air Pressure

Even though your vehicle is equipped with tire pressure monitoring system (TPMS), visually inspect your tires and use an air pressure gauge to measure the air pressure at least once a month or any time you think the tires look low. Always check air pressure when your tires are cold.

GL1800/D/DA

Do not adjust tire pressure using the values indicated on the tire pressure gauge of the INFO 1 display.

The tire pressure values indicated on the tire pressure gauge of the INFO 1 display may not match actual values, because the tire pressure gauge indication is not updated instantly and is updated only at a certain period.

Even if the direction of the valve stem is changed, do not return it to the original position. Have your vehicle inspected by your dealer.

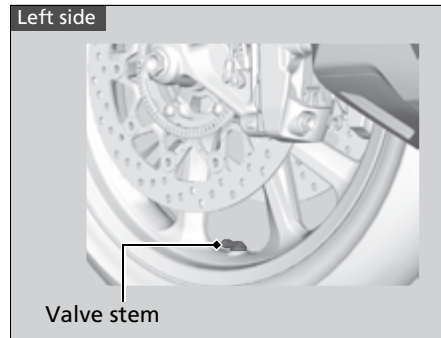

Inspecting for Damage

Inspect the tires for cuts, slits, or cracks that expose fabric or cords, or nails or other foreign objects embedded in the side of the tire or the tread. Also inspect for any unusual bumps or bulges in the side walls of the tires.

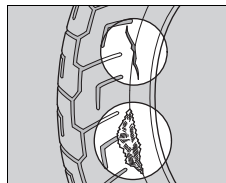

Inspecting for Abnormal Wear

Inspect the tires for signs of abnormal wear on the contact surface.

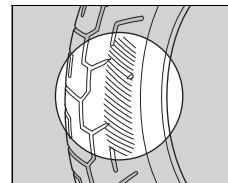

Inspecting Tread Depth

Inspect the tread wear indicators. If they become visible, replace the tires immediately.

For safe riding, you should replace the tires when the minimum tread depth is reached.

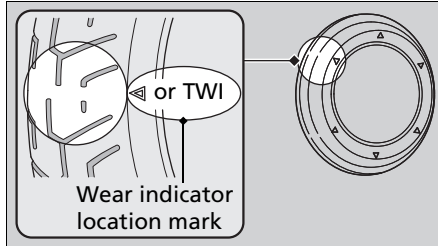

⚠ WARNING

Riding on tires that are excessively worn or improperly inflated can cause a crash in which you can be seriously hurt or killed.

Follow all instructions in this owner's manual regarding tires inflation and maintenance.

Have your tires replaced by your dealer. For recommended tires, air pressure and minimum tread depth, see "Specifications." ➤ P. 244, 246 Follow these guidelines whenever you replace tires.

- Use the recommended tires or equivalents of the same size, construction, speed rating, and load range.
- Have the wheel balanced with Honda Genuine balance weights or equivalent after the tire is installed.
- Do not install a tube inside a tubeless tire on this vehicle. Excessive heat build-up can cause the tube to burst.
- Use only tubeless tires on this vehicle. The rims are designed for tubeless tires, and during hard acceleration or braking, a tube-type tire could slip on the rim and cause the tire to rapidly deflate.

- Each wheel is equipped with a tire pressure sensor mounted inside the tire behind the valve stem. You must use TPMS specific wheels. Not using TPMS specific wheels can cause an air leak, a tire pressure monitoring system failure, or both.

⚠ WARNING

Installing improper tires on your vehicle can adversely affect handling and stability, and can cause a crash in which you can be seriously hurt or killed.

Always use the size and type of tires recommended in this owner's manual.

Tire Service Life

The service life of your tires is dependent on many factors, including, but not limited to, riding habits, road conditions, vehicle loading, tire air pressure, maintenance history, speed, and environmental conditions (even when the tires are not in use).

In addition to your regular inspections and maintenance, it is recommended that you have annual inspections performed once the tires reach 5 years old. It is also recommended that all tires be removed from service after 10 years from the date of manufacture, regardless of their condition or state of wear.

The last four digits of the TIN (tire identification number) indicate the date of manufacture.

Tire Identification Number (TIN)

The tire identification number (TIN) is a group of numbers and letters located on the sidewall of the tire.

- ①
- ②
- ③

DOT XXXX XXXX 22 09

DOT: This indicates that the tire meets all requirements of the U.S. Department of Transportation.

- ① XXXX: Factory code
- ② XXXX: Tire type code
- ③ 22 09: Date of manufacture (week & year).
Example: week 22 in year 09.

Tire Labeling Example

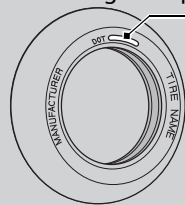

Tire identification number (TIN)

Removing & Installing Body Components

Battery

Removal

Make sure the ignition switch is turned to OFF.

After turning the ignition switch OFF, wait more than 60 seconds and then remove the negative cable of the battery. Because the electrical system may not function correctly.

1. Remove the left side cover. **P. 170**
2. Disconnect the negative \ominus terminal from the battery.
3. Disconnect the positive \oplus terminal from the battery.

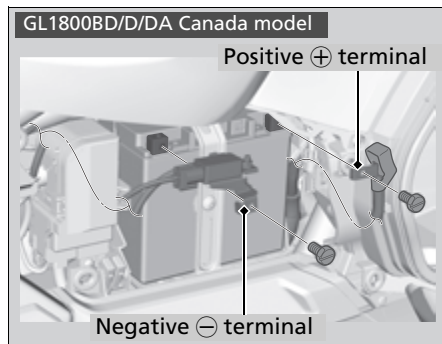
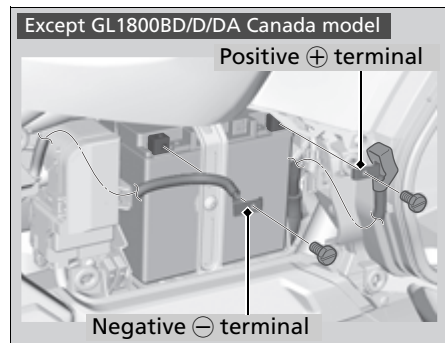

4. Remove the battery holder bolt.
5. Swing the battery holder as shown to avoid interference against the seat.

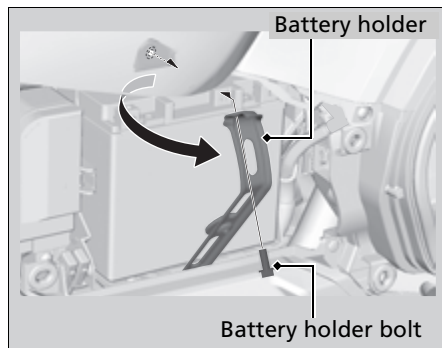

6. Remove the battery holder from the hook.
7. Remove the battery taking care not to drop the terminal nuts.

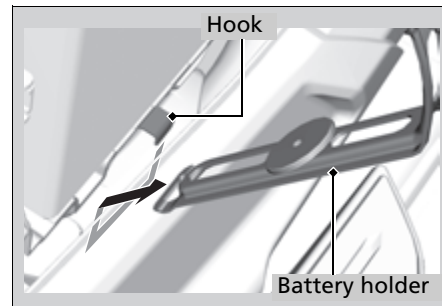

Installation

Install the parts in the reverse order of removal. Always connect the positive \oplus terminal first. Make sure that bolts and nuts are tight.

Make sure the clock information is correct after the battery is reconnected. ► P. 79

For proper handling of the battery, see "Maintenance Fundamentals." ► P. 157
"Battery Goes Dead." ► P. 212

Cylinder Head Side Cover

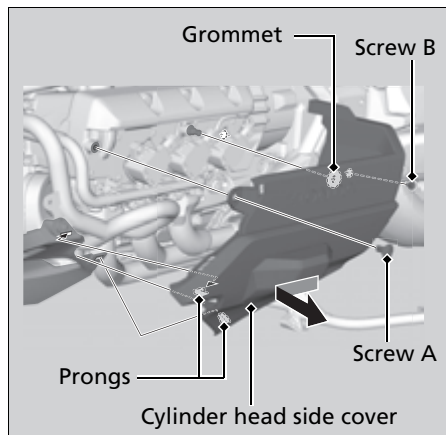

The right and left cylinder head side cover can be removed in the same way.

Removal

1. Remove the fog light cover. ► P. 169
2. Remove the screw A and B.
3. Remove the prongs from the lower cover.
4. Pull the grommet from the boss on the cylinder head and slide the cylinder head side cover forward, then remove it.

Installation

Install the parts in the reverse order of removal.

Fog Light Cover

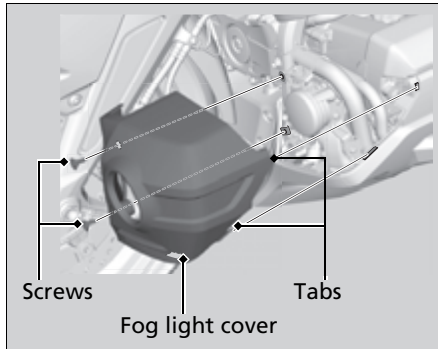

The right and left fog light cover can be removed in the same way.

Removal

1. Remove the screws.
2. Release the tabs from the cylinder head side cover.
3. Remove the fog light cover.

Installation

Install the parts in the reverse order of removal.

Left Engine Side Cover

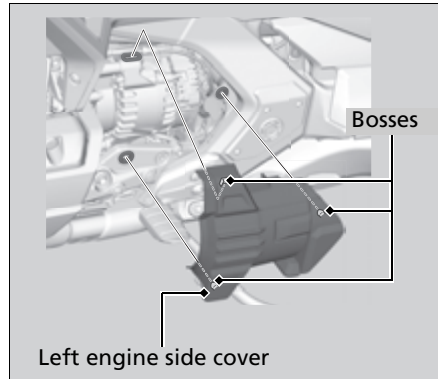

Removal

1. Release the bosses from the grommets.
2. Remove the left engine side cover.

Installation

Install the parts in the reverse order of removal.

Side Cover

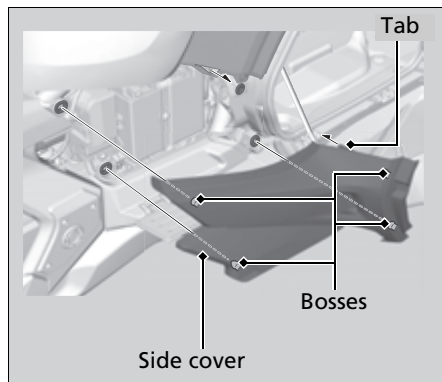

The right and left side cover can be removed in the same way.

Removal

1. Open the saddlebag. ► P. 142
2. Remove the bosses.
3. Release the tab from the saddlebag cover.
4. Remove the side cover.

Installation

Install the parts in the reverse order of removal.

Checking the Engine Oil

GL1800BD/D/DA Canada model

Check the engine oil with the Idling Stop system disabled. ➤ P. 61

1. If the engine is cold, idle the engine for 3 to 5 minutes.
2. Turn the ignition switch OFF and wait for 2 to 3 minutes.
3. Place your vehicle in an upright position on a firm, level surface.
4. Remove the dipstick and wipe it clean.
5. Insert the dipstick until it seats, but don't screw it in.

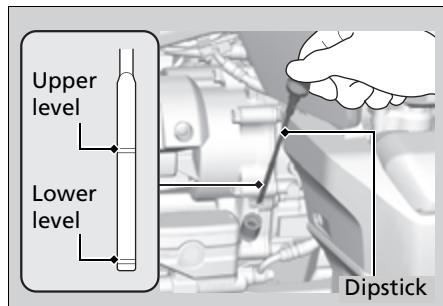

6. Check that the oil level is between the upper level and lower level marks on the dipstick.
7. Securely install the dipstick.

Adding Engine Oil

If the engine oil is below or near the lower level mark, add the recommended engine oil. ➤ P. 162, 244, 246

1. Remove the oil fill cap. Add the recommended oil until it reaches the upper level mark.
 - ▶ Place your vehicle in an upright position on a firm, level surface when checking the oil level.
 - ▶ Do not overfill above the upper level mark.
 - ▶ Make sure no foreign objects enter the oil filler opening.
 - ▶ Wipe up any spills immediately.

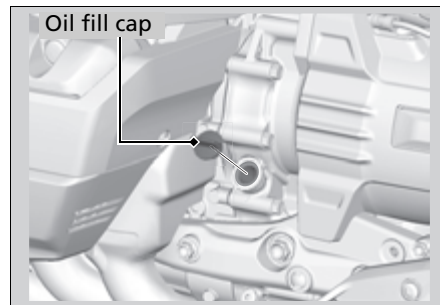

2. Securely reinstall the oil fill cap.

NOTICE

Overfilling with oil or operating with insufficient oil can cause damage to your engine. Do not mix different brands and grades of oil. They may affect lubrication and clutch operation.

For the recommended oil and oil selection guidelines, see "Maintenance Fundamentals." ➤ P. 162

Checking the Coolant

Check the coolant level in the reserve tank while the engine is cold.

1. Place your vehicle on a firm, level surface.
2. Remove the left engine side cover.
➤ P. 169
3. Hold your vehicle in an upright position.
4. Check that the coolant level is between the UPPER level and LOWER level marks in the reserve tank.

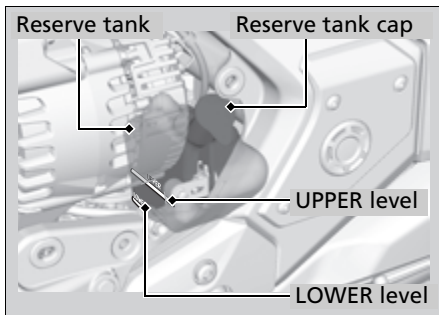

If the coolant level is dropping noticeably or the reserve tank is empty, you likely have a serious leak. Have your vehicle inspected by your dealer.

Adding Coolant

If the coolant level is below the LOWER level mark, add the recommended coolant (➤ P. 163) until the level reaches the UPPER level mark.

Add fluid only from the reserve tank cap and do not remove radiator cap.

1. Remove the left engine side cover.
➤ P. 169
2. Remove the reserve tank cap and add fluid while monitoring the coolant level.
 - ▶ Do not overfill above the UPPER level mark.
 - ▶ Make sure no foreign objects enter the reserve tank opening.
3. Securely reinstall the reserve tank cap.
4. Install the left engine side cover.

⚠ WARNING

Removing the radiator cap while the engine is hot can cause the coolant to spray out, potentially scalding you.

Always let the engine and radiator cool down before removing the radiator cap.

Checking the Final Drive Oil

1. Hold the vehicle upright on firm level ground.
2. Remove the oil fill hole cap and O-ring.
3. Check the oil level. It should be flush with the lower edge of the oil fill hole.

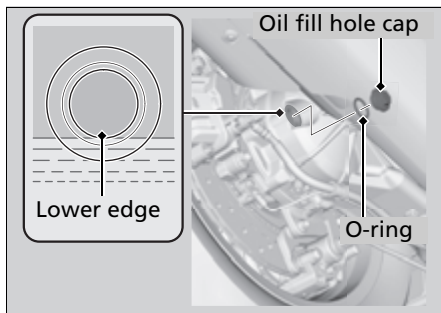

Adding Final Drive Oil

If the final drive oil level is low, check for oil leaks. Add the recommended final drive oil (➤ P. 163) until it reaches the lower edge of the opening.

1. Pour the final drive oil into the oil fill hole until it reaches the lower edge of the opening.
 - ▶ Do not over fill above the lower edge of oil fill hole.
 - ▶ Make sure no foreign objects enter the oil fill hole.
 - ▶ Wipe up any spills immediately.
2. Install a new O-ring onto the oil fill hole cap. Tighten the oil fill hole cap.

Torque: 5.9 lbf-ft (8 N·m, 0.8 kgf·m)

Checking Brake Fluid

1. Place your vehicle in an upright position on a firm, level surface.
2. Check that the brake fluid reservoir is horizontal and that the fluid level is above the LWR mark.

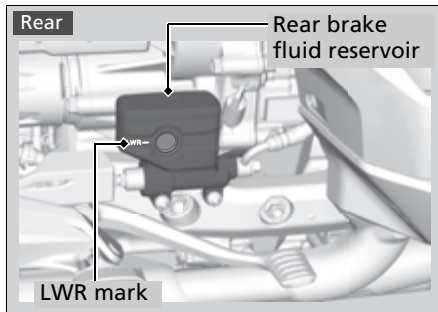
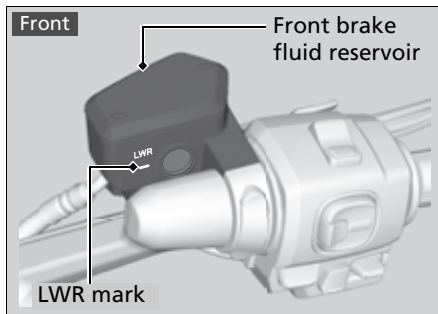

If the brake fluid level in either reservoir is below the LWR mark or the brake lever and pedal freeplay becomes excessive, inspect the brake pads for wear. If the brake pads are not worn, you most likely have a leak. Have your vehicle inspected by your dealer.

Inspecting the Brake Pads

Check the condition of the brake pad wear indicators.

Front

The pads need to be replaced if a brake pad is worn to the bottom of the indicator.

Rear

The pads need to be replaced if a brake pad is worn to the indicator.

1. **Front** Inspect the brake pads from in front of the brake caliper.
 - Always inspect both left and right brake calipers.
2. **Rear** Inspect the brake pads from below the brake caliper.

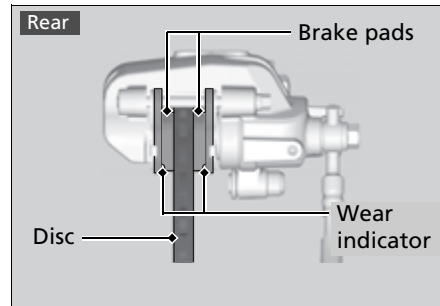
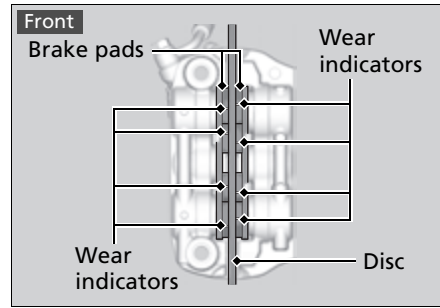

If necessary have the pads replaced by your dealer.

Always replace both left and right brake pads at the same time.

Checking the Parking Brake

GL1800D/BD/DA

Place your vehicle on a firm, level surface. Stop the engine and push your vehicle while set the parking brake to check the efficacy of the parking brake.

If the efficacy of the parking brake becomes weak, have the brake adjusted by your dealer.

Parking brake lever

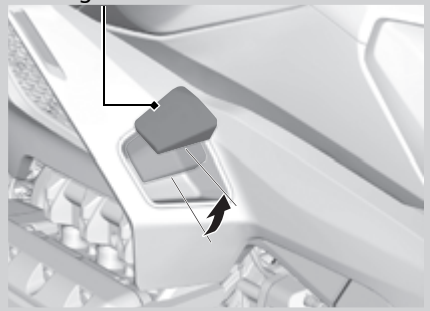

Adjusting the Brake Light Switch

Check the operation of the brake light switch.

Hold the brake light switch and turn the adjusting nut in the direction A if the switch operates too late, or turn the nut in the direction B if the switch operates too soon.

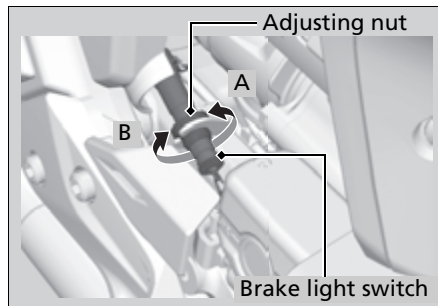

Checking the Side Stand

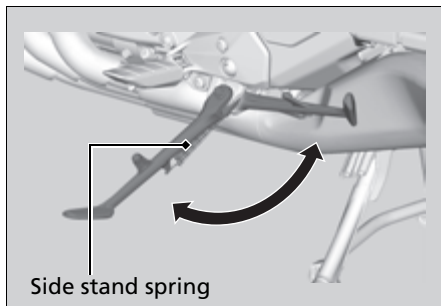

1. Check that the side stand operates smoothly. If the side stand is stiff or squeaky, clean the pivot area and lubricate the pivot bolt with clean grease.
2. Check the spring for damage or loss of tension.
3. **GL1800/B**
Sit on the vehicle, shift the transmission to Neutral, and raise the side stand.
GL1800D/BD/DA
Sit on the vehicle and raise the side stand.

4. **GL1800/B**
Start the engine, pull the clutch lever in, and shift the transmission into gear.
GL1800D/BD/DA
Start the engine and press the D side of N-D switch to switch the transmission into AT MODE (D).
5. Lower the side stand all the way. The engine should stop as you lower the side stand. If the engine doesn't stop, have your vehicle inspected by your dealer.

Checking Clutch Fluid

GL1800/B

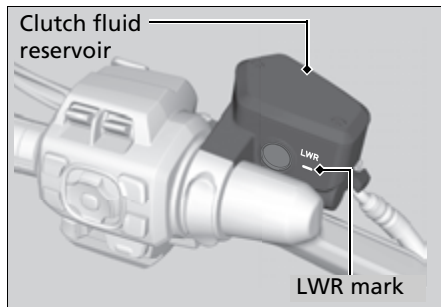

1. Place your vehicle in an upright position on a firm, level surface.
2. Check that the clutch fluid reservoir is horizontal and that the fluid level is above the LWR mark.

If the fluid level is low or if you find fluid leaks, or deterioration or cracks in the hoses and fittings, have the clutch system serviced by your dealer.

Checking the Throttle

With the engine off, check that the throttle rotates smoothly from fully closed to fully open. If the throttle does not move smoothly, close automatically, have the vehicle inspected by your dealer.

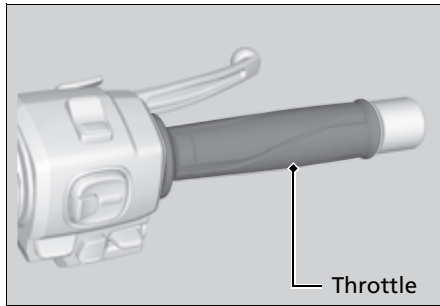

Adjusting the Clutch and Brake Levers

You can adjust the distances between the tip of the clutch lever (GL1800/B) and handle grip, and between the tip of the brake lever and handle grip.

Adjustment method

Turn the adjuster until the numbers align with the index mark while pushing the lever forward in the desired position.

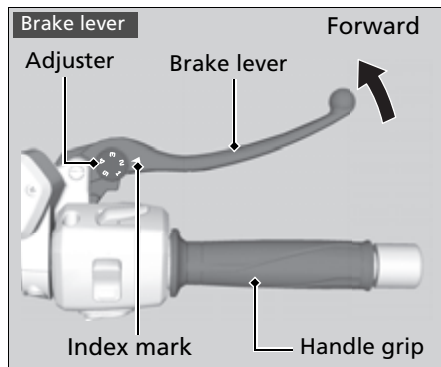
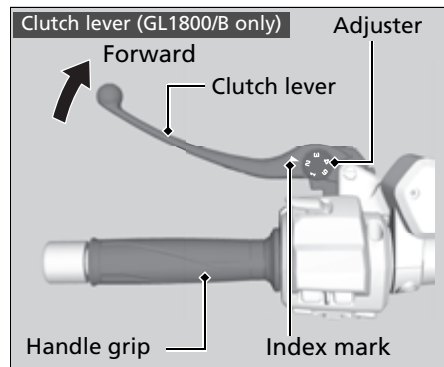

After adjustment, check that the lever operates correctly before riding.

NOTICE

Do not turn the adjuster beyond its natural limit.

Selecting the Electrical Adjustable Suspension

GL1800/D/DA

The electrical adjustable suspension allows the preload of the rear suspension to be adjusted in four levels according to riding and load conditions.

Preload can be adjusted on the multi-information display. ► P. 29

When the riding mode is changed, front and rear suspension damping is automatically adjusted to a setting corresponding to the mode. ► P. 134

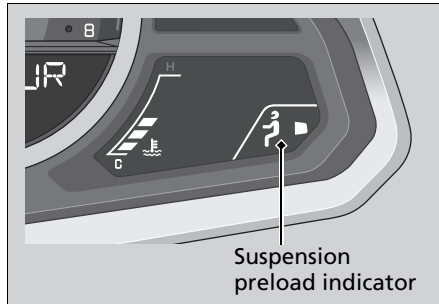

NOTICE

The front and rear shock absorber damper units contain high pressure nitrogen gas. Do not attempt to disassemble, service, or improperly dispose of the damper. See your dealer.

Adjusting the Rear Suspension

GL1800B/BD

You can adjust the spring preload of the rear suspension to suit the load or the road surface.

NOTICE

Do not turn the adjuster beyond its limits.

NOTICE

The rear shock absorber damper unit contains high pressure nitrogen gas. Do not attempt to disassemble, service, or improperly dispose of the damper. See your dealer.

Spring Preload

Remove the right side cover. ► P. 170

Turn the adjuster clockwise to increase spring preload (hard), or turn the adjuster counterclockwise to decrease spring preload (soft).

To set the standard position, turn the adjuster counterclockwise until it will no longer turn (lightly seat), and then turn the adjuster clockwise until it clicks. This click is position 0 (minimum setting). The standard position is 9 clicks from the minimum setting (total setting: 33 clicks).

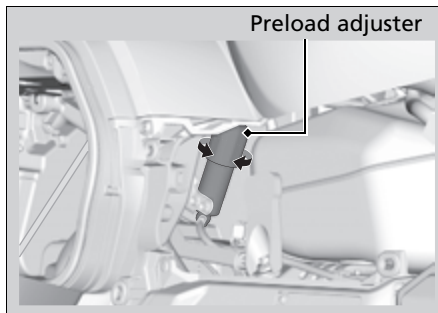

Replacing the Honda SMART Key Battery

If the Honda SMART Key indicator flashes 5 times when the ignition switch is turned ON, the low battery pop-up information appears, or the operating range becomes unstable, replace the battery as soon as possible.

We recommend to see your dealer for this service.

Battery type: CR2032

1. Push the release button and remove the built-in key from the Honda SMART Key.

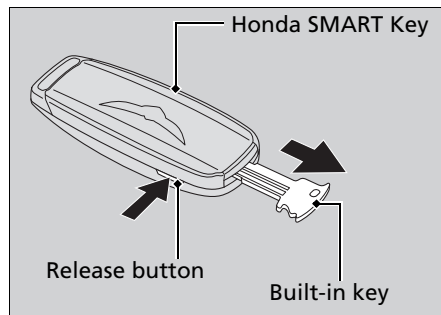

2. Slightly insert the built-in key from the opposite side into the key hole.

3. With the emblem upward, separate the Honda SMART Key by prying the built-in key as shown in the illustration.
 - ▶ Do not pry the built-in key forcibly.
 - ▶ Do not touch the circuit or terminal. This may cause problems.
 - ▶ Be careful to avoid scratching the waterproof covering or allowing dust to enter.
 - ▶ Do not forcibly dismantle the Honda SMART Key body.

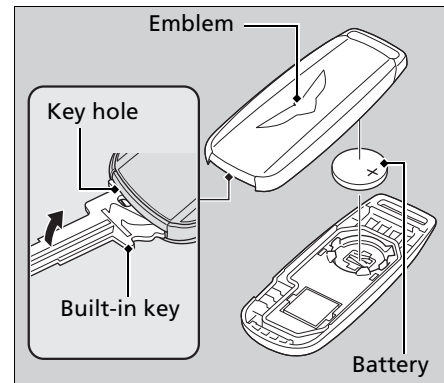

4. Replace the old battery with a new one with the positive ⊕ side facing up.
5. Assemble the parts in the reverse order of disassembly.

WARNING

Chemical Burn Hazard: do not swallow battery.

If swallowed, the battery can cause severe internal burns and even death.

- Keep battery away from children and battery compartment securely closed.
- If the battery compartment does not close securely, stop using the product and keep it away from children.
- Immediately seek medical attention if a child may have swallowed battery.

Troubleshooting

Engine Will Not Start	P. 186	Low Tire Pressure Indicator.....	P. 190	When the Honda SMART Key System Does Not Operate Properly	P. 197
Overheating (High coolant temperature indicator is on)	P. 187	TPMS Indicator	P. 191	Activating the Electrical System in an Emergency	P. 198
Warning Indicators On or Flashing	P. 188	AIRBAG Indicator GL1800DA	P. 191	If the Saddlebags or Travel Trunk Won't Open ...	P. 200
Low Oil Pressure Indicator	P. 188	Other Warning Indications	P. 192	Tire Puncture	P. 202
PGM-FI (Programmed Fuel Injection)		Fuel Gauge Failure Indication	P. 192	Audio System Trouble	P. 203
Malfunction Indicator Lamp (MIL)	P. 188	Handle Grip Heater Failure Indication ...	P. 192	Electrical Trouble	P. 212
Combined ABS Indicator	P. 188	Seat Heaters Failure Indication		Battery Goes Dead.....	P. 212
Torque Control Indicator		GL1800/D/DA	P. 193	Burned-out Light Bulb	P. 212
GL1800/D/DA	P. 189	Coolant Temperature Gauge Failure Indication ...	P. 193	Blown Fuse	P. 213
Honda SMART Key Indicator	P. 189	If the "-" is Blinking in the Gear Position Indicator While Riding (GL1800BD/D/DA)	P. 194		
Clutch Temperature Indicator		When the Idling Stop System Does Not Operate Properly (GL1800BD/D/DA Canada model) ...	P. 195		
GL1800BD/D/DA	P. 190				

Starter Operates But Engine Does Not Start

Check the following items:

- Check the correct engine starting sequence ➤ P. 126
- Check that there is gasoline in the fuel tank
- Check if the PGM-FI (Programmed Fuel Injection) Malfunction Indicator Lamp (MIL) is on
 - ▶ If the indicator lamp is on, contact your dealer as soon as possible.

Starter Does Not Operate

Check the following items:

- Check the correct engine starting sequence ➤ P. 126
- Check for a blown fuse ➤ P. 213
- Check for a loose battery connection (➤ P. 167) or battery terminal corrosion (➤ P. 160)
- Check the condition of the battery ➤ P. 212

If the problem continues, have your vehicle inspected by your dealer.

Overheating (High coolant temperature indicator is on)

The engine is overheating when the following occurs:

- High coolant temperature indicator comes on.
- The 6th (H) segment flashes in the coolant temperature gauge.
- Acceleration becomes sluggish.

If this occurs, pull safely to the side of the road and perform the following procedure. Extended fast idling may cause the high coolant temperature indicator to come on. Also the 6th (H) segment will flash.

NOTICE

Continuing to ride with an overheated engine can cause serious damage to the engine.

1. Stop the engine (➡ P. 49), and then turn the ignition switch to ON.

2. Check that the radiator fan is operating, and then turn the ignition switch to OFF.

If the fan is not operating:

Suspect a fault. Do not start the engine. Transport your vehicle to your dealer.

If the fan is operating:

Allow the engine to cool with the ignition switch turned OFF.

3. After the engine has cooled, inspect the radiator hose and check if there is a leak.

➡ P. 172

If there is a leak:

Do not start the engine. Transport your vehicle to your dealer.

4. Check the coolant level in the reserve tank. ➡ P. 172
 - ▶ Add coolant as necessary.
5. If 1 - 4 check normal, you may continue riding, but closely monitor the coolant temperature gauge.

Low Oil Pressure Indicator

If the low oil pressure indicator comes on, pull safely to the side of the road and stop the engine.

NOTICE

Continuing to ride with low oil pressure can cause serious damage to the engine.

1. Check the engine oil level, and add oil as necessary.  P. 171
2. Start the engine.
 - ▶ Only continue riding if the low oil pressure indicator goes off.

Rapid acceleration may momentarily cause the low oil pressure indicator to come on, especially if the oil is at or near the low level.

If the low oil pressure indicator stays on when the oil level is at the proper level, stop the engine and contact your dealer.

If the engine oil level goes down rapidly, your vehicle may have a leak or another serious problem. Have your vehicle inspected by your dealer.

PGM-FI (Programmed Fuel Injection) Malfunction Indicator Lamp (MIL)

If the indicator comes on while riding, you may have a serious problem with the PGM-FI system. Reduce speed and have your vehicle inspected by your dealer as soon as possible.

Combined ABS Indicator

If the Combined ABS indicator operates in one of the following ways, your brakes will continue to work as a conventional system, but without the Combined ABS function. Reduce your speed and have your vehicle inspected by your dealer as soon as possible.

- Indicator does not come on when the ignition switch is turned ON
- Indicator does not go off at speeds above 3 mph (5 km/h)
- Indicator comes on or starts flashing while riding

The combined ABS indicator may flash if:

- The front wheel leaves the ground for 1 second or more
- You turn the rear wheel while your vehicle is lifted off the ground.

This is normal but the Combined ABS is not in operation. To activate the system again, turn the ignition switch to OFF, and then to ON again.

Torque Control Indicator

GL1800/D/DA

If the indicator operates in one of the following ways, you may have a serious problem with the Torque Control. Reduce your speed and have your vehicle inspected by your dealer as soon as possible.

- Indicator comes on while riding.
- Indicator does not come on when the ignition switch is turned on.
- Indicator does not go off at speeds above 3 mph (5 km/h).

Even when the Torque Control indicator is on, your vehicle will have normal riding ability without Torque Control function.

- When the indicator comes on while the Torque Control is in operation, you will have to completely close the throttle to regain normal riding ability.

The Torque Control indicator may come on if you rotate the rear wheel while your vehicle is lifted off the ground. In this case, turn the ignition switch to OFF and then ON again. The Torque Control indicator will go off after your speed reaches 3 mph (5 km/h).

Honda SMART Key Indicator

■ If the Honda SMART Key Indicator Flashes 5 times When the Ignition Switch is Turned ON

Replacing the Honda SMART Key Battery ■ P. 183

■ When the Honda SMART Key Indicator is Flashing While the Electrical System is On

The Honda SMART Key indicator flashes when communication between your vehicle and Honda SMART Key stops after turning on the ignition switch.

It is probably caused by the following:

- Strong radio waves or noise are affecting the system
- You lost the Honda SMART Key while riding

However, this does not affect the operation of your vehicle until the ignition switch turned OFF.

You may not be able to turn off the electrical system when losing the Honda SMART Key while riding, or if the battery is low, or because the system is affected by strong radio waves or noise. If this occurs, turn the ignition switch counterclockwise and hold it until the electrical system shut off.

If you do not have the Honda SMART Key, the electrical system can be activated by means of emergency procedures. ■ P. 198

Clutch Temperature Indicator

GL1800BD/D/DA

The clutch temperature indicator flashes if the clutch temperature becomes unusually high.

If the indicator flashes, pull safely to the side of the road and shift the transmission to neutral, then idle the engine.

When the indicator goes off, riding can be restarted.

If this occurs frequently, contact your dealer.

NOTICE

Continuing to ride with high clutch temperature can cause serious damage to the clutch.

Low Tire Pressure Indicator

If the low tire pressure indicator flashes, check your tires as soon as possible.

If the low tire pressure indicator lights constantly, one or more of your tires is significantly underinflated. You should stop and check your tires as soon as possible.

For more information on temporary repair, refer to "Emergency Repair Using a Tire Repair Kit." ► P. 202

Check the air pressure when the tires are cold. (This means the vehicle has been parked for at least 3 hours.)

Adjust to the recommended tire pressures if necessary. ► P. 244, 246

When the low tire pressure indicator flashes or comes on, but you continue to ride, the low tire pressure indicator will go off in some cases. It is still necessary to check the air pressures of both tires after the tires cool because air in the tires is expanded with heat.

If the low tire pressure indicator does not go off after inflating the tires to the specified values, have your dealer to check the system as soon as possible.

Riding on an underinflated tire causes the tire to overheat and can lead to tire failure.

Under-inflation also reduces fuel efficiency and tire tread life, and may affect the vehicle's handling and stopping ability.

Because tire pressure varies by temperature and other conditions, the low tire pressure indicator may turn on unexpectedly.

Please note that the TPMS is not a substitute for proper tire maintenance, and it is the rider's responsibility to maintain correct tire pressure, even if under-inflation has not reached the level of turning on the low tire pressure indicator.

For example, if you check and fill your tires in a warm area, then ride in extremely cold weather, the tire pressure will be lower than measured and could be underinflated

and cause the low tire pressure indicator to turn on. Or, if you check and adjust your tire pressure in cooler conditions, and ride into extremely hot conditions, the tire may become overinflated. However, the low tire pressure indicator will not turn on if the tires are overinflated.

TPMS Indicator

The TPMS indicator comes on if there is a problem with the tire pressure monitoring system.

If this occurs, the system will shut off and no longer monitor tire pressure.

Have the system checked by your dealer as soon as possible.

Also the TPMS indicator may light for the following reasons:

- Interference of other electronic devices by using the same radio frequency.
- Using replacement wheels not equipped with tire pressure sensors.

AIRBAG Indicator

GL1800DA

The AIRBAG indicator comes on if there is a problem with the airbag system.

If the indicator does not come on, or comes and stays on when the ignition switch is turned on, or comes on while you are riding, have your vehicle inspected by your dealer as soon as possible as the airbag may not deploy when it could help save your life.

WARNING

Ignoring the airbag indicator can result in serious injury or death in a severe frontal impact if the airbag system does not work properly.

Have your vehicle checked by a dealer as soon as possible if the airbag indicator alerts you to a possible problem.

Hill Start Assist (HSA) Indicator

If the hill start assist (HSA) indicator comes on in amber in one of the following ways, you may have a serious problem with the HSA system.

Reduce speed and have your vehicle inspected by your dealer as soon as possible.

- Indicator comes on in amber while riding.
- Indicator does not come on when the ignition switch is turned to ON.
- Indicator does not go off at speeds above 3 mph (5 km/h).
- Even when the hill start assist (HSA) indicator comes on in amber, your vehicle will have normal riding ability without HSA function.

If the hill start assist (HSA) indicator comes on in white while stopping the vehicle, this is normal and the HSA is working properly.

Fuel Gauge Failure Indication

If the fuel system has an error, the fuel gauge segments will be displayed as shown in the illustration.

If this occurs, see your dealer as soon as possible.

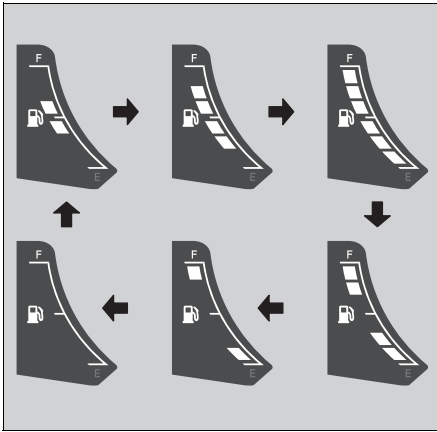

Handle Grip Heater Failure Indication

If the handle grip heater system has an error, the handle grip heater indicator will blink.

If this occurs, see your dealer as soon as possible.

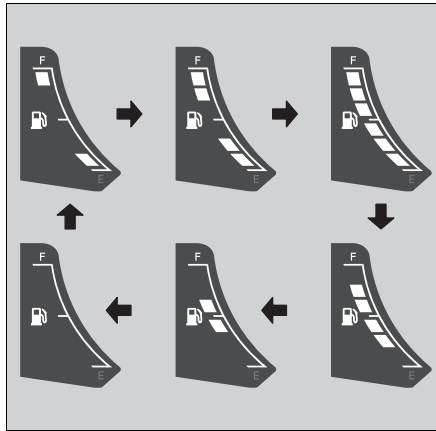

Seat Heaters Failure Indication

GL1800/D/DA

If the seat heater system has an error, the seat heater indicator will blink.

If this occurs, see your dealer as soon as possible.

Coolant Temperature Gauge Failure Indication

If the cooling system has an error, all segments will blink as shown in the illustration.

If this occurs, see your dealer as soon as possible.

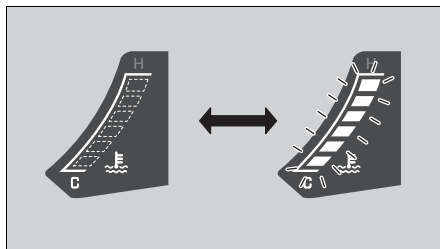

If the “-” is Blinking in the Gear Position Indicator While Riding (GL1800BD/D/DA)

If the “-” is blinking in the gear position indicator while riding, you may have a serious problem with the Dual Clutch Transmission system.

Park your vehicle in a safe place and have your vehicle inspected by dealer immediately.

It may be possible to ride your vehicle by following the steps below.

1. Turn the ignition switch to OFF.
2. Turn the ignition switch to ON and start the engine.

If you cannot start the engine:

Turn the ignition switch to OFF and move the vehicle back and forth slightly (to disengage the gears).

Turn the ignition switch to ON again and start the engine.

If you still cannot start the engine:

Start the engine while applying the brake lever or pressing the brake pedal.

If you can shift from N to D range:

When a gear position is shown in the gear position indicator, you can ride in that gear. Take your vehicle to your dealer riding at a safe speed.

If you can't shift from N to D range and the “-” is blinking:

Possible damage to the DCT is preventing you from riding.

Have your vehicle inspected by your dealer immediately.

Idling Stop Indicator Does Not Come On

When the Idling Stop indicator does not come on, perform the followings.

If the Idling Stop system is off:

Press the start/Idling Stop button or set the Idling Stop system at the multi-information display.

If the engine is cold:

Warm up the engine.
The Idling Stop system does not operate when the engine is cold.

If you did not ride the vehicle after engine starts:

Ride the vehicle at speeds of over 6 mph (10 km/h). The Idling Stop system does not operate until you ride once.

If PGM-FI malfunction indicator lamp (MIL) lights:

When the PGM-FI malfunction indicator lamp (MIL) lights, the Idling Stop system does not operate for protection of the engine. See your dealer.

If the battery voltage is low:

Ride the vehicle for a while, then stop the engine and then restart the engine, referring to the correct engine starting procedure (▶ P. 126). The Idling Stop system may not operate if the battery voltage is low.

If this occurs frequently, contact your dealer.

If the temperature of the battery is cold:

Ride the vehicle for a while.
The Idling Stop system does not operate when the battery is cold.

Engine is Not Stopped by the Idling Stop System While the Idling Stop Indicator is On

When the engine is not stopped by Idling Stop system while the Idling Stop indicator is on, perform the following.

If the vehicle does not stop completely:

Stop the vehicle completely. The Idling Stop system operates if the speed is only at 0 mph (0 km/h).

If the throttle is not closed completely:

Close the throttle completely.

If the Hill start assist (HSA) is operated:

The Idling Stop system does not stop the engine while the HSA is operated.

When the transmission is shifted in Neutral:

The Idling Stop system does not stop the engine when the transmission is shifted in Neutral (N side of the N-D switch is pressed).

Engine Does Not Start Even If the Throttle is Opened

Engine does not start even if the throttle is opened, perform the followings.

If the side stand is down:

While the engine is stopped by the Idling Stop system, if you operate the side stand, the flashing Idling Stop indicator changes flashing to off, and the Idling Stop system is cancelled. Restart the engine with the start/Idling Stop button, referring to the starting procedure (▶ P. 126) for standard engine starting.

If the rider does not sit astride the vehicle:

When the rider has not been sitting astride the vehicle for approx. 3 minutes, the Idling Stop indicator changes from flashing to off and you cannot restart the engine, even if you open the throttle.

Restart the engine with the start/Idling Stop button, referring to the starting procedure for standard engine starting.

If the start/Idling Stop button is operated:

While the engine is stopping by the Idling Stop system, if you press the start/Idling Stop button, the Idling Stop system will be cancelled.

Restart the engine with the start/Idling Stop button, referring to the starting procedure (▶ P. 126) for standard engine starting.

If the Idling Stop indicator flashes, but engine does not start even if the throttle is opened, perform the followings.

Battery lead is loose:

Check the battery terminals.

When the Honda SMART Key System Does Not Operate Properly

When the Honda SMART Key system does not work properly, perform the following.

- Check that the Honda SMART Key system is activated.
Lightly press the ON/OFF button on the Honda SMART Key.
If the Honda SMART Key LED does not blink 3 times, activate the Honda SMART Key system. 📄 P. 56
If the Honda SMART Key LED does not respond, replace the battery of the Honda SMART Key. 📄 P. 183
- Check that there is no communication failure in the Honda SMART Key system. The Honda SMART Key system uses low-intensity radio waves. The Honda SMART Key system may not work properly in the following conditions:
 - ▶ When there are facilities nearby that generate strong radio waves or noise such as TV towers, power stations, radio stations, or airports.
 - ▶ When you carry the Honda SMART Key with a laptop or wireless communication device such as a radio or mobile phone.

- ▶ When the Honda SMART Key comes into contact with or is covered by metal objects.

- Check that a registered Honda SMART Key is used.
Use a registered Honda SMART Key. The Honda SMART Key system cannot be activated without a registered Honda SMART Key.
- Make sure that you do not use a broken Honda SMART Key.
If you use a broken Honda SMART Key, the Honda SMART Key system cannot be activated. Bring the emergency key and ID tag to your dealer.
- Check the battery condition and battery lead in your vehicle.
Check the battery and battery terminals. If the battery is weak, contact your dealer.

If the Honda SMART Key system cannot be activated due to other causes, contact your dealer.

Activating the Electrical System in an Emergency

The electrical system can be activated by inputting the ID number.

Set to ID number input mode

1. Open the left and right saddlebags by the emergency procedures. **P. 200**
2. Press and hold the start button for more than 4 seconds.
 - ▶ The buzzer sounds and the system enters the ID number input mode.
3. Check the ID number on the ID tag.

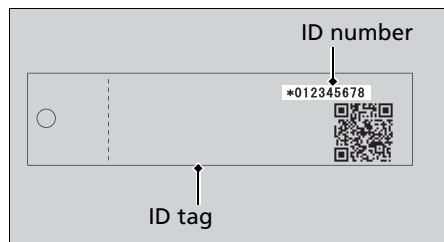

ID number input

You can input your ID number by pressing the fairing pocket opener and the start button. Input the ID number on the ID tag starting with the digit on the left by pressing the fairing pocket opener.

The ID number is input according to the number of times the fairing pocket opener is pressed.

Press the fairing pocket opener the desired number of times, then press the start button to fix the current digit (the buzzer sounds), and input the next digit, and then repeat until all the digits are input.

While inputting the ID number, if the button is not pressed for about 20 seconds, the inputted ID number is cancelled and the system returns to the state before ID number input (the buzzer sounds).

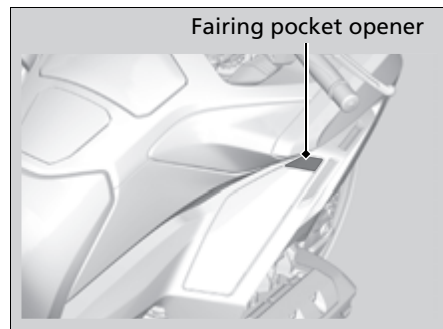

Example:

- To input "0", press the start button without pressing the fairing pocket opener, and then input next digit.



- To input "1", press the fairing pocket opener once, and then press the start button to input the next digit.

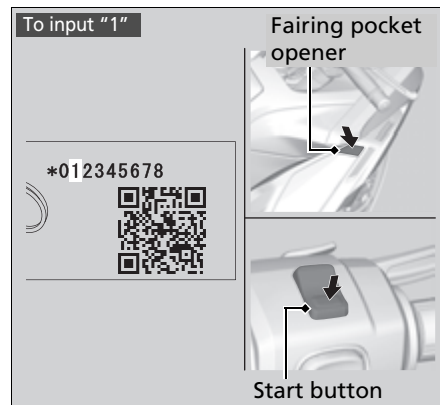

ID number input success:

After the last digit of the ID number is inputted and the start button is pressed, the ID number is authenticated. The steering will be unlocked (if it is locked) and the electrical system activated. You can start the engine.

You can turn off the engine and electrical system and also lock the steering using the ignition switch.

To activate the electrical system again, repeat the procedures for ID number input.

ID number input failure:

If the ID number is not authenticated after inputting, the steering cannot be unlocked and the electrical system will not activate.

Repeat the procedures for ID number input from the beginning.

ID number input cancel

If you input the wrong number, you can cancel ID number input by not pressing the button for about 20 seconds (the buzzer sounds).

Repeat the procedures for ID number input from the beginning.

If the Saddlebags or Travel Trunk Won't Open

The built-in key can be used to open the left saddle bag when the Honda SMART Key battery becomes weak.

If you lose the Honda SMART Key, the left saddlebag can be unlocked using the emergency key.  P. 216

To remove the built-in key, pull it out by pressing the release button on the Honda SMART Key.

To reinstall the built-in key, push the built-in key into the Honda SMART Key until it clicks.

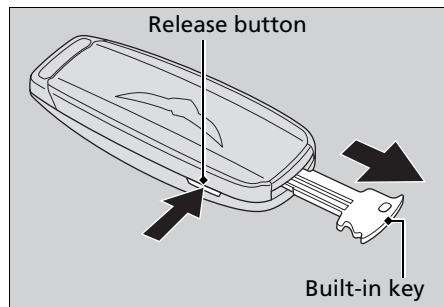

To Open the Saddlebags Emergency

1. Remove the rear center lid by using a flat head screwdriver covered with a protective cloth.

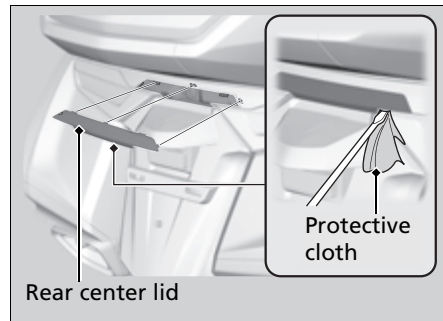

2. Remove the built-in key from the Honda SMART Key.

3. Insert the built-in key or emergency key in the left saddlebag opener and turn it clockwise to open the left saddlebag.

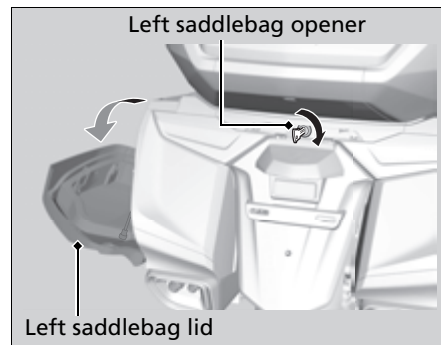

4. Release the right saddlebag opener from the prong in the left saddlebag. Pull the right saddlebag opener to open the right saddlebag.

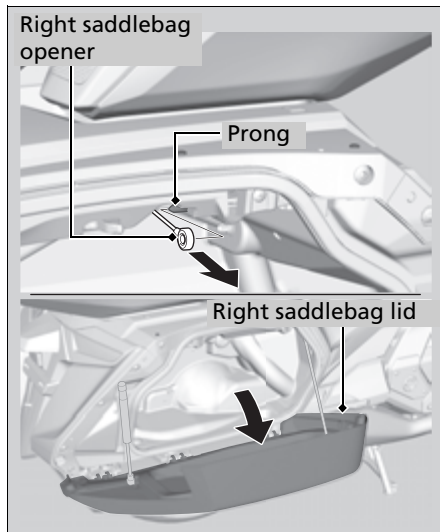

5. Install the right saddlebag opener onto the prong before closing the saddlebags.

To Open the Travel Trunk Emergency

GL1800/D/DA

1. Open the left and right saddlebags.
► P. 200
2. Release the travel trunk opener from the prong in the right saddlebag. Pull the travel trunk opener to open the travel trunk.

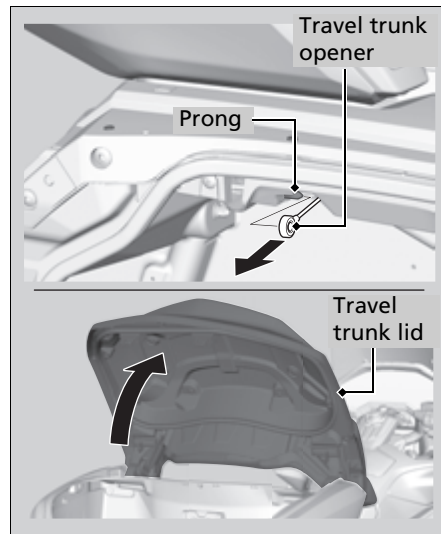

3. Install the travel trunk opener onto the prong before closing the right saddlebag.

Tire Puncture

Repairing a puncture or removing a wheel requires special tools and technical expertise.

We recommend you have this type of service performed by your dealer.

After an emergency repair, always have the tire inspected/replaced by your dealer.

Emergency Repair Using a Tire Repair Kit

If your tire has a minor puncture, you can make an emergency repair using a tubeless tire repair kit.

Follow the instructions provided with the emergency tire repair kit.

Riding your vehicle with a temporary tire repair is very risky. Do not exceed 30 mph (50 km/h). Have the tire replaced by your dealer as soon as possible.

NOTICE

Using a puncture-repairing agent can damage the TPMS sensors, causing the TPMS indicator to turn on. Have your vehicle checked by your dealer as soon as possible.

NOTICE

Use caution not to damage the TPMS sensor if an internal plug patch must be used to repair the tire. If you have a tire professionally repaired at a non-Honda facility, we recommend that you have the work checked by your dealer. TPMS wheels require special handling when changing the tire. Failure to follow the proper tire replacement procedure can result in damage to the TPMS sensor.

WARNING

Riding your vehicle with a temporary tire repair can be risky. If the temporary repair fails, you can crash and be seriously injured or killed.



If you must ride with a temporary tire repair, ride slowly and carefully and do not exceed 30 mph (50 km/h) until the tire is replaced.

Audio System Trouble





Symptom	Cause/remedy
Unable to pair <i>Bluetooth</i> ® device	Some <i>Bluetooth</i> ® devices and application software you use may be incompatible with the audio system and/or the operable functions may be limited.
	Check that the audio system and <i>Bluetooth</i> ® device are both in the pairing mode. ■ P. 85, 90
	The audio system may not be properly connected when another <i>Bluetooth</i> ® device is being paired at the same time. Check your surroundings to make sure no other device being paired is present before re-pairing. Presence of a <i>Bluetooth</i> ® device in the vicinity sometimes affects the pairing due to radio wave interference, etc.
	When connecting a <i>Bluetooth</i> ® device, make sure no other <i>Bluetooth</i> ® device readied for pairing is present. Presence of a <i>Bluetooth</i> ® device in the vicinity sometimes affects the pairing due to radio wave interference, etc.
	When you repeatedly fail in pairing, delete the paired device once, then try pairing again. ■ P. 85, 88
Unable to connect <i>Bluetooth</i> ® device	Depending on the <i>Bluetooth</i> ® device and application software you use, it may take some time for the audio system to connect to a device and to start playing an audio file.
	The connection may be temporarily disconnected when starting the engine, which is normal and not a malfunction. The <i>Bluetooth</i> ® device will be reconnected after the engine is started.
	Check that your <i>Bluetooth</i> ® device has been paired. Referring to the instruction manual of your <i>Bluetooth</i> ® device, check that your <i>Bluetooth</i> ® device is in connectable state.

Symptom	Cause/remedy
<p>Unable to connect <i>Bluetooth</i>® phone device</p>	<p>Some <i>Bluetooth</i>® devices and application software you use may not connect automatically. For connecting, follow the instructions in the instruction manual of your <i>Bluetooth</i>® device.</p> <p>The <i>Bluetooth</i>® devices that can be connected at the same time are limited to one <i>Bluetooth</i>® device and two <i>Bluetooth</i>® headsets.</p> <p>If the problem continues after the above-described inspection, delete the paired device once, then try pairing again. ➤ P. 85, 88, 90</p> <p>The <i>Bluetooth</i>® connection cannot be established while launching Apple CarPlay/Android Auto. Quit Apple CarPlay/Android Auto, then try pairing again. ➤ P. 85, 88</p> <p>While connected to Apple CarPlay/Android Auto, Bluetooth function is disabled.</p>
<p>Connected, but does not play.</p>	<p>Some <i>Bluetooth</i>® devices and application software you use may be incompatible with the audio system and/or audio files may not be played properly. Check the recommended specifications. ➤ P. 84</p> <p>Depending on the <i>Bluetooth</i>® device and application software you use, an audio file may not play automatically. For playing, follow the instructions in the instruction manual of your <i>Bluetooth</i>® device.</p> <p>Depending on the <i>Bluetooth</i>® device and application software you use, an audio file may not play normally after receiving a telephone call, etc. Check that your <i>Bluetooth</i>® device is in playable state.</p>
<p>Takes some time to start playing after turning the power on or changing the audio mode.</p>	<p>Right after the power is turned on or the audio mode is changed, the audio system may take some time to connect to an audio device and to start playing an audio file. Also, the audio system may not allow any audio control operation while preparing to play an audio file.</p>

Symptom	Cause/remedy
Sounds skip Noises mix	Presence of another <i>Bluetooth</i> ® device or a device that emits electromagnetic waves such as communication equipment in the vicinity sometimes affects the communication.
	Due to the characteristics of <i>Bluetooth</i> ®, though in rare cases, the system operation may become unstable. When it remains unstable, turn off the power to the audio system or the device being used, and then turn it on again.
	The storage location of the <i>Bluetooth</i> ® device sometimes affects the audio system and communication. When sounds skip or noises mix, change the location of the device. For example, when the device is kept in a pocket of clothing sandwiched in between the rider and passenger, the communication may be affected. For <i>Bluetooth</i> ® antenna locations, refer to Audio System Location. 📄 P. 68
	Also, weather, buildings in the vicinity, road conditions, etc. can sometimes affect the communication.
	Depending on the <i>Bluetooth</i> ® device and application software you use, an audio file may not play normally after receiving a telephone call, etc. Change the audio mode (📄 P. 71) or turn off the power to the audio system and then turn it on again. If the skipping of sounds or mixing of noises continues, check the status of your <i>Bluetooth</i> ® device.
	If the skipping of sounds or mixing of noises continues, delete the paired device once, then try pairing again. 📄 P. 85, 88
	Check the recommended specifications. 📄 P. 84 Noise sometimes mixes at the place where radio wave is weak.
Audio volume from headset is small/big.	Adjust the volume while in the individual modes. 📄 P. 71
	Check the volume setting of the paired headset.

Symptom	Cause/remedy
No or inaccurate display	Depending on the audio device and the audio file, nothing may be displayed or the display may be inaccurate in some cases. Check the information on available tags.  P. 105
	When the information in an audio file such as the artist name and track title is in a non-compliant tag format, it may be indicated by "." or no information will be shown.
	Depending on the type of the album art used for the music information of audio files, the album art may not be displayed. The system supports ID3v2 as available tag for album art. Check the album art format of the audio file.
	The system does not support album art display via <i>Bluetooth</i> [®] connection.
About USB device	Some USB devices may be incompatible with the audio system and/or their operable functions may be limited.
	When the audio system does not recognize the USB device connected to the USB connector, turn the ignition switch OFF and then turn it on again.
	When a large number of files are stored in the USB device, it sometimes takes a long time before an audio file starts playing. Reduce the number of files in the USB device.
	Check that the audio files stored in the USB device is in a playable file format.  P. 105
USB failure	USB function may be unusable when the system failure occurs. USB connection may recover by turning the ignition switch OFF, and then ON again.

Symptom	Cause/remedy
<i>Bluetooth</i> ® handsfree calling cannot be available.	Connected <i>Bluetooth</i> ® device may be unsupported device. Check the supported <i>Bluetooth</i> ® version/profiles. ➤ P. 84
	When the <i>Bluetooth</i> ® connection is unstable due to surrounding conditions or radio wave conditions, the handsfree calling functions may not be available.
	To use the <i>Bluetooth</i> ® handsfree calling, a headset connection is necessary. Connect a paired headset. ➤ P. 90
During a call, headset volume is small/big.	Adjust the volume during a call. ➤ P. 71
Passenger's headset is no sound.	If [Private mode] is enabled, no sound comes from the passenger's headset. Check [Private mode] setting. ➤ P. 92
About Phonebook	Since the phonebook is stored in the system, it may be displayed even when connecting another phone.
<i>Bluetooth</i> ® Handsfree Calling	Depending on the connection status, the times displayed in call history on the vehicle side or the phone side may differ.
	Depending on your mobile carrier plan, available functions may differ.
	A display delay may occur depending on the number of phone books, call history and music data etc. stored in the connected device.

Symptom	Cause/remedy
Apple CarPlay cannot be available.	Connected iPhone may be unsupported model. Check the compatible model with Apple CarPlay.  P. 111
	Connected iPhone may be unsupported iOS version. Update the iPhone to the newer version.
	To use Apple CarPlay, a headset connection is necessary. Connect a paired headset.  P. 90
	When connecting your iPhone, if it is recognized as iPod, disconnect the USB cable once, enable the Apple CarPlay ( P. 81), and then reconnect the USB cable again.
	When a mobile network communication is unstable due to surrounding conditions or signal strength conditions, Apple CarPlay functions may not be available.
	When the paired headset connection is broken due to headset battery depletion or communication failure, Apple CarPlay cannot be used until the connection is restored.
	The screen will not switch to Apple CarPlay automatically, other than when the ignition switch is turned to OFF with Apple CarPlay is activated.
	Apple CarPlay cannot be available with USB connection via the USB 2 connector. Check the USB connection, and then reconnect the USB 1 connector if necessary.
	Some USB cables may be incompatible with Apple CarPlay. Use certified cable to connect the iPhone.
	You have not agreed to enable Apple CarPlay. Reconnect the iPhone and enable to use CarPlay on the disclaimer screen.  P. 112
Apple CarPlay setting on your iPhone may be disabled. Disconnect iPhone and enable the Apple CarPlay setting on your iPhone.	

Symptom	Cause/remedy
Android Auto cannot be available.	Connected Android phone may be unsupported model. Check the compatible model with Android Auto. ➤ P. 114
	Connected Android phone may be unsupported Android version. Update the Android phone to the newer version.
	To use Android Auto, a headset connection is necessary. Connect a paired headset. ➤ P. 90
	When a mobile network communication is unstable due to surrounding conditions or signal strength conditions, Android Auto functions may not be available.
	When the paired headset connection is broken due to headset battery depletion or communication failure, go back to the Home screen, and pair the headset connection again. ➤ P. 90
	Android Auto cannot be available with USB connection via the USB 2 connector. Check the USB connection, and then reconnect the USB 1 connector if necessary.
	Some USB cables may be incompatible with Android Auto. For Android Auto, the USB cables should be certified by USB-IF to be compliant with USB 2.0 Standard.
	You have not agreed to enable Android Auto. Reconnect the Android phone and enable to use Android Auto on the disclaimer screen. ➤ P. 115
Android Auto setting on your Android phone may be disabled. Disconnect Android phone and enable the Android Auto setting on your Android phone.	

Audio System Trouble

Symptom	Cause/remedy
Connected, but does not operate Apple CarPlay/Android Auto.	You cannot operate Apple CarPlay/Android Auto by the center panel switches/Interface dial while the vehicle is in motion. Operate with the left handlebar switches or park your vehicle in a safe place, then operate.
Some functions of Apple CarPlay/Android Auto is not available.	Some functions may be limited due to condition of mobile network communication.
Apple CarPlay/Android Auto screen is too dark/bright	Selecting [Day / Night] menu in [Vehicle setting], you can select daytime mode or nighttime mode in the navigation map or an application such as Maps (▶ P. 32), also adjust backlight brightness by [Auto dimmer meter illumination] menu in [Vehicle setting] (▶ P. 31).
The multi-function display is too dark/bright	When the ignition switch is in the ACC, [Auto Dimmer Meter Illumination] function does not work. Turn the ignition switch to ON. The map color tone has Day/Night color tones and it changes according to the surrounding brightness. You can select daytime mode or nighttime mode. ▶ P. 32

Symptom	Cause/remedy
Audio system cannot operate.	Certain manual functions and settings are disabled or inoperable while the vehicle is in motion. You cannot select a grayed-out menu until the vehicle is stopped.
Set menu in [Vehicle setting] does not be reflected or inoperable.	In [Vehicle setting], certain items cannot be selected and display information is limited when the ignition switch is in ACC. The set menu will be reflected to the previous setting when the ignition switch is turned ON.
When turning the ignition switch OFF and ON continuously.	Since the system restart takes time, it may take time until the screen is appeared.
High temperature/overcurrent protection	To protect the system, some operations may be limited temporarily. The system automatically recovers after the cause is solved.
About Idling Stop system (GL1800D/DA Canada model)	When the Idling Stop system is activated, sound may not come out temporarily for system protection, but sound will recover automatically.
Radio receiver sensitivity	The sensitivity of receiver is affected by the object which interrupts a radio wave nearby the radio antenna (top of the right saddlebag).
Software update	The statements in this owner's manual may not match your vehicle's Audio System after performing the software update (map data update).

If the problem continues after the above-described inspection, have your vehicle inspected by your dealer.

Battery Goes Dead

Charge the battery using a motorcycle battery charger. Remove the battery from the vehicle before charging.

Do not use an automobile-type battery charger, as these can overheat a motorcycle battery and cause permanent damage.

If the battery does not recover after recharging, contact your dealer.

NOTICE

Jump starting using an automobile battery is not recommended, as this can damage your vehicle's electrical system.
Bump starting is also not recommended.

Burned-out Light Bulb

All light bulbs on the vehicle are LEDs. If there is an LED which is not turned on, see your dealer for servicing.

Blown Fuse

Before handling fuses, see "Inspecting and Replacing Fuses." P. 162

Fuse Box Fuses

1. Remove the left side cover. P. 170
2. Remove the fuse box cover.
3. Pull the fuses out one by one with the fuse puller and check for a blown fuse. Always replace a blown fuse with a spare fuse of the same rating.
 - ▶ Spare fuses and fuse puller are provided on back side of the fuse cover.
4. Install the parts in the reverse order of removal.

Main Fuse B, Speed Limiter Fuse and External Amplifier Fuse

To check and replace the main fuse B, speed limiter fuse and external amplifier fuse, see your dealer for servicing.

GL1800D/DA USA model

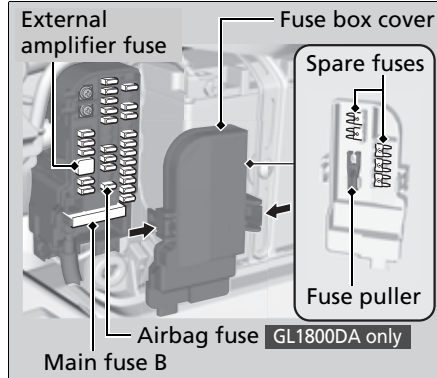

GL1800D/DA Canada model

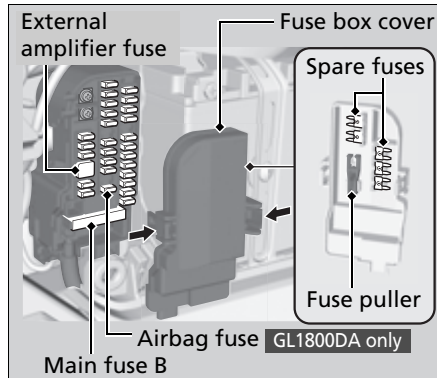

GL1800BD USA model

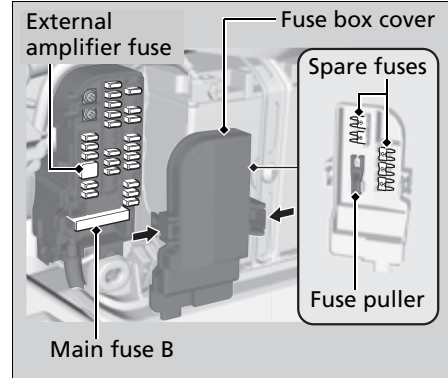

GL1800BD Canada model

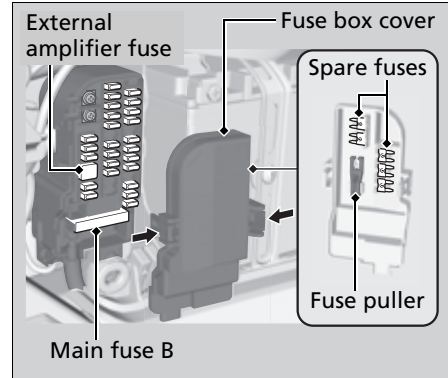

GL1800

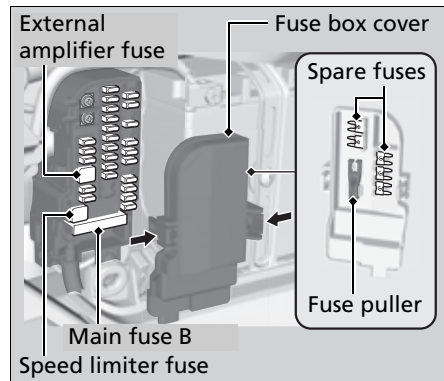

GL1800B

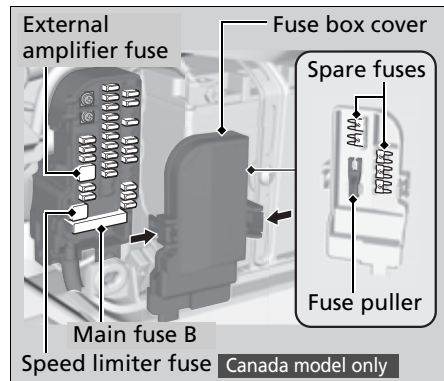

Ignition Main Fuse & ACC Main Fuse

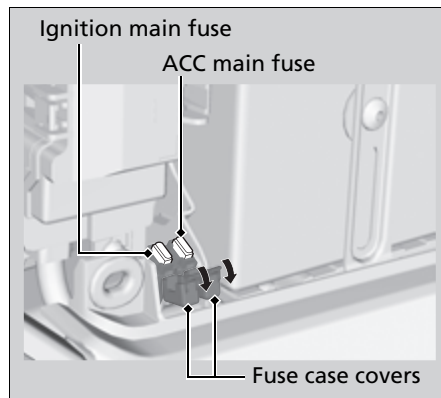

NOTICE

If a fuse fails repeatedly, you likely have an electrical problem. Have your vehicle inspected by your dealer.

1. Remove the left side cover. ► P. 170
2. Remove the fuse case covers.
3. Pull the fuses out one by one with the fuse puller and check for a blown fuse. Always replace a blown fuse with a spare fuse of the same rating.
 - Spare fuses and fuse puller are provided on back side of the fuse box cover.
4. Install the parts in the reverse order of removal.

Information

Keys	P. 216	Catalytic Converter	P. 235
Instruments, Controls, & Other Features	P. 218	Oxygenated Fuels	P. 236
Legal Information on Apple CarPlay/ Android Auto	P. 222	Authorized Manuals	P. 237
Caring for Your Vehicle	P. 224	Warranty Coverage and Service	P. 238
Storing Your Vehicle	P. 227	Honda Contacts	P. 240
Transporting Your Vehicle	P. 228	Customer Support	P. 241
You & the Environment	P. 229	Reporting Safety Defects	P. 242
Vehicle Identification Number	P. 230		
Tire Pressure Monitoring System (TPMS) Explanation	P. 231		
Emission Control Systems	P. 232		

Keys

Emergency Key

This vehicle has emergency key, built-in key and a key tag with a key number. Store the emergency key and key tag in a safe location.

Normally, the built-in key should be stored in the Honda SMART Key. **P. 200**

To make a duplicate key, take the key and key tag to your dealer or a locksmith.

The emergency key and built-in key are used to unlock the left saddle bag in an emergency. **P. 200**

Do not store the emergency key in the saddlebags, fairing pocket, travel trunk

GL1800/D/DA or shelter case **Except GL1800DA**.

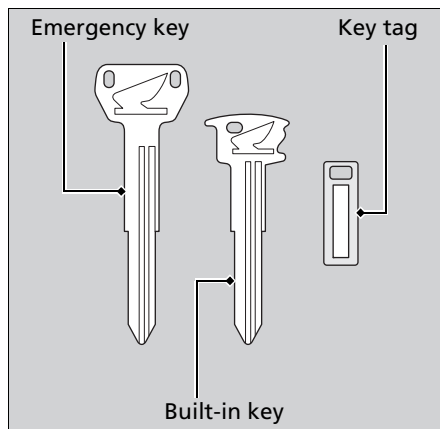

Honda SMART Key

Carrying the Honda SMART Key allows you to perform the following operations:

- Locking or unlocking the steering and activating or deactivating the electrical system
- Releasing the left and right saddlebags and travel trunk
- Releasing the fairing pocket

The ID number of the Honda SMART Key is on the ID tag. You can also unlock the steering (if it is locked) and activate the electrical system by inputting the ID number.

Always carry both the emergency key and ID tag, but separate from the Honda SMART Key, to avoid losing all of them at the same time.

Also store a copy of your ID number in a safe place other than your vehicle.

The Honda SMART Key contains electronic circuits. If the circuits are damaged, the Honda SMART Key will not allow you to perform any operations.

- Do not drop the Honda SMART Key or set heavy objects on them.
- Protect the Honda SMART Key from direct sunlight, high temperature, and high humidity.
- Do not scratch or puncture.
- Do not store near any magnetized products such as a magnetized key chain.
- Always keep the Honda SMART Key away from electric appliances such as a TV, radio, PC or low-frequency massage device.
- Keep the Honda SMART Key away from liquids. If it gets wet, dry it immediately with a soft cloth.
- Keep the Honda SMART Key away from the vehicle while washing the vehicle.
- Do not burn.
- Do not wash in an ultrasonic cleaner.

- If fuel, wax, or grease adhere to the Honda SMART Key, wipe it off immediately to avoid cracking or warping.
- Do not disassemble the Honda SMART Key other than when changing a battery. Only the case of the Honda SMART Key can be disassembled. Do not disassemble other parts.
- Do not lose your Honda SMART Key. If you lose it, you will need to register a new Honda SMART Key. See your dealer with your emergency key and ID tag for registration.

The battery in the Honda SMART Key system normally lasts about 2 years.

To get add additional Honda SMART Key, take the Honda SMART Key and the vehicle to your dealer.

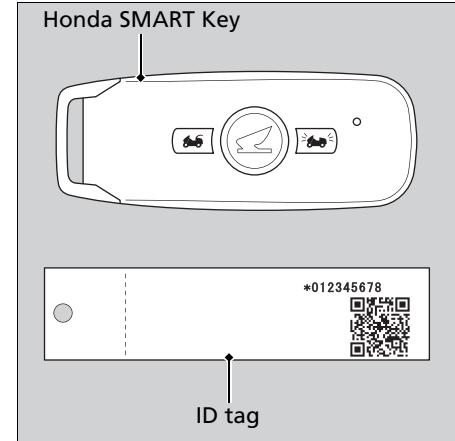

Instruments, Controls, & Other Features

Ignition Switch

Leaving the ignition switch in ON or ACC with the engine stopped will drain the battery.

Do not turn the ignition switch while riding.

Engine Stop Switch

Do not use the engine stop switch except in an emergency. Doing so when riding will cause the engine to suddenly turn off, making riding unsafe.

If you stop the engine using the engine stop switch, turn the ignition switch OFF. Failing to do so will drain the battery.

Odometer

The display locks at 999,999 when it exceeds 999,999.

Tripmeter

Each tripmeter returns to 0.0 when it exceeds 9,999.9.

Owner's Manual

The owner's manual, Navigation System manual, registration and insurance information can be stored in the left saddlebag.

Ignition Cut-off System

A banking (lean angle) sensor automatically stops the engine and fuel pump if the vehicle falls over. To reset the sensor, you must turn the ignition switch to OFF and back to ON before the engine can be restarted.

Throttle by Wire System

This model is equipped with a Throttle by Wire System.

Do not put magnetized items or items susceptible to magnetic interference near the right handlebar switches.

Automatic Brightness Control

The backlight brightness of the meter will be controlled automatically when "AUTO" is selected on the brightness setting.

Ambient brightness is detected by the photosensor.

Do not damage or cover the photosensor. Otherwise, the automatic brightness control may not work properly.

Photosensor

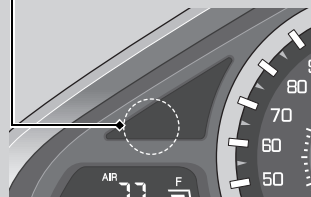

Audio System

The audio systems on your vehicle emit radio waves when in operation.

USA

This device complies with Part 15 of the FCC Rules. Operation is subject to the following two conditions:

- (1) this device may not cause harmful interference, and*
- (2) this device must accept any interference received, including interference that may cause undesired operation.*

FCC CAUTION:

Changes or modifications not expressly approved by the party responsible for compliance could void the user's authority to operate the equipment.

This equipment complies with FCC's RF radiation exposure limits set forth for an uncontrolled environment. The antenna(s) used for this transmitter must be installed and operated to provide a separation distance of at least 20 cm from all persons and must not be collocated or operating in

conjunction with any other antenna or transmitter. Installers must ensure that 20 cm separation distance will be maintained between the device (excluding its handset) and users.

Canada

This Class B digital apparatus complies with Canadian ICES-003.

This device complies with Industry Canada's licence-exempt RSSs. Operation is subject to the following two conditions:

- (1) This device may not cause interference, and*
- (2) This device must accept any interference, including interference that may cause undesired operation of the device.*

This radio transmitter (12339A-MKCAU) has been approved by Industry Canada to operate with the antenna types with the maximum permissible gain indicated in test report.

Antenna types not included in the report, having a gain greater than the maximum gain indicated for that type, are strictly prohibited for use with this device.

Mexico

La operación de este equipo está sujeta a las siguientes dos condiciones:

- (1) es posible que este equipo o dispositivo no cause interferencia perjudicial y*
- (2) este equipo o dispositivo debe aceptar cualquier interferencia, incluyendo la que pueda causar su operación no deseada.*

Honda SMART Key System

The Honda SMART Key system on your vehicle emit radio waves when in operation.

USA

FCC CAUTION:

Changes or modifications not expressly approved by the party responsible for compliance could void the user's authority to operate the equipment.

This device complies with part 15 of the FCC Rules. Operation is subject to the following two conditions: (1) This device may not cause harmful interference, and (2) this device must accept any interference received, including interference that may cause undesired operation.

Mexico

<GHR-H014-R>

IFETEL RLVOMGH17-1178

<GHR-H014-T>

IFETEL RLVOMGH17-1178

Canada

This device complies with Industry Canada's applicable licence-exempt RSSs.

Operation is subject to the following two conditions:

- (1) This device may not cause interference;
- and
- (2) This device must accept any interference, including interference that may cause undesired operation of the device.

Tire Pressure Monitoring System (TPMS)

Your vehicle is equipped with a tire pressure monitoring system (TPMS) that turns on every time you start to ride the vehicle and it monitors the pressure in your tires while riding.

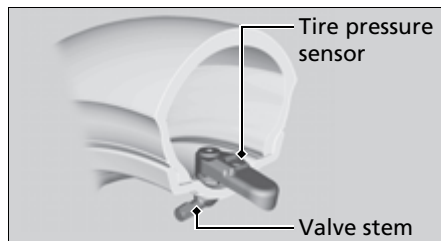

Each tire has its own pressure sensor. If the air pressure of a tire becomes significantly low while riding, the sensor in that tire sends a signal that causes the low tire pressure indicator to turn on.

Modifying the TPMS on your vehicle could make the systems ineffective.

The Tire Pressure Monitoring System (TPMS) on your vehicle emit radio waves when in operation.

USA

As required by the FCC:

This device complies with Part 15 of the FCC rules. Operation is subject to the following two conditions: (1) This device may not cause harmful interference, and (2) this device must accept any interference received, including interference that may cause undesired operation.

FCC CAUTION:

Changes or modifications not expressly approved by the party responsible for compliance could void the user's authority to operate the equipment.

Canada

This device complies with Industry Canada licence-exempt RSS standard(s). Operation is subject to the following two conditions: (1) this device may not cause interference, and (2) this device must accept any interference, including interference that may cause undesired operation of the device.

Assist-slipper Clutch System**GL1800/B**

The assist-slipper clutch system helps to prevent the rear tire from locking up when the deceleration of your vehicle produces a strong engine braking effect. It also makes the clutch lever operation feel lighter.

Use only MA classification engine oil for your vehicle. Using engine oil other than MA classification oil could result in damage to the assist-slipper clutch system.

Airbag System**GL1800DA****Event Data Recorders**

Your vehicle is equipped with one or more devices commonly referred to as event data recorders.

These devices record airbag deployment data, and the failure of any airbag system component.

This data belongs to the vehicle owner and may not be accessed by anyone else except as legally required or with the permission of the vehicle owner.

Legal Information on Apple CarPlay/Android Auto

OWNER'S MANUAL LICENSE/LIABILITY STATEMENTS

USE OF APPLE CARPLAY IS SUBJECT TO YOUR AGREEMENT TO THE CARPLAY TERMS OF USE, WHICH ARE INCLUDED AS PART OF THE APPLE iOS TERMS OF USE. IN SUMMARY, THE CARPLAY TERMS OF USE DISCLAIM APPLE AND ITS SERVICE PROVIDERS' LIABILITY IF THE SERVICES FAIL TO PERFORM CORRECTLY OR ARE DISCONTINUED, STRICTLY LIMIT APPLE AND ITS SERVICE PROVIDERS' OTHER LIABILITIES, DESCRIBE THE KINDS OF USER INFORMATION (INCLUDING, FOR EXAMPLE, VEHICLE LOCATION, VEHICLE SPEED, AND VEHICLE STATUS) BEING GATHERED AND STORED BY APPLE AND ITS SERVICE PROVIDERS, AND DISCLOSE CERTAIN POSSIBLE RISKS ASSOCIATED WITH THE USE OF CARPLAY, INCLUDING THE POTENTIAL FOR DRIVER DISTRACTION. SEE APPLE'S PRIVACY POLICY FOR DETAILS REGARDING APPLE'S USE AND HANDLING OF DATA UPLOADED BY CARPLAY.

USE OF ANDROID AUTO IS SUBJECT TO YOUR AGREEMENT TO THE ANDROID AUTO TERMS OF USE WHICH MUST BE AGREED TO WHEN THE ANDROID AUTO APPLICATION IS DOWNLOADED TO YOUR ANDROID PHONE. IN SUMMARY, THE ANDROID AUTO TERMS OF USE DISCLAIM GOOGLE AND ITS SERVICE PROVIDERS' LIABILITY IF THE SERVICES FAIL TO PERFORM CORRECTLY OR ARE DISCONTINUED, STRICTLY LIMIT GOOGLE AND ITS SERVICE PROVIDERS' OTHER LIABILITIES, DESCRIBE THE KINDS OF USER INFORMATION (INCLUDING, FOR EXAMPLE, VEHICLE LOCATION, VEHICLE SPEED, AND VEHICLE STATUS) BEING GATHERED AND STORED BY GOOGLE AND ITS SERVICE PROVIDERS, AND DISCLOSE CERTAIN POSSIBLE RISKS ASSOCIATED WITH THE USE OF ANDROID AUTO, INCLUDING THE POTENTIAL FOR DRIVER DISTRACTION. SEE GOOGLE'S PRIVACY POLICY FOR DETAILS REGARDING GOOGLE'S USE AND HANDLING OF DATA UPLOADED BY ANDROID AUTO.

DISCLAIMER OF WARRANTIES; LIMITATION ON LIABILITY

YOU EXPRESSLY ACKNOWLEDGE AND AGREE THAT USE OF APPLE CARPLAY OR ANDROID AUTO ("THE APPLICATIONS") IS AT YOUR SOLE RISK AND THAT THE ENTIRE RISK AS TO SATISFACTORY QUALITY, PERFORMANCE, ACCURACY AND EFFORT IS WITH YOU TO THE MAXIMUM EXTENT PERMITTED BY APPLICABLE LAW, AND THAT THE APPLICATIONS AND INFORMATION ON THE APPLICATIONS IS PROVIDED "AS IS" AND "AS AVAILABLE," WITH ALL FAULTS AND WITHOUT WARRANTY OF ANY KIND, AND HONDA HEREBY DISCLAIMS ALL WARRANTIES AND CONDITIONS WITH RESPECT TO THE APPLICATIONS AND INFORMATION ON THE APPLICATIONS, EITHER EXPRESS, IMPLIED OR STATUTORY, INCLUDING, BUT NOT LIMITED TO, THE IMPLIED WARRANTIES AND/OR CONDITIONS OF MERCHANTABILITY, SATISFACTORY QUALITY, FITNESS FOR A PARTICULAR PURPOSE, ACCURACY, QUIET ENJOYMENT, AND NONINFRINGEMENT OF THIRD PARTY RIGHTS. NO ORAL OR

WRITTEN INFORMATION OR ADVICE GIVEN BY HONDA OR AN AUTHORIZED REPRESENTATIVE SHALL CREATE A WARRANTY. AS EXAMPLES, AND WITHOUT LIMITATION, HONDA DISCLAIMS ANY WARRANTY REGARDING THE ACCURACY OF DATA PROVIDED BY THE APPLICATIONS, SUCH AS THE ACCURACY OF DIRECTIONS, ESTIMATED TRAVEL TIME, SPEED LIMITS, ROAD CONDITIONS, NEWS, WEATHER, TRAFFIC, OR OTHER CONTENT PROVIDED BY APPLE, GOOGLE, THEIR AFFILIATES, OR THIRD PARTY PROVIDERS; HONDA DOES NOT GUARANTEE AGAINST LOSS OF APPLICATION DATA, WHICH MAY BE LOST AT ANY TIME; HONDA DOES NOT GUARANTEE THAT THE APPLICATIONS OR ANY SERVICES PROVIDED THROUGH THEM WILL BE PROVIDED AT ALL TIMES OR THAT ANY OR ALL SERVICES WILL BE AVAILABLE AT ANY PARTICULAR TIME OR LOCATION. FOR EXAMPLE, SERVICES MAY BE SUSPENDED OR INTERRUPTED WITHOUT NOTICE FOR REPAIR, MAINTENANCE, SECURITY FIXES, UPDATES, ETC., SERVICES MAY BE

UNAVAILABLE IN YOUR AREA OR LOCATION, ETC. IN ADDITION, YOU UNDERSTAND THAT CHANGES IN THIRD PARTY TECHNOLOGY OR GOVERNMENT REGULATION MAY RENDER THE SERVICES AND/OR APPLICATIONS OBSOLETE AND/ OR UNUSABLE.

TO THE EXTENT NOT PROHIBITED BY LAW, IN NO EVENT SHALL HONDA OR ITS AFFILIATES BE LIABLE FOR PERSONAL INJURY, OR ANY INCIDENTAL, SPECIAL, INDIRECT OR CONSEQUENTIAL DAMAGES WHATSOEVER, INCLUDING, WITHOUT LIMITATION, DAMAGES FOR LOSS OF PROFITS, CORRUPTION OR LOSS OF DATA, FAILURE TO TRANSMIT OR RECEIVE ANY DATA, BUSINESS INTERRUPTION OR ANY OTHER COMMERCIAL DAMAGES OR LOSSES, ARISING OUT OF OR RELATED TO THE APPLICATIONS OR YOUR USE OF OR INABILITY TO USE THE APPLICATIONS OR INFORMATION ON THE APPLICATIONS, HOWEVER CAUSED, REGARDLESS OF THE THEORY OF LIABILITY (CONTRACT, TORT OR OTHERWISE) AND EVEN IF HONDA WERE ADVISED OF THE POSSIBILITY OF

SUCH DAMAGES. SOME STATES AND JURISDICTIONS DISALLOW THE EXCLUSION OR LIMITATION OF LIABILITY FOR DAMAGES, SO THESE LIMITATIONS AND EXCLUSIONS MAY NOT APPLY TO YOU. IN NO EVENT SHALL HONDA'S TOTAL LIABILITY TO YOU FOR ALL DAMAGES (OTHER THAN AS MAY BE REQUIRED BY APPLICABLE LAW IN CASES INVOLVING PERSONAL INJURY) EXCEED THE AMOUNT OF FIVE DOLLARS (\$5.00). THE FOREGOING LIMITATIONS WILL APPLY EVEN IF THE ABOVE STATED REMEDY FAILS OF ITS ESSENTIAL PURPOSE.

Caring for Your Vehicle

Frequent cleaning and polishing is important to ensure the life of your Honda. A clean vehicle makes it easier to spot potential problems.

In particular, seawater and salts used to prevent ice on roads promote the formation of corrosion. Always wash your vehicle thoroughly after riding on coastal or treated roads.

Washing

Allow the engine, muffler, brakes, and other high-temperature parts to cool before washing.

1. Rinse your vehicle thoroughly using a low pressure garden hose to remove loose dirt.
2. If necessary, use a sponge or a soft towel with mild cleaner to remove road grime.
 - ▶ Clean the windshield, headlight lens, panels, and other plastic components with extra care to avoid scratching them. Avoid directing water into the air cleaner, muffler, and electrical parts.

3. Thoroughly rinse your vehicle with plenty of clean water and dry with a soft, clean cloth.
4. After the vehicle dries, lubricate any moving parts.
 - ▶ Make sure that no lubricant spills onto the brakes or tires. Brake discs, pads, drum or shoes contaminated with oil will suffer greatly reduced braking effectiveness and can lead to a crash.
5. Apply a coat of wax to prevent corrosion.
 - ▶ Avoid products that contain harsh detergents or chemical solvents. These can damage the metal, paint, and plastic on your vehicle. Keep the wax clear of the tires and brakes.
 - ▶ If your vehicle has any matte painted parts, do not apply a coat of wax to the matte painted surface.

Washing Precautions

Follow these guidelines when washing:

- Do not use high-pressure washers:
 - ▶ High-pressure water cleaners can damage moving parts and electrical parts, rendering them inoperable.
 - ▶ Water in the air intake can be drawn into the throttle body and/or enter the air cleaner.
- Do not direct water at the muffler:
 - ▶ Water in the muffler can prevent starting and causes rust in the muffler.
- Dry the brakes:
 - ▶ Water adversely affects braking effectiveness. After washing, apply the brakes intermittently at low speed to help dry them.
- Do not direct water in the left saddlebag:
 - ▶ Water in the left saddlebag can damage your documents and other belongings.
- Do not direct water at the air cleaner:
 - ▶ Water in the air cleaner can prevent the engine from starting.

- Do not direct water near the headlight.
 - ▶ The headlight's inside lens may fog temporarily after washing or while riding in the rain. This does not impact the headlight function. However, if you see a large amount of water or ice accumulated inside the lens(es), have your vehicle inspected by your dealer.
- Do not use wax or polishing compounds on matte painted surfaces:
 - ▶ Use a soft cloth or sponge, plenty of water, and a mild detergent to clean matte painted surfaces. Dry with a soft clean cloth.

Aluminum Components

Aluminum will corrode from contact with dirt, mud, or road salt. Clean aluminum parts regularly and follow these guidelines to avoid scratches:

- Do not use stiff brushes, steel wool, or cleaners containing abrasives.
- Avoid riding over or scraping against curbs.

Panels

Follow these guidelines to prevent scratches and blemishes:

- Wash gently using a soft sponge and plenty of water.
- To remove stubborn stains, use diluted detergent and rinse thoroughly with plenty of water.
- Avoid getting gasoline, brake fluid, or detergents on the instruments, panels, or headlight.

Windscreen

Keep the windscreen raised after turning off the electrical system to make it easy to clean. 📖 P. 150

Using plenty of water, clean the windscreen with a soft cloth or sponge. (Avoid using detergents or any kind of chemical cleaner on the windscreen.) Dry with a soft, clean cloth.

NOTICE

To avoid possible scratching or other damage, use only water and a soft cloth or sponge to clean the windscreen.

For a dirtier windscreen, use a diluted neutral detergent with a sponge and plenty of water. Make sure to wash off all the detergent. (Detergent residue may cause windscreen cracks.)

Replace the windscreen if scratches cannot be removed and they obstruct clear vision.

Take care to keep battery electrolyte, brake fluid, or other chemical solvents off the windscreen and screen garnish. They will damage the plastic.

Instrument Panel

The instrument panel is coated with a special surface treatment to prevent reflection and glare.

Wipe any moisture (including rainwater) on the instrument panel with a dry, soft cloth immediately.

Using plenty of water, clean the instrument panel with a soft cloth or sponge.

For a dirtier instrument panel, use a diluted neutral detergent with a sponge and plenty of water. Make sure to wash off all the detergent. Dry with a soft, clean cloth.

Take care to keep battery electrolyte, brake fluid, or other chemical solvents off the instrument panel. They will damage the special surface treatment of the instrument panel.

Exhaust Pipe and Muffler

The exhaust pipe and muffler are stainless steel but may become stained by mud or dust.

To remove mud or dust, use a wet sponge and a liquid kitchen abrasive, then rinse well with clean water. Dry with chamois or a soft towel.

If necessary, remove heat stains by using a commercially available fine texture compound. Then, rinse by the same manner as removing mud or dust.

When the exhaust pipe and muffler are painted, do not use a commercially available abrasive kitchen cleaning compound. Use a neutral detergent to clean the painted surface on the exhaust pipe and muffler. If you are not sure if your exhaust pipe and muffler are painted, contact your dealer.

NOTICE

Even though the exhaust is made of stainless steel, it can become stained. Remove all marks and blemishes as soon as they are noticed.

Storing Your Vehicle

If you store your vehicle outdoors, you should consider using a full-body cover.

If you won't be riding for an extended period, follow these guidelines:

- Wash your vehicle and wax all painted surfaces (except matte painted surfaces). Coat chrome pieces with rust-inhibiting oil.

- **GL1800/D/DA**

Place your vehicle on its center stand and position a block so that both tires are off the ground.

- **GL1800B/BD**

Place your vehicle on a maintenance stand and position a block so that both tires are off the ground.

- After rain, remove the body cover and allow the vehicle to dry.
- Remove the battery (▶ P. 167) to prevent discharge. Charge the battery in a shaded, well-ventilated area.
 - ▶ If you leave the battery in place, disconnect the negative ⊖ terminal to prevent discharge.

After removing your vehicle from storage, inspect all maintenance items required by the Maintenance Schedule.

USA For more information about storage, refer to the *Honda Winter Storage Guide*, available from your dealer.

Canada For more information about storage, visit our website at www.honda.ca and look up "Storage Tips" under the "Honda Warranty" in the Warranty tab for your Model.

Transporting Your Vehicle

If your vehicle needs to be transported, it should be carried on a motorcycle trailer or a flatbed truck or trailer that has a loading ramp or lifting platform, and motorcycle tie-down straps. Never try to tow your vehicle with a wheel or wheels on the ground.

NOTICE

- Towing your vehicle with a wheel or wheels on the ground can cause serious damage to the transmission.
- When tying down the vehicle for transportation, do not use tie-downs or straps on the handlebars or handgrips. Doing so may cause damage to the steering system, heated grips and/or handlebar switches.

Tie-down Method

1. Remove both sides of the cylinder head side covers. ➤ P. 168
2. Secure the vehicle using a buckle or ratchet style tie-down strap to the engine guards and affix the other ends to an anchor point.
 - ▶ Make sure the tie-downs straps are tight and the vehicle is secure.

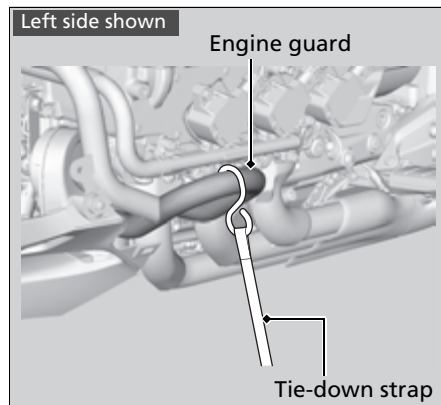

3. Remove both left and right saddlebag guard covers by removing the clips to expose the saddlebag guards.
4. Secure the vehicle using a buckle or ratchet style tie-down strap to the saddlebag guards and affix the other ends to an anchor point.
 - ▶ Make sure the tie-downs straps are tight and the vehicle is secure.

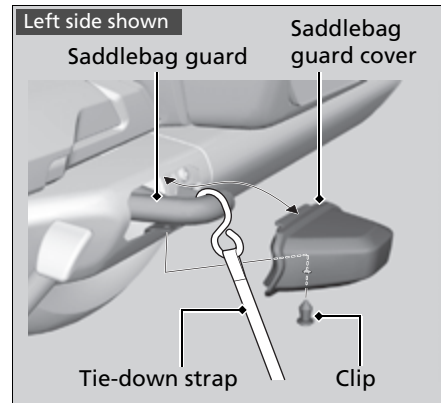

You & the Environment

Owning and riding a vehicle can be enjoyable, but you must do your part to protect the environment.

Choose Sensible Cleaners

Use a biodegradable detergent when you wash your vehicle. Avoid aerosol spray cleaners that contain chlorofluorocarbons (CFCs) which damage the atmosphere's protective ozone layer.

Recycle Wastes

Put oil and other toxic wastes in approved containers and take them to a recycling center.

Call your local or state office of public works or environmental services to find a recycling center in your area and to get instructions on how to dispose of non-recyclable wastes. Do not place used engine oil in the trash or pour it down a drain or on the ground. Used oil, gasoline, coolant, and cleaning solvents contain poisons that can hurt refuse workers and contaminate drinking water, lakes, rivers, and oceans.

Vehicle Identification Number

The VIN and engine serial number uniquely identify your vehicle and are required in order to register your vehicle. They may also be required when ordering replacement parts.

To check the VIN, remove the cover by releasing the clip.

You should record these numbers and keep them in a safe place.

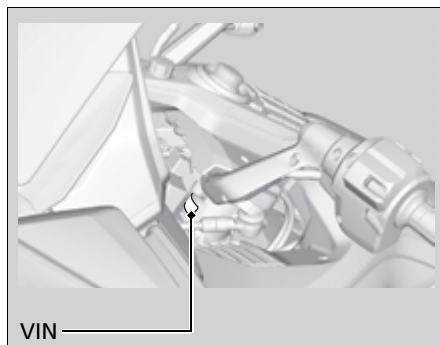
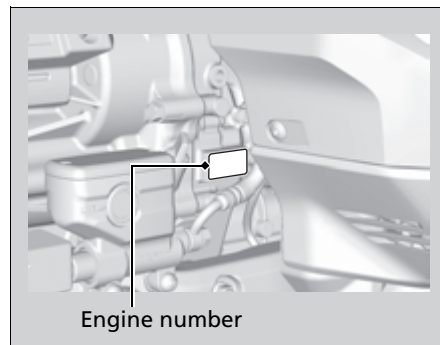
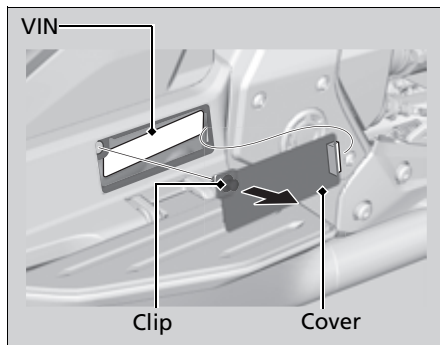

Tire Pressure Monitoring System (TPMS) Explanation

Both tires should be checked monthly when cold, and inflated to the inflation pressure recommended by the vehicle manufacturer on the tire information label.

(If your vehicle has different tires than those indicated on the vehicle tire information label, you should determine the proper tire inflation pressure for those tires.)

As an added safety feature, your vehicle has been equipped with a tire pressure monitoring system (TPMS) that illuminates a low tire pressure indicator when one or more of your tires significantly under-inflated.

Accordingly, when the low tire pressure indicator illuminates, you should stop and check your tires as soon as possible, and inflate them to the proper pressure.

Riding on a significantly under-inflated tire causes the tire to overheat and can lead to tire failure. Under-inflation also reduces

fuel efficiency and tire tread life, and may affect the vehicle's handling and stopping ability.

Please note that the TPMS is not a substitute for proper tire maintenance, and it is the rider's responsibility to maintain correct tire pressure, even if under-inflation has not reached the level to trigger illumination of the low tire pressure indicator.

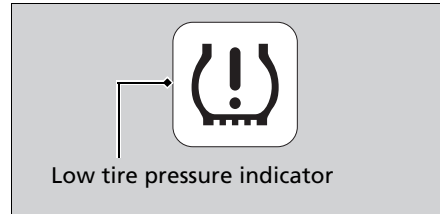

Your vehicle has also been equipped with a TPMS indicator to indicate when the system is not operating properly. The TPMS indicator displays the symbol "TPMS" when illuminated.

When the TPMS indicator is illuminated, the system may not be able to detect or

signal low tire pressure as intended.

TPMS malfunctions may occur for a variety of reasons, including the installation of replacement or alternate tires or wheels on the vehicle that prevent the TPMS from functioning properly.

Always check the TPMS indicator after replacing one or more tires or wheels on your vehicle to ensure that the replacement or alternate tires and wheels allow the TPMS to continue to function properly.

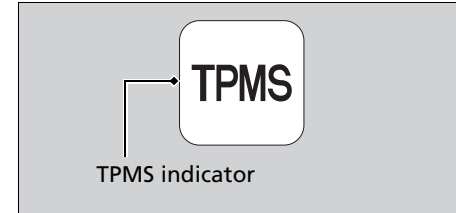

Emission Control Systems

Your vehicle engine emits combustion by-products, including carbon monoxide (CO), oxides of nitrogen (NOx), and hydrocarbons (HC). Gasoline evaporation also emits hydrocarbons. Controlling the production of NOx, CO, and HC is important for the environment.

Exhaust Emission Requirements

The U.S. Environmental Protection Agency (EPA), the California Air Resources Board (CARB), and Environment and Climate Change Canada (ECCC) require that your vehicle comply with applicable exhaust, crankcase, and fuel permeation emission standards during its useful life, when operated and maintained according to the instructions provided.

CARB also requires that your vehicle comply with applicable evaporative emission requirements during its useful life, when operated and maintained according to the instructions provided.

USA Compliance with the terms of the Distributor's Warranties for Honda Motorcycle Emission Control Systems is necessary in order to maintain a valid emissions system warranty.

The Vehicle Emission Control Information label is attached inside the left saddlebag.

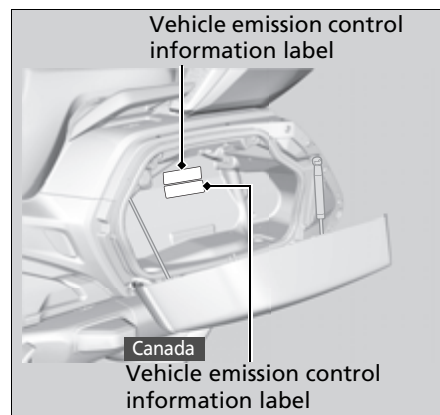

Noise Emission Requirements

The EPA requires that vehicles built after January 1, 1983 comply with applicable noise emission standards for one year or 3,730 miles (6,000 km) after the time of purchase when operated and maintained according to the instructions provided.

Exhaust Emission Control System

The exhaust emission control system includes the following components that should not need adjustment, although periodic inspection by your dealer is recommended.

PGM-FI System

The PGM-FI (programmed fuel injection) system uses sequential multiport fuel injection, and is comprised of air intake, engine control, fuel control, and exhaust control subsystems.

The engine control module (ECM) uses sensors to determine how much air enters the engine, and then controls how much fuel to inject.

Ignition Timing Control System

The ignition timing control system adjusts the ignition timing to reduce the amount of HC, CO, and NO_x produced.

Secondary Air Injection System

The secondary air injection system adds filtered air into the exhaust gas to help improve emission control performance.

Catalytic Converters

The exhaust system contains one or more catalytic converters. Catalytic converters use a catalyst to convert most of the harmful exhaust gas compounds into harmless compounds.

Evaporative Emission Control System

50 STATE (meets California)

An evaporative emissions control system uses a canister filled with charcoal to adsorb fuel vapor from the fuel tank while the engine is off. The vapor is drawn into the engine and burned while riding.

Crankcase Emissions Control System

The engine is equipped with a closed crankcase system to prevent discharging crankcase emissions into the atmosphere. Blow-by gas is returned to the combustion chamber through the air cleaner housing and throttle body.

Fuel Permeation Emission Control

The fuel tank, fuel hoses, and fuel vapor charge hoses use fuel permeation control technologies to prevent fuel vapor emissions.

Tampering with these components to reduce or defeat the effectiveness of the fuel permeation technologies is prohibited.

Noise Emission Control System

TAMPERING WITH THE NOISE CONTROL SYSTEM IS PROHIBITED:

U. S. federal law prohibits, and Canadian provincial laws may prohibit, the following acts or the causing thereof: (1) The removal or rendering inoperative by any person, other than for purposes of maintenance, repair or replacement, of any device or element of design incorporated into any new vehicle for the purpose of noise control prior to its sale or delivery to the ultimate purchaser or while it is in use; or (2) the use of the vehicle after such device or element of design has been removed or rendered inoperative by any person.

AMONG THOSE ACTS PRESUMED TO CONSTITUTE TAMPERING ARE THE FOLLOWING ACTS:

- Removal of, or puncturing the muffler, baffles, header pipes or any other component which conducts exhaust gases.
- Removal of, or puncturing of any part of the intake system.
- Lack of proper maintenance.

- Removing or disabling any emissions compliance component, or replacing any compliance component with a non-compliant component.

Problems Affecting Vehicle Exhaust Emissions

Have your vehicle inspected and repaired by your dealer if you experience any of the following symptoms:

- Hard starting or stalling after starting
- Rough idling
- Misfiring or backfiring during acceleration
- Poor engine performance and poor fuel economy

Catalytic Converter

This vehicle is equipped with two three-way catalytic converters. Each catalytic converter contains precious metals that serve as catalysts in high temperature chemical reactions that convert hydrocarbons (HC), carbon monoxide (CO), and oxides of nitrogen (NO_x) in the exhaust gases into safe compounds.

A defective catalytic converter contributes to air pollution and can impair your engine's performance. A replacement unit must be an original Honda part or equivalent.

Follow these guidelines to protect your vehicle's catalytic converters.

- Always use unleaded gasoline. Leaded gasoline will damage the catalytic converters.
- Keep the engine in good running condition.
A poorly running engine can cause the catalytic converter to overheat, causing damage to the converter or the vehicle.
- If your engine is misfiring, backfiring, stalling, or otherwise not running properly, stop riding and turn off the engine. Have your vehicle serviced as soon as possible.

Oxygenated Fuels

Some conventional fuels blended with alcohol or an ether compound are available in some locales to help reduce emissions to meet clean air standards.

These gasolines are collectively referred to as oxygenated fuels. If you plan to use oxygenated fuel, check that it is unleaded and meets the minimum octane rating and blend requirement.

The following fuel blends have been approved for use in your vehicle:

- Ethanol (ethyl alcohol) up to 10% by volume.
 - ▶ Gasoline containing ethanol may be marketed under the name Gasohol.
- Do not use gasoline containing methanol (methyl alcohol).

If you accidentally fill your fuel tank with an oxygenated fuel containing higher percentages, you may experience performance problems. To resolve the problem, have your dealer drain the fuel tank and replace with the correct fuel. Fuel system or performance problems resulting from the use of an oxygenated fuel containing higher percentages are not covered by your warranty.

NOTICE

Improper use of oxygenated fuels can damage metal, rubber, and plastic parts of your fuel system. Oxygenated fuel can also damage paint. Damage caused by spilled fuel is not covered by warranty.

If you notice any undesirable operating symptoms or performance problems, try a different brand of gasoline.

Authorized Manuals

USA The Service Manual used by your authorized dealer is available from your Honda dealer or Helm, Inc.

Canada See your dealer to order authorized manuals.

Also available, but not necessary to service your model, is the Honda Common Service Manual, which explains basic service information for various systems on Honda motorcycles, scooters, ATV, and SxS.

USA The Winter Storage Guide in conjunction with the Owner's Manual and Service Manual can help you prepare your Honda motorcycle, scooter, ATV, and SxS for winter storage.

These Honda manuals are written for the professional technician. However, if you possess the proper tools, observe the safety standards, and are mechanically capable, you should find them easy to use. Special Honda tools are necessary for some procedures.

USA

Order online: www.helminc.com

Order Toll Free: 1-888-CYCLE93

(1-888-292-5393)

(NOTE: For Credit Card Orders Only)

Monday - Friday 8:00 AM - 6:00 PM EST

Description
2022 GL1800/B/BD/D/DA Service Manual
Common Service Manual (61CSM00)
USA Winter Storage Guide (S9507)
2022 GL1800/B/BD/D/DA Owner's Manual
2022 GL1800/B/BD/D/DA Navigation System Manual

Warranty Coverage and Service

Coverage

Your new Honda is covered by the following warranties:

- Vehicle Limited Warranty
- Emission Control System Warranty
- **USA** Noise Control Warranty

The responsibilities, restrictions, and exclusions that apply to these warranties are explained in the Warranties Booklet given to you by your Honda dealer at the time of purchase. Always keep your Honda owner's card with your Warranties Booklet.

Canada Please refer to the Warranty Booklet posted on our website at www.honda.ca.

It is important to realize that your warranty applies only to defects in material or workmanship of your Honda. Your warranty coverage does not apply to the normal wear and deterioration associated with use of the vehicle.

Your warranty coverage is not voided if you perform your own maintenance. However, failures that occur due directly to improper maintenance are not covered by these warranties.

USA You can extend almost all of your warranty coverage through the HondaCare® Protection Plan.

Statement on Warranty Coverage for Aftermarket and Recycled Parts

The Magnuson-Moss Warranty Act, 15 U.S.C. s. 2301 et seq., makes it illegal for motor vehicle manufacturers to void a motor vehicle warranty or deny warranty coverage solely because an aftermarket or recycled part has been used to repair the vehicle or someone other than the authorized service provider performed service on the vehicle. This provision does not apply to a new motor vehicle purchased solely for commercial or industrial use.

Under federal law, a manufacturer may deny warranty coverage and charge for repairs to a vehicle if it is discovered that an aftermarket or recycled part installed on the vehicle is defective or was installed incorrectly and caused damage to another part of the vehicle otherwise covered under warranty. The Federal Trade Commission requires that a manufacturer demonstrate that an aftermarket or recycled part or service performed by a person other than an authorized service provider caused damage to another part of the vehicle otherwise covered under warranty before denying warranty coverage. Additionally, federal law allows a manufacturer to void a motor vehicle warranty or deny warranty coverage if the manufacturer provides the article or service to consumers free of charge under the warranty or the manufacturer has secured a waiver from the Federal Trade Commission.

Service

Please remember that maintenance recommended in the Maintenance Schedule is not included in your warranty coverage.

If you believe you have a problem with your vehicle, call the service department of your Honda dealer. Make an appointment for an inspection and diagnosis. You will be asked to authorize that inspection, and your dealer will return the results of the inspection. If a problem exists and is covered under warranty, your dealer will perform the warranty repairs.

If you have any questions about your warranty coverage or the nature of the repair, talk to the Service Manager of your Honda dealer.

If a misunderstanding occurs and you aren't satisfied with your dealer's handling of the situation, we suggest you discuss your problem with the appropriate member of the dealership's management team. If you are still not satisfied, contact the owner of the dealership or their designated representative.

Honda Contacts

American Honda Motor Co., Inc.

If you wish to contact Honda directly to comment on your experiences with your vehicle or with your dealer, please send your comments using one of the following methods:



POST MAIL

Powersports Customer Relations,
American Honda Motor Co., Inc.
P.O. Box 2200, Torrance,
CA 90509-2200
mailstop: 100-4W-5F



PHONE

Telephone: (866) 784-1870



ONLINE CUSTOMER SERVICE

Website:

www.powersports.honda.com/contact-us

Canada

Honda Canada Inc.
Customer Relations Department,
180 Honda Boulevard
Markham, Ontario
L6C 0H9
Telephone: (888) 946-6329
Fax: (877) 939-0909
E-mail: honda_cr@ch.honda.com

Please include the following information in your letter:

- Name, address, and telephone number
- Product model, year, and VIN
- Date of purchase
- Dealer name and address

We will likely ask your Honda dealer to respond, or possibly acknowledge your comments directly.

Your Honda Dealer

The service department of your Honda dealer offers trained personnel to perform regular maintenance and unexpected repairs. It has the latest available service information from Honda and also handles warranty inspections and repairs.

The parts department offers Honda Genuine Parts, Pro Honda products, Honda Accessories (USA only), and Honda accessories and products (Canada only) that provide the same quality that went into your vehicle.

USA The sales department offers the HondaCare® Protection Plan to extend almost all of your warranty coverage.

Your Honda dealer can also supply information about riding events and information about safety training available in your local area.

Customer Support

Honda Customer Support

You may contact Honda Customer Service, Motorcycle Division, American Honda Motor Co., Inc., P.O. Box 2200, mailstop: 100-4C-7B, Torrance, CA 90509-2200. Telephone: (866) 784-1870.

Audio/Navigation System Software and Map Software Upgrades

Honda is continually expanding the scope of the Map software and the Audio/Navigation System software. The softwares are updated to correspond with new version releases.

USA

For the software updates, visit our website www.powersports.honda.com.

Canada

For the software updates, visit our website <https://motorcycle.honda.ca>.

Reporting Safety Defects

USA

If you believe that your vehicle has a defect which could cause a crash or could cause injury or death, you should immediately inform the National Highway Traffic Safety Administration (NHTSA) in addition to notifying American Honda Motor Co., Inc.

If NHTSA receives similar complaints, it may open an investigation, and if it finds that a safety defect exists in a group of vehicles, it may order a recall and remedy campaign. However, NHTSA cannot become involved in individual problems between you, your dealer, or American Honda Motor Co., Inc.

To contact NHTSA, you may call the Vehicle Safety Hotline toll-free at:

1-888-327-4236

(TTY: 1-800-424-9153); go to

<https://www.safercar.gov>;

or write to:

Administrator, NHTSA,
1200 New Jersey Avenue, SE.,
Washington, DC 20590.

You can also obtain other information about motor vehicle safety from:

<https://www.safercar.gov>.

Canada

If you believe that your vehicle has a defect which could cause a crash or could cause injury or death, you should immediately inform Honda Canada Inc. and you may also inform Transport Canada.

If Transport Canada receives similar complaints, it may open an investigation, and if it finds that a safety defect exists in a group of vehicles, it may lead to a recall and remedy campaign. However, Transport Canada cannot become involved in individual problems between you, your dealer, or Honda Canada Inc.

To contact Transport Canada's Defect Investigations and Recalls Division,
Mailing Address:
Transport Canada - ASFAD
330 Sparks Street
Ottawa, ON
K1A 0N5

Telephone: 819-994-3328
(Ottawa-Gatineau area or internationally)
Toll free:
1-800-333-0510 (in Canada)

Online:
(English Link:)
www.tc.canada.ca/recalls
(French Link:)
www.tc.canada.ca/rappels

For more information on reporting safety defects or about motor vehicle safety, go to
<https://www.tc.gc.ca/roadsafety>.

Specifications

GL1800BD/D/DA

Main Components

Overall length	GL1800BD	97.4 in (2,475 mm)
	GL1800D/DA	103.0 in (2,615 mm)
Overall width		35.6 in (905 mm)
Overall height	GL1800BD	52.8 in (1,340 mm)
	GL1800D/DA	56.3 in (1,430 mm)
Wheelbase		66.7 in (1,695 mm)
Minimum ground clearance		5.1 in (130 mm)
Caster angle		30.5°
Trail		4.3 in (109 mm)
Curb weight	GL1800BD USA model	805 lb (365 kg)
	GL1800BD Canada model	807 lb (366 kg)
	GL1800D USA model	847 lb (384 kg)
	GL1800D Canada model	849 lb (385 kg)
	GL1800DA USA model	855 lb (388 kg)
	GL1800DA Canada model	858 lb (389 kg)
Maximum weight capacity*1	GL1800BD	421 lb (191 kg)
	GL1800D	423 lb (192 kg)
	GL1800DA	417 lb (189 kg)

*1 Including rider, all luggage, and accessories

Maximum luggage weight	Travel trunk (Except GL1800BD)	20.0 lb (9.0 kg)
	Each saddlebag	20.0 lb (9.0 kg)
	Fairing pocket	4.5 lb (2.0 kg)
Passenger capacity	Shelter case (Except GL1800DA)	6.6 lb (3.0 kg)
	Rider and 1 passenger	
Minimum turning radius		11.2 ft (3.4 m)
Displacement		111.8 cu-in (1,833 cm ³)
Bore x stroke		2.87 x 2.87 in (73.0 x 73.0 mm)
Compression ratio		10.5:1
Fuel	Unleaded gasoline Recommended: 86 PON or higher	
Tank capacity		5.5 US gal (21 liters)
Battery		GYZ20L
		12 V-20 Ah (10 HR)
Gear ratio	1st	2.166
	2nd	1.695
	3rd	1.304
	4th	1.038
	5th	0.820
	6th	0.666
	7th	0.521
Reverse		4.373
Reduction ratio (primary / secondary / final)		1.795 / 0.972 / 2.615

Service Data

Tire size	Front	130/70R18M/C 63H
	Rear	200/55R16M/C 77H
Tire type		Radial, tubeless
Recommended Tire	Front	BRIDGESTONE G853 RADIAL G DUNLOP D423F
	Rear	BRIDGESTONE G852 RADIAL G DUNLOP D423
Tire air pressure	Front	36 psi (250 kPa, 2.50 kgf/cm ²)
	Rear	41 psi (280 kPa, 2.80 kgf/cm ²)
Minimum tread depth	Front	0.06 in (1.5 mm)
	Rear	0.08 in (2.0 mm)
Spark plug	(standard)	CR6HSB-9 (NGK)
Spark plug gap		0.031 to 0.035 in (0.80 to 0.90 mm)
Idle speed	(non-adjustable)	730 ± 100 rpm
Recommended engine oil		API Service Classification SJ or higher except oils labeled as energy conserving or resource conserving on the circular API service label, SAE 10W-30, JASO T 903 standard MA, Pro Honda GN4 4-stroke oil (USA & Canada) or Honda 4-stroke oil, or an equivalent motorcycle oil
		After draining 4.6 US qt (4.4 liters)
Engine oil capacity		After draining & engine oil filter change 4.9 US qt (4.6 liters)
		After draining, engine & clutch oil filter change 4.9 US qt (4.6 liters)
		After disassembly 5.9 US qt (5.6 liters)

Recommended final drive oil	Hypoid gear oil SAE 80	
Final drive oil capacity	After draining	4.7 US oz (140 cm ³)
	After disassembly	5.4 US oz (160 cm ³)
Recommended brake fluid	Honda DOT 4 Brake Fluid	
Cooling system capacity	3.06 US qt (2.90 liters)	
Recommended coolant	Pro Honda HP Coolant	

■ Bulbs

Headlight	LED
Brake light	LED
Taillight	LED
Front turn signal light	LED
Rear turn signal light	LED
License plate light	LED
Fog light (GL1800D/DA)	LED

■ Fuses

Ignition main fuse	30 A
ACC main fuse	20 A
Main fuse B	120 A
External amplifier fuse	40 A
Other fuse	30 A, 15 A, 10 A, 5 A

■ Torque Specifications

Final drive oil fill hole cap	5.9 lbf-ft (8 N·m, 0.8 kgf-m)
-------------------------------	-------------------------------

Specifications

GL1800/B

■ Main Components

Overall length	GL1800	103.0 in (2,615 mm)
	GL1800B	97.4 in (2,475 mm)
Overall width	36.4 in (925 mm)	
Overall height	GL1800	56.3 in (1,430 mm)
	GL1800B	52.8 in (1,340 mm)
Wheelbase	66.7 in (1,695 mm)	
Minimum ground clearance	5.1 in (130 mm)	
Caster angle	30.5°	
Trail	4.3 in (109 mm)	
Curb weight	GL1800 USA model	844 lb (383 kg)
	GL1800 Canada model	847 lb (384 kg)
	GL1800B USA model	789 lb (358 kg)
	GL1800B Canada model	805 lb (365 kg)
Maximum weight capacity*1	GL1800	423 lb (192 kg)
	GL1800B	421 lb (191kg)
Maximum luggage weight	Travel trunk (Except GL1800B)	20.0 lb (9.0 kg)
	Each saddlebag	20.0 lb (9.0 kg)
	Fairing pocket	4.5 lb (2.0 kg)
	Shelter case	6.6 lb (3.0 kg)
	Passenger capacity	Rider and 1 passenger
Minimum turning radius	11.2 ft (3.4 m)	

*1 Including rider, all luggage, and accessories

Displacement	111.8 cu-in (1,833 cm ³)	
Bore x stroke	2.87 x 2.87 in (73.0 x 73.0 mm)	
Compression ratio	10.5:1	
Fuel	Unleaded gasoline Recommended: 86 PON or higher	
Tank capacity	5.5 US gal (21 liters)	
Battery	GYZ20L	
	12 V-20 Ah (10 HR)	
Gear ratio	1st	2.200
	2nd	1.416
	3rd	1.035
	4th	0.820
	5th	0.666
	6th	0.521
Reduction ratio (primary / secondary / final)	1.795 / 0.972 / 2.615	

■ Service Data

Tire size	Front	130/70R18M/C 63H
	Rear	200/55R16M/C 77H
Tire type	Radial, tubeless	
Recommended Tire	Front	BRIDGESTONE G853 RADIAL G DUNLOP D423F
	Rear	BRIDGESTONE G852 RADIAL G DUNLOP D423
Tire air pressure	Front	36 psi (250 kPa, 2.50 kgf/cm ²)
	Rear	41 psi (280 kPa, 2.80 kgf/cm ²)
Minimum tread depth	Front	0.06 in (1.5 mm)
	Rear	0.08 in (2.0 mm)
Spark plug	(standard)	CR6HSB-9 (NGK)
Spark plug gap	0.031 to 0.035 in (0.80 to 0.90 mm)	
Idle speed	(non-adjustable)	730 ± 100 rpm
Recommended engine oil	API Service Classification SJ or higher except oils labeled as energy conserving or resource conserving on the circular API service label, SAE 10W-30, JASO T 903 standard MA, Pro Honda GN4 4-stroke oil (USA & Canada) or Honda 4-stroke oil, or an equivalent motorcycle oil	
	After draining	3.7 US qt (3.5 liters)
Engine oil capacity	After draining & engine oil filter change	3.9 US qt (3.7 liters)
	After disassembly	4.6 US qt (4.4 liters)

Recommended final drive oil	Hypoid gear oil SAE 80	
Final drive oil capacity	After draining	4.7 US oz (140 cm ³)
	After disassembly	5.4 US oz (160 cm ³)
Recommended brake (clutch) fluid	Honda DOT 4 Brake Fluid	
Cooling system capacity	3.06 US qt (2.90 liters)	
Recommended coolant	Pro Honda HP Coolant	

■ Bulbs

Headlight	LED
Brake light	LED
Taillight	LED
Front turn signal light	LED
Rear turn signal light	LED
License plate light	LED
Fog light (GL1800)	LED

■ Fuses

Ignition main fuse	30 A
ACC main fuse	20 A
Main fuse B	120 A
Speed limiter fuse (Except GL1800B USA model)	60 A
External amplifier fuse	40 A
Other fuse	30 A, 15 A, 10 A, 5 A

■ Torque Specifications

Final drive oil fill hole cap	5.9 lbf-ft (8 N-m, 0.8 kgf-m)
-------------------------------	-------------------------------

Information Record

VIN	
Engine No.	
Color Label & Code	
Owner's Name	
Address	
City/State	
Phone	
Dealer's Name	
Address	
City/State	
Phone	
Service Manager	

California Proposition 65 Warning

 **WARNING:** Operating, servicing and maintaining a passenger vehicle or off-highway motor vehicle can expose you to chemicals including engine exhaust, carbon monoxide, phthalates, and lead, which are known to the State of California to cause cancer and birth defects or other reproductive harm. To minimize exposure, avoid breathing exhaust, do not idle the engine except as necessary, service your vehicle in a well-ventilated area and wear gloves or wash your hands frequently when servicing your vehicle. For more information go to www.P65Warnings.ca.gov/passenger-vehicle.

HONDA
The Power of Dreams

**RIDE
RED**

31MKC640
00X31-MKC-6400

PRINTED IN USA

Free Manuals Download Website

<http://myh66.com>

<http://usermanuals.us>

<http://www.somanuals.com>

<http://www.4manuals.cc>

<http://www.manual-lib.com>

<http://www.404manual.com>

<http://www.luxmanual.com>

<http://aubethermostatmanual.com>

Golf course search by state

<http://golfingnear.com>

Email search by domain

<http://emailbydomain.com>

Auto manuals search

<http://auto.somanuals.com>

TV manuals search

<http://tv.somanuals.com>