

HONDA
The Power of Dreams

Owner's Guide

for Quick Reference

Owner's Manuals at:
owners.honda.com (U.S.)
honda.ca (Canada)

2020 ODYSSEY

31THRG20
OG12684
00X31-THR-G201

2020 Honda ODYSSEY Owner's Guide
© 2019 Honda Motor Co., Ltd. — All Rights Reserved

Printed in U.S.A.

 **HONDA**

DISCLOSURES

Devices That Emit Radio Waves

Each radio frequency device installed in the vehicle conforms to the requirements and standards of the regulation listed below:

As required by the FCC:

This device complies with Part 15 of the FCC rules. Operation is subject to the following two conditions: (1) This device may not cause harmful interference, and (2) this device must accept any interference received, including interference that may cause undesired operation.

Changes or modifications not expressly approved by the party responsible for compliance could void the user's authority to operate the equipment.

As required by Industry Canada:

This device complies with Industry Canada licence-exempt RSS standard(s). Operation is subject to the following two conditions: (1) this device may not cause interference, and (2) this device must accept any interference, including interference that may cause undesired operation of the device.

Disclaimer

The information and data contained herein are believed to be accurate and reliable. American Honda Motor Co., Inc. makes no warranty of any kind and accepts no responsibility for the results obtained through application of this information.

Privacy Notice

This vehicle may share location and usage information. To manage this setting, visit www.hondalink.com/vehicle-data-choices.

Event Data Recorders

This vehicle is equipped with an event data recorder (EDR). The main purpose of an EDR is to record, in certain crash or near crash-like situations, such as an airbag deployment or hitting a road obstacle, data that will assist in understanding how a vehicle's systems performed. **The EDR is designed to record data related to vehicle dynamics and safety systems for a short period of time, typically 30 seconds or less. The EDR in this vehicle is designed to record such data as:**

- **How various systems in your vehicle were operating;**
- **Whether or not the driver and passenger safety belts were buckled/fastened;**

- **How far (if at all) the driver was depressing the accelerator and/or brake pedal; and,**
- **How fast the vehicle was traveling.**

These data can help provide a better understanding of the circumstances in which crashes and injuries occur. NOTE: EDR data are recorded by your vehicle only if a non-trivial crash situation occurs; no data are recorded by the EDR under normal driving conditions and no personal data (e.g., name, gender, age, and crash location) are recorded. However, other parties, such as law enforcement, could combine the EDR data with the type of personally identifying data routinely acquired during a crash investigation.

To read data recorded by an EDR, special equipment is required, and access to the vehicle or the EDR is needed. In addition to the vehicle manufacturer, other parties such as law enforcement that have the special equipment can read the information if they have access to the vehicle or the EDR.

The data belongs to the vehicle owner and may not be accessed by anyone else except as legally required or with the permission of the vehicle owner.

Service Diagnostic Recorders

This vehicle is equipped with service-related devices that record information about powertrain performance. The data can be used to verify emissions law requirements and/or help technicians diagnose and solve service problems. It may also be combined with data from other sources for research purposes, but it remains confidential. Some diagnostic and maintenance information is uploaded to Honda upon vehicle start up.

INTRODUCTION

This is a quick reference guide to acquaint you with your **2020 ODYSSEY**. It provides basic information and instructions on technology and convenience features, as well as emergency procedures and how to get assistance.

This guide is for vehicles sold in the United States and Canada. It covers all variations of your model, so you may find descriptions of features and equipment that are not in your vehicle. Images throughout this guide represent features and equipment that are available on some, but not all, models.

This guide is not intended to be a substitute for the Owner's Manual. Visit owners.honda.com (U.S.) or honda.ca (Canada) to view the most current Owner's Manual, Navigation Manual, Vehicle Warranty, Rear Entertainment System Booklet in Braille, and the tire manufactures' warranties.

If you are the first registered owner of your vehicle, you may request a complimentary printed copy of the Owner's Manual, Navigation Manual, or Vehicle Warranty within the first six months of vehicle purchase. To request a copy, visit owners.honda.com and create or log in to your account. In Canada, please request a copy from your Honda dealer.

Honda Automobile Customer Service

Your authorized Honda dealer should be able to answer any questions you have about your vehicle. However, if you are dissatisfied with the information you receive, you can call Honda Automobile Customer Service.

Call (800) 999-1009 (U.S.) or (888) 946-6329 (Canada).

Honda Roadside Assistance

24-hour emergency road service is available to you in the United States and Canada throughout your 3-year/36,000-mile warranty term. Services include jump starting, flat tire and lockout assistance, towing, and more (limitations apply).

Call (866) 864-5211 (U.S.) or (800) 465-7587 (Canada)

TABLE OF CONTENTS

VISUAL INDEX.....	1	NAVIGATION.....	117
SAFETY INFORMATION.....	3	DRIVING.....	121
INSTRUMENT PANEL.....	30	HANDLING THE UNEXPECTED.....	164
VEHICLE CONTROLS.....	39	MAINTENANCE.....	181
AUDIO AND CONNECTIVITY.....	81	SPECIFICATIONS.....	205
<i>BLUETOOTH</i> [®] HANDSFREELINK [®] ...	108	CUSTOMER INFORMATION.....	207
VOICE COMMAND INDEX.....	116	INDEX.....	209

VISUAL INDEX

Steering Wheel and Nearby Controls



This page intentionally left blank.

1. Lights/Turn Signals
2. Wipers/Washers

3. Horn
4. Brightness Control

Dashboard and Nearby Controls

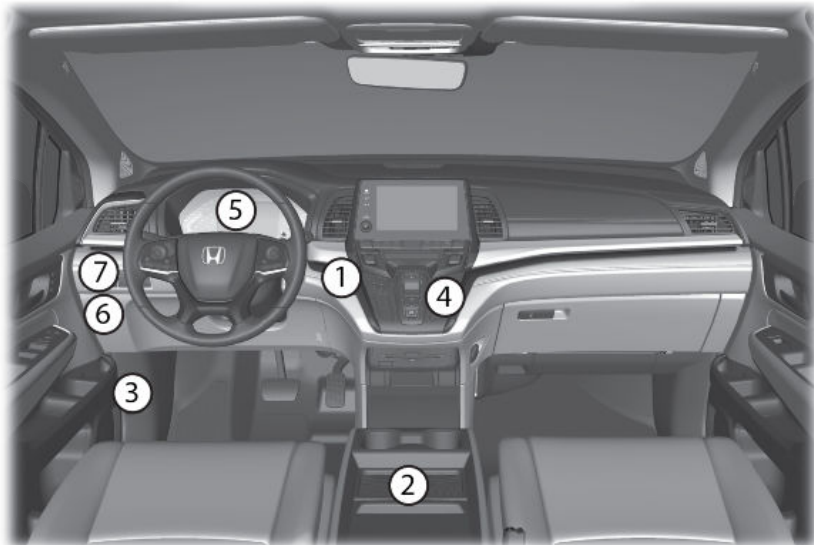

- | | |
|-----------------------------|--|
| 1. ENGINE START/STOP Button | 5. Driver Information Interface |
| 2. USB Port | 6. Electric Parking Brake Switch |
| 3. Hood Release Handle | 7. Power Tailgate Button* ¹ |
| 4. Hazard Warning Button | |

SAFETY INFORMATION

Your safety, and the safety of others, is very important and operating this vehicle safely is an important responsibility. While we strive to help you make informed decisions about safety, it is not practical or possible to warn you about all the hazards associated with operating or maintaining your vehicle. Therefore, you must use your own good judgment.

Important Safety Information

This guide explains many of your vehicle's safety features and how to use them. Please read this information carefully. Following the instructions below will also help to keep you and your passengers safe.

■ Important Safety Precautions

- Always wear your seat belt.
- Secure all children in the proper restraint system.
- Be aware of airbag hazards.
- Don't drink and drive.
- Pay appropriate attention to the task of driving safely.
- Control your speed.
- Keep your vehicle in safe condition.
- Do not leave children unattended in the vehicle.

Engaging in cell phone conversation or other activities that keep you from paying close attention to the road, other vehicles, and pedestrians could lead to a crash. Remember, situations can change quickly, and only you can decide when it is safe to divert some attention away from driving.

■ Safety Messages

When you see the following messages throughout this guide, pay close attention.

⚠ DANGER

You **WILL** be KILLED or SERIOUSLY HURT if you don't follow instructions.

⚠ WARNING

You **CAN** be KILLED or SERIOUSLY HURT if you don't follow instructions.

⚠ CAUTION

You **CAN** be HURT if you don't follow instructions.

NOTICE

This information is intended to help you avoid damage to your vehicle, other property, or the environment.

*1 - If equipped

■ Carbon Monoxide Gas

The engine exhaust from this vehicle contains carbon monoxide, a colorless, odorless, and highly toxic gas. As long as you properly maintain your vehicle and follow the instructions set forth below, you will not accumulate dangerous levels of carbon monoxide gas in the vehicle interior.

Have the exhaust system inspected for leaks whenever:

- The exhaust system is making an unusual noise.
- The exhaust system may have been damaged.
- The vehicle is raised for an oil change.

When you operate a vehicle with the tailgate open, airflow can pull exhaust gas into the interior and create a hazardous condition. If you must drive with the tailgate open, open all the windows and set the climate control system as shown below:

1. Select the fresh air mode.
2. Select the  mode.
3. Set the fan speed to high.
4. Set the temperature control to a comfortable setting.

Adjust the climate control system in the same manner if you sit in your parked vehicle with the engine running.

WARNING

Carbon monoxide gas is toxic.
Breathing it can cause unconsciousness and even kill you.
Avoid any enclosed areas or activities that expose you to carbon monoxide.

An enclosed area such as a garage can quickly fill up with carbon monoxide gas. Do not run the engine with the garage door closed. Even when the garage door is open, drive out of the garage immediately after starting the engine.

Seat Belts

A seat belt is your best protection in all types of collisions. Airbags are designed to supplement seat belts, not replace them. So even though your vehicle is equipped with airbags, make sure you and your passengers always wear your seat belts and wear them properly.

■ Lap/Shoulder Seat Belts

All seven or eight seating positions are equipped with lap/shoulder seat belts with emergency locking retractors. In normal driving, the retractor lets

you move freely while keeping some tension on the belt. During a collision or sudden stop, the retractor locks to restrain your body. The rear seat belts also have a lockable retractor for use with child seats.

■ Proper Use of Seat Belts

Follow these guidelines for proper use:

- All occupants should sit upright, well back in the seat, and remain in the position for the duration of the trip. Slouching and leaning reduces the effectiveness of the belt and can increase the chance of serious injury in a crash.
- Never place the shoulder part of a lap/shoulder seat belt under your arm or behind your back. This could cause very serious injuries in a crash.
- Two people should never use the same seat belt. If they do, they could be very seriously injured in a crash.
- Do not put any accessories on the seat belts. Devices intended to improve comfort or reposition the shoulder part of a seat belt can reduce the protective capability and increase the chance of serious injury in a crash.
- No one should sit in a seat with an inoperative seat belt or one that does not appear to be working correctly. Using a seat belt that is not working properly may not protect the occupant in a crash. Have a dealer check the belt as soon as possible.

WARNING

Not wearing a seat belt properly increases the chance of a serious injury or death in a crash, even though your vehicle has airbags.
Be sure you and your passengers always wear seat belts and wear them properly.

■ Seat Belt Inspection

Regularly check the condition of your seat belts as follows:

- Pull each belt out fully and look for frays, cuts, burns, and wear.
- Check that the latch plates and buckles work smoothly and the belts retract easily. If a belt does not retract easily, cleaning the belt may correct the problem. Only use mild soap and warm water. Do not use bleach or cleaning solvents. Make sure the belt is completely dry before allowing it to retract.

Any belt that is not in good condition or working properly will not provide proper protection and should be replaced as soon as possible.

A belt that has been worn during a crash may not provide the same level of protection in a subsequent crash. Have your seat belts inspected by a dealer after any collision.

⚠ WARNING

Not checking or maintaining seat belts can result in serious injury or death if the seat belts do not work properly when needed.

Check your seat belts regularly and have any problem corrected as soon as possible.

■ Fastening a Seat Belt

Adjust your seat to the proper position and then follow the steps below:

1. Pull the seat belt out slowly.



2. Insert the latch plate into the buckle, then tug on the belt to make sure the buckle is secure. Make sure that the belt is not twisted or caught on anything.

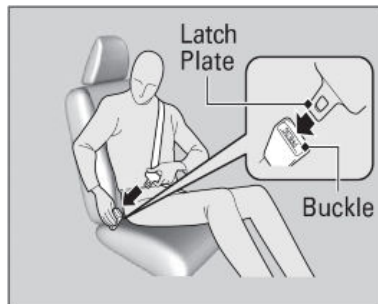

3. Position the lap part of the belt as low as possible across your hips, then pull up on the shoulder part of the belt so the lap part fits snugly. This lets your strong pelvic bones take the force of a crash and reduces the chance of internal injuries.



4. If necessary, pull up on the belt again to remove any slack, then make sure that the belt rests across the center of your chest and over your shoulder. This spreads the forces of a crash over the strongest bones in your upper body.

To release the belt, push the red **PRESS** button then guide the belt by hand until it has retracted completely. When exiting the vehicle, be sure the belt is properly stowed so that it will not get caught in the closing door.

⚠ WARNING

Improperly positioning the seat belt can cause serious injury or death in a crash.

Make sure all seat belts are properly positioned before driving.

■ Adjusting the Shoulder Anchor

The front seats have adjustable shoulder anchors to accommodate taller and shorter occupants.

1. Move the anchor up and down while pulling the release outward.
2. Position the anchor so that the belt rests across the center of your chest and over your shoulder.



■ Seat Belt with Detachable Anchor

1. Pull out the seat belt's small latch plate and the latch plate from each holding slot in the ceiling.

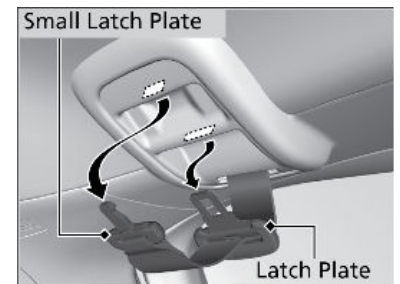

- Line up the triangle marks on the small latch plate and anchor buckle. Make sure the seat belt is not twisted. Attach the belt to the anchor buckle.

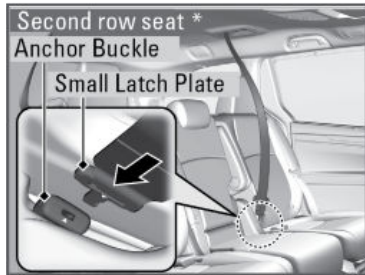

* Not available on all models

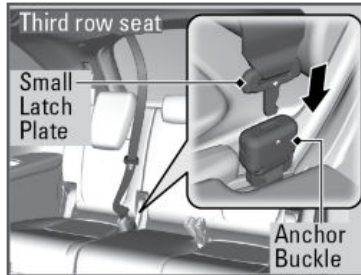

- Insert latch plate into the buckle. Properly fasten the seat belt the same way you fasten the lap/shoulder seat belt.

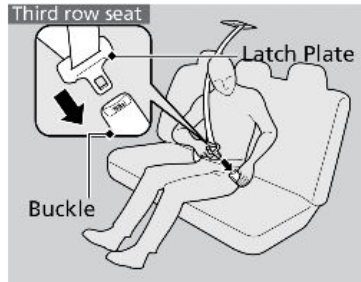
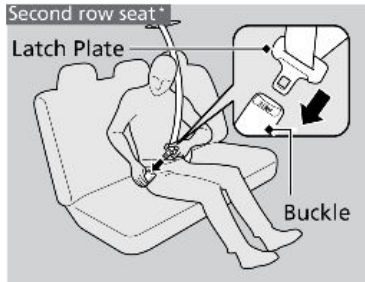

- To unlatch the detachable anchor, insert the latch plate into the slot on the side of the anchor buckle.

Second Row Center Seat*¹

Pivot down the anchor buckle forward. Insert the latch plate into the slot on the back of the anchor buckle.

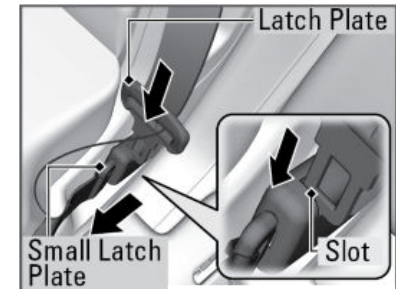
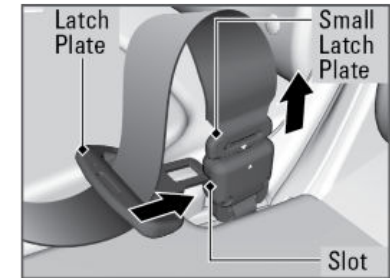

⚠ WARNING

Using the seat belt with the detachable anchor unlatched increases the change of serious injury or death in a crash.

Before using the seat belt, make sure the detachable anchor is correctly latched.

Airbags

Your vehicle is equipped with several types of airbags: front airbags, front knee airbags, side airbags, and side curtain airbags.

■ Front Airbags (SRS)

The front SRS airbags inflate in a moderate-to-severe frontal collision to help protect the head and chest of the driver and/or front passenger. They are housed in the center of the steering wheel for the driver and in the dashboard for the front passenger. Both airbags are marked SRS AIRBAG.

SRS (Supplemental Restraint System) indicates that the airbags are designed to supplement seat belts, not replace them. Seat belts are the occupant's primary restraint system.

Front knee SRS airbags inflate in a moderate to severe frontal collision to help keep the driver and front passenger in the proper position and to help maximize the benefit provided by the vehicle's other safety features.

*1 - If equipped

The driver's knee airbag is housed under the steering column. The front passenger's knee airbag is stored under the glove box. Both are marked **SRS AIRBAG**.

When the driver's front airbag inflates, the driver's knee airbag also inflates. When front passenger's airbag inflates, the front passenger's knee airbag also inflates.

Even if the collision is not severe enough to deploy the front airbag, the knee airbag may inflate alone.

Do not attach accessories on or near the driver's and front passenger's knee airbag. They can interfere with the proper operation of the airbag, or hurt someone if an airbag inflates.

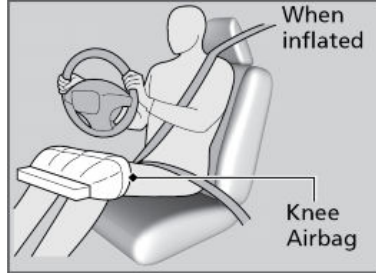
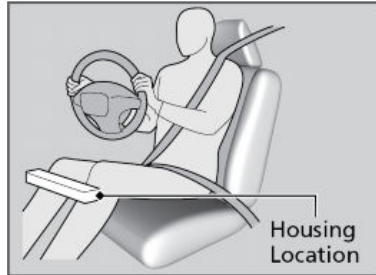

■ Advanced Airbags

The airbags have advanced features to help reduce the likelihood of airbag related injuries to smaller occupants.

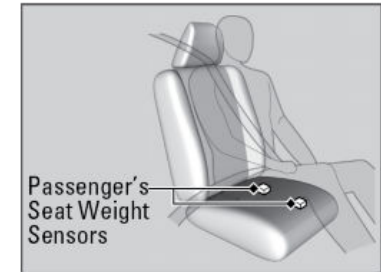

The driver's advanced airbag system includes a seat position sensor. Based on information from this sensor and the severity of the impact, the advanced airbag system determines the optimal deployment of the driver's airbag.

The front passenger's advanced airbag system has weight sensors.

We advise against allowing a child age 12 or under to ride in the front passenger's seat. However, **if you do allow a child age 12 or under to ride in the front passenger's seat**, note that the system will automatically turn off the front passenger's airbag if the sensors detect that the child is approximately 65 lbs (29 kg) or less.

For the advanced airbags to work properly:

- Do not spill any liquid on or under the seats.
- Make sure the floor mat behind the front passenger's seat is hooked to the floor mat anchor. An improperly placed mat can interfere with the advanced airbag sensors.
- Do not put any object under the passenger's seat.
- Make sure any objects are positioned properly on the floor. Improperly positioned objects can interfere with the advanced airbag sensors.
- All occupants should sit upright and wear their seat belts properly.
- Do not cover the passenger's side dashboard with a cloth, towel, cover, etc.

■ Side Airbags

The side airbags help protect the upper torso and pelvis of the driver or a front passenger during a moderate-to-severe side impact. They are housed in the outside edge of the driver's and front passenger's seat-backs. Both are marked **SIDE AIRBAG**.

When the sensors detect a moderate-to-severe side impact, the control unit signals the side airbag on the impact side to immediately inflate.

Do not attach accessories on or near the side airbags. They can interfere with the proper operation of the airbags or hurt someone if an airbag inflates.

Do not cover or replace the front seat-back covers without consulting a dealer. This can prevent your side airbags from properly deploying during a side impact.

■ Side Curtain Airbags

Side curtain airbags help protect the heads of the driver and passengers in outer seating positions during a moderate-to-severe side impact. The side curtain airbags equipped in this vehicle are also designed to help reduce the likelihood of partial and complete ejection of vehicle occupants through side windows in crashes, particularly rollover crashes.

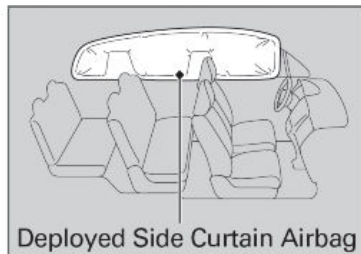
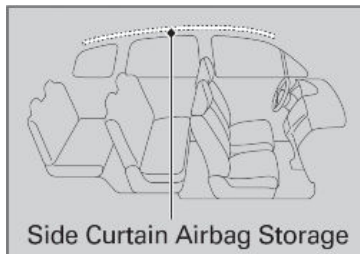

The side curtain airbags are located in the ceiling above the side windows on both sides of the vehicle.

The side curtain airbags are designed to deploy in a rollover or moderate-to-severe side impact.

If the SRS control unit senses that your vehicle is about to roll over, it immediately deploys both side curtain airbags and activates both front seat belt tensioners.

If the impact is on the passenger's side, the passenger's side curtain airbag deploys even if there are no occupants on that side of the vehicle.

To get the best protection from the side curtain airbags, occupants should wear their seat belts properly and sit upright and well back in their seats.

When side curtain airbags deploy in a frontal collision

One or both side curtain airbags may inflate in a moderate-to-severe angled frontal collision.

■ Important Facts About Your Airbags

Airbags can pose serious hazards. To do their job, airbags must inflate with tremendous force. So, while airbags help save lives, they can cause burns, bruises, and other minor injuries, sometimes even fatal ones if occupants are not wearing their seat belts properly and sitting correctly.

What you should do: Always wear your seat belt properly, and sit upright and as far back from the steering wheel as possible while allowing full control of the vehicle. A front passenger should move their seat as far back from the dashboard as possible.

Remember, however, that no safety system can prevent all injuries or deaths that can occur in a severe crash, even when seat belts are properly worn and the airbags deploy.

Do not place hard or sharp objects between yourself and a front airbag.

Carrying hard or sharp objects on your lap or driving with a pipe or other sharp object in your mouth can result in injuries if your front airbag inflates.

Do not attach or place objects on the front and driver's knee airbag covers.

Objects on the covers marked **SRS AIRBAG** could interfere with the proper operation of the airbags or be propelled inside the vehicle and hurt someone if the airbags inflate.

Airbag System Indicators

If a problem occurs in the airbag system, the SRS indicator comes on and a message appears on the Driver Information Interface.

Supplemental Restraint System (SRS) Indicator

When the power mode is set to ON, the indicator comes on for a few seconds, then goes off. This tells you the system is working properly.

If the indicator comes on at any other time besides vehicle start-up or does not come on at all, have the system checked by a dealer as soon as possible. If you don't, your airbags and seat belt tensioners may not work properly when they are needed.



⚠ WARNING

Ignoring the SRS indicator can result in serious injury or death if the airbag systems or tensioners do not work properly.

Have your vehicle checked by a dealer as soon as possible if the SRS indicator alerts you to a possible problem.

Passenger Airbag Off Indicator

The indicator comes on to alert you that the passenger's front airbag has been turned off. This occurs when the front passenger's weight sensors detect about 65 lbs (29 kg) or less, the weight of an infant or small child, on the seat.

Children age 12 or under should always ride properly restrained in a back seat.

If the front passenger's seat is empty, the passenger's front airbag will not deploy and the indicator will come on. The front passenger's knee airbag will not deploy either.

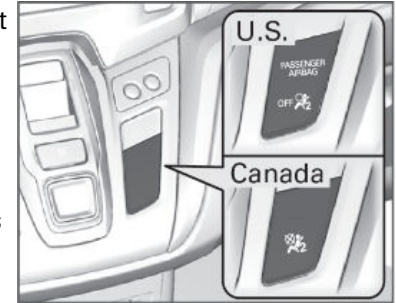

To ensure the passenger is detected properly, confirm that:

- There is no child seat or other object pressing against the rear of the seat-back.
- There is no rear passenger pushing or pulling on the back of the front passenger's seat.
- The front seat or seat-back is not forced back against an object on the seat or floor behind it.
- There is no object placed under or beside the front passenger's seat.
- The occupant is sitting in an upright position and the seat-back is not excessively reclined.
- The occupant is not leaning against the door or center console.
- The occupant's feet are placed on the floor in front of them.
- There are no objects hanging from the front passenger's seat.
- Only small, lightweight objects are in the seat-back pocket.

The passenger front airbag off indicator may come on and go off repeatedly if the total weight on the seat is near the airbag cutoff threshold.

Have your vehicle checked by a dealer as soon as possible if:

- All of the above conditions are met and the indicator comes on with an adult seated in the front passenger seat.
- The seat is empty and the indicator is off.

Do not allow an adult passenger to ride in the front seat when the indicator is on.

Airbag System Components

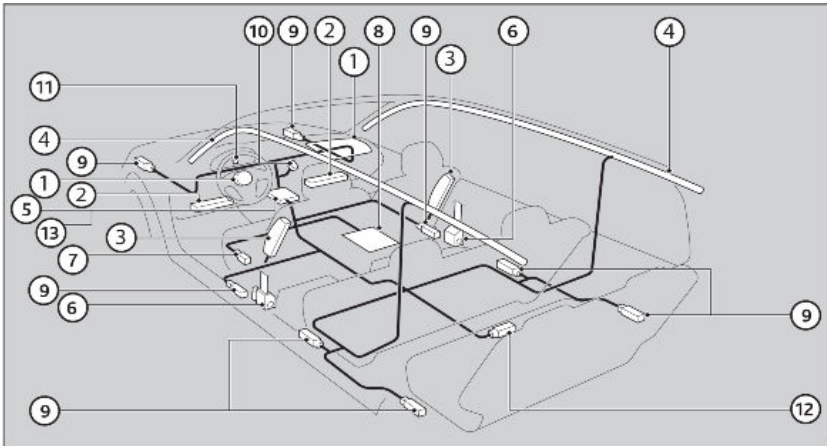

1. Two SRS (Supplemental Restraint System) front airbags. The driver's airbag is stored in the center of the steering wheel; the front passenger's airbag is stored in the dashboard. Both are marked **SRS AIRBAG**.
2. Two front knee airbags. The driver's knee airbag is stored under the steering column; the front passenger's knee airbag is stored under the glove box. Both are marked **SRS AIRBAG**.
3. Two side airbags, one for the driver and one for a front passenger. The airbags are stored in the outer edges of the seat-backs. Both are marked **SIDE AIRBAG**.
4. Two side curtain airbags, one for each side of the vehicle. The airbags are stored in the ceiling, above the side windows. The front and rear pillars are marked **SIDE CURTAIN AIRBAG**.
5. An electronic control unit that, when the vehicle is ON, continually monitors information about the various impact sensors, seat and buckle sensors, rollover sensor, airbag activators, seat belt tensioners, and other vehicle information. During a crash event the unit can record such information.
6. Automatic front seat belt tensioners. In addition, the driver's and front passenger's seat belt buckles incorporate sensors that detect whether or not the belts are fastened.
7. A driver's seat position sensor. This sensor determines the optimal force at which the airbag will deploy in a crash.
8. Weight sensors in the front passenger's seat. The front passenger's airbag will be turned off if the weight on the seat is approximately 65 lbs (29 kg) or less (the weight of an infant or small child).

9. Impact sensors that can detect a moderate-to-severe front or side impact.
10. An indicator on the dashboard that alerts you that the front passenger's front airbag has been turned off.
11. An indicator on the instrument panel that alerts you to a possible problem with the airbag system or seat belt tensioners.
12. Safing sensor.
13. A rollover sensor that can detect if your vehicle is about to roll over and signal the control unit to deploy both side curtain airbags.

Airbag Care

You do not need to, and should not, perform any maintenance on or replace any airbag system components yourself. However, you should have your vehicle inspected by a dealer in the following situations:

When the airbags have deployed

If an airbag has inflated, the control unit and other related parts must be replaced. Similarly, once an automatic seat belt tensioner has been activated, it must be replaced.

When the vehicle has been in a moderate-to-severe collision

Even if the airbags did not inflate, have your dealer inspect the following: the driver's seat position sensor, weight sensors in the passenger's seat, front seat belt tensioners, and each seat belt that was worn during the crash.

Do not remove or modify a front seat without first consulting a dealer

This would likely disable or affect the driver's seat position sensor or the weight sensors in the passenger's seat. If it is necessary to remove or modify a front seat to accommodate a person with disabilities, contact a Honda dealer. For U.S. vehicles, call Honda Automobile Customer Service at (800) 999-1009. For Canadian vehicles, call Honda Canada Customer Relations at (888) 946-6329.

Child Safety

Each year, many children are injured or killed in vehicle crashes because they are either unrestrained or not properly restrained. In fact, vehicle collisions are the number one cause of death of children ages 12 and under.

The National Highway Traffic Safety Administration and Transport Canada recommend that all children ages 12 and under be properly restrained in a rear

seat. Some states or provinces/territories have laws restricting where children may ride.

To reduce the number of child deaths and injuries, every state, Canadian province, and territory requires that infants and children be properly restrained when they ride in a vehicle.

■ Protecting Child Passengers – Important Considerations

- An inflating front or side airbag can injure or kill a child sitting in the front seat.
- A child in the front seat is more likely to interfere with the driver's ability to safely control the vehicle.
- Statistics show that children of all sizes and ages are safer when they are properly restrained in a rear seat.
- Any child who is too small to wear a seat belt correctly must be restrained in an approved child seat that is properly secured to the vehicle using either the lap belt portion of the lap/shoulder belt or the lower anchors of the LATCH system.
- Never hold a child on your lap because it is impossible to protect them in the event of a collision.
- Never put a seat belt over yourself and a child. During a crash, the belt would likely press deep into the child and cause serious or fatal injuries.
- Never let two children use the same seat belt. Both children could be very seriously injured in a crash.
- Do not allow children to operate the doors, windows, or seat adjustments.
- Do not leave children, pets or people needing assistance in the vehicle unattended, especially in hot weather when the inside of the vehicle can get hot enough to kill them. They could also activate vehicle controls, causing it to move unexpectedly.

To deactivate a lockable retractor, release the buckle and allow the seat belt to wind up all the way.

To remind you of the passenger's front airbag hazards and child safety, your vehicle has warning labels on the dashboard (U.S. models) and on the front visors. Please read and follow the instructions on these labels.

⚠ WARNING

Children who are unrestrained or improperly restrained can be seriously injured or killed in a crash.

Any child too small for a seat belt should be properly restrained in a child seat.

A larger child should be properly restrained with a seat belt, using a booster seat if necessary.

⚠ WARNING

Allowing a child to play with a seat belt or wrap one around their neck can result in serious injury or death.

Instruct children not to play with any seat belt and make sure any unused seat belt a child can reach is buckled, fully retracted, and locked.

■ Protecting Infants

An infant must be properly restrained in a rear-facing, reclining child seat until the infant reaches the seat manufacturer's weight or height limit for the seat, and the infant is at least one year old. Many experts recommend use of a rear-facing seat for a child up to two years old if the child's height and weight are appropriate for a rear-facing seat.

Child seats must be placed and secured in a rear seating position. Rear-facing child seats should never be installed in a forward-facing position. When properly installed, a rear-facing child seat may prevent the driver or a front passenger from moving their seat all the way back, or from locking their seat-back in the desired position.

Make sure that there is no contact between the child seat and the seat in front of it. It can also interfere with proper operation of the front passenger's advanced front airbag system. If this occurs, we recommend that you install the child seat directly behind the front passenger's seat, move the seat as far forward as needed, and leave it unoccupied. Or, you may wish to get a smaller rear-facing child seat.

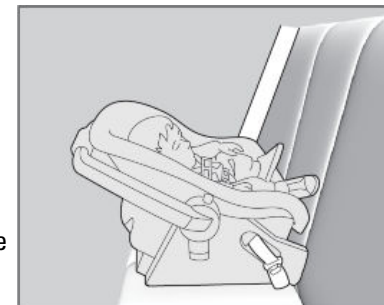

Always refer to the child seat manufacturer's instructions before installation.

Do not allow a front seat to rest against a child seat installed in a rear seating position: The weight sensor in the front seat may not correctly detect the actual weight of the occupant.

⚠ WARNING

Placing a rear-facing child seat in the front seat can result in serious injury or death during a crash.

Always place a rear-facing child seat in the rear seat, not the front.

■ Protecting Smaller Children

If a child is at least one year old and has exceeded the weight and height limitations of a rearward-facing child seat, the child should be properly restrained in a firmly secured forward-facing child seat until they exceed the weight and height limitations for the forward-facing child seat.

We strongly recommend placing a forward-facing child seat in a rear seating position. Placing a forward-facing child seat in the front seat can be hazardous, even with advanced front airbags that automatically turn the passenger's front airbag off. A rear seat is the safest place for a child.



Educate yourself about the laws and regulations regarding child seat use where you are driving, and follow the child seat manufacturer's instructions.

⚠ WARNING

Placing a forward-facing child seat in the front seat can result in serious injury or death if the front airbag inflates.

If you must place a forward-facing child seat in front, move the vehicle seat as far back as possible, and properly restrain the child.

■ Selecting a Child Seat

Most child seats are LATCH-compatible (Lower Anchors and Tethers for Children). Some have a rigid-type connector, while others have a flexible-type connector. Both are equally easy to use. Some existing and previously owned child seats can only be installed using the seat belt. Whichever type you choose, follow the child seat manufacturer's use and care instructions

including recommended expiration dates as well as the instructions in this guide. Proper installation is key to maximizing your child's safety.

In seating positions and vehicles not equipped with LATCH, a LATCH compatible child seat can be installed using the seat belt and a top tether for added security. This is because all child seats are required to be designed so that they can be secured with a lap belt or the lap part of a lap/shoulder belt. In addition, the child seat manufacturer may advise that a seat belt be used to attach a LATCH-compatible seat once a child reaches a specified weight. Please read the child seat owner's manual for proper installation instructions.

Important considerations when selecting a child seat

Make sure the child seat meets the following three requirements:

- The child seat is the correct type and size for the child.
- The child seat is the correct type for the seating position.
- The child seat is compliant with Federal Motor Vehicle Safety Standard 213 or Canadian Motor Vehicle Safety Standard 213.

■ Installing a LATCH-Compatible Child Seat

A LATCH-compatible child seat can be installed in each of the second and third row seats except for the third row center. A child seat is attached to the lower anchors with either the rigid or flexible type of connectors.

1. Locate the lower anchors under the marks.

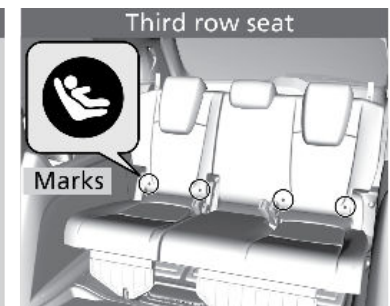
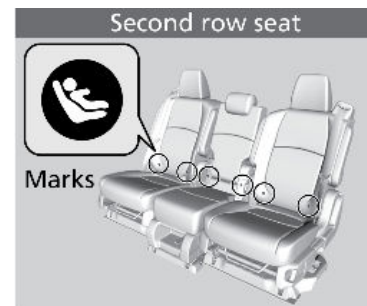

- Place the child seat on the vehicle seat, then attach the child seat to the lower anchors according to the instructions that came with the child seat. When installing the child seat, make sure that the lower anchors are not obstructed by the seat belt or any other object.

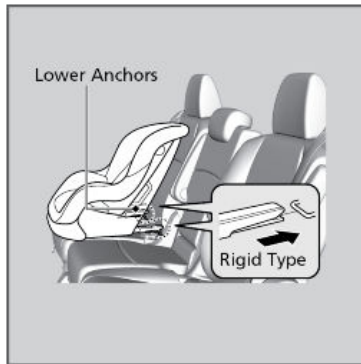

- To install a child seat in the second row center seat*¹, remove the covers on each lower end of the seat-back by pulling on the handles.

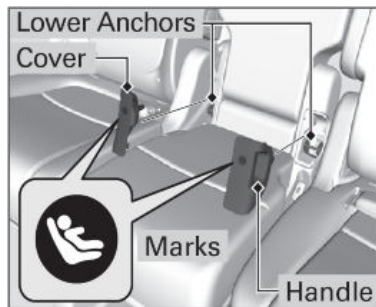

- Put the head restraint to its upper-most position, then route the tether strap outside/between the head restraint legs, and secure the tether strap hook to the anchor. Make sure the strap is not twisted.

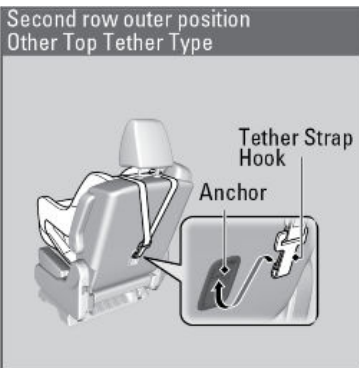
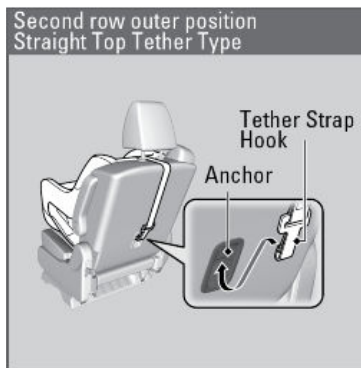

*1 - If equipped

- Tighten the tether strap as instructed by the child seat manufacturer.
- Make sure the child seat is firmly secured by rocking it forward and back and side to side; little movement should be felt.
- Make sure any unused seat belt that a child can reach is buckled, the lockable retractor is activated, and the belt is fully retracted and locked.

For your child's safety, when using a child seat installed using the LATCH system, make sure that the child seat is properly secured to the vehicle. A child seat that is not properly secured will not adequately protect a child in a crash and may cause injury to the child or other vehicle occupants.

⚠ WARNING

Never attach two child seats to the same anchor.

In a collision, one anchor may not be strong enough to hold two child seats attachments and may break, causing serious injury or death.

⚠ WARNING

Do not use the lower inner anchors of the outer rear seats to secure a LATCH-compatible child seat to the third row center seat, unless the child seat manufacturer's instructions for that system permit the use of inner anchors with the stated spacing.

Installing a LATCH-compatible child seat in the third row center seat

Each outer third row seat is equipped with a pair of lower anchors which are used to secure a LATCH-compatible child seat. The third row center seat, however, is not equipped with anchors of any kind.

The inner and outer anchors are spaced apart at a standard distance of 11 inches (280 mm).

The distance between the two inner anchors is:

- 16.0 inches (406.2 mm)

LATCH-compatible restraint systems that are fitted with rigid-type attachments cannot be installed in the third row center seat. However, a system fitted with flexible-type attachments can be installed in the third row center seat, provided that the manufacturer's instructions for that system permit the use of the inner anchors with the stated spacing.

Before seating a child, make sure that the system is properly attached to both the lower anchors and tether anchors.

■ Installing a Child Seat with a Lap/Shoulder Seat Belt

A child seat can be installed with a lap/shoulder belt in any rear seat or, if absolutely necessary, the front passenger seat.

1. Place the child seat on the vehicle seat.
2. Route the seat belt through the child seat according to the seat manufacturer's instructions, and insert the latch plate into the buckle. Insert the latch plate fully until it clicks.
3. Slowly pull the shoulder part of the belt all the way out until it stops. This activates the lockable retractor.
4. Let the seat belt retract a few inches and check that the retractor has switched modes by pulling on the webbing. It should not pull out again until it is reset by removing the latch plate from the buckle. If you are able to pull the shoulder belt out, the lockable retractor is not activated. Slowly pull the seat belt all the way out, and repeat steps 3–4.
5. Grab the shoulder part of the seat belt near the buckle, and pull up to remove any slack from the lap part of the belt. When doing this, place your weight on the child seat and push it into the vehicle seat.

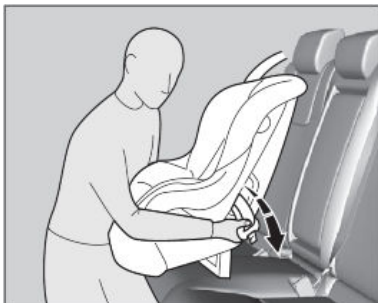

6. Make sure the child seat is firmly secured by rocking it forward and back, and side to side; less than one inch of movement should occur near the seat belt.
7. Make sure any unused seat belt that a child can reach is buckled. The lockable retractor is activated and the seat belt fully retracted and locked.



To deactivate a lockable retractor, release the buckle and allow the seat belt to wind up all the way.

■ Adding Security with a Tether

A tether anchorage point is provided behind each second and third row seating position. If you have a child restraint system that comes with a tether, but can be installed with a seat belt, the tether may be used for additional security. Always use a tether for forward facing child seats when using the seat belt or lower anchors.

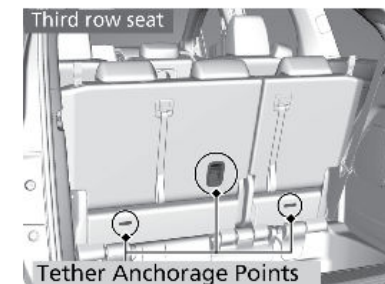
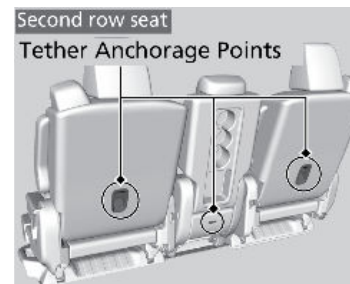

1. Locate the appropriate tether anchorage point.

2. Raise the outer head restraint to its highest position, then route the tether strap between the head restraint legs. Raise the head restraint to its highest position, then route the tether strap outside/through the head restraint legs. Make sure the strap is not twisted.

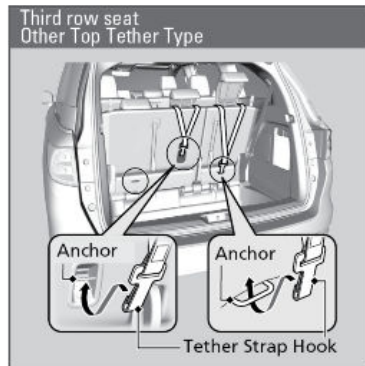
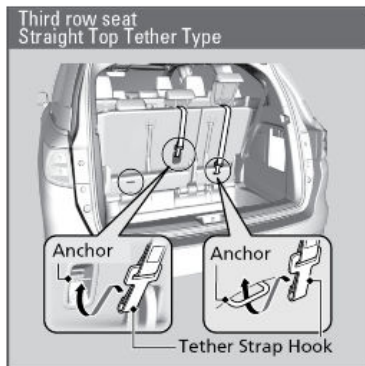
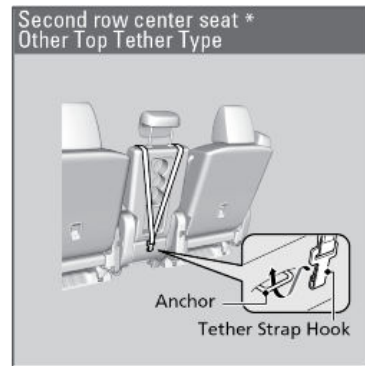
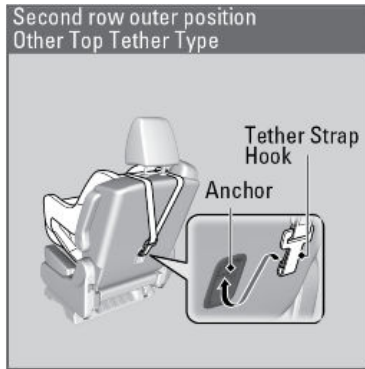
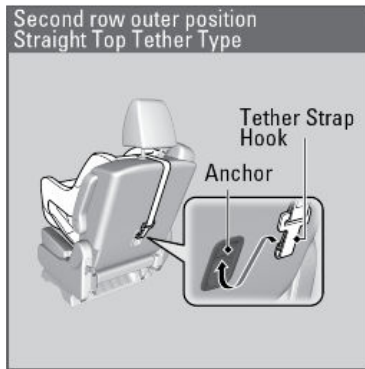

3. Secure the tether strap hook to the anchor.

4. Tighten the tether strap as instructed by the child seat manufacturer.

■ Protecting Larger Children

When a child is too big for a child seat, secure the child in a rear seat using the lap/shoulder seat belt.

Have the child sit upright and all the way back, then ensure the following:

- The child's knees bend comfortably over the edge of the seat.
- The shoulder belt crosses between the child's neck and arm.
- The lap part of the seat belt is as low as possible, touching the child's thighs.
- The child can stay seated for the whole trip.



If a lap/shoulder belt cannot be used properly, position the child in a booster seat in a rear seat. For the child's safety, check that the child meets the booster seat manufacturer's recommendations.

When installing a booster seat, make sure to read the instructions that came with it, and install the seat accordingly.

There are high- and low-type booster seats. Choose a booster seat that allows the child to wear the seat belt correctly.

Some U.S. states and Canadian provinces/territories require children to use a booster seat until they reach a given age or weight (e.g., 6 years or 60 lbs). Be sure to check current laws in the state or province/territory where you intend to drive.

⚠ WARNING

Allowing a child age 12 or under to sit in the front can result in injury or death if the passenger's front airbag inflates.

If a larger child must ride in front, move the vehicle seat as far to the rear as possible, have the child sit up properly and wear the seat belt properly, using a booster seat if needed.

Safety Label Locations

Safety labels are in the locations shown. They warn you of potential hazards that can cause serious injury or death. Read these labels carefully.

If a label comes off or becomes hard to read (except for the U.S. dashboard label which may be removed by the owner), contact a dealer for a replacement.

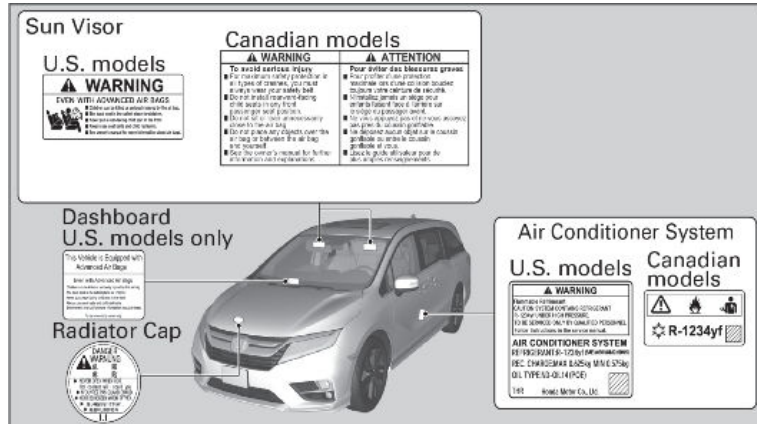

Reporting Safety Defects

In the U.S.

If you believe that your vehicle has a defect which could cause a crash or could cause injury or death, you should immediately inform the National Highway Traffic Safety Administration (NHTSA) in addition to notifying American Honda Motor Co., Inc.

If NHTSA receives similar complaints, it may open an investigation, and if it finds that a safety defect exists in a group of vehicles, it may order a recall and remedy campaign. However, NHTSA cannot become involved in individual problems between you, your dealer, or American Honda Motor Co., Inc.

To contact NHTSA, you may call the Vehicle Safety Hotline toll-free at 1-888-327-4236 (TTY: 1-800-424-9153); go to <http://www.safercar.gov>, or write to: Administrator, NHTSA, 1200 New Jersey Avenue, SE., Washington, DC 20590. You can also obtain other information about motor vehicle safety from <http://www.safercar.gov>.

In Canada

If you believe that your vehicle has a defect which could cause a crash or could cause injury or death, you should immediately inform Honda Canada, Inc., and you may also inform Transport Canada.

If Transport Canada receives similar complaints, it may open an investigation, and if it finds that a safety defect exists in a group of vehicles, it may lead to a recall and remedy campaign. However, Transport Canada cannot become involved in individual problems between you, your dealer, or Honda Canada, Inc.

To contact Transport Canada's Defect Investigations and Recalls Division, you may call 1-800-333-0510. For more information on reporting safety defects or about motor vehicle safety, go to <http://www.tc.gc.ca/roadsafety>.

INSTRUMENT PANEL

Indicators, gauges, and displays related to driving the vehicle.



Indicators briefly appear with each engine start and then go out. Red and amber indicators are most critical. Blue and green indicators are used for general information.

Malfunction Indicators

These are the most critical indicators. If they come on and stay lit while driving or at any other time, there may be a problem. See your dealer for assistance.

BRAKE
U.S.



Canada

Brake system (red)

- Comes on when the parking brake is applied, and goes off when it is released.
- Comes on when the brake fluid is low.
- Comes on if there is a problem with the brake system.
- The beeper sounds and the indicator comes on if you drive with the parking brake not fully released.
- **Comes on while driving** - Make sure the parking brake is released. Check the brake fluid level.
- **Comes on along with the ABS indicator** - Have your vehicle checked by a dealer.
- **Blinks and the brake system indicator (amber) comes on at the same time** - There is a problem with the electric parking brake system. The parking brake may not be set. Avoid using the parking brake and have your vehicle checked by a dealer immediately.

BRAKE
SYSTEM
U.S.



Canada

Brake system (amber)

- Comes on if there is a problem with the automatic brake hold system.
- Comes on if there is a problem with a system related to braking other than the conventional brake system.
- Comes on if there is a problem with the electric parking brake system.
- **Stays on constantly** - Have your vehicle checked by a dealer.
- **Comes on while driving** - Avoid using the parking brake and have your vehicle checked by a dealer immediately.



Charging system

- Comes on when the battery is not charging.
- Comes on when you set the power mode to ON, and goes off when the engine starts.
- **Comes on while driving** - Turn off the climate control system and rear defogger in order to reduce electricity consumption.



Supplemental Restraint System (SRS)

- Comes on for a few seconds when you set the power mode to ON, then goes off.

Comes on if a problem with any of the following is detected:

- Supplemental restraint system
- Knee airbag system
- Side airbag system
- Side curtain airbag system
- Seat belt tensioner
- **Stays on constantly or does not come on at all** - Have your vehicle checked by a dealer.

LKAS

Lane Keeping Assist System (LKAS) *1

There is a problem with the system.

- **Stays on constantly or does not come on at all** - Have your vehicle checked by a dealer.



Malfunction Indication Lamp (check engine light)

- Comes on when you set the power mode to ON, and goes off when the engine starts, or after several seconds if the engine did not start. If "readiness codes" have not been set, it blinks five times before it goes off.
- Comes on if there is a problem with the emissions control system.
- Blinks when a misfire in the engine's cylinders is detected.
- Readiness codes are part of the on board diagnostics for the emissions control systems.
- **Comes on while driving** - Have your vehicle checked by a dealer.
- **Blinks while driving** - Stop in a safe place where there are no flammable objects. Stop the engine for 10 minutes or more, and wait for it to cool down. Then, take your vehicle to a dealer.



Anti-lock Brake System (ABS)

There is a problem with the anti-lock brake system. Your vehicle still has normal braking ability, but no anti-lock function. Have your vehicle checked by a dealer.

- Comes on for a few seconds when you set the power mode to ON, then goes off.



Low Tire Pressure / Tire Pressure Monitoring System (TPMS)

- Comes on for a few seconds when you set the power mode to ON, then goes off.
- Comes on if the tire pressure of any of the tires becomes significantly low.
- Blinks for about one minute, and then stays on if there is a problem with the TPMS with Tire Fill Assist, or when a compact spare tire is temporarily installed.
- **Blinks and then remains on:** Have your vehicle checked by a dealer. If the vehicle is fitted with a compact spare, get your regular tire repaired or replaced and put back on your vehicle as soon as you can.



Vehicle Stability Assist™ (VSA®) System

Comes on if there is a problem with the VSA®, brake lighting system, or hill start assist system.

- **Stays on constantly** - Have your vehicle checked by a dealer.
- Comes on for a few seconds when you set the power mode to ON, then goes off.



Collision Mitigation Braking System™ (CMBS™) *1

Comes on when there is a problem with the CMBS™ system.

- **Stays on constantly without the CMBS™ off** - Have your vehicle checked by a dealer.
- Comes on if the CMBS™ is deactivated. A driver information interface message appears for five seconds.
- Comes on when the CMBS™ system shuts itself off.
- **Stays on** - The area around the camera is blocked by dirt, mud, etc. Stop your vehicle in a safe place, and wipe it off with a soft cloth.
- When the radar sensor gets dirty, stop your vehicle in a safe place, and wipe off dirt using a soft cloth. Indicator may take some time to go off after the radar sensor is cleaned.
- **Stays on** - The temperature inside the camera is too high. Use the climate control system to cool down the camera. The system activates when the temperature inside the camera cools down.



Road Departure Mitigation (RDM)

- Comes on if there is a problem with the RDM system.
- **Stays on constantly** - Have your vehicle checked by a dealer.
- Comes on when the RDM system shuts itself off.
- The area around the radar sensor is blocked by dirt, mud, etc. Stop your vehicle in a safe place, and wipe it off with a soft cloth.
- Have your vehicle checked by a dealer if the indicator does not go off even after you cleaned the area around the camera.
- **Stays on** - The temperature inside the camera is too high. Use the climate control system to cool down the camera. The system activates when the temperature inside the camera cools down.



Blind Spot Information*1

Comes on if there is a problem with the system.

- Stays on while blind spot information system is turned off.
- Comes on when mud, snow, or ice accumulates in the vicinity of sensor.
- **Comes on while driving** - Remove the obstacle in the vicinity of the sensor.
- **Comes on while driving** - Have your vehicle checked by a dealer.

*1 - If equipped

**Electric Power Steering (EPS) System**

Comes on if there is a problem with the EPS system.

- **Stays on constantly** - Have your vehicle checked by a dealer.
- Comes on for a few seconds when you set the power mode to ON, goes off when the engine starts.

**Adaptive Cruise Control (ACC)*1**

Comes on if there is a problem with ACC.

- Comes on for a few seconds when you set the power mode to ON, then goes off.
- **Comes on while driving** - Have your vehicle checked by a dealer.
- ACC has been automatically canceled.
- Comes on if anything covers the radar sensor cover and prevents the sensor from detecting a vehicle in front.
- May come on when driving in bad weather (rain, snow, fog, etc.).
- When the radar sensor gets dirty, stop your vehicle in a safe place, and wipe off dirt using a soft cloth. Indicator may take some time to go off after the radar sensor is cleaned.
- Have your vehicle checked by a dealer if the indicator does not go off even after you clean the sensor cover.

**Auto Idle Stop**

- Blinks if there is a problem with the Auto Idle Stop system. Have your vehicle checked by a dealer.
- Comes on when the Auto Idle Stop system has been turned off by the Auto Idle Stop system **OFF** button.

**Transmission System Indicator**

All the gear positions may light for several seconds, and go off.

- The indicated current gear position or all the gear positions blink if there is a problem with the transmission system and the vehicle will no longer move. Immediately stop in a safe place. Have your vehicle checked by a dealer.
- The indicated current gear selection blinks if there is a problem with the transmission system.
- Avoid sudden start and acceleration and stop in a safe place immediately. Have your vehicle checked by a dealer immediately.

Condition Indicators

These indicators may require you to perform an action.

**Parking Brake**

Release the parking brake before driving. You will hear a beep if you drive with it not fully released.



Canada

- **Comes on while driving** - Make sure the parking brake is released. Check the brake fluid level.
- **Comes on along with the ABS indicator** - Have your vehicle checked by a dealer.

**Seat Belt Reminder**

The indicator blinks and beeps sound continuously if you or your front passenger has not fastened your seat belts when you begin driving. If the indicator remains on after seat belts are fastened, see your dealer.

**Low Fuel**

Refuel as soon as possible. If the indicator blinks, there is a problem with the fuel gauge. See your dealer.

- Comes on when the fuel reserve is running low (approximately 2.9 U.S. gal/11.0 Liter left).
- Blinks if there is a problem with the fuel gauge.

**Low Tire Pressure / Tire Pressure Monitoring System (TPMS)**

Comes on if the tire pressure of any of the tires becomes significantly low.

- **Comes on while driving:** Stop in a safe place, check tire pressures, and inflate tire(s) if necessary.
- **Blinks and remains on** - Have your vehicle checked by a dealer. If the vehicle is fitted with a compact spare, get your regular tire repaired or replaced and put back on your vehicle as soon as you can.

**System Message**

Comes on along with a beep when a problem is detected. A system message on the driver information interface (DII) appears at the same time. While the indicator is on, press the (home) button, select **Warnings**, then press the **ENTER** button to see the message again.

*1 - If equipped





















Immobilizer

Your key cannot be recognized by the vehicle.

- **Blinks** - You cannot start the engine. Set the power mode to VEHICLE OFF*¹, then select the ON mode again.
- **Repeatedly Blinks** - The system may be malfunctioning. Have your vehicle checked by a dealer.
- Do not attempt to alter this system or add other devices to it. Electrical problems can occur.

On/Off Indicators

These indicators remind you when an item is on or off.

	VSA® off		Exterior lights on
	VSA® engaged (blinks)		Auto High Beam System* ¹ on
	CMBS* ¹ off		ECON mode on
	RDM* ¹ off		Automatic brake hold on
	LKAS* ¹ on		Automatic brake hold activated
	ACC* ¹ on		Auto Idle Stop on
	Turn signals/hazards on		Auto Idle Stop off
	Fog lights* ¹ on		CRUISE MAIN on* ¹
	High beams on		CRUISE CONTROL on* ¹

*1 - If equipped

*1 - If equipped

Driver Information Interface

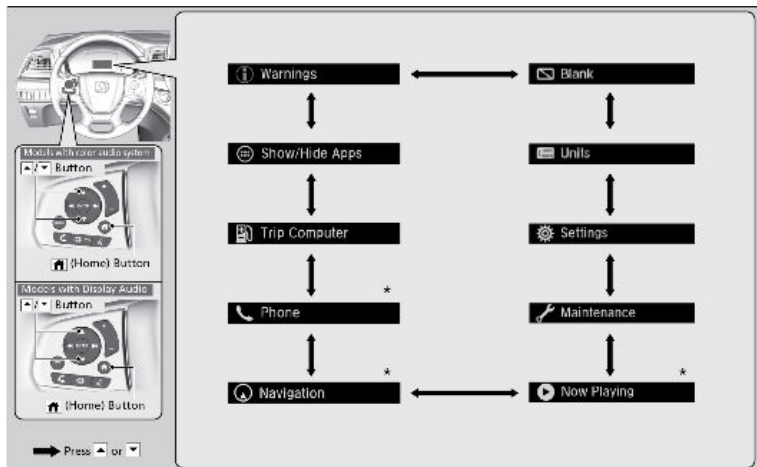

* Not available on all models

VEHICLE CONTROLS

Various controls necessary for operating and driving the vehicle.

Using the Remote Transmitter

Lock or unlock the doors, fuel fill door, and tailgate.

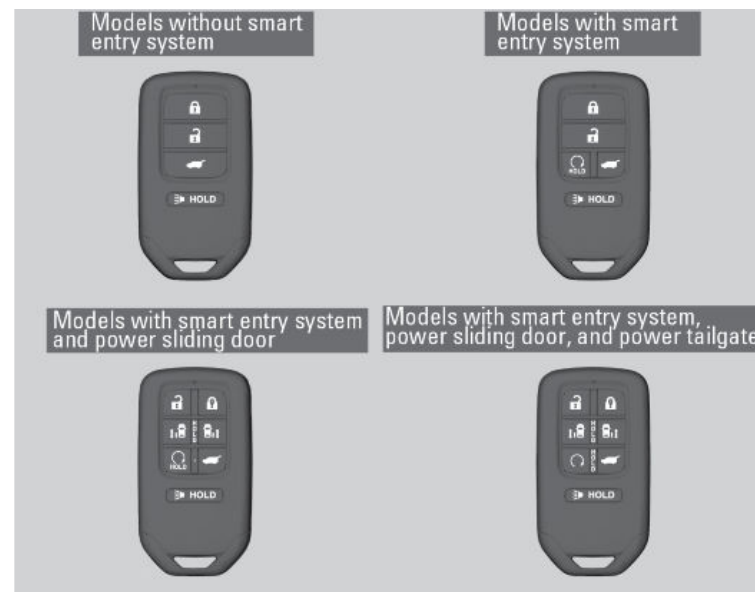

NOTICE

Leaving the remote transmitter in the vehicle can result in theft or accidental movement of the vehicle. Always take it with you whenever you leave the vehicle unattended.

Smart Entry System*1

When you carry the remote transmitter, in a pocket or purse and it is outside the vehicle and within range (about 32 inches or 80 cm), you can lock or unlock the doors, fuel fill door, and open the tailgate without handling the transmitter.

*1 - If equipped

■ Unlocking/Locking the Doors

To unlock: Grab the driver's door handle to unlock the driver's door. Grab the front passenger's door handle to unlock all the doors and the tailgate. You can customize this feature's behavior.

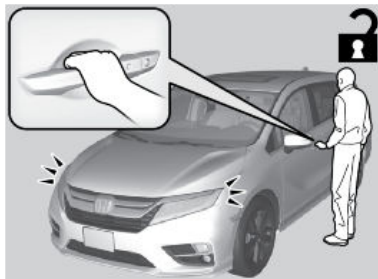

To lock: Press the door lock button on the front door or the tailgate.

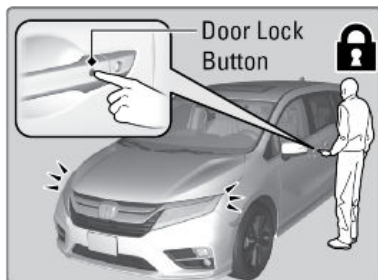

Note: System range is affected by radio signals from other devices (for example, cell phones or tablets) so for best results, carry the remote transmitter separately from these devices.

■ Customizing Door Lock and Unlock Settings

Customize the auto door lock and unlock settings to your preference.

Models with Color Audio

Using the Driver Information Interface

1. Press the **HOME** button, then select **Vehicle Settings**.
2. Select **Door Setup**.
3. Select **Auto Door Lock** or **Auto Door Unlock** to customize.

Models with Display Audio

1. Select **Home**.
2. Select **Settings**.
3. Select **Vehicle**.
4. Select **Door Setup**.
5. Select **Auto Door Lock** or **Auto Door Unlock** to customize.

■ Walk Away Auto Lock®

When you walk away from the vehicle while carrying the remote transmitter, the doors and tailgate can automatically lock if the following conditions are met:

- The remote transmitter is within a range of 5 feet (1.5 m).
- All doors and the tailgate are closed.
- There is no additional remote transmitter inside the vehicle.

Follow these steps:

1. Exit the vehicle, close the door and stay near it. Listen for a beep. The system is activated.
2. Walk at least 5 feet (1.5 m) away.
3. Listen for a beep and look for the lights to flash. The doors lock.

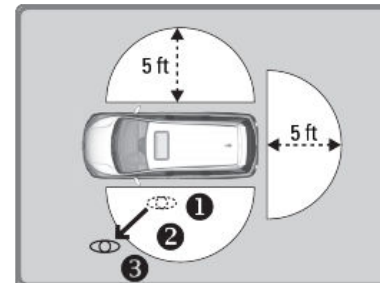

The auto lock function is set to OFF as the factory default setting. It can be set to ON using the audio/information screen. If you set the auto lock function to ON, only the remote transmitter that was used to unlock the driver's door prior to the setting change can activate auto lock. To turn on this feature, follow the steps below:

Models with Display Audio

1. Press the **HOME** button then select **Settings**.
2. Select **Vehicle**.
3. Select **Keyless Access Setup**.
4. Select **Walk Away Auto Lock®**

Door Operation

There are a few different ways of unlocking the doors from inside the vehicle.

■ Using the Lock Tab

To unlock: Pull the lock tab rearward. When you unlock either front door using the lock tab, the specific door (driver's or passenger's) unlocks.

To lock: Push the lock tab forward. When you lock the door using the lock tab on the driver's door, all the other doors and the tailgate lock at the same time. When you lock the door using the lock tab on the front passenger's door, only that door locks.

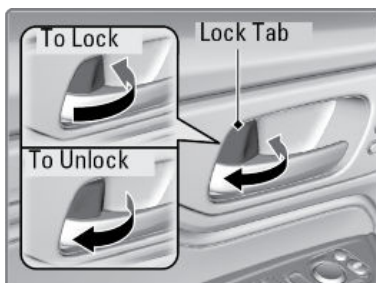

■ Using the Front Door Inner Handle

Pull the front door inner handle. The door unlocks and opens in one motion. Unlocking and opening the driver's door from the inner handle unlocks all other doors.

Do not pull a front door inner handle while the vehicle is moving.



■ Using the Master Door Lock Switch

To unlock: Press the unlock side of the switch to unlock all doors and the tailgate.

To lock: Press the lock side of the switch to lock all doors and the tailgate.

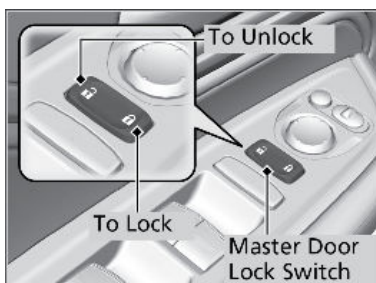

■ Childproof Door Locks

The childproof door locks prevent the rear doors from being opened from the inside regardless of the position of the lock tab.

Slide the lever in the rear door to the lock position, and close the door.

Open the door using the outer door handle.

Note: To open the door from the inside when the childproof door lock is on, put the lock tab in the unlock position, lower the rear window, put your hand out of the window, and pull the outside door handle.

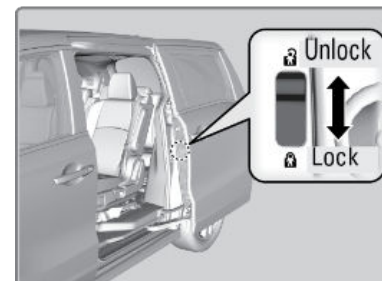

■ Precautions for Opening/Closing the Sliding Doors

Always make sure individuals and objects are clear of the sliding doors.

Open the sliding door all the way until it stops. If it is not fully opened, the sliding door may close again by its own weight.

Do not leave the sliding door open while parking on a slope. The door may slide close by its weight.

When opening or closing the sliding doors, do not grab the door or place your hand on the vehicle body. Use the handle.

Do not put your foot and hand on the sliding door rail and on the rollers.

If a small child is in the vehicle, use the childproof door locks to prevent the child in the rear seat from accidentally opening the sliding doors.

Do not put any items that stick out from the pocket in the door pockets. It may prevent the doors from properly opening or closing, and damage the vehicle.

⚠ WARNING

Closing a sliding door while any part of a passenger is in the door's path can cause serious injury.

Make sure all passengers are clear of the doorway before closing a sliding door.

■ **Opening/Closing the Sliding Doors**

From the outside, pull the outer door handle and slide the door all the way to the front or rear.

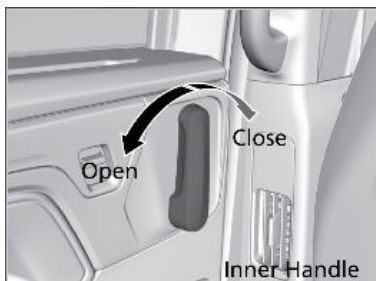
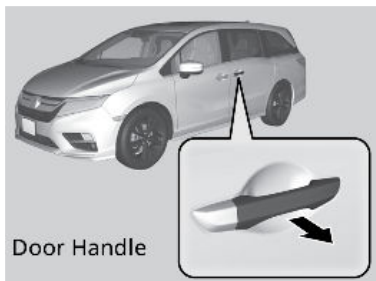

From the inside, grab the inner door handle and slide the door all the way to the front or rear.

■ **Power Sliding Doors*1**

The power sliding doors can be operated by pressing the power sliding door button on the remote, pressing the power sliding door switches on the dashboard or door pillars, or using the door handle.

The power sliding doors can be operated when:

- The power sliding door switch is **ON**.
- The power sliding door is unlocked.
- The fuel fill door is closed (for driver's side sliding door).
- The shift position is either in Park (P) or the brake pedal is depressed or the parking brake is applied.

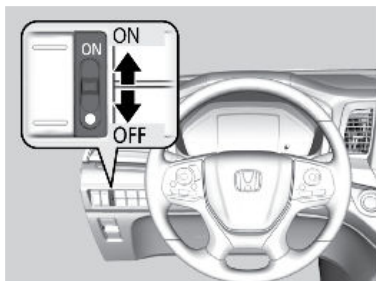

Opening/Closing the Power Sliding Doors

Press **OPEN** on the power sliding door button for the desired door side.

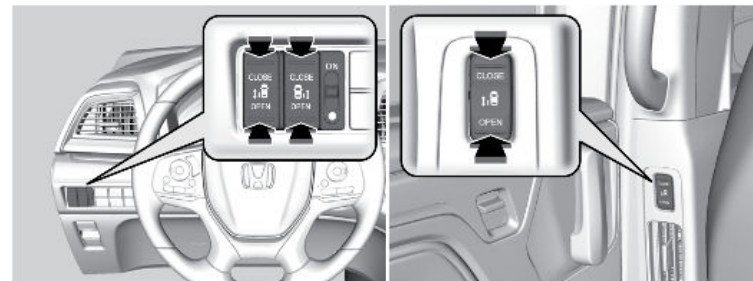

Press **CLOSE** to close the door.

While a power sliding door is in operation, you can press the button again to stop it from opening or closing. Press the button again to resume operation.

A sliding door will not open fully if the window is open more than 5 inches (13 cm). Close the door, close the window, and open the door again.

The driver's side sliding door will not open if the fuel fill door is opened.

Note: Closing a power sliding door on someone's hand or fingers can cause serious injury. Some parts of the door edge do not sense resistance when the door is near closing.

⚠ WARNING

Closing a sliding door while any part of a passenger is in the door's path can cause serious injury.

Make sure all passengers are clear of the doorway before closing a sliding door.

Tailgate Operation

Use these methods to operate the tailgate.

■ **Precautions for Opening/Closing the Tailgate**

Always make sure individuals and objects are clear of the tailgate before opening or closing it.

The power tailgate can be opened/closed when the transmission is in Park (P).

NOTICE

Do not push or pull on the power tailgate when it is being automatically opened or closed. Forcibly opening or closing the power tailgate while in operation can deform the tailgate frame.

When operating the power tailgate, make sure there is enough space around your vehicle. People near the tailgate may be seriously hurt if the

*1 - If equipped

tailgate hits or closes on their heads. Be especially cautious if children are around.

■ **Power Tailgate Button**

To open or close the power tailgate, press the power tailgate button for about one second.

If you press the button again while the power tailgate is moving, the power tailgate will stop and reverse direction.

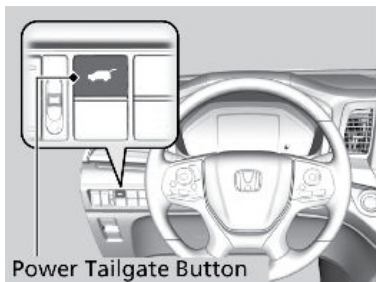

■ **Power Tailgate Outer Handle**

Automatic Operation

If you press and hold the outer handle of the tailgate for no longer than one second, the tailgate opens automatically.

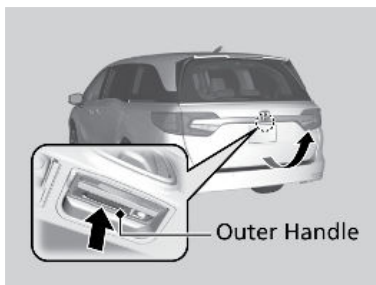

Manual Operation

To open the tailgate manually, press the outer handle for more than one second.

■ **Programmable Tailgate Position**

You can set the maximum opening of the tailgate to suit your needs.

1. Manually adjust the tailgate to your desired position.
2. Press and hold the tailgate inner button until you hear one long and two short beeps.

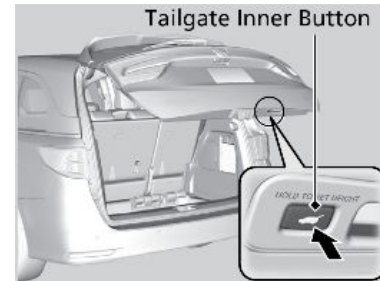

■ **Power Tailgate Inner Button**

Press the button on the tailgate to close the power tailgate.

If you press the button again while the power tailgate is moving, the power tailgate will stop and reverses direction.

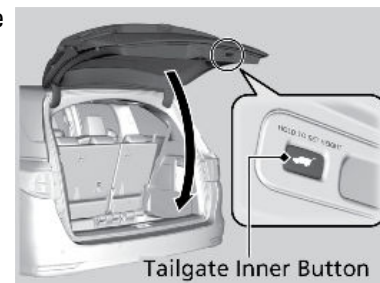

■ **Hands-Free Access Power Tailgate*1**

Use a forward and back kicking motion under the center of the rear bumper to open or close the power tailgate while carrying the smart entry remote. Some exterior lights flash twice and a beep sounds once, then the tailgate begins to move.

Note: This function will not operate if you don't have the smart entry remote on you. Please make sure you have the smart entry remote on you.

During rain or in other instances when the vehicle becomes wet, the sensor may not properly detect your foot motion.

The duration of the kicking motion should be approximately one second.

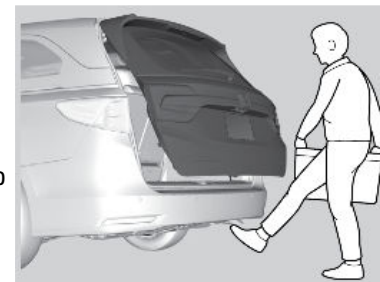

Power Window Operation

Power windows can be opened and closed by using the switches on the doors when the vehicle is on. The switches on the driver's side can be used to open and close all the windows.

Automatic Operation

To open: Push the switch down firmly.

To close: Pull the switch up firmly.

The window opens or closes completely. To stop the window at any time, push or pull the switch again briefly.

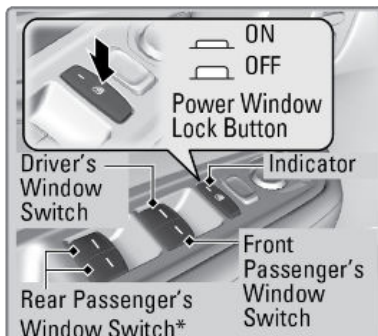

Manual Operation

To open: Push the switch down lightly.

To close: Pull the switch up lightly.

Release the switch when the windows reach the desired position.

Power Window Lock

Push in the power window lock button so only the driver's window can be operated.

Auto Reverse

If a power window senses resistance when closing automatically, it will stop closing and reverse direction. The driver's window auto reverse function is disabled when you continuously pull up the switch. The auto reverse function stops sensing when the window is almost closed to ensure that it fully closes.

⚠ WARNING

Closing a power window on someone's hands or fingers can cause serious injury.

Make sure your passengers are away from the windows before closing them.

Power Moonroof*¹ Operation

The moonroof can be opened and closed when the vehicle is on by using the switch on the ceiling.

Automatic Operation

To open: Firmly pull the switch back.

To close: Firmly push the switch forward.

The moonroof will automatically open or close all the way. To stop the moonroof at any time, push the switch briefly.

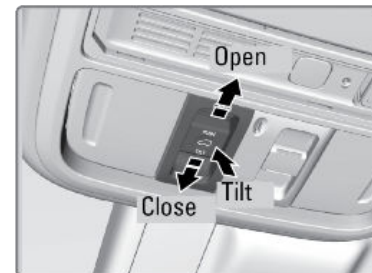

Manual Operation

To open: Push down on the switch lightly, and hold it until the desired position is reached.

To close: Pull the switch up lightly, and hold it until the desired position is reached.

Moonroof Tilt

To tilt: Push the center of the switch.

To close: Push the switch forward firmly, then release.

NOTICE

Opening the moonroof in below freezing temperature or when it is covered with snow or ice can damage the moonroof panel or motor.

⚠ WARNING

Opening or closing the moonroof on someone's hands or fingers can cause serious injury.

Make sure all hands and fingers are clear of the moonroof before opening or closing it.

Interior and Exterior Lights

Operate interior and exterior lights when the vehicle is on or off.

Brightness Control

Adjust instrument panel brightness when the vehicle is on.

To brighten: Turn the knob to the right.

To dim: Turn the knob to the left.

A beep sounds when the brightness reaches its minimum or maximum.

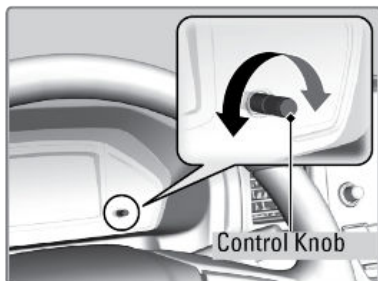

Interior Lights

Change the interior light settings using the switches on the ceiling.

ON position: The interior lights come on regardless of whether the doors are open or closed.

Door-activated position: Interior lights come on when any of the doors are opened, the driver's door is unlocked, or the vehicle is turned off.

OFF position: The interior lights remain off regardless of whether the doors are open or closed.

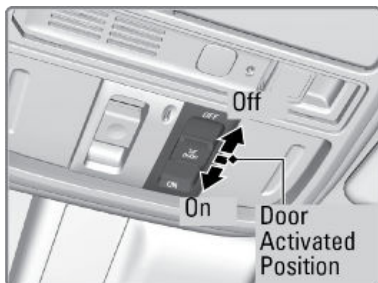

Map Lights

Press the map light lenses to turn on or off.



Press the second or third row map lights to turn on or off when the front interior light switch is in the door-activated position.

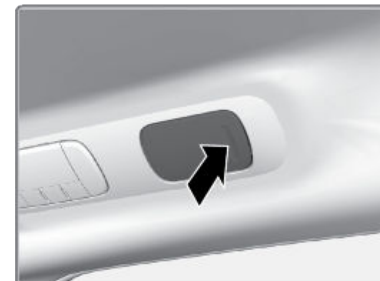

Exterior Lights

Rotate the switches on the lever to operate the exterior lights.

Push the lever forward to turn on the high beams.

Return the lever to its original position for low beams.

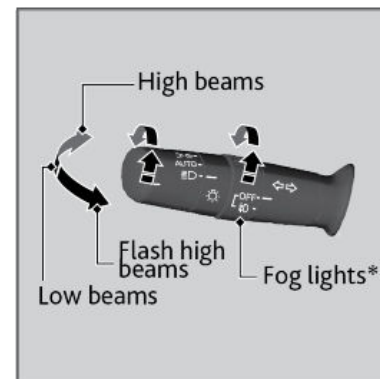

* Not available on all models

OFF: All exterior lights are off.

 Turn on exterior lights except headlights.

AUTO: Turn on the automatic lighting feature. Headlights turn on or off depending on ambient brightness when the vehicle is on. Headlights automatically come on after the wipers are engaged for a certain time. The headlights come on when you unlock a door in dark areas with the headlight switch in AUTO.

 Turn on all exterior lights including headlights.

 Turn fog lights*¹ on or off.

■ Cargo Area Light

Located on the rear ceiling in front of the tailgate.

Tailgate activated: The light comes on when you open the tailgate, and goes off when closed.



One-Touch Turn Signal

Use this quick and convenient method to signal a lane change.

Lightly push the turn signal lever up or down for an automatic three-blink sequence.

For a continuous signal, push the lever up or down until it locks into place.

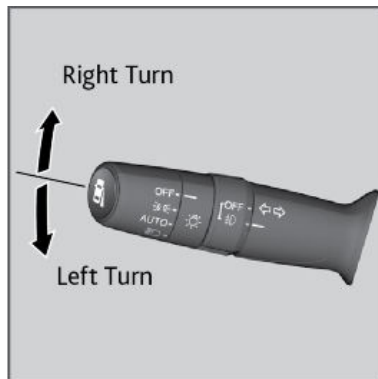

Auto High Beam

The front sensor camera detects the light sources ahead of the vehicle such as the lights of a preceding or oncoming vehicle, or street lights. When you are driving at night, the system automatically switches the headlights between low beam and high beam depending on the situation.

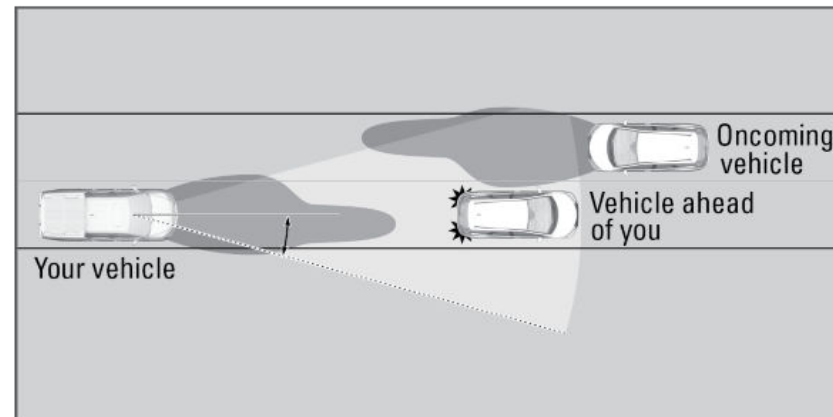

For the system to work properly:

- Do not place an object that reflects light on the dashboard.
- Keep the windshield around the camera clean. When cleaning the windshield, be careful not to apply windshield cleanser to the camera lens.
- Do not attach an object, sticker or film in the area around the camera.
- Do not touch the camera lens.

If the camera receives a strong impact or requires repair in the area near the camera, consult a dealer.

If the **Some Driver Assist Systems Cannot Operate: Camera Temperature Too High** message appears:

- Use the climate control system to cool down the interior and, if necessary, also use defroster mode with airflow directed toward the camera.
- Start driving the vehicle to lower the windshield temperature, which cools down the area around the camera.

If the **Some Driver Assist Systems Cannot Operate: Clean Front Windshield,** message appears:

- Park your vehicle in a safe place, and clean the windshield. If the message does not disappear after you have cleaned the windshield and driven for a while, have your vehicle checked by a dealer.

■ Automatically switching between high beam and low beam

When auto high beam is active, the headlights switch between high beam and low beam based on the following conditions.

Switching to high beam

All of the following conditions must be met before the high beams turn on.

- Your vehicle speed is 45 mph (72 km/h) or more.
- There are no preceding or oncoming vehicles with headlights or taillights turned on.
- There are few street lights on the road ahead.

Switching to low beam

One of the following conditions must be met before the low beams turn on.

- Your vehicle speed is 30 mph (48 km/h) or less.
- There is a preceding or oncoming vehicle with headlights or taillights turned on.
- There are many street lights on the road ahead.

■ Manually switching between high beam and low beam

If you want to manually switch the headlights between high beam and low beam, follow either of the procedures below. Note that when you do this, the auto high beam indicator will turn off and the auto high-beam will be deactivated.

Using the lever: Pull the lever toward you for flashing the high beams then release it within about one second while driving. To reactivate, pull the lever toward you for flashing the high beams then release it while driving. The auto high beam indicator will come on.

Using the light switch: Turn the light switch to . To reactivate, turn the light switch to **AUTO** when the lever is in the low beam position, the auto high beam indicator will come on.

■ Turning the System On or Off

Make sure the headlight lever is in the low beam position with the switch rotated to the AUTO position. The auto high beam system indicator comes on.

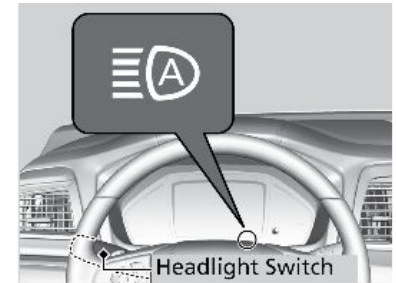

To turn the system on: Pull and hold the headlight lever toward you for about 30 seconds, until the indicator flashes once.

To turn the system off: Pull and hold the headlight lever toward you for about 40 seconds, until the indicator flashes twice.

Wiper Operation

The windshield wipers and washers can be used when the vehicle is on.

■ Front Wipers

Move the wiper lever up or down to the desired position.

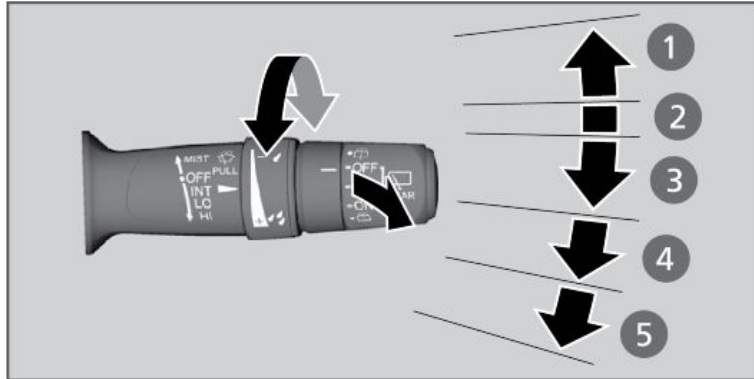

- | | |
|--|------------------------|
| 1. MIST | 4. LO: Low speed wipe |
| 2. OFF | 5. HI: High speed wipe |
| 3. INT ^{*6} /AUTO ^{*7} | |

■ Headlight Integration with Wipers

When the headlights are in the **AUTO** position, they automatically turn on when the front wipers operate several times within a certain interval. The headlights turn off shortly after the wipers are turned off or if there is enough ambient light.

^{*6} - Without automatic intermittent wipers
^{*7} - With automatic intermittent wipers

■ Intermittent (INT) Wipers^{*1}

When you move the lever to the INT position, the wipers operate based on the delay adjustment.

Rotate the adjustment ring to adjust the wiper delay.

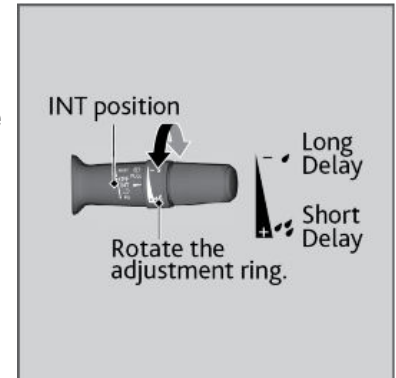

■ Automatic Intermittent Wipers^{*1}

When you push the lever down to **AUTO**, the windshield wipers sweep once, and go into the automatic mode.

The wipers operate intermittently, at low speed, or at high speed and stops in accordance with the amount of rainfall the rainfall sensor detects.

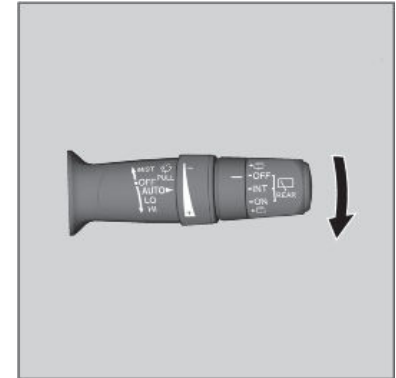

NOTICE

AUTO should always be turned **OFF** before the following situations in order to prevent severe damage to the wiper system:

- Cleaning the windshield
- Driving through a car wash
- No rain present

^{*1} - If equipped

Adjusting the Front Seats

Always make seat adjustments before driving.

Adjust the driver's seat as far back as possible while allowing you to maintain full control of the vehicle. You should be able to sit upright and well back in the seat, adequately press the pedals without leaning forward, and grip the steering wheel comfortably. The passenger's seat should be adjusted so that it is as far back from the front airbag in the dashboard as possible.

The National Highway Traffic Safety Administration and Transport Canada recommend that drivers allow at least 10 inches (25 cm) between the center of the steering wheel and the chest.

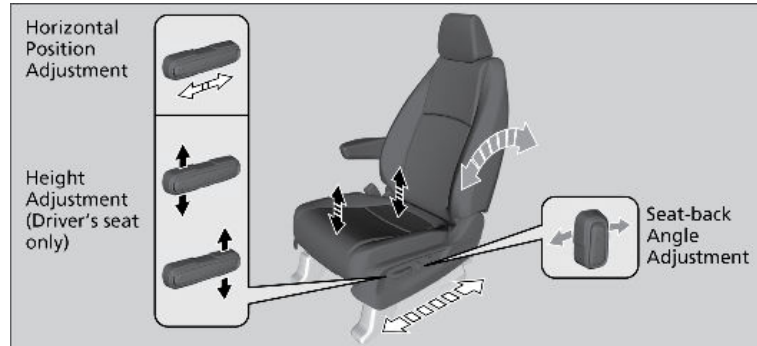
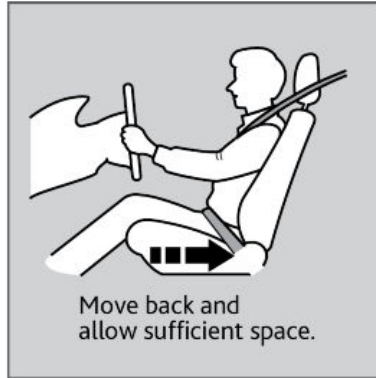

⚠ WARNING

Sitting too close to a front airbag can result in serious injury or death if the front airbags inflate.

Always sit as far back from the front airbags as possible while maintaining control of the vehicle.

■ Adjusting the Seat-Backs

Adjust the driver's seat-back to a comfortable, upright position, leaving ample space between your chest and the airbag cover in the center of the steering wheel.

The front seat passenger should also adjust their seat-back to a comfortable, upright position.

Do not put a cushion, or other object, between the seat-back and your back. Doing so may interfere with proper seat belt or airbag operation.

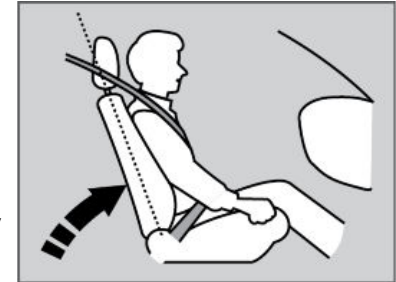

⚠ WARNING

Reclining the seat-back too far can result in serious injury or death in a crash.

Adjust the seat-back to an upright position, and sit well back in the seat.

Driving Position Memory System*1

You can store two driver's seat and door mirror positions with the driving position memory system (except for power lumbar).

When the driver's door is unlocked, and you open the driver's door with a remote transmitter, door mirrors adjust to one of the two preset positions and the seat adjusts to retracted positions of one of the two preset positions automatically.

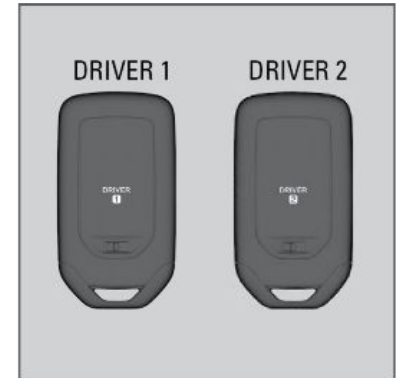

■ **Storing a Position in Memory**

1. Set the power mode to ON. Adjust the driver's seat and mirrors to the desired position.

2. Press the **SET** button.

You will hear a beep, and the memory button indicator light will blink.

3. Press and hold memory button 1 or 2 within 5 seconds of pressing the **SET** button.

You will hear two beeps, and the indicator light on the button you pressed stays on once the seat, the steering wheel, and the outside mirror positions have been memorized.

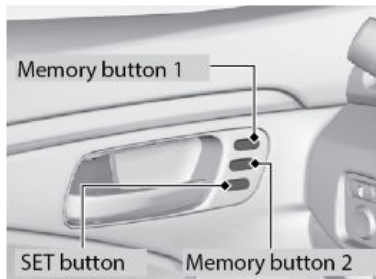

Adjusting the Head Restraints

Your vehicle is equipped with head restraints in all seating positions. Head restraints are most effective for protection against whiplash and other rear-impact crash injuries when the center of the back of the occupant's head rests against the center of the restraint. The tops of the occupant's ears should be level with the center height of the restraint.

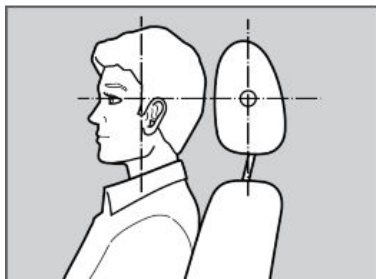

For a head restraint system to work properly:

- Do not hang any items on the head restraints or from the restraint legs.
- Do not place any objects between an occupant and the seat-back.
- Install each restraint in its proper location.

⚠ WARNING

Improperly positioning head restraints reduces their effectiveness and increases the likelihood of serious injury in a crash.

Make sure head restraints are in place and positioned properly before driving.

■ **Adjusting the Front and Second Row Outer and Third Row Outer Head Restraints Positions**

To raise: Pull it upward.

To lower: Push it down while pressing the release button.

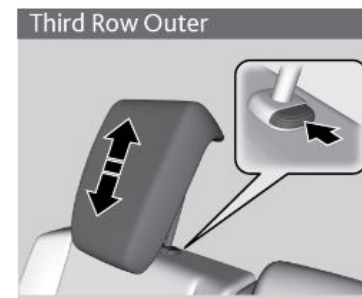
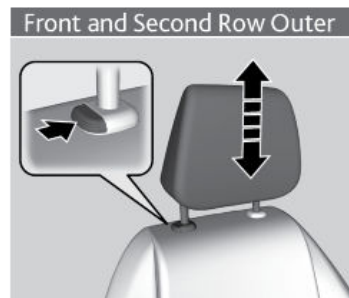

■ **Changing the Second Row*1/Third Row Center Seat Head Restraint Positions**

To raise: Pull it upward.

To lower: Push it down while pressing the release button.

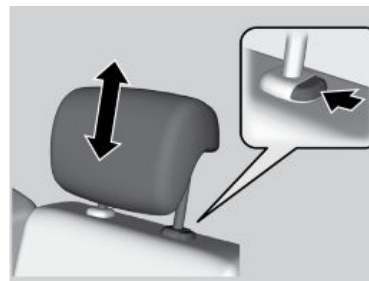

■ **Removing and Reinstalling the Head Restraints**

Head restraints can be removed for cleaning or repair.

To remove: Pull the restraint up as far as it will go. Then push the release button, and pull the restraint up and out.

To reinstall: Insert the legs back in place, then adjust the head restraint to an appropriate height while pressing the release button. Pull up on the restraint to make sure it is locked in position.

⚠ WARNING

Failure to reinstall, or correctly reinstall, the head restraints can result in severe injury during a crash.

Always replace the head restraints before driving.

Maintain a Proper Seating Position

After all occupants have adjusted their seats and head restraints, and put on their seat belts, it is very important that they continue to sit upright, well back in their seats, with their feet on the floor, until the vehicle is safely parked and the engine is off.

Sitting improperly can increase the chance of injury during a crash. For example, if an occupant slouches, lies down, turns sideways, sits forward, leans forward or sideways, or puts one or both feet up, the chance of injury during a crash is greatly increased.

In addition, an occupant who is out of position in the front seat can be seriously or fatally injured in a crash by striking interior parts of the vehicle or being struck by an inflating front airbag.

⚠ WARNING

Sitting improperly or out of position can result in serious injury or death in a crash.

Always sit upright, well back in the seat, with your feet on the floor.

Glove Box

Pull the handle to open the glove box. You can lock the glove box with the built-in key.

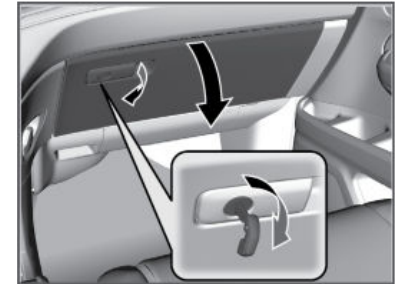

⚠ WARNING

An open glove box can cause serious injury to your passenger in a crash, even if the passenger is wearing the seat belt.

Always keep the glove box closed while driving.

Adjusting the Rear Seats

■ **Adjusting the Second Row Seats**

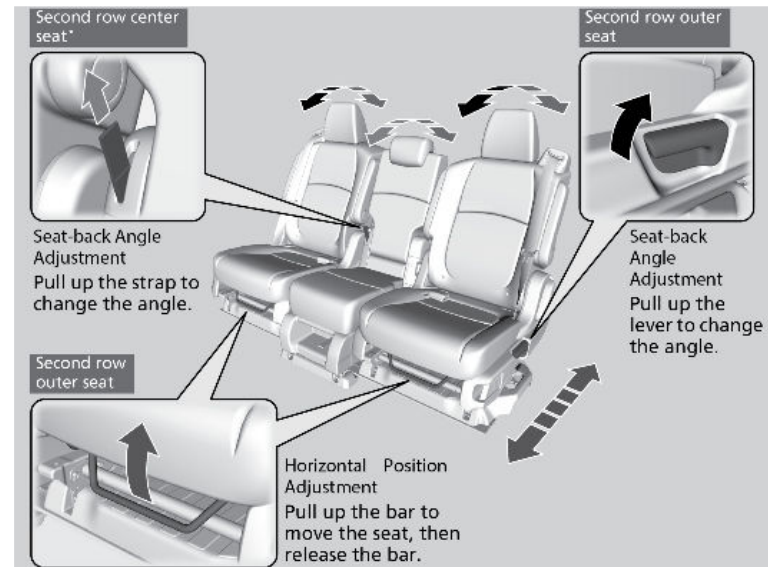

⚠ WARNING

An unsecured seat or seat-back can move out of position or collapse without warning if there is sudden acceleration or stop or in a crash. A seat or seat-back that suddenly moves or collapses can result in severe injury or death. Always make sure all seats and seat-backs are securely locked into position before driving.

Ensuring seats are locked into place:

Once the desired seat position and seat-back angles are made, rock the seat back and forth to make sure they are locked into position. There should be no movement.



■ **Adjusting the Third Row Seats**

Pull up the right strap to change the angle of the right seat back or the left strap for the left and center seat backs.

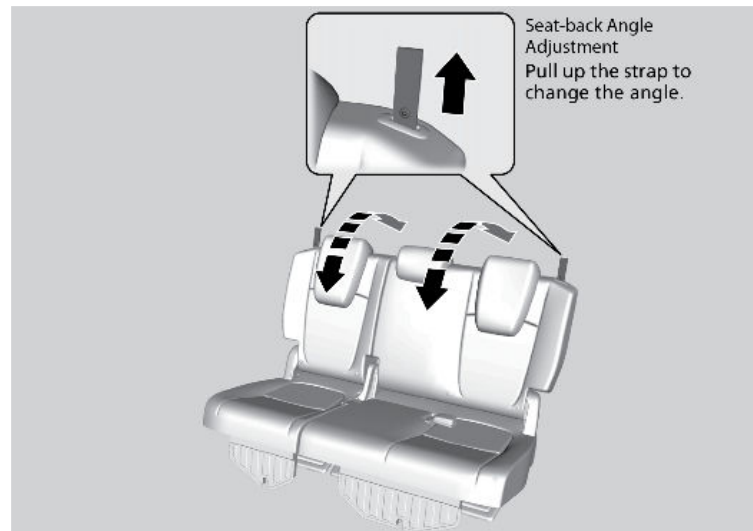

■ **Removing the Second Row Center Seat*1**

The second row center seat can be removed to increase storage, cargo space, or passenger mobility.

1. Store the center seat belt.
2. Release the center seat belt detachable anchor (insert a key into the slot on the side of the anchor buckle) and retract the seat belt into the holder on the ceiling.
3. Pull up the adjustment strap and fold down the seat back.
4. Pull the lock release strap under the seat cushion and hold the seat back while lifting the rear of the seat.
5. Pull the seat back slightly, then pivot it upward to unhook the front of the seat from the floor.

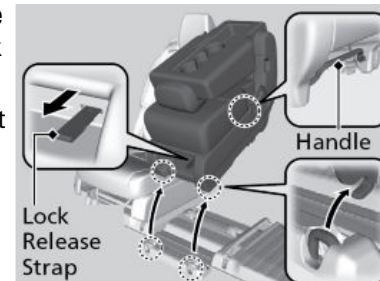

6. Remove the seat.

To reinstall the seat: First hook the front of the seat to the floor. After confirming both the front hooks are fully inserted into the front strikers, begin to lower the seat, then allow it to drop and lock to the rear floor

*1 - If equipped

strikers. Raise the seat-back to an upright position, then rock the seat back and forth to confirm both the rear latches are securely locked into position.

■ **Removing a Second Row Outer Seat**

Follow the steps below to remove either of the second row outer seats:

1. Remove the head restraint.
2. Move the seat to its rearmost position.
3. Pull the seat-back angle adjustment lever, then fold the seat-back forward.

4. Pull the lock release lever, tilt the seat-back forward and lift the rear of the seat. To lift the seat, grab the handle under the rear side of the seat.

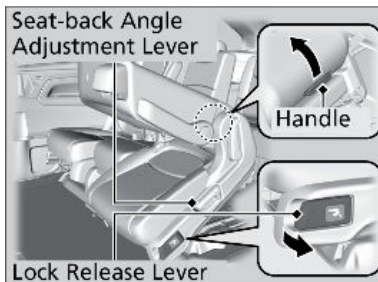

5. Pivot the rear of the seat upward to unhook the front of the seat from the floor.

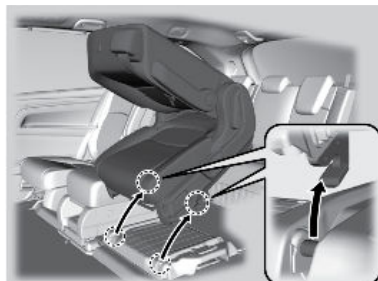

6. Remove the seat.

To reinstall the seat: With the seat-back folded forward, insert the front seat hooks into the front floor strikers. After confirming both front hooks are fully inserted into the front strikers, begin to lower the seat, then allow it to drop and lock to the rear floor strikers.

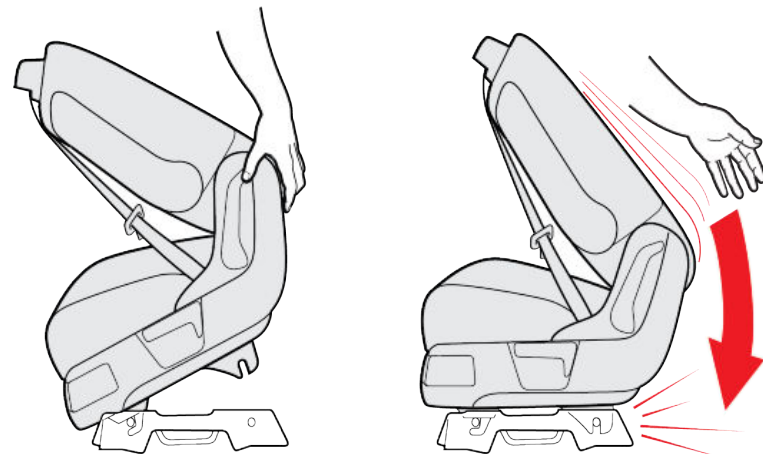

Install the head restraints, then raise the seat-back to an upright position, then rock the seat back and forth to confirm both the inner and outer latches are securely locked into position.

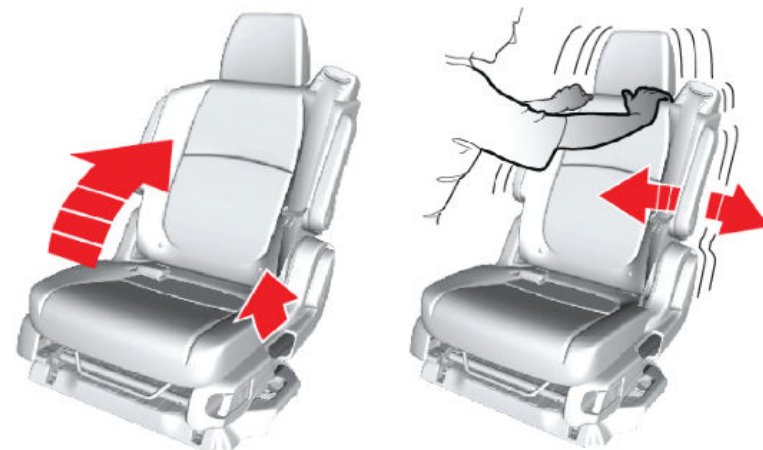

■ **Sliding the Second Row Magic Slide™ Seats*1**

With the second row center seat removed, the second row outer seats can be moved in or out. Pull up the handle at the side of the seat, then slide the seat.



■ **Third Row Seat Access**

1. Pull forward on the walk-in lever or pull the release strap to tilt the second row outer seat forward. Slide the whole seat forward.
2. When re-positioning the seat, push it firmly to the rear to ensure the horizontal adjusters and the seat-back lock completely into place.

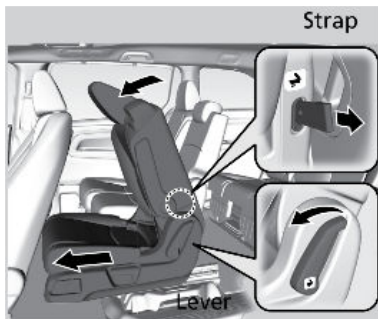

■ **Storing the One-Motion Third Row Magic Seat®**

You can store the third row seats to create a flat cargo area.

1. Release the center seat belt detachable anchor (insert a key into the slot on the side of the anchor buckle) and retract the seat belt into the holder on the ceiling.
2. Lower the head restraints to their lowest positions.
3. Pull one of the straps to release the leg lock. Keep pulling to tuck the seats and straps into the cargo area.

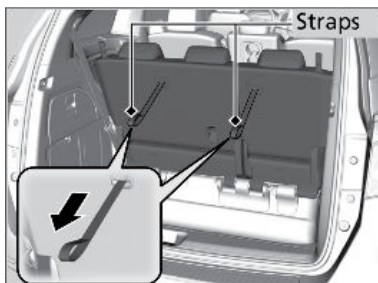

To return the seat to the upright position:

1. Grab the handle, pull up the folded seat and pivot it forward, then allow it to drop into position.



2. The front leg latches when it contacts the floor striker. Pull the strap to put the seat-back(s) upright.

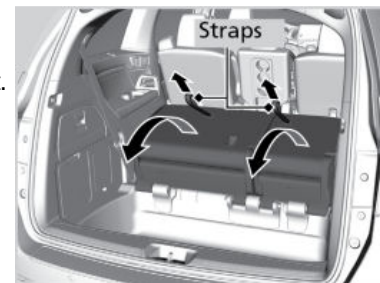

Ensuring seats are locked into place:

Once the desired seat position and seat-back angles are made, rock the seat back and forth to make sure they are locked into position. There should be no movement.

■ **Folding Down the Rear Seats**

Make sure all items in the cargo area or items extending to the third row seats are properly secured. Loose items can fly forward if you have to brake hard.

*1 - If equipped

Floor Mats

The front and second row passenger's floor mats hook over the floor anchors, which keep them from sliding forward. To remove a mat for cleaning, turn the anchor knobs to the unlock position. When reinstalling, the mat after cleaning, turn the knobs to the lock position.

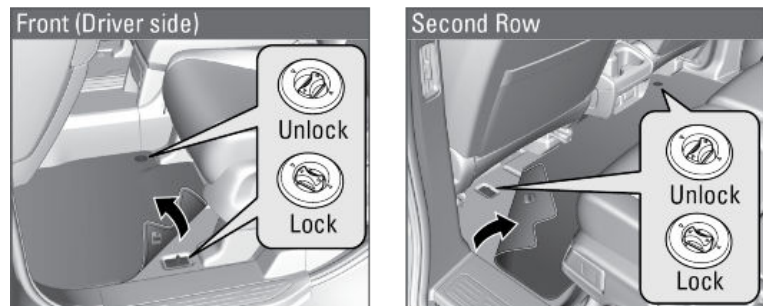

Do not put additional floor mats on top of the anchored mats.

Adjusting the Steering Wheel

The steering wheel height and distance from your body can be adjusted so that you can comfortably grip the steering wheel in an appropriate driving posture.

1. Push down the steering wheel adjustment lever. The steering wheel adjustment lever is under the steering column.
2. Move the steering wheel up or down, and in or out. Make sure you can see the instrument panel gauges and indicators.
3. Pull up on the steering wheel adjustment lever to lock the steering wheel in position. After adjusting the position, make sure you have securely locked the steering wheel in place by trying to move it up, down, in, and out.

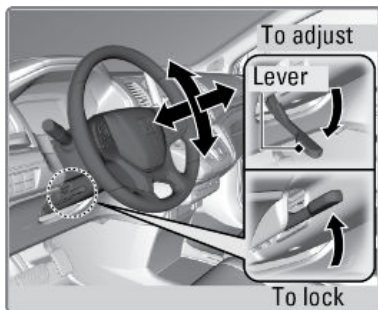

⚠ WARNING

Adjusting the steering wheel position while driving may cause you to lose control of the vehicle and be seriously injured in a crash.

Adjust the steering wheel only when the vehicle is stopped.

Adjusting the Mirrors

Adjust the angle of the mirrors for the best visibility when you are sitting in the correct driving position.

■ Rearview Mirror with Day/Night Positions*1

Manually adjust the position to reduce headlight glare from vehicles behind you. Flip the tab to switch between day and night positions.

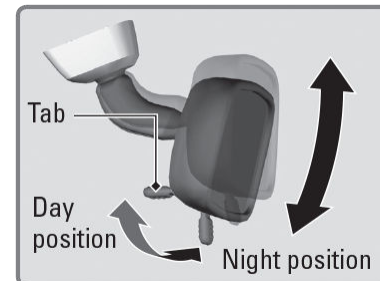

■ Automatic Dimming Rearview Mirror*1

The automatic dimming function reduces glare in the rearview mirror from headlights behind you. Press the AUTO button to turn this function on and off. This function cancels when the transmission is in Reverse (R).

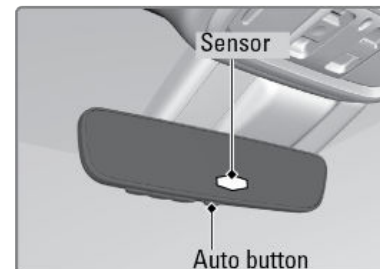

■ Power Door Mirrors

You can adjust the door mirrors when the power mode is in ON.

L/R selector switch: Select the left or right mirror. After adjusting the mirror, return the switch to the center position.

Mirror position adjustment switch: Press the switch left, right, up, or down to move the mirror.

Folding door mirrors*1 button: Press to fold the door mirrors in and out.

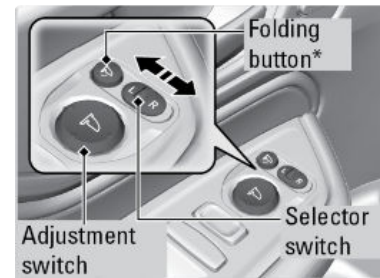

*1 - If equipped

■ **Reverse Tilt Door Mirrors*1**

If activated, either side door mirror automatically tilts downward when you put the transmission into R (Reverse); this improves close-in visibility on the selected side of the vehicle when backing up. The mirror automatically returns to its original position when you take the transmission out of R (Reverse).

To activate this feature, set the power mode to ON and slide the selector switch to the left or right side.



HomeLink® Universal Transceiver*1

Program your vehicle to operate up to three remote-controlled devices around your home (such as garage doors, lighting, or home security systems) using the buttons on the bottom of the rearview mirror.

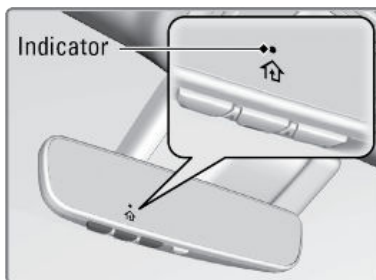

■ **Training a Button**

Park near the system you want to program, and follow the instructions below.

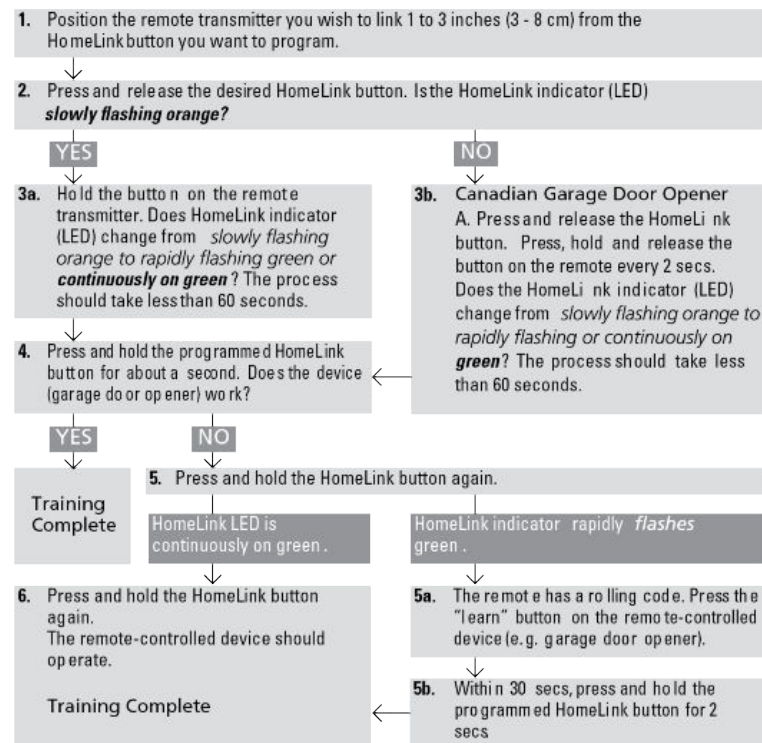

To retrain a button or erase codes, see the Owner's Manual at owners.honda.com (U.S.) or honda.ca (Canada). If you need help, call HomeLink at (800) 355-3515 or visit www.homelink.com.

Climate Control System

The automatic climate control system maintains the interior temperature you select. The system also selects the proper mix of heated or cooled air that raises or lowers the interior temperature to your preference as quickly as possible.

Models with Auto Idle Stop - During idle-stops, air-conditioning is suspended, and only the blower remains active.

If you do not want air-conditioning suspended, press the Auto Idle Stop **OFF** button to cancel idle-stop. (See Auto Idle Stop)

*1 - If equipped

■ Front Operation - Climate Control System

Automatic Climate Control - Dual Zone Climate Control System

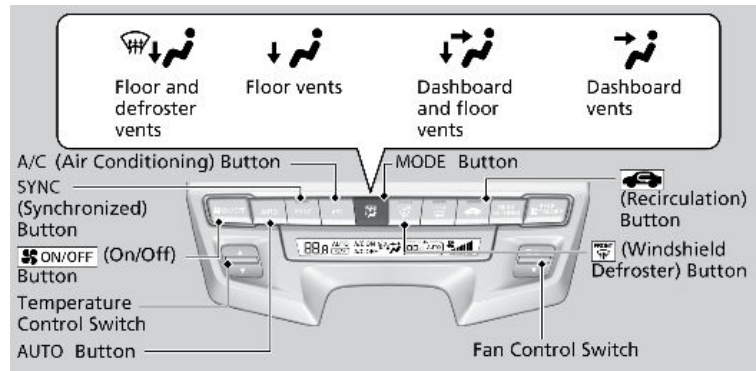

Automatic Climate Control - Tri-Zone Climate Control System

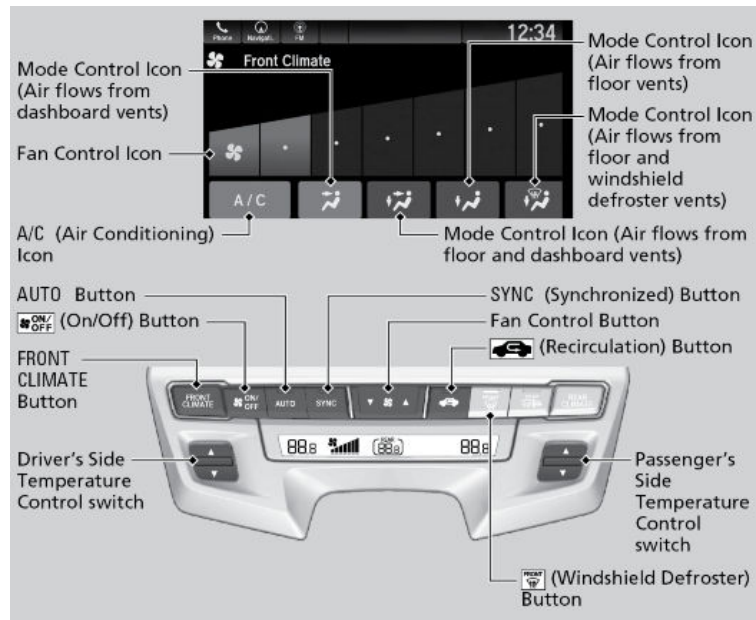

■ Rear Operation

Rear Operation from the Front Panel - Tri-zone Climate Control System

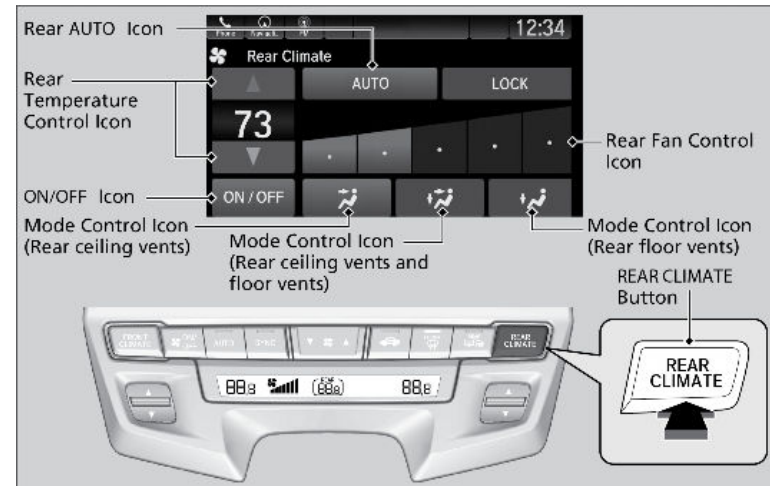

Rear Operation from the Rear Panel - Tri-zone Climate Control System

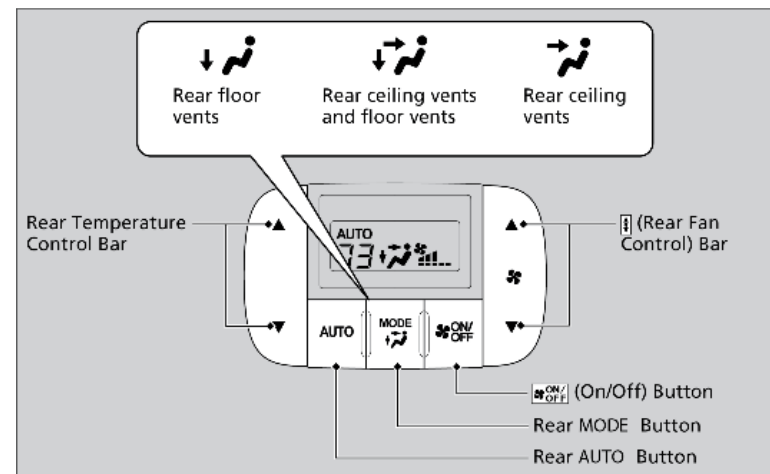

■ **Heated Windshield Button*3**

Press the heated windshield button to deice the windshield at the wiper park area and along the driver side edge of the windshield when the power mode is in ON. The heated windshield will automatically switch off after 15 minutes.

When the power mode is set to ON and the outside temperature is below 39°F (4°C), the heated windshield may automatically activate. The system deactivates itself once the outside temperature reaches 43°F (6°C).

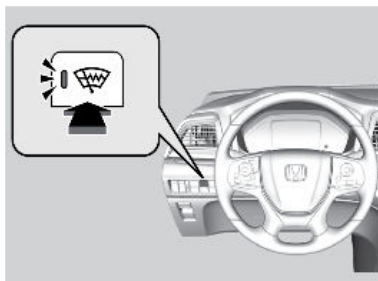

■ **Heated Steering Wheel*1**

The power mode must be in ON to use the heated steering wheel. Press the button on the right side of the steering wheel. The heated steering wheel is turned off every time you start the engine, even if you turned it on the last time you drove the vehicle.



Front Seat Heaters*1 and Ventilation*1

Press the seat heater or the seat ventilation button to cycle through settings. The appropriate indicator (red for heat, blue for ventilation) appears for each setting.

- Once - The HI setting (three indicators on)
- Twice - The MID setting (two indicators on)
- Three times - The LO setting (one indicator on)
- Four times - The OFF setting (no indicators on)

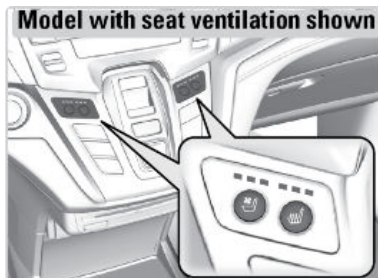

After a certain period of time, the strength setting for the seat heaters will automatically be reduced by one level at a time

*3 - Canadian models only
*1 - If equipped

until the seat heater shuts off. The elapsed time varies according to the interior environment.

⚠ WARNING

Heat-induced burns are possible when using seat heaters.

Persons with a diminished ability to sense temperature (e.g., persons with diabetes, lower-limb nerve damage, or paralysis) or with sensitive skin should not use the seat heaters.

Customized Features

When you customize settings, make sure that the vehicle is at a complete stop and shift to Park (P) and the power mode set to ON to select Vehicle Settings. Use the interface to make and enter selections.

Models with Color Audio

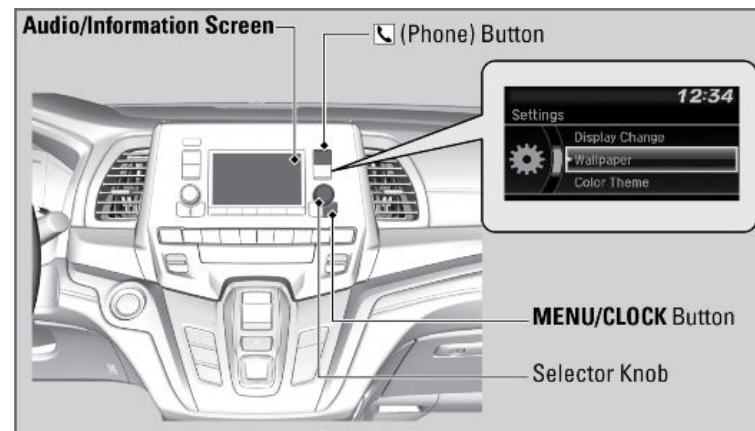

Models with Display Audio

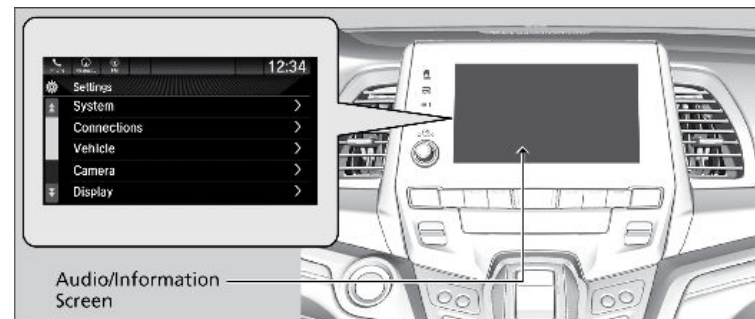

■ **To Change a Setting**

Models with Color Audio

Using the Driver Information Interface

1. Press the **Home** button.
2. Select **Settings**.
3. Select a setting option and make your preferred changes. Then press the **ENTER** button.

Models with Display Audio

1. Press the **Home** button.
2. Select **Settings**.
3. Select a category.
4. Select a setting option, and make your preferred changes.

Setting the Clock

On vehicles with navigation, the time is automatically set using GPS signals. To manually adjust the clock, use the following steps:

Models with Color Audio

1. Press and hold the **MENU/CLOCK** button.
2. Select **Adjust Clock**, then press the selector knob.
3. Rotate knob to change the hour, then press the selector knob.
4. Rotate knob to change the minute, then press the selector knob.
5. Press the selector knob to switch to **Set**.
6. Press the selector knob to complete clock adjustment.



Models with Display Audio

1. Press the **Home** button.
2. Select **Settings**.
3. Select **System**.
4. Select **Date & Time**.
5. Select **Set Date & Time**.

6. Select **Set Time**.
7. Use the up and down arrows to set the hour and minute.
8. Press the **Save** button to set the time.

HondaVAC™*1

Clean up dry spills and debris inside your vehicle with the in-car vacuum system.

■ **Operating the Vacuum**

1. Make sure the vehicle is in Park (P) with the parking brake set. The vacuum can be used with the vehicle ON (engine running) or in Accessory mode (engine NOT running).
2. Start the engine (ON) in a well ventilated, open area outside to minimize the likelihood of carbon monoxide exposure OR set the power mode to ACCESSORY.
3. Open the vacuum storage lid in the driver's side rear cargo area.
4. Pull out the vacuum hose and install one of the attachments if desired.
5. Press the power button and begin to vacuum (dry use only).

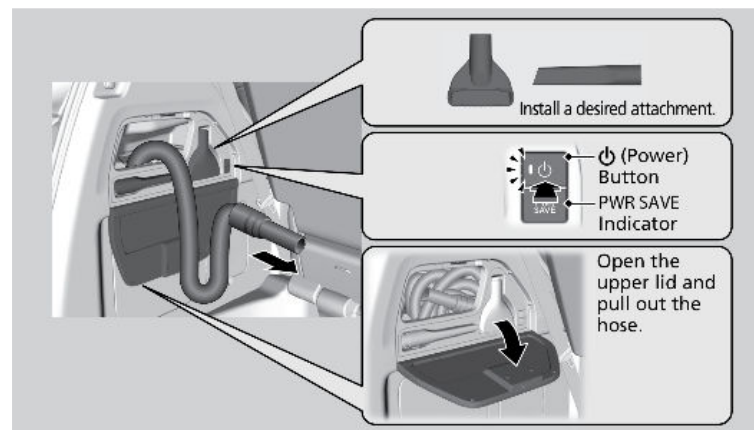

Accessory mode operation (without the engine running)

- After 7 minutes, an intermittent beep begins to sound as a time limit alert.
- After 8 minutes, a beep sounds PWR SAVE indicator comes on, and the vacuum turns off. You must start the engine if you want to continue using the vacuum. The vacuum will restart after the engine has been running for about one minute.

*1 - If equipped

See the Owner's Manual at owners.honda.com (U.S.) or honda.ca (Canada) for instructions on emptying the canister.

⚠ WARNING

Engine exhaust contains toxic carbon monoxide that builds up rapidly in enclosed areas. Breathing it can cause unconsciousness and even kill you.

If running the engine to power the vacuum, park the vehicle outdoors and lower all windows to ensure adequate ventilation.

Do not vacuum flammable liquids or in an area with flammable vapors. A fire or explosion could result, causing death or serious injury.

Note: The vacuum is intended for dry use only. Water and other liquids can damage the vacuum.

AUDIO AND CONNECTIVITY

How to operate the vehicle's audio system.

Basic Audio Operation

Connect audio devices and operate buttons and displays for the audio system.

Note: When the screen is viewed through polarized sunglasses, a rainbow pattern may appear on the screen due to optical characteristics of the screen.

■ USB Port

Install the iPod® USB connector or the USB flash drive to the USB port.

Models with Color Audio

In the console compartment

The right-side port (1.0A) is for playing audio, connecting a phone, and device charging.

The left-side port (2.5A) is for device charging only.

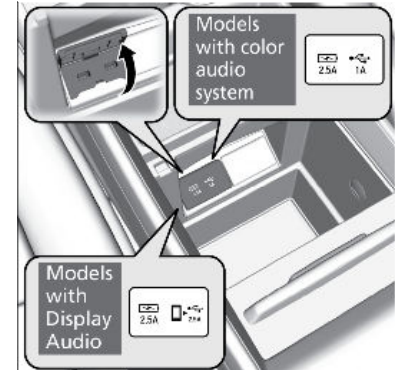

Models with Display Audio

The USB port (2.5A) on the right side is for charging devices, playing audio files and connecting compatible phones with Apple CarPlay® or Android Auto™.

On the back of the console compartment*1

The USB ports (2.5A) are only for charging devices.

The USB port (2.5A) on the left side is only for charging devices.

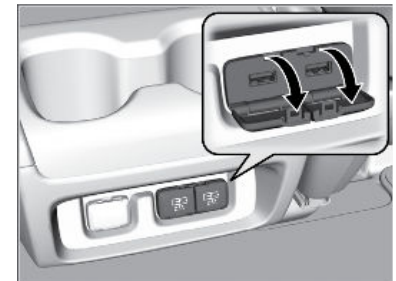

*1 - If equipped

Tip: To prevent any potential issues, be sure to use an Apple MFi Certified Lightning Connector for Apple CarPlay® or a USB cable certified by USB-IF to be compliant with USB 2.0 Standard for Android Auto™.

■ **Accessory Power Socket**

The accessory power sockets can be used when the power mode is in ACCESSORY or ON.

Console Panel

Open the cover to use it.

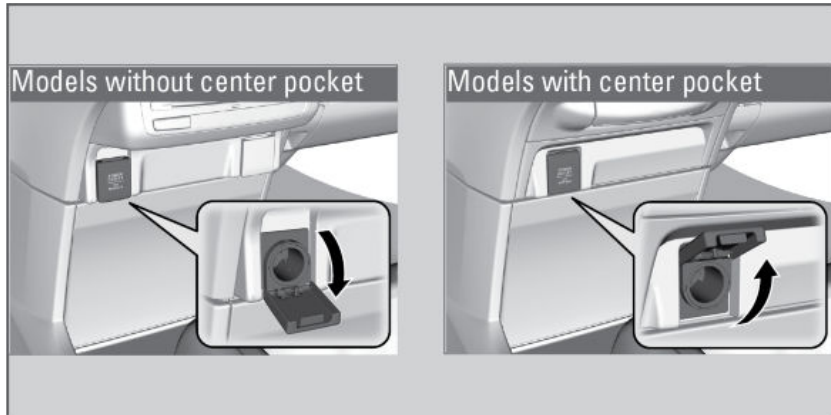

Third row seat*1

Open the cover to use it.

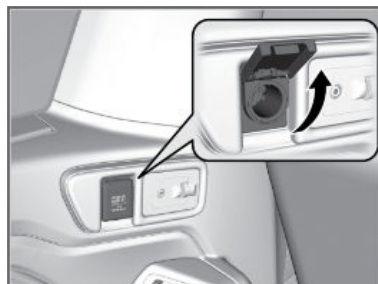

Cargo area

Open the cover to use it.

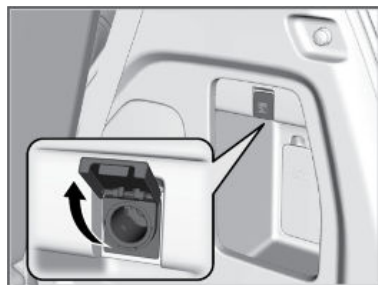

*1 - If equipped

NOTICE

Do not insert an automotive type cigarette lighter element. This can overheat the power socket.

■ **Adjusting the Sound**

Adjust various sound settings.

Models with Color Audio

Use the selector knob to make and enter selections.

1. Press the Sound button.
2. Select a sound mode to change, and adjust it using the selector knob.
3. Press the Back button to exit the menu.

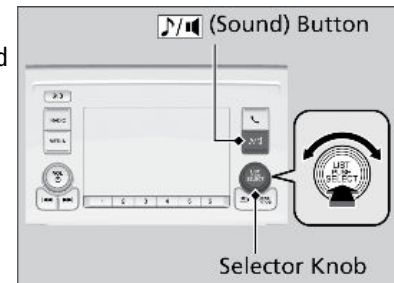

Models with Display Audio

Touch items on the screen to make and enter selections.

1. From the HOME screen, select an audio source.
2. Select Sound.
3. Select an item to change and adjust the setting. Select Save when complete.

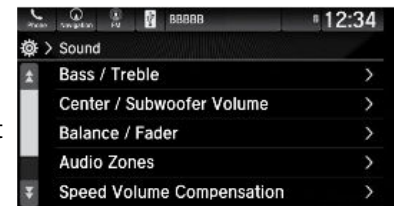

■ **Audio Remote Controls**

Models with Color Audio

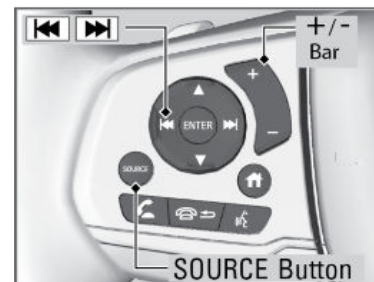

SOURCE Button: Press to cycle through the available audio modes.

Volume Bar (+/-): Press the +/- at the ends of the bar to adjust the volume.

Models with Display Audio

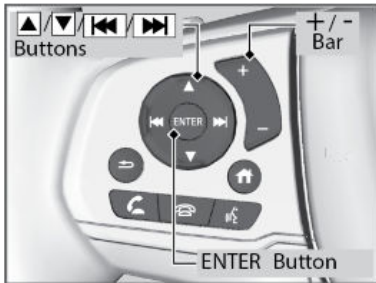

Volume Bar (+/-): Press the +/- at the ends of the bar to adjust the volume.

Up/Down Arrows: Press to cycle through the available audio modes.

Audio/Information Screen

Displays each mode status and wallpaper. From this screen, you can go to various setup options.

■ Switching the Display

Press the NAV, PHONE, INFO and AUDIO buttons to go to the corresponding display.

Models with Color Audio

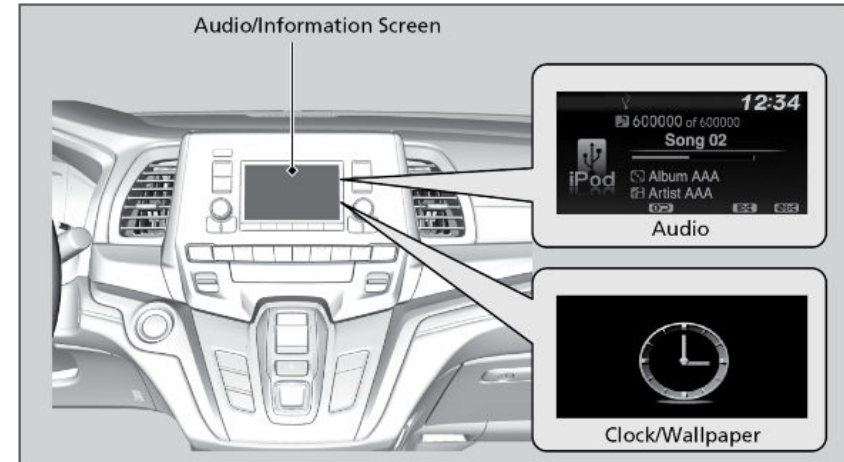

Models with Display Audio

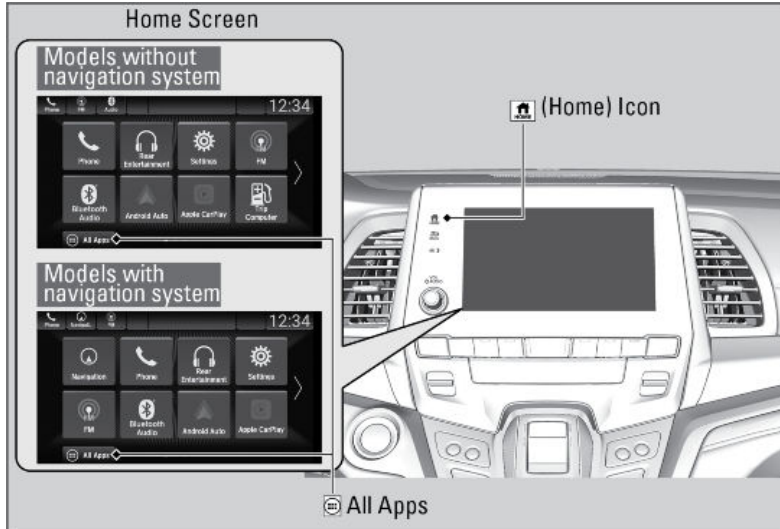

Color Audio System

Use the buttons to control the color audio system.

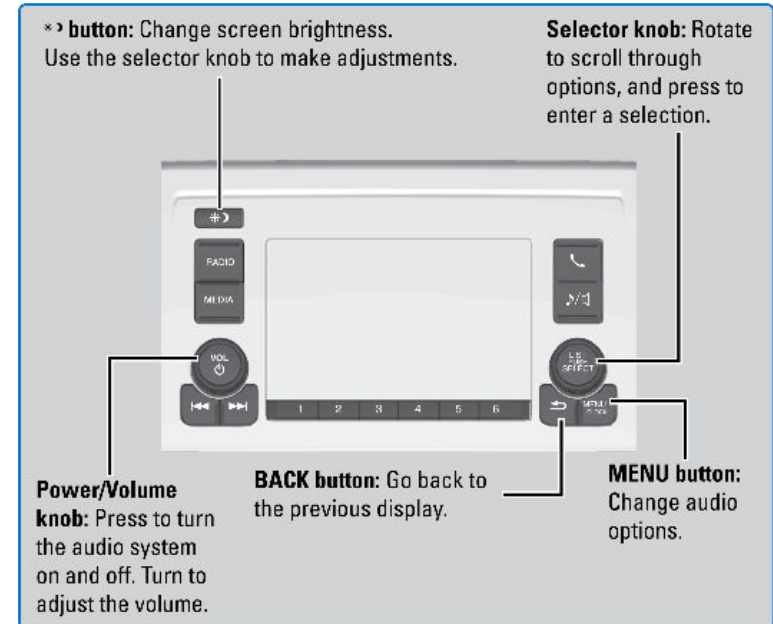

Display Audio System

Use simple gestures-including touching, swiping and scrolling-to operate certain audio functions.

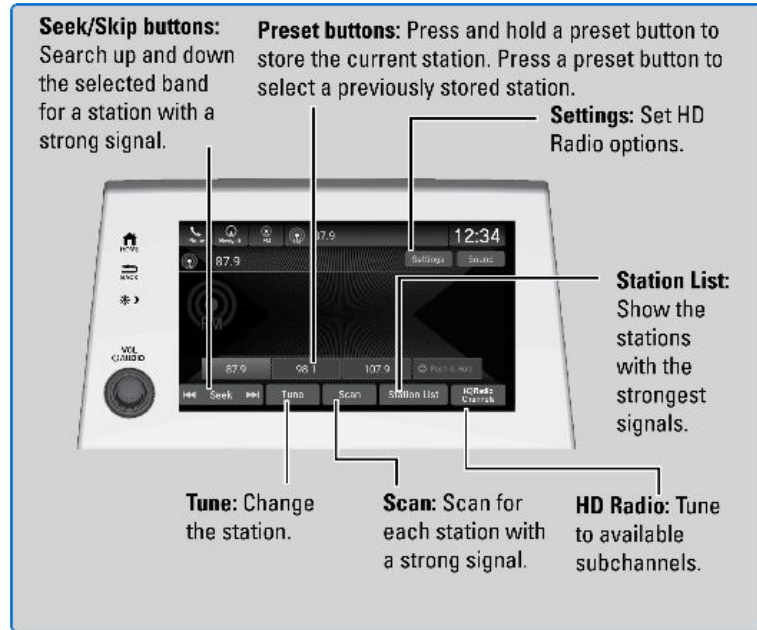

Note: Some items may be grayed out during driving to reduce the potential for distraction. You can select them when the vehicle is stopped or use voice commands.

Wearing gloves may limit or prevent touchscreen response.

Managing Apps

Models with Display Audio

Customize the Home screens by adding, moving, and hiding apps. Use presets to keep frequently used apps at your fingertips.

■ Add Apps to a Home screen

1. On the Home screen, select All Apps.
2. Check the box for an app you want to add.



All Apps Icon



Check Box

■ Move Apps

1. On the Home screen, select and hold an icon.
2. Drag and drop it where you would like it.
3. Select Done.

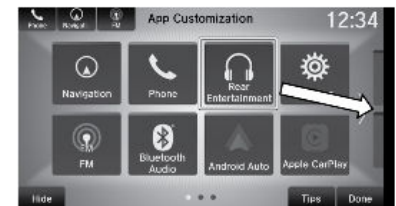

■ Hide Apps

1. On the Home screen, select and hold an icon.
2. Drag and drop it on the Hide icon.
3. Select OK.Done.

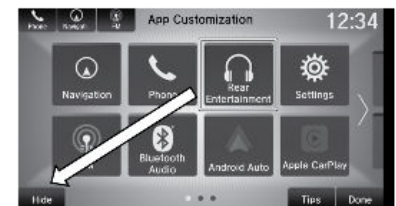

■ **Set Shortcuts**

1. On the Home screen, select and hold an icon.
2. Drag and drop it the upper-left corner of the screen.
3. Select Done.

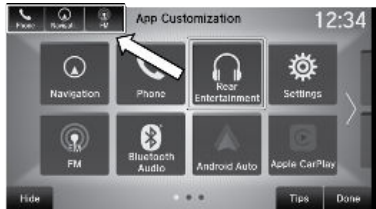

Near Field Communication (NFC)*1

Near Field Communication (NFC) allows you to connect select Android phones to the audio system via *Bluetooth*®.

NFC enables two devices to communicate in close proximity, within about 2 inch (40 mm).

■ **NFC Setup**

1. Press the Home button.
2. Select Settings.
3. Select Connections.
4. Select NFC, then ON.



Note: Depending on your phone and cellular signal capability, your vehicle's location may not be sent to the operator.

■ **NFC *Bluetooth*® Setup**

1. Press the Home button and then select **NFC Manager**.
- or -
- Touch the NFC logo near the glove box with the NFC tag of your phone. The NFC Manager screen is displayed.

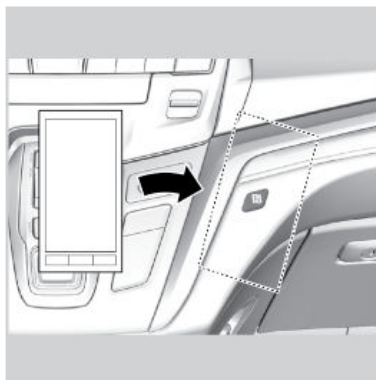

2. Select **Connect Device to Vehicle Bluetooth**.



3. Touch the NFC logo near the glove box with the NFC tag of your phone.
4. A notification appears on the screen if pairing is successful.



**1 - If equipped*

Apple CarPlay[®]*1

If you connect an Apple CarPlay[®]-compatible iPhone[®] to the system via the USB port, you can use the audio/information screen, instead of the iPhone[®] display, to make a phone call, listen to music, view maps (navigation), and access messages.

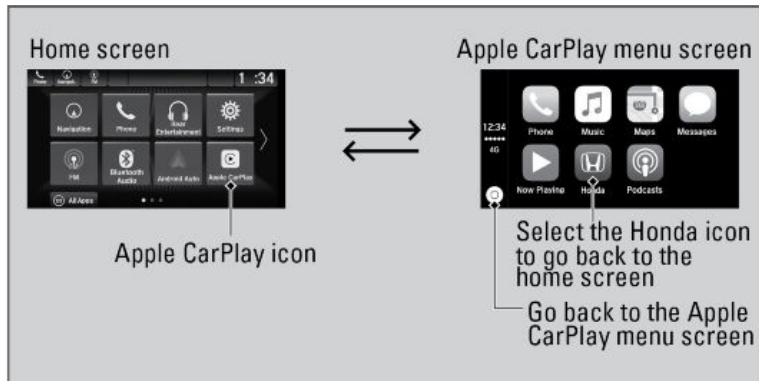

- **Phone:** Access your contacts, make phone calls, or listen to voice mail.
- **Music:** Play music stored on your iPhone[®].
- **Maps:** Display Apple Maps and use the navigation function just as you would on your iPhone[®].
- **Messages:** View and reply to text messages, or have messages read to you.

Tip: To prevent any potential issues, be sure to use an Apple MFi Certified Lightning Connector for Apple CarPlay[®].

**1 - If equipped*

Depending on use, Apple CarPlay[®] can share certain vehicle information (e.g., vehicle location, speed, and other operating conditions) with the connected iPhone[®]. See Apple's privacy policy for details regarding Apple's use and handling of data uploaded by Apple CarPlay[®]. Use of Apple CarPlay[®] is at user's own risk, and is subject to agreement to the Apple CarPlay[®] terms of use, which are included as part of the Apple iOS terms of use. Apple CarPlay[®] vehicle integration is provided "as is," and Honda cannot guarantee Apple CarPlay[®] operability or functionality now or in the future due to, among other conditions, changes in Apple CarPlay[®] software/Apple iOS, service interruptions, or incompatibility or obsolescence of vehicle-integrated hardware or software. See dealer for details. Only use Apple CarPlay[®] when conditions allow you to do so safely. See your Owner's Manual at owners.honda.com (U.S.) or honda.ca (Canada) for further license and warranty terms.

Android Auto[™]*1

Connect a compatible Android phone to the system. You can use the touchscreen to make a phone call, listen to music, and more. Visit the Android Auto[™] website for more information.

Park in a safe place before connecting your Android smartphone and launching any compatible apps.

1. Connect the phone to the front (right side*1) USB port. Compatible Android phones will prompt you to download any required apps.
2. Select Enable or Disable.
3. Follow any prompts shown on your phone.
4. The phone will be automatically paired. A tutorial will appear on the vehicle screen.
5. Select a menu option.

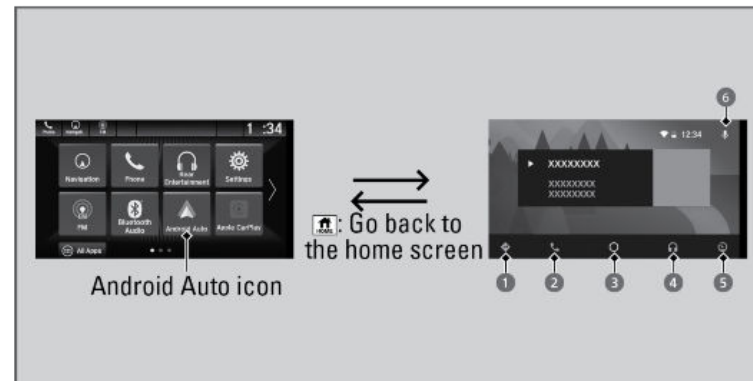

1. **Maps (Navigation):** View Google Maps and operate navigation. You can only use this system or the pre-installed navigation system to set a destination with routing guidance. You cannot enter destinations using the keyboard while the vehicle is moving.
2. **Phone:** Make phone calls or listen to voicemail.
3. **Home (Google Now):** Display useful information organized by Android Auto[™] into simple cards that appear only when needed.
4. **Music:** Play music from compatible apps. Select this icon to switch between music apps.
5. **Return to HOME screen:** Displays a menu with an option to return to the vehicle system HOME screen.

**1 - If equipped*

6. **Voice:** Use voice commands via Google Voice Search to operate Android Auto™. You can also press and hold the Talk button on the steering wheel (see Steering Wheel Controls) to say voice commands.

Tip: To prevent any potential issues, be sure to use a USB cable certified by USB-IF to be compliant with USB 2.0 Standard for Android Auto™.

Depending on use, Android Auto can share certain vehicle information (e.g., vehicle location, speed, and other operating conditions) with Google and its service providers. See Google privacy policy for details regarding Google's use and handling of data uploaded by Android Auto. Use of Android Auto is at user's own risk, and is subject to agreement to the Android Auto terms of use, which are presented to the user when the Android Auto application is downloaded to the user's Android phone. Android Auto vehicle integration is provided "as is," and Honda cannot guarantee Android Auto operability or functionality now or in the future due to, among other conditions, changes in Android Auto software/Android operating system, service interruptions, or incompatibility or obsolescence of vehicle-integrated hardware or software. See dealer for details. Only use Android Auto when conditions allow you to do so safely. See your Owner's Manual at owners.honda.com (U.S.) or honda.ca (Canada) for further license and warranty terms.

Wi-Fi Connection*1

Models with Display Audio

You can connect the audio system to the internet using Wi-Fi. If your compatible phone has hotspot capabilities, the system can be tethered to the phone. Follow the steps below to set up Wi-Fi when the vehicle is stopped. Standard data rates apply with your phone service provider.

1. From Home, select Settings.
2. Select Connections, then Wi-Fi.
3. Select Change Mode.
4. Select Network or HotSpot, then Save.
5. Select Connect.
Enter a password for the access point, and select OK.

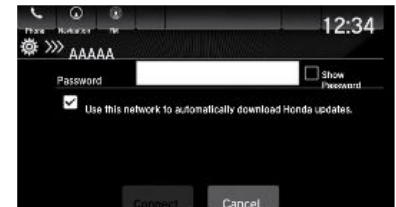

*1 - If equipped

System Updates

Install authorized updates to the Display Audio system software. Install via a WiFi connection, WiFi connection or a USB storage device.

Wireless Connection Setup

These steps are required only for updating via Wi-Fi.

1. From the Home screen, select System Updates, then Settings.
2. Select Connection Setup.
3. Select Change Mode.
4. Select Network, then Save.

The display returns to the network list.

5. Select an access point from the network list, then Connect.



Wireless Updating

1. From the Home screen, select System Updates.
2. Select Settings.
3. Select Connection Setup.
4. Select Change Mode.
5. Select Network, then Save.
6. Select an access point from the network list, then Connect.

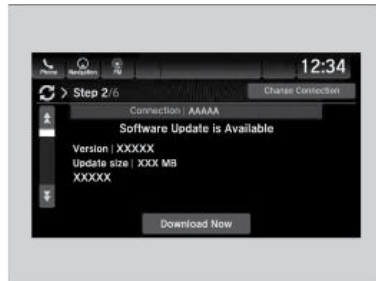
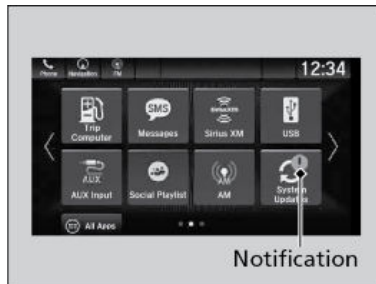

USB Updating

Download the update.

1. From the Home screen, select System Updates, then via USB.
2. Connect a USB drive into the front (right side*1) USB port (see USB Port).
3. Once the system finishes copying to the USB drive, disconnect the drive and connect it to your computer.
4. Follow the link to download the updated files. See usb.honda.com for more details.



Install the update

1. From the Home screen, select System Updates, then via USB.
2. Connect the USB device containing the updated files to the front (right side*1) USB port.
3. Select Install Now or Install While Vehicle Off.

Notes for wireless and USB updating:

- If you select Install Now, the system will reboot. Do not operate the Display Audio unit during the software update. You will see a notice when the update is complete.
- If you select Install While Vehicle Off, you will see a notice when the update is complete when you start the vehicle.

Note:

- Honda recommends using a flash drive with 8GB capacity or higher.

FM/AM Radio

Models with Color Audio

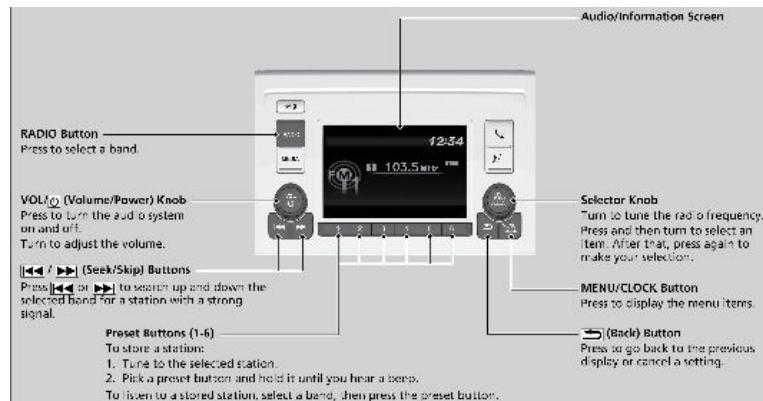

Models with Display Audio

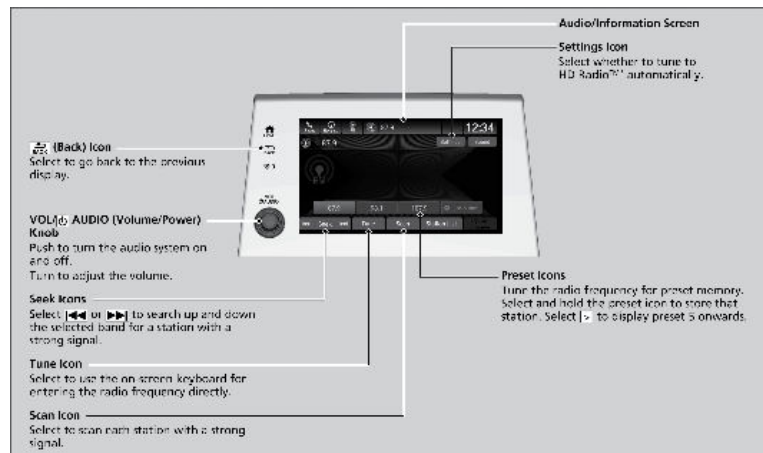

SiriusXM® *1

Available on a subscription basis only. For more information or to subscribe, contact your dealer, or visit www.sirius.com/subscribe (U.S.) or www.sirius.ca/subscribe (Canada).

To learn about additional features—such as multi-channel preset, replay, or SportsFlash—see your Owner's Manual at owners.honda.com (U.S.) or honda.ca (Canada).

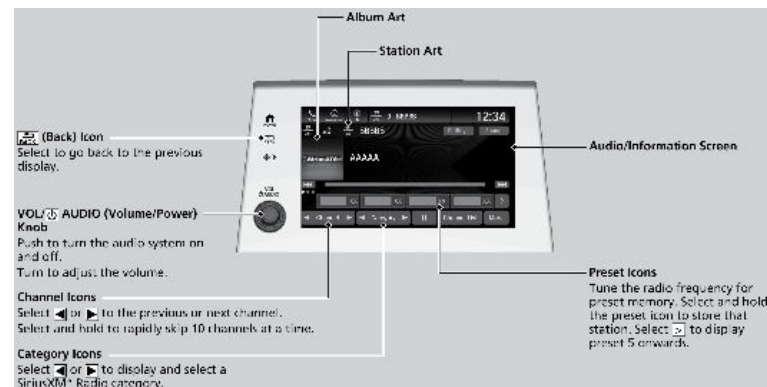

Bluetooth® Audio

Play streaming or stored audio from your compatible phone when it is paired to **Bluetooth® HandsFreeLink®** (see Pairing a Phone). Visit handsfreelink.com to check phone compatibility. Canada customers can phone (855) 490-7351 for any HandsFreeLink® related inquiry. Standard data rates apply with your phone service provider.

Models with Color Audio

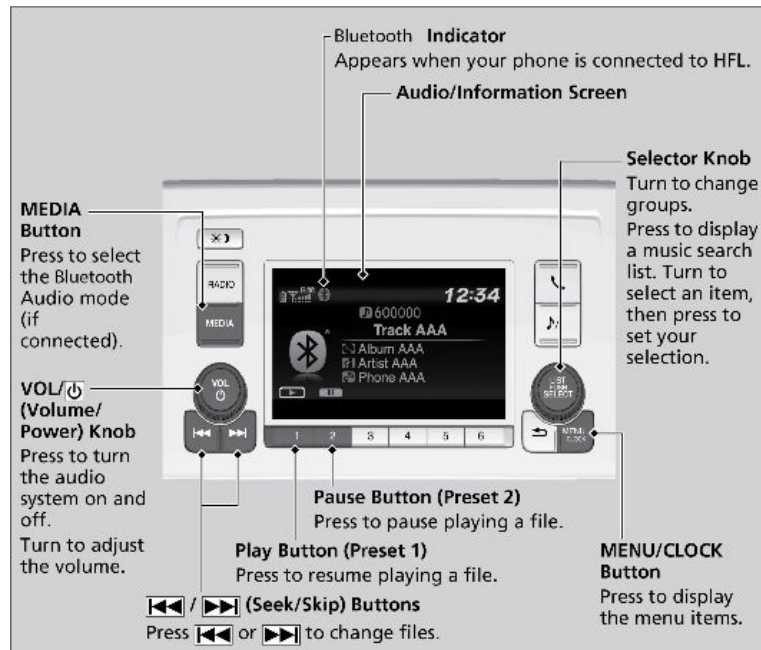

Models with Display Audio

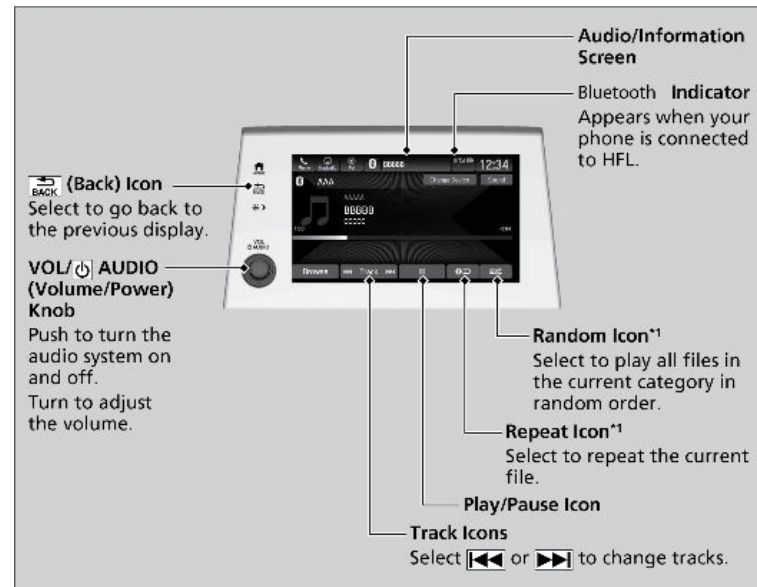

HondaLink®

A subscription-based service that provides convenient features such as voice communication in case of emergency, online security, and one-on-one operator assistance*1.

To check phone compatibility and get more information, visit handsfreelink.com. Canada customers can phone (855) 490-7351 for any HandsFreeLink® related inquiry. Standard data rates may apply with your phone service provider.

■ HondaLink® Connection

Follow the steps below to connect to HondaLink® Connection and use its features.

1. Download the HondaLink® Connection Connect app to your compatible smartphone.
2. Pair your phone to **Bluetooth HandsFreeLink** (see Pairing a Phone).

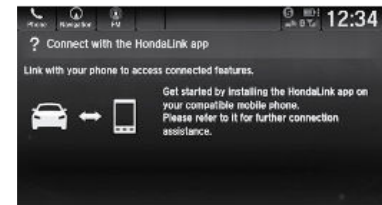

Applicable laws may prohibit the operation of handheld electronic devices while operating a vehicle. Launch streaming audio on your phone only when safe to do so.

**1 - If equipped*

- From the HOME screen, select HondaLink® Connection.
- Certain features require you to send vehicle information to Honda. Select Enable Once, Always Enable, or Disable.

■ HondaLink® Assist*1

If your vehicle's airbags deploy or if the unit detects that the vehicle is severely impacted, your vehicle automatically attempts to connect to the HondaLink® operator. If connected, information about your vehicle, its location, and its condition can be sent to the operator*1; you also can speak to the operator when connected.

Rear Entertainment System (RES)*1

Rear passengers can enjoy a different audio or entertainment source than front passengers, including movies, games, and other audio choices.



■ Operating the System from the Front

To operate the system, set the power mode to ON or ACCESSORY. Select Rear Entertainment, then the Rear Icon in the audio/information screen to turn on the system. You can also turn on the system by pressing the Power button on the remote.



■ Operating the System from the Rear

- Make sure the REAR POWER button is turned on in the front.
- Press the HOME button.

*1 - If equipped

*1 - If equipped

3. Select the desired source button (DVD, iPod®, USB flash drive, HDMI etc.).

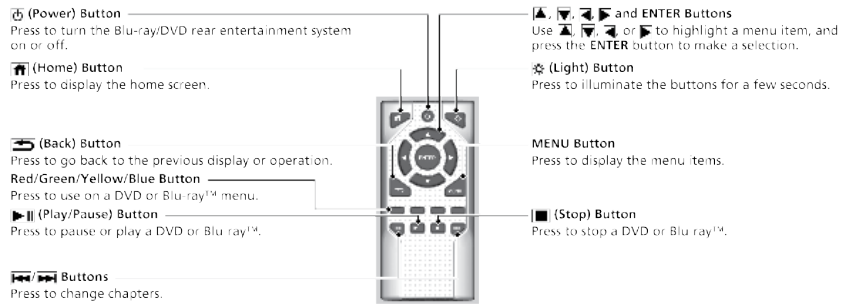

CAUTION

Radio Frequency Radiation Exposure. The Rear Entertainment System remote complies with FCC radiation exposure limits set forth for an uncontrolled environment and meets the FCC Radio Frequency (RF) Exposure Guidelines. The Rear Entertainment System remote should be kept at least 7.9 inches (20 cm) or more away from a person's body when operated.

■ **Playing a Disc**

Insert a DVD or Blu-ray™ into the lower slot of the front audio system, and select the Rear icon in the audio/information screen.

The system automatically starts the DVD or Blu-ray™. DVD or Blu-ray™ is available for the rear seat passenger only.

NOTICE

Do not use discs with adhesive labels or insert a damaged disc. Inserting these types of discs may cause them to get stuck or damage the audio unit.

■ **HDMI™ Port**

There is an HDMI™ port on the back of the center console compartment. The system will accept HDMI™ input from video games and video equipment which are equipped with an HDMI™ port.

Open the outlet cover and insert the cable.

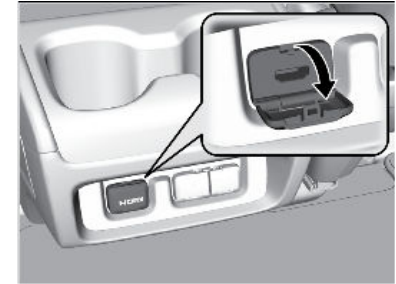

■ **Overhead Screen**

Pull down the screen to the first or second detent until it latches.

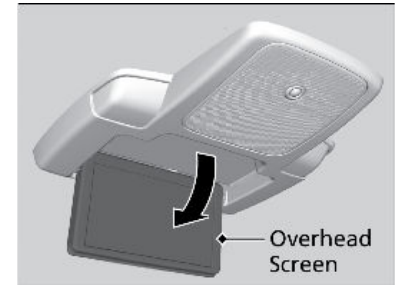

NOTICE

This vehicle's overhead mounted display includes mercury-containing components. Upon removal or replacement, please reuse, recycle, or dispose of as hazardous waste.

■ **Wireless Headphones**

Your vehicle comes with two sets of wireless headphones.

Press the Power button on the right earpiece to turn on the headphones.

Turn the dial on the right earpiece to adjust the volume.

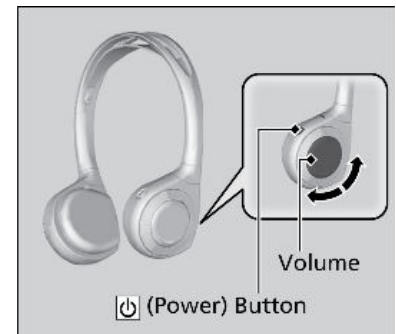

■ **Auxiliary Console Panel**

Headphone connectors for the Blu-ray/DVD rear entertainment system are on both sides of the third row. Each connector has its own volume control.



■ **Rear Entertainment System Accessibility**

The Blu-ray/DVD Rear Entertainment System (RES) supports an accessibility function which allows for audio feedback of on-screen operations through the headphones.

Selecting the Accessibility Function

1. Press the Power button on the remote (from the rear seat).
2. Select Accessibility and then press the Enter button on the remote.

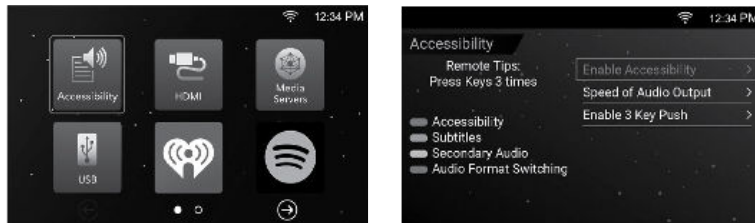

The following items are available:

- Enable Accessibility:** Turns the accessibility mode ON or OFF. The default setting is OFF.
- Speed of Audio Output:** Adjusts to increase or decrease the speed of audio output.
- Enable 3 Key Push:** Turns the 3-button push behavior ON or OFF.

CabinWatch™*1

Models with Display Audio

Monitor second- and third-row passengers via the Display Audio screen.

1. Select Home.
2. Select CabinWatch™.

To zoom the desired position, double tap, pinch out, or drag there on the audio/information screen.

To return to the normal display, double tap again or pinch in.

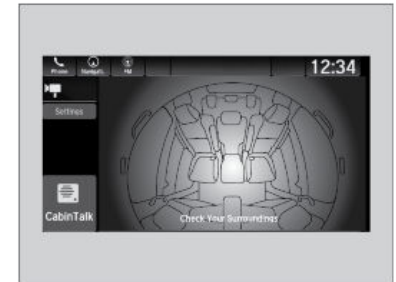

CabinTalk™*1

Broadcast your voice to second- and third-row passengers via the rear speakers or headphones.

1. Select Home.
2. Select CabinTalk™.

Models with center speaker

Select Speakers to broadcast to the rear speakers.

Select Headphones to broadcast to headphones.

Select Mic is On to mute your voice.



*1 - If equipped

BLUETOOTH® HANDSFREELINK®

How to operate the vehicle's hands-free calling system.

Basic HFL Operation

Make and receive phone calls using the vehicle's audio system, without handling your phone. Visit handsfreelink.com to check phone compatibility. Canada customers can phone (855) 490-7351 for any HandsFreeLink® related inquiry.

To reduce the potential for driver distraction, certain manual functions may be inoperable or grayed out while the vehicle is moving. Voice commands are always available.

■ HFL Displays and Controls

Use the controls to enter information and make selections.

Models with Color Audio

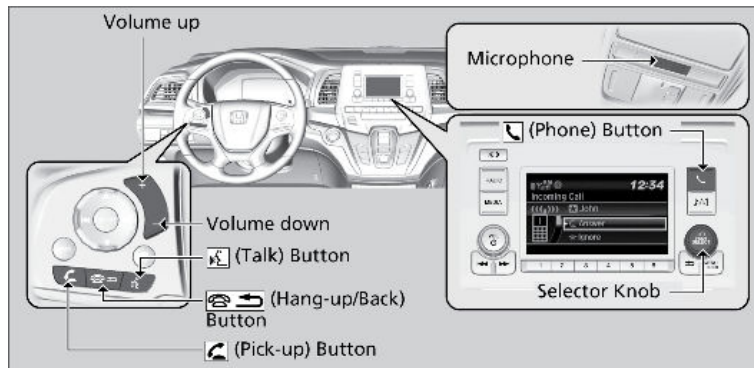

Models with Display Audio

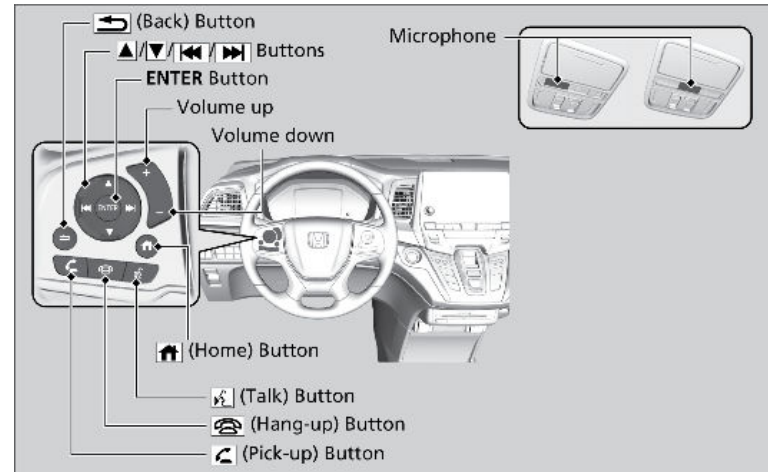

■ Talk Button Tips

When using the Talk button, wait for the beep before saying a command. The system recognizes commands listed in the Voice Command Index.

- When using the Talk button, wait until you hear a beep before speaking.
- To bypass the system prompts, simply press the Talk button again to say your command.
- Speak in a clear, natural voice.
- Reduce all background noise.
- Adjust the dashboard vents away from the microphone on the ceiling.
- Close the windows and moonroof*1.

Pairing a Phone

To use hands-free phone and streaming audio functions, you must first pair your phone to the system. This can only be done when the vehicle is stopped. If there is an active connection to Apple CarPlay® (see Apple CarPlay) or Android Auto™ (see Android Auto), pairing of additional Bluetooth-compatible devices is unavailable and Add Bluetooth Device is grayed out from the Bluetooth Device List screen.

■ **Pairing the First Phone**

Models with Color Audio

Use the selector knob to make and enter selections.

1. Press the Phone button.
2. Select Yes.
3. Make sure your phone is in search or discoverable mode, then press the selector knob.
4. When your phone appears on the list, select it by pressing the selector knob.



If your phone does not appear, select Phone Not Found? and search for *Bluetooth*® devices using your phone. From your phone, select HandsFreeLink®.



Search for *Bluetooth*® devices using your phone. From your phone, select HandsFreeLink®.

5. The system gives you a pairing code on the audio/information screen. Confirm if the pairing code on the screen and your phone match. This may vary by phone.
6. A notification appears on the screen if pairing is successful.

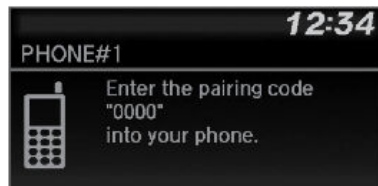

Models with Display Audio

Use the touchscreen to make and enter selections.

1. From the Home screen, select Phone.
2. Select Connect Phone.



3. Make sure your phone is in discovery mode, then select Connect New Device.
4. The system searches for your phone. Select your phone when it appears on the list.
If your phone does not appear: search for HandsFreeLink from your phone. Connect to HFL.
5. The system gives you a pairing code. Compare it to the code that appears on your phone. Connect to HFL from your phone.
6. Select your desired options, then select Connect.

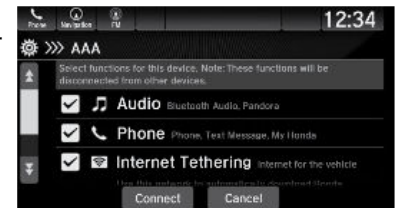
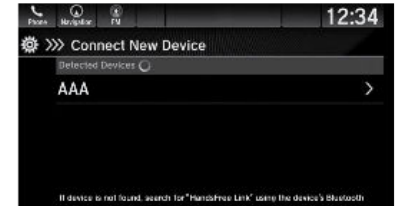

■ **Pairing an Additional Phone**

Models with Color Audio

1. Press the Phone button to go to the Phone screen. If a prompt appears asking to connect to a phone, select No.
2. Select Phone Setup.
3. Select *Bluetooth*® Setup.
4. Select Add New Device.
5. Select Add New.
6. Make sure your phone is in discovery mode. Select OK.
7. The system searches for your phone. Select it when it appears on the list.
8. *If your phone does not appear:* Select Phone Not Found?, and search for HandsFreeLink from your phone. Connect to HFL.
9. The system gives you a pairing code. Enter it on your phone when prompted.



Applicable laws may prohibit the operation of handheld electronic devices while operating a vehicle.

Models with Display Audio

1. Select Add *Bluetooth*® Device from the *Bluetooth*® device list screen.
2. To change the *Bluetooth*® connection priority device setting, select Priority Device Settings from the *Bluetooth*® Device List screen.

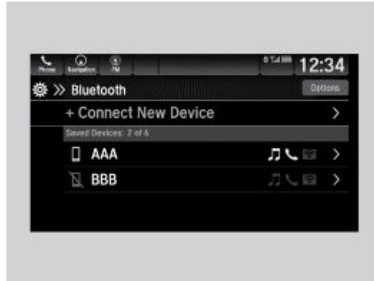

Making a Call

You can make calls by inputting any phone number, or by using the imported phonebook, call history, speed dial entries, or redial.

■ **Dialing a Number**

Models with Color Audio

1. Press the Phone button.
2. Select Dial.
3. Enter the phone number. Select the green phone icon to call.



Models with Display Audio

Enter a 10-digit phone number to call.

1. From the Home screen, select Phone.
2. Select Keypad.
3. Enter the phone number.
4. Select Call.



■ **Using the Phonebook**

When your phone is paired, its phonebook is automatically imported to the system.

This method is inoperable while the vehicle is moving.

Models with Color Audio

1. Press the Phone button.
2. Select Phonebook.
3. Scroll through the list to find the name and number you want to call, and select it to call.



Models with Display Audio

1. From the Home screen, select Phone.
2. Select Contacts.
3. Scroll through the list to find the name.
4. Select a number.

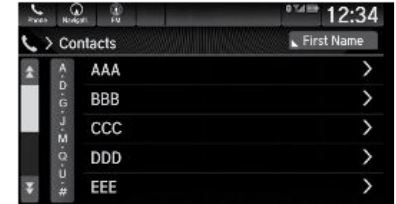

■ **Storing Speed Dial Entries**

Store up to 20 numbers for quick dialing. To store a speed dial number:

Models with Color Audio

1. Press the Phone button.
2. Rotate the selector knob to select Speed Dial, then press it.
3. Rotate the selector knob to select Add New, then press it.
4. Rotate the selector knob to select a place to choose a number from, then press it.



From Call History:

Select a number from the call history.

From Phonebook:

Select a number from the connected cell phone's imported phonebook.

From Phone Number:

Input the number manually.

5. When the speed dial is successfully stored, you are asked to create a voice tag for the number. Rotate the selector knob to select Yes or No, then press it.

Applicable laws may prohibit the operation of handheld electronic devices while operating a vehicle.

- Using the Talk button, follow the prompts to say the name for the speed dial entry.

Models with Display Audio

- Go to the phone menu screen.
- Select the Recent Calls, Contacts, or Keypad screen.
- Select the star icon.

A notification appears on the screen if the speed dial is successfully stored.

To remove the speed dial, select the star icon again.

Contacts Screen



Star Icon

Keypad Screen



Star Icon

■ **Using Speed Dial**

Make calls quickly using stored speed dial entries.

Models with Color Audio

- Press the Phone button.
- Select Speed Dial.
- Scroll through the list to find the entry you want to call, and select it to call.



Models with Display Audio

- Go to the phone menu screen.
- Select Favorite Contacts.
You can change the order of speed dial entries by selecting Reorder.
- Select a number.
Dialing starts automatically.

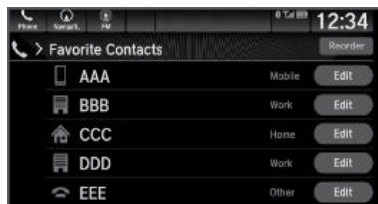

SMS Text Messaging and E-Mail*1

HFL can display newly received text messages as well as the last 20 messages received on a linked cell phone. Each received message can be read aloud and replied to using a fixed common phrase.

- A pop-up appears and notifies you of a new text message.
- Select Open to display the message.
- Select Play to listen to the message. To discontinue the message read-out, select Stop.



*1 - If equipped

VOICE COMMAND INDEX

Learn about the available voice commands to help you operate the vehicle. The system recognizes only those commands shown here. Press the TALK button before you say a command.

Voice Portal Commands

When you press the TALK button, the Voice Portal screen appears. Say one of the options, and follow the system prompts.

- Phone
- Audio
- Navigation*2

Phone Commands

The system accepts these commands on most screens.

- Call (name)
- Call (phone number)
- Call (category)

Audio Commands

The system accepts these commands on the dedicated screen for the voice recognition of the audio.

- Tune to <87.7-107.9> FM
- Tune to <530-1710> AM
- SiriusXM*1 channel (1-999)
- SiriusXM*1 channel (station name)
- USB play artist
- USB play album
- USB play playlist
- USB play song

Navigation Commands*2

When you press the Talk button and say "Navigation," you can say one of the options below. Follow the system prompts.

- Show/View map
- Go home
- Find address
- Stop route
- Detour
- Find city
- Recent Places
- Find intersection

*2 - Models with navigation only
*1 - If equipped

NAVIGATION

Learn how to enter a destination and operate the navigation system*1.

Basic Navigation Operation

A real-time navigation uses GPS and a map database to show your current location and help guide you to a desired destination. You can operate the system using voice commands or the system controls.

To reduce the potential of driver distraction, certain manual functions may be inoperable or grayed out while the vehicle is moving. Voice commands are always available.

Steering Wheel Controls

Use the steering wheel controls to give voice commands.

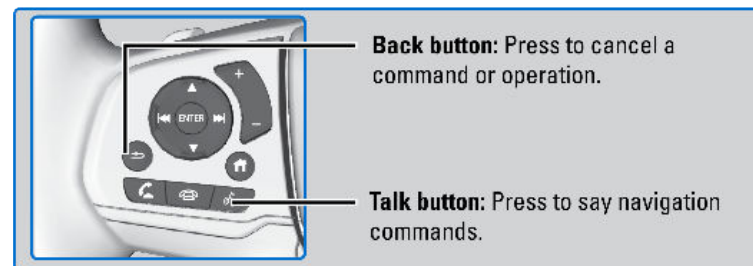

System Guidance Volume

1. From the Home Screen, select Navigation.
2. Select Map Tools, Then Guidance volume.
3. Select + or - to adjust volume, or select Mute.
4. Press Back to exit the menus.



Navigation Display and Controls

Touch icons on the screen to enter information and make selections.

*1 - If equipped

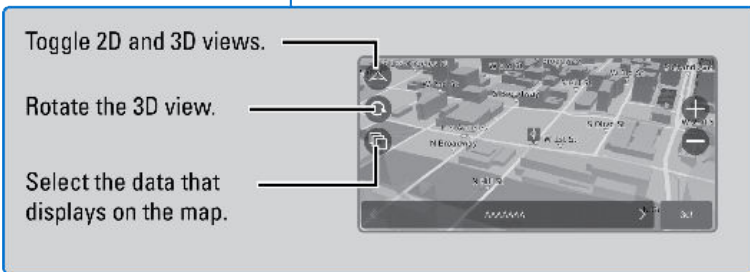
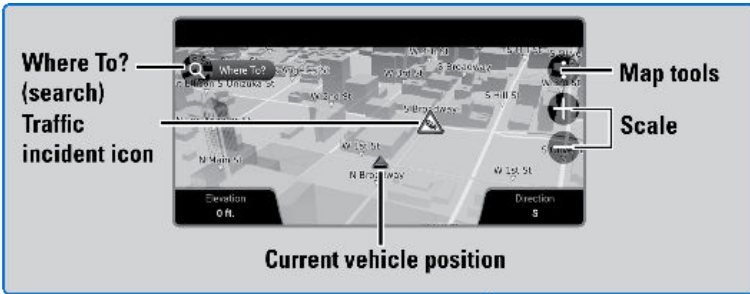

Entering Your Destination

There are several methods to enter a destination.

■ Home Address

Store your home address in the system so you can easily route to it.

1. Select Set Home Location.
2. Select an option.
 Select Use Current Location to set home location.
 If selecting Enter My Address, Recently Found or Saved Place, proceed to steps 3 and 4.
3. Select the home location.
4. Select Select.

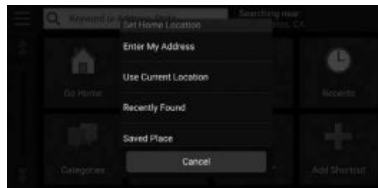

When your home address is stored, you can press the Talk button and say "Navigation" and then "Go Home" at any time. You can also select Go home from the Where To? menu.

■ Street Address

1. From the map screen, select the Search icon.
2. Select Search Tools.
3. Select Address.
4. Enter the house number and street name.
5. Select Done or a suggestion.
6. Select the address from the list.
7. Select Go!.

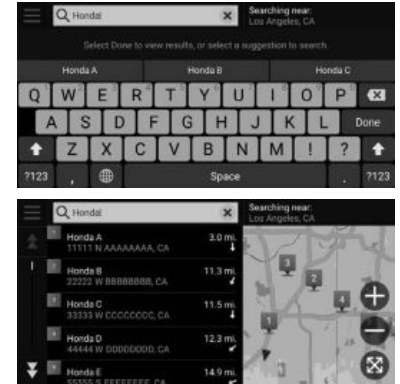

Routing

After a destination is set, you can alter or cancel your route.

■ Map Legend

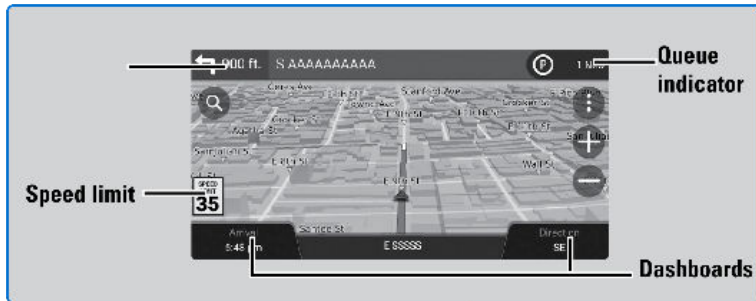

⚠ WARNING

Using the navigation system while driving can take your attention away from the road, causing a crash in which you could be seriously injured or killed.

Operate system controls only when the conditions permit you to safely do so.

DRIVING

Learn about preparation for driving, as well as other features.

Before Driving

Check the following items before you begin driving.

■ Exterior Checks

- Make sure there are no obstructions on the windows, door mirrors, exterior lights, or other parts of the vehicle.
- Remove any frost, snow, or ice.
- Make sure the hood is securely closed.
- Heat from the engine and exhaust can ignite flammable materials left under the hood, causing a fire. If you've parked your vehicle for an extended period, inspect and remove any debris that may have collected, such as dried grass and leaves that have fallen or have been carried in for use as a nest by a small animal. Also check under the hood for leftover flammable materials after you or someone else has performed maintenance on your vehicle.
- Make sure the tires are in good condition.
- Make sure there are no people or objects behind or around the vehicle.

NOTICE

If the doors are frozen shut, use warm water around the door edges to melt any ice. Do not try to force them open, as this can damage the rubber trim around the doors. When done, wipe dry to avoid further freezing.

Do not pour warm water into the key cylinder. You will be unable to insert the key if the water freezes in the hole.

■ Interior Checks

- Store or secure all items on board properly.
- Do not pile items higher than the seat height.
- Do not place anything in the front seat footwells. Make sure to secure the floor mats.
- If you have any animals on board, do not let them move freely in the vehicle.
- Securely close and lock all doors and the tailgate.
- Adjust your seating position, mirrors, and steering wheel properly.

- Make sure items placed on the floor behind the front seats cannot roll under the seats.
- Everyone in the vehicle must fasten their seat belt.
- Make sure that the indicators in the instrument panel come on when you start the vehicle, and go off soon after. Always have a dealer check the vehicle if a problem is indicated.

In addition:

- During the first 600 miles (1,000 km) of operation, avoid sudden acceleration or full throttle operation so as to not damage the engine or powertrain.
- Avoid hard braking for the first 200 miles (300 km). You should also follow this when the brake pads are replaced.
- Avoid towing a trailer during your vehicle's first 600 miles (1,000 km).

⚠ WARNING

Improper accessories or modifications can affect your vehicle's handling, and stability, and performance, and cause a crash in which you can be seriously hurt or killed.

Follow all instructions in the vehicle owner's manual regarding accessories and modifications.

Maximum Load Limit

Carrying too much cargo or improperly storing it can affect your vehicle's handling, stability, stopping distance, and tires, and make it unsafe. See the Tire and Loading Information label on the driver's doorjamb.

■ Maximum Load For Your Vehicle

The maximum load for your vehicle type is:

- Models without second row center seat: 1,173 lbs (532 kg)
- Models with second row center seat: 1,340 lbs (608 kg)

Label Example

TIRE	SIZE	COLD TIRE PRESSURE	SEE OWNER'S MANUAL FOR ADDITIONAL INFORMATION
FRONT	XXXX/XXXXX XXX	XXXKPA, XXPSI	
REAR		XXXKPA, XXPSI	
SPARE	XXXX/XXXX XXXX	XXXKPA, XXPSI	

This figure includes the total weight of all occupants, cargo, and accessories, and the tongue load if you are towing a trailer. Below are the steps for determining the correct load limit:

1. Locate the statement "The combined weight of occupants and cargo should never exceed XXX kg or XXX lbs." on your vehicle's placard.
2. Determine the combined weight of the driver and passengers that will be riding in your vehicle.
3. Subtract the combined weight of the driver and passengers from XXX kg or XXX lbs.
4. The resulting figure equals the available amount of cargo and luggage load capacity. For example, if the "XXX" amount equals 1,400 lbs. (635 kg) and there will be five 150 lbs. passengers in your vehicle, the amount of available cargo and luggage load capacity is 650 lbs. (1,400 - 750 (5 x 150) = 650 lbs.).
5. Determine the combined weight of luggage and cargo being loaded on the vehicle. That weight may not safely exceed the available cargo and luggage load capacity calculated in step 4.

- If your vehicle will be towing a trailer, load from your trailer will be transferred to your vehicle. Consult the Owner's Manual to determine how this reduces the available cargo and luggage load capacity of your vehicle.

Load Limits Example

Example 1

Max Load
1,340 lbs
(608 kg)

Passenger Weight
150 lbs x 2 = 300 lbs
(68 kg x 2 = 136 kg)

Cargo Weight
1,040 lbs
(472 kg)

Example 2

Max Load
1,340 lbs
(608 kg)

Passenger Weight
150 lbs x 5 = 750 lbs
(68 kg x 5 = 340 kg)

Cargo Weight
590 lbs
(268 kg)

In addition, the total weight of the vehicle, all occupants, accessories, cargo, and trailer tongue load must not exceed the Gross Vehicle Weight Rating (GVWR) or the Gross Axle Weight Rating (GAWR). Both are on a label on the driver's doorjamb.

⚠ WARNING

Overloading or improper loading can affect handling and stability and cause a crash in which you can be hurt or killed.

Follow all load limits and other loading guidelines in this guide.

The headlight aim on your vehicle was set by the factory, and does not need to be adjusted. However, if you regularly carry heavy items in the cargo area or tow a trailer, have the aiming readjusted at your dealer or by a qualified technician.

Towing a Trailer

Your vehicle can tow a trailer if you carefully observe the load limits, use the proper equipment, and follow the towing guidelines. See the Owner's Manual at owners.honda.com (U.S.) or honda.ca (Canada) for more information.

Towing Load Limits

Total trailer weight

Do not exceed the maximum allowable weight of the trailer, cargo and everything in or on it shown in the table. Towing loads in excess of this can seriously affect vehicle handling and performance and can damage the engine and drivetrain.

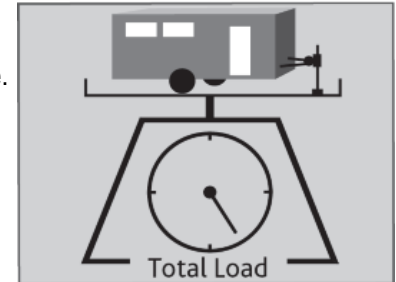

Number of occupants	Except ELITE and TOURING grade models	ELITE and TOURING grade models
2	3,000 lbs (1,360 kg)	3,500 lbs (1,587 kg)
3	3,000 lbs (1,360 kg)	3,350 lbs (1,520 kg)
4	3,000 lbs (1,360 kg)	3,150 lbs (1,429 kg)
5	3,000 lbs (1,360 kg)	3,000 lbs (1,360 kg)
6	2,000 lbs (907 kg)	2,000 lbs (907 kg)
7	800 lbs (363 kg)	800 lbs (363 kg)
8	Towing not recommended	

Each weight limit is calculated based on the following conditions:

- Occupants fill seats from the front of the vehicle to the back.
 - Each occupant weights 150 lbs (68 kg).
 - Each occupant has 17.6 lbs (8 kg) cargo in the cargo area.
- Any additional weight, cargo or accessories reduce the maximum trailer weight and maximum tongue load.

Tongue Load

The weight of the tongue with a fully loaded trailer on the hitch should be approximately:

10% of the total trailer weight.

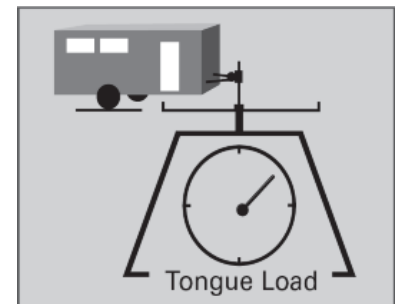

- Excessive tongue load reduces front tire traction and steering control. Too little tongue load can make the trailer unstable and cause it to sway.

⚠ WARNING

Exceeding any load limit or improperly loading your vehicle and trailer can cause a crash in which you can be seriously hurt or killed.

Check the loading of your vehicle and trailer carefully before starting to drive.

Things You Need to Know Before Towing a Trailer

- Have the trailer properly serviced and keep it in good condition.
- Make sure that all the weights and load in the vehicle and trailer are within limits.
- Securely attach the hitch, safety chains, and other necessary parts to the trailer.
- Securely store all the items in and on the trailer so that they do not shift while driving.
- Check if the lights and brakes on the trailer are working properly.
- Check the pressures of the trailer tires, including the spare.
- Turn off the Auto Idle Stop system using the Auto Idle Stop OFF button. The trailer weight can affect your vehicle's brake effectiveness if Auto Idle Stop is activated on a hill while towing a trailer.

Towing Behind A Motorhome

Your vehicle is not designed to be towed behind a motorhome. If your vehicle needs to be towed in an emergency, refer to Emergency Towing.

Improper towing such as towing behind a motorhome or other motor vehicle can damage the transmission.

Remote Engine Start *1

Start your vehicle's engine using the smart entry remote before you enter the vehicle.

■ Starting the Engine

Press the Lock button, then press and hold the Engine button to remotely start the engine.

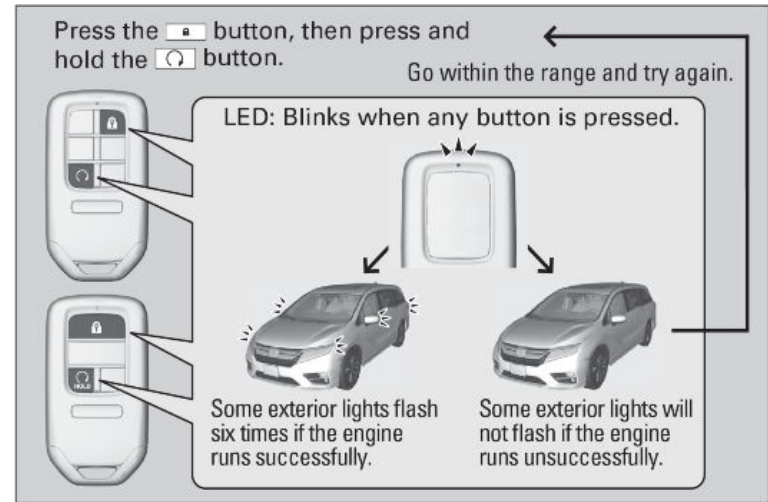

When started remotely, the engine automatically shuts off after 10 minutes of idling and/or the brake pedal and ENGINE START/STOP button have not been pressed simultaneously.

■ Stopping the Engine

When started remotely, the engine shuts off after 10 minutes of idling. It will also stop if the ENGINE START/STOP button and the brake are pressed simultaneously.

*1 - If equipped

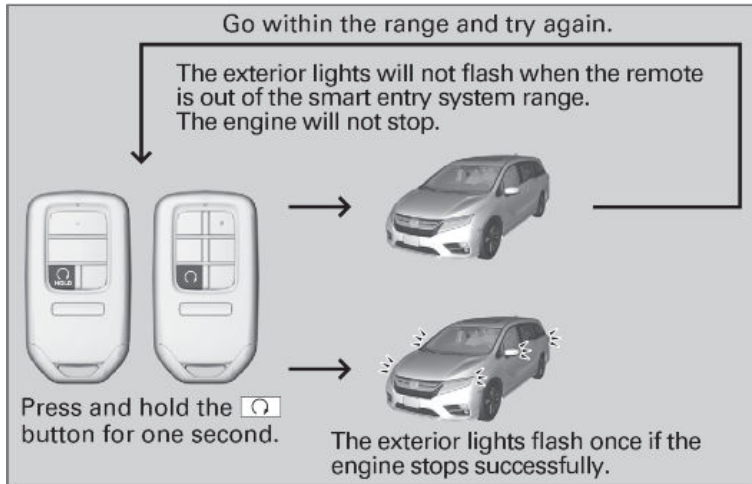

WARNING

Carbon monoxide gas is toxic and can rapidly accumulate in closed or even partly enclosed areas.

Breathing it can cause unconsciousness and even kill you.

Never use the remote engine starter with the vehicle parked in a garage or other areas with limited ventilation.

Starting to Drive

Turn on the vehicle and start the engine to begin driving.

■ Starting the Engine

1. Make sure the parking brake is applied.
The parking brake and brake system indicator comes on for 15 seconds when you press the electric parking brake switch.
2. Depress the brake pedal.
3. Press the ENGINE START/STOP button without depressing the accelerator pedal. The engine will crank until it starts.

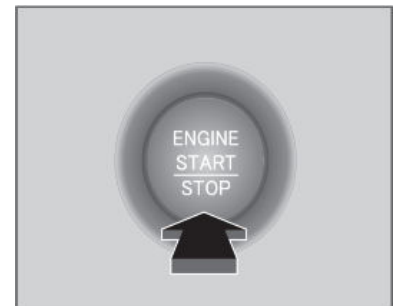
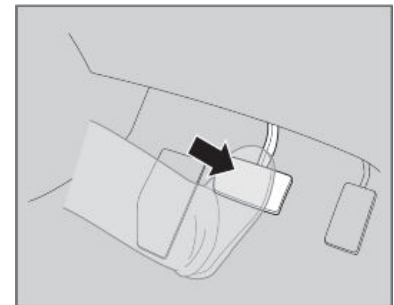

Note: The engine is harder to start in cold weather and in thinner air found at altitudes above 8,000 feet (2,400 m). When starting the engine in cold weather, turn off all electrical accessories such as the lights, climate control system, and rear defogger in order to reduce battery drain.

■ **Changing the Power Mode**

Use the **ENGINE START/STOP** button to cycle through power modes or start the engine.

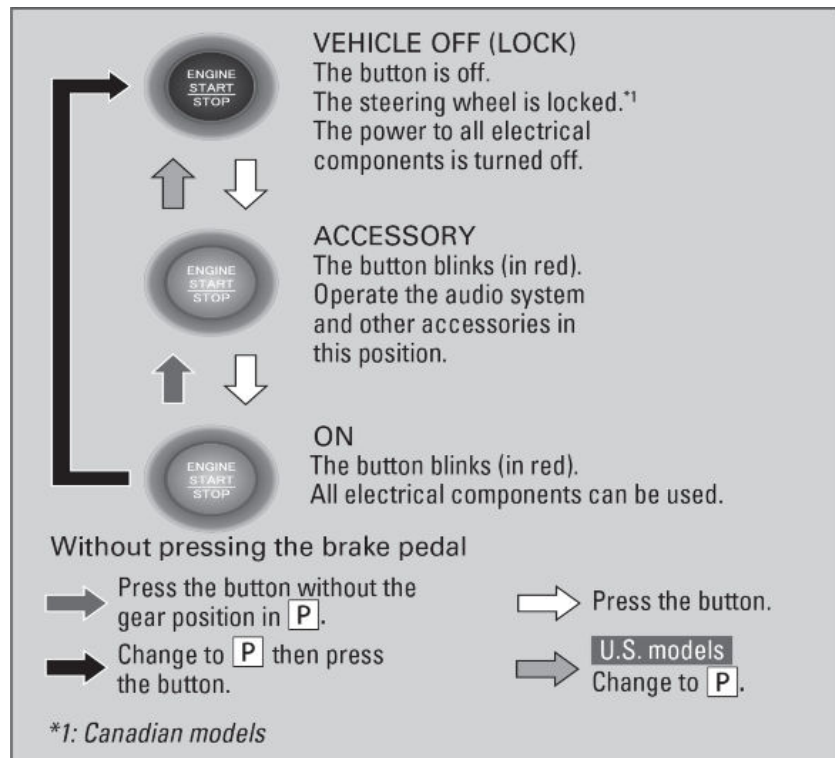

Shifting

Change the gear position based on your driving needs.

■ **Electronic Gear Selector**

Select the vehicle's gear using a simple button interface. Apply the brake pedal and select a gear.



- Park (P):** Press the (P) button to put the vehicle in Park.
- Reverse (R):** Pull back the (R) button to put the vehicle in Reverse.
- Neutral (N):** Press the (N) button to put the vehicle in Neutral. Transmission is not locked.

Drive/S Position (D/S):	Each time you press the D/S button, the mode switches between Drive and S mode. Used for:
Drive:	Normal driving (gears change between 1st and 9th automatically). Temporarily driving in the sequential mode.
S Position:	Automatically changing gears between 1st and 8th (8th gear is used only at high speed). Driving in the sequential mode.

⚠ WARNING

The vehicle can roll away if left unattended without confirming that Park (P) is engaged.

A vehicle that rolls away could cause a crash resulting in serious injury or death.

Always keep your foot on the brake pedal until you have confirmed that (P) is shown on the gear position indicator.

NOTICE

When you change from **D** to **R** and vice versa, or want to change to Park (P), come to a complete stop and keep the brake pedal applied. Operating the gear buttons before the vehicle has come to a complete standstill can damage the transmission.

Auto park mode

For your convenience, Park (P) is automatically engaged when the vehicle is turned off, or when all of the following conditions are met:

The vehicle is stopped with the engine running, the driver's seat belt is unbuckled, and the driver's door is opened. You should always apply the brake and shift to Park when idling, or before exiting the vehicle.

If you select any gear other than Park when the driver's door is opened and the driver's seat belt is unbuckled, Park is re-engaged when the brake pedal is released.

Car Wash Mode

Follow the procedure below to use a conveyor-style car wash where you or an attendant do not remain in the vehicle. Make sure the wiper lever is in the OFF position. You should inform the car wash attendant of this procedure.

1. With the engine running, press and hold the brake pedal.
2. Select (N), then release the button to display N (Neutral) hold mode on the driver information interface.
3. Press and hold (N) again for two seconds.

If the **ENGINE START/STOP** button is pressed after the car wash mode has been activated, the power mode will change to ACCESSORY and a message will be displayed on the driver information interface. After 15 minutes, the gear position changes to Park and the power mode changes to OFF.

- For 15 minutes the gear position remains in **N** and the power mode will remain in ACCESSORY. After that, the position automatically changes to **P** and the power mode changes to OFF.
- Manually changing to **P** cancels ACCESSORY mode. The **P** indicator comes on and the power mode changes to OFF. You must always shift to **P** when car wash mode is no longer needed.

NOTICE

When the transmission is too hot, car wash mode may not be available. Let the engine idle and cool down the transmission.

Auto Idle Stop

To help maximize fuel economy, the engine automatically stops when the vehicle comes to a stop, depending on environmental and vehicle operating conditions. The indicator (green) comes on at this time.

■ Activating Auto Idle Stop

When the vehicle stops with the gear position in Drive (D) and the brake pedal is pressed, the engine turns off and the green auto idle stop indicator appears.

If you release the brake pedal, turn the steering wheel, or press the accelerator pedal, the engine restarts and the vehicle begins to move.

Auto idle stop may not activate (or the engine may automatically restart) when the engine is warming up, the air conditioning system is on, the 12V battery is charging, or when other conditions are met. For a complete list of conditions, see your Owner's Manual at owners.honda.com (U.S.) or honda.ca (Canada).

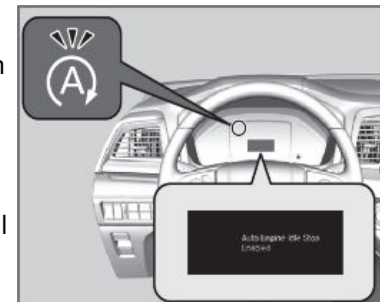

■ Turning the System On or Off

Press the Auto Idle Stop Off button to turn the system off. The amber auto idle stop indicator comes on. Press the button again to turn it on. The Auto Idle Stop system is turned on every time you start the engine, even if you turned it off the last time you drove the vehicle.

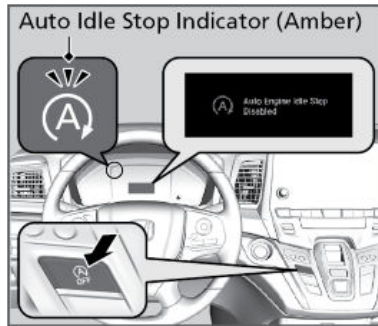

Braking

Slow down or stop your vehicle and keep it from moving when parked.

■ Foot Brake

Press the brake pedal to slow down or stop your vehicle from moving.

Your vehicle is equipped with disc brakes at all four wheels. A vacuum power assist helps reduce the effort needed on the brake pedal. The brake assist system increases the stopping force when you depress the brake pedal hard in an emergency situation. The anti-lock brake system (ABS) helps you retain steering control when braking very hard.

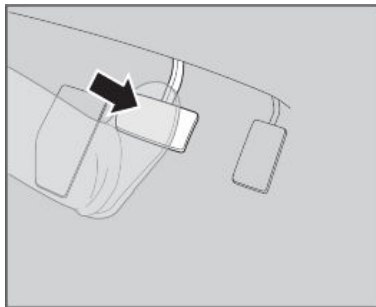

■ Parking Brake

Keep the vehicle from moving when parked.

To apply:

1. Press the parking brake switch.

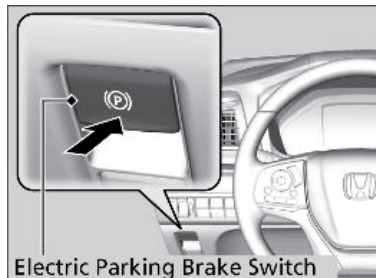

Electric Parking Brake Switch

To release:

1. Depress the brake pedal.
2. Pull the parking brake switch up.

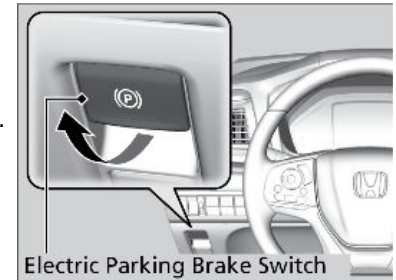

Electric Parking Brake Switch

If you press and hold the electric parking brake switch while driving the brakes on all four wheels are applied (by the VSA[®] system) until the vehicle comes to a stop (at which point the electric parking brake is applied) or the switch is released.

⚠ WARNING

The vehicle can roll away if left unattended without confirming that Park is engaged.

A vehicle that rolls away could cause a crash resulting in serious injury or death.

Always keep your foot on the brake pedal until you have confirmed that P is shown on the gear position Indicator.

■ Automatic Brake Hold

Keeps the brake applied after releasing the brake pedal until the accelerator pedal is pressed. You can use this system while the vehicle is temporarily stopped, like at traffic lights and in heavy traffic.

■ Turning on the system ■ Activating the system ■ Canceling the system



Automatic Brake Hold Button

Fasten your seat belt properly, then start the engine. Press the automatic brake hold button.

- The automatic brake hold system indicator comes on. The system is turned on.



Brake Pedal

Depress the brake pedal to come to a complete stop. The transmission must be in **D** or **N**.

- The automatic brake hold indicator comes on. Braking is kept for up to 10 minutes.
- Release the brake pedal after the automatic brake hold indicator comes on.



Accelerator Pedal

Depress the accelerator pedal while the transmission is in **D**. The system is canceled and the vehicle starts to move.

- The automatic brake hold system indicator comes on. The system continues to be on.

⚠ WARNING

Activating the automatic brake hold system on steep hills or slippery roads may still allow the vehicle to move if you remove your foot from the brake pedal.

If a vehicle unexpectedly moves, it may cause a crash resulting in serious injury or death.

Never activate the automatic brake hold system or rely on it to keep a vehicle from moving when stopped on a steep hill or slippery roads.

⚠ WARNING

Using the automatic brake hold system to park the vehicle may result in the vehicle unexpectedly moving.

If a vehicle moves unexpectedly, it may cause a crash, resulting in serious injury or death.

Never leave the vehicle when braking is temporarily kept by automatic brake hold and always park the vehicle by putting the transmission in **P** and applying the parking brake.

■ Brake Assist System

Designed to assist the driver by generating greater braking force when you depress the brake pedal hard during emergency braking.

Press the brake pedal firmly for more powerful braking. When brake assist operates, the pedal may wiggle slightly and an operating noise may be heard. This is normal. Keep holding the brake pedal firmly down.

■ Anti-Lock Brake System (ABS)

During hard or emergency braking, the system rapidly pumps the brakes to prevent wheel lockup and help you maintain steering control. You should never pump the brake pedal. Let the ABS work for you by always keeping firm, steady pressure on the brake pedal.

The electronic brake distribution (EBD) system, which is part of the ABS, also balances the front-to-rear braking distribution according to vehicle loading.

When ABS activates, you may notice vibrations through the brake pedal or the vehicle body, the brake pedal depressing further than usual, or hear a motor noise from the engine compartment. These are all normal.

NOTICE

The ABS may not function correctly if you use an incorrect tire type and size.

Intelligent Traction Management System*1

Optimizes vehicle performance to help you drive on snowy surfaces. The mode you select appears on the instrument display.

Normal: (Snow mode not selected) Provides balanced driving performance on most road surfaces.

Snow: Use when driving on snowy road surfaces.

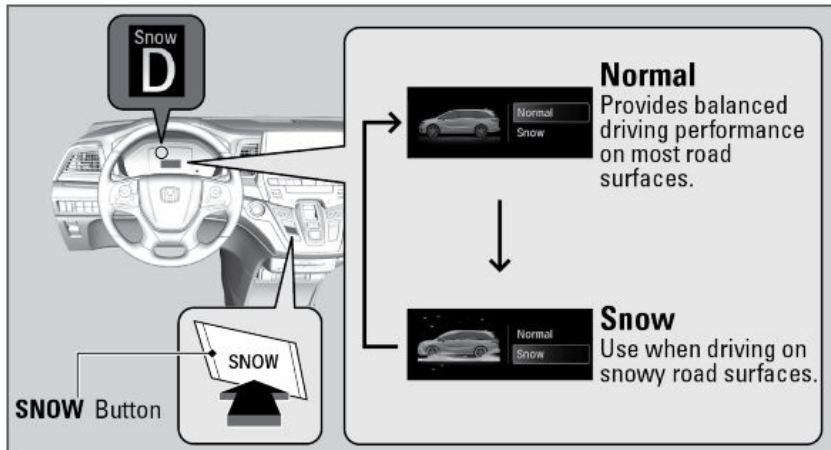

Ambient Meter

The color of the ambient meter changes to green to indicate that the vehicle is being driven in a fuel efficient manner.



ECON Mode

The **ECON** button turns the ECON mode on and off. The ECON mode helps you improve your fuel economy by adjusting the performance of the engine, air conditioning system, and cruise control.



Vehicle Stability Assist™ (VSA®) System

Helps to stabilize the vehicle during cornering if the vehicle turns more or less than what was intended. It also assists in maintaining traction on slippery surfaces by regulating engine and motor output and selectively applying the brakes. VSA is also known as Electronic Stability Control (ESC).

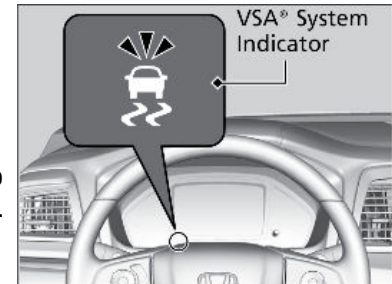

■ Turning the System On or Off

This button is on the driver side control panel.

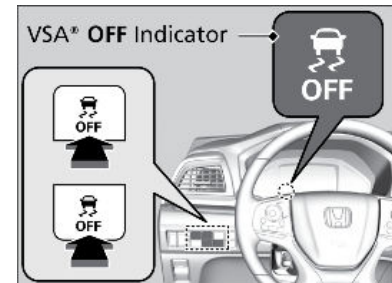

Honda Sensing^{®*1}

A driver support system which employs the use of two distinctly different kinds of sensors, a radar sensor located in the front grille and a front sensor camera mounted to the interior side of the windshield, behind the rearview mirror.

These are the components of Honda Sensing[®]:

Adaptive Cruise Control (ACC)^{*1}: Helps maintain a constant vehicle speed and a set following interval behind a vehicle detected ahead of yours, without you having to keep your foot on the brake or the accelerator.

Lane Keeping Assist System (LKAS)^{*1}

Provides steering input to help keep the vehicle in the middle of a detected lane and provides tactile and visual alerts if the vehicle is detected drifting out of its lane.

Road Departure Mitigation (RDM) System^{*1}: Alerts and helps to assist you when the system detects a possibility of your vehicle unintentionally crossing over detected lane markings and/or leaving the roadway altogether.

Collision Mitigation Braking System™ (CMBS™)^{*1}: Can assist you when there is a possibility of your vehicle colliding with a vehicle or a pedestrian detected in front of yours. The CMBS™ is designed to alert you when a potential collision is determined, as well as to reduce your vehicle speed to help minimize collision severity when a collision is deemed unavoidable.

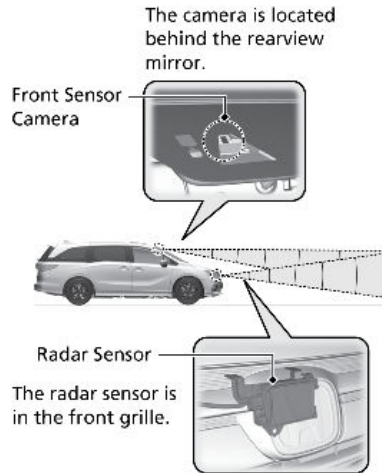

■ "Some Driver Assist Systems Cannot Operate:" Information Messages

Honda Sensing[®] is deactivated and a message appears when:

Radar Obstructed and Clean Front Windshield



Anything covers the radar sensor cover or the area around the front sensor camera preventing detection of a vehicle in front. May appear when driving in bad weather (rain, snow, fog, etc.).

- Stop your vehicle in a safe place and clear the area using a soft cloth.
- Have your vehicle checked by a dealer if the message does not disappear even after you clean the area.

Camera Temperature Too High



The temperature inside the front sensor camera is too high.

- Use the climate control system to cool the interior. Defroster mode will direct airflow toward the camera.

Cruise Control^{*1}

Maintain a constant vehicle speed without having to keep your foot on the accelerator pedal. Use cruise control on freeways or open roads where you can travel at a constant speed with little acceleration or deceleration.

**1 - If equipped*

■ **Activating and Setting the Vehicle Speed**

1. Press the CRUISE button. The CRUISE MAIN indicator appears.
2. Accelerate to the desired speed (above 25 mph/ 40 km/h). Take your foot off the pedal and press the -/SET button to set the speed. The CRUISE CONTROL indicator appears.

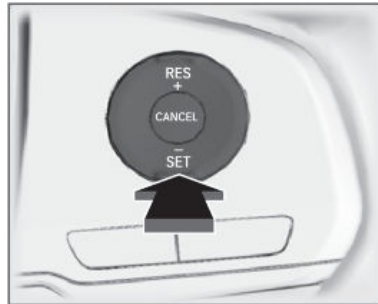

■ **Adjusting the Vehicle Speed**

Increase or decrease the vehicle speed using the RES/+ or SET/- button on the steering wheel.

- Each time you press the RES/+ or -/SET button, the vehicle speed is increased or decreased by about 1 mph or 1 km/h accordingly.
- If you press and hold the RES/+ or -/SET button, the vehicle speed increases or decreases by about 5 mph or 5 km/h accordingly.



■ **Canceling Cruise Control**

Press the CANCEL button, the MAIN button or the brake pedal. The CRUISE CONTROL indicator goes off.

After cruise control has been canceled, you can still resume the prior set speed by pressing the RES/+ button while driving at a speed of at least 25 mph (40 km/h).

Press CRUISE to turn the system off.

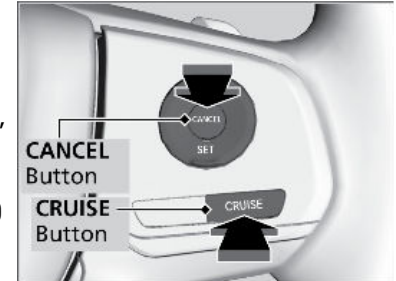

⚠ WARNING
Improper use of cruise control can lead to a crash. Use cruise control only when traveling on open highways in good weather.

Adaptive Cruise Control (ACC)*1

Helps maintain a constant vehicle speed and a set following interval behind a vehicle detected ahead of yours and, if the detected vehicle comes to a stop, can decelerate and stop your vehicle, without you having to keep your foot on the brake or the accelerator. When ACC slows your vehicle by applying the brakes, your vehicle's brake lights will illuminate.

ACC cannot be activated if Intelligent Traction Management setting is snow.

When to use

The camera is located behind the rearview mirror.

The radar sensor is inside the front grille.

- ☑ Vehicle speed for adaptive cruise control: Desired speed in a range above roughly 25 mph (40 km/h) ~
- ☑ Gear positions for adaptive cruise control: In D or S

■ **Activating and Setting the Vehicle Speed**

1. Press the MAIN button. The ACC indicator appears.



2. Accelerate to the desired speed.
Above 25 *mph* (40 *km/h*): Take your foot off the pedal and press the SET button to set the speed.

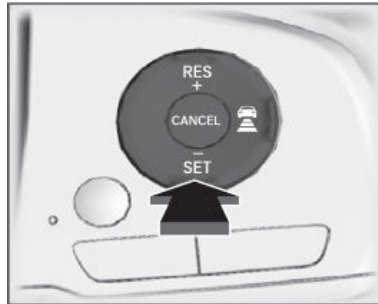

■ **Adjusting the Vehicle Speed**

Increase or decrease the vehicle speed using the RES/+ or SET/- button on the steering wheel.

- Each time you press the RES/+ or -/SET button, the vehicle speed is increased or decreased by about 1 *mph* or 1 *km/h* accordingly.
- If you press and hold the RES/+ or -/SET button, the vehicle speed increases or decreases by about 5 *mph* or 5 *km/h* accordingly.



■ **Adjusting the Vehicle Distance**

Press the Interval button to change the ACC following-interval. Each time you press the button, the following-interval setting cycles through extra long, long, middle, and short following-intervals.



⚠ WARNING
Improper use of ACC can lead to a crash.
Use ACC only when driving on expressways or freeways and in good weather conditions.

■ **During Operation**

ACC monitors if a vehicle ahead of you enters the ACC range. If a vehicle is detected doing so, the ACC system maintains or decelerates your vehicle's set speed in order to keep the vehicle's set following-interval from the vehicle ahead.

If a vehicle detected ahead of you slows down abruptly or if another vehicle cuts in front of you, the beeper sounds and a message appears on the driver information interface.

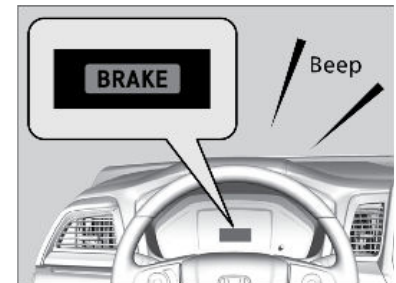

■ **Canceling ACC**

You can press the CANCEL button, MAIN button, or the brake pedal. The ACC indicator goes off.

Certain conditions may cause ACC to cancel automatically. When this happens, a beep sounds and a message appears on the driver information interface.

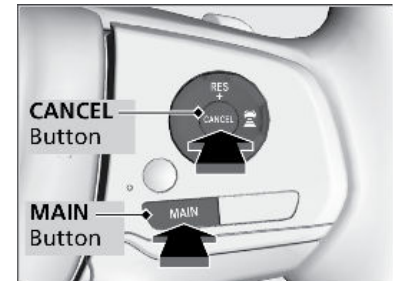

After cruise control has been canceled, you can still resume the prior set speed by pressing the RES/+ switch.

⚠ WARNING

Improper use of ACC can lead to a crash.

Use ACC only when driving on expressways or freeways and in good weather conditions.

⚠ WARNING

ACC has limited braking capability.

When your vehicle speed drops below 22 mph (35 km/h), ACC will automatically cancel and no longer will apply your vehicle's brakes.

Always be prepared to apply the brake pedal when conditions require.

■ **Switching to Standard Cruise Control**

Press and hold the Interval button for one second.

Cruise Mode Selected appears in the driver information interface for two seconds, and then the mode switches to Cruise.

To switch back to ACC, press and hold the interval button again for one second. **ACC Mode Selected** appears on the driver information interface for two seconds.

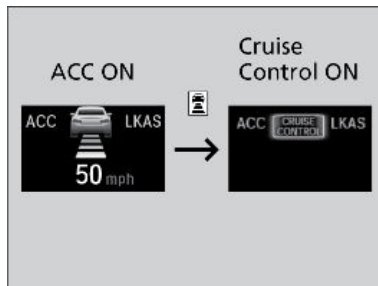

■ **Important Safety Reminder**

As with any system, there are limits to ACC. Use the brake pedal whenever necessary, and always keep a safe interval between your vehicle and other vehicles.

Lane Keeping Assist System (LKAS)*1

Provides steering input to help keep the vehicle in the middle of a detected lane and provides audible and visual alerts if the vehicle is detected drifting out of its lane while driving between 45–90 mph (72–145 km/h).

A camera mounted between the windshield and the rearview mirror determines if your vehicle begins to move away from the center of a detected lane while driving between 45–90 mph (72–145 km/h).

If you cross a detected lane line without using your turn signal, a message appears on the DII and the steering vibrates slightly.

Steering input assist
The system applies torque to the steering to keep the vehicle between the left and right lane lines. The applied torque becomes stronger as the vehicle gets closer to either of the lane lines.

Front sensor camera
Monitors the lane lines

Tactile and visual alerts
Rapid vibrations on the steering wheel and a warning display alert you that the vehicle is drifting out of a detected lane.

When you operate the turn signals to change lanes, the system is suspended, and resumes after the signals are off.
If you make a lane change without operating the turn signals, the LKAS alerts activate, and torque is applied to the steering.

■ Turning the System On or Off

1. Press the MAIN button. LKAS appears on the driver information interface.
2. Press the LKAS button. Lane outlines appear on the driver information interface. Dotted lane lines turn solid when the system activates.
3. Press the MAIN button or the LKAS button to turn the system off.



■ Important Safety Reminders

LKAS is for your convenience only. It is not a substitute for your vehicle control. The system does not work if you take your hands off the steering wheel or fail to steer the vehicle.

Do not place objects on the top of the instrument panel. They may reflect onto the windshield and prevent the system from detecting lane lines properly.

The LKAS only alerts you when lane drift is detected without a turn signal in use. The LKAS may not detect all lane markings or lane departures; accuracy will vary based on weather, speed, and lane marker condition.

It is always your responsibility to safely operate the vehicle and avoid collisions.

The LKAS is convenient when it is used on freeways.

Road Departure Mitigation (RDM)*1

Alerts and helps to assist you if the system determines a possibility of your vehicle unintentionally crossing over detected lane markings and/or leaving the roadway altogether while driving between 45-90 mph (72-145km/h).

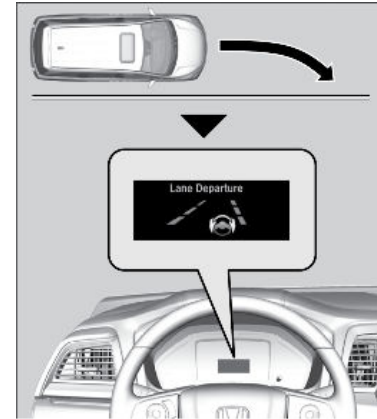

As a visual alert, the Lane Departure message appears on the driver information interface. If the system determines that its steering input is insufficient to keep your vehicle on the roadway, it may apply braking.

Braking is applied only when the lane markings are solid continuous lines.

If the system operates several times without detecting driver response, the system beeps to alert you

■ Turning the System On or Off

Press the RDM button to turn the system on or off. The indicator in the button comes on and the message appears on the driver information interface when the system is on.

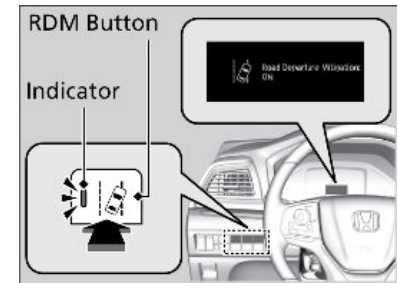

■ Changing Settings

Models with Display Audio

Determine the warning timing or turn the system off. The vehicle must be in Park (P) and the power mode ON.

1. Select HOME, then select Settings.
2. Select Vehicle.
3. Select Driver Assist System Setup.
4. Select Road Departure Mitigation Setting.
5. Select from the options.

■ Important Safety Reminder

The RDM system has limitations. Over-reliance on it may result in a collision. It is always your responsibility to keep your vehicle within the driving lane.

The RDM system only alerts you when lane drift is detected without a turn signal in use. The RDM system may not detect all lane marking or lane or roadway departures; accuracy will vary based on weather, speed, and lane marker condition. It is always your responsibility to safely operate the vehicle and avoid collisions.

Collision Mitigation Braking System™ (CMBS™)*1

Can assist you when there is a possibility of your vehicle colliding with a vehicle or a pedestrian detected in front of yours. CMBS™ is designed to alert you to a potential collision, as well as to reduce your vehicle speed to help minimize collision severity when a collision is deemed unavoidable. The CMBS™ activates when:

- The speed difference between your vehicle and a vehicle or pedestrian detected in front of you becomes about 3 mph (5 km/h) and over with a chance of a collision.
- Your vehicle speed is about 62 mph (100 km/h) or less and there is a chance of a collision with an oncoming detected vehicle or a pedestrian in front of you.

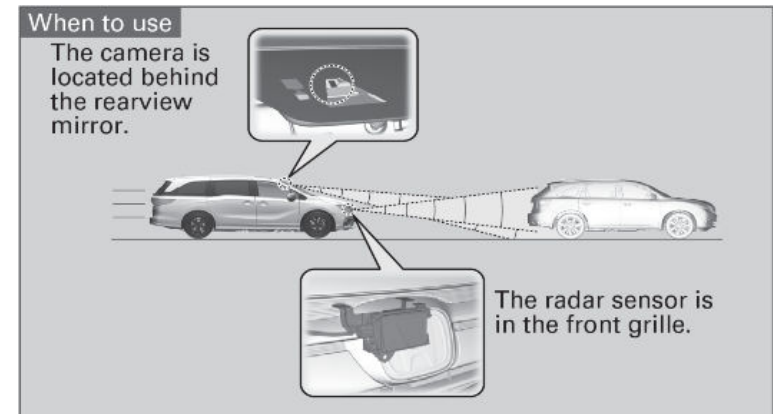

When a potential collision to an oncoming detected vehicle is determined, the system alerts you with rapid vibration on the steering wheel, in addition to visual and audible alerts. Take appropriate action to prevent a collision (apply the brakes, operate the steering wheel, etc.).

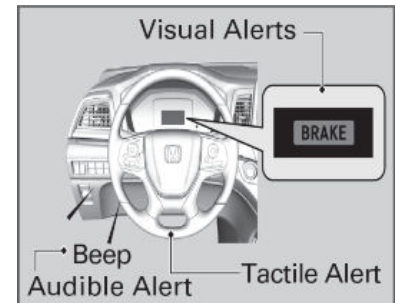

■ Alert Stages

The system has three alert stages for a possible collision. Depending on the circumstances or CMBS™ settings, CMBS™ may not go through all of the stages before initiating the last stage.

- Stage 1:** Visual and audible warning.
- Stage 2:** Visual and audible warning, light brake application.
- Stage 3:** Visual and audible warning, strong brake application.

■ Changing Settings

Determine the warning timing. The vehicle must be in Park (P).

1. Select HOME, then select Settings.
2. Select Vehicle.
3. Select Driver Assist System Setup.
4. Select Forward Collision Warning Distance.
5. Select from the options.

■ Turning the System On or Off

The CMBS™ is turned on every time you start the engine, even if you turned it off the last time you drove the vehicle.

Press and hold the button until the beeper sounds to switch the system on or off. When the CMBS™ is off:

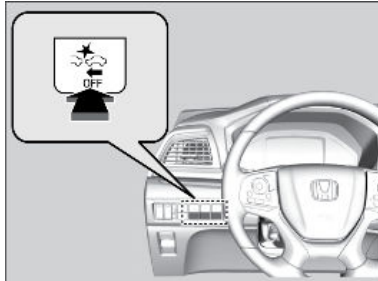

- The CMBS™ indicator in the instrument panel comes on.
- A message on the driver information interface reminds you that the system is off.

■ Important Safety Reminder

CMBS is designed to reduce the severity of an unavoidable collision. It does not prevent collisions nor stop the vehicle automatically. It is still your responsibility to operate the brake pedal and steering wheel appropriately according to the driving conditions.

Blind Spot Information System*1

Alerts you to a detected vehicle in your left or right blind spot while driving between 20 mph (32 km/h) and 100 mph (160 km/h). When the system detects vehicles approaching from behind in adjacent lanes, the appropriate indicator comes on for a few seconds, providing assistance when you change lanes.

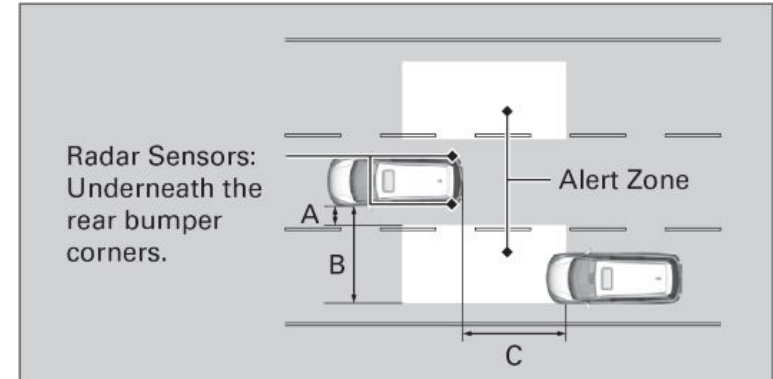

Blind Spot Information System Alert Indicator comes on when:

- A vehicle enters the alert zone from behind to overtake you with a speed difference of no more than 31 mph (50 km/h) from your vehicle.
- You pass a vehicle with a speed difference of no more than 12 mph (20 km/h).

Blinks and the beeper sounds when:

You move the turn signal lever in the direction of the detected vehicle. The beeper sounds three times.

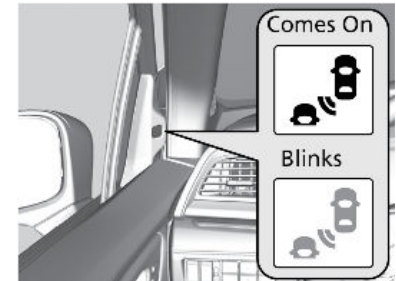

■ Changing Settings

Determine the warning type or turn the system off. The vehicle must be in Park (P).

1. Select HOME, then select Settings.
2. Select Vehicle.
3. Select Driver Assist System Setup.
4. Select Blind Spot Information.
5. Select an alert type or turn the system off.

*1 - If equipped

■ "Blind Spot Information Not Available" Information Message



The Blind Spot Information system is deactivated and a message appears when:

Mud, snow, or ice accumulates in the vicinity of the sensors.

- Stop your vehicle in a safe place and clear the area in the vicinity of the sensor on both sides of the vehicle. Refer to Blind Spot Information for the location of the sensors.

■ Important Safety Reminder

Like all assistance systems, the Blind Spot Information System has limitations. Over-reliance on the system may result in a collision. The system is for your convenience only.

⚠ WARNING

Failure to visually confirm that it is safe to change lanes before doing so may result in a crash and serious injury or death.

Do not rely only on the blind spot information system when changing lanes.

Always look in your mirrors, to either side of your vehicle, and behind you for other vehicles before changing lanes.

LaneWatch™*4

LaneWatch is an assistance system that allows you to check the passenger side rear areas displayed on the audio/information screen when the turn signal is activated to the passenger's side. A camera in the passenger side door mirror monitors these areas and allows you to check for vehicles, in addition to your visual check and use of the passenger door mirror. You can also keep the system on for your convenience while driving.

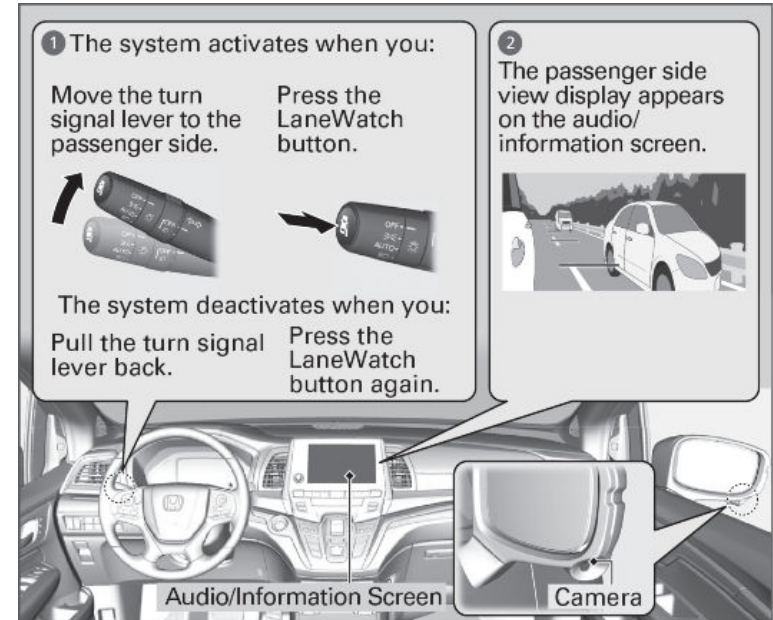

⚠ WARNING

Failure to visually confirm that it is safe to change lanes before doing so may result in a crash and serious injury or death.

Do not rely only on LaneWatch while driving.

Always look in your mirrors, to either side of your vehicle, and behind you for other vehicles before changing lanes.

■ Activating LaneWatch

Activate the right turn signal. The LaneWatch display appears. Check the display for blind spots, and visually confirm that it is safe to change lanes.

You can also press the LaneWatch button on the end of the turn signal switch to view a constant real-time display. Press it again to turn the display off.

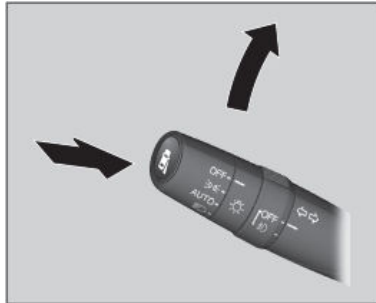

■ Changing Settings

Customize the display and how and when the display appears.

Models with Display Audio

1. Select Home, then select Settings.
2. Select Camera.
3. Select LaneWatch.
4. Select from the options.

■ Important Safety Reminder

Like all assistance systems, LaneWatch has limitations. Over-reliance on the system may result in a collision.

Parking Sensor System*¹

The corner and center sensors monitor obstacles near your vehicle. The beeper and audio/information screen let you know the approximate distance between your vehicle and the obstacle. As you get closer to the object, the beep rate increases and the screen indicators blink yellow, amber, or red depending on proximity to object.

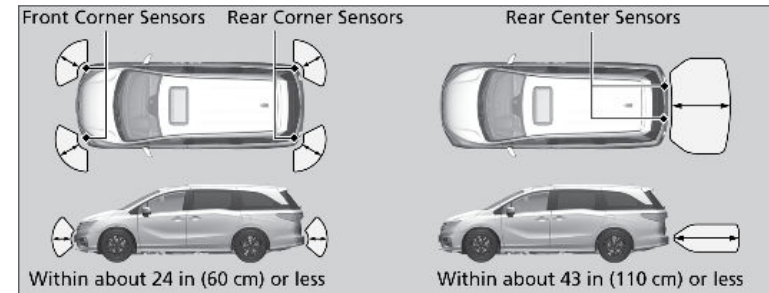

■ Turning the System On or Off

With the power mode in ON, press the parking sensor system button to turn on or off the system. The indicator in the button comes on when the system is on.

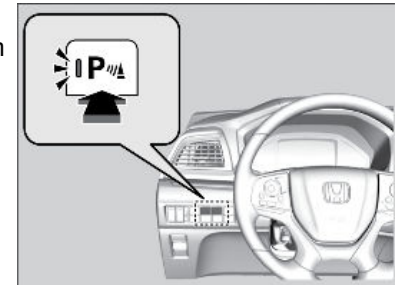

Cross Traffic Monitor*1

Alerts you if a detected vehicle is approaching from a rear corner when your vehicle is in Reverse (R) at speeds of 3 mph (5 km/h) or lower.

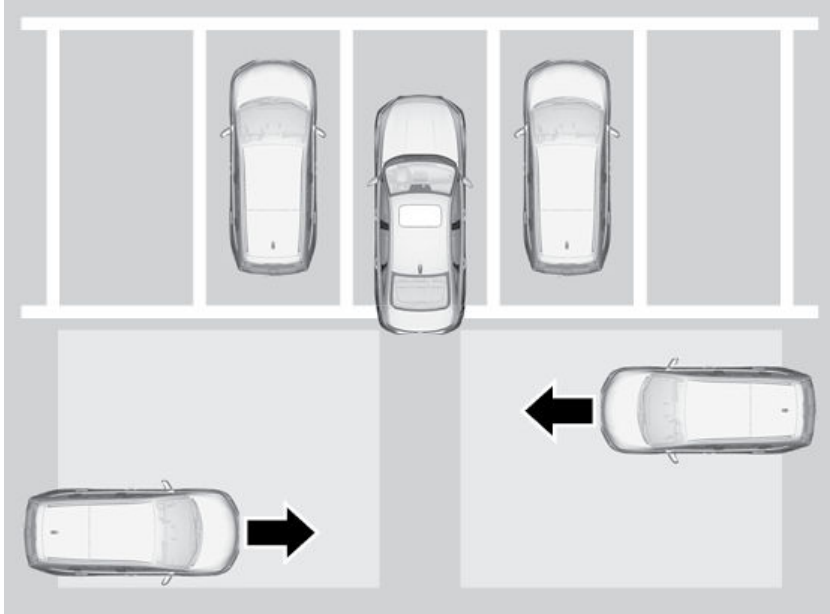

When a vehicle is detected approaching from a rear corner, Cross Traffic Monitor alerts you with a buzzer and a displayed warning.

The system will not detect a vehicle that approaches from directly behind your vehicle, nor will it provide alerts about a detected vehicle when it moves directly behind your vehicle.

The system does not provide alerts for a vehicle that is moving away from your vehicle, and it may alert for pedestrians, bicycles, or stationary objects.

Turning the System On or Off

Models with Display Audio

1. Select HOME, then select Settings.
2. Select Camera.
3. Select Rear Camera.
4. Select Cross Traffic Monitor.
5. Select On or Off.

The system can also be turned on and off on the audio/information screen by pressing the CTM icon.

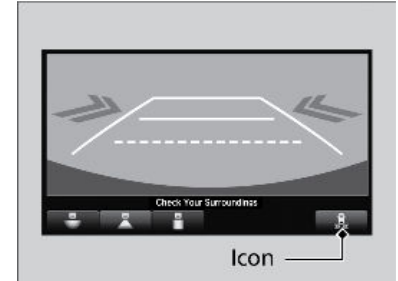

⚠ WARNING

Cross Traffic Monitor cannot detect all approaching vehicles and may not detect an approaching vehicle at all.

Failure to visually confirm that it is safe to back up the vehicle before doing so may result in a collision.

Do not solely rely on the system when reversing; always also use your mirrors, and look behind and to the sides of your vehicle before reversing.

*1 - If equipped

Multi-View Rear Camera

The audio/information screen can display your vehicle's rear view. The display automatically changes to the rear view when the transmission is put into Reverse (R).

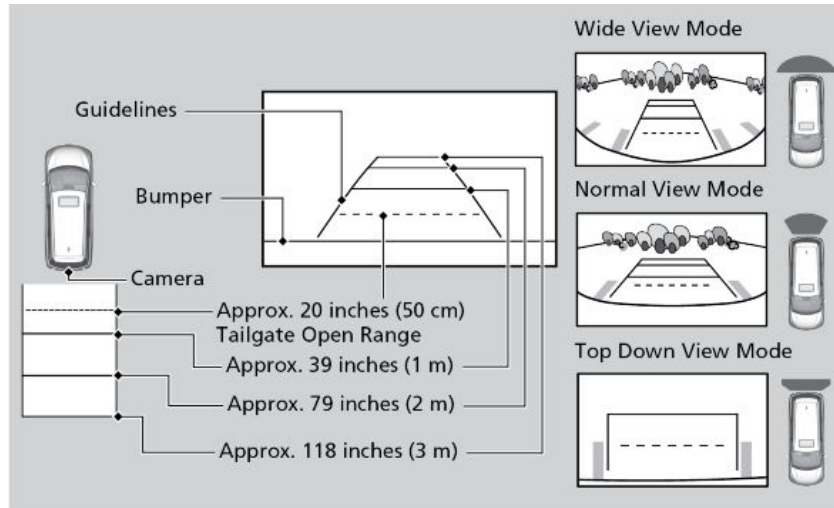

The rear camera view is restricted. You cannot see the corner ends of the bumper or what is underneath the bumper. Its unique lens also makes objects appear closer or farther than they actually are.

Visually confirm that it is safe to drive before backing up. Certain conditions (such as weather, lightning, and high temperatures) may also restrict the rear view. Do not rely on the rearview display, which does not give you all the information about conditions at the rear of your vehicle.

■ Changing Settings

Turn the guidelines on or off.

Models with Color Audio

1. Press the MENU/CLOCK button, select Settings.
2. Select Rear Camera.
3. Select Camera Guideline.
4. Select from the available choices.

Models with Display Audio

1. Press HOME.
2. Select Settings.

3. Select Camera.
4. Select Rear Camera.
5. Select Guidelines.
6. Select from the available choices.

Improving Fuel Economy and Reducing CO₂ Emissions

Achieving fuel economy and reducing CO₂ emissions is dependent on several factors, including driving conditions, load weight, idling time, driving habits, and vehicle condition. Depending on these and other factors, you may not achieve the rated fuel economy of this vehicle.

Refueling

Use the proper fuel and refueling procedure to ensure the best performance and safety of your vehicle.

■ Fuel Information

Use of unleaded gasoline of 87 octane or higher is recommended.

- Honda recommends TOP TIER Detergent Gasoline where available.
- Do NOT use gasoline containing more than 15% ethanol.
- Do NOT use gasoline containing methanol.
- Do NOT use gasoline containing MMT.

NOTICE

We recommend quality gasoline containing detergent additives that help prevent fuel system and engine deposits. In addition, in order to maintain good performance, fuel economy, and emissions control, we strongly recommend the use of gasoline that does NOT contain harmful manganese-based fuel additives such as MMT, if such gasoline is available.

■ How to Refuel

Your fuel tank is not equipped with a fuel filler cap. You can insert the filler nozzle directly into the filler neck. The tank seals itself again when you pull out the filler nozzle.

1. The fuel fill door is located at the left rear of the vehicle. Park next to the service pump that is most accessible.
2. Turn off the engine.
3. Press the fuel door release button. The fuel fill door opens
4. Insert the filler nozzle fully. When the tank is full, the nozzle clicks off automatically. Wait about 5 seconds before removing the filler nozzle.
5. Close the fuel fill door.

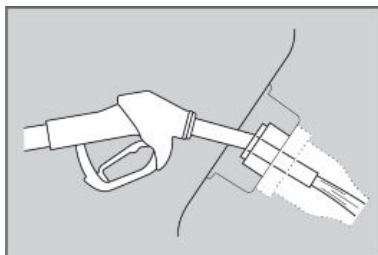

⚠ WARNING

Gasoline is highly flammable and explosive.

You can be burned or seriously injured when handling fuel.

- Stop the engine, and keep heat, sparks, and flame away.
- Handle fuel only outdoors.
- Wipe up spills immediately.

■ Refueling from a Portable Fuel Container

If you need to refuel your vehicle from a portable fuel container, use the funnel provided with your vehicle.

1. Turn off the engine.
2. Press on the edge of the fuel fill door to make it pop up slightly. The fuel fill door opens.

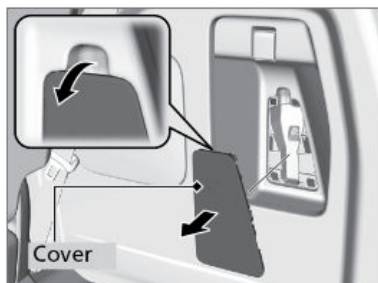

3. Remove the cover on the right side panel of the cargo area. Pick up the funnel from the cover (as shown).
4. Place the end of the funnel on the lower part of the filler opening, then insert it slowly and fully.

Make sure that the end of the funnel goes down along with the filler pipe.

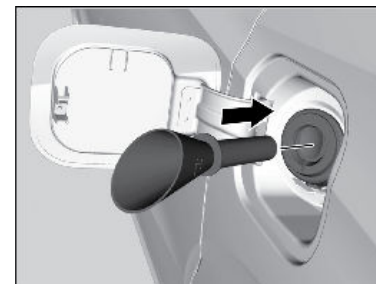
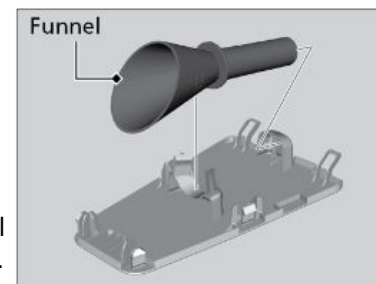

5. Fill the tank with fuel from the portable fuel container. Pour fuel carefully so you do not spill any.
6. Remove the funnel from the filler neck. Wipe up any fuel from the funnel before storing it.
7. Shut the fuel fill door by hand.

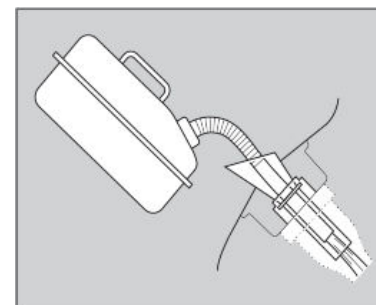

NOTICE

Do not insert the nozzle of a portable fuel container or any funnel other than the one provided with your vehicle. Doing so can damage the fuel system. Do not try to pry open or push open the sealed fuel tank with foreign objects. This can damage the fuel system and its seal.

HANDLING THE UNEXPECTED

Learn about what to do in critical or emergency situations.

Smart Entry System Battery Strength

If the beeper sounds, the **To Start, Hold Remote Near Start Button** message appears on the driver information interface, and the indicator on the **ENGINE START/STOP** button flashes, and the engine won't start. Start the engine as follows:

1. Touch the center of the **ENGINE START/STOP** button with the **A** logo on the keyless access remote while the indicator on the **ENGINE START/STOP** button is flashing. The buttons on the keyless access remote should be facing you.

The **ENGINE START/STOP** button flashes for about 30 seconds.

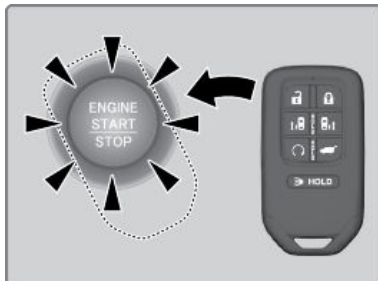

2. Depress the brake pedal and press the **ENGINE START/STOP** button within 10 seconds after the beeper sounds and the **ENGINE START/STOP** button changes from flashing to on.

If you do not depress the pedal, the mode will change to **ACCESSORY**.

Jump Starting

Turn off the power to electric devices, such as audio and lights. Turn off the engine, then open the hood.

1. Connect the first jumper cable to your vehicle's battery (+) terminal.
2. Connect the other end of the first jumper cable to the booster battery (+) terminal.

If you use a booster battery, only use a 12-volt booster battery.

When using an automotive battery charger, select a charging voltage lower than 15-volt. Check the charger manual for the proper setting.

3. Connect the second jumper cable to the booster battery (-) terminal.

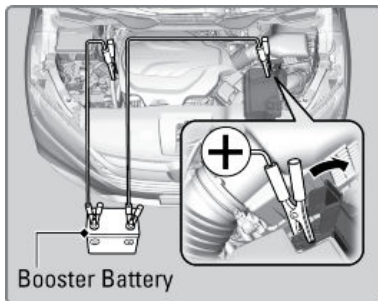

4. Connect the other end of the second jumper cable to the engine mounting bolt (as shown). Do not connect this jumper cable to any other part.

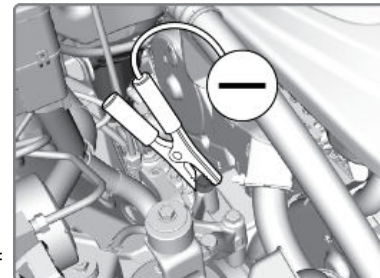

5. If your vehicle is connected to another vehicle, start the assisting vehicle's engine and increase its rpm slightly.
6. Attempt to start your vehicle's engine. If it turns over slowly, make sure that the jumper cables have good metal-to-metal contact.

Securely attach the jumper cables clips so that they do not come off when the engine vibrates. Also be careful not to tangle the jumper cables or allow the cable ends to touch each other while attaching or detaching the jumper cables. Battery performance degrades in cold conditions and may prevent the engine from starting.

What to Do After the Engine Starts

Once your vehicle's engine has started, remove the jumper cables in the following order:

1. Disconnect the jumper cable from your vehicle's ground.
2. Disconnect the other end of the jumper cable from the booster battery (-) terminal.
3. Disconnect the jumper cable from your vehicle's battery (+) terminal.
4. Disconnect the other end of the jumper cable from the booster battery (+) terminal.

Have your vehicle inspected by a nearby service station or a dealer.

⚠ WARNING

A battery can explode if you do not follow the correct procedure, seriously injuring anyone nearby.

Keep all sparks, open flames, and smoking materials away from the battery.

⚠ WARNING

Battery posts, terminals, and related accessories contain lead and lead compounds.

Wash your hands after handling.

Overheating

Signs your engine is overheating:

- The temperature gauge needle is at the H mark.
- The engine suddenly loses power.
- Steam or spray comes out from under the engine compartment.
- The message **Stop Driving When Safe. Engine Temperature Too Hot** appears on the driver information interface.

First thing to do:

1. Immediately park the vehicle in a safe place. Turn off all accessories and turn on the hazard warning lights.
2. If no steam or spray is present: Keep the vehicle running and open the hood (See Under the Hood).

If steam or spray is present: Turn off the engine and wait until it subsides. Then, open the hood (See Under the Hood).

3. Check that the cooling fan is operating and stop the engine once the temperature gauge pointer comes down. If the cooling fan is not operating, immediately stop the engine.
4. Once the engine has cooled down, inspect the coolant level and check the cooling system components for leaks. If the coolant level in the reserve tank is low, add coolant until it reaches the MAX mark. If there is no coolant in the reserve tank, make sure the radiator is cool, then cover the radiator cap with a heavy cloth and open the cap. If necessary, add coolant up to the base of the filler neck and put the cap back on.

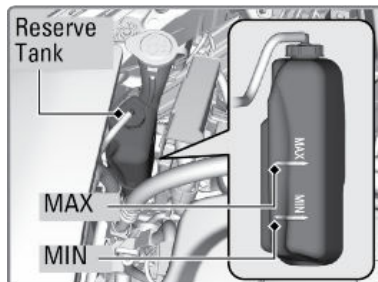

Once the engine has cooled sufficiently, restart it and check the temperature gauge. If the temperature gauge pointer has gone down, resume driving. If it has not gone down, contact a dealer for repairs.

If the coolant is leaking, contact a dealer for repairs.

Use water as an emergency/temporary measure only. Have a dealer flush the system with proper antifreeze as soon as possible.

NOTICE

Continuing to drive with the temperature gauge needle at the H mark may damage the engine.

⚠ WARNING

Steam and spray from an overheated engine can seriously scald you. Do not open the hood if steam is coming out.

⚠ WARNING

Removing the radiator cap while the engine is hot can cause the coolant to spray out, seriously scalding you.

Always let the engine and radiator cool down before removing the radiator cap.

Emergency Engine Stop

The ENGINE START/STOP button may be used to stop the engine due to an emergency situation even while driving. If you must stop the engine, choose one of the following operations:

- Press and hold the ENGINE START/STOP button for two seconds, **or**
- Firmly press the ENGINE START/STOP button three times.

The steering wheel will not lock. However, because turning off the engine disables the power assist the engine provides to the steering and braking systems, it will require significantly more physical effort and time to steer and slow the vehicle. Use both feet on the brake pedal to slow down the vehicle and stop immediately in a safe place.

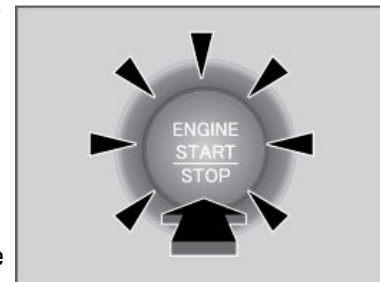

U.S. models: The gear position automatically changes to Park (P) after the vehicle comes to a complete stop. Then, the power mode changes to VEHICLE OFF.

Canadian models: The gear position automatically changes to P after the vehicle comes to a complete stop. Then press the ENGINE START/STOP button twice without depressing the brake pedal to change the mode to VEHICLE OFF.

NOTICE

Do not press the **ENGINE START/STOP** button while driving unless it is absolutely necessary for the engine to be switched off.

If you press the **ENGINE START/STOP** button while driving, the beeper sounds.

Emergency Towing

Call a professional towing service if you need to tow your vehicle.

Flat bed equipment: The operator loads your vehicle on the back of a truck. **This is the only way to transport your vehicle.** Any other towing method will damage the vehicle's drive system.

NOTICE

Trying to lift or tow your vehicle by the bumpers will cause serious damage. The bumpers are not designed to support the vehicle's weight.

Improper towing such as towing behind a motorhome or other motor vehicle can damage the transmission.

Never tow your vehicle with just a rope or chain. It is very dangerous since ropes or chains may shift from side to side or break.

Tire Pressure Monitoring System (TPMS) with Tire Fill Assist

Monitors the tire pressure while you are driving.

If your vehicle's tire pressure becomes significantly low, the Low Tire Pressure/TPMS indicator comes on and a message appears on the driver information interface.

Tire Pressures Low is displayed when a tire has significantly low pressure. The specific tire is displayed on the screen.

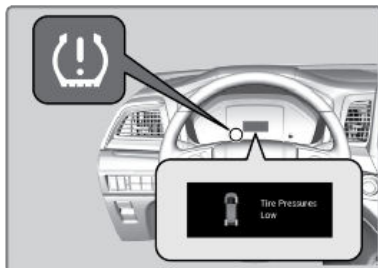

■ What to Do

If the indicator comes on and stays on, stop your vehicle in a safe place. Check the tire pressure and adjust the pressure to the specified level. The specified tire pressure is on a label on the driver's doorjamb.

If the indicator blinks, have the tire inspected by a dealer as soon as possible. If the compact spare tire causes the indicator to blink, change the tire to full-size tire. The indicator goes off after driving for a few miles (kilometers).

NOTICE

Driving on an extremely underinflated tire can cause it to overheat.

An overheated tire can fail.

Always inflate your tires to the prescribed level.

■ Tire Fill Assist

The TPMS audibly and visually informs you of changes in tire pressure of the individual tire that you are adjusting using audible and visual indications. The TPMS audibly and visually informs you of changes in tire pressure of the individual tire that you are adjusting using audible and visual indications.

If a change in tire pressure has been significant, the system beeps and the hazard lights flash continuously for five seconds when the specified tire pressure is reached. Stop filling the tire.

If you replace a flat tire with the spare tire, the low tire pressure/TPMS indicator comes on while you are driving. After driving for a few miles (kilometers), Tire Pressure Monitor Problem will appear on the driver information interface and the indicator will start blinking for a short time and then stay on; however, this is normal and is no cause for concern.

If you replace the tire with a full-size tire, the warning message on the driver information interface and the low tire pressure/TPMS indicator will go off after a few miles (kilometers).

Use the TPMS specific wheels. Each is equipped with a tire pressure sensor mounted inside the tire behind the valve stem.

■ Tire Pressure Monitoring System (TPMS) - Required Federal Explanation

U.S. models

Each tire, including the spare (if provided), should be checked monthly when cold and inflated to the inflation pressure recommended by the vehicle manufacturer on the vehicle placard or tire inflation pressure label.

(If your vehicle has tires of a different size than the size indicated on the vehicle placard or tire inflation pressure label, you should determine the proper tire inflation pressure for those tires.)

As an added safety feature, your vehicle has been equipped with a tire pressure monitoring system (TPMS) that illuminates a low tire pressure telltale  when one or more of your tires is significantly under-inflated.

Accordingly, when the low tire pressure telltale illuminates, you should stop and check your tires as soon as possible, and inflate them to the proper pressure.

Driving on a significantly under-inflated tire causes the tire to overheat and can lead to tire failure. Under-inflation also reduces fuel efficiency and tire tread life, and may affect the vehicle's handling and stopping ability.

Please note that the TPMS is not a substitute for proper tire maintenance, and it is the driver's responsibility to maintain correct tire pressure, even if

under-inflation has not reached the level to trigger illumination of the TPMS low tire pressure telltale.

Your vehicle has also been equipped with a TPMS malfunction indicator to indicate when the system is not operating properly. The TPMS malfunction indicator is combined with the low tire pressure telltale. When the system detects a malfunction, the telltale will flash for approximately one minute and then remain continuously illuminated. This sequence will continue upon subsequent vehicle start-ups as long as the malfunction exists.

When the malfunction indicator is illuminated, the system may not be able to detect or signal low tire pressure as intended.

TPMS malfunctions may occur for a variety of reasons, including the installation of replacement or alternate tires or wheels on the vehicle that prevent the TPMS from functioning properly.

Always check the TPMS malfunction telltale after replacing one or more tires or wheels on your vehicle to ensure that the replacement or alternate tires and wheels allow the TPMS to continue to function properly.

Changing a Tire

If a tire goes flat while driving, grasp the steering wheel firmly and brake gradually to reduce speed. Then stop in a safe place.

Replace the flat tire with the compact spare tire.

Go to a dealer as soon as possible to have the full-size tire repaired or replaced.

When driving with the compact spare on the vehicle, indicators that certain vehicle features are not working properly may appear on the dash. If these indicators remain on after the tire is replaced with the correct specified regular tire, have your vehicle checked by a dealer.

■ Getting Ready to Change the Tire

1. Park the vehicle on firm, level, non-slippery surface and set the parking brake.
2. Press the P button.
3. Turn on the hazard warning lights and set the ENGINE START/STOP button to VEHICLE OFF (LOCK).

4. Remove the floor mat under the second row seat and pull up the carpet. Remove the floor lid.

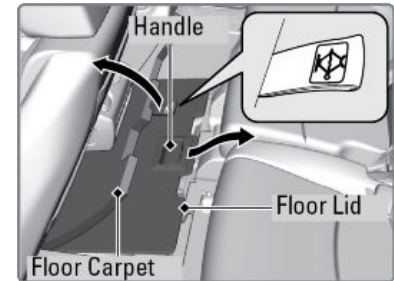

5. Take the tool case out of the spare tire well. Take the jack and wheel nut wrench out of the tool case.

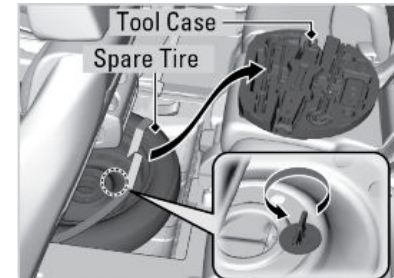

6. Unscrew the wing bolt, and remove the spacer cone. Then, remove the spare tire.
7. Place a wheel block or rock in the front and rear of the wheel diagonal to the flat tire.

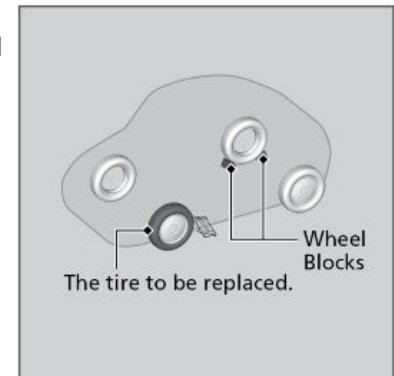

8. Place the compact spare tire (wheel side up) under the vehicle body, near the tire that needs to be replaced.



- Loosen each wheel nut about one turn using the wheel nut wrench.



NOTICE

Do not use the jack if it doesn't work properly. Call your dealer or a professional towing service.

The wheel nut wrench supplied with your vehicle is specially adapted to fit the hoist shaft. Do not use any other tool.

■ Setting Up the Jack

- Place the jack under the jacking point closest to the tire to be changed.

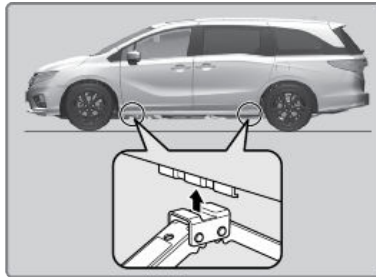

- Turn the end bracket clockwise (as shown in the image) until the top of the jack contacts the jacking point. Make sure that the jacking point tab is resting in the jack notch.

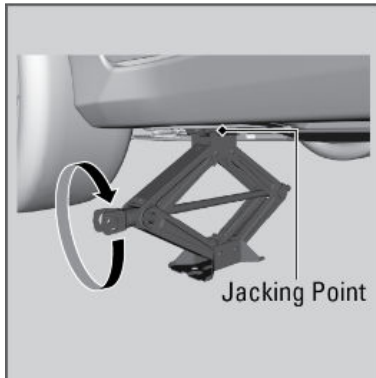

- Raise the vehicle, using the jack handle bar and the jack handle, until the tire is off the ground.



⚠ WARNING

The vehicle can easily roll off the jack, seriously injuring anyone underneath.

Follow the directions for changing a tire exactly, and no person should place any portion of their body under a vehicle that is supported by a jack.

Attention: The jack shall be placed on a flat and stable surface on the same level as the vehicle is parked.

The following instructions must be followed to use the jack safely:

- Do not use the jack with people or luggage in the vehicle.
- Use the jack provided in your vehicle. Other jacks may not support the weight (load) or fit the jacking point.
- Do not use while the engine is running.
- Use only where the ground is firm and level.
- Use only at the jacking points.
- Do not get in the vehicle while using the jack.
- Do not put anything on top of or underneath the jack.

Models with power sliding doors

Turn off the sliding door main switch before replacing a rear tire. If the main switch is on, the power sliding door may accidentally operate, causing an accident.

■ Replacing the Flat Tire

1. Remove the wheel nuts and flat tire.



2. Wipe the mounting surfaces of the wheel with a clean cloth. Mount the compact spare tire. Screw the wheel nuts until they touch the lips around the mounting holes, then stop rotating.

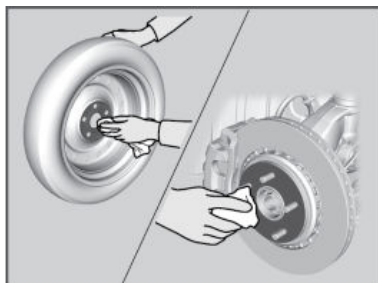

3. Lower the vehicle and remove the jack. Tighten the wheel nuts in the order indicated in the image. Go around, tightening the nuts, two to three times in this order.

Wheel nut torque: 94 lbf-ft (127 N-m, 13.0 kgf-m)

Do not over tighten the wheel nuts by applying extra torque using your foot or a pipe.

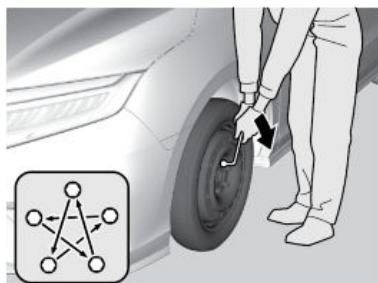

If you drive with the spare tire installed, the low tire pressure/TPMS indicator appears. The indicator stays on until a regular tire is installed and the TPMS system is recalibrated.

■ Storing the Flat Tire

1. The storage bag, bracket, mounting wing bolt (A) and mounting wing bolt (B) are in the tool case.

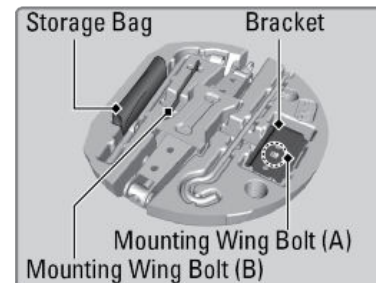

2. Put the flat tire in the storage bag provided with your vehicle.

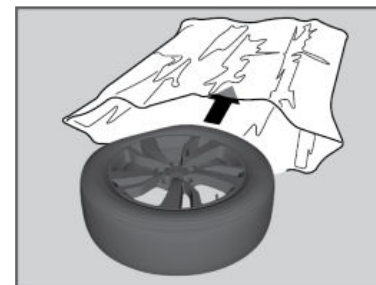

3. On the driver's side of the third row seat, pull down the U-shaped carpet piece and use a coin to remove the plastic screw. Install the bracket and the mounting wing bolt (A) on the attachment point and tighten the bolt. Install the flat tire on the bracket with the inside of the wheel facing toward you.

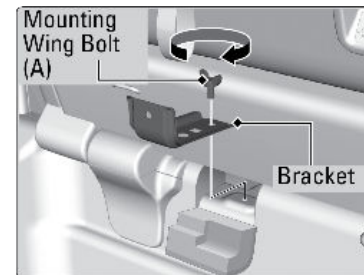
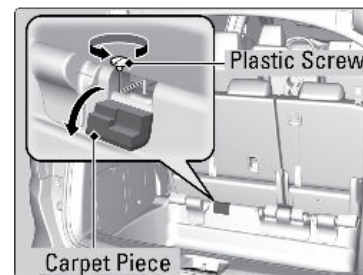

4. Install the mounting wing bolt (B) to the bracket through one of the five wheel nut holes and tighten the bolt. As needed, poke a hole in the storage bag.

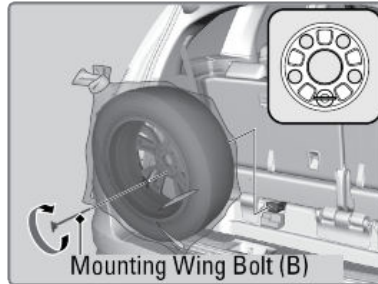

Storing a Flat Tire on the Folded Third Row Seat

1. Turn over the flap on the left side of the cargo area floor.
2. Pull down the U-shaped carpet and remove the plastic screw with a coin.
3. Place the flat tire face down on the attachment point.
4. Put the tire mounting wing bolt (B) in the attachment point through one of the five wheel nut holes, and tighten the bolt. Poke a hole in the storage bag as needed.

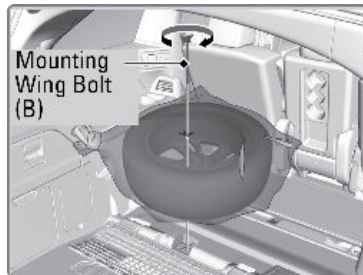
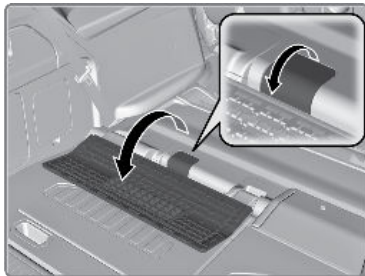

The compact spare tire and wheel in your vehicle are specifically for this model. Do not use them with another vehicle. Do not use another type of compact spare tire or wheel with your vehicle.

Do not mount tire chains on a compact spare tire. If a chain-mounted front tire goes flat, remove one of the full-size rear tires and replace it with the compact spare tire. Remove the flat front tire and replace it with the full-size tire that was removed from the rear.

Mount the tire chains on the front tire.

Do not use a puncture-repairing agent on a flat tire, as it can damage the tire pressure sensor.

Do not use the jack if it doesn't work properly. Call your dealer or a professional towing service.

⚠ WARNING

Loose items can fly around the interior in a crash and can seriously injure the occupants.

Store the wheel, jack, and tools securely before driving.

Fuse Locations

If any electrical devices are not working, turn the power mode to VEHICLE OFF and check to see if any applicable fuse is blown. Fuse locations are shown on the fuse box cover. Locate the fuse in question by the fuse number and box cover number. Refer to the Owner's Manual at owners.honda.com for a complete fuse chart.

■ Engine Compartment Fuse Box

Fuse Box A

Located at the rear of the engine compartment, on the passenger side. Push the tabs to open the box.

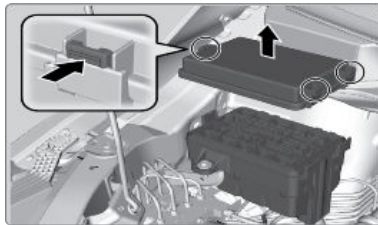

Fuse Box B

Located on the battery (+) terminal. Remove the engine compartment cover and the air intake duct (tools will be needed). Remove the cover on the (+) terminal (as shown). Have a dealer replace these fuses.

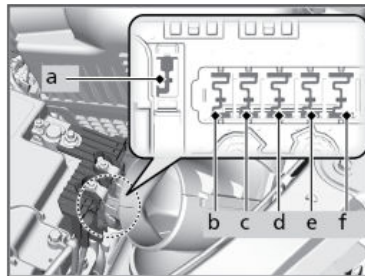
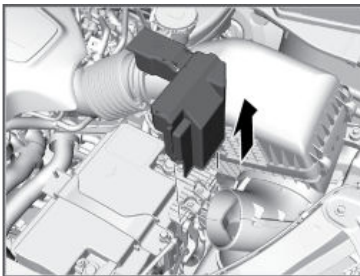

■ Driver's Side Interior Fuse Box

Driver's Side Interior Fuse Box Type A

Located under the dashboard. Fuse locations are shown on the label on the outer side of the side panel cover. Locate the fuse in question by the fuse number and label number.

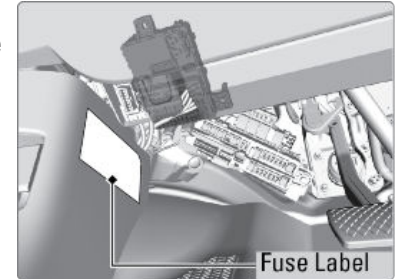

Fuse Box B

Located under the dashboard.

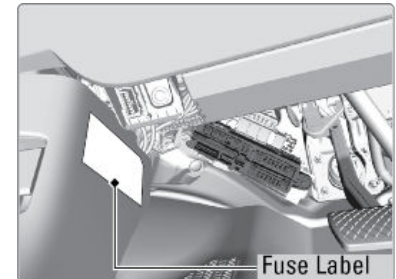

Fuse Box C

Located under the dashboard.

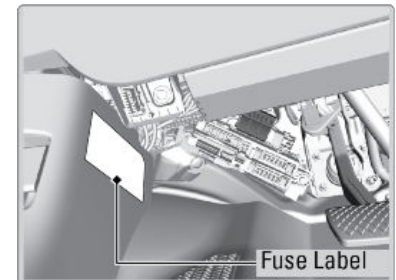

Rear Side Interior Fuse Box

Located on the left side of the cargo area. Remove the cover by prying on the edge of the cover using a flat-tip screwdriver. Wrap the flat-tip screwdriver with a cloth to prevent scratches. Fuse locations are shown on the cover.

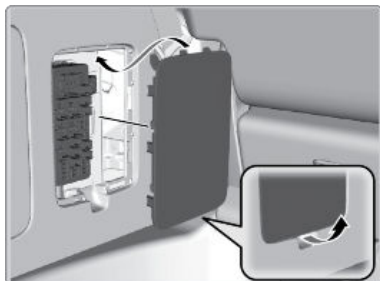

■ Inspecting and Changing Fuses

1. Set the power mode to VEHICLE OFF. Turn headlights and all accessories off.
2. Check the fuses on the battery in the engine compartment. If the fuse is blown, have it replaced by a dealer.
3. Remove the fuse box cover.
4. Inspect the small fuses in the engine compartment and the vehicle interior. If there is a blown fuse, remove it with the fuse puller and replace it with a new one.
5. Check the large fuse in the vehicle interior. If the fuse is blown, use a Phillips-head screwdriver to remove the screw and replace it with a new one.

NOTICE

Replacing a fuse with one that has a higher rating greatly increases the chances of damaging the electrical system.

MAINTENANCE

Learn about basic maintenance that you can perform on the vehicle yourself, as well as information about how to best maintain the vehicle.

Safety Precautions

Some of the most important safety precautions are listed below; however, we cannot warn you of every conceivable hazard that can arise in performing maintenance. Only you can decide whether or not you should perform a given task.

■ Maintenance Safety

- To reduce the possibility of fire or explosion, keep cigarettes, sparks, and flames away from the battery and all fuel-related parts.
- Never leave rags, towels, or other flammable objects under the hood. Heat from the engine and exhaust can ignite them, causing a fire.
- To clean parts, use a commercially available degreaser or parts cleaner, not gasoline.
- Wear eye protection and protective clothing when working with the battery or compressed air.
- Engine exhaust contains carbon monoxide, which is poisonous and can kill you. Only operate the engine if there is sufficient ventilation.

■ Vehicle Safety

- The vehicle must be stationary and parked on level ground with the parking brake set and the engine off.
- Be aware that hot parts can burn you. Make sure to let the engine and exhaust system cool thoroughly before touching vehicle parts.
- Be aware that moving parts can injure you. Do not start the engine unless instructed, and keep your hands and limbs away from moving parts.

- Do not open the hood while the Auto Idle Stop function is activated.

⚠ WARNING

Improperly maintaining this vehicle or failing to correct a problem before driving can cause a crash in which you can be seriously hurt or killed.

Always follow the inspection and maintenance recommendations according to the schedules in this guide.

⚠ WARNING

Failure to properly follow maintenance instructions and precautions can cause you to be seriously hurt or killed.

Always follow the procedures and precautions in this guide.

Maintenance Minder™

When maintenance is due, the system message indicator comes on and a message appears on the display every time you turn the vehicle on. The messages notify you when to change the engine oil or when to bring your vehicle to a dealer for indicated maintenance services.

Press the Homebutton on the steering wheel to change displays.



- Independent of the Maintenance Minder information, replace the brake fluid every 3 years.

U.S. Models

- Independent of the Maintenance Minder information, adjust the valves during services A, B, 1, 2, or 3 if they are noisy.

Canadian Models

- Independent of the Maintenance Minder information, adjust the valves during services A, 0, 9, 1, 2, or 3 if they are noisy.

U.S. Models

Maintenance, replacement, or repair of emissions control devices and systems may be done by any automotive repair establishment or individuals using parts that are certified to EPA standards.

According to state and federal regulations, failure to perform maintenance on the maintenance main items marked with # will not void your emissions warranties. However, all maintenance services should be performed in accordance with the intervals indicated by the Driver Information Interface.

■ **Maintenance Minder Service Codes**

These codes indicate what services are due on your vehicle.

U.S. Models

CODE	Maintenance Main Items
A	<ul style="list-style-type: none"> • Replace engine oil*¹
B	<ul style="list-style-type: none"> • Replace engine oil*¹ and oil filter • Inspect front and rear brakes • Inspect tie rod ends, steering gearbox, and boots • Inspect suspension components • Inspect driveshaft boots • Inspect brake hoses and lines (Including ABS/VSA®) • Inspect all fluid levels and condition of fluids • Inspect exhaust system[#] • Inspect fuel lines and connections[#]

*1: If the message **Maintenance Due Now** does not appear more than 12 months after the display is reset, change the engine oil every year.

#: See information on maintenance and emissions warranty in the Owner's manual.

CODE	Maintenance Sub Items
1	<ul style="list-style-type: none"> • Rotate tires
2	<ul style="list-style-type: none"> • Replace air cleaner element^{*2} • Replace dust and pollen filter^{*3} • Inspect drive belt
3	<ul style="list-style-type: none"> • Replace transmission fluid
4	<ul style="list-style-type: none"> • Replace spark plugs • Replace timing belt and inspect water pump^{*4} • Inspect valve clearance
5	<ul style="list-style-type: none"> • Replace engine coolant
7	<ul style="list-style-type: none"> • Replace brake fluid^{*5}

*2: If you drive in dusty conditions, replace the air cleaner element every 15,000 miles (24,000 km).

*3: If you drive primarily in urban areas that have high concentrations of soot in the air from industry and from diesel-powered vehicles, replace the dust and pollen filter every 15,000 miles (24,000 km).

*4: If you drive regularly in very high temperatures (over 110°F, 43°C), in very low temperatures (under -20°F, -29°C), replace every 60,000 miles (100,000 km).

*5: If a Maintenance Minder message does not appear more than 36 months after the display for item 7 is reset, change the brake fluid every 3 years.

Canadian Models

CODE	Maintenance Main Items
A	<ul style="list-style-type: none"> • Replace engine oil^{*1}
0	<ul style="list-style-type: none"> • Replace engine oil^{*1} and oil filter

*1: If the message **Maintenance Due Now** does not appear more than 12 months after the display is reset, change the engine oil every year.

CODE	Maintenance Sub Items
1	<ul style="list-style-type: none"> • Rotate tires
2	<ul style="list-style-type: none"> • Replace air cleaner element^{*2} • Replace dust and pollen filter^{*3} • Inspect drive belt
3	<ul style="list-style-type: none"> • Replace transmission fluid
4	<ul style="list-style-type: none"> • Replace spark plugs • Replace timing belt and inspect water pump^{*4} • Inspect valve clearance
5	<ul style="list-style-type: none"> • Replace engine coolant
7	<ul style="list-style-type: none"> • Replace brake fluid^{*5}
9	<ul style="list-style-type: none"> • Service front and rear brakes • Inspect tie rod ends, steering gearbox, and boots • Inspect suspension components • Inspect driveshaft boots • Inspect brake hoses and lines (including ABS/VSA®) • Inspect all fluid levels and condition of fluids • Inspect exhaust system[#] • Inspect fuel lines and connections[#]

*2: If you drive in dusty conditions, replace the air cleaner element every 24,000 km (15,000 miles).

*3: If you drive primarily in urban areas that have high concentrations of soot in the air from industry and from diesel-powered vehicles, replace the dust and pollen filter every 24,000 km (15,000 miles).

*4: If you drive regularly in very high temperatures (over 43°C, 110°F), in very low temperatures (under -29°C, -20°F), replace every 100,000 km (60,000 miles).

*5: If a Maintenance Minder message does not appear more than 36 months after the display for item 7 is reset, change the brake fluid every 3 years.

: See information on maintenance and emissions warranty in the Owner's manual.

Under the Hood

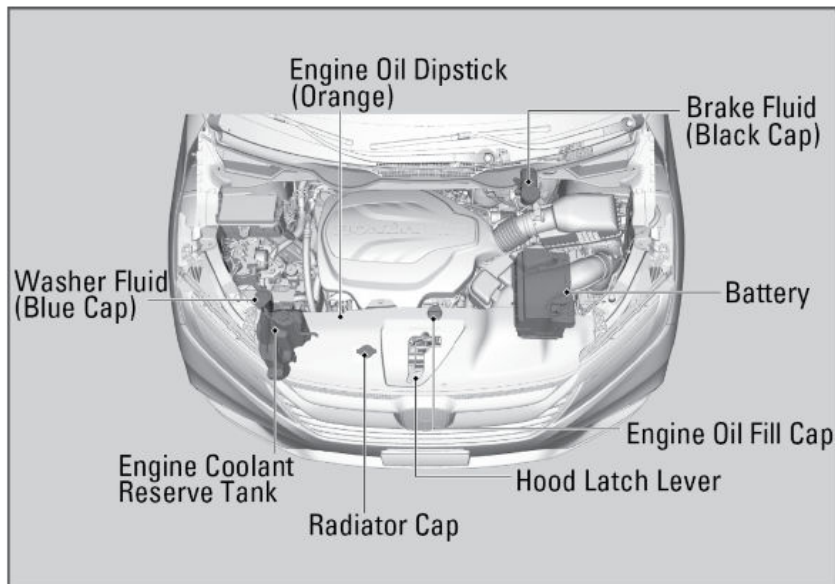

■ Opening the Hood

1. Park the vehicle on a level surface and set the parking brake.
2. Pull the hood release handle under the lower left corner of the dashboard. The hood will pop up slightly.

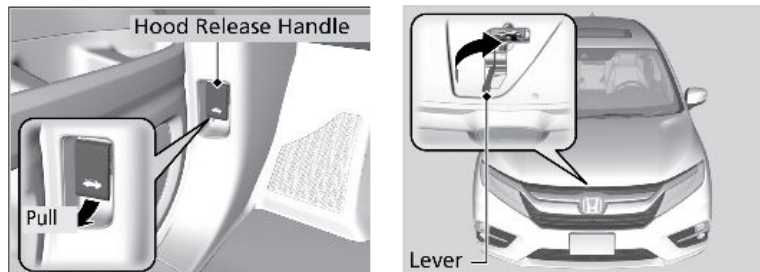

3. Push the hood latch lever (located under the front edge of the hood to the center) to the side and raise the hood. Once you have raised the hood slightly, you can release the lever.

4. Remove the support rod from the clamp using the grip. Mount the support rod in the hood.

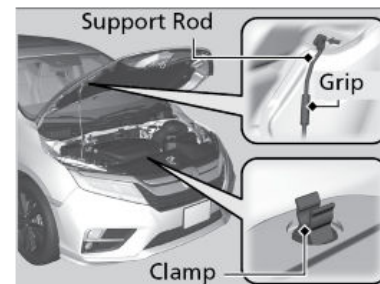

When closing, remove the support rod, and stow it in the clamp, then gently lower the hood.

When closing, lower the hood to approximately 12 inches (30 cm) and remove your hands and let the hood close.

NOTICE

Do not open the hood when the wiper arms are raised. The hood will strike the wipers, and may damage either the hood or the wipers.

Do not press the engine cover forcibly. This may damage the engine cover and component parts.

Do not open the hood while the Auto Idle Stop function is activated.

⚠ WARNING

The hood support rod can become very hot due to heat from the engine. To ensure against possible burns, do not handle the metal section of the rod: Use the foam grip instead

Engine Oil

Park the vehicle on level ground. Wait approximately three minutes after turning the engine off before you check the oil.

■ Checking the Oil

1. Remove the dipstick (orange).
2. Wipe the dipstick with a clean cloth or paper towel.
3. Insert the dipstick all the way back into its hole.

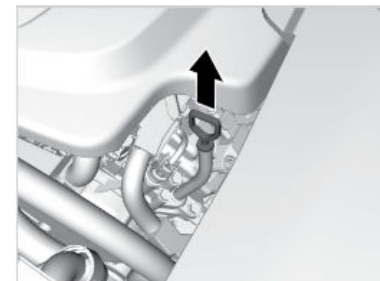

- Remove the dipstick again, and check the level. It should be between the upper and lower marks.

Add oil if necessary.

If the oil level is near or below the lower mark, slowly add oil, being careful not to overfill.

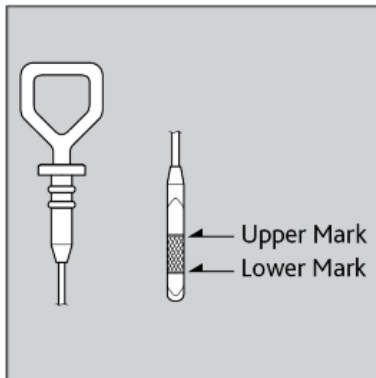

■ **Recommended Engine Oil**

- **Honda Genuine Motor Oil**
- **Premium-grade 0W-20 detergent oil with an API Certification Seal on the container**

This seal indicates the oil is energy conserving and that it meets the American Petroleum Institute's latest requirements. Use **Honda Genuine Motor Oil** or another commercial engine oil of suitable viscosity for the ambient temperature.

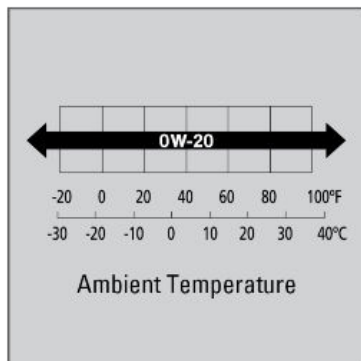

You may also use synthetic motor oil if it is labeled with the API Certification Seal and is of the specified viscosity grade.

■ **Adding Oil**

- Unscrew and remove the engine oil fill cap.
- Add oil slowly.
- Reinstall the engine oil fill cap and tighten it securely.

- Wait for three minutes and recheck the engine oil dipstick.

NOTICE

Do not fill the engine oil above the upper mark. Overfilling the engine oil may result in leaks and engine damage.

If any oil spills, wipe it away immediately. Spilled oil may damage the engine compartment components.

■ **Resetting the Engine Oil Life**

If you change or replace the vehicle's engine oil yourself, you must reset the engine oil life.

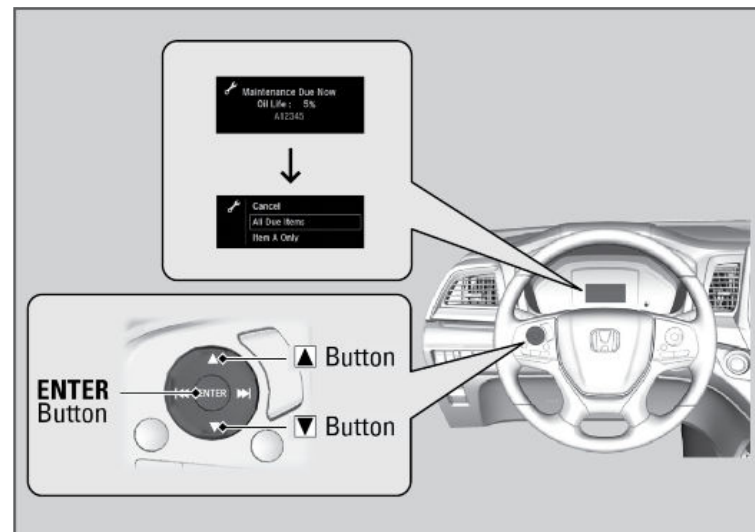

- Set the ENGINE START/STOP to ON.
- Display the engine oil life (see Maintenance Minder).
- Press and hold the ENTER button for about 10 seconds to enter the reset mode.
- Press the up or down arrow button to select a maintenance item to reset, or to select All Due Items. You can also select Cancel to end the process.
- Press the ENTER button to reset the selected item.
- Repeat from step 5 for other items you wish to reset.

Models with Display Audio: You can also reset the Maintenance Minder™ display using the audio/information screen.

NOTICE

Failure to reset the after a maintenance service results in the system showing incorrect maintenance intervals, which can lead to serious mechanical problems.

Engine Coolant

Park the vehicle on level ground. Check the reserve tank and the coolant level in the radiator. **Use Honda Long Life Antifreeze/Coolant Type 2.**

■ **Checking the Reserve Tank**

1. **Make sure the engine and radiator are cool.**

2. Check the amount of coolant in the reserve tank.

If the coolant level is below the MIN mark, add the specified coolant until it reaches the MAX mark.

3. Inspect the cooling system for leaks.

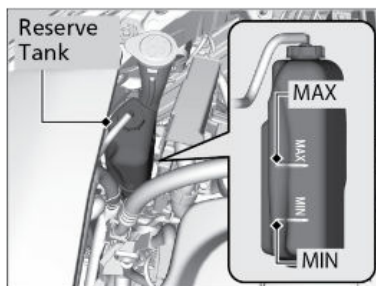

⚠ WARNING

Removing the radiator cap while the engine is hot can cause the coolant to spray out, seriously scalding you.

Always let the engine and radiator cool down before removing the radiator cap.

NOTICE

Honda Genuine engine coolant is a 50/50 mixture of antifreeze and water that can withstand freezing at temperatures as low as -31°F (-35°C). If your vehicle is consistently subjected to temperatures below this, the concentration of antifreeze in the coolant should be increased. Consult a dealer for details.

If Honda antifreeze/coolant is not available, you may use another major brand of non-silicate coolant as a temporary replacement. Check that it is a high quality coolant recommended for aluminum engines. Continued use of any non-Honda coolant can result in corrosion, causing the cooling system to malfunction or fail. Have the cooling system flushed and refilled with Honda antifreeze/coolant as soon as possible.

Do not add rust inhibitors or other additives to your vehicle's cooling system. They may not be compatible with the coolant or with the engine components.

■ **Adding Coolant**

1. **Make sure the engine and radiator are cool.**
2. Remove the engine compartment cover.
3. Turn the radiator cap 1/8 turn counterclockwise and relieve any pressure in the cooling system.
4. Push down and turn the radiator cap counter-clockwise to remove it.
5. Pour coolant into the reserve tank until it reaches the MAX mark.
6. Put the radiator cap back on and tighten it fully.

NOTICE

Pour the fluid slowly and carefully so you do not spill any. Clean up any spills immediately; they can damage components in the engine compartment.

Checking the Battery

The battery condition is monitored by the sensor on the negative terminal. If there is a problem with the sensor, a warning message appears on the Driver Information Interface. Have your vehicle checked by a dealer.

⚠ WARNING

The battery gives off explosive hydrogen gas during normal operation.

A spark or flame can cause the battery to explode with enough force to kill or seriously hurt you.

When conducting any battery maintenance, wear protective clothing and a face shield, or have a skilled technician do it.

WARNING: Battery posts, terminals, and related accessories contain lead and lead compounds. **Wash your hands after handling.**

Charging the AGM Battery

AGM labeled batteries, like those installed in your vehicle, require a compatible charger to be properly charged. Damage to the battery can result if the battery is charged improperly or with the wrong equipment. For more information on how to charge your vehicle's AGM battery, consult a dealer.

The battery installed in this vehicle is specifically designed for a model with Auto Idle Stop. Using a battery other than this specified type may shorten the battery life, and prevent Auto Idle Stop from activating. If you need to replace

the battery, make sure to select the specified type. Ask a dealer for more details.

Replacing the Button Battery for the Remote Transmitter

If the indicator does not come on when the button is pressed, replace the battery.

Battery type: CR2032

1. Remove the built-in key.
2. Remove the upper half of the cover by carefully prying on the edge with a coin. Wrap a coin with a cloth to prevent scratching the smart entry remote. Remove carefully to avoid losing the buttons.
3. Make sure to replace the battery with the correct polarity.

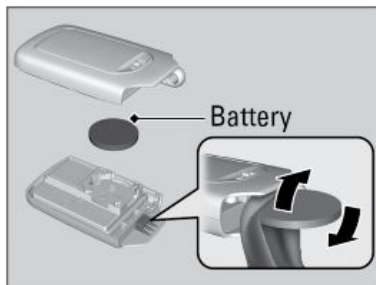

⚠ WARNING

CHEMICAL BURN HAZARD

The battery that powers the remote transmitter can cause severe internal burns and can even lead to death if swallowed.

Keep new and used batteries away from children.

If you suspect that a child has swallowed the battery, seek medical attention immediately.

NOTICE

An improperly disposed of battery can damage the environment. Always confirm local regulations for battery disposal.

Replacement batteries are commercially available or at a dealer.

Window Washer Fluid

Check the amount of window washer fluid by looking at the reservoir. Fill the reservoir if it is low. Pour the washer fluid carefully. Do not overflow the reservoir.

Canadian Models Only

If the washer fluid is low, a message appears on the Driver Information Interface.

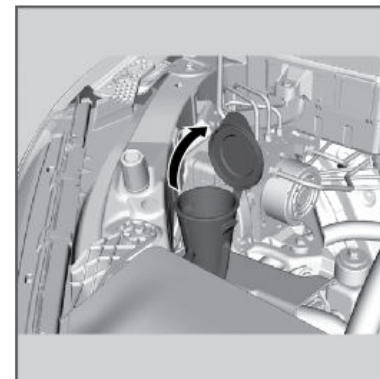

NOTICE

Do not use engine antifreeze or a vinegar/water solution in the windshield washer reservoir. Antifreeze can damage your vehicle's paint. A vinegar/water solution can damage the windshield washer pump.

Use only commercially available windshield washer fluid.

Avoid prolonged use of hard water to prevent lime scale build up.

Brake Fluid

The fluid level should be between the MIN and MAX marks on the side of the tank. We recommend using **Honda Heavy Duty Brake Fluid DOT 3**.

The fluid level should be between the **MIN** and **MAX** marks on the side of the reserve tank.

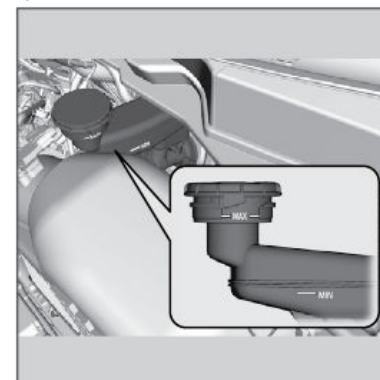

NOTICE

Brake fluid marked DOT 5 is not compatible with your vehicle's braking system and can cause extensive damage.

If the specified brake fluid is not available, you should use only DOT 3 or DOT 4 fluid from a sealed container as a temporary replacement.

Using any non-Honda brake fluid can cause corrosion and decrease the longevity of the system. Have the brake system flushed and refilled with Honda Heavy Duty Brake Fluid DOT 3 as soon as possible.

If the brake fluid level is at or below the **MIN** mark, have a dealer inspect the vehicle for leaks or worn brake pads as soon as possible.

Changing Wiper Blades

If the wiper blade rubber has deteriorated, it will leave streaks and the hard surfaces of the blade may scratch the window glass.

1. Set the power mode to VEHICLE OFF.
2. While holding the wiper switch in the MIST position, press the **POWER** button three times. Both wiper arms are now set to the maintenance position.

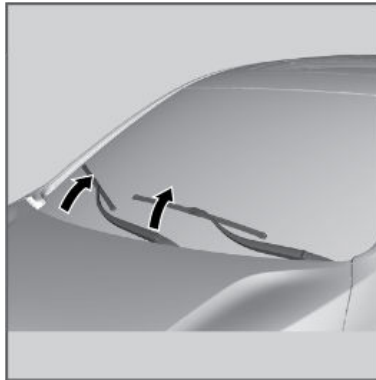

3. Lift both wiper arms.

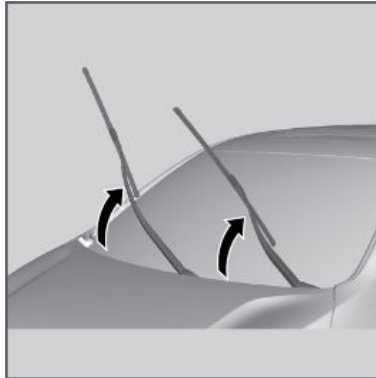

4. Press up on and hold the tab, then slide the holder off the wiper arm.

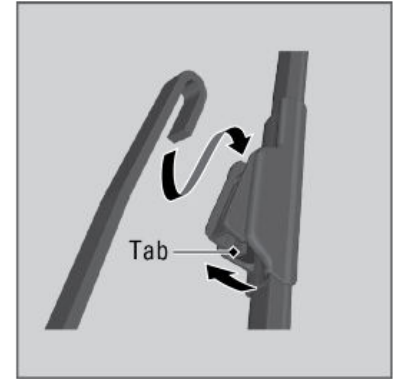

5. Pull the end of the wiper blade in the direction of the arrow in the image until it unfastens from the holder's end cap.
6. Pull the wiper blade to the opposite direction to slide it out from its holder.

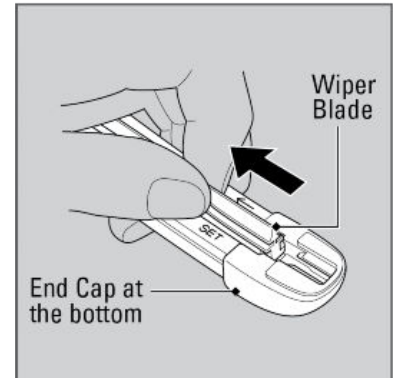

7. Insert the flat side of the new wiper blade onto the bottom part of the holder. Insert the blade all the way.
8. Install the end of the wiper blade into the cap.
9. Slide the wiper holder onto the wiper arm until it locks.
10. Lower both wiper arms.
11. Set the power mode to ON and hold the wiper switch in the **MIST** position until both wiper arms return to the standard position.

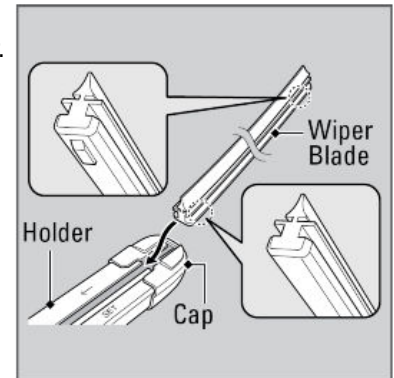

NOTICE

Avoid dropping the wiper arm onto the windshield, it may damage the wiper arm and/or the windshield.

■ **Changing the Rear Wiper Blade**

1. Raise the wiper arm off.
2. Pivot up the bottom end of the wiper blade up until it comes off from the wiper arm.
3. Slide the wiper blade out of the holder.

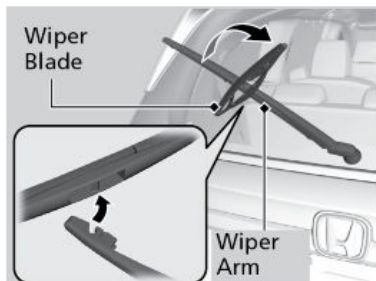

4. Remove the retainers from wiper blade and mount it to a new rubber blade.
5. Slide the new wiper blade onto the holder. Make sure it is engaged correctly, then install the wiper blade assembly onto the wiper arm.

NOTICE

Avoid dropping the wiper arm, as it may damage the rear window.

Tire Information

To safely operate your vehicle, your tires must be of the proper type and size, in good condition with adequate tread, and properly inflated.

■ **Inflation Guidelines**

- Properly inflated tires provide the best combination of handling, tread life, and comfort. Refer to the driver's doorjamb label or see SPECIFICATIONS for the specified pressure.
- Underinflated tires wear unevenly, adversely affect handling and fuel economy, and are more likely to fail from overheating.
- Overinflated tires make your vehicle ride harshly, are more prone to road hazards, and wear unevenly.
- Every day before you drive, look at each of the tires. If one looks lower than the others, check the pressure with a tire gauge.
- Measure the air pressure when tires are cold. This means the vehicle has been parked for at least 3 hours, or driven less than 1 mile (1.6 km). If necessary, add or release air until the specified pressure is reached. If checked when hot, tire pressure can be as much as 4-6 psi (30-40 kPa, 0.3-0.4 kgf/cm²) higher than checked when cold.

- At least once a month or before long trips, use a gauge to measure the pressure in all tires, including the spare. Even tires in good condition can lose 1-2 psi (10-20 kPa, 0.1-0.2 kgf/cm²) per month.

■ **Inspection Guidelines**

Every time you inflate the tires, check for the following:

- Any damage to tires, including bumps, bulges, cuts, splits, or cracks in the side or tread.
- Remove any foreign objects and inspect for air leaks. Replace tires if you see fabric or cord.
- Uneven or excessive tread wear. Have a dealer check the wheel alignment.
- Cracks or other damage around the valve stems.

Check the spare tire pressure once a month or before long trips.

⚠ WARNING

Using tires that are excessively worn or improperly inflated can cause a crash in which you can be seriously hurt or killed.

Follow all instructions in the owner's manual regarding tire inflation and maintenance.

■ **Wear Indicators**

The groove where the wear indicator is located is 1/16 inch (1.6 mm) shallower than elsewhere on the tire. If the tread has worn so low that the indicator is exposed, replace the tire.

Worn out tires have poor traction on wet roads.

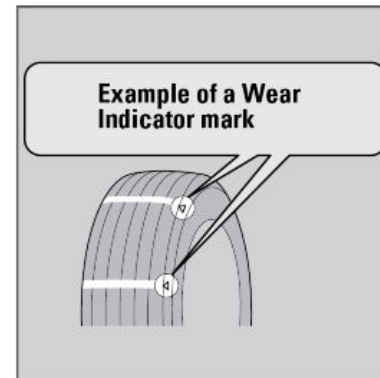

■ **Tire and Loading Information Label**

The label attached to the driver's doorjamb provides necessary tire and loading information.

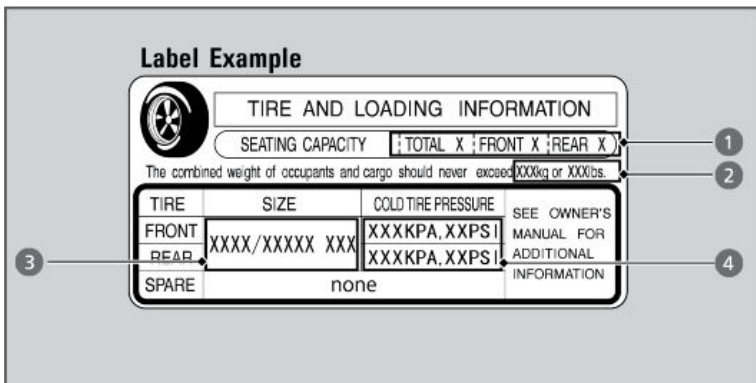

1. The number of people your vehicle can carry.
2. The total weight your vehicle can carry. Do not exceed this weight.
3. The original tire sizes for front, rear, and spare.
4. The proper cold tire pressure for front, rear, and spare.

Tire and Wheel Replacement

Replace your tires with radials of the same size, load range, speed rating, and maximum cold tire pressure rating (as shown on the tire sidewall). Using tires of a different size or construction can cause certain vehicle systems such as the ABS and Vehicle Stability Assist™ (VSA®) System to work incorrectly. It is best to replace all four tires at the same time. If that isn't possible, replace the front or rear tires in pairs.

If you replace a wheel, make sure that the wheel's specifications match those of the original wheels. Only use TPMS specified wheels approved for your vehicle.

⚠ WARNING

Installing improper tires on your vehicle can affect handling and stability. This can cause a crash in which you can be seriously hurt or killed. Always use the size and type of tires recommended in the Owner's Manual.

Tire Service Life

The life of your tires is dependent on many factors, including driving habits, road conditions, vehicle loading, inflation pressure, maintenance history, speed, and environmental conditions (even when the tires are not in use).

In addition to regular inspections and inflation pressure maintenance, it is recommended that you have annual inspections performed once the tires

reach five years old. All tires, including the spare, should be removed from service after 10 years from the date of manufacture, regardless of their condition or state of wear.

Winter Tires

If driving on snowy or frozen roads, mount all season tires marked "M+S", snow tires, or tire chains; reduce speed and maintain sufficient distance between vehicles when driving.

Be particularly careful when operating the steering wheel or brakes to prevent skidding. Use tire chains, snow tires, or all season tires when necessary or according to the law.

For winter tires, select the size and load ranges that are the same as the original tires, and mount them to all four wheels.

Tire Chains

Install tire chains on the front tires only. Because your vehicle has limited tire clearance, we strongly recommend using the following chains:

Models with 235/60R18: Peerless Autotrac 231905

Models with 235/55R19: Peerless Autotrac 232405

- Follow the chain manufacturer's instruction when installing. Mount them as tightly as you can.
- Check that the chains do not touch the brake lines or suspension.
- Drive slowly.

NOTICE

Traction devices that are the wrong size or improperly installed can damage your vehicle's brake lines, suspension, body, and wheels. Stop driving if they are hitting any part of the vehicle.

When tire chains are mounted, follow the chain manufacturer's instructions regarding vehicle operational limits.

If your vehicle is equipped with summer tires, be aware that these tires are not designed for winter driving conditions. For more information, contact a dealer.

⚠ WARNING

Using the wrong chains, or not properly installing chains, can damage the brake lines and cause a crash in which you can be seriously injured or killed.

Follow all instructions in this guide regarding the selection and use of tire chains.

Tire Labeling

The tires that came on your vehicle have a number of markings. Those you should be aware of are described below.

Here is an example of what each component means:

P235/60R18 102V

- P: tire type (passenger vehicle)
- 235: tire width in millimeters
- 60: aspect ratio (tire section height as a percentage of its width)
- R: tire construction code (radial)
- 18: rim diameter in inches
- 102: load index (code indicating maximum load tire can carry)
- V: speed symbol (code indicating maximum speed rating)

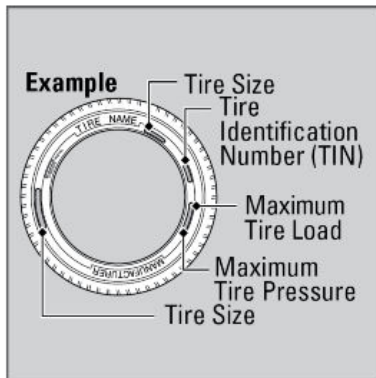

■ Tire Identification Number (TIN)

The tire identification number (TIN) is a group of numbers and letters that look like the following example. The TIN is located on the sidewall of the tire.

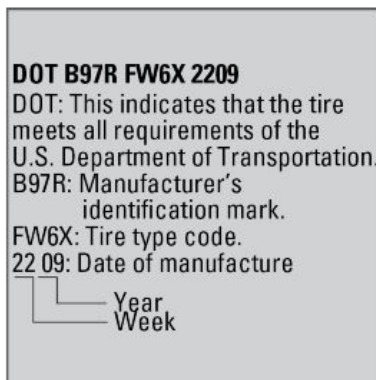

■ Glossary of Tire Terminology

Cold Tire Pressure – The tire air pressure when the vehicle has been parked for at least three hours or driven less than 1 mile (1.6 km).

Load Rating – The maximum load that a tire is rated to carry for a given inflation pressure.

Maximum Inflation Pressure – The maximum tire air pressure that the tire can hold.

Maximum Load Rating – The load rating for a tire at the maximum permissible inflation pressure for that tire.

Recommended Inflation Pressure – The cold tire inflation pressure recommended by the manufacturer.

Treadwear Indicators (TWI) – The projections within the principal grooves designed to give a visual indication of the degrees of wear of the tread.

DOT Tire Quality Grading

The tires on your vehicle meet all U.S. Federal Safety Requirements. All tires are also graded for treadwear, traction, and temperature performance according to Department of Transportation (DOT) standards. These gradings are explained below.

■ Uniform Tire Quality Grading

Quality grades can be found where applicable on the tire sidewall between tread shoulder and maximum section width.

For example:

Treadwear 200

Traction AA

Temperature A

All passenger car tires must conform to Federal Safety Requirements in addition to these grades.

■ Treadwear

The treadwear grade is a comparative rating based on the wear rate of the tire when tested under controlled conditions on a specified government test course. For example, a tire graded 150 would wear one and one-half (1 1/2) times as well on the government course as a tire graded 100. The relative performance of tires depends upon the actual conditions of their use, however, and may depart significantly from the norm due to variations in driving habits, service practices, and differences in road characteristics and climate.

■ Traction

The traction grades, from highest to lowest, are AA, A, B, and C. Those grades represent the tire's ability to stop on wet pavement as measured under controlled conditions on specified government test surfaces of asphalt and concrete. A tire marked C may have poor traction performance.

WARNING: The traction grade assigned to this tire is based on straight-ahead braking traction tests, and does not include acceleration, cornering, hydroplaning, or peak traction characteristics.

■ Temperature

The temperature grades are A (the highest), B, and C, representing the tire’s resistance to the generation of heat and its ability to dissipate heat when tested under controlled conditions on a specified indoor laboratory test wheel. Sustained high temperature can cause the material of the tire to degenerate and reduce tire life, and excessive temperature can lead to sudden tire failure. The grade C corresponds to a level of performance which all passenger car tire must meet under the Federal Motor Vehicle Safety Standard No. 109. Grades B and A represent higher levels of performance on the laboratory test wheel than the minimum required by law.

WARNING: The temperature grade for this tire is established for a tire that is properly inflated and not overloaded. Excessive speed, underinflation, or excessive loading, either separately or in combination, can cause heat buildup and possible tire failure.

Air Conditioning

To ensure proper and safe operation, the Society of Automotive Engineers (SAE J2845) recommends that the refrigerant system only be serviced by trained and certified technicians.

Never repair or replace the air conditioning evaporator (cooling coil) with one removed from a used or salvaged vehicle.

New replacement mobile air conditioning evaporators must be certified (and labeled) as meeting SAE Standard J2842.

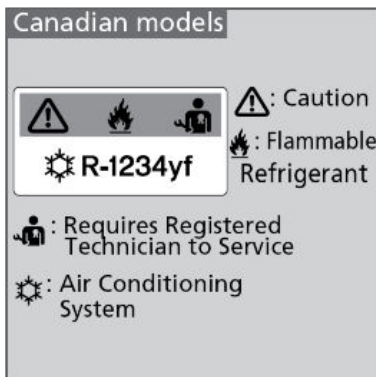

NOTICE

Vented refrigerant is harmful to the environment. To avoid refrigerant from venting, never replace the evaporator with one removed from a used or salvaged vehicle.

Refrigerant in your vehicle's air conditioning system is flammable and can be ignited during servicing if proper procedures are not followed.

Testing of Readiness Codes

Your vehicle has readiness codes as part of the onboard self-diagnostic system. Some states use these codes for testing to verify whether your vehicle’s emissions components are working properly. The codes may not be read if you go through the testing just after the 12-volt battery has gone dead or been disconnected.

To check if they are set, to ON without starting the engine. The malfunction indicator lamp will come on for several seconds. If it goes off, the readiness codes are set. If it blinks five times, the readiness codes are not set.

If you are required to have your vehicle tested before the readiness codes are set, prepare the vehicle for retesting by doing the following:

1. Fill the gas tank to approximately 3/4 full.
2. Park the vehicle and leave the engine off for 6 hours or more.
3. Make sure the ambient temperature is between 40°F and 95°F (4°C and 35°C).
4. Start the engine without touching the accelerator pedal, and let it idle for 20 seconds.
5. Keep the vehicle in PARK (P). Increase the engine speed to 2,000 rpm, and hold it there for about 3 minutes.
6. Let the engine idle with your foot off the accelerator for 20 seconds.
7. Select a nearby, lightly traveled major highway where you can maintain a speed of 50 to 60 mph (80 to 97 km/h) for at least 20 minutes. Drive on the highway in DRIVE (D). Do not use cruise control. When traffic allows, drive for 90 seconds without moving the accelerator pedal. (Vehicle speed may vary slightly; this is okay.) If you cannot do this for a continuous 90 seconds because of traffic conditions, drive for at least 30 seconds, then repeat it two more times (for a total of 90 seconds).
8. Drive in city or suburban traffic for at least 10 minutes. When traffic conditions allow, let the vehicle coast for several seconds without using the accelerator pedal or the brake pedal.
9. Park the vehicle and leave the engine off for 30 minutes.

The readiness codes are erased when the battery is disconnected, and set again only after several days of driving under a variety of conditions.

If a testing facility determines that the readiness codes are not set, you may be requested to return at a later date to complete the test.

If the testing facility determines the readiness codes are still not set, see a dealer.

Accessories and Modifications

■ Accessories

When installing accessories, check the following:

- Do not install accessories on the windshield. They can obstruct your view and delay your reaction to driving conditions.
- Do not install any accessories over areas marked SRS AIRBAG, on the sides or backs of the front seats, on front or side pillars, or near the side windows. Accessories installed in these areas may interfere with proper operation of the vehicle's airbags or may be propelled into you or another occupant if the airbags deploy.
- Be sure electronic accessories do not overload electrical circuits or interfere with proper operation of your vehicle.
- Before installing any electronic accessory, have the installer contact a dealer for assistance. If possible, have a dealer inspect the final installation.

■ Modifications

Do not modify your vehicle in a manner that may affect its handling, stability, or reliability, or install non-genuine Honda parts or accessories that may have similar effect.

Even minor modifications to vehicle systems can affect overall vehicle performance. Always make sure all equipment is properly installed and maintained, and do not make any modification to your vehicle or its systems that might cause your vehicle to no longer meet federal, state, province, territory, and local regulations.

The on-board diagnostic port (OBD-II/SAE J1962 connector) installed on this vehicle is intended to be used with automobile system diagnostic devices or with other devices that Honda has approved. Use of any other type of device may adversely affect the vehicle's electronic systems or allow them to be compromised, possibly resulting in a system malfunction, drained battery, or other unexpected problems.

Do not modify or attempt to repair any of the electrical components.

⚠ WARNING

Improper accessories or modifications can affect your vehicle's handling, stability, and performance, and cause a crash in which you can be seriously hurt or killed.

Follow all instructions in this owner's guide regarding accessories and modifications.

SPECIFICATIONS

Vehicle Specifications

Model	Honda Odyssey	
No. of Passengers:		
Front	2	
Rear	2nd Row	3 (2)*1
	3rd Row	3
Total	8 (7)*1	
Gross Vehicle Weight Rating	U.S.: 6,019 lbs (2,730 kg) Canada: 2,730 kg	

*1: LX grade model

Air Conditioning

Refrigerant Type	HFO-1234yf (R-1234yf)
Charge Quantity	20.3 - 22.0 oz (575 - 625 g)
Lubricant Type	ND-OIL14 (POE)
Quantity	7.3 - 8.2 cu-in (120 - 135 cm³)

Engine & Fuel Specifications

Spark Plugs	NGK DILZKR7B11G
Fuel Type	Unleaded gasoline, Pump octane number of 87 or higher
Fuel Tank Capacity	19.5 US gal (73.8 L)

Engine Oil

Recommended	-Genuine Honda Motor Oil 0W-20 -API Premium-grade 0W-20 detergent oil
--------------------	--

Engine Coolant

Specified	Honda Long-Life Antifreeze/ Coolant Type2
Ratio	50/50 with distilled water

Brake Fluid

Specified	Honda Heavy Duty Brake Fluid DOT 3
------------------	------------------------------------

Tire

Regular	Size	235/60R18 103H ^{*1} 235/55R19 101H ^{*2}
	Pressure psi (kPa [kgf/cm ²])	35 (240 [2.4]) ^{*1} 36 (250 [2.5]) ^{*2}
Compact Spare	Size	T135/80D17 103M
	Pressure psi (kPa [kgf/cm ²])	60 (420 [4.2])
Wheel Size	Regular	18 x 7 1/2J ^{*1} 19 x 7 1/2J ^{*2}
	Compact Spare	17 x 4T

*1: Except U.S. ELITE and Canadian TOURING grade models

*2: U.S. ELITE and Canadian TOURING grade models

Light Bulbs

Headlights (Low Beam)	55W (H11) ^{*1, *2} LED ^{*3}
Headlights (High Beam)	60W (HB3) ^{*1, *2} LED ^{*3}
Fog Lights	35W (H8) ^{*2} LED ^{*3}
Front Turn Signal/Parking Lights	28/8W (Amber) ^{*1}
Front Turn Signal Lights	28/8W (Amber) ^{*2, *3}
Front Side Marker Lights	3CP
Parking/Daytime Running Lights	LED ^{*2, *3}
Daytime Running Lights	60W (HB3) ^{*1}
Side Turn Signal Lights (on Door Mirrors)	LED ^{*2, *3}
Brake Lights	21W
Rear Side Marker/Taillights	LED
Rear Turn Signal Lights	21W
Back-Up Lights	21W
Taillights	LED
High-Mount Brake Light	LED
Rear License Plate Light	LED
Map Lights	5W
Cargo Area Light	8W
Vanity Mirror Lights	5W
Glove Box Light	1.4W

*1: LX and LX-HS grade models

*2: EX, EXL, EXL-NR, EX-R, EXLNAV, and EXLRES grade models

*3: ELITE and TOURING grade models

CUSTOMER INFORMATION

Learn about information specific to you as a Honda customer and how to get help.

Contact Us

Honda dealer personnel are trained professionals. They should be able to answer all your questions. If you encounter a problem that your dealership does not solve to your satisfaction, please discuss it with the dealership's Service Manager or General Manager. If you are dissatisfied with the decision made by the dealership's management, contact Honda Automobile Customer Service.

U.S. owners

American Honda Motor Co., Inc. Torrance, CA 90501-2746
Honda Automobile Customer Service Tel: (800) 999-1009
Mail Stop 100-5E-8A Fax: (310) 783-3023
1919 Torrance Blvd. Twitter:@HondaCustSvc

Canadian owners

Honda Canada, Inc. Markham, ON L6C 0H9
Customer Relations Tel: (888) 946-6329
180 Honda Blvd. E-mail: honda_cr@ch.honda.com

In Puerto Rico and the U.S. Virgin Islands

Bella International
P.O. Box 190816
San Juan, PR 00919-0816
Tel: (787) 620-7546

When you call or write, please provide the following information:

- Vehicle Identification Number
- Date of purchase
- Odometer reading of your vehicle
- Your name, address, and telephone number
- A detailed description of the problem
- Name of the dealer who sold the vehicle to you

Warranty Coverages

Below is a brief summary of the warranties covering your new vehicle.

New Vehicle Limited Warranty: Covers your new vehicle, except for the emissions control system and accessories, against defects in materials and workmanship.

Emissions Control Systems Defects Warranty and Emissions Performance Warranty: Covers your vehicle's emissions control systems. Time, mileage, and coverage are conditional.

Seat Belt Limited Warranty: Covers seat belts that fail to function properly.

Rust Perforation Limited Warranty: Covers all exterior body panels that rust through from the inside.

Accessory Limited Warranty: Covers Honda accessories.

Replacement Parts Limited Warranty: Covers all Honda replacement parts against defects in materials and workmanship.

Replacement Battery Limited Warranty: Provides prorated coverage for a replacement battery purchased from a Honda dealer.

Replacement Muffler Lifetime Limited Warranty: Covers a replacement muffler for the duration of the ownership.

Restrictions and exclusions apply to all these warranties. See the Warranty Information booklet or visit owners.honda.com (U.S.) or honda.ca (Canada) for complete descriptions of each warranty, including time, mileage, and other conditional limitations.

Your vehicle's original tires are covered by their manufacturer. Tire warranty information can be found at owners.honda.com (U.S.) or honda.ca (Canada).

EPA Contact Information

An owner may obtain further information concerning emission warranties or report violations of the term of the emission warranties by contacting:

Director,
 Light-Duty Vehicle Center,
 U.S. Environmental Protection Agency,
 Attn: Warranty Claim
 2000 Traverwood Drive,
 Ann Arbor, MI 48105
 Email: complianceinfo@epa.gov

INDEX

Airbags.....	9, 11, 12, 14, 16, 17	LATCH-Compatible Child Seat.....	21
Advanced Airbags.....	11	Selecting a Child Seat.....	20
Airbag Care.....	17	Climate Control System.....	73, 76
Airbag System Components.....	16	Heated Seats.....	76
Airbag System Indicators.....	14	Heated Steering Wheel.....	76
Front Airbags.....	9	Heated Windshield.....	76
Side Airbags.....	11	Clock.....	78
Side Curtain Airbags.....	12	Contact Us.....	207
Audio and Connectivity.....	81–107	Cruise Control.....	141, 143
Adjusting the Sound.....	83	Adaptive Cruise Control (ACC).....	143
Android Auto.....	93	Customized Features.....	77
Bluetooth Audio.....	100	Doors.....	42
FM/AM Radio.....	98	Front Door Inner Handle.....	42
Rear Entertainment System (RES).....	103	Lock Tab.....	42
SiriusXM Radio.....	99	Master Door Lock Switch.....	42
USB Port.....	81	Driver Assist Systems.....	140, 141
Blind Spot Information.....	153	Engine.....	130, 167
Bluetooth HandsfreeLink (HFL).....	109, 112, 114, 115	Emergency Engine Stop.....	167
Dialing a Number.....	112	ENGINE START/STOP Button.....	130
Making a Call.....	112	Floor Mats.....	70
Pairing a Phone.....	109	Fuel.....	161
SMS Text Messaging and E- Mail.....	115	Fuel Information.....	161
Using Speed Dial.....	114	Refueling.....	161
Using the Phonebook.....	112	Fuses.....	178, 180
Brake Hold.....	135	Changing.....	180
Braking.....	134, 137, 151	Location.....	178
Anti-Lock Brake System (ABS).....	137	Gear Selection.....	131
Brake Assist System.....	137	Shifting.....	131
CMBS.....	151	Headlights.....	51, 56
Foot Brake.....	134	Headlight-Wiper Integration.....	56
Parking Brake.....	134	HFL.....	108–115
Brightness Control.....	50	HomeLink Universal Transceiver.....	72
Carbon Monoxide Gas.....	4	Honda Sensing.....	140
Child Safety.....	17, 20, 21, 24, 25, 43	HomeLink.....	101, 102
Child Seat with lap/shoulder belt.....	24	HondaLink Assist.....	102
Child seat with Tether.....	25	Immobilizer.....	35
Childproof Door Locks.....	43	Instrument Panel Indicators.....	30
		Jump Starting.....	164
		Lane Keeping Assist System (LKAS).....	147

LaneWatch.....	155	Driver Seat.....	58
Lights.....	50	Driving Position Memory System.....	59
Interior Lights.....	50	Head Restraints.....	60
Maintenance.....	181–204	Rear Seats.....	63
Battery.....	191	Smart Entry System.....	39, 164
Brake Fluid.....	193	Specifications.....	205, 206
Engine Oil.....	187	Light Bulbs.....	205, 206
Maintenance Minder.....	182	Steering Wheel Adjusting.....	70
Opening the Hood.....	186	Tires.....	168–170, 174, 196–201
Under the Hood.....	186	Flat Tire.....	170
Window Washer Fluid.....	193	Replacing Flat Tire.....	174
Wiper Blades.....	194	Tire and Loading Information	
Mirrors.....	71, 72	Label.....	197
Door Mirrors.....	71	Tire and Wheel Replacement.....	198
Rearview Mirror.....	71	Tire Chains.....	199
Reverse Tilt Down Mirrors.....	72	Tire Fill Assist.....	169
Moonroof.....	49	Tire Identification Number (TIN)...	200
Multi-View Rear Camera.....	160	Tire Information.....	196
Navigation.....	117–120	Tire Labeling.....	200
Home Address.....	118	Tire Pressure Monitoring System	
Map Legend.....	120	(TPMS).....	168
Routing.....	120	Tire Quality Grading.....	201
Steering Wheel Controls.....	117	Tire Service Life.....	198
Street Address.....	119	Tire Terminology.....	200
Overheating.....	166	Wear Indicators.....	197
Parking Brake.....	134	Winter Tires.....	199
Parking Sensor System.....	157	Towing.....	124, 125, 168
Power Outlets 12-Volt.....	82	Emergency Towing.....	168
Power Sliding Doors.....	44	Load Limits.....	125
Readiness Codes.....	203	Trailer Weight.....	125
Remote Engine Start.....	126	Towing a Trailer.....	124
Road Departure Mitigation (RDM)...	149	Turn Signals.....	52
Safety.....	3–29	Vehicle Stability Assist System	
Reporting Safety Defects.....	29	(VSA).....	139
Safety Label Locations.....	28	Voice Command Index.....	116
Seat Belts.....	4–7	Walk Away Auto Lock.....	41
Fastening a Seat Belt.....	6	Warranty.....	208
Inspection.....	5	Warranty Coverages.....	208
Lap/Shoulder Belts.....	4	Window.....	48
Proper Use.....	5	Power Windows.....	48
Shoulder Anchor.....	7	Wipers.....	56, 57
Seating.....	58–60, 63	Automatic Intermittent Wipers.....	57
		Intermittent Wipers.....	57

DISCLOSURES

California Proposition 65 Warning

⚠️WARNING: Operating, servicing and maintaining a passenger vehicle or off-highway motor vehicle can expose you to chemicals including engine exhaust, carbon monoxide, phthalates, and lead, which are known to the State of California to cause cancer and birth defects or other reproductive harm. To minimize exposure, avoid breathing exhaust, do not idle the engine except as necessary, service your vehicle in a well-ventilated area and wear gloves or wash your hands frequently when servicing your vehicle. For more information go to www.p65Warnings.ca.gov/passenger-vehicle.

California Perchlorate Contamination Prevention Act

The airbags, seat belt tensioners, and CR-type batteries in this vehicle may contain perchlorate materials-special handling may apply. See www.dtsc.ca.gov/hazardouswaste/perchlorate/ for more information.

End User License Agreement

Your vehicle comes equipped with software, which is governed by the End User License Agreement in this vehicle’s Owner’s Manual, and which contains a binding arbitration clause. Please refer to the End User License Agreement for the terms and conditions governing your use of the installed software, as well as the applications, services, functions, and content provided through the software. Your use of the installed software will serve as your consent to the terms and conditions of the End User License Agreement.

You may opt out of the arbitration provisions within 30 days of your initial use of the Software by sending a signed, written notice to HONDA at American Honda Motor Co., Inc. Honda Automobile Customer Services Mail Stop 100-5E-8A, 1919 Torrance Blvd. Torrance, CA 90501-2746.

Free Manuals Download Website

<http://myh66.com>

<http://usermanuals.us>

<http://www.somanuals.com>

<http://www.4manuals.cc>

<http://www.manual-lib.com>

<http://www.404manual.com>

<http://www.luxmanual.com>

<http://aubethermostatmanual.com>

Golf course search by state

<http://golfingnear.com>

Email search by domain

<http://emailbydomain.com>

Auto manuals search

<http://auto.somanuals.com>

TV manuals search

<http://tv.somanuals.com>