

Enterprise Hybrid Device (EHD)

EDA50-111
EDA50-011 Quick Start Guide
EDA50-211

This is one general user manual for EDA50 serial.

EDA50-111
EDA50-011 Only sale for EU



EDA50-ENG-QS(Rev.B)

Open the Package

Please check if the following items included in the package:

- É ScanPal EDA50 Device ;
- É Main battery (3.8V, lithium ion battery);
- É 10-watt power adapter;
- É Replaceable adapter Plugs;
- É USB charging cable;
- É Quick Start Guide and other compliance documents.

Remarks:

If you ordered accessories for the terminal, please make sure they are also included in the package; be sure to keep the original packages for ScanPal EDA50 to be returned for repairing when necessary.

Note:

End users should not arbitrarily replace the operating system with other operating systems. To update operating system installed on your device, you need to get license from the OS vendors.

EDA50-111/EDA50-011/EDA50-211 belongs to ScanPal Series

Front Panel

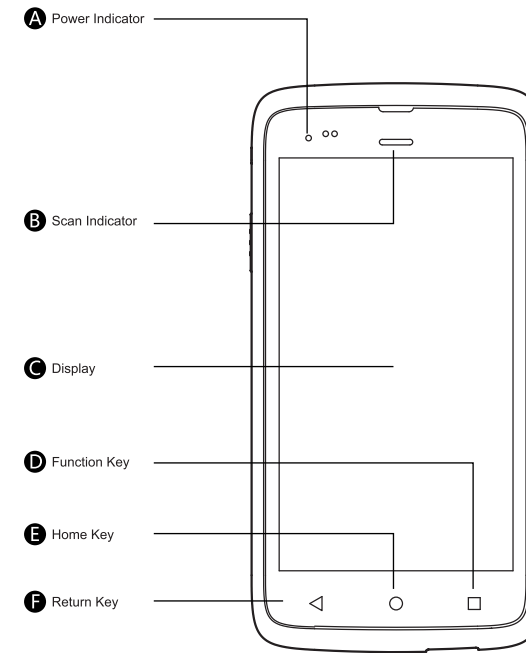

Rear Panel

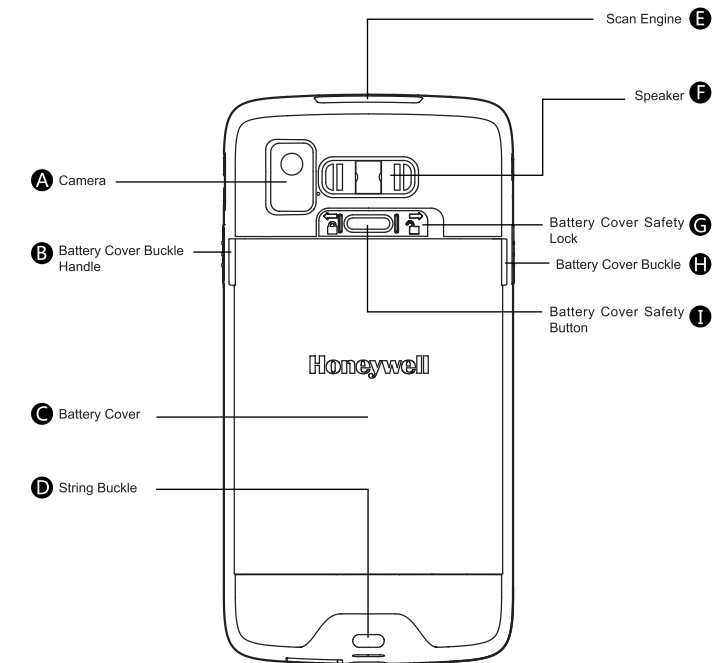

Left Side View

Right Side View

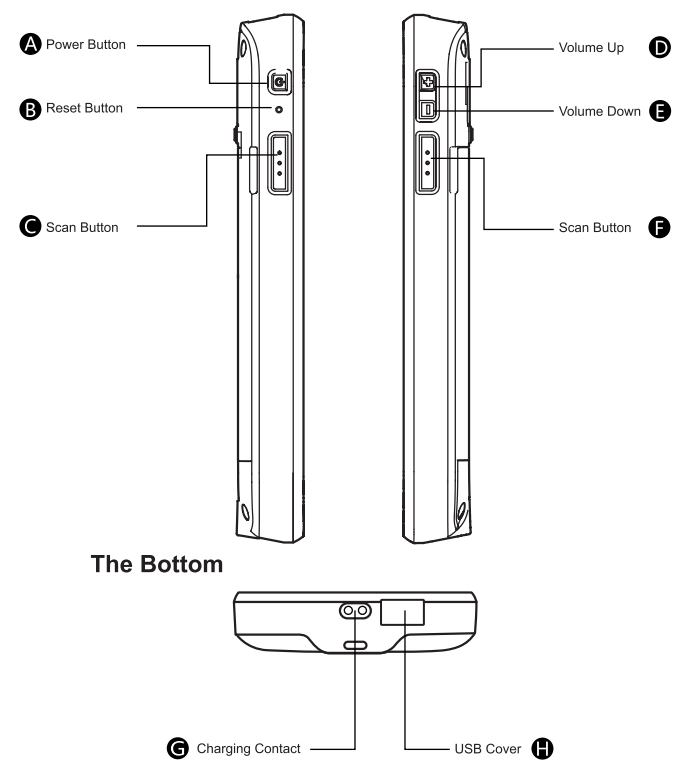

Install the Main Battery

Replace the battery with wrong models may cause explosion. Please make sure to use the battery in accordance with local regulations. Please recycle the battery when possible. Do not dispose it as household waste

Please ensure all kits are dry when connect the mobile device or battery to external devices.

Damages caused by connecting wet kits are not covered by the warranty.

ScanPal EDA50 comes with a battery in a separate package. Please follow the steps below to install the battery.

1. Press down the battery cover safety button to move the battery cover safety lock to the unlock position at right;
2. Open the battery cover with the battery cover buckle handle ;
3. Insert the battery (Insert the non-connector side first, then press the battery down to establish connection between the battery and the phone)
4. Press down the battery cover (Insert the non-connector side first, then press the battery cover down)
5. Press down the battery cover safety button to move the battery cover safety lock to the lock position at left

Remarks:

Refer to the illustrated installation steps on the following page.

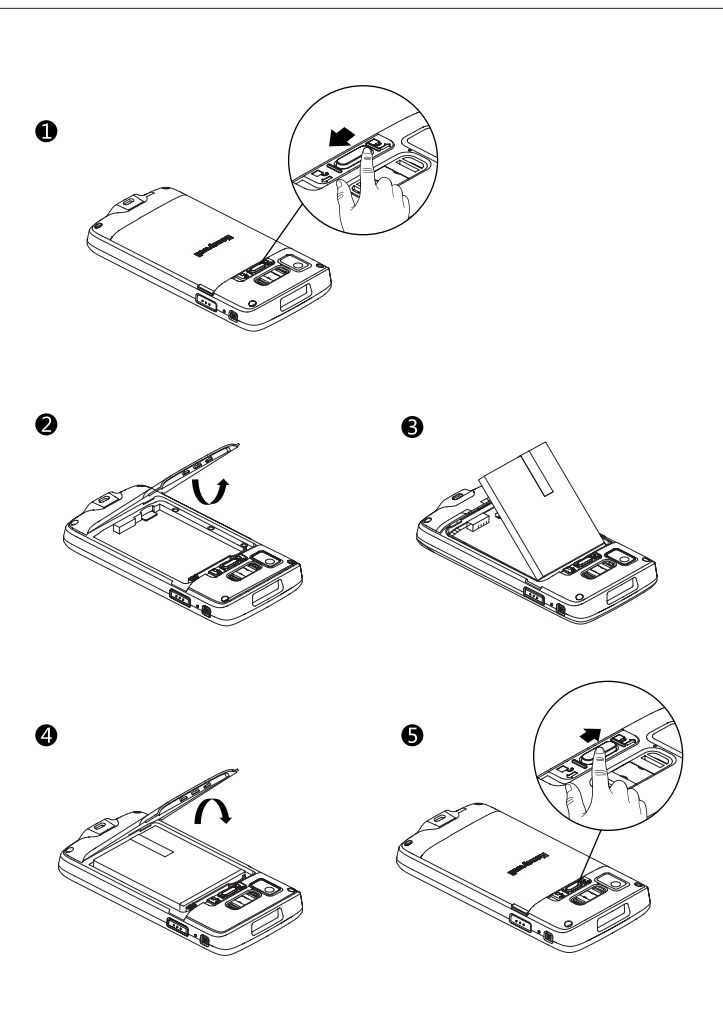

Charging / Sync

Synchronous Communication

Open the USB cover at the bottom of ScanPal EDA50
Connect ScanPal™ EDA50 to the computer using the Micro USB cable

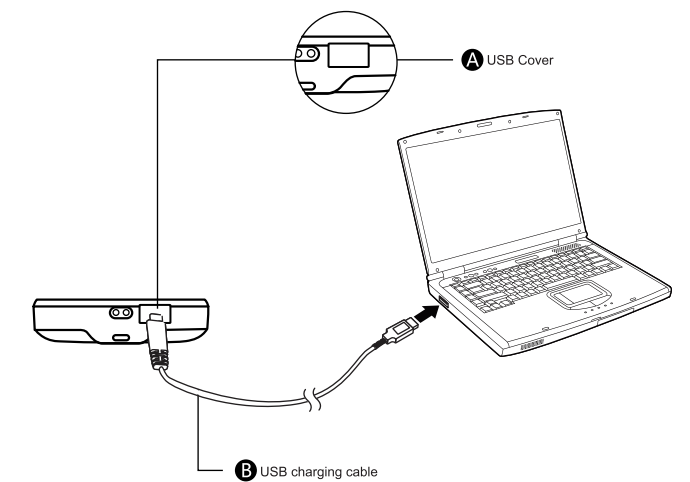

Charging / Sync

Charging

1. Open the USB cover at the bottom of ScanPal EDA50;
2. Connect ScanPal EDA50 to the power adapter with USB charging cable;
3. Make sure the replaceable adapter plug plugged into the power adapter;
4. Connect the power adapter to the wall plug and start charging for ScanPal EDA50.

Fully charge the ScanPal EDA50 before using it for the first time.

Using the device while charging will significantly extend the time required to fully charge.

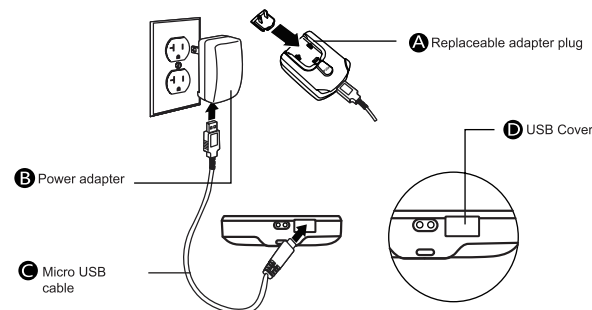

Remarks:

It's recommended to use Honeywell's peripherals, batteries, USB charging cables and power adapters.

Damages caused by using non-Honeywell peripherals, batteries, USB charging cables or power adapters are not covered by the warranty.

Warnings:

Please make sure all kits are dry when use the terminal and battery with other accessories.

Damages caused by using wet kits may not be covered by the warranty.

Use Scan Engine

Align the aiming beam with the barcodes, and adjust the angle between the beam and the barcodes to get the best results.

The recommended range from the terminal to the barcodes is 4" to 10" (10cm to 25cm)

1. Tap All Apps > Demos > Scan Demo;
2. Click Scan on the screen or press one of the Scan Buttons;
3. Center the aiming beam over the barcode;
4. Adjust the aiming beam: for optimum performance, avoid reflections by scanning the barcode at a slight angle;

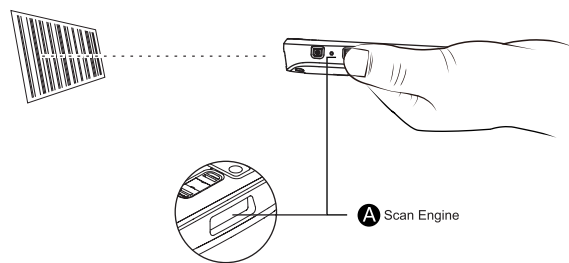

Suspend / Wake Up the Terminal

Suspend / Wake Up the Terminal

Press the power button and then release (less than 2 seconds)

To wake up the device from sleep mode, press the power button and then release (less than 2 seconds)

Reboot

When something is wrong with the OS, press the reset button and then release to restart ScanPal EDA50

ScanPal EDA50 Power Indicator

The status of power indicators in non-charging and charging process are illustrated as below:

Non-charging process	
Off	Battery power is normal
Flashing orange	Battery power is low
Charging process	
Constant green	Charging complete
Flashing green	During charging process, and the charging is about to be completed
Orange	During charging process, and the battery power is still low
Flashing red	Battery is abnormal

Install memory card

1. Power off;
2. Press down the battery cover safety button to move the lock to the unlock position at right;
3. Open the battery cover with the battery cover buckle handle ;
4. Pull out the battery (First open the battery connector side, then pull out the battery)
5. Insert the Micro SD card to SD card slot until it clicks;
6. Insert the battery (Insert the non-connector side first, then press the battery down to establish connection between the battery and the phone);
7. Press down the battery cover (Insert the non-connector side first, then press the battery cover down);
8. Press down the battery cover safety button to move the battery cover safety lock to the lock position at left;
9. Power on

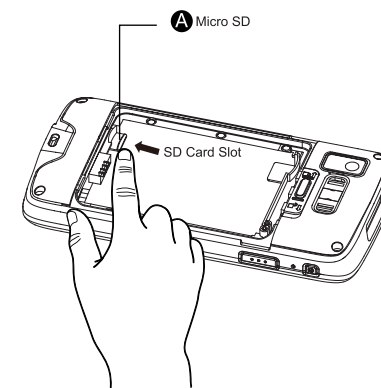

Install SIM Card (Optional)

1. Power off the device;
2. Press down the battery cover safety button and move the battery cover lock to the unlock position to the right;
3. Open the battery cover using the battery cover notches;
4. Pull out the battery: first pull the bottom side, then pull out the battery;
5. Insert the SIM card into the SIM card slot until it clicks;
6. Insert the battery: insert the top part first, then press the bottom part to lock it in place;
7. Install the battery cover: insert the bottom part first, then press the top part;
8. Press down the battery cover safety button and move the battery cover lock to the lock position at the left;
9. Power on the device

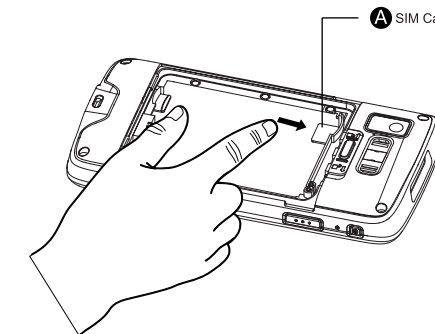

Note: only EDA50-111 delivers this feature

Aiming Beam

The aiming beam gets narrower when the terminal gets closer to the barcodes, while it gets wider when the terminal gets farther from the barcodes.

The smaller the barcodes, the closer the aiming beams should get to the barcodes
The bigger the barcodes, the father the aiming beams should get to the barcodes

Beam positions when scan barcodes



Technical Support

For information about technical support, after-sales service and maintenance, please visit www.honeywellaidc.com.

User Documents

For the local version of this article, please visit www.honeywellaidc.com.

Patents

For information on patents, please refer to www.honeywellaidc.com/patents.

Warranty

Please log into www.honeywellaidc.com/warranty_information for warranty information on your product.

Disclaimer

Honeywell International Inc. reserves the rights to modify the specifications and other information mentioned above without prior notification.

Readers should consult Honeywell International Inc. to make sure if any changes made any time they read this article.

The information in this article does not represent any commitments of Honeywell International Inc.

Honeywell International Inc. is not responsible for direct or indirect loss caused by any technical or editing errors or omissions contained in this article.

The proprietary information contained in this article is protected by copyright.

All rights reserved.

Without prior written consent from Honeywell International Inc., any form of photocopy, copy or translation into other languages for any part of this article is not allowed.

All Rights Reserved by Honeywell International Inc.
Website: www.honeywellaidc.com

Honeywell

Federal Communications Commission (FCC) Interference Statement

This equipment has been tested and found to comply with the limits for a Class B digital device, pursuant to Part 15 of the FCC Rules.

These limits are designed to provide reasonable protection against harmful interference in a residential installation. This equipment generate, uses and can radiate radio frequency energy and, if not installed and used in accordance with the instructions, may cause harmful interference to radio communications.

However, there is no guarantee that interference will not occur in a particular installation. If this equipment does cause harmful interference to radio or television reception, which can be determined by turning the equipment off and on, the user is encouraged to try to correct the interference by one of the following measures:

- Reorient or relocate the receiving antenna.
- Increase the separation between the equipment and receiver.
- Connect the equipment into an outlet on a circuit different from that to which the receiver is connected.
- Consult the dealer or an experienced radio/TV technician for help.

This device complies with Part 15 of the FCC Rules. Operation is subject to the following two conditions:

(1) This device may not cause harmful interference, and (2) this device must accept any interference received, including interference that may cause undesired operation.

FCC Caution: Any changes or modifications not expressly approved by the party responsible for compliance could void the user's authority to operate this equipment.

The SAR limit adopted by USA is 1.6 watts/kilogram (W/kg) averaged over one gram of tissue. The highest SAR value reported to the Federal Communications

Commission (FCC) for this device type when it is properly worn on the body is 1.095 W/kg, head is 1.017 W/kg, Hotspot is 1.095 W/kg.

For body worn operation, this product has been tested and meets the FCC RF exposure guidelines for use with an accessory that contains no metal and the positions the handset a minimum of 1.0 cm from the body. Use of other enhancements may not ensure compliance with FCC RF exposure guidelines. If you do not use a body-worn accessory and are not holding the phone at the ear, position the handset a minimum of 1.0 cm from your body when the phone is switched on.

RF exposure warning

This equipment complies with FCC radiation exposure limits set forth for an uncontrolled environment.

Free Manuals Download Website

<http://myh66.com>

<http://usermanuals.us>

<http://www.somanuals.com>

<http://www.4manuals.cc>

<http://www.manual-lib.com>

<http://www.404manual.com>

<http://www.luxmanual.com>

<http://aubethermostatmanual.com>

Golf course search by state

<http://golfingnear.com>

Email search by domain

<http://emailbydomain.com>

Auto manuals search

<http://auto.somanuals.com>

TV manuals search

<http://tv.somanuals.com>