



HP Notebook PC (AMD)

** Models: 14-an0XX*

** Models: 14-as0XX*

** Models: 14-au0XX*

** Models: 14z-an000*

HP 245 G5 Notebook PC

Maintenance and Service Guide

© Copyright 2016 HP Development Company, L.P.

AMD is a trademark of Advanced Micro Devices, Inc. Bluetooth is a trademark owned by its proprietor and used by HP Inc. under license. Intel is a trademark of Intel Corporation in the U.S. and other countries. Microsoft and Windows are U.S. registered trademarks of the Microsoft group of companies.

The information contained herein is subject to change without notice. The only warranties for HP products and services are set forth in the express warranty statements accompanying such products and services. Nothing herein should be construed as constituting an additional warranty. HP shall not be liable for technical or editorial errors or omissions contained herein.

Second Edition: August 2016

First Edition: April 2016

Document Part Number: 855442-002

Product notice

This guide describes features that are common to most models. Some features may not be available on your computer.

Not all features are available in all editions of Windows. This computer may require upgraded and/or separately purchased hardware, drivers, and/or software to take full advantage of Windows functionality. See <http://www.microsoft.com> for details.

Software terms

By installing, copying, downloading, or otherwise using any software product preinstalled on this computer, you agree to be bound by the terms of the HP End User License Agreement (EULA). If you do not accept these license terms, your sole remedy is to return the entire unused product (hardware and software) within 14 days for a refund subject to the refund policy of your place of purchase.

For any further information or to request a full refund of the computer, please contact your local point of sale (the seller).

Safety warning notice

 **WARNING!** To reduce the possibility of heat-related injuries or of overheating the device, do not place the device directly on your lap or obstruct the device air vents. Use the device only on a hard, flat surface. Do not allow another hard surface, such as an adjoining optional printer, or a soft surface, such as pillows or rugs or clothing, to block airflow. Also, do not allow the AC adapter to contact the skin or a soft surface, such as pillows or rugs or clothing, during operation. The device and the AC adapter comply with the user-accessible surface temperature limits defined by the International Standard for Safety of Information Technology Equipment (IEC 60950-1).

Table of contents

1 Product description	1
2 External component identification	5
Display	5
Right side	6
Left side	7
Top	8
TouchPad	8
Lights	9
Button	10
Keys	11
Bottom	12
Service tag	13
3 Illustrated parts catalog	15
Computer major components	15
Miscellaneous parts	18
Display assembly subcomponents	19
Mass storage devices	20
4 Removal and replacement procedures preliminary requirements	21
Tools required	21
Service considerations	21
Plastic parts	21
Cables and connectors	21
Drive handling	22
Grounding guidelines	22
Electrostatic discharge damage	22
Packaging and transporting guidelines	23
Workstation guidelines	23
5 Removal and replacement procedures for Customer Self-Repair parts	25
Component replacement procedures	25
Battery	26
Optical drive	27

6 Removal and replacement procedures for Authorized Service Provider parts	29
Component replacement procedures	29
Bottom cover	30
Hard drive	32
eMMC module	34
WLAN module	36
Memory module	38
RTC battery	39
USB board	40
Speakers	41
Power button board	42
Heat sink assembly	43
Fan	46
System board	48
TouchPad button board	52
Display assembly	53
Power connector cable	61
Top cover/keyboard	62
7 Using Setup Utility (BIOS) in Windows 10	63
Starting Setup Utility (BIOS)	63
Updating Setup Utility (BIOS)	63
Determining the BIOS version	63
Downloading a BIOS update	64
8 Backing up, restoring, and recovering in Windows 10	65
Creating recovery media and backups	65
Creating HP Recovery media (select products only)	65
Using Windows tools	66
Restore and recovery	67
Recovering using HP Recovery Manager	67
What you need to know before you get started	67
Using the HP Recovery partition (select products only)	68
Using HP Recovery media to recover	68
Changing the computer boot order	69
Removing the HP Recovery partition (select products only)	69
9 Using HP PC Hardware Diagnostics (UEFI)	71
Downloading HP PC Hardware Diagnostics (UEFI) to a USB device	71

10 Specifications	73
Computer specifications	73
35.6-cm (14.0-in) display specifications	74
Hard drive specifications	75
DVD±RW SuperMulti DL Drive specifications	76
11 Statement of memory volatility	77
Nonvolatile memory usage	81
Questions and answers	83
Using HP Sure Start (select models only)	84
12 Power cord set requirements	85
Requirements for all countries	85
Requirements for specific countries and regions	86
13 Recycling	89
Index	91

1 Product description

Category	Description	Discrete graphics	UMA graphics	UMA, on-board mem, eMMC	UMA, on-board mem	HP 245 G5
Product name	HP Notebook PC	√	√	√	√	
	Model numbers: 14-an0XX, 14-as0XX, 14-au0XX, 14z-an000					
	HP 245 G5 Notebook PC					√
Processor	AMD Quad-Core A-Series Processor	√	√			√
	A8-7410 (2.2 GHz, turbo up to 2.5 GHz), 1600 MHz/2 MB L2, Quad 15W					
	A6-7310 (2.0 GHz, turbo up to 2.4 GHz), 1600 MHz/2 MB L2, Quad 15W	√	√			√
	A4-7210 (1.8 GHz, turbo up to 2.2 GHz), 1600 MHz/2 MB L2, Quad 15W			√		
	A4-3350B (2.0 GHz, turbo up to 2.4 GHz), 1600 MHz/2 MB L2, Quad 15W					√
AMD Quad-Core E-Series Processor			√	√	√	√
	E2-7110 (1.8 GHz), 1600 MHz/2 MB L2, Quad 15W					
Chipset	Integrated SoC FCH	√	√	√	√	√
Graphics	Internal graphics	√				√
	AMD Radeon™ R5 Graphics (A8 processor)					
	AMD Radeon R4 Graphics (A6 processor)	√				√
	AMD Radeon R3 Graphics (A4 processor)		√	√	√	
	AMD Radeon R2 Graphics (E1/E2 processor)		√	√	√	√
	Switchable discrete graphics	√				
	AMD Radeon R5 M430 R16M-M1-30 (Exo Pro DDR3) with up to 2048MB of dedicated video memory					
	Supports HD Decode, DX12, HDMI	√	√	√	√	
Supports PX7	√					
Panel	35.6-cm (14.0-in) , white light-emitting diode (WLED), BrightView (1366×768) display, slim-flat 3.0 mm, eDP; typical brightness: 220 nits:	√	√	√	√	√
	HD, SVA	√	√	√	√	√
	FHD, UWVA		√			
Memory	Two non-customer-accessible/upgradable memory module slots	√	√			√
	DDR3L-1600 Single Channel Support					

Category	Description	Discrete graphics	UMA graphics	UMA, on-board mem, eMMC	UMA, on-board mem	HP 245 G5
	Supports up to 16 GB of system RAM in the following configurations: <ul style="list-style-type: none"> 8192-MB total system memory (8192×1) or (4096×2) 6144-MB total system memory (4096×1) + (2048×1) 4096-MB total system memory (4096×1) or (2048×2) 2048-MB total system memory (2048×1) 					
	<ul style="list-style-type: none"> 16384-MB total system memory (8192×2) 	√				√
	On-board system memory DDR3L-1600 single channel support Supports up to 2 GB max on-board system memory			√	√	
Hard drives	Single hard drive configurations Supports 6.35-cm (2.5-in) SATA hard drives in 9.5-mm (.37-in) and 7.0-mm (.28-in) thicknesses <ul style="list-style-type: none"> 2-TB, 5400-rpm, 9.5-mm 1-TB, 5400-rpm, 9.5-mm 500-GB, 5400-rpm, 9.5-mm or 7.2-mm 	√	√	√	√	√
	<ul style="list-style-type: none"> 500-GB, 7200-rpm, 7.0-mm 					√
	SSHD configurations 500 GB, 5400 RPM, 7 mm, SSHD w/8GB NAND		√			
	eMMC configurations 32 GB		√	√		
	64 GB		√			
Optical drive	Fixed, serial ATA, 9.5-mm tray load Supports configuration without optical drive	√	√	√	√	√
	DVD+/-RW Double-Layer SuperMulti	√	√		√	√
	Supports zero power optical drive					
	Supports M-disc					
Webcam/mic	HP TrueVision HD: HD camera - activity LED, USB 2.0, BSI sensor, 1280 x 720 by 30 frames per second HP Webcam– 640 x 480 by 24 frames per second Single digital microphone HP Noise Cancellation enabled	√	√	√	√	√
Audio	DTS Studio Sound Dual speakers	√	√	√	√	√

Category	Description	Discrete graphics	UMA graphics	UMA, on-board mem, eMMC	UMA, on-board mem	HP 245 G5
Ethernet	Integrated 10/100 network interface card (NIC)	√	√	√	√	
Wireless Network	<p>Integrated wireless options with single antenna (M.2/PCIe):</p> <p>Compatible with Miracast-certified devices</p> <p>Support for the following WLAN formats:</p> <ul style="list-style-type: none"> Intel Dual Band Wireless-AC 3165 802.11 ac 1x1 WiFi + BT 4.2 Combo Adapter Intel Dual Band Wireless-AC 3168 802.11 ac 1x1 WiFi + BT 4.2 Combo Adapter Realtek RTL8188EE-VJ 802.11b/g/n 1x1 Wi-Fi Adapter Realtek RTL8188EE 802.11b/g/n 1x1 Wi-Fi Adapter Realtek RTL8723BE-VB 802.11b/g/n 1x1 Wi-Fi + BT4.0 Combo Adapter (HP Notebook PC models only) 	√	√	√	√	√
External media card	<p>HP Multi-Format Digital Media Reader</p> <p>Support SD/SDHC/SDXC</p> <p>Push-Pull Insertion/Removal</p>	√	√	√	√	√
Internal Card	One M.2 slot for WLAN	√	√	√	√	√
Ports	<p>VGA (Dsub 15 pin) supporting: 1920 × 1200 external resolution @ 60Hz. Hot Plug/unplug and auto detect for correct output to wide-aspect vs. standard aspect video.</p> <p>HDMI version 1.4b supporting 1920 × 1080 @ 60Hz</p> <p>RJ-45 (Ethernet)</p> <p>USB 3.0 (1 port; left side)</p> <p>USB 2.0 (2 ports; 1 left side, 1 right side)</p> <p>AC Smart Pin adapter plug</p> <p>Headphone/line out and microphone/line in combo jack</p>	√	√	√	√	√
Keyboard/pointing devices	<p>Full-size textured "island style" keyboard with numeric keypad</p> <p>TouchPad with multi-touch gestures enabled</p> <p>Taps enabled by default</p> <p>Support Modern Trackpad Gestures</p>	√	√	√	√	√
Power	<p>AC adapters</p> <p>65-W</p> <p>65-W EM</p> <p>45-W</p> <p>45-W EM</p>	√				√
		√				
			√	√	√	√

Category	Description	Discrete graphics	UMA graphics	UMA, on-board mem, eMMC	UMA, on-board mem	HP 245 G5
	1 meter power cord	√	√	√	√	√
	Batteries	√	√	√	√	√
	4-cell, 41-Whr Li-ion battery					
	3-cell, 31-Whr Li-ion battery		√	√	√	√
	6-cell, 47-Whr Li-ion battery					√
Security	TPM 2.0	√	√	√	√	√
	Kensington Security Lock					
Operating system	Preinstalled	√	√			√
	Windows 10					
	Windows 10 Professional					
	Windows 10 Home ML					
	Windows 10 Home Value Notebook				√	
	Windows 10 Home Entry NB		√	√		
	Windows 10 Home Entry NB EM/SL					
	Windows 10 Home Entry NB w/OneDrive					
	Windows 10 Home Entry NB w/OneDrive EM/SL					
	Windows 10 Home EM/SL	√	√	√		
	Windows 10 Home High End ML					
	Windows 10 Home EM/SL	√	√			
	Windows 10 Home Value Notebook EM/SL				√	
	CPPP Windows 10 Home China/SL 64	√	√			
	CPPP Windows 10 Home EM/SL 64 SEAP					
	Windows 10 Home Value Notebook EM/SL 64 SEAP NB	√	√		√	
	Windows 10 Home Value India EM/SL 64 NB				√	
	Windows 10 Professional Shape the Future MSNA (EM)					√
	Windows 10 Pro Downgrade to Windows 7 Pro					
	Windows 10 Pro Downgrade to Windows 7 Pro StF MSNA					
	Windows 10 Home MSNA (EM)					√
	FreeDOS 2.0	√	√	√	√	√
Service	End-user replaceable parts	√	√	√	√	√
	AC adapter					
	Battery					
	Optical drive					

2 External component identification

Display



Component	Description
(1) Webcam light	On: The webcam is in use.
(2) Webcam	Records video and captures photographs. Some products allow you to video conference and chat online using streaming video. To use a webcam (integrated camera): <ul style="list-style-type: none">▲ Type <code>camera</code> in the taskbar search box, and then select Camera.
(3) Internal microphone	Records sound.
(4) WLAN antennas*	Send and receive wireless signals to communicate with wireless local area networks (WLANs).

*The antennas are not visible from the outside of the computer. For optimal transmission, keep the areas immediately around the antennas free from obstructions.



For wireless regulatory notices, see the section of the *Regulatory, Safety, and Environmental Notices* that applies to your country or region.

To access this guide:

- ▲ Select the **Start** button, select **All apps**, select **HP Help and Support**, and then select **HP Documentation**.

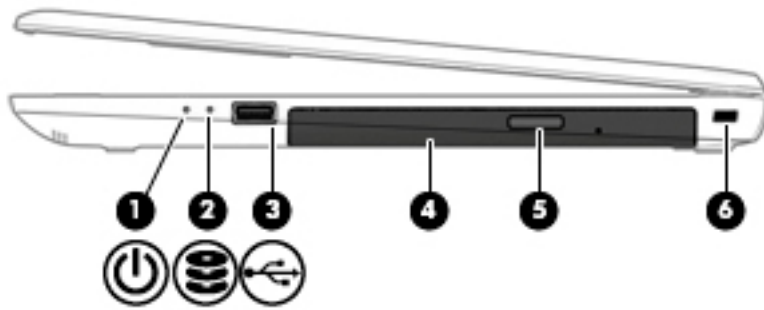





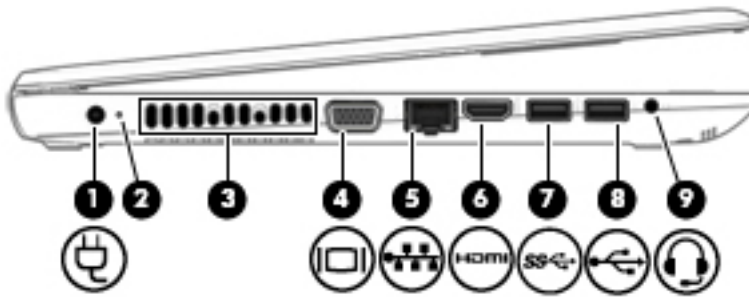

Right side



Component	Description
(1)  Power light	<ul style="list-style-type: none">• On: The computer is on.• Blinking: The computer is in the Sleep state, a power-saving state. The computer shuts off power to the display and other unneeded components.• Off: The computer is off or in Hibernation. Hibernation is a power-saving state that uses the least amount of power.
(2)  Drive light (select products only)	<ul style="list-style-type: none">• Blinking white: The hard drive is being accessed.
(3)  USB 2.0 port	Connects an optional USB device, such as a keyboard, mouse, external drive, printer, scanner or USB hub.
(4) Optical drive (select products only)	Depending on your computer, reads an optical disc or reads and writes to an optical disc. NOTE: For disc compatibility information, type <code>help</code> in the taskbar search box, select Help and Support , and then type <code>disc compatibility</code> in the search box.
(5) Optical drive eject button (select products only)	Releases the optical drive disc tray.
(6) Security cable slot	Attaches an optional security cable to the computer. NOTE: The security cable is designed to act as a deterrent, but it may not prevent the computer from being mishandled or stolen.

Left side



Component	Description
(1) 	Connects an AC adapter.
(2) 	<ul style="list-style-type: none"> White: The AC adapter is connected and the battery is fully charged. Blinking white: The AC adapter is disconnected and the battery has reached a low battery level. Amber: The AC adapter is connected and the battery is charging. Off: The battery is not charging.
(3) 	Enables airflow to cool internal components. NOTE: The computer fan starts up automatically to cool internal components and prevent overheating. It is normal for the internal fan to cycle on and off during routine operation.
(4) 	Connects an external VGA monitor or projector.
(5) 	<ul style="list-style-type: none"> White: The network is connected. Amber: Activity is occurring on the network.
(6) 	Connects an optional video or audio device, such as a high-definition television, any compatible digital or audio component, or a high-speed High-Definition Multimedia Interface (HDMI) device.
(7) 	Connects an optional USB device, such as a keyboard, mouse, external drive, printer, scanner or USB hub.
(8) 	Connects an optional USB device, such as a keyboard, mouse, external drive, printer, scanner or USB hub.
(9) 	Connects optional powered stereo speakers, headphones, earbuds, a headset, or a television audio cable. Also connects an optional headset microphone. This jack does not support optional standalone microphones.

Component	Description
	<p>WARNING! To reduce the risk of personal injury, adjust the volume before putting on headphones, earbuds, or a headset. For additional safety information, refer to the <i>Regulatory, Safety, and Environmental Notices</i>.</p> <p>To access this guide:</p> <ul style="list-style-type: none"> ▲ Select the Start button, select All apps, select HP Help and Support, and then select HP Documentation. <p>NOTE: When a device is connected to the jack, the computer speakers are disabled.</p>

Top

TouchPad

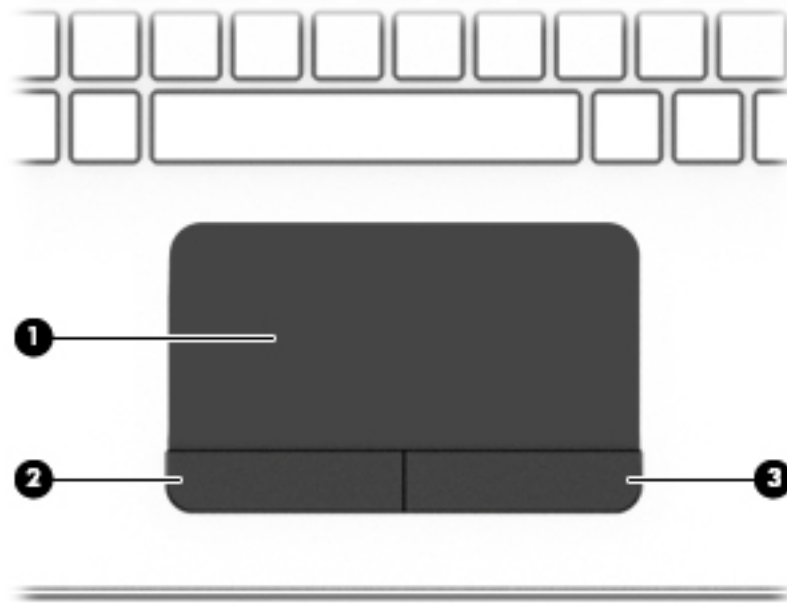

Component	Description
(1) TouchPad zone	Reads your finger gestures to move the pointer or activate items on the screen.
(2) Left TouchPad button	Functions like the left button on an external mouse.
(3) Right TouchPad button	Functions like the right button on an external mouse.

Lights

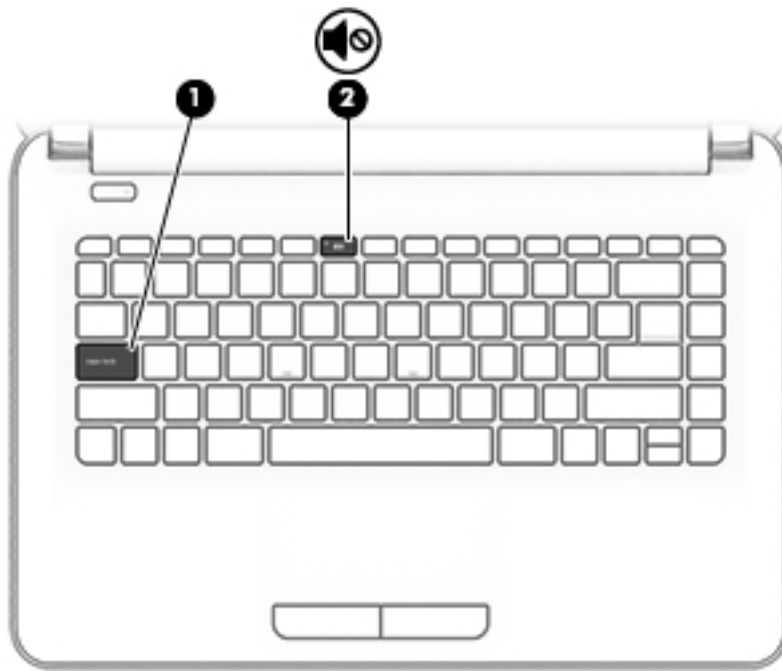

Component	Description
(1) Caps lock light	On: Caps lock is on, which switches the key input to all capital letters.
(2)  Mute light	<ul style="list-style-type: none">• Amber: Computer sound is off.• Off: Computer sound is on.

Button

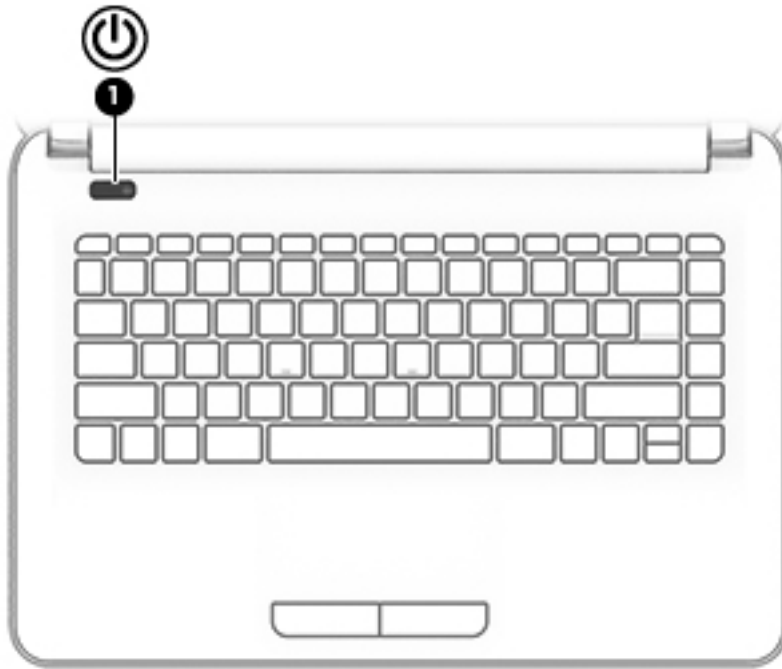

Component	Description
<p>(1)  Power button</p>	<ul style="list-style-type: none">• When the computer is off, press the button to turn on the computer.• When the computer is on, press the button briefly to initiate Sleep.• When the computer is in the Sleep state, press the button briefly to exit Sleep.• When the computer is in Hibernation, press the button briefly to exit Hibernation. <p>CAUTION: Pressing and holding down the power button results in the loss of unsaved information.</p> <p>If the computer has stopped responding and shutdown procedures are ineffective, press and hold the power button down for at least 5 seconds to turn off the computer.</p> <p>To learn more about your power settings, see your power options.</p> <ul style="list-style-type: none">▲ Type <code>power</code> in the taskbar search box, and then select Power and sleep settings. <p>– or –</p> <p>Right-click the Start button, and then select Power Options.</p>

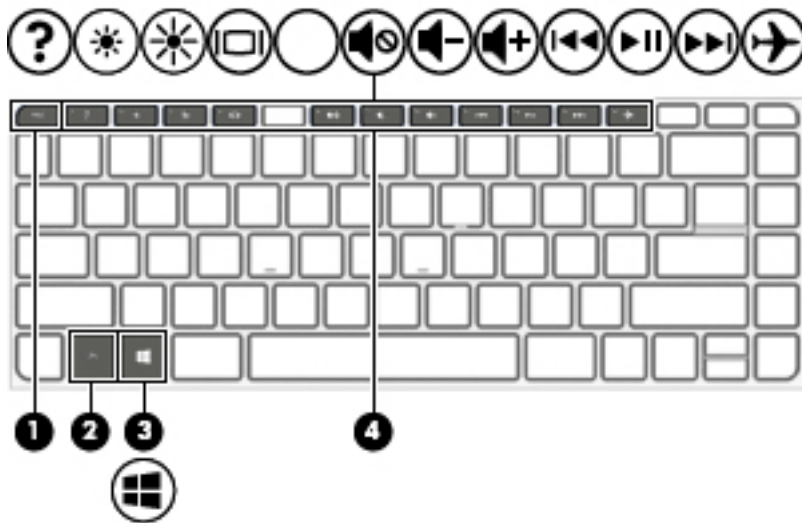

Keys

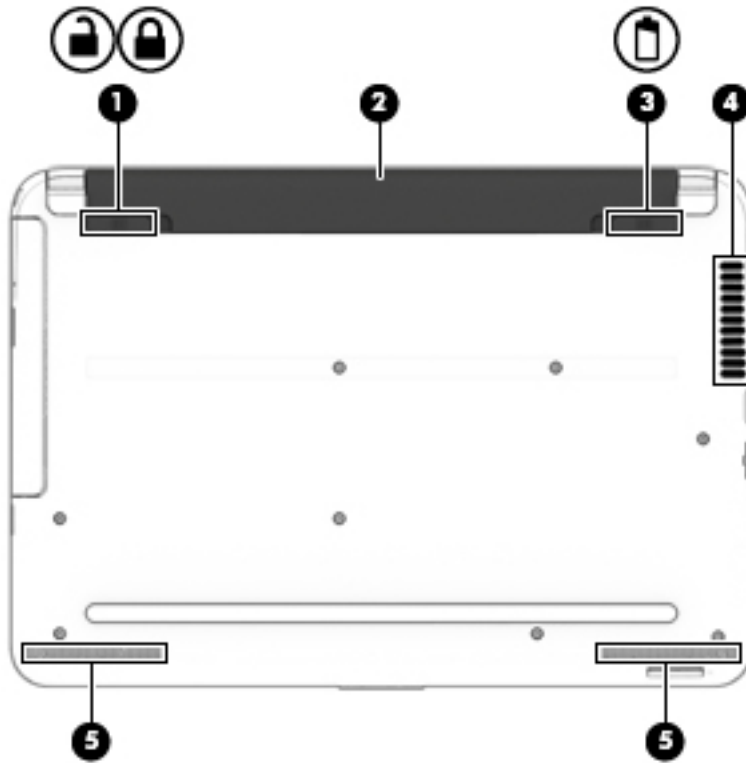

Component	Description
(1) <code>esc</code> key	Displays system information when pressed in combination with the <code>fn</code> key.
(2) <code>fn</code> key	Executes frequently used system functions when pressed in combination with the <code>esc</code> key, action keys, or the <code>spacebar</code> .
(3)  Windows key	Opens the Start menu. NOTE: Pressing the Windows key again will close the Start menu.
(4) Action keys	Execute frequently used system functions.

Bottom



Component	Description
(1)  	Battery lock Locks the battery in the battery bay.
(2)	Battery bay Holds the battery.
(3) 	Battery release latch Releases the battery.
(4)	Vent Enables airflow to cool internal components. NOTE: The computer fan starts up automatically to cool internal components and prevent overheating. It is normal for the internal fan to cycle on and off during routine operation.
(5)	Speakers (2) Produce sound.

Service tag

When ordering parts or requesting information, provide the computer serial number and model number provided on the service tag.

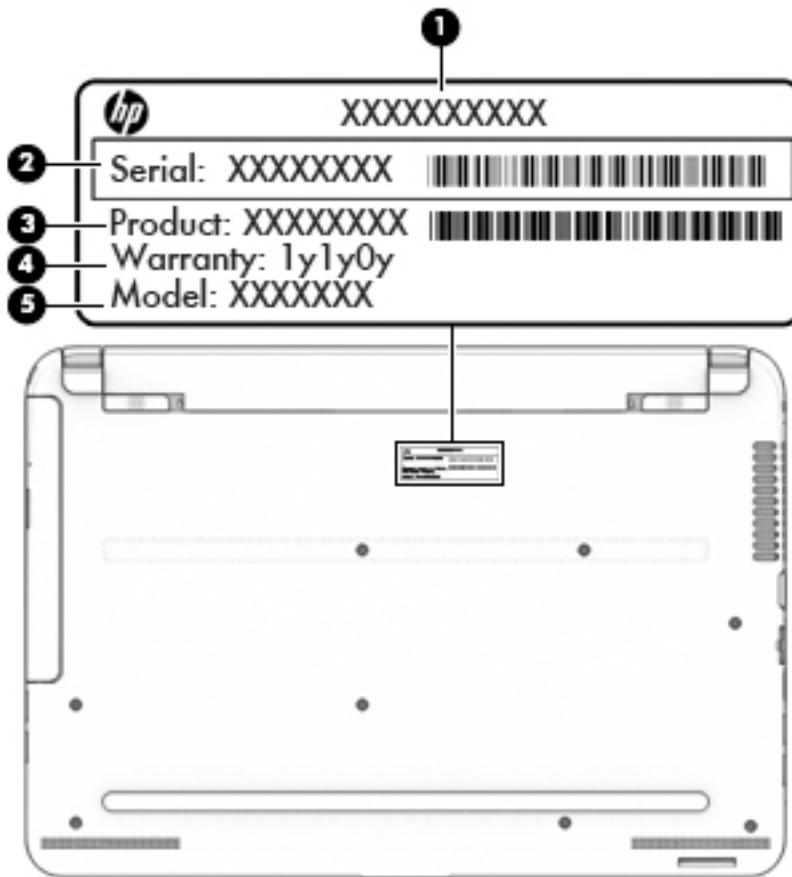

Item	Description	Function
(1)	Product name	This is the product name affixed to the front of the computer.
(2)	Serial number (s/n)	This is an alphanumeric identifier that is unique to each product.
(3)	Part number/Product number (p/n)	This number provides specific information about the product's hardware components. The part number helps a service technician to determine what components and parts are needed.
(4)	Warranty period	This number describes the duration of the warranty period for the computer.
(5)	Model description	This is the alphanumeric identifier used to locate documents, drivers, and support for the computer.

3 Illustrated parts catalog

Computer major components

 **NOTE:** HP continually improves and changes product parts. For complete and current information on supported parts for your computer, go to <http://partsurfer.hp.com>, select your country or region, and then follow the on-screen instructions.

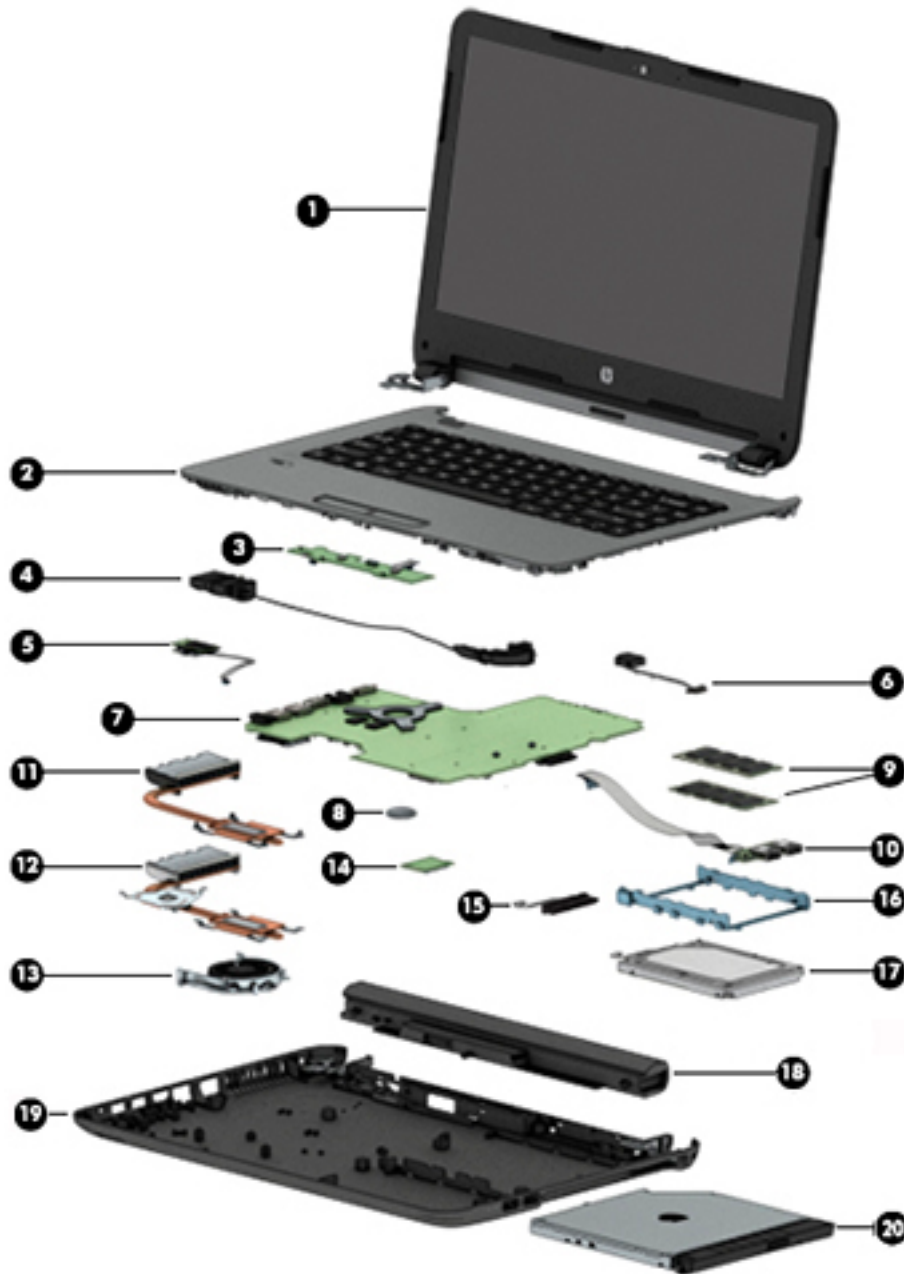

Item	Component	Spare part number
(1)	Display assembly (35.6-cm [14.0-in] HD, anti-glare, touchscreen) NOTE: Full display hinge-ups are not spared. For display assembly subcomponent spare part information, see Display assembly subcomponents on page 19 .	not spared
(2)	Top cover/keyboard (includes touchpad) NOTE: For a list of country codes, see Top cover/keyboard on page 62 . For use only in HP Notebook PC models:	
	• Turbo silver	858078-xx1
	• White silver	858079-xx1
	• Red	858080-xx1
	• Blue	858082-xx1
	For use in all models:	
	• Black	858077-xx1
(3)	Touchpad button board (includes cable)	813517-001
(4)	Speakers (left and right)	858083-001
(5)	Power button board (includes cable)	813516-001
(6)	Power connector cable	813505-001
(7)	System board (includes replacement thermal materials): All system boards use the following part numbers: xxxxxx-001: Windows 7 or non-Windows operating systems xxxxxx-601: Windows 10 operating system HP Notebook PC models with 2 GB of discrete graphics memory:	
	• AMD A8-7410 processor	858046-xx1
	• AMD A6-7310 processor	858045-xx1
	HP Notebook PC models with UMA graphics memory:	
	• AMD A8-7410 processor	858044-xx1
	• AMD A6-7310 processor	858043-xx1
	• AMD A4-7210 processor	858042-xx1
	• AMD E2-7110 processor	858047-xx1
	• AMD E2-7110 processor and 2 GB on-board system memory	858048-xx1
	• AMD E2-7110 processor, 2 GB on-board system memory, and a 32 GB eMMC drive	858049-xx1
	HP 245 G5 models:	
	• AMD A8-7410 processor	907163-xx1
	• AMD A6-7310 processor	860452-xx1
	• AMD A4-3350B processor	907162-xx1

Item	Component	Spare part number
	<ul style="list-style-type: none"> AMD E2-7110 processor 	860451-xx1
(8)	RTC battery	718440-001
(9)	Memory module (PC3L, 12800, 1600-MHz):	
	8-GB	693374-005
	4 GB	691740-005
	2 GB	691739-005
(10)	USB board (includes cable)	813515-001
	Heat sink assembly (includes replacement thermal materials):	
(11)	For use in models with UMA graphics memory	813507-001
(12)	For use in models with discrete graphics memory (HP Notebook PC models only)	813508-001
(13)	Fan	813506-001
(14)	WLAN module	
	Realtek RTL8723BE-VB 802.11b/g/n 1x1 Wi-Fi + BT4.0 Combo Adapter	855106-885
	Intel Dual Band Wireless-AC 3165 802.11 ac 1x1 WiFi + BT 4.2 Combo	806723-005
	Realtek RTL8188EE-VJ 802.11b/g/n 1x1 Wi-Fi Adapter	857334-855
	Intel Dual Band Wireless-AC 3168 802.11 ac 1x1 WiFi + BT 4.2 Combo	863934-855
(15)	Hard drive connector	815139-001
(16)	Hard drive bracket	859126-001
(17)	Hard drive (SATA; does not include bracket or cable):	
	NOTE: The hard drive cable is available using spare part number 815139-001.	
	1-TB, 5400-rpm, 2.5-inch	778192-005
	500-GB, 5400-rpm, 7-mm	778186-005
	500-GB, 5400-rpm, hybrid 8 GB SSD, 7-mm	732000-005
	eMMC drive, M.2 (includes eMMC board, bracket, cable, foam, and screws; not illustrated)	
	64 GB	903803-001
	32 GB	861964-001
(18)	Battery	
	6-cell, 47-Whr, 2.2-Ah Li-ion battery (for use only in HP 245 G5 Notebook PC models)	844198-850
	4-cell, 41-Whr, 2.8-Ah Li-ion battery (for use in all models)	807957-001
	3-cell, 31-Whr, 2.8-Ah Li-ion battery (for use in all models)	807956-001
(19)	Base enclosure	
	For use in HP Notebook PC models:	
	<ul style="list-style-type: none"> Models with an optical drive 	858071-001
	<ul style="list-style-type: none"> Models without an optical drive 	858072-001

Item	Component	Spare part number
	For use in HP 245 G5 Notebook PC models:	
	• Models with an optical drive	860455-001
	• Models without an optical drive	860471-001
	Rubber Kit (includes rear left and right feet; not illustrated):	
	For use in HP Notebook PC models	862192-001
	For use in HP 245 G5 Notebook PC models	813522-001
(20)	Optical drive (DVD+/-RW Double-Layer SuperMulti; includes bracket and bezel):	
	For use in HP Notebook PC models	863675-001
	For use in HP 245 G5 Notebook PC models	813514-001
		906505-001

Miscellaneous parts

Component	Spare part number
HP Smart AC adapter (4.5 mm, non-PFC)	
65-W EM	714635-850
65-W (HP Notebook PC models only)	710412-001
45-W	741553-850
Power cord (3-pin, black, 1.00-m) for use in:	
Argentina	401300-007
Australia	213356-008
Brazil	438722-004
The People's Republic of China	286497-008
Europe	213350-009
India	404827-003
Italy	213352-008
Japan	349756-002
North America	213349-009
South Korea	267836-008
Taiwan	393313-003
Thailand	285096-006
The United Kingdom and Singapore	213351-008
Rubber Kit (includes front and rear feet)	
For use in HP Notebook PC models	862192-001

Component	Spare part number
For use in HP 245 G5 Notebook PC models	813522-001
Screw Kit	813523-001
Notebook case, Chroma sleeve, black/red	853426-001

Display assembly subcomponents

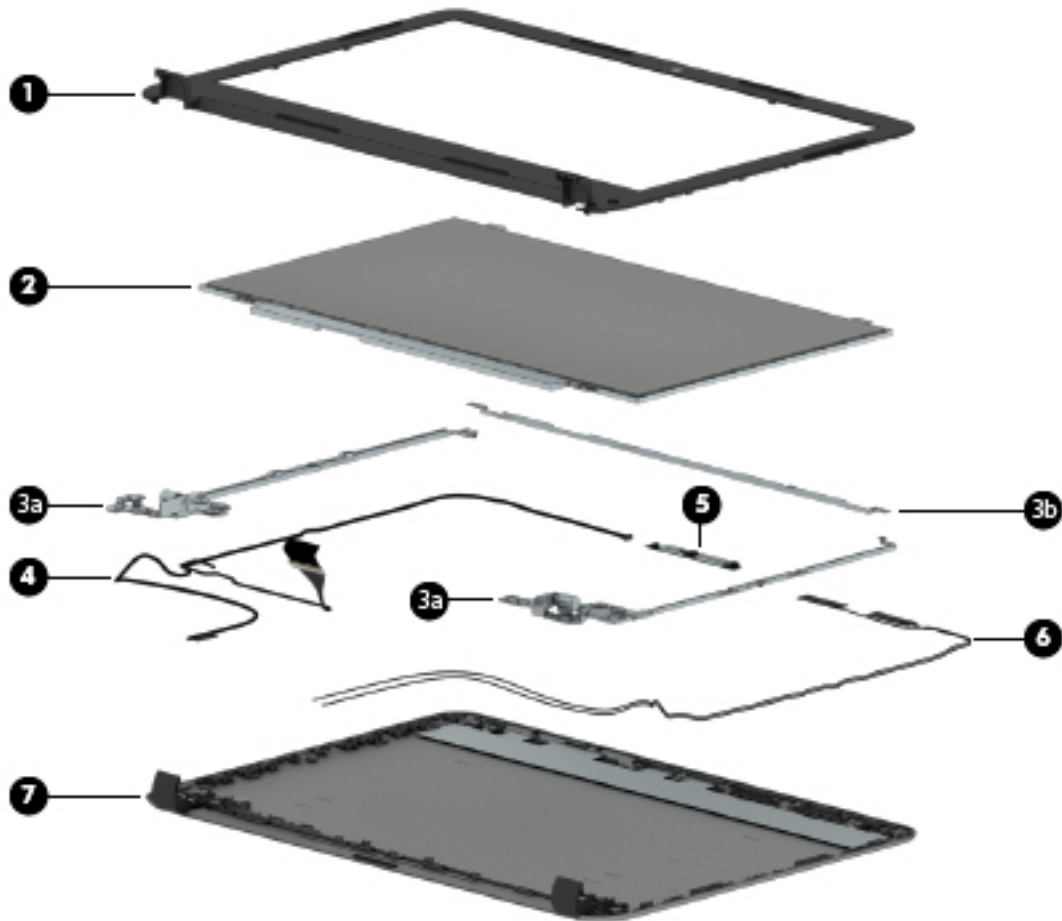

Item	Component	Spare part number
(1)	Display bezel (includes insulator screws)	858073-001
(2)	Raw display panel (35.6-cm [14.0-in], HD, WLED, BrightView; includes insulator screws)	
	For use in HP Notebook PC models:	
	• FHD	860573-001
	• HD	860574-001
	For use in HP 245 G5 Notebook PC models:	
	• HD	864838-001

Item	Component	Spare part number
	Hinges (left and right; includes insulator screws)	
(3a)	Left and right hinges	858076-001
(3b)	Top hinge	858702-001
(4)	Display cable (includes display panel cable and webcam/microphone cable)	
	For use with FHD displays (HP Notebook PC only)	858074-001
	For use with HD displays	858075-001
(5)	Webcam/microphone module (includes insulator screws)	
	VGA	860575-001
	HD	860576-001
(6)	Antenna	
	Single antenna	813485-001
	Dual antennas	859127-001
(7)	Display enclosure (includes insulator screws):	
	For use in HP Notebook PC models:	
	<ul style="list-style-type: none"> • Black models 	858065-001
	<ul style="list-style-type: none"> • Red models 	858068-001
	<ul style="list-style-type: none"> • White silver models 	858067-001
	<ul style="list-style-type: none"> • Turbo silver models 	858066-001
	<ul style="list-style-type: none"> • Blue models 	858070-001
	For use in HP 245 G5 Notebook PC models	860456-001

Mass storage devices

Component	Spare part number
eMMC drive , includes eMMC board, bracket, cable, foam, and screws	
64 GB	903803-001
32 GB	861964-001
Hard drive , SATA; does not include bracket or cable):	
1-TB, 5400-rpm, 2.5-in	778192-005
500-GB, 5400-rpm, 7-mm	778186-005
500-GB, 5400-rpm, hybrid 8 GB SSD, 7-mm	732000-005
Hard drive bracket	859126-001
Hard drive connector	815139-001

4 Removal and replacement procedures preliminary requirements

Tools required

You will need the following tools to complete the removal and replacement procedures:

- Flat-bladed screwdriver
- Magnetic screwdriver
- Phillips P0 and P1 screwdrivers

Service considerations

The following sections include some of the considerations that you must keep in mind during disassembly and assembly procedures.

 **NOTE:** As you remove each subassembly from the computer, place the subassembly (and all accompanying screws) away from the work area to prevent damage.

Plastic parts

 **CAUTION:** Using excessive force during disassembly and reassembly can damage plastic parts. Use care when handling the plastic parts. Apply pressure only at the points designated in the maintenance instructions.

Cables and connectors

 **CAUTION:** When servicing the computer, be sure that cables are placed in their proper locations during the reassembly process. Improper cable placement can damage the computer.

Cables must be handled with extreme care to avoid damage. Apply only the tension required to unseat or seat the cables during removal and insertion. Handle cables by the connector whenever possible. In all cases, avoid bending, twisting, or tearing cables. Be sure that cables are routed in such a way that they cannot be caught or snagged by parts being removed or replaced. Handle flex cables with extreme care; these cables tear easily.

Drive handling

⚠ CAUTION: Drives are fragile components that must be handled with care. To prevent damage to the computer, damage to a drive, or loss of information, observe these precautions:

Before removing or inserting a hard drive, shut down the computer. If you are unsure whether the computer is off or in Hibernation, turn the computer on, and then shut it down through the operating system.

Before handling a drive, be sure that you are discharged of static electricity. While handling a drive, avoid touching the connector.

Before removing a diskette drive or optical drive, be sure that a diskette or disc is not in the drive and be sure that the optical drive tray is closed.

Handle drives on surfaces covered with at least one inch of shock-proof foam.

Avoid dropping drives from any height onto any surface.

After removing a hard drive, an optical drive, or a diskette drive, place it in a static-proof bag.

Avoid exposing an internal hard drive to products that have magnetic fields, such as monitors or speakers.

Avoid exposing a drive to temperature extremes or liquids.

If a drive must be mailed, place the drive in a bubble pack mailer or other suitable form of protective packaging and label the package "FRAGILE."

Grounding guidelines

Electrostatic discharge damage

Electronic components are sensitive to electrostatic discharge (ESD). Circuitry design and structure determine the degree of sensitivity. Networks built into many integrated circuits provide some protection, but in many cases, ESD contains enough power to alter device parameters or melt silicon junctions.

A discharge of static electricity from a finger or other conductor can destroy static-sensitive devices or microcircuitry. Even if the spark is neither felt nor heard, damage may have occurred.

An electronic device exposed to ESD may not be affected at all and can work perfectly throughout a normal cycle. Or the device may function normally for a while, then degrade in the internal layers, reducing its life expectancy.

⚠ CAUTION: To prevent damage to the computer when you are removing or installing internal components, observe these precautions:

Keep components in their electrostatic-safe containers until you are ready to install them.

Before touching an electronic component, discharge static electricity by using the guidelines described in this section.

Avoid touching pins, leads, and circuitry. Handle electronic components as little as possible.

If you remove a component, place it in an electrostatic-safe container.

The following table shows how humidity affects the electrostatic voltage levels generated by different activities.

⚠ CAUTION: A product can be degraded by as little as 700 V.

Typical electrostatic voltage levels			
Event	Relative humidity		
	10%	40%	55%
Walking across carpet	35,000 V	15,000 V	7,500 V
Walking across vinyl floor	12,000 V	5,000 V	3,000 V
Motions of bench worker	6,000 V	800 V	400 V
Removing DIPs from plastic tube	2,000 V	700 V	400 V
Removing DIPs from vinyl tray	11,500 V	4,000 V	2,000 V
Removing DIPs from Styrofoam	14,500 V	5,000 V	3,500 V
Removing bubble pack from PCB	26,500 V	20,000 V	7,000 V
Packing PCBs in foam-lined box	21,000 V	11,000 V	5,000 V

Packaging and transporting guidelines

Follow these grounding guidelines when packaging and transporting equipment:

- To avoid hand contact, transport products in static-safe tubes, bags, or boxes.
- Protect ESD-sensitive parts and assemblies with conductive or approved containers or packaging.
- Keep ESD-sensitive parts in their containers until the parts arrive at static-free workstations.
- Place items on a grounded surface before removing items from their containers.
- Always be properly grounded when touching a component or assembly.
- Store reusable ESD-sensitive parts from assemblies in protective packaging or non-conductive foam.
- Use transporters and conveyors made of antistatic belts and roller bushings. Be sure that mechanized equipment used for moving materials is wired to ground and that proper materials are selected to avoid static charging. When grounding is not possible, use an ionizer to dissipate electric charges.

Workstation guidelines

Follow these grounding workstation guidelines:

- Cover the workstation with approved static-shielding material.
- Use a wrist strap connected to a properly grounded work surface and use properly grounded tools and equipment.
- Use conductive field service tools, such as cutters, screwdrivers, and vacuums.
- When fixtures must directly contact dissipative surfaces, use fixtures made only of static-safe materials.
- Keep the work area free of nonconductive materials, such as ordinary plastic assembly aids and Styrofoam.
- Handle ESD-sensitive components, parts, and assemblies by the case or PCM laminate. Handle these items only at static-free workstations.
- Avoid contact with pins, leads, or circuitry.
- Turn off power and input signals before inserting or removing connectors or test equipment.

Equipment guidelines

Grounding equipment must include either a wrist strap or a foot strap at a grounded workstation.

- When seated, wear a wrist strap connected to a grounded system. Wrist straps are flexible straps with a minimum of one megohm $\pm 10\%$ resistance in the ground cords. To provide proper ground, wear a strap snugly against the skin at all times. On grounded mats with banana-plug connectors, use alligator clips to connect a wrist strap.
- When standing, use foot straps and a grounded floor mat. Foot straps (heel, toe, or boot straps) can be used at standing workstations and are compatible with most types of shoes or boots. On conductive floors or dissipative floor mats, use foot straps on both feet with a minimum of one megohm resistance between the operator and ground. To be effective, the conductive must be worn in contact with the skin.

The following grounding equipment is recommended to prevent electrostatic damage:

- Antistatic tape
- Antistatic smocks, aprons, and sleeve protectors
- Conductive bins and other assembly or soldering aids
- Nonconductive foam
- Conductive tabletop workstations with ground cords of one megohm resistance
- Static-dissipative tables or floor mats with hard ties to the ground
- Field service kits
- Static awareness labels
- Material-handling packages
- Nonconductive plastic bags, tubes, or boxes
- Metal tote boxes
- Electrostatic voltage levels and protective materials

The following table lists the shielding protection provided by antistatic bags and floor mats.

Material	Use	Voltage protection level
Antistatic plastics	Bags	1,500 V
Carbon-loaded plastic	Floor mats	7,500 V
Metallized laminate	Floor mats	5,000 V

5 Removal and replacement procedures for Customer Self-Repair parts

 **CAUTION:** The Customer Self-Repair program is not available in all locations. Installing a part not supported by the Customer Self-Repair program may void your warranty. Check your warranty to determine if Customer Self-Repair is supported in your location.

 **NOTE:** HP continually improves and changes product parts. For complete and current information on supported parts for your computer, go to <http://partsurfer.hp.com>, select your country or region, and then follow the on-screen instructions.

Component replacement procedures

 **NOTE:** Please read and follow the procedures described here to access and replace Customer Self-Repair parts successfully.

 **NOTE:** Details about your computer, including model, serial number, product key, and length of warranty, are on the service tag at the bottom of your computer. See [Service tag on page 13](#) for details.

This chapter provides removal and replacement procedures for Customer Self-Repair parts.

Battery

Description	Spare part number
6-cell, 47-Whr, 2.2-Ah Li-ion battery (for use only in HP 245 G5 Notebook PC models)	844198-850
4-cell, 41-Whr, 2.8-Ah Li-ion battery (for use in all models)	807957-001
3-cell, 31-Whr, 2.8-Ah Li-ion battery (for use in all models)	807956-001

Before disassembling the computer, follow these steps:

1. Shut down the computer. If you are unsure whether the computer is off or in Hibernation, turn the computer on, and then shut it down through the operating system.
2. Disconnect all external devices connected to the computer.
3. Disconnect the power from the computer by first unplugging the power cord from the AC outlet and then unplugging the AC adapter from the computer.

To remove the battery:

1. Position the computer upside down on a flat surface.
2. Slide the battery lock latch **(1)** to unlock the battery, and then slide the battery release latch **(2)** to release the battery.



NOTE: The battery release latch automatically returns to its original position.

3. Remove the battery **(3)** from the computer.

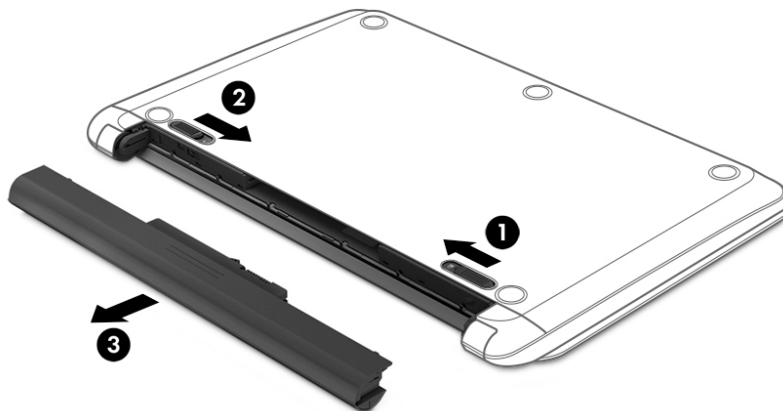

Optical drive



NOTE: Optical drive spare part kits include bracket and bezel.

Description	Spare part number
DVD+/-RW Double-Layer SuperMulti Drive (includes bracket and bezel) for use in HP Notebook PC models	863675-001
DVD+/-RW Double-Layer SuperMulti Drive (includes bracket and bezel) for use in HP 245 G5 Notebook PC models	813514-001 906505-001

Before removing the optical drive, follow these steps:

1. Shut down the computer. If you are unsure whether the computer is off or in Hibernation, turn the computer on, and then shut it down through the operating system.
2. Disconnect all external devices connected to the computer.
3. Disconnect the power from the computer by first unplugging the power cord from the AC outlet and then unplugging the AC adapter from the computer.
4. Remove the battery (see [Battery on page 26](#)).

To remove the optical drive:

1. Remove the Phillips PM2.5×6.0 screw **(1)** that secures the optical drive to the computer.
2. Remove the optical drive **(2)** by sliding it out of the optical drive bay.

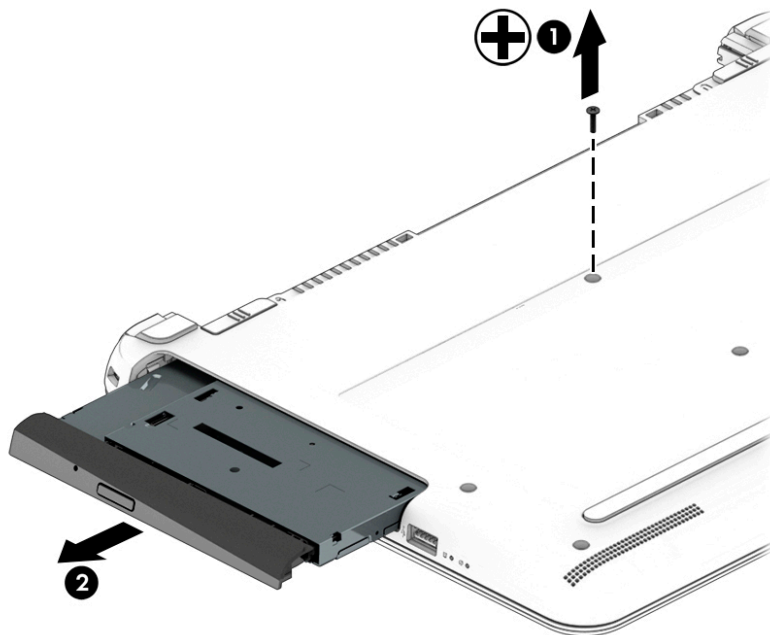

Reverse this procedure to reassemble and install the optical drive.

6 Removal and replacement procedures for Authorized Service Provider parts

 **CAUTION:** Components described in this chapter should only be accessed by an authorized service provider. Accessing these parts can damage the computer or void the warranty.

 **NOTE:** HP continually improves and changes product parts. For complete and current information on supported parts for your computer, go to <http://partsurfer.hp.com>, select your country or region, and then follow the on-screen instructions.

Component replacement procedures

 **NOTE:** Details about your computer, including model, serial number, product key, and length of warranty, are on the service tag at the bottom of your computer. See [Service tag on page 13](#) for details.

This chapter provides removal and replacement procedures for Authorized Service Provider only parts.

There are as many as 60 screws that must be removed, replaced, or loosened when servicing Authorized Service Provider only parts. Make special note of each screw size and location during removal and replacement.

Bottom cover

Description	Spare part number
Bottom cover for use in HP Notebook PC models with an optical drive	858071-001
Bottom cover for use in HP Notebook PC models without an optical drive	858072-001
Bottom cover for use in HP 245 G5 Notebook PC models with an optical drive	860455-001
Bottom cover for use in HP 245 G5 Notebook PC models without an optical drive	860471-001

Before removing the bottom cover, follow these steps:

1. Shut down the computer. If you are unsure whether the computer is off or in Hibernation, turn the computer on, and then shut it down through the operating system.
2. Disconnect all external devices connected to the computer.
3. Disconnect the power from the computer by first unplugging the power cord from the AC outlet and then unplugging the AC adapter from the computer.
4. Remove the battery (see [Battery on page 26](#)).
5. Remove the optical drive (see [Optical drive on page 27](#)).

To remove the bottom cover:

1. Position the computer upside down with the front toward you.
2. Remove the two rubber feet from rear of the bottom of the computer **(1)**
3. Remove the 11 Phillips PM2.5×6.0 screws **(2)** from the bottom of the computer.
4. Remove the 2 Phillips PM2.0×2.0 screws **(3)** from the optical drive bay.

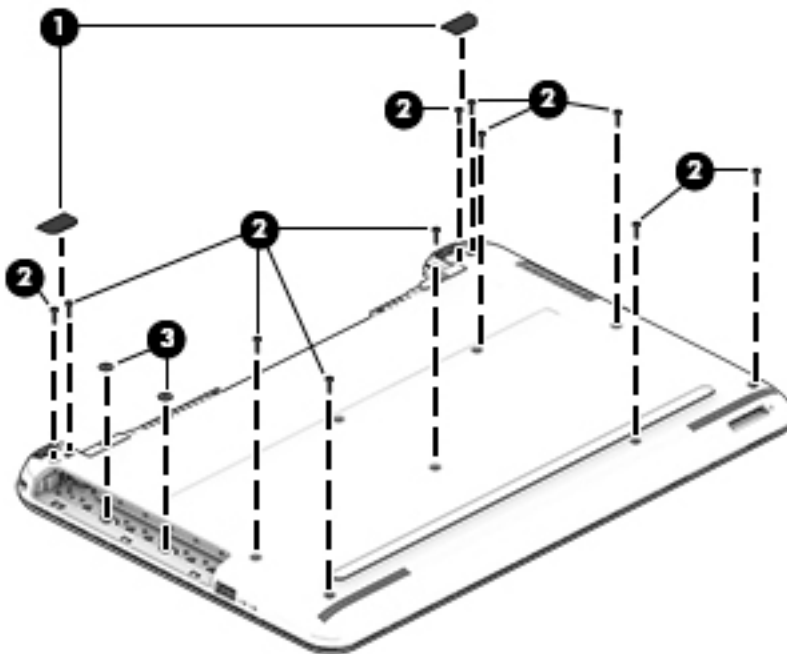

5. Start prying near the optical drive bay and work around to the back and side to separate the bottom cover from the computer **(1)**.
6. Remove the bottom cover **(2)**.

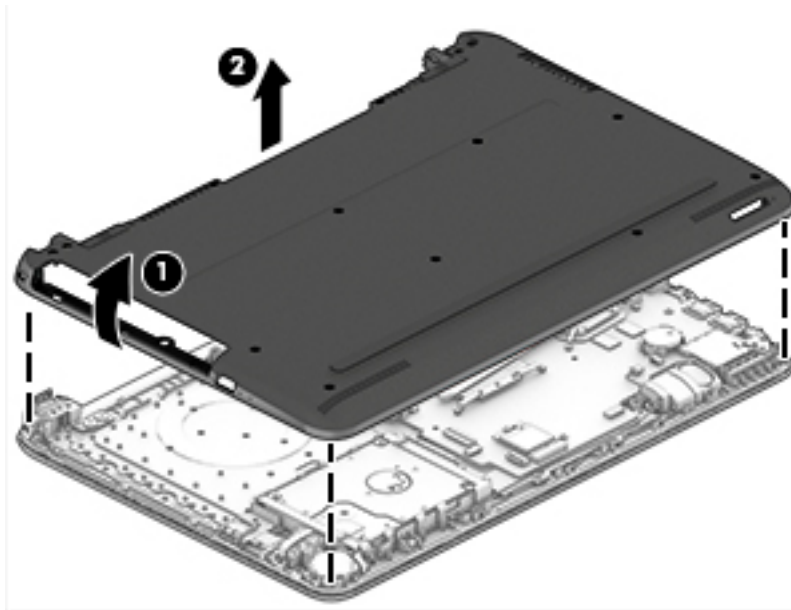

Reverse this procedure to install the bottom cover.

Hard drive



NOTE: The hard drive spare part kit does not include the hard drive bracket or cable.

Description	Spare part number
Hard drive	
1-TB, 5400-rpm, 2.5-in	778192-005
500-GB, 5400-rpm, 7-mm	778186-005
500-GB, hybrid 8 GB SSD, 5400-rpm, 7-mm	732000-005
Hard drive bracket	859126-001
Hard drive connector	815139-001

Before removing the hard drive, follow these steps:

1. Shut down the computer. If you are unsure whether the computer is off or in Hibernation, turn the computer on, and then shut it down through the operating system.
2. Disconnect all external devices connected to the computer.
3. Disconnect the power from the computer by first unplugging the power cord from the AC outlet and then unplugging the AC adapter from the computer.
4. Remove the battery (see [Battery on page 26](#)).
5. Remove the optical drive (see [Optical drive on page 27](#)).
6. Remove the bottom cover (see [Bottom cover on page 30](#)).

To remove the hard drive:

1. Disconnect the hard drive cable from the system board **(1)**.
2. Lift the hard drive assembly from the computer **(2)**.

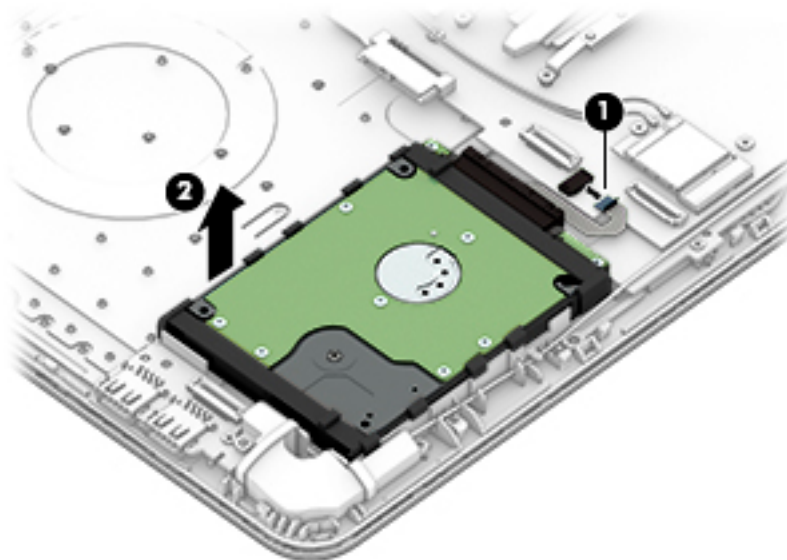

3. To disassemble the hard drive, pull the connector away from the drive to remove it **(1)**.

4. Flex the sides of the bracket **(2)**, and then remove it from the hard drive **(3)**.

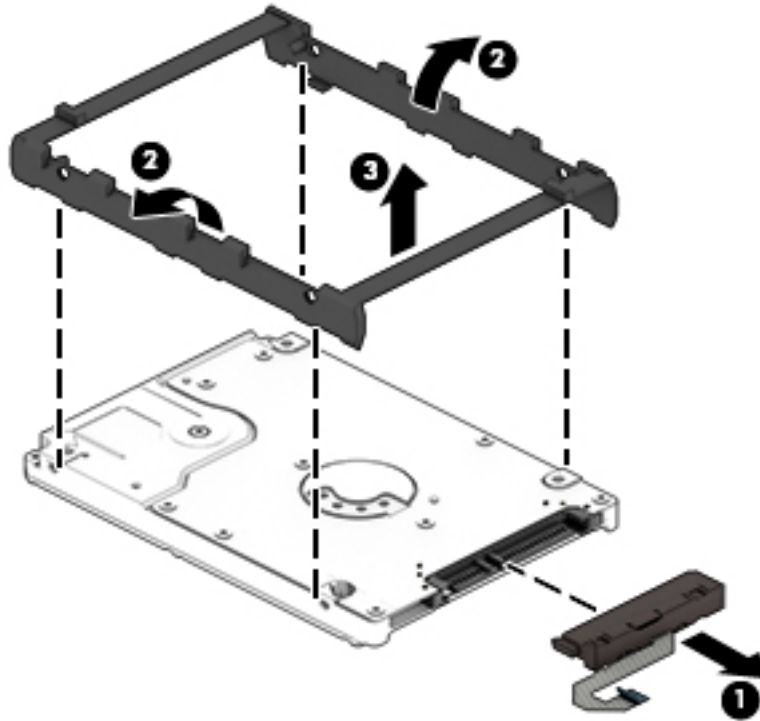

Reverse this procedure to reassemble and install the hard drive.

eMMC module

Description	Spare part number
eMMC drive, 64 GB, M.2 (includes eMMC board, bracket, cable, foam, and screws)	903803-001
eMMC drive, 32 GB, M.2 (includes eMMC board, bracket, cable, foam, and screws)	861964-001

Before removing the eMMC module, follow these steps:

1. Shut down the computer. If you are unsure whether the computer is off or in Hibernation, turn the computer on, and then shut it down through the operating system.
2. Disconnect all external devices connected to the computer.
3. Disconnect the power from the computer by first unplugging the power cord from the AC outlet and then unplugging the AC adapter from the computer.
4. Remove the battery (see [Battery on page 26](#)).
5. Remove the optical drive (see [Optical drive on page 27](#)).
6. Remove the bottom cover (see [Bottom cover on page 30](#)).

To remove the eMMC module:

1. Disconnect the cable from the system board **(1)**.
2. Remove the three Phillips PM2.0×3.0 screws **(2)** that secure the module to the computer
3. Lift the module from the system board **(3)**.

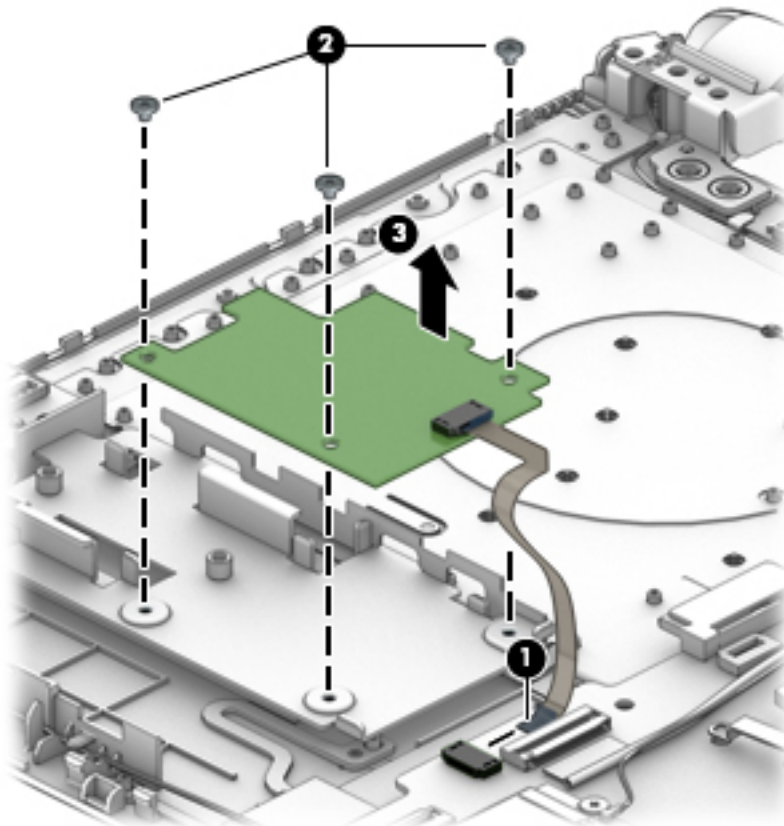

4. If you need to remove the eMMC bracket, slide the bracket toward the edge of the computer to disengage it from the clips **(1)**.
5. Lift the bracket from the computer **(2)**.

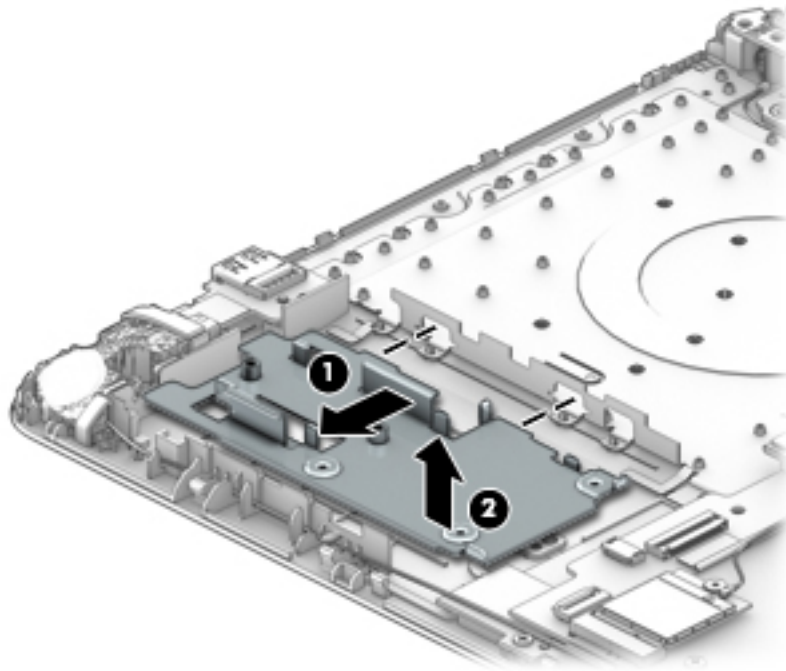

Reverse this procedure to install the eMMC module.

To install the eMMC bracket, slide the bracket onto the clips **(1)** and then rotate it downward into place **(2)**.

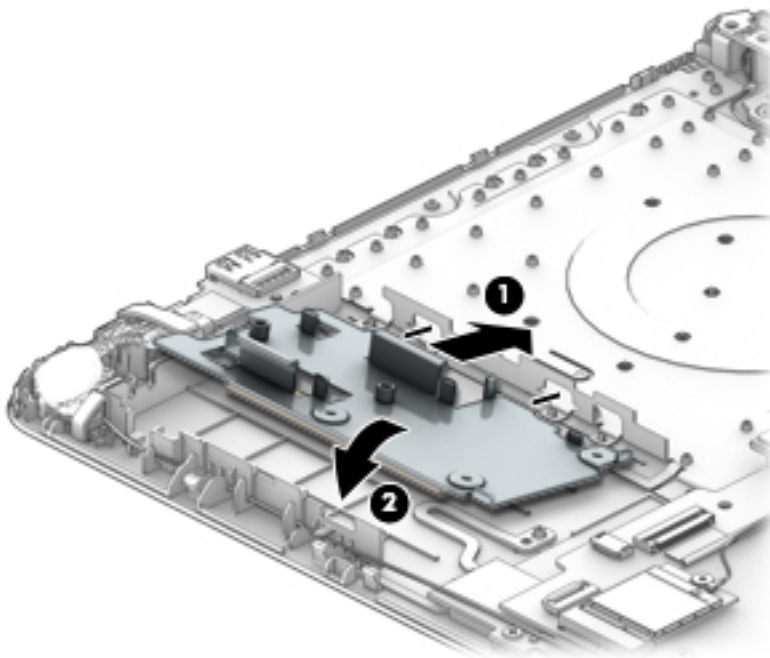

WLAN module

Description	Spare part number
Realtek RTL8723BE-VB 802.11b/g/n 1x1 Wi-Fi + BT4.0 Combo Adapter	855106-885
Intel Dual Band Wireless-AC 3165 802.11 ac 1x1 WiFi + BT 4.2 Combo	806723-005
Realtek RTL8188EE-VJ 802.11b/g/n 1x1 Wi-Fi Adapter	857334-855
Intel Dual Band Wireless-AC 3168 802.11 ac 1x1 WiFi + BT 4.2 Combo	863934-855

 **CAUTION:** To prevent an unresponsive system, replace the wireless module only with a wireless module authorized for use in the computer by the governmental agency that regulates wireless devices in your country or region. If you replace the module and then receive a warning message, remove the module to restore device functionality, and then contact support.

Before removing the WLAN module, follow these steps:

1. Shut down the computer. If you are unsure whether the computer is off or in Hibernation, turn the computer on, and then shut it down through the operating system.
2. Disconnect all external devices connected to the computer.
3. Disconnect the power from the computer by first unplugging the power cord from the AC outlet and then unplugging the AC adapter from the computer.
4. Remove the battery (see [Battery on page 26](#)).
5. Remove the optical drive (see [Optical drive on page 27](#)).
6. Remove the bottom cover (see [Bottom cover on page 30](#)).

To remove the WLAN module:

1. Disconnect the WLAN antenna cable **(1)** from the terminal on the WLAN module.

 **NOTE:** The number of antenna cables may vary.

 **NOTE:** The #1 WLAN antenna cable is connected to the WLAN module Main terminal.

If two antennas are connected, the #2 WLAN antenna cable is connected to the WLAN module Aux terminal.

2. Remove the Phillips PM2.0×3.0 screw **(2)** that secures the WLAN module to the system board. (The WLAN module tilts up.)

3. Remove the WLAN module by pulling the module away from the slot at an angle (3).

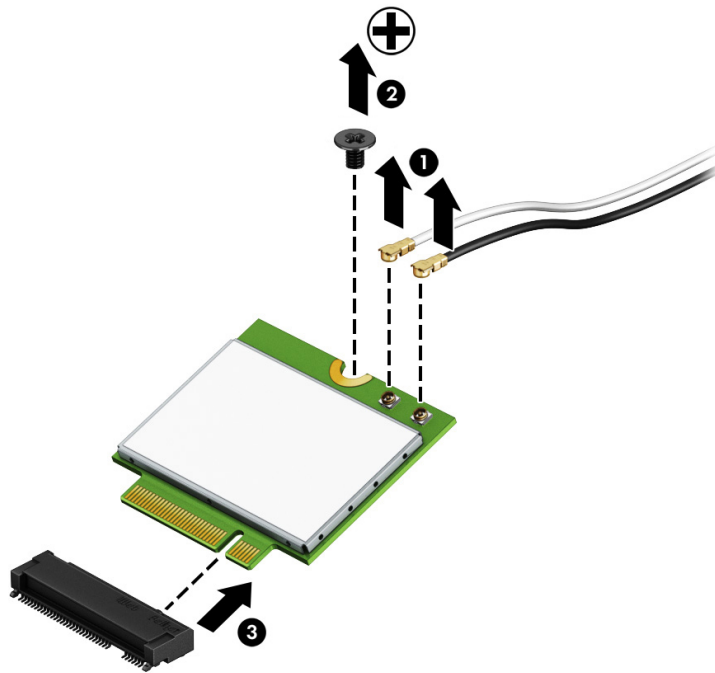

 **NOTE:** If the WLAN antennas are not connected to the terminals on the WLAN module, the protective sleeves must be installed on the antenna connectors, as shown in the following illustration.



Reverse this procedure to install the WLAN module.

Memory module

Description	Spare part number
Memory module (PC3L, 12800, 1600-MHz)	
8-GB	693374-005
4-GB	691740-005
2-GB	691739-005

Before removing a memory module, follow these steps:

1. Shut down the computer. If you are unsure whether the computer is off or in Hibernation, turn the computer on, and then shut it down through the operating system.
2. Disconnect all external devices connected to the computer.
3. Disconnect the power from the computer by first unplugging the power cord from the AC outlet and then unplugging the AC adapter from the computer.
4. Remove the battery (see [Battery on page 26](#)).
5. Remove the optical drive (see [Optical drive on page 27](#)).
6. Remove the bottom cover (see [Bottom cover on page 30](#)).

To remove a memory module:

1. Spread the retaining tabs **(1)** on each side of the memory module slot to release the memory module. (The memory module tilts up.)
2. Remove the memory module **(2)** by pulling it away from the slot at an angle.

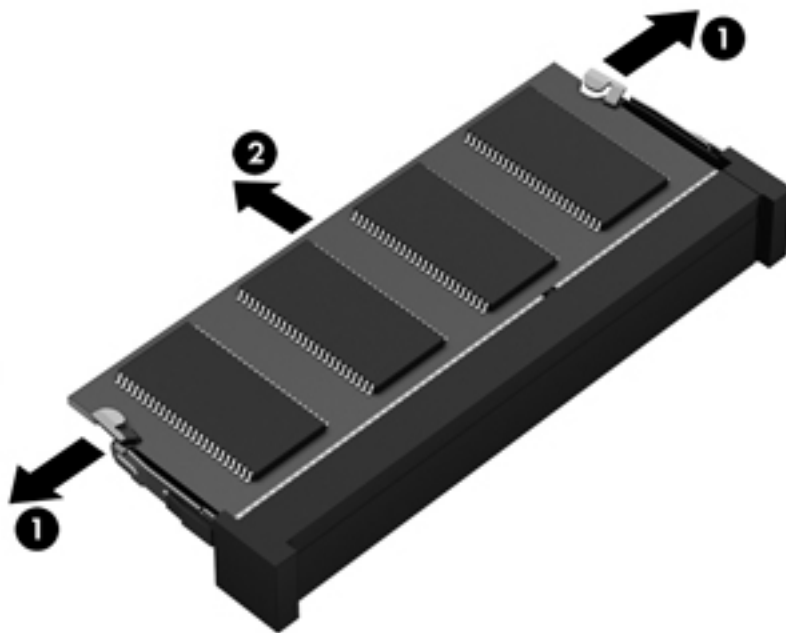

Reverse this procedure to install a memory module.

RTC battery

Description	Spare part number
RTC battery	718440-001

Before removing the RTC battery, follow these steps:

1. Shut down the computer. If you are unsure whether the computer is off or in Hibernation, turn the computer on, and then shut it down through the operating system.
2. Disconnect all external devices connected to the computer.
3. Disconnect the power from the computer by first unplugging the power cord from the AC outlet and then unplugging the AC adapter from the computer.
4. Remove the battery (see [Battery on page 26](#)).
5. Remove the optical drive (see [Optical drive on page 27](#)).
6. Remove the bottom cover (see [Bottom cover on page 30](#)).

To remove the RTC battery:

- ▲ Using a thin tool or screwdriver, disengage the battery from the socket **(1)**, and then remove the battery **(2)**.

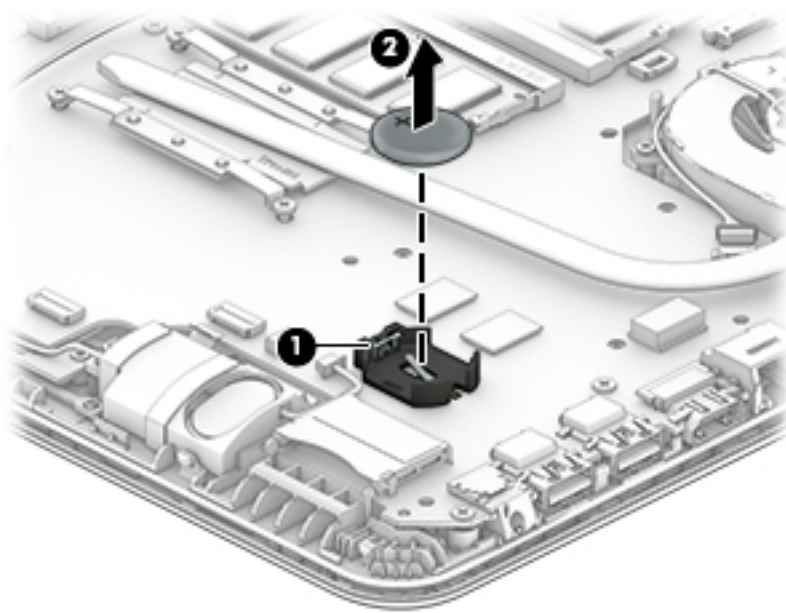

Reverse this procedure to install the RTC battery.

USB board

Description	Spare part number
USB board (includes cable)	813515-001

Before removing the USB board, follow these steps:

1. Shut down the computer. If you are unsure whether the computer is off or in Hibernation, turn the computer on, and then shut it down through the operating system.
2. Disconnect all external devices connected to the computer.
3. Disconnect the power from the computer by first unplugging the power cord from the AC outlet and then unplugging the AC adapter from the computer.
4. Remove the battery (see [Battery on page 26](#)).
5. Remove the optical drive (see [Optical drive on page 27](#)).
6. Remove the bottom cover (see [Bottom cover on page 30](#)).

To remove the USB board:

1. Disconnect the cable from the board **(1)**.
2. Lift the cable to disengage the adhesive that secures it to the computer **(2)**.
3. Remove the Phillips PM2.5×3.5 screw **(3)** that secures the USB board to the computer.
4. Lift the USB board **(4)** from the computer.

Lift the cable to disengage the adhesive that secures it to the computer **(4)**.

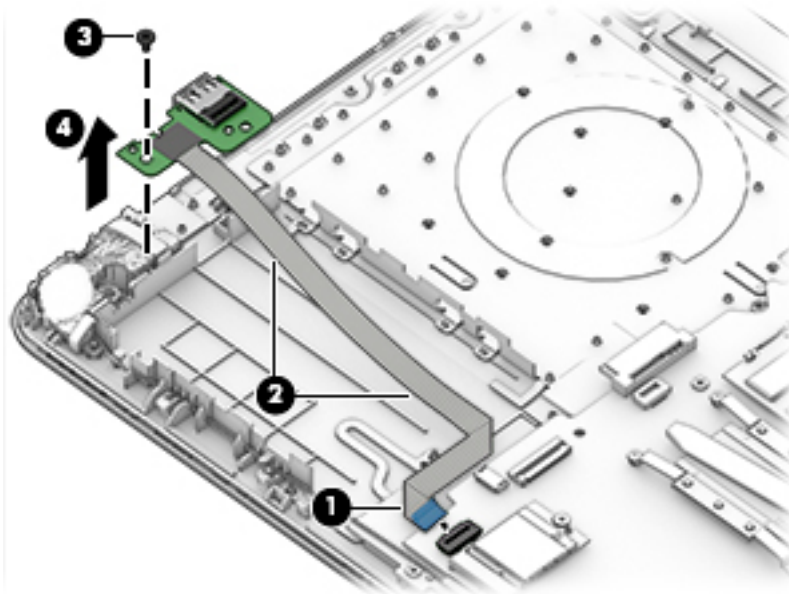

Reverse this procedure to install the USB board.

Speakers

Description	Spare part number
Speakers (left and right)	858083-001

Before removing the speakers, follow these steps:

1. Shut down the computer. If you are unsure whether the computer is off or in Hibernation, turn the computer on, and then shut it down through the operating system.
2. Disconnect all external devices connected to the computer.
3. Disconnect the power from the computer by first unplugging the power cord from the AC outlet and then unplugging the AC adapter from the computer.
4. Remove the battery (see [Battery on page 26](#)).
5. Remove the optical drive (see [Optical drive on page 27](#)).
6. Remove the bottom cover (see [Bottom cover on page 30](#)).

To remove the speakers:

1. Disconnect the speaker cable from the system board (1).
2. Remove the cable from the routing path (2), and then lift up and remove the speakers from the computer (3).

 **NOTE:** The speakers are not secured with screws.

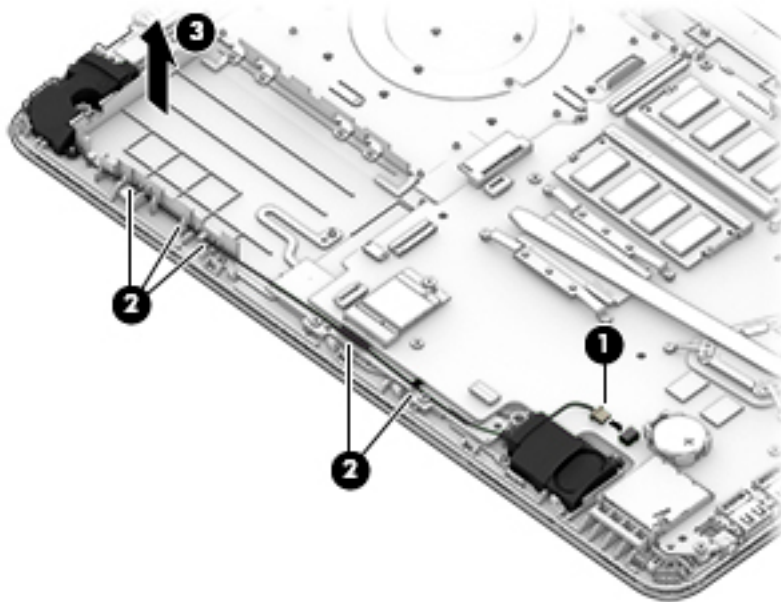

Reverse this procedure to install the speakers.

Power button board

Description	Spare part number
Power button board (includes cable)	813516-001

Before removing the power button board, follow these steps:

1. Shut down the computer. If you are unsure whether the computer is off or in Hibernation, turn the computer on, and then shut it down through the operating system.
2. Disconnect all external devices connected to the computer.
3. Disconnect the power from the computer by first unplugging the power cord from the AC outlet and then unplugging the AC adapter from the computer.
4. Remove the battery (see [Battery on page 26](#)).
5. Remove the optical drive (see [Optical drive on page 27](#)).
6. Remove the bottom cover (see [Bottom cover on page 30](#)).

To remove the power button board:

1. Disconnect the power button board cable from the system board **(1)**.
2. Remove the Phillips PM2.0×3.0 screw **(2)** that secures the power button board to the top cover.
3. Rotate the top of the board upward, and then remove the power button board and cable from the computer **(3)**.

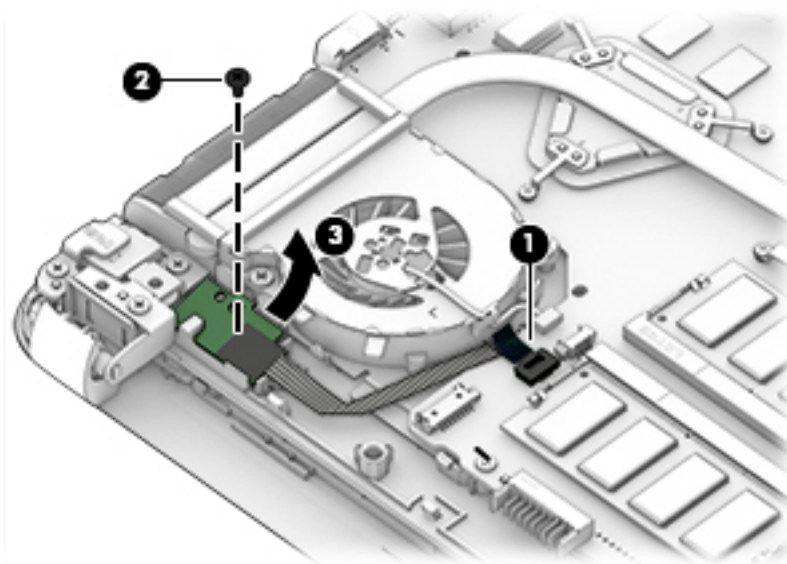

Reverse this procedure to install the power button board and cable.

Heat sink assembly



NOTE: The heat sink assembly spare part kit includes replacement thermal materials.

Description	Spare part number
Heat sink for use in models with discrete graphics memory (HP Notebook PC models only)	813508-001
Heat sink for use in models with UMA graphics memory	813507-001



NOTE: To properly ventilate the computer, allow at least **7.6 cm** (3.0 in) of clearance on the left side of the computer. The computer uses an electric fan for ventilation. The fan is controlled by a temperature sensor and is designed to turn on automatically when high temperature conditions exist. These conditions are affected by high external temperatures, system power consumption, power management/battery conservation configurations, battery fast charging, and software requirements. Exhaust air is displaced through the ventilation grill located on the left side of the computer.

Before removing the heat sink assembly, follow these steps:

1. Shut down the computer. If you are unsure whether the computer is off or in Hibernation, turn the computer on, and then shut it down through the operating system.
2. Disconnect all external devices connected to the computer.
3. Disconnect the power from the computer by first unplugging the power cord from the AC outlet and then unplugging the AC adapter from the computer.
4. Remove the battery (see [Battery on page 26](#)).
5. Remove the optical drive (see [Optical drive on page 27](#)).
6. Remove the bottom cover (see [Bottom cover on page 30](#)).

To remove the heat sink assembly:

1. Refer to the following heat sink removal image that matches your computer.
2. On models with discrete graphics, remove the seven Phillips PM2.0×3.0 screws **(1)** on the heat sink that secure the heat sink assembly to the system board.

3. Remove the heat sink assembly from the system board **(2)**.

 **NOTE:** Heat sink appearance may vary.

Discrete graphics

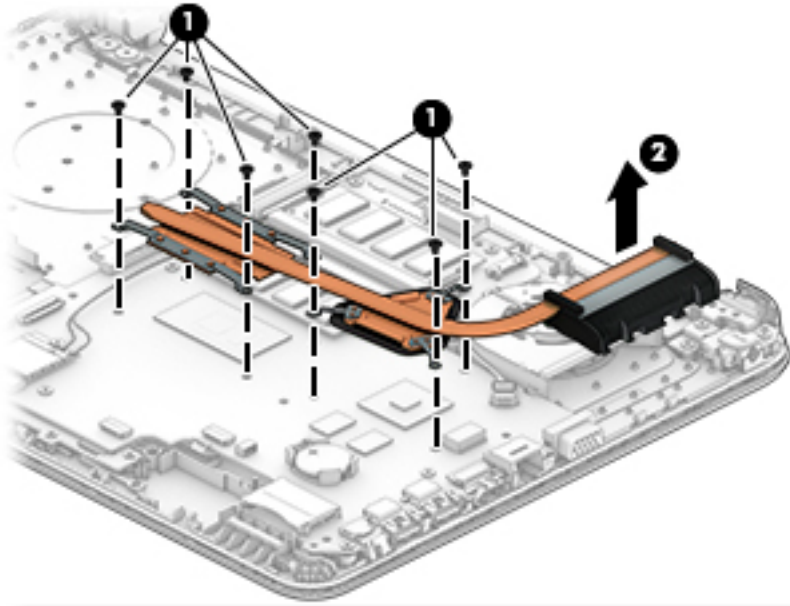

4. On models with UMA graphics, remove the four Phillips PM2.0×3.0 screws **(1)** on the heat sink that secure the heat sink assembly to the system board.
5. Remove the heat sink assembly from the system board **(2)**.

 **NOTE:** Heat sink appearance may vary.

UMA graphics

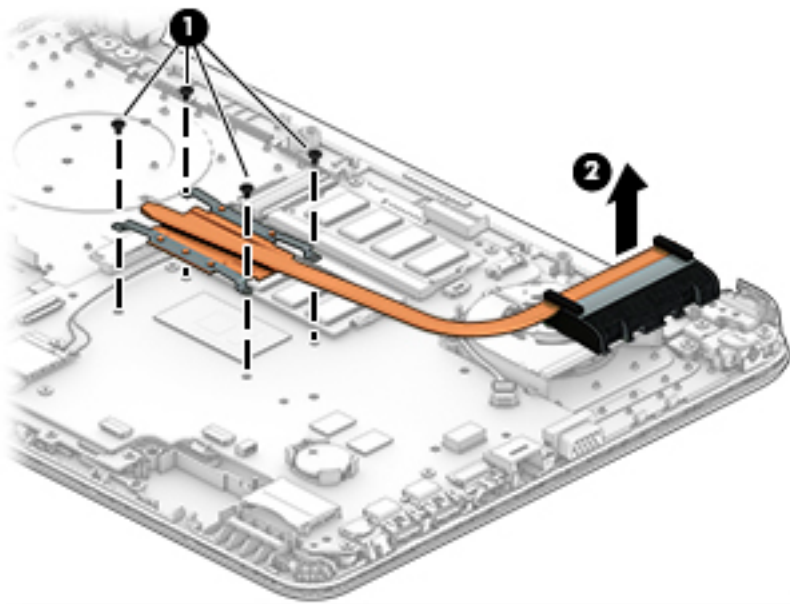

Thermal paste is used on the processor and associated heat sink areas as shown in the following images:

- **Discrete graphics** Heat sink **(1)** and processor **(2)**, as well as the heat sink **(3)** and graphics chip **(4)**.

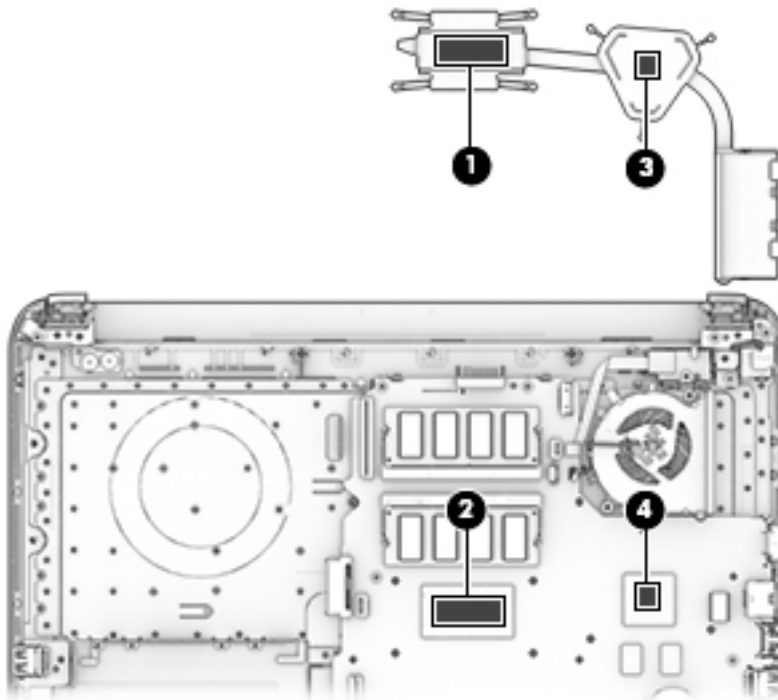

- **UMA graphics Heat sink (1) and the processor (2).**

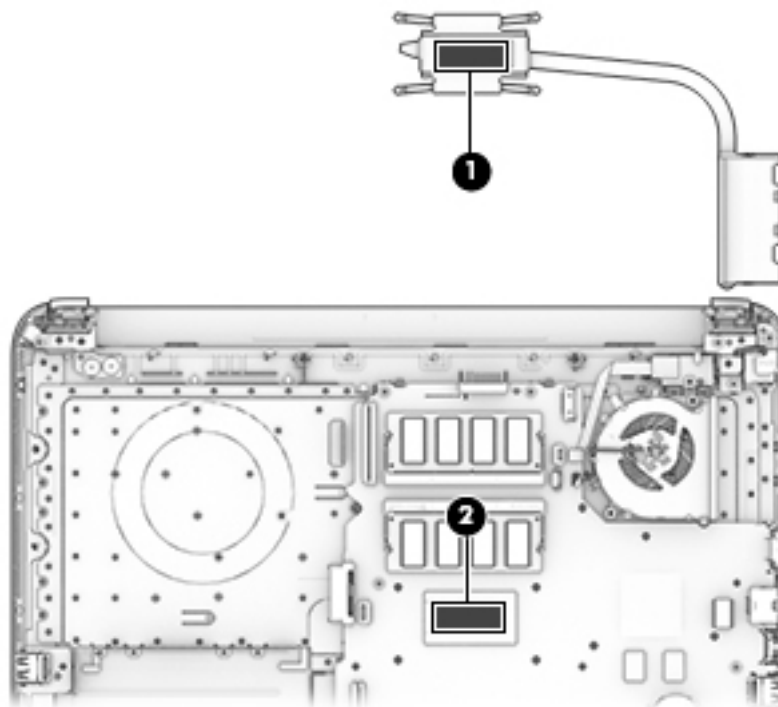

Reverse this procedure to reassemble and install the heat sink assembly.

Fan

Description	Spare part number
Fan	813506-001



NOTE: To properly ventilate the computer, allow at least **7.6 cm** (3.0 in) of clearance on the left side of the computer. The computer uses an electric fan for ventilation. The fan is controlled by a temperature sensor and is designed to turn on automatically when high temperature conditions exist. These conditions are affected by high external temperatures, system power consumption, power management/battery conservation configurations, battery fast charging, and software requirements. Exhaust air is displaced through the ventilation grill located on the left side of the computer.

Before removing the fan/heat sink assembly, follow these steps:

1. Shut down the computer. If you are unsure whether the computer is off or in Hibernation, turn the computer on, and then shut it down through the operating system.
2. Disconnect all external devices connected to the computer.
3. Disconnect the power from the computer by first unplugging the power cord from the AC outlet and then unplugging the AC adapter from the computer.
4. Remove the battery (see [Battery on page 26](#)).
5. Remove the optical drive (see [Optical drive on page 27](#)).
6. Remove the bottom cover (see [Bottom cover on page 30](#)).

To remove the fan:

1. Remove the power connector cable from the clips in the fan **(1)**.
2. Remove the black and silver tape that secures the display cable to the fan **(2)**.
3. Disconnect the fan cable **(3)** from the system board.
4. Remove the two Phillips PM2.0×4.0 screws **(4)** that secure the fan to the computer.

5. Remove the fan from the computer (5).

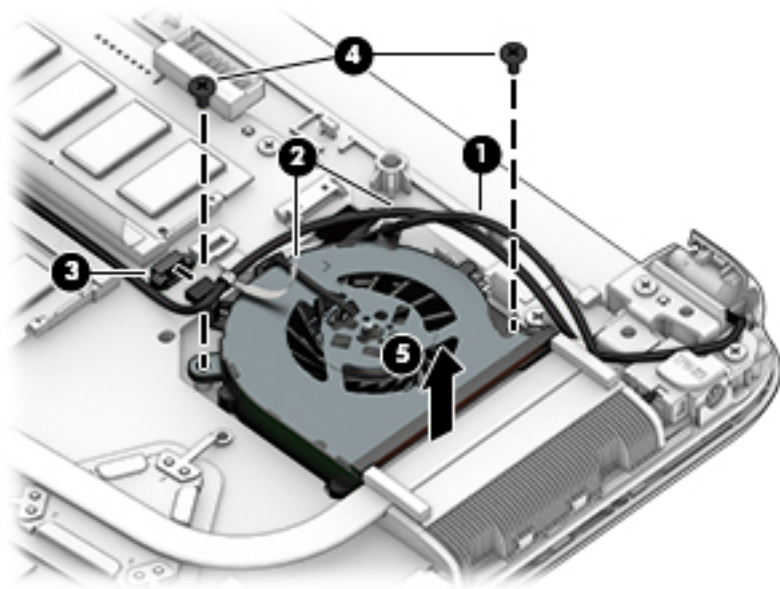

Reverse this procedure to install the fan.

System board



NOTE: The system board spare part kit includes replacement thermal materials.

Description	Spare part number
System board (includes replacement thermal materials)	
All system boards use the following part numbers:	
xxxxxx-001: Windows 7 or non-Windows operating systems	
xxxxxx-601: Windows 10 operating system	
HP Notebook PC models with discrete graphics memory:	
<ul style="list-style-type: none">AMD A8-7410 processor	858046-xx1
<ul style="list-style-type: none">AMD A6-7310 processor	858045-xx1
HP Notebook PC models with UMA graphics memory	
<ul style="list-style-type: none">AMD A8-7410 processor	858044-xx1
<ul style="list-style-type: none">AMD A6-7310 processor	858043-xx1
<ul style="list-style-type: none">AMD A4-7210 processor	858042-xx1
<ul style="list-style-type: none">AMD E2-7110 processor	858047-xx1
<ul style="list-style-type: none">AMD E2-7110 processor and 2 GB on-board system memory	858048-xx1
<ul style="list-style-type: none">AMD E2-7110 processor, 2 GB on-board system memory, and a 32 GB eMMC drive	858049-xx1
HP 245 G5 models:	
<ul style="list-style-type: none">AMD A8-7410 processor	907163-xx1
<ul style="list-style-type: none">AMD A6-7310 processor	860452-xx1
<ul style="list-style-type: none">AMD A4-3350B processor	907162-xx1
<ul style="list-style-type: none">AMD E2-7110 processor	860451-xx1

Before removing the system board, follow these steps:

1. Shut down the computer. If you are unsure whether the computer is off or in Hibernation, turn the computer on, and then shut it down through the operating system.
2. Disconnect all external devices connected to the computer.
3. Disconnect the power from the computer by first unplugging the power cord from the AC outlet and then unplugging the AC adapter from the computer.
4. Remove the battery (see [Battery on page 26](#)).
5. Remove the optical drive (see [Optical drive on page 27](#)).
6. Remove the bottom cover (see [Bottom cover on page 30](#)).
7. Remove the hard drive (see [Hard drive on page 32](#)).
8. Remove the eMMC module (see [eMMC module on page 34](#)).

 **NOTE:** When replacing the system board, be sure that the following components are removed from the defective system board and installed on the replacement system board:

- WLAN module (see [WLAN module on page 36](#))
- Memory module (see [Memory module on page 38](#))

To remove the system board:

- 1.** Remove the display cables by lifting the black and silver tape that secures the cable to the fan **(1)**.
- 2.** Lift the tape that covers the cable in the space between the two memory modules **(2)**.
- 3.** Lift the pieces of tape along the side of the system board **(3)**.
- 4.** Separate the antenna cable from the display cable **(4)**.
- 5.** Disconnect the display cable from the system board **(5)**, and then remove the cables from their remaining routing paths.

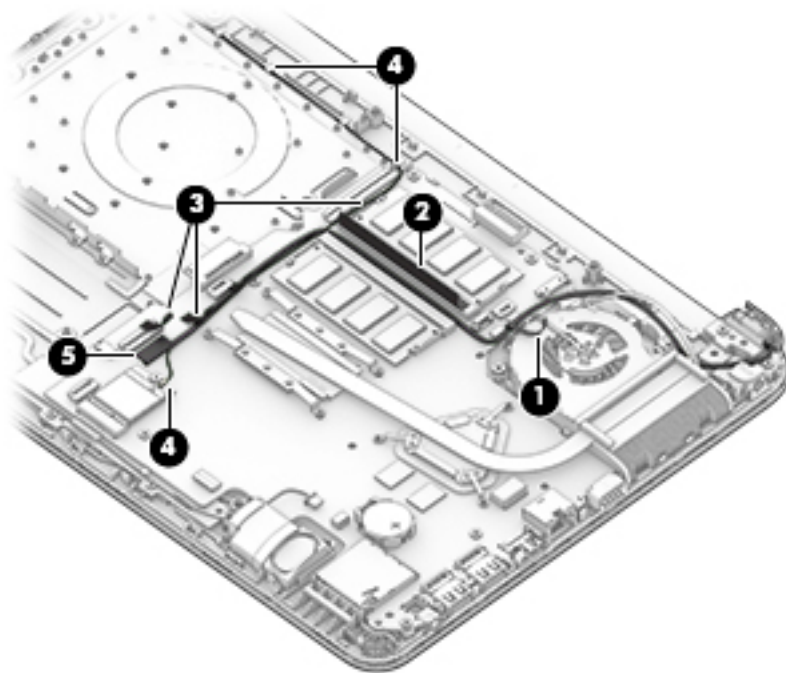

6. Position the computer upright, and then disconnect the following cables from the system board:
 - (1): Keyboard cable
 - (2): Hard drive cable
 - (3): USB board cable
 - (4): TouchPad button board cable
 - (5): Speaker cable
 - (6): Fan cable
 - (7): Power button board cable
 - (8): Power connector cable

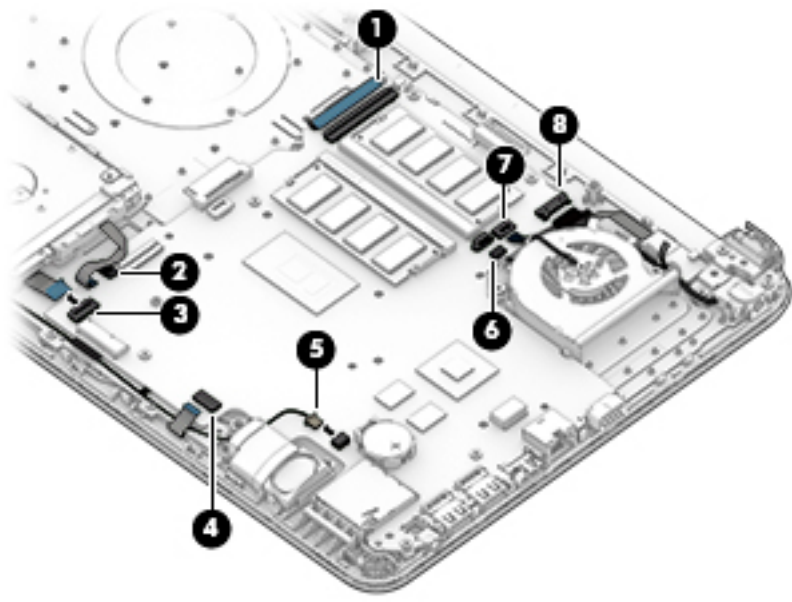

7. Remove the Phillips PM2.0×3.0 screw (1) that secures the system board to the computer.
8. Remove the five Phillips PM2.5×3.5 screws (2) that secure the system board to the computer.

9. Lift the system board out of the computer (3).

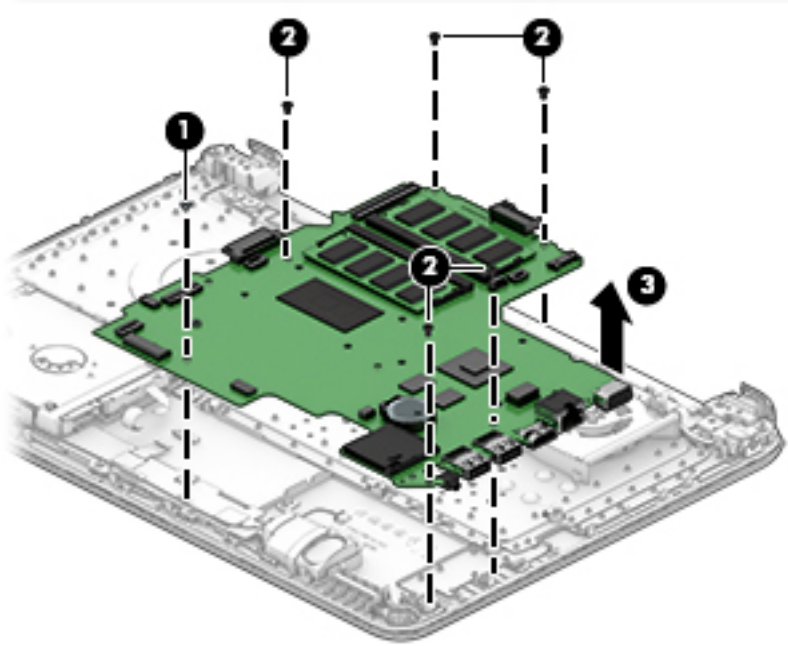

Reverse this procedure to install the system board.

TouchPad button board

Description	Spare part number
TouchPad button board (includes cable)	813517-001

Before removing the TouchPad button board, follow these steps:

1. Shut down the computer. If you are unsure whether the computer is off or in Hibernation, turn the computer on, and then shut it down through the operating system.
2. Disconnect all external devices connected to the computer.
3. Disconnect the power from the computer by first unplugging the power cord from the AC outlet and then unplugging the AC adapter from the computer.
4. Remove the battery (see [Battery on page 26](#)).
5. Remove the optical drive (see [Optical drive on page 27](#)).
6. Remove the bottom cover (see [Bottom cover on page 30](#)).
7. Remove the system board (see [System board on page 48](#)).

To remove the TouchPad button board:

1. Disconnect the cable from the TouchPad **(1)**.
2. Remove the three Phillips PM2.0×3.0 screws **(2)** that secure the TouchPad button board to the computer.
3. Remove the TouchPad button board and cable **(3)**.

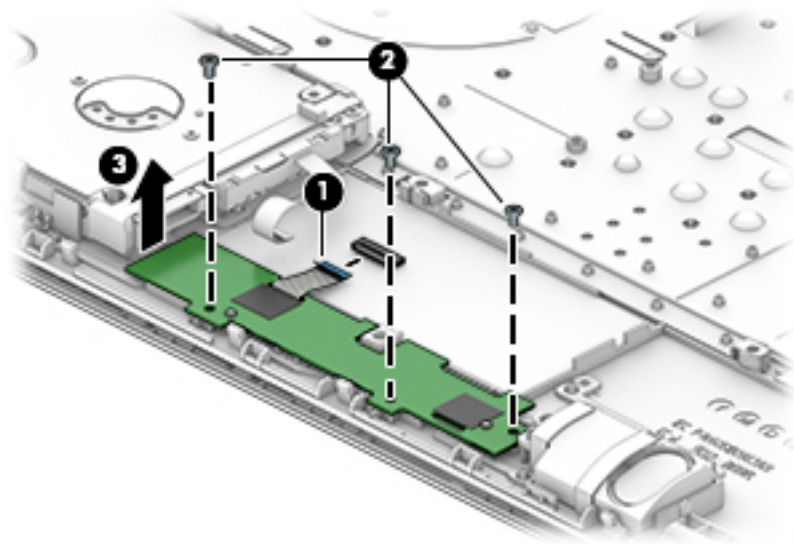

Reverse this procedure to install the TouchPad button board and cables.

Display assembly

This section describes removing the display assembly and disassembling display subcomponents.

Description	Spare part number
Raw display panel for use in HP Notebook PC models (includes insulator screws)	
FHD	860573-001
HD	860574-001
Raw display panel for use in HP 245 G5 Notebook PC models (includes insulator screws)	864838-001
Antenna (includes insulator screws)	
Single antenna	813485-001
Dual antennas	859127-001
Display bezel (includes insulator screws)	858073-001
Display cable (includes display panel cable and webcam/microphone cable; includes insulator screws)	
For use with FHD displays (HP Notebook PC only)	858074-001
For use with HD displays	858075-001
Display enclosure for use in HP Notebook PC models (includes insulator screws)	
Black models	858065-001
Red models	858068-001
White silver models	858067-001
Turbo silver models	858066-001
Blue models	858070-001
Display enclosure for use in HP 245 G5 Notebook PC models (includes insulator screws)	860456-001
Hinges (left and right) (includes insulator screws)	858076-001
Hinge (top)	858702-001
Webcam/microphone module (includes insulator screws)	
VGA	860575-001
HD	860576-001

Before removing the display assembly, follow these steps:

1. Shut down the computer. If you are unsure whether the computer is off or in Hibernation, turn the computer on, and then shut it down through the operating system.
2. Disconnect all external devices connected to the computer.
3. Disconnect the power from the computer by first unplugging the power cord from the AC outlet and then unplugging the AC adapter from the computer.
4. Remove the battery (see [Battery on page 26](#)).

5. Remove the optical drive (see [Optical drive on page 27](#)).
6. Remove the bottom cover (see [Bottom cover on page 30](#)).

To remove the display assembly:

1. Remove the three Phillips PM2.5×6.0 screws **(1)**, two Phillips broadhead PM2.0×2.0 screws **(2)** (on the right hinge), and one Phillips PM2.5×4.0 screw **(3)** (on the left hinge) that secures the display assembly to the computer.
2. Lift the display from the computer **(4)**.

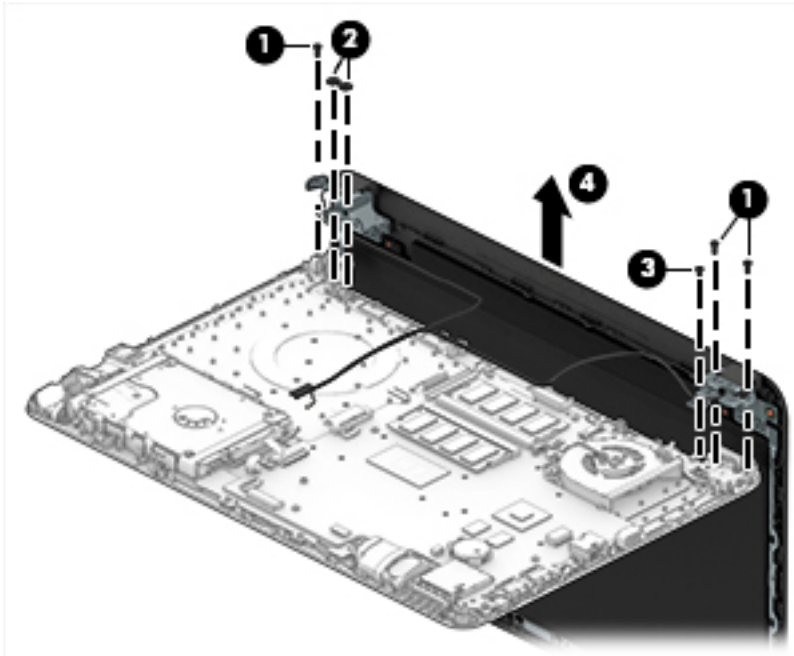

If it is necessary to replace any of the display assembly subcomponents:

1. To remove the display bezel:
 - a. Remove the two screw covers **(1)** and two Phillips PM2.5×3.5 screws **(2)** that secure the display bezel to the enclosure.

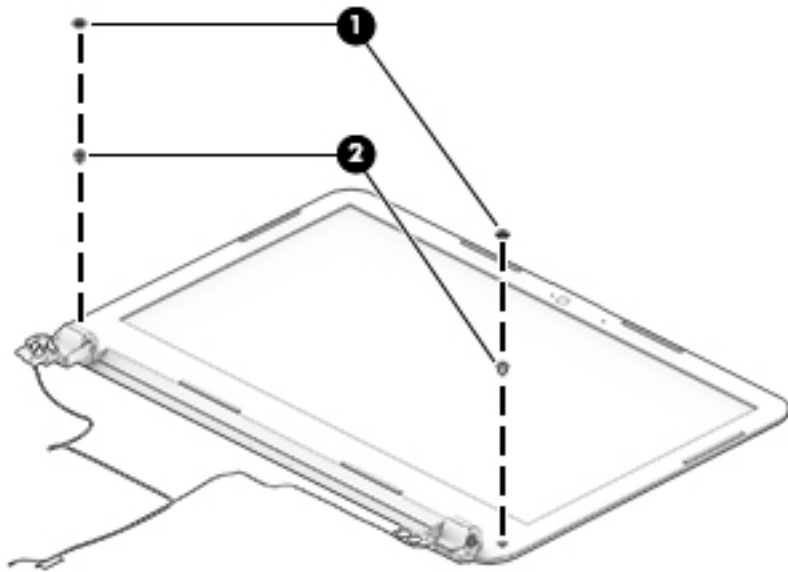

- b. At the seams in the front of the display hinges, use a plastic, non-marking tool **(1)** to separate the bezel **(2)** from the display enclosure.

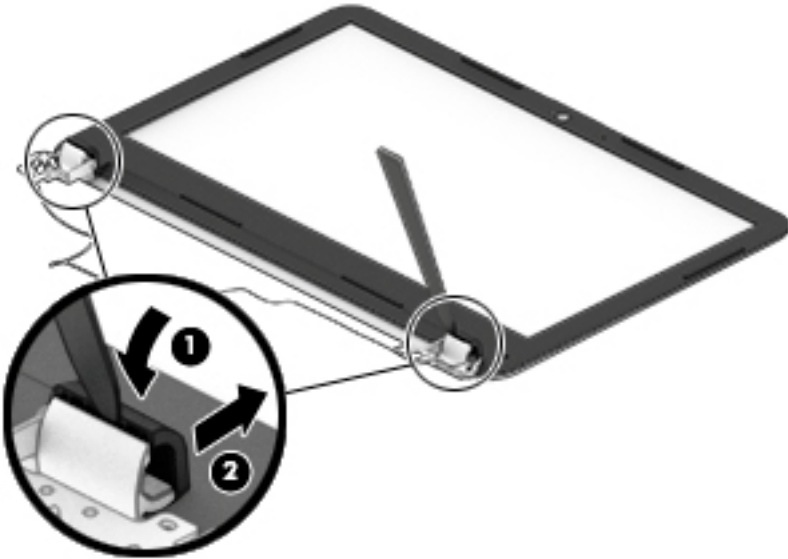

- c. At the seam in the bottom of the display, use a plastic, non-marking tool **(1)** to separate the bezel **(2)** from the display enclosure.



- d. Lift the left **(1)**, top **(2)**, and the right sides **(3)** of the bezel to loosen it from the display. Lift the bezel off the display **(4)**.

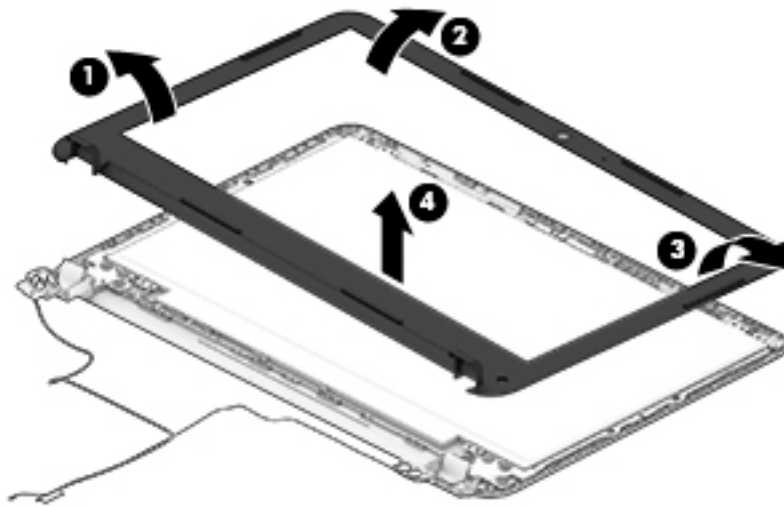

2. To remove the webcam/microphone module:
 - a. Position the display assembly with the top edge toward you.
 - b. Disconnect the cable **(1)** from the module.

- c. Lift to disengage the adhesive that secures the webcam/microphone module to the display, and then remove the module **(2)**.

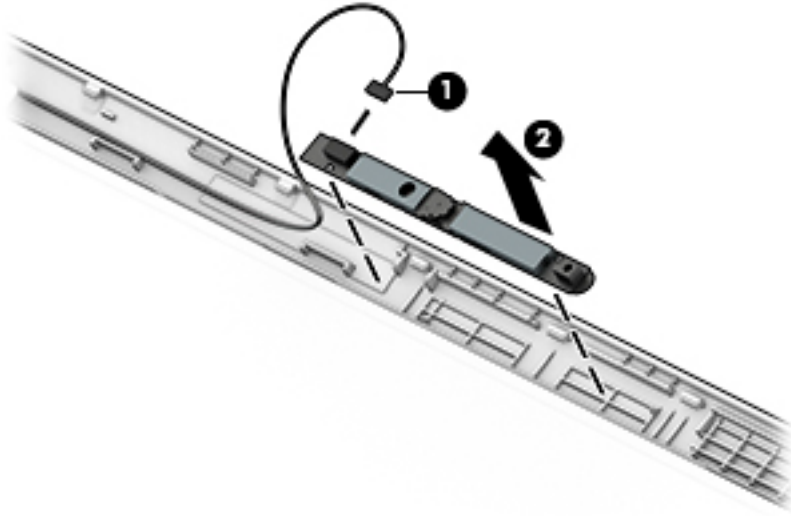

3. To remove the display panel:

- a. Remove the four Phillips PM2.0×2.4 screws that secure the display panel to the enclosure.

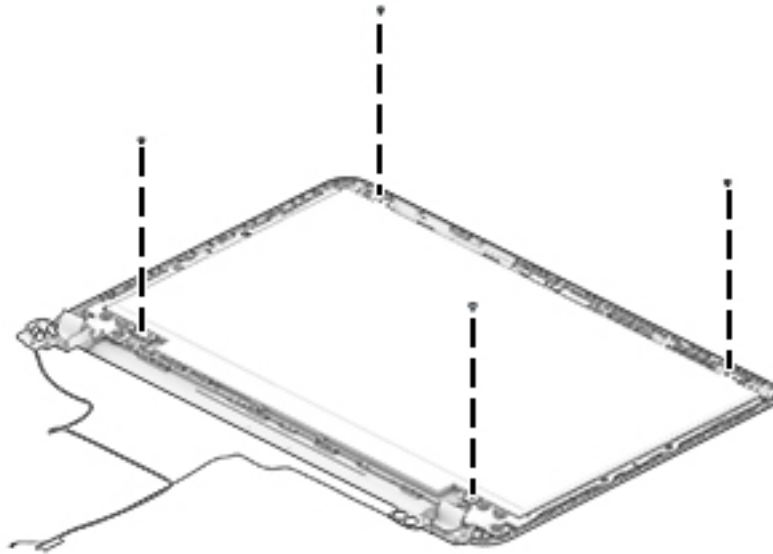

- b. Rotate the display panel off the display enclosure **(1)** to gain access to the display cable connection on the back of the panel.

- c. On the back of the display panel, release the adhesive strip **(2)** that secures the display panel cable to the display panel, and then disconnect the cable **(3)**.

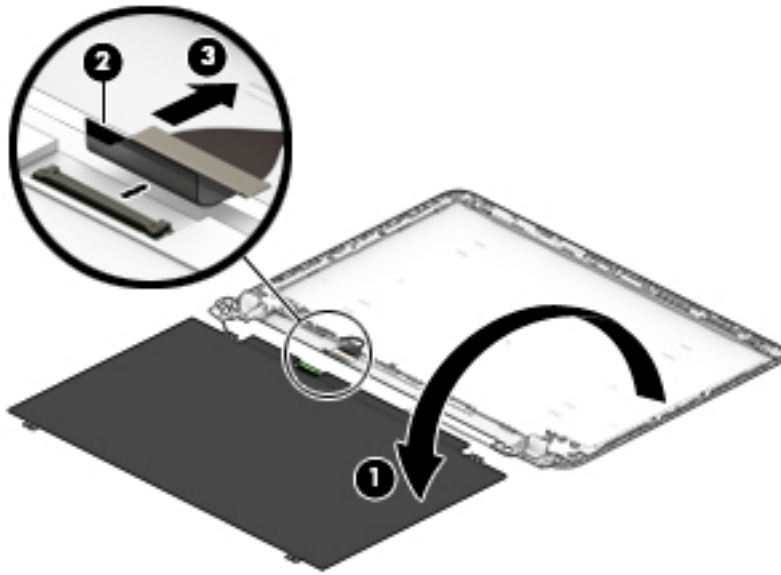

4. To remove the display hinges:
- a. Remove the two Phillips PM2.0×3.0 screws **(1)** that secure the top hinge to the display enclosure.
 - b. Lift the tape **(2)**, and then remove the top display hinge **(3)**.

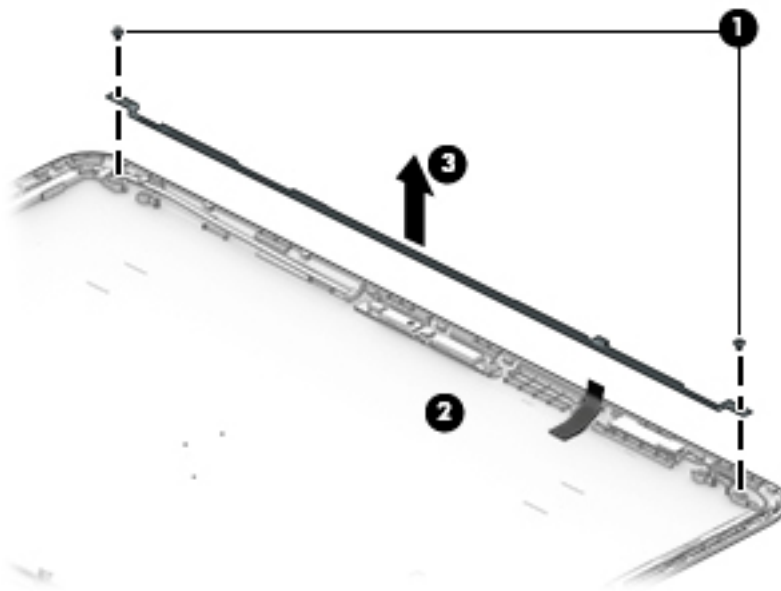

- c. Remove the six broadhead Phillips PM2.5×3.0 screws **(1)** at the bottom of the hinges that secure the left and right hinges to the display enclosure.
- d. Remove the two Phillips PM2.0×3.0 screws **(2)** in the middle of the hinges that secure the left and right hinges to the display enclosure.
- e. Lift the tape that secures the left and right hinges to the enclosure **(3)**.

- f. Remove the left and right display hinges (4).

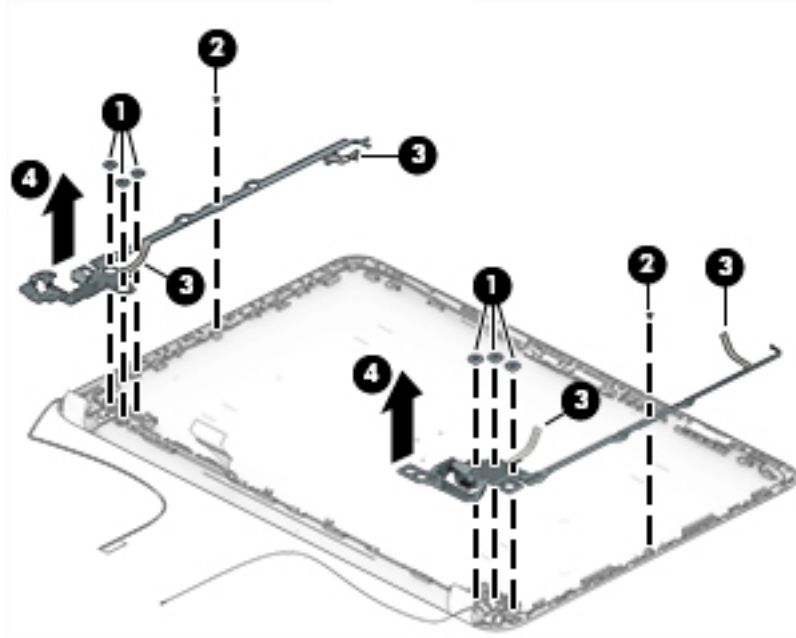

5. To remove the wireless cable and antenna (1), release the cable from the clips built into the display enclosure (2), and then remove the cable and antenna.

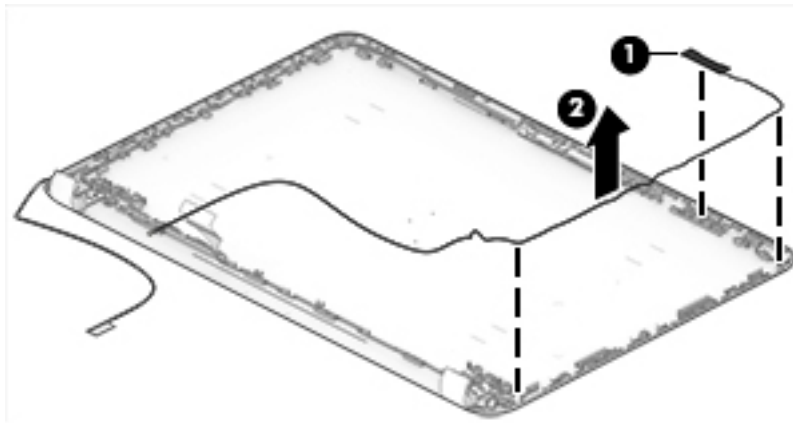

6. To remove the display/webcam cable, remove the cable from the clips built into the display enclosure, and then remove the cable from the display enclosure.

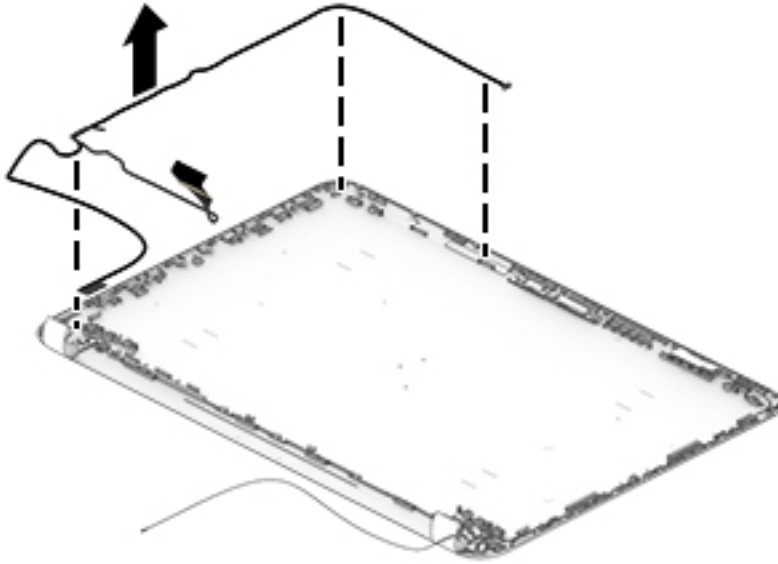

7. If replacing the display enclosure, be sure that the subcomponents (including the webcam/microphone module, the antenna receivers, and all associated cables and hardware) are transferred to the new enclosure.

Use the following image to determine proper cable routing in the display.

(1): Display/webcam cable

(2): Antenna cable

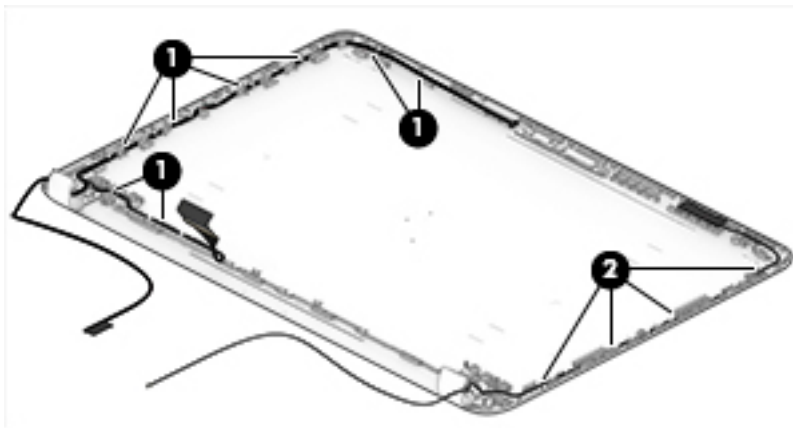

Reverse this procedure to reassemble and install the display assembly.

Power connector cable

Description	Spare part number
Power connector cable	813505-001

Before removing the power connector cable, follow these steps:

1. Shut down the computer. If you are unsure whether the computer is off or in Hibernation, turn the computer on, and then shut it down through the operating system.
2. Disconnect all external devices connected to the computer.
3. Disconnect the power from the computer by first unplugging the power cord from the AC outlet and then unplugging the AC adapter from the computer.
4. Remove the battery (see [Battery on page 26](#)).
5. Remove the optical drive (see [Optical drive on page 27](#)).
6. Remove the bottom cover (see [Bottom cover on page 30](#)).
7. Remove the display (see [Display assembly on page 53](#)).

To remove the power connector cable:

1. Disconnect the cable from the system board (1).
2. Lift the tape and remove the cable from the clips around the fan (2).
3. Lift the power connector cable from the computer (3).

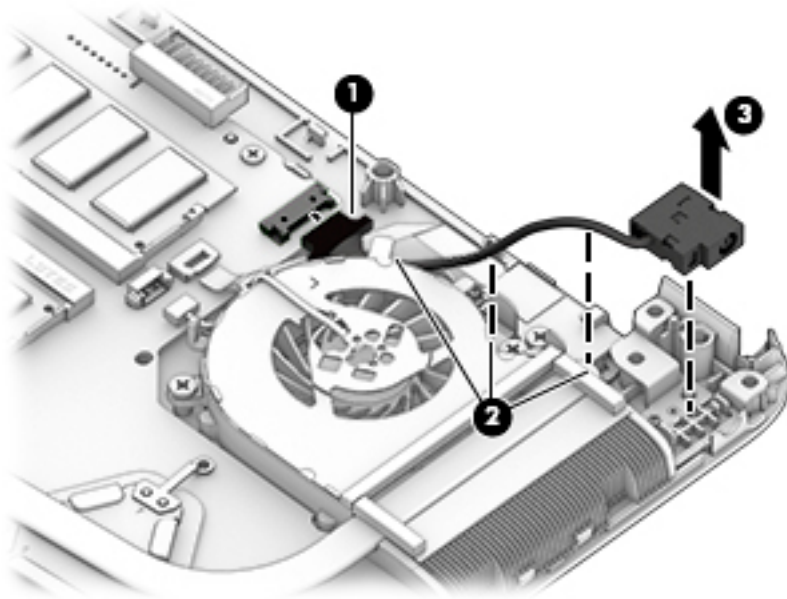

Reverse this procedure to install the power connector cable.

Top cover/keyboard

In this section, the first table provides the main spare part number for the keyboard. The second table provides the country codes.



NOTE: All top cover/keyboard spare part kits include TouchPad.

Description	Spare part number
Top cover/keyboard for use in turbo silver HP Notebook PC models	858078-xx1
Top cover/keyboard for use in white silver HP Notebook PC models	858079-xx1
Top cover/keyboard for use in red HP Notebook PC models	858080-xx1
Top cover/keyboard for use in blue HP Notebook PC models	858082-xx1
Top cover/keyboard for use in all black models	858077-xx1

For use in country or region	Spare part number	For use in country or region	Spare part number
Canada	-DB1	Taiwan	-AB1
Latin America	-161	Thailand	-281
South Korea	-AD1	United States	-001

The top cover/keyboard spare part kit includes the keyboard, keyboard cable and the keyboard backlight cable.

The top cover/keyboard spare part remains after all other spare parts have been removed.

7 Using Setup Utility (BIOS) in Windows 10

Setup Utility, or Basic Input/Output System (BIOS), controls communication between all the input and output devices on the system (such as disk drives, display, keyboard, mouse, and printer). Setup Utility (BIOS) includes settings for the types of devices installed, the startup sequence of the computer, and the amount of system and extended memory.

 **NOTE:** To start Setup Utility on convertible computers, your computer must be in notebook mode and you must use the keyboard attached to your notebook.

Starting Setup Utility (BIOS)

 **CAUTION:** Use extreme care when making changes in Setup Utility (BIOS). Errors can prevent the computer from operating properly.

- ▲ Turn on or restart the computer, quickly press **esc**, and then press **f10**.

Updating Setup Utility (BIOS)

Updated versions of Setup Utility (BIOS) may be available on the HP website.

Most BIOS updates on the HP website are packaged in compressed files called *SoftPaqs*.

Some download packages contain a file named *Readme.txt*, which contains information regarding installing and troubleshooting the file.

Determining the BIOS version

To decide whether you need to update Setup Utility (BIOS), first determine the BIOS version on your computer.

To reveal the BIOS version information (also known as *ROM date* and *System BIOS*), use one of these options.

- HP Support Assistant
 1. Type `support` in the taskbar search box, and then select the **HP Support Assistant** app.
– or –
Click the question mark icon in the taskbar.
 2. Select **My PC**, and then select **Specifications**.
- Setup Utility (BIOS)
 1. Start Setup Utility (BIOS) (see [Starting Setup Utility \(BIOS\) on page 63](#)).
 2. Select **Main**, select **System Information**, and then make note of the BIOS version.
 3. Select **Exit**, select **No**, and then follow the on-screen instructions.

To check for later BIOS versions, see [Downloading a BIOS update on page 64](#).

Downloading a BIOS update

 **CAUTION:** To reduce the risk of damage to the computer or an unsuccessful installation, download and install a BIOS update only when the computer is connected to reliable external power using the AC adapter. Do not download or install a BIOS update while the computer is running on battery power, docked in an optional docking device, or connected to an optional power source. During the download and installation, follow these instructions:

- Do not disconnect power from the computer by unplugging the power cord from the AC outlet.
- Do not shut down the computer or initiate Sleep.
- Do not insert, remove, connect, or disconnect any device, cable, or cord.

 **NOTE:** If your computer is connected to a network, consult the network administrator before installing any software updates, especially system BIOS updates.

1. Type `support` in the taskbar search box, and then select the **HP Support Assistant** app.
– or –
Click the question mark icon in the taskbar.
2. Click **Updates**, and then click **Check for updates and messages**.
3. Follow the on-screen instructions.
4. At the download area, follow these steps:
 - a. Identify the most recent BIOS update and compare it to the BIOS version currently installed on your computer. If the update is more recent than your BIOS version, make a note of the date, name, or other identifier. You may need this information to locate the update later, after it has been downloaded to your hard drive.
 - b. Follow the on-screen instructions to download your selection to the hard drive.

Make a note of the path to the location on your hard drive where the BIOS update is downloaded. You will need to access this path when you are ready to install the update.

BIOS installation procedures vary. Follow any instructions that appear on the screen after the download is complete. If no instructions appear, follow these steps:

1. Type `file` in the taskbar search box, and then select **File Explorer**.
2. Click your hard drive designation. The hard drive designation is typically Local Disk (C:).
3. Using the hard drive path you recorded earlier, open the folder that contains the update.
4. Double-click the file that has an `.exe` extension (for example, `filename.exe`).

The BIOS installation begins.
5. Complete the installation by following the on-screen instructions.

 **NOTE:** After a message on the screen reports a successful installation, you can delete the downloaded file from your hard drive.

8 Backing up, restoring, and recovering in Windows 10

This chapter provides information about the following processes. The information in the chapter is standard procedure for most products.

- Creating recovery media and backups
- Restoring and recovering your system

For additional information, refer to the HP support assistant app.

- ▲ Type `support` in the taskbar search box, and then select the **HP Support Assistant** app.

– or –

Click the question mark icon in the taskbar.

 **IMPORTANT:** If you will be performing recovery procedures on a tablet, the tablet battery must be at least 70% charged before you start the recovery process.

IMPORTANT: For a tablet with a detachable keyboard, connect the keyboard to the keyboard dock before beginning any recovery process.

Creating recovery media and backups

The following methods of creating recovery media and backups are available on select products only. Choose the available method according to your computer model.

- Use HP Recovery Manager to create HP Recovery media after you successfully set up the computer. This step creates a backup of the HP Recovery partition on the computer. The backup can be used to reinstall the original operating system in cases where the hard drive is corrupted or has been replaced. For information on creating recovery media, see [Creating HP Recovery media \(select products only\) on page 65](#). For information on the recovery options that are available using the recovery media, see [Using Windows tools on page 66](#).

- Use Windows tools to create system restore points and create backups of personal information.

For more information, see [Recovering using HP Recovery Manager on page 67](#).

 **NOTE:** If storage is 32 GB or less, Microsoft System Restore is disabled by default.

Creating HP Recovery media (select products only)

If possible, check for the presence of the Recovery partition and the Windows partition. From the **Start** menu, select **File Explorer**, and then select **This PC**.

- If your computer does not list the Windows partition and the Recovery partition, you can obtain recovery media for your system from support. See the *Worldwide Telephone Numbers* booklet included with the computer. You can also find contact information on the HP website. Go to <http://www.hp.com/support>, select your country or region, and follow the on-screen instructions.

You can use Windows tools to create system restore points and create backups of personal information, see [Using Windows tools on page 66](#).

- If your computer does list the Recovery partition and the Windows partition, you can use HP Recovery Manager to create recovery media after you successfully set up the computer. HP Recovery media can be used to perform system recovery if the hard drive becomes corrupted. System recovery reinstalls the original operating system and software programs that were installed at the factory and then configures the settings for the programs. HP Recovery media can also be used to customize the system or restore the factory image if you replace the hard drive.
 - Only one set of recovery media can be created. Handle these recovery tools carefully, and keep them in a safe place.
 - HP Recovery Manager examines the computer and determines the required storage capacity for the media that will be required.
 - To create recovery discs, your computer must have an optical drive with DVD writer capability, and you must use only high-quality blank DVD-R, DVD+R, DVD-R DL, or DVD+R DL discs. Do not use rewritable discs such as CD±RW, DVD±RW, double-layer DVD±RW, or BD-RE (rewritable Blu-ray) discs; they are not compatible with HP Recovery Manager software. Or, instead, you can use a high-quality blank USB flash drive.
 - If your computer does not include an integrated optical drive with DVD writer capability, but you would like to create DVD recovery media, you can use an external optical drive (purchased separately) to create recovery discs. If you use an external optical drive, it must be connected directly to a USB port on the computer; the drive cannot be connected to a USB port on an external device, such as a USB hub. If you cannot create DVD media yourself, you can obtain recovery discs for your computer from HP. See the *Worldwide Telephone Numbers* booklet included with the computer. You can also find contact information on the HP website. Go to <http://www.hp.com/support>, select your country or region, and follow the on-screen instructions.
 - Be sure that the computer is connected to AC power before you begin creating the recovery media.
 - The creation process can take an hour or more. Do not interrupt the creation process.
 - If necessary, you can exit the program before you have finished creating all of the recovery DVDs. HP Recovery Manager will finish burning the current DVD. The next time you start HP Recovery Manager, you will be prompted to continue.

To create HP Recovery media:



IMPORTANT: For a tablet with a detachable keyboard, connect the keyboard to the keyboard dock before beginning these steps.

1. Type `recovery` in the taskbar search box, and then select **HP Recovery Manager**.
2. Select **Create recovery media**, and then follow the on-screen instructions.

If you ever need to recover the system, see [Recovering using HP Recovery Manager on page 67](#).

Using Windows tools

You can create recovery media, system restore points, and backups of personal information using Windows tools.



NOTE: If storage is 32 GB or less, Microsoft System Restore is disabled by default.

For more information and steps, see the Get started app.

- ▲ Select the **Start** button, and then select the **Get started** app.

Restore and recovery

There are several options for recovering your system. Choose the method that best matches your situation and level of expertise:

 **IMPORTANT:** Not all methods are available on all products.

- Windows offers several options for restoring from backup, refreshing the computer, and resetting the computer to its original state. For more information see the Get started app.
 - ▲ Select the **Start** button, and then select the **Get started** app.
- If you need to correct a problem with a preinstalled application or driver, use the Reinstall drivers and/or applications option (select products only) of HP Recovery Manager to reinstall the individual application or driver.
 - ▲ Type `recovery` in the taskbar search box, select **HP Recovery Manager**, select **Reinstall drivers and/or applications**, and then follow the on-screen instructions.
- If you want to recover the Windows partition to original factory content, you can choose the System Recovery option from the HP Recovery partition (select products only) or use the HP Recovery media. For more information, see [Recovering using HP Recovery Manager on page 67](#). If you have not already created recovery media, see [Creating HP Recovery media \(select products only\) on page 65](#).
- On select products, if you want to recover the computer's original factory partition and content, or if you have replaced the hard drive, you can use the Factory Reset option of HP Recovery media. For more information, see [Recovering using HP Recovery Manager on page 67](#).
- On select products, if you want to remove the recovery partition to reclaim hard drive space, HP Recovery Manager offers the Remove Recovery Partition option.

For more information, see [Removing the HP Recovery partition \(select products only\) on page 69](#).

Recovering using HP Recovery Manager

HP Recovery Manager software allows you to recover the computer to its original factory state by using the HP Recovery media that you either created or that you obtained from HP, or by using the HP Recovery partition (select products only). If you have not already created recovery media, see [Creating HP Recovery media \(select products only\) on page 65](#).

What you need to know before you get started

- HP Recovery Manager recovers only software that was installed at the factory. For software not provided with this computer, you must either download the software from the manufacturer's website or reinstall the software from the media provided by the manufacturer.

 **IMPORTANT:** Recovery through HP Recovery Manager should be used as a final attempt to correct computer issues.

- HP Recovery media must be used if the computer hard drive fails. If you have not already created recovery media, see [Creating HP Recovery media \(select products only\) on page 65](#).
- To use the Factory Reset option (select products only), you must use HP Recovery media. If you have not already created recovery media, see [Creating HP Recovery media \(select products only\) on page 65](#).
- If your computer does not allow the creation of HP Recovery media or if the HP Recovery media does not work, you can obtain recovery media for your system from support. See the *Worldwide Telephone Numbers* booklet included with the computer. You can also find contact information from the HP

website. Go to <http://www.hp.com/support>, select your country or region, and follow the on-screen instructions.

 **IMPORTANT:** HP Recovery Manager does not automatically provide backups of your personal data. Before beginning recovery, back up any personal data you want to retain.

Using HP Recovery media, you can choose from one of the following recovery options:

 **NOTE:** Only the options available for your computer display when you start the recovery process.

- System Recovery—Reinstalls the original operating system, and then configures the settings for the programs that were installed at the factory.
- Factory Reset—Restores the computer to its original factory state by deleting all information from the hard drive and re-creating the partitions. Then it reinstalls the operating system and the software that was installed at the factory.

The HP Recovery partition (select products only) allows System Recovery only.

Using the HP Recovery partition (select products only)

The HP Recovery partition allows you to perform a system recovery without the need for recovery discs or a recovery USB flash drive. This type of recovery can be used only if the hard drive is still working.

To start HP Recovery Manager from the HP Recovery partition:

 **IMPORTANT:** For a tablet with a detachable keyboard, connect the keyboard to the keyboard dock before beginning these steps (select products only).

1. Type `recovery` in the taskbar search box, select **Recovery Manager**, and then select **HP Recovery Environment**.

- or -

For computers or tablets with keyboards attached, press **f11** while the computer boots, or press and hold **f11** as you press the power button.

For tablets without keyboards:

Turn on or restart the tablet, and then quickly hold down the volume down button; then select **f11**.

- or -

Turn on or restart the tablet, and then quickly hold down the Windows button; then select **f11**.

2. Select **Troubleshoot** from the boot options menu.
3. Select **Recovery Manager**, and then follow the on-screen instructions.

Using HP Recovery media to recover

You can use HP Recovery media to recover the original system. This method can be used if your system does not have an HP Recovery partition or if the hard drive is not working properly.

1. If possible, back up all personal files.
2. Insert the HP Recovery media, and then restart the computer.

 **NOTE:** If the computer does not automatically restart in HP Recovery Manager, change the computer boot order. See [Changing the computer boot order on page 69](#).

3. Follow the on-screen instructions.

Changing the computer boot order

If your computer does not restart in HP Recovery Manager, you can change the computer boot order, which is the order of devices listed in BIOS where the computer looks for startup information. You can change the selection to an optical drive or a USB flash drive.

To change the boot order:

 **IMPORTANT:** For a tablet with a detachable keyboard, connect the keyboard to the keyboard dock before beginning these steps.

1. Insert the HP Recovery media.
2. Access BIOS:

For computers or tablets with keyboards attached:

- ▲ Turn on or restart the computer or tablet, quickly press **esc**, and then press **f9** for boot options.

For tablets without keyboards:

- ▲ Turn on or restart the tablet, and then quickly hold down the volume down button; then select **f9**.
- or -

Turn on or restart the tablet, and then quickly hold down the Windows button; then select **f9**.

3. Select the optical drive or USB flash drive from which you want to boot.
4. Follow the on-screen instructions.

Removing the HP Recovery partition (select products only)

HP Recovery Manager software allows you to remove the HP Recovery partition to free up hard drive space.

 **IMPORTANT:** After you remove the HP Recovery partition, you will not be able to perform System Recovery or create HP recovery media from the HP Recovery partition. So before you remove the Recovery partition, create HP Recovery media; see [Creating HP Recovery media \(select products only\) on page 65](#).

 **NOTE:** The Remove Recovery Partition option is only available on products that support this function.

Follow these steps to remove the HP Recovery partition:

1. Type `recovery` in the taskbar search box, and then select **HP Recovery Manager**.
2. Select **Remove Recovery Partition**, and then follow the on-screen instructions.

9 Using HP PC Hardware Diagnostics (UEFI)

HP PC Hardware Diagnostics is a Unified Extensible Firmware Interface (UEFI) that allows you to run diagnostic tests to determine whether the computer hardware is functioning properly. The tool runs outside the operating system so that it can isolate hardware failures from issues that are caused by the operating system or other software components.

When HP PC Hardware Diagnostics (UEFI) detects a failure that requires hardware replacement, a 24-digit Failure ID code is generated. This ID code can then be provided to support to help determine how to correct the problem.

 **NOTE:** To start diagnostics on a convertible computer, your computer must be in notebook mode and you must use the keyboard attached.

To start HP PC Hardware Diagnostics (UEFI), follow these steps:

1. Turn on or restart the computer, and quickly press **esc**.
2. Press **f2**.

The BIOS searches three places for the diagnostic tools, in the following order:

- a. Connected USB drive

 **NOTE:** To download the HP PC Hardware Diagnostics (UEFI) tool to a USB drive, see [Downloading HP PC Hardware Diagnostics \(UEFI\) to a USB device on page 71](#).

- b. Hard drive
 - c. BIOS
3. When the diagnostic tool opens, select the type of diagnostic test you want to run, and then follow the on-screen instructions.

 **NOTE:** If you need to stop a diagnostic test, press **esc**.

Downloading HP PC Hardware Diagnostics (UEFI) to a USB device

 **NOTE:** The HP PC Hardware Diagnostics (UEFI) download instructions are provided in English only, and you must use a Windows computer to download and create the HP UEFI support environment because only .exe files are offered.

There are two options to download HP PC Hardware Diagnostics to a USB device.

Download the latest UEFI version

1. Go to <http://www.hp.com/go/techcenter/pcdiags>. The HP PC Diagnostics home page is displayed.
2. In the HP PC Hardware Diagnostics section, select the **Download** link, and then select **Run**.

Download any version of UEFI for a specific product

1. Go to <http://www.hp.com/support>.
2. Select **Get software and drivers**.

3. Enter the product name or number.

– or –

Select **Identify now** to let HP automatically detect your product.

4. Select your computer, and then select your operating system.
5. In the **Diagnostic** section, follow the on-screen instructions to select and download the UEFI version you want.

10 Specifications

Computer specifications

	Metric	U.S.
Dimensions (touch models)		
Depth	241.5 mm	9.51 in
Width	345.4 mm	13.60 in
Height	23.9 mm	0.94 in
Weight		
3 cell battery, hard drive and optical drive	1900 g	4.19 lb
4 cell battery, hard drive and optical drive	1940 g	4.28 lb
3 cell battery, hard drive, no optical drive	1780 g	3.92 lb
4 cell battery, hard drive, no optical drive	1820 g	4.01 lb
Input power		
Operating voltage and current	19.5 V dc @ 2.31 A – 45 W	
	19.5 V dc @ 3.33 A – 65 W	
Temperature		
Operating	5°C to 35°C	41°F to 95°F
Nonoperating	-20°C to 60°C	-4°F to 140°F
Relative humidity (noncondensing)		
Operating	10% to 90%	
Nonoperating	5% to 95%	
Maximum altitude (unpressurized)		
Operating	-15 m to 3,048 m	-50 ft to 10,000 ft
Nonoperating	-15 m to 12,192 m	-50 ft to 40,000 ft
NOTE: Applicable product safety standards specify thermal limits for plastic surfaces. The device operates well within this range of temperatures.		

35.6-cm (14.0-in) display specifications

	Metric	U.S.
Dimensions		
Height	17.6 cm	6.93 in
Width	31.2 cm	12.28 in
Diagonal	35.7 cm	14.06 in
Brightness	220 nits	
Resolution	1366 × 768	
Viewing angle	SVA or UWVA	
Backlight	WLED	
Graphics adapter	eDP	
Thickness	3.0 mm	

Hard drive specifications

	1-TB*	500-GB*
Dimensions		
Height	9.5 mm	7.0 mm or 9.5 mm
Length	100.4 mm	100.6 mm
Width	69.9 mm	70.1 mm
Weight	107.0 g	92.0 g
Interface type	SATA	SATA
Transfer rate		
Synchronous (maximum)	300 MB/sec	300 MB/sec
Security	ATA security	ATA security
Seek times (typical read, including setting)		
Single track	2.0 ms	3 ms
Average (read/write)	12 ms	13 ms
Maximum	22 ms	24 ms
Logical blocks	1,953,525,168	1,048,576,000
Disk rotational speed	5400 rpm	5400 rpm
Operating temperature		
*1 GB = 1 billion bytes when referring to hard drive storage capacity. Actual accessible capacity is less.		
NOTE: Certain restrictions and exclusions apply. Contact technical support for details.		

DVD±RW SuperMulti DL Drive specifications

Component	Value	
Applicable disc	Read: CD-DA, CD+(E)G, CD-MIDI, CD-TEXT, CD-ROM, CD-ROM XA, MIXED MODE CD, CD-I, CD-I Bridge (Photo-CD, Video CD), Multisession CD (Photo-CD, CD-EXTRA, Portfolio, CD-R, CD-RW), CD-R, CD-RW, DVD-ROM (DVD-5, DVD-9, DVD-10, DVD-18), DVD-R, DVD-RW, DVD+R, DVD+RW, DVD-RAM	Write: CD-R and CD-RW DVD+R, DVD+RW, DVD-R, DVD-RW, DVD-RAM
Center hole diameter	1.5 cm (0.59 in)	
Disc diameter		
Standard disc	12 cm (4.72 in)	
Mini disc	8 cm (3.15 in)	
Disc thickness	1.2 mm (0.047 in)	
Track pitch	0.74 μm	
Access time	CD	DVD
Random	< 175 ms	< 230 ms
Full stroke	< 285 ms	< 335 ms
Audio output level	Line-out, 0.7 Vrms	
Cache buffer	2 MB	
Data transfer rate		
24X CD-ROM	3,600 KB/sec	
8X DVD-ROM	10,800 KB/sec	
24X CD-R	3,600 KB/sec	
16X CD-RW	2,400 KB/sec	
8X DVD+R	10,800 KB/sec	
4X DVD+RW	5,400 KB/sec	
8X DVD-R	10,800 KB/sec	
4X DVD-RW	5,400 KB/sec	
2.4X DVD+R(9)	2,700 KB/sec	
5X DVD-RAM	6,750 KB/sec	
Transfer mode	Multiword DMA Mode	
Startup time	< 15 seconds	
Stop time	< 6 seconds	

11 Statement of memory volatility

The purpose of this chapter is to provide general information regarding nonvolatile memory in HP Business PCs. This chapter also provides general instructions for restoring nonvolatile memory that can contain personal data after the system has been powered off and the hard drive has been removed.

HP Business PC products that use Intel®-based or AMD®-based system boards contain volatile DDR memory. The amount of nonvolatile memory present in the system depends upon the system configuration. Intel-based and AMD-based system boards contain nonvolatile memory subcomponents as originally shipped from HP, assuming that no subsequent modifications have been made to the system and assuming that no applications, features, or functionality have been added to or installed on the system.

Following system shutdown and removal of all power sources from an HP Business PC system, personal data can remain on volatile system memory (DIMMs) for a finite period of time and will also remain in nonvolatile memory. Use the steps below to remove personal data from the PC, including the nonvolatile memory found in Intel-based and AMD-based system boards.

 **NOTE:** If your tablet has a keyboard base, connect to the keyboard base before beginning steps in this chapter.

Current BIOS steps

1. Follow steps (a) through (f) below to restore the nonvolatile memory that can contain personal data. Restoring or reprogramming nonvolatile memory that does not store personal data is neither necessary nor recommended.
 - a. Turn on or restart the computer, and then press **esc** while the "Press the ESC key for Startup Menu" message is displayed at the bottom of the screen.

 **IMPORTANT:** If the **Main** menu displays **Restore Defaults** instead of **Apply Factory Defaults and Exit**, go to [Legacy BIOS Steps on page 78](#).

 **NOTE:** If the system has a BIOS administrator password, enter the password at the prompt.
 - b. Select **Main**, select **Apply Factory Defaults and Exit**, and then select **Yes** to load defaults.
The computer will reboot.
 - c. During the reboot, press **esc** while the "Press the ESC key for Startup Menu" message is displayed at the bottom of the screen.

 **NOTE:** If the system has a BIOS administrator password, enter the password at the prompt.
 - d. Select the **Security** menu, select **Restore Security Settings to Factory Defaults**, and then select **Yes** to restore security level defaults.
The computer will reboot.
 - e. During the reboot, press **esc** while the "Press the ESC key for Startup Menu" message is displayed at the bottom of the screen.

 **NOTE:** If the system has a BIOS administrator password, enter the password at the prompt.
 - f. If an asset or ownership tag is set, select the **Security** menu and scroll down to the **Utilities** menu. Select **System IDs**, and then select **Asset Tracking Number**. Clear the tag, and then make the selection to return to the prior menu.

- g. If a DriveLock password is set, select the **Security** menu, and scroll down to **Hard Drive Utilities** under the **Utilities** menu. Select **Hard Drive Utilities**, select **DriveLock**, then uncheck the checkbox for **DriveLock password on restart**. Select **OK** to proceed.
- h. Select the **Main** menu, and then select **Reset BIOS Security to factory default**. Click **Yes** at the warning message.
The computer will reboot.
- i. During the reboot, press **esc** while the "Press the ESC key for Startup Menu" message is displayed at the bottom of the screen.



NOTE: If the system has a BIOS administrator password, enter the password at the prompt.

- j. Select the **Main** menu, select **Apply Factory Defaults and Exit**, select **Yes** to save changes and exit, and then select **Shutdown**.
 - k. Reboot the system. If the system has a Trusted Platform Module (TPM) and/or fingerprint reader, one or two prompts will appear—one to clear the TPM and the other to Reset Fingerprint Sensor; press or tap **F1** to accept or **F2** to reject.
 - l. Remove all power and system batteries for at least 24 hours.
2. Complete one of the following:
- Remove and retain the storage drive.
 - or –
 - Clear the drive contents by using a third party utility designed to erase data from an SSD.
 - or –
 - Clear the contents of the drive by using the following BIOS Setup Secure Erase command option steps:



IMPORTANT: If you clear data using Secure Erase, it cannot be recovered.

- a. Turn on or restart the computer, and then press **esc** while the "Press the ESC key for Startup Menu" message is displayed at the bottom of the screen.
- b. Select the **Security** menu and scroll down to the **Utilities** menu.
- c. Select **Hard Drive Tools**.
- d. Under **Utilities**, select **Secure Erase**, select the hard drive storing the data you want to clear, and then follow the on-screen instructions to continue.

Legacy BIOS Steps

Use the steps for older versions of BIOS.



NOTE: If you already completed the steps in [Current BIOS steps on page 77](#), skip this section.

1. Follow steps (a) through (i) below to restore the nonvolatile memory that can contain personal data. Restoring or reprogramming nonvolatile memory that does not store personal data is neither necessary nor recommended.



NOTE: If you have not already done so, access the BIOS menu.

- Turn on or restart the computer, and then press **esc** while the "Press the ESC key for Startup Menu" message is displayed at the bottom of the screen.

 **NOTE:** If the system has a BIOS administrator password, enter the password at the prompt.

- a. Select **Main**, select **Restore Defaults**, and then select **Yes** to load defaults.
 - b. Select the **Security** menu, select **Restore Security Level Defaults**, and then select **Yes** to restore security level defaults.
 - c. If an asset or ownership tag is set, select the **Security** menu and scroll down to the **Utilities** menu. Select **System IDs**, and then select **Asset Tracking Number**. Clear the tag, and then make the selection to return to the prior menu.
 - d. If a DriveLock password is set, select the **Security** menu, and scroll down to **Hard Drive Tools** under the **Utilities** menu. Select **Hard Drive Tools**, select **DriveLock**, then uncheck the checkbox for **DriveLock password on restart**. Select **OK** to proceed.
 - e. If an Automatic DriveLock password is set, select the **Security** menu, scroll down to **Hard Drive Tools** under the **Utilities** menu. Select **Hard Drive Tools**, scroll down to **Automatic DriveLock**, then select the desired hard drive and disable protection. At the automatic drive lock warning screen, select **Yes** to continue. Repeat this procedure if more than one hard drive has an Automatic DriveLock password.
 - f. Select the **Main** menu, and then select **Reset BIOS Security to factory default**. Click **Yes** at the warning message.
 - g. Select the **Main** menu, select **Save Changes and Exit**, select **Yes** to save changes and exit, and then select **Shutdown**.
 - h. Reboot the system. If the system has a Trusted Platform Module (TPM) and/or fingerprint reader, one or two prompts will appear—one to clear the TPM and the other to Reset Fingerprint Sensor; press or tap **F1** to accept or **F2** to reject.
 - i. Remove all power and system batteries for at least 24 hours.
2. Complete one of the following:
- Remove and retain the storage drive.
 - or –
 - Clear the drive contents by using a third party utility designed to erase data from an SSD.
 - or –
 - Clear the contents of the drive by using the following BIOS Setup Secure Erase command option steps:

 **IMPORTANT:** If you clear data using Secure Erase, it cannot be recovered.

- a. Turn on or restart the computer, and then press **esc** while the "Press the ESC key for Startup Menu" message is displayed at the bottom of the screen.
 - b. Select the **Security** menu and scroll down to the **Utilities** menu.
 - c. Select **Hard Drive Tools**.
 - d. Under **Utilities**, select **Secure Erase**, select the hard drive storing the data you want to clear, and then follow the on-screen instructions to continue.
- or –
- Clear the contents of the drive by using the following Disk Sanitizer command steps:

 **IMPORTANT:** If you clear data using Disk Sanitizer, it cannot be recovered.

 **NOTE:** The amount of time it takes for Disk Sanitizer to run can take several hours. Plug the computer into an AC outlet before starting.

- a. Turn on or restart the computer, and then press **esc** while the "Press the ESC key for Startup Menu" message is displayed at the bottom of the screen.
- b. Select the **Security** menu and scroll down to the **Utilities** menu.
- c. Select **Hard Drive Tools**.
- d. Under **Utilities**, select **Disk Sanitizer**, select the hard drive storing the data you want to clear, and then follow the on-screen instructions to continue.

Nonvolatile memory usage

Nonvolatile Memory Type	Amount (Size)	Does this memory store customer data?	Does this memory retain data when power is removed?	What is the purpose of this memory?	How is data input into this memory?	How is this memory write-protected?
HP Sure Start flash (select models only)	2 MBytes	No	Yes	Provides protected backup of critical System BIOS code, EC firmware, and critical PC configuration data for select platforms that support HP Sure Start. For more information, see Using HP Sure Start (select models only) on page 84.	Data cannot be written to this device via the host processor. The content is managed solely by the HP Sure Start Embedded Controller.	This memory is protected by the HP Sure Start Embedded Controller.
Real Time Clock (RTC) battery backed-up CMOS configuration memory	256 Bytes	No	Yes	Stores system date and time and noncritical data.	RTC battery backed-up CMOS is programmed using the Computer Setup (BIOS), or changing the Microsoft Windows date & time.	This memory is not write-protected.
Controller (NIC) EEPROM	64 KBytes (not customer accessible)	No	Yes	Stores NIC configuration and NIC firmware.	NIC EEPROM is programmed using a utility from the NIC vendor that can be run from DOS.	A utility is required to write data to this memory and is available from the NIC vendor. Writing data to this ROM in an inappropriate manner will render the NIC non-functional.
DIMM Serial Presence Detect (SPD) configuration data	256 Bytes per memory module, 128 Bytes programmable (not customer accessible)	No	Yes	Stores memory module information.	DIMM SPD is programmed by the memory vendor.	Data cannot be written to this memory when the module is installed in a PC. The specific write-protection method varies by memory vendor.
System BIOS	4 MBytes to 5 MBytes	Yes	Yes	Stores system BIOS code and PC configuration data.	System BIOS code is programmed at the factory. Code is updated when the system BIOS is updated. Configuration data and settings are input using the Computer Setup (BIOS) or a custom utility.	NOTE: Writing data to this ROM in an inappropriate manner can render the PC non-functional. A utility is required for writing data to this memory and is available on the HP website; go to http://www.hp.com/support . Select Find your product , and then follow

Nonvolatile Memory Type	Amount (Size)	Does this memory store customer data?	Does this memory retain data when power is removed?	What is the purpose of this memory?	How is data input into this memory?	How is this memory write-protected?
Intel Management Engine Firmware (present in only specific ZBook and EliteBook models. For more information, go to http://www.hp.com/support . Select Find your product , and then follow the on-screen instructions.)	1.5 MBytes or 5 MBytes	Yes	Yes	Stores Management Engine Code, Settings, Provisioning Data and iAMT third-party data store.	Management Engine Code is programmed at the factory. Code is updated via Intel secure firmware update utility. Unique Provisioning Data can be entered at the factory or by an administrator using the Management Engine (MEBx) setup utility. The third party data store contents can be populated by a remote management console or local applications that have been registered by an administrator to have access to the space.	the on-screen instructions. The Intel chipset is configured to enforce hardware protection to block all direct read/write access to this area. An Intel utility is required for updating the firmware. Only firmware updates digitally signed by Intel can be applied using this utility.
Bluetooth flash	2 Mbit	No	Yes	Stores Bluetooth configuration and firmware.	Bluetooth flash is programmed at the factory. Tools for writing data to this memory are not publicly available but can be obtained from the silicon vendor.	A utility is required for writing data to this memory and is made available through newer versions of the driver whenever the flash requires an upgrade.
802.11 WLAN EEPROM	4 Kbit to 8 Kbit	No	Yes	Stores configuration and calibration data.	802.11 WLAN EEPROM is programmed at the factory. Tools for writing data to this memory are not made public.	A utility is required for writing data to this memory and is typically not made available to the public unless a firmware upgrade is necessary to address a unique issue.
Web camera	64 Kbit	No	Yes	Stores webcam configuration and firmware.	Webcam memory is programmed using a utility from the device manufacturer that can be run from Windows.	A utility is required for writing data to this memory and is typically not made available to the public unless a firmware upgrade is necessary to address a unique issue.
Fingerprint reader	512 KByte flash	Yes	Yes	Stores fingerprint templates.	Fingerprint reader memory is programmed by user enrollment in HP ProtectTools Security Manager.	Only a digitally signed application can make the call to write to the flash.

Questions and answers

1. How can the BIOS settings be restored (returned to factory settings)?



IMPORTANT: Restore defaults does not securely erase any data on your hard drive. See question and answer 6 for steps to securely erase data.

Restore defaults does not reset the Custom Secure Boot keys. See question and answer 7 for information about resetting the keys.

- a. Turn on or restart the computer, and then press **esc** while the "Press the ESC key for Startup Menu" message is displayed at the bottom of the screen.
- b. Select **Main**, and then select **Restore defaults**.
- c. Follow the on-screen instructions.
- d. Select **Main**, select **Save Changes and Exit**, and then follow the on-screen instructions.

2. What is a UEFI BIOS, and how is it different from a legacy BIOS?

The Unified Extensible Firmware Interface (UEFI) BIOS is an industry-standard software interface between the platform firmware and an operating system (OS). It is a replacement for the older BIOS architecture, but supports much of the legacy BIOS functionality.

Like the legacy BIOS, the UEFI BIOS provides an interface to display the system information and configuration settings and to change the configuration of your computer before an OS is loaded. BIOS provides a secure run-time environment that supports a Graphic User Interface (GUI). In this environment, you can use either a pointing device (Touchscreen, TouchPad, pointing stick, or USB mouse) or the keyboard to navigate and make menu and configuration selections. The UEFI BIOS also contains basic system diagnostics.

The UEFI BIOS provides functionality beyond that of the legacy BIOS. In addition, the UEFI BIOS works to initialize the computer's hardware before loading and executing the OS; the run-time environment allows the loading and execution of software programs from storage devices to provide more functionality, such as advanced hardware diagnostics (with the ability to display more detailed system information) and advanced firmware management and recovery software.

HP has provided options in Computer Setup (BIOS) to allow you to run in legacy BIOS, if required by the operating system. Examples of this requirement would be if you upgrade or downgrade the OS.

3. Where does the UEFI BIOS reside?

The UEFI BIOS resides on a flash memory chip. A utility is required to write to the chip.

4. What kind of configuration data is stored on the DIMM Serial Presence Detect (SPD) memory module? How would this data be written?

The DIMM SPD memory contains information about the memory module, such as size, serial number, data width, speed/timing, voltage, and thermal information. This information is written by the module manufacturer and stored on an EEPROM. This EEPROM cannot be written to when the memory module is installed in a PC. Third-party tools do exist that can write to the EEPROM when the memory module is not installed in a PC. Various third-party tools are available to read SPD memory.

5. What is meant by "Restore the nonvolatile memory found in Intel-based system boards"?

This message relates to clearing the Real Time Clock (RTC) CMOS memory that contains PC configuration data.

6. How can the BIOS security be reset to factory defaults and data erased?

 **IMPORTANT:** Resetting will result in the loss of information.

These steps will not reset Custom Secure Boot Keys. See question and answer 7 for information about resetting the keys.

- a. Turn on or restart the computer, and then press **esc** while the "Press the ESC key for Startup Menu" message is displayed at the bottom of the screen.
- b. Select **Main**, and then select **Reset BIOS Security to Factory Default**.
- c. Follow the on-screen instructions.
- d. Select **Main**, select **Save Changes and Exit**, and then follow the on-screen instructions.

7. How can the Custom Secure Boot Keys be reset?

Secure Boot is a feature to ensure that only authenticated code can start on a platform. If you enabled Secure Boot and created Custom Secure Boot Keys, simply disabling Secure Boot will not clear the keys. You must also select to clear the Custom Secure Boot Keys. Use the same Secure Boot access procedure you used to create the Custom Secure Boot Keys, but make the selection to clear or delete all Secure Boot Keys.

- a. Turn on or restart the computer, and then press **esc** while the "Press the ESC key for Startup Menu" message is displayed at the bottom of the screen.
- b. Select the **Security** menu, select **Secure Boot Configuration**, and then follow the on-screen instructions.
- c. At the **Secure Boot Configuration** window, select **Secure Boot**, select **Clear Secure Boot Keys**, and then follow the on-screen instructions to continue.

Using HP Sure Start (select models only)

Select computer models are configured with HP Sure Start, a technology that continuously monitors your computer's BIOS for attacks or corruption. If the BIOS becomes corrupted or is attacked, HP Sure Start restores the BIOS to its previously safe state, without user intervention. Those select computer models ship with HP Sure Start configured and enabled. HP Sure Start is configured and already enabled so that most users can use the HP Sure Start default configuration. The default configuration can be customized by advanced users.

To access the latest documentation on HP Sure Start, go to <http://www.hp.com/support>. Select **Find your product**, and then follow the on-screen instructions.

12 Power cord set requirements

The wide-range input feature of the computer permits it to operate from any line voltage from 100 to 120 volts ac, or from 220 to 240 volts ac.

The 3-conductor power cord set included with the computer meets the requirements for use in the country or region where the equipment is purchased.

Power cord sets for use in other countries and regions must meet the requirements of the country or region where the computer is used.

Requirements for all countries

The following requirements are applicable to all countries and regions:

- The length of the power cord set must be at least **1.5 m** (5.0 ft) and no more than **2.0 m** (6.5 ft).
- All power cord sets must be approved by an acceptable accredited agency responsible for evaluation in the country or region where the power cord set will be used.
- The power cord sets must have a minimum current capacity of 10 A and a nominal voltage rating of 125 or 250 V ac, as required by the power system of each country or region.
- The appliance coupler must meet the mechanical configuration of an EN 60 320/IEC 320 Standard Sheet C13 connector for mating with the appliance inlet on the back of the computer.

Requirements for specific countries and regions

Country/region	Accredited agency	Applicable note number
Argentina	IRAM	1
Australia	SAA	1
Austria	OVE	1
Belgium	CEBEC	1
Brazil	ABNT	1
Canada	CSA	2
Chile	IMQ	1
Denmark	DEMKO	1
Finland	FIMKO	1
France	UTE	1
Germany	VDE	1
India	ISI	1
Israel	SII	1
Italy	IMQ	1
Japan	JIS	3
The Netherlands	KEMA	1
New Zealand	SANZ	1
Norway	NEMKO	1
The People's Republic of China	CCC	4
Saudi Arabia	SASO	7
Singapore	PSB	1
South Africa	SABS	1
South Korea	KTL	5
Sweden	SEMKO	1
Switzerland	SEV	1
Taiwan	BSMI	6
Thailand	TISI	1
The United Kingdom	ASTA	1
The United States	UL	2

1. The flexible cord must be Type H05VV-F, 3-conductor, 0.75mm² conductor size. Power cord set fittings (appliance coupler and wall plug) must bear the certification mark of the agency responsible for evaluation in the country or region where it will be used.
2. The flexible cord must be Type SVT/SJT or equivalent, No. 18 AWG, 3-conductor. The wall plug must be a two-pole grounding type with a NEMA 5-15P (15 A, 125 V ac) or NEMA 6-15P (15 A, 250 V ac) configuration. CSA or C-UL mark. UL file number must be on each element.

Country/region	Accredited agency	Applicable note number
		3. The appliance coupler, flexible cord, and wall plug must bear a “T” mark and registration number in accordance with the Japanese Dentori Law. The flexible cord must be Type VCTF, 3-conductor, 0.75mm ² or 1.25mm ² conductor size. The wall plug must be a two-pole grounding type with a Japanese Industrial Standard C8303 (7 A, 125 V ac) configuration.
		4. The flexible cord must be Type RVV, 3-conductor, 0.75mm ² conductor size. Power cord set fittings (appliance coupler and wall plug) must bear the CCC certification mark.
		5. The flexible cord must be Type H05VV-F 3X0.75mm ² conductor size. KTL logo and individual approval number must be on each element. Corset approval number and logo must be printed on a flag label.
		6. The flexible cord must be Type HVCTF 3X1.25mm ² conductor size. Power cord set fittings (appliance coupler, cable, and wall plug) must bear the BSMI certification mark.
		7. For 127 V ac, the flexible cord must be Type SVT or SJT 3 x 18 AWG, with plug NEMA 5-15P (15 A, 125 V ac), with UL and CSA or C-UL marks. For 240 V ac, the flexible cord must be Type H05VV-F 3X0.75/1.00mm ² conductor size, with plug BS 1363/A with BSI or ASTA marks.

13 Recycling

When a non-rechargeable or rechargeable battery has reached the end of its useful life, do not dispose of the battery in general household waste. Follow the local laws and regulations in your area for battery disposal.

HP encourages customers to recycle used electronic hardware, HP original print cartridges, and rechargeable batteries. For more information about recycling programs, see the HP Web site at <http://www.hp.com/recycle>.

Index

A

- AC adapter and battery 7
- action keys
 - identifying 11
- antenna
 - illustrated 20
 - removing 59
- antennas
 - removing 60
- audio, product description 2
- audio-out (headphone)/audio-in (microphone) jack, identifying 7

B

- backups 65
- base enclosure
 - illustrated 17
- battery
 - illustrated 17
 - removing 26
- battery cover, identifying 12
- battery lock, identifying 12
- battery release latch 12
- BIOS
 - determining version 63
 - downloading an update 64
 - starting the Setup Utility 63
 - updating 63
- boot order
 - changing 69
- bottom cover
 - removing 30
- buttons
 - left TouchPad 8
 - optical drive eject 6
 - power 10
 - right TouchPad 8

C

- cables, service considerations 21
- caps lock light, identifying 9
- chipset, product description 1
- components for the HP Notebook 14
 - computer model
 - bottom 12

- display 5
 - left side 7
 - right side 6
 - top 8
- computer major components, illustrated 15
- computer specifications 73
- connector, power 7
- connectors, service considerations 21

D

- display assembly
 - illustrated 16
 - removing 53
 - spare part numbers 16
- display assembly subcomponents
 - illustrated 19
 - removing 53
- display bezel
 - illustrated 19
 - removing 54
- display cable
 - illustrated 20
 - removing 58
- display enclosure
 - illustrated 20
 - removing 60
- display panel
 - illustrated 19, 53
 - product description 1
 - removing 57, 58
- display specifications 74
- drive light 6
- DVD±RW SuperMulti DL Drive specifications 76

E

- electrostatic discharge 22
- eMMC drive
 - spare part number 17, 20, 34
- eMMC module
 - removing 34
- equipment guidelines 24
- esc key, identifying 11

- Ethernet, product description 3
- external media cards 3
- external monitor port 7

F

- fan
 - illustrated 17
 - removing 46
- fn key, identifying 11

G

- graphics, product description 1
- grounding guidelines 22
- guidelines
 - equipment 24
 - grounding 22
 - packaging 23
 - transporting 23
 - workstation 23

H

- hard drive
 - illustrated 17, 20
 - precautions 22
 - product description 2
 - removing 32
 - specifications 75
- hard drive bracket
 - illustrated 17
- hard drive connector
 - illustrated 17, 20, 32
 - removing 32
- HDMI port
 - identifying 7
- heat sink assembly
 - illustrated 17
 - removing 17, 43
- hinges
 - illustrated 20
 - removing 57, 58
- HP PC Hardware Diagnostics (UEFI) using 71
- HP Recovery Manager
 - correcting boot problems 69
 - starting 68

- HP Recovery media
 - creating 65
 - recovery 68
 - HP Recovery partition
 - recovery 68
 - removing 69
 - HP Sure Start 84
- I**
- internal card
 - product description 3
 - internal microphone, identifying 5
- J**
- jacks
 - audio-out (headphone)/audio-in (microphone) 7
 - network 7
 - RJ-45 (network) 7
- K**
- keyboard
 - illustrated 16
 - product description 3
 - keys
 - action 11
 - esc 11
 - fn 11
 - Windows 11
- L**
- latch, battery release 12
 - lights
 - AC adapter and battery light 7
 - caps lock 9
 - drive 6
 - mute 9
 - power 6
 - RJ-45 (network) status 7
- M**
- mass storage devices
 - illustrated 20
 - precautions 22
 - memory
 - nonvolatile 77
 - volatile 77
 - memory module
 - illustrated 17
 - product description 1
 - removing 38
 - microphone 2
 - minimized image recovery 68
 - minimized image, creating 67
 - model name 1
 - mute light, identifying 9
- N**
- network jack, identifying 7
 - nonvolatile memory 77
- O**
- operating system 4
 - optical drive
 - illustrated 18
 - precautions 22
 - product description 2
 - removing 27
 - specifications 76
 - optical drive eject button, identifying 6
 - optical drive, identifying 6
 - original system recovery 67
- P**
- packaging guidelines 23
 - plastic parts, service considerations 21
 - pointing device 3
 - ports
 - external monitor 7
 - HDMI 7
 - product description 3
 - USB 2.0 6, 7
 - USB 3.0 7
 - power button board
 - illustrated 16
 - removing 42
 - power button, identifying 10
 - power connector cable
 - illustrated 16
 - removing 61
 - power connector, identifying 7
 - power cord
 - requirements for all countries 85
 - requirements for specific countries and regions 86
 - set requirements 85
 - spare part numbers 18
 - power lights, identifying 6
 - power requirements 3
 - processor
 - product description 1
 - product description
 - audio 2
 - chipset 1
 - display panel 1
 - Ethernet 3
 - external media cards 3
 - graphics 1
 - hard drive 2
 - internal card 3
 - keyboard 3
 - memory module 1
 - microphone 2
 - operating system 4
 - optical drive 2
 - pointing device 3
 - ports 3
 - power requirements 3
 - processor 1
 - product name 1
 - security 4
 - serviceability 4
 - video 2
 - wireless 3
 - product name 1
- R**
- recover
 - options 67
 - recovery
 - discs 66, 68
 - HP Recovery Manager 67
 - media 68
 - starting 68
 - supported discs 66
 - system 67
 - USB flash drive 68
 - using HP Recovery media 66
 - recovery media
 - creating 65
 - creating using HP Recovery Manager 66
 - recovery partition
 - removing 69
 - removal/replacement
 - preliminaries 21
 - procedures 25, 29
 - removing personal data from volatile system memory 77

RJ-45 (network) jack, identifying 7
RJ-45 (network) status lights,
identifying 7
RTC battery
illustrated 17
removing 39

S

security cable slot, identifying 6
security, product description 4
service considerations
cables 21
connectors 21
plastic parts 21
service tag 13
serviceability, product description 4
slots
security cable 6
speakers
identifying 12
illustrated 16
removing 41
specifications
computer 73
display 74
DVD±RW SuperMulti DL Drive 76
hard drive 75
optical drive 76
supported discs, recovery 66
system board
removing 48
spare part number 16, 48
system memory, removing personal
data from volatile 77
system recovery 67
system restore point
creating 66
system restore point, creating 65

T

tools required 21
top cover/keyboard 62
TouchPad
buttons 8
TouchPad button board
removing 52
spare part number 16, 52
TouchPad zone, identifying 8
transporting guidelines 23

U

USB 2.0 port, identifying 6, 7
USB 3.0 port, identifying 7
USB board
removing 40
spare part number 17

V

vents, identifying 7, 12
video, product description 2

W

webcam
identifying 5
webcam light, identifying 5
webcam/microphone cable
illustrated 20
removing 57, 58
webcam/microphone module
illustrated 20
removing 56
Windows
system restore point 65, 66
Windows key, identifying 11
Windows tools
using 66
wireless antenna
illustrated 20
removing 59
wireless antennas
removing 60
wireless, product description 3
WLAN antennas, identifying 5
WLAN module
illustrated 17
removing 36
workstation guidelines 23

Free Manuals Download Website

<http://myh66.com>

<http://usermanuals.us>

<http://www.somanuals.com>

<http://www.4manuals.cc>

<http://www.manual-lib.com>

<http://www.404manual.com>

<http://www.luxmanual.com>

<http://aubethermostatmanual.com>

Golf course search by state

<http://golfingnear.com>

Email search by domain

<http://emailbydomain.com>

Auto manuals search

<http://auto.somanuals.com>

TV manuals search

<http://tv.somanuals.com>