



HP 15 Laptop PC (Intel)

** Model numbers: 15-bs0xx*

HP 15g Laptop PC

** Model numbers: 15g-br0xx*

HP 15q Laptop PC

** Model numbers: 15q-bu0xx*

Maintenance and Service Guide

© Copyright 2017 HP Development Company, L.P.

AMD is a trademark of Advanced Micro Devices, Inc. Bluetooth is a trademark owned by its proprietor and used by HP Inc. under license. Intel, Celeron, and Pentium are trademarks of Intel Corporation in the U.S. and other countries. Microsoft and Windows are U.S. registered trademarks of the Microsoft group of companies.

In accordance with Microsoft's support policy, HP does not support the Windows 8 or Windows 7 operating system on products configured with Intel and AMD 7th generation and forward processors or provide any Windows 8 or Windows 7 drivers on <http://www.support.hp.com>.

The information contained herein is subject to change without notice. The only warranties for HP products and services are set forth in the express warranty statements accompanying such products and services. Nothing herein should be construed as constituting an additional warranty. HP shall not be liable for technical or editorial errors or omissions contained herein.

First Edition: April 2017

Document Part Number: 923865-001

Product notice

This guide describes features that are common to most models. Some features may not be available on your computer.

Not all features are available in all editions or versions of Windows. Systems may require upgraded and/or separately purchased hardware, drivers, software or BIOS update to take full advantage of Windows functionality. Windows 10 is automatically updated, which is always enabled. ISP fees may apply and additional requirements may apply over time for updates. Go to <http://www.microsoft.com> for details.

To access the latest user guides or manuals for your product, go to <http://www.hp.com/support>, and select your country. Select **Find your product**, and then follow the on-screen instructions.

Software terms

By installing, copying, downloading, or otherwise using any software product preinstalled on this computer, you agree to be bound by the terms of the HP End User License Agreement (EULA). If you do not accept these license terms, your sole remedy is to return the entire unused product (hardware and software) within 14 days for a full refund subject to the refund policy of your seller.

For any further information or to request a full refund of the price of the computer, please contact your seller.

Safety warning notice

 **WARNING!** To reduce the possibility of heat-related injuries or of overheating the device, do not place the device directly on your lap or obstruct the device air vents. Use the device only on a hard, flat surface. Do not allow another hard surface, such as an adjoining optional printer, or a soft surface, such as pillows or rugs or clothing, to block airflow. Also, do not allow the AC adapter to contact the skin or a soft surface, such as pillows or rugs or clothing, during operation. The device and the AC adapter comply with the user-accessible surface temperature limits defined by the International Standard for Safety of Information Technology Equipment (IEC 60950-1).

Table of contents

1 Product description	1
2 Getting to know your computer	7
Right side	7
Left side	8
Display	9
Keyboard area	10
TouchPad	10
Lights	11
Button	12
Special keys	13
Action keys	14
Bottom	15
Labels	16
3 Illustrated parts catalog	17
Computer major components	17
Display assembly subcomponents	22
Cables	24
Mass storage devices	25
Miscellaneous parts	26
4 Removal and replacement procedures preliminary requirements	29
Tools required	29
Service considerations	29
Plastic parts	29
Cables and connectors	29
Drive handling	30
Grounding guidelines	30
Electrostatic discharge damage	30
Packaging and transporting guidelines	31
Workstation guidelines	31
5 Removal and replacement procedures for Customer Self-Repair parts	33
Component replacement procedures	33
Battery	34

Optical drive	35
6 Removal and replacement procedures for Authorized Service Provider parts	39
Component replacement procedures	39
Display subcomponents (bezel, panel, camera)	39
Rubber feet	43
Bottom cover	45
WLAN module	48
Memory module	50
Optical drive connector board	52
Hard drive and hard drive connector board	53
M.2 solid-state drive adapter bracket and connector board	56
Solid-state drive (SSD)	58
RTC battery	59
Speakers	60
USB board	61
Fan	62
Heat sink assembly	64
TouchPad button board	68
System board	69
Display assembly	72
Power connector cable	82
Power button board	83
Cable locations	84
Top cover/keyboard	85
7 Using Setup Utility (BIOS)	87
Starting Setup Utility (BIOS)	87
Updating Setup Utility (BIOS)	87
Determining the BIOS version	87
Downloading a BIOS update	88
8 Backing up, restoring, and recovering	89
Creating recovery media and backups	89
Creating HP Recovery media (select products only)	89
Using Windows tools	90
Restore and recovery	91
Recovering using HP Recovery Manager	91
What you need to know before you get started	91
Using the HP Recovery partition (select products only)	92

Using HP Recovery media to recover	92
Changing the computer boot order	93
Removing the HP Recovery partition (select products only)	94
9 Using HP PC Hardware Diagnostics (UEFI)	95
Downloading HP PC Hardware Diagnostics (UEFI) to a USB device	95
10 Specifications	97
Computer specifications	97
39.6-cm (15.6-in) display specifications	98
Hard drive specifications	99
M.2 solid-state drive specifications	100
DVD±RW SuperMulti DL Drive specifications	101
11 Power cord set requirements	103
Requirements for all countries	103
Requirements for specific countries and regions	104
12 Recycling	107
Index	109

1 Product description

Category	Description	7th gen Dis 530	7th gen Dis 520	7th gen UMA	6th gen Dis	6th gen UMA	Pent Dis	Pen/Cel UMA
Product name	HP 15 Laptop PC (Intel) <i>* Model numbers: 15-bs0xx</i>	✓	✓	✓	✓	✓	✓	✓
	HP 15g Laptop PC <i>* Model numbers: 15g-br0xx</i>	✓	✓	✓	✓	✓	✓	✓
	HP 15q Laptop PC <i>* Model numbers: 15q-bu0xx</i>	✓	✓	✓	✓	✓	✓	✓
Processor	7th generation Intel® Core™ processors	✓	✓	✓				
	Intel Core i7-7500U (2.7-GHz, turbo up to 3.5 GHz, 4-MB L3 cache, 2133-MHz, dual, 15W)	✓		✓				
	Intel Core i5-7200U (2.5-GHz, turbo up to 3.1 GHz, 3-MB L3 cache, 2133-MHz, dual, 15W)	✓	✓	✓				
	Intel Core i3-7100U (2.4-GHz, 3-MB L3 cache, 2133-MHz, dual, 15W)				✓			
	6th generation Intel Core processors				✓	✓		
	Intel Core i3-6006U (2.0-GHz, 3-MB L3 cache, 2133-MHz, dual, 15W)				✓	✓		
	Intel Pentium® and Celeron® processors						✓	✓
	Intel Pentium N3710 (1.6-GHz, turbo up to 2.56 GHz, 2-MB L3 cache, 1600-MHz, quad, 6W)						✓	✓
	Intel Celeron N3060 (1.6-GHz, turbo up to 2.48 GHz, 2-MB L3 cache, 1600-MHz, dual, 6W)							✓
Graphics	Internal graphics	✓	✓	✓	✓	✓	✓	✓
	Intel HD Graphics 620	✓	✓	✓				
	Intel HD Graphics 520				✓	✓		
	Intel HD Graphics 405 (Pentium only)						✓	✓
	Intel HD Graphics 400							✓
	Switchable discrete graphics	✓	✓		✓		✓	
	AMD Radeon™ M530 R17M-M1-70 with 4096 MB or 2048 GB of dedicated video memory	✓						
	AMD Radeon M520 R17M-M1-30 with 2048 MB of dedicated video memory (not supported on Celeron)		✓		✓		✓	
	Support HD Decode, DX12, and HDMI	✓	✓	✓	✓	✓	✓	✓

Category	Description	7th gen Dis 530	7th gen Dis 520	7th gen UMA	6th gen Dis	6th gen UMA	Pent Dis	Pen/Cel UMA
Panel	39.6-cm (15.6-in), high-definition (HD), white light-emitting diode (WLED), SVA, BrightView (1366×768) display, slim 3.2 mm, eDP; typical brightness: 220 nits	√	√	√	√	√	√	√
	39.6-cm (15.6-in), high-definition (HD), white light-emitting diode (WLED), SVA, anti glare (1366×768) display, slim 3.2 mm, eDP; typical brightness: 220 nits	√	√	√	√	√	√	√
	39.6-cm (15.6-in), full high-definition (FHD), white light-emitting diode (WLED), SVA, anti glare (1920×1080) display, slim 3.2 mm, eDP; typical brightness: 220 nits	√	√	√	√	√	√	√
Memory	Two non-customer-accessible/upgradable memory module slots (Intel Core processors)	√	√	√	√	√		
	DDR4-2133 dual channel support (DDR4-2400 bridge to DDR4-2133)	√	√	√	√	√		
	Supports up to 16 GB of system RAM in the following configurations:	√	√	√	√	√		
	• 16384-MB total system memory (8192×2)	√	√	√	√	√		
	• 12288-MB total system memory (8192×1) + (4096×1)	√	√	√	√	√		
	• 8192-MB total system memory (8192×1) or (4096×2)	√	√	√	√	√		
	• 6144-MB total system memory (4096×1) + (2048×1)	√	√	√	√	√		
	• 4096-MB total system memory (4096×1)	√	√	√	√	√		
	One non-customer-accessible/upgradable memory module slot						√	√
	DDR3L-1600 single channel support						√	√
	Supports up to 8 GB of system RAM in the following configurations:						√	√
	• 8192-MB total system memory (8192×1)						√	√
	• 4096-MB total system memory (4096×1)						√	√
• 2048-MB total system memory (2048×1)						√	√	
Hard drives	Supports 6.35-cm (2.5-in) SATA hard drives in 9.5-mm (.37-in) and 7.2-mm (.28-in) thicknesses	√	√	√	√	√	√	√
	Support for SSD + HDD (not supported on Pentium/Celeron)	√	√	√	√	√		

Category	Description	7th gen Dis 530	7th gen Dis 520	7th gen UMA	6th gen Dis	6th gen UMA	Pent Dis	Pen/Cel UMA
	Support for m.2 SATA SSD	✓	✓	✓	✓	✓	✓	✓
	Single hard drive configurations:	✓	✓	✓	✓	✓	✓	✓
	• 2-TB, 5400 rpm, 9.5 mm or 7.2-mm	✓	✓	✓	✓	✓	✓	✓
	• 1-TB, 5400 rpm, 9.5 mm or 7.2 mm	✓	✓	✓	✓	✓	✓	✓
	• 500-GB, 5400 rpm, 7.0-mm	✓	✓	✓	✓	✓	✓	✓
	eMMC configurations:	✓	✓	✓	✓	✓	✓	✓
	• 128 GB	✓	✓	✓	✓	✓	✓	✓
	M.2 SATA-3 configurations (value):	✓	✓	✓	✓	✓	✓	✓
	• 256 GB	✓	✓	✓	✓	✓	✓	✓
	• 128 GB	✓	✓	✓	✓	✓	✓	✓
	M.2 SATA-3 configurations (TLC):	✓	✓	✓	✓	✓	✓	✓
	• 512 GB	✓	✓	✓	✓	✓	✓	✓
	• 256 GB	✓	✓	✓	✓	✓	✓	✓
	• 128 GB	✓	✓	✓	✓	✓	✓	✓
	Dual storage configurations	✓	✓	✓	✓	✓		
	• 256 GB Value SSD + 1 TB HDD	✓	✓	✓	✓	✓		
	• 128 GB Value SSD + 1 TB HDD	✓	✓	✓	✓	✓		
Optical drive	Fixed, serial ATA, 9.0-mm tray load	✓	✓	✓	✓	✓	✓	✓
	DVD+/-RW Double-Layer writer	✓	✓	✓	✓	✓	✓	✓
	Supports zero power optical drive	✓	✓	✓	✓	✓	✓	✓
	Supports M-disc	✓	✓	✓	✓	✓	✓	✓
	Supports configuration without optical drive	✓	✓	✓	✓	✓	✓	✓
Camera	HP TrueVision HD camera - activity LED, USB 2.0, HD BSI sensor, f2.0, 720p by 30 frames per second	✓	✓	✓	✓	✓	✓	✓
Mic	HP Camera – VGA camera, indicator LED, USB 2.0, f2.4, 480p by 30 frames per second	✓	✓	✓	✓	✓	✓	✓
	Single digital microphone	✓	✓	✓	✓	✓	✓	✓
Audio	Dual speakers	✓	✓	✓	✓	✓	✓	✓
	HP Audio Control	✓	✓	✓	✓	✓	✓	✓
Ethernet	Integrated 10/100/1000 network interface card (NIC)	✓	✓	✓	✓	✓	✓	✓
Wireless Network	Integrated wireless options with single antenna (M.2/PCIe):	✓	✓	✓	✓	✓	✓	✓
	Compatible with Miracast-certified devices	✓	✓	✓	✓	✓	✓	✓
	Support for the following WLAN formats:	✓	✓	✓	✓	✓	✓	✓

Category	Description	7th gen Dis 530	7th gen Dis 520	7th gen UMA	6th gen Dis	6th gen UMA	Pent Dis	Pen/Cel UMA
	<ul style="list-style-type: none"> Realtek RTL 8188EE 802.11 bgn 1x1 WiFi Adapter 	✓	✓	✓	✓	✓	✓	✓
	<ul style="list-style-type: none"> Realtek RTL8723DE 802.11 bgn 1x1 WiFi + BT 4.2 Combo Adapter 	✓	✓	✓	✓	✓	✓	✓
	<ul style="list-style-type: none"> Realtek RTL8723BE-VB 802.11b/g/n 1x1 Wi-Fi + BT4.0 Combo Adapter 	✓	✓	✓	✓	✓	✓	✓
	Integrated wireless options with dual antennas (M.2/PCIe):	✓	✓	✓	✓	✓	✓	✓
	Compatible with Miracast-certified devices	✓	✓	✓	✓	✓	✓	✓
	Support for the following WLAN formats:	✓	✓	✓	✓	✓	✓	✓
	<ul style="list-style-type: none"> Intel Dual Band Wireless-AC 3168 802.11 ac 1x1 WiFi + BT 4.2 Combo (non-vPro) 	✓	✓	✓	✓	✓	✓	✓
	<ul style="list-style-type: none"> Intel Dual Band Wireless-AC 7265 802.11AC 2x2 WiFi + BT 4.2 Combo Adapter (non-vPro) 	✓	✓	✓	✓	✓	✓	✓
External media card	HP Multi-Format Digital Media Reader	✓	✓	✓	✓	✓	✓	✓
	Support SD/SDHC/SDXC	✓	✓	✓	✓	✓	✓	✓
	Push-pull insertion/removal	✓	✓	✓	✓	✓	✓	✓
Internal Card	One M.2 slot for SSD	✓	✓	✓	✓	✓	✓	✓
	One M.2 slot for WLAN	✓	✓	✓	✓	✓	✓	✓
Ports	HDMI version 1.4b supporting 1920 ×1080 @ 60Hz	✓	✓	✓	✓	✓	✓	✓
	Hot Plug/unplug and auto detect for correct output to wide-aspect vs. standard aspect video	✓	✓	✓	✓	✓	✓	✓
	RJ-45 (Ethernet)	✓	✓	✓	✓	✓	✓	✓
	USB 3.0 (2 ports; left side)	✓	✓	✓	✓	✓	✓	✓
	USB 2.0 (1 right side)	✓	✓	✓	✓	✓	✓	✓
	AC Smart Pin adapter plug	✓	✓	✓	✓	✓	✓	✓
	Headphone/line out and microphone/line in combo jack	✓	✓	✓	✓	✓	✓	✓
Keyboard /pointing devices	Full-size textured, island style keyboard with numeric keypad	✓	✓	✓	✓	✓	✓	✓
	Full size, 3 coat, UV paint, island-style, backlit keyboard with numeric key pad	✓	✓	✓	✓	✓	✓	✓
	TouchPad with multi-touch gestures enabled	✓	✓	✓	✓	✓	✓	✓
	TouchPad taps enabled by default	✓	✓	✓	✓	✓	✓	✓
	TouchPad supports Modern Trackpad Gestures	✓	✓	✓	✓	✓	✓	✓







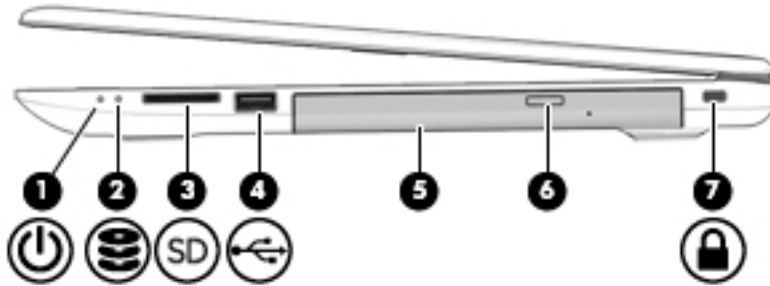

Category	Description	7th gen Dis 530	7th gen Dis 520	7th gen UMA	6th gen Dis	6th gen UMA	Pent Dis	Pen/Cel UMA
Power	AC adapters	√	√	√	√	√	√	√
	65-W EM	√	√	√	√	√	√	√
	65-W	√	√		√		√	
	45-W			√		√		√
	1 meter power cord	√	√	√	√	√	√	√
	Batteries	√	√	√	√	√	√	√
	4-cell, 41-Whr Li-ion battery	√	√	√	√	√	√	√
	3-cell, 31-Whr Li-ion battery			√		√		√
Security	fTPM 2.0	√	√	√	√	√	√	√
	Kensington Security Lock	√	√	√	√	√	√	√
Operating system	Preinstalled	√	√	√	√	√	√	√
	Windows 10	√	√	√	√	√	√	√
	Windows 10 Professional	√	√	√	√	√	√	√
	For Developed Market (ML):	√	√	√	√	√	√	√
	Windows 10 Home ML	√	√	√	√	√	√	√
	Windows 10 Home Plus ML	√	√	√	√	√	√	√
	For Emerging Market (EM/SL):	√	√	√	√	√	√	√
	Windows 10 Home EM/SL	√	√	√	√	√	√	√
	Windows 10 Home Plus EM/SL	√	√	√	√	√	√	√
	Windows 10 Home Value NB EM/SL						√	√
	Windows 10 Home Value NB Select Geo EM/SL						√	√
	For China Market:	√	√	√	√	√	√	√
	CPPP Windows 10 Home High End China Language Edition	√	√	√	√	√	√	√
	CPPP Windows 10 Home China Language Edition	√	√	√	√	√	√	√
	For APJ SEAP Market (EM/SL):	√	√	√	√	√	√	√
	SEAP Windows 10 Home EM/SL	√	√	√	√	√	√	√
	SEAP Windows 10 Home Plus	√	√	√	√	√	√	√
FreeDOS 2.0	√	√	√	√	√	√	√	
SEAP Windows 10 Home Value Notebook						√	√	
Service	End-user replaceable parts	√	√	√	√	√	√	√
	AC adapter	√	√	√	√	√	√	√

Category	Description	7th gen Dis 530	7th gen Dis 520	7th gen UMA	6th gen Dis	6th gen UMA	Pent Dis	Pen/Cel UMA
	Battery	√	√	√	√	√	√	√
	Optical drive	√	√	√	√	√	√	√

2 Getting to know your computer







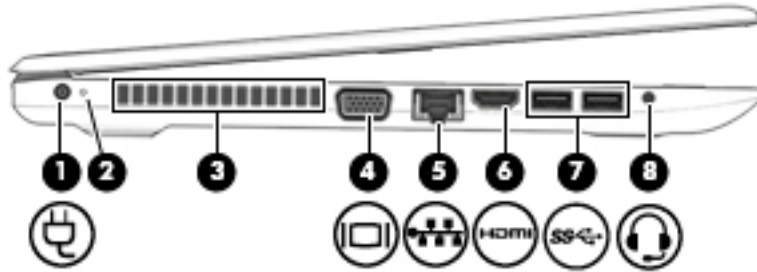

Right side



Component	Description
(1)  Power light	<ul style="list-style-type: none">On: The computer is on.Blinking: The computer is in the Sleep state, a power-saving state. The computer shuts off power to the display and other unneeded components.Off: The computer is off or in Hibernation. Hibernation is a power-saving state that uses the least amount of power.
(2)  Drive light	<ul style="list-style-type: none">Blinking white: The hard drive is being accessed.
(3)  Memory card reader	<p>Reads optional memory cards that enable you to store, manage, share, or access information.</p> <p>To insert a card:</p> <ol style="list-style-type: none">Hold the card label-side up, with connectors facing the computer.Insert the card into the memory card reader, and then press in on the card until it is firmly seated. <p>To remove a card:</p> <ul style="list-style-type: none"> Pull the card out of the memory card reader.
(4)  USB 2.0 port	Connects a USB device, such as a cell phone, camera, activity tracker, or smartwatch, and provides data transfer.
(5)  Optical drive (select products only)	Depending on your computer model, reads an optical disc or reads and writes to an optical disc. NOTE: For disc compatibility information, type <code>help</code> in the taskbar search box, select Help and Support , and then type <code>disc compatibility</code> in the search box.
(6)  Optical drive eject button (select products only)	Releases the optical drive disc tray.
(7)  Security cable slot	Attaches an optional security cable to the computer. NOTE: The security cable is designed to act as a deterrent, but it may not prevent the computer from being mishandled or stolen.

Left side



Component	Description
(1) 	Power connector Connects an AC adapter.
(2) 	AC adapter and battery light <ul style="list-style-type: none"> White: The AC adapter is connected and the battery is fully charged. Blinking white: The AC adapter is disconnected and the battery has reached a low battery level. Amber: The AC adapter is connected and the battery is charging. Off: The battery is not charging.
(3) 	Vent Enables airflow to cool internal components. NOTE: The computer fan starts up automatically to cool internal components and prevent overheating. It is normal for the internal fan to cycle on and off during routine operation.
(4) 	External monitor port (select products only) Connects an external VGA monitor or projector.
(5) 	RJ-45 (network) jack/status lights <ul style="list-style-type: none"> White: The network is connected. Amber: Activity is occurring on the network.
(6) 	HDMI port Connects an optional video or audio device, such as a high-definition television, any compatible digital or audio component, or a high-speed High-Definition Multimedia Interface (HDMI) device.
(7) 	USB 3.x SuperSpeed ports (2) Connect a USB device, such as a cell phone, camera, activity tracker, or smartwatch, and provides high-speed data transfer.
(8) 	Audio-out (headphone)/Audio-in (microphone) combo jack Connects optional powered stereo speakers, headphones, earbuds, a headset, or a television audio cable. Also connects an optional headset microphone. This jack does not support optional standalone microphones. WARNING! To reduce the risk of personal injury, adjust the volume before putting on headphones, earbuds, or a headset. For additional safety information, refer to the <i>Regulatory, Safety, and Environmental Notices</i> . To access this guide: <ul style="list-style-type: none"> ▲ Select the Start button, select HP Help and Support, and then select HP Documentation. NOTE: When a device is connected to the jack, the computer speakers are disabled.

Display

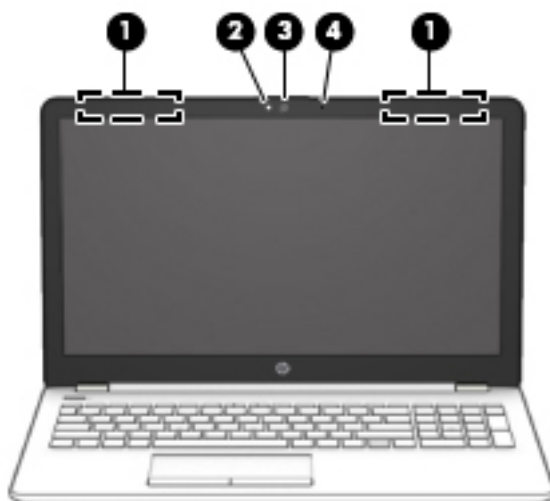

Component	Description
(1) WLAN antennas*	Send and receive wireless signals to communicate with wireless local area networks (WLANs).
(2) Camera light	On: The camera is in use.
(3) Camera	Allows you to video chat, record video, and record still images.
(4) Internal microphone	Records sound.

*The antennas are not visible from the outside of the computer, and antenna location varies. For optimal transmission, keep the areas immediately around the antennas free from obstructions.

For wireless regulatory notices, see the section of the *Regulatory, Safety, and Environmental Notices* that applies to your country or region.

To access this guide:

- ▲ Select the **Start** button, select **HP Help and Support**, and then select **HP Documentation**.

Keyboard area

TouchPad

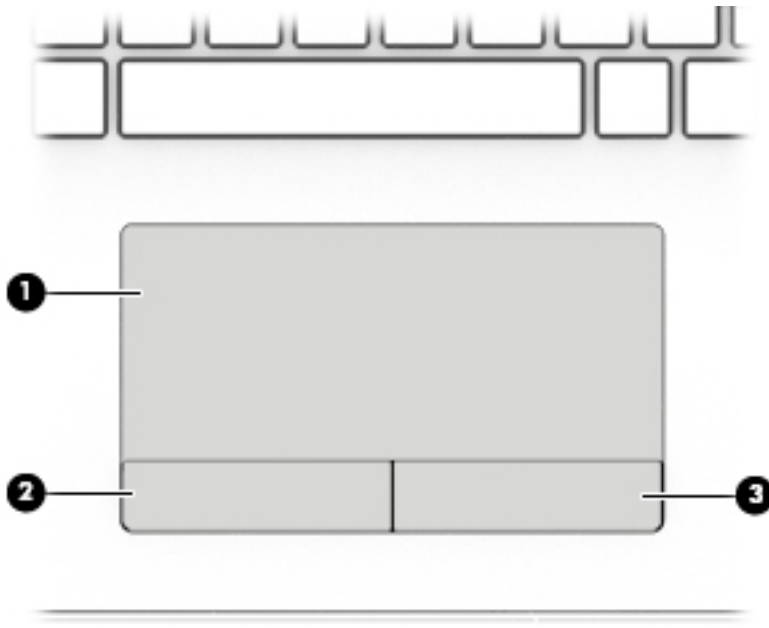

Component	Description
(1) TouchPad zone	Reads your finger gestures to move the pointer or activate items on the screen.
(2) Left TouchPad button	Functions like the left button on an external mouse.
(3) Right TouchPad button	Functions like the right button on an external mouse.

Lights

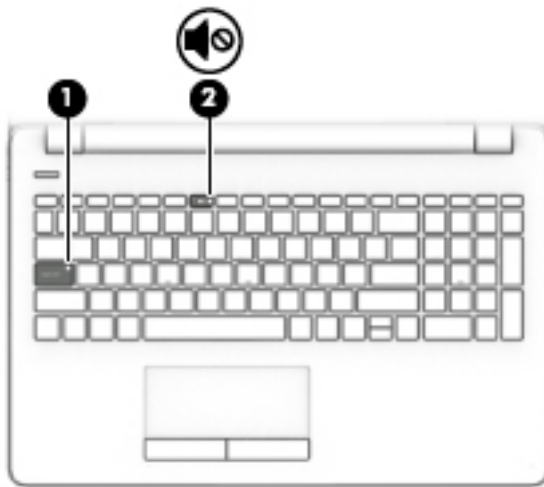

Component	Description
(1) Caps lock light	On: Caps lock is on, which switches the key input to all capital letters.
(2)  Mute light	<ul style="list-style-type: none">• Amber: Computer sound is off.• Off: Computer sound is on.

Button

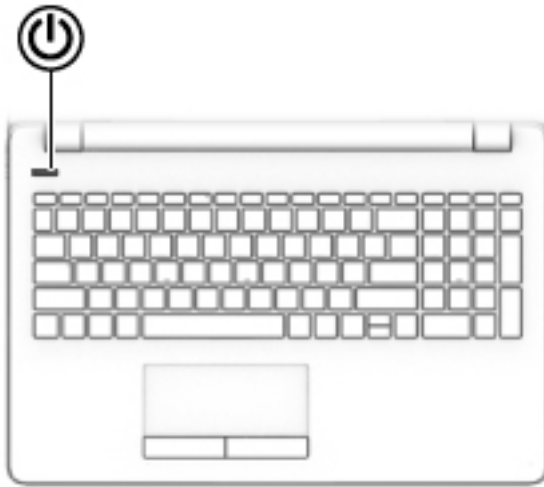

Component	Description
 Power button	<ul style="list-style-type: none">• When the computer is off, press the button to turn on the computer.• When the computer is on, press the button briefly to initiate Sleep.• When the computer is in the Sleep state, press the button briefly to exit Sleep.• When the computer is in Hibernation, press the button briefly to exit Hibernation. <p>CAUTION: Pressing and holding down the power button results in the loss of unsaved information.</p> <p>If the computer has stopped responding and shutdown procedures are ineffective, press and hold the power button down for at least 5 seconds to turn off the computer.</p> <p>To learn more about your power settings, see your power options.</p> <ul style="list-style-type: none">▲ Type <code>power</code> in the taskbar search box, and then select Power & sleep settings. <p>– or –</p> <p>Right-click the Start button, and then select Power Options.</p>

Special keys

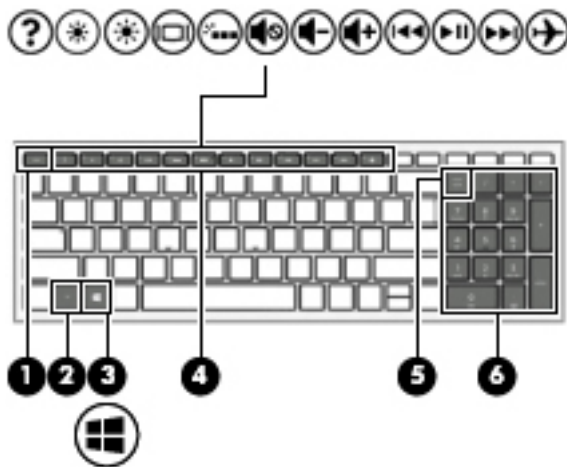













Component	Description
(1) esc key	Displays system information when pressed in combination with the fn key.
(2) fn key	Executes specific functions when pressed in combination with another key.
(3)  Windows key	Opens the Start menu. NOTE: Pressing the Windows key again will close the Start menu.
(4) Action keys	Execute frequently used system functions. NOTE: On select products, the f5 action key turns the keyboard backlight feature off or on.
(5) num lock key	Alternates between the navigational and numeric functions on the integrated numeric keypad.
(6) Integrated numeric keypad	A separate keypad to the right of the alphabet keyboard. When num lock is pressed, the keypad can be used like an external numeric keypad. NOTE: If the keypad function is active when the computer is turned off, that function is reinstated when the computer is turned back on.

Action keys



An action key performs the function indicated by the icon on the key. To determine which keys are on your product, see [Special keys on page 13](#).

▲ To use an action key, press and hold the key.

Icon	Description
	Opens the Get started app.
	Decreases the screen brightness incrementally as long as you hold down the key.
	Increases the screen brightness incrementally as long as you hold down the key.
	Switches the screen image between display devices connected to the system. For example, if a monitor is connected to the computer, repeatedly pressing this key alternates the screen image from the computer display to the monitor display to a simultaneous display on both the computer and the monitor.
	Turns the keyboard backlight off or on. NOTE: To conserve battery power, turn off this feature.
	Mutes or restores speaker sound.
	Decreases speaker volume incrementally while you hold down the key.
	Increases speaker volume incrementally while you hold down the key.
	Plays the previous track of an audio CD or the previous section of a DVD or a Blu-ray Disc (BD).
	Starts, pauses, or resumes playback of an audio CD, a DVD, or a BD.
	Plays the next track of an audio CD or the next section of a DVD or a BD.
	Turns the airplane mode and wireless feature on or off. NOTE: The airplane mode key is also referred to as the wireless button. NOTE: A wireless network must be set up before a wireless connection is possible.

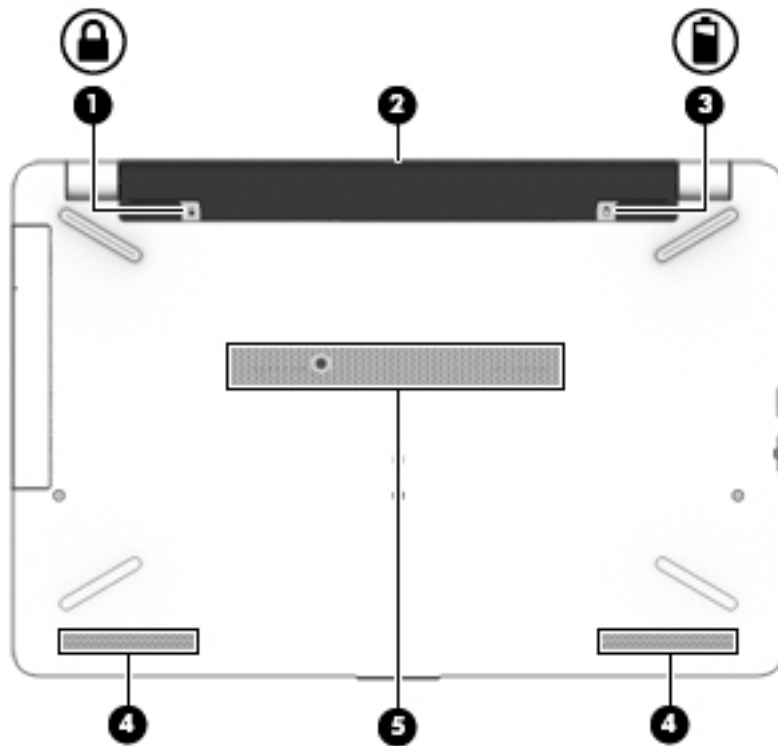
Bottom



Component	Description
(1) 	Battery lock Locks the battery in the battery bay.
(2)	Battery bay Holds the battery.
(3) 	Battery release latch Releases the battery.
(4)	Speakers (2) Produce sound.
(5)	Vent Enables airflow to cool internal components. NOTE: The computer fan starts up automatically to cool internal components and prevent overheating. It is normal for the internal fan to cycle on and off during routine operation.

Labels

The labels affixed to the computer provide information you may need when you troubleshoot system problems or travel internationally with the computer.

IMPORTANT: Check the following locations for the labels described in this section: the bottom of the computer, inside the battery bay, under the service door, or on the back of the display.

- Service label—Provides important information to identify your computer. When contacting support, you will probably be asked for the serial number, and possibly for the product number or the model number. Locate these numbers before you contact support.

Your service label will resemble one of the examples shown below. Refer to the illustration that most closely matches the service label on your computer.

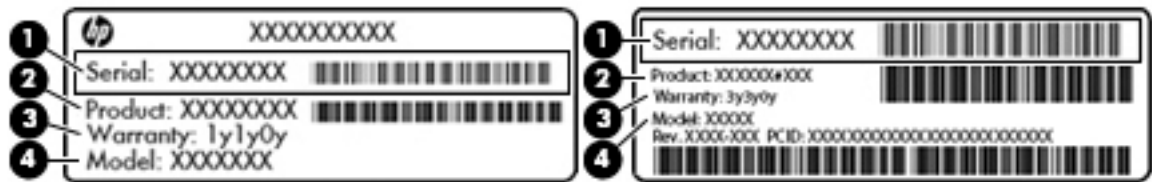

Component

- (1) Serial number
- (2) Product number
- (3) Warranty period
- (4) Model number (select products only)

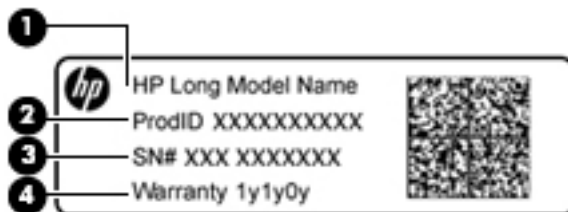

Component

- (1) Model name (select products only)
- (2) Product number
- (3) Serial number
- (4) Warranty period

- Regulatory label(s)—Provide(s) regulatory information about the computer.
- Wireless certification label(s)—Provide(s) information about optional wireless devices and the approval markings for the countries or regions in which the devices have been approved for use.

3 Illustrated parts catalog

Computer major components

 **NOTE:** HP continually improves and changes product parts. For complete and current information on supported parts for your computer, go to <http://partsurfer.hp.com>, select your country or region, and then follow the on-screen instructions.

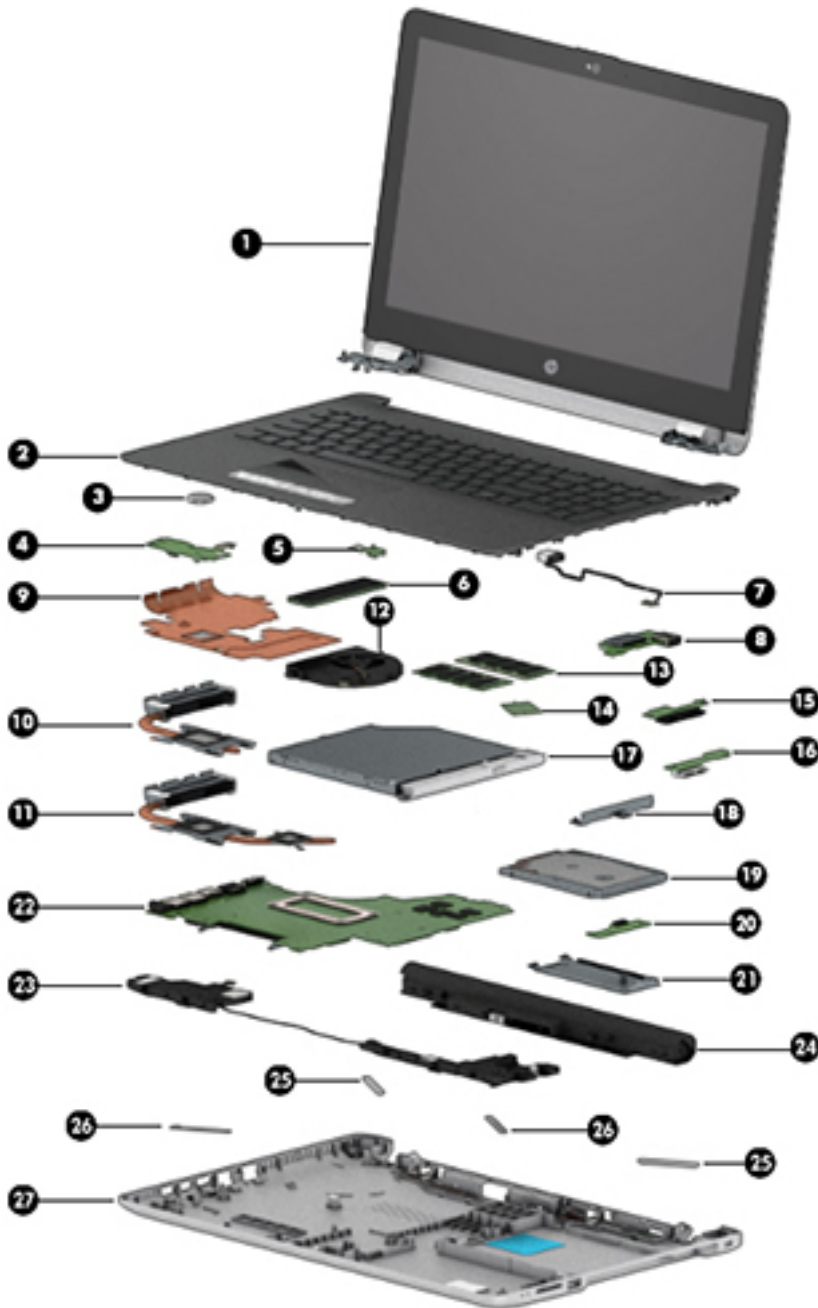

Item	Component	Spare part number
(1)	Display assembly (touch or non-touch) NOTE: For display assembly spare part information, see Display assembly subcomponents on page 22 .	not spared
(2)	Top cover/keyboard NOTE: For a detailed list of keyboard country codes, see Top cover/keyboard on page 85 .	
	Models in the following color: jet black	925008-xxx
	Models in the following color: snow white	925009-xxx
	Models without a backlight in the following colors: pike silver, silk gold, empress red, smoke gray, marine blue, amethyst purple, pale mint, sparkling black	925010-xxx
	Models with a backlight in the following colors: pike silver, silk gold, empress red, smoke gray, marine blue, amethyst purple, pale mint, sparkling black NOTE: Available only for the following countries and regions: the United States (-001), India (-002), English/French Canada (-DB1).	925011-xxx
	Models without a backlight for use in the United States in the following color: rose gold	925564-001
	Models with a backlight for use in the United States in the following color: rose gold	925565-001
(3)	RTC battery	922847-001
(4)	Touchpad button board	
	For use in models without a solid-state drive	924993-001
	For use in models with a solid-state drive	934256-001
(5)	Power button board	924994-001
(6)	Solid-state drive, M.2	
	512 GB	763008-017
	256 GB	865902-017
	128 GB	827560-048
	eMMC module, 128 GB (not illustrated)	833958-005
(7)	Power connector cable	931613-001
(8)	USB board	924991-001
	Heat sink assembly (includes replacement thermal materials)	
(9)	For use in models with UMA graphics and Intel Pentium or Celeron processors	924977-001
(10)	For use in models with UMA graphics memory and 6th or 7th generation Intel Core processors	924975-001
(11)	For use in models with discrete graphics memory and Intel Pentium or Celeron processors	924978-001
(11)	For use in models with discrete graphics memory and 6th or 7th generation Intel Core processors	924976-001
(12)	Fan	925012-001
(13)	Memory module	
	PC3L-1600	
	For use in models with Intel Pentium and Celeron processors	

Item	Component	Spare part number
	<ul style="list-style-type: none"> 8-GB 	693374-005
	<ul style="list-style-type: none"> 4 GB 	691740-005
	<ul style="list-style-type: none"> 2 GB 	691739-005
	DDR4-2400	
	For use in models with 6th and 7th generation Intel Core processors	
	<ul style="list-style-type: none"> 8-GB 	862398-855
	<ul style="list-style-type: none"> 4 GB 	862397-855
	<ul style="list-style-type: none"> 2 GB 	864271-855
(14)	WLAN module	
	Intel Dual Band Wireless-AC 7265 802.11AC 2x2 WiFi + BT 4.2 Combo Adapter (non-vPro)	901229-855
	Realtek RTL8723DE 802.11 bgn 1x1 WiFi + BT 4.2 Combo Adapter	927230-855
	Realtek RTL8723BE-VB 802.11b/g/n 1x1 Wi-Fi + BT4.0 Combo Adapter	855106-855
	Realtek RTL 8188EE 802.11 bgn 1x1 WiFi Adapter	927235-855
	Intel Dual Band Wireless-AC 3168 802.11 ac 1x1 WiFi + BT 4.2 Combo Adapter	863934-855
(15)	Hard drive connector board	924995-001
(16)	Optical drive connector board	924990-001
(17)	Optical drive (DVD+/-RW Double-Layer SuperMulti)	920417-008
(18)	Hard drive bracket	924980-001
(19)	Hard drive, 2.5 inch (does not include bracket, connector board, or cable)	
	<ul style="list-style-type: none"> 2-TB, 5400-rpm 	912487-855
	<ul style="list-style-type: none"> 1-TB, 5400-rpm 	778192-005
	<ul style="list-style-type: none"> 500-GB, 5400-rpm 	778186-005
(20)	Solid-state drive board	924992-001
(21)	Solid-state drive bracket	924981-001
(22)	System board (includes replacement thermal materials)	
	All system boards use the following part numbers:	
	xxxxxx-001: Non-Windows operating systems	
	xxxxxx-601: Windows 10 operating system	
	For use in models with discrete graphics memory	
	<ul style="list-style-type: none"> Intel Core i7-7500U processor and 4 GB of discrete graphics memory 	924759-xx1
	<ul style="list-style-type: none"> Intel Core i7-7500U processor and 2 GB of discrete graphics memory 	924757-xx1
	<ul style="list-style-type: none"> Intel Core i5-7200U processor and 4 GB of discrete graphics memory 	924758-xx1
	<ul style="list-style-type: none"> Intel Core i5-7200U processor and 2 GB of discrete graphics memory 	924756-xx1
	<ul style="list-style-type: none"> Intel Core i3-6006U processor and 2 GB of discrete graphics memory 	924755-xx1

Item	Component	Spare part number
	<ul style="list-style-type: none"> Intel Pentium N3710 processor and 2 GB of discrete graphics memory 	924760-xx1
	For use in models with UMA graphics memory:	
	<ul style="list-style-type: none"> Intel Core i7-7500U processor 	924752-xx1
	<ul style="list-style-type: none"> Intel Core i5-7200U processor 	924751-xx1
	<ul style="list-style-type: none"> Intel Core i3-7100U processor 	924749-xx1
	<ul style="list-style-type: none"> Intel Core i3-6006U processor 	924750-xx1
	<ul style="list-style-type: none"> Intel Pentium N3710 processor 	924754-xx1
	<ul style="list-style-type: none"> Intel Celeron N3060 processor 	924753-xx1
(23)	Speakers (includes left and right speakers and cable)	925306-001
(24)	Battery	
	4-cell, 41-Whr, 2.8-Ah Li-ion battery	919701-850
	3-cell, 31-Whr, 2.8-Ah Li-ion battery	919700-850
(25)	Rubber Kit (includes upper feet)	
	Asteroid silver	931599-001
	Dark ash silver	931600-01
	Silk gold	924998-001
	Marine blue	925000-001
	Amethyst purple	925001-001
	Pale mint	925002-001
	Empress red	926298-001
	Rose gold	926299-001
(26)	Rubber Kit (includes lower feet)	
	Asteroid silver	931601-001
	Dark ash silver	931602-001
	Silk gold	925299-001
	Marine blue	925301-001
	Amethyst purple	925302-001
	Pale mint	925303-001
	Empress red	926300-001
	Rose gold	926301-001
(27)	Bottom cover	
	For use in models with an optical drive:	
	<ul style="list-style-type: none"> Pike silver 	924901-001
	<ul style="list-style-type: none"> Silk gold 	924902-001

Item	Component	Spare part number
	• Smoke gray	924903-001
	• Marine blue	924904-001
	• Amethyst purple	924905-001
	• Pale mint	924906-001
	• Jet black	924907-001
	• Snow white	924908-001
	• Empress red	924913-001
	• Rose gold	924914-001
	For use in models without an optical drive:	
	• Pike silver	924909-001
	• Silk gold	924910-001
	• Smoke gray	924911-001
	• Marine blue	924912-001
	• Jet black	924915-001
	• Snow white	924916-001
	• Empress red	926295-001

Display assembly subcomponents

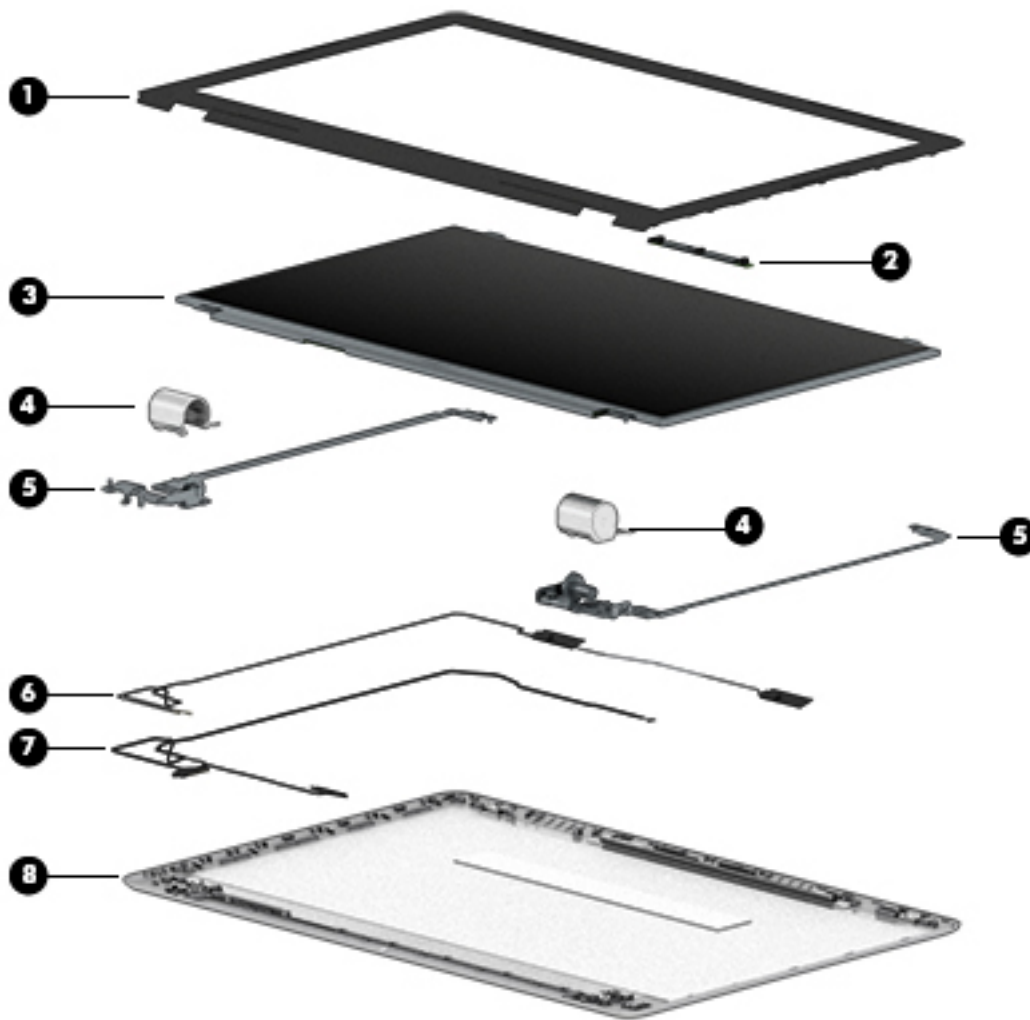

Item	Component	Spare part number
(1)	Display bezel	924925-001
(2)	Camera/microphone module	
	HD	919471-006
	VGA	919472-006
(3)	Raw display panel (39.6-cm [15.6-in])	
	FHD, anti glare	798933-011
	HD, BrightView, touch	809612-013
	HD, BrightView, non-touch	847654-007
	HD, anti glare	909185-005
(4)	Hinge cover	
	Left, silver, for use in full featured models	924982-001

Item	Component	Spare part number
	Right, silver, for use in full featured models	924983-001
	Left, black, for use in defeatured models	924984-001
	Right, black, for use in defeatured models	924985-001
	Left, white, for use in defeatured models	924986-001
	Right, white, for use in defeatured models	924987-001
	Left, rose gold, for use in full featured models	932782-001
	Right, rose gold, for use in full featured models	932783-001
(5)	Hinge Kit (left and right)	925297-001
(6)	Antenna (includes wireless antenna cable and transceiver)	925032-001
(7)	Display cable (includes display panel cable and camera/microphone cable)	
	Non-touch screen	924930-001
	Touch screen, HD	924932-001
(8)	Display enclosure:	
	Pike silver	924892-001
	Silk gold	924893-001
	Smoke gray	924894-001
	Marine blue	924895-001
	Amethyst purple	924896-001
	Pale mint	924897-001
	Sparkling black	924898-001
	Jet black	924899-001
	Snow white	924900-001
	Empress red	926293-001
	Rose gold	926294-001

Cables

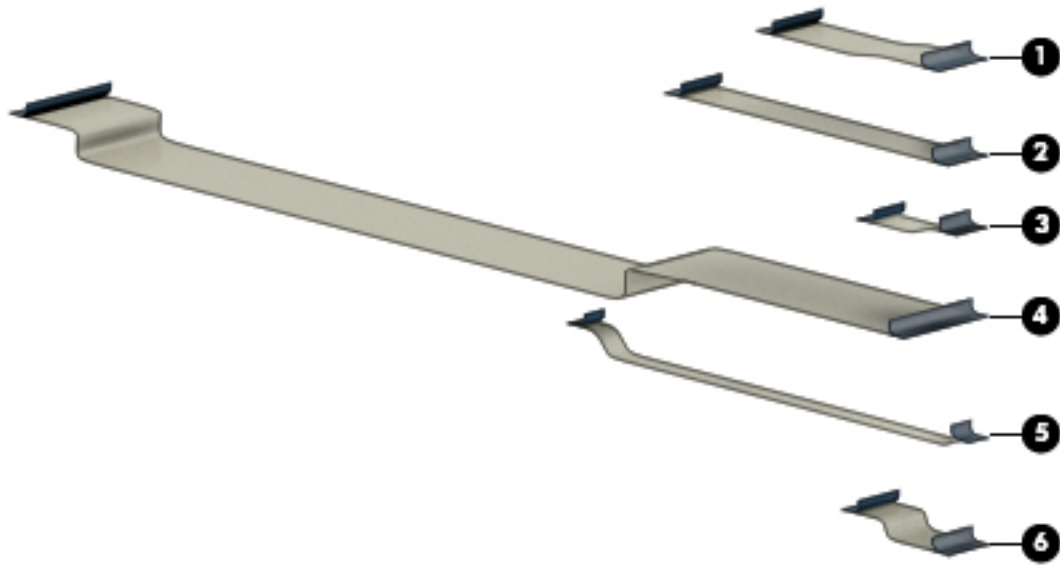

Item	Component	Spare part number
(1)	Hard drive connector board cable	924927-001
(2)	TouchPad button board cable	924934-001
(3)	TouchPad cable	924928-001
(4)	USB board cable	924929-001
(5)	Power button board cable	924933-001
(6)	Optical drive connector board cable	924926-001

Mass storage devices

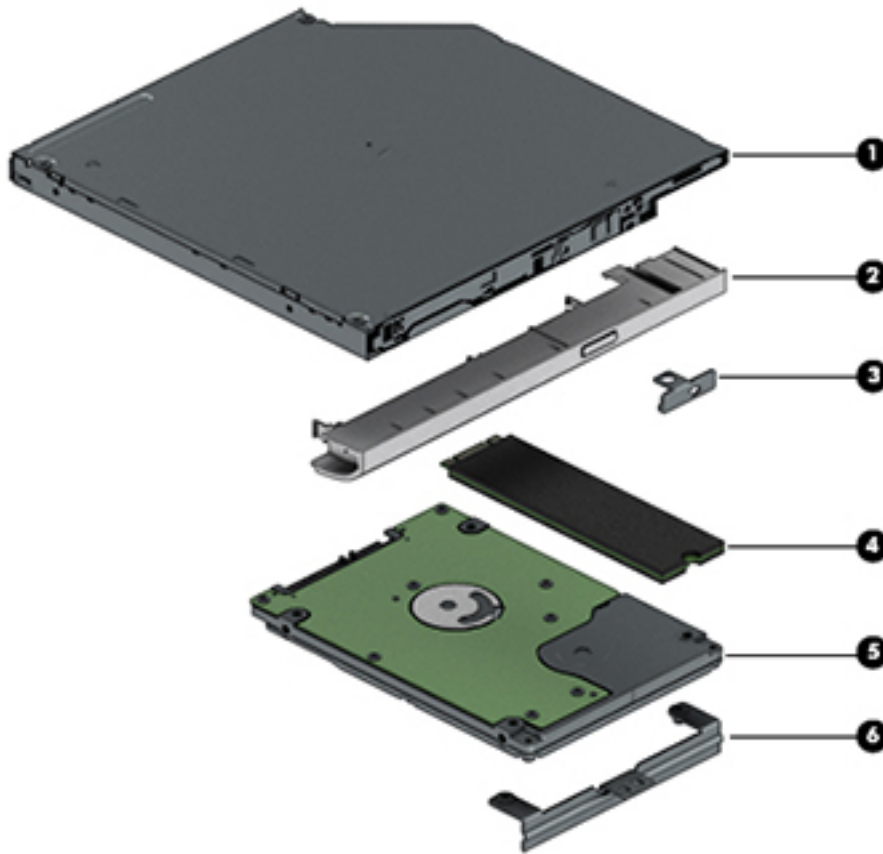

Item	Component	Spare part number
(1)	Optical drive (DVD+/-RW Double-Layer SuperMulti)	920417-008
(2)	Optical drive bezel	
	Pike silver	924917-001
	Silk gold	924918-001
	Smoke gray	924919-001
	Marine blue	924920-001
	Amethyst purple	924921-001
	Pale mint	924922-001
	Jet black	924923-001
	Snow white	924924-001
	Empress red	924296-001
	Rose gold	924297-001
(3)	Optical drive bracket	924979-001
(4)	Solid-state drive, M.2	
	512 GB	763008-017

Item	Component	Spare part number
	256 GB	865902-017
	128 GB	827560-048
(5)	Hard drive , SATA; does not include brackets, connector board, or cable):	
	2-TB, 5400-rpm	912487-855
	1-TB, 5400-rpm	778192-005
	500-GB, 5400-rpm	778186-005
(6)	Hard drive bracket	924980-001

Miscellaneous parts

Component	Spare part number
HP Smart AC adapter (4.5 mm, non-PFC)	
65-W	710412-001
65-W, for use in Argentina	710340-850
65-W, EM, for use in India and the People's Republic of China	913691-850
45-W	741553-850
45-W, for use in Argentina	741553-852
Power cord:	
For use in Argentina	920688-003
For use in Australia	920688-011
For use in Denmark	920688-007
For use in Europe	920688-005
For use in India	920688-016
For use in Israel	920688-008
For use in Italy	920688-002
For use in Japan	920688-017
For use in North America	920688-001
For use in the People's Republic of China	920688-014
For use in South Africa	920688-010
For use in South Korea	920688-013
For use in Switzerland	920688-009
For use in Taiwan	920688-015
For use in Thailand	920688-012
For use in the United Kingdom	920688-006

Component	Spare part number
Power adapter	
For use in Japan	226768-001
Screw Kit	
Black	925005-001
Silver	925006-001
HP HDMI to VGA Adapter	701943-001

4 Removal and replacement procedures preliminary requirements

Tools required

You will need the following tools to complete the removal and replacement procedures:

- Flat-bladed screwdriver
- Magnetic screwdriver
- Phillips P0 and P1 screwdrivers

Service considerations

The following sections include some of the considerations that you must keep in mind during disassembly and assembly procedures.

 **NOTE:** As you remove each subassembly from the computer, place the subassembly (and all accompanying screws) away from the work area to prevent damage.

Plastic parts

 **CAUTION:** Using excessive force during disassembly and reassembly can damage plastic parts. Use care when handling the plastic parts. Apply pressure only at the points designated in the maintenance instructions.

Cables and connectors

 **CAUTION:** When servicing the computer, be sure that cables are placed in their proper locations during the reassembly process. Improper cable placement can damage the computer.

Cables must be handled with extreme care to avoid damage. Apply only the tension required to unseat or seat the cables during removal and insertion. Handle cables by the connector whenever possible. In all cases, avoid bending, twisting, or tearing cables. Be sure that cables are routed in such a way that they cannot be caught or snagged by parts being removed or replaced. Handle flex cables with extreme care; these cables tear easily.

Drive handling

⚠ CAUTION: Drives are fragile components that must be handled with care. To prevent damage to the computer, damage to a drive, or loss of information, observe these precautions:

Before removing or inserting a hard drive, shut down the computer. If you are unsure whether the computer is off or in Hibernation, turn the computer on, and then shut it down through the operating system.

Before handling a drive, be sure that you are discharged of static electricity. While handling a drive, avoid touching the connector.

Before removing a diskette drive or optical drive, be sure that a diskette or disc is not in the drive and be sure that the optical drive tray is closed.

Handle drives on surfaces covered with at least one inch of shock-proof foam.

Avoid dropping drives from any height onto any surface.

After removing a hard drive, an optical drive, or a diskette drive, place it in a static-proof bag.

Avoid exposing an internal hard drive to products that have magnetic fields, such as monitors or speakers.

Avoid exposing a drive to temperature extremes or liquids.

If a drive must be mailed, place the drive in a bubble pack mailer or other suitable form of protective packaging and label the package "FRAGILE."

Grounding guidelines

Electrostatic discharge damage

Electronic components are sensitive to electrostatic discharge (ESD). Circuitry design and structure determine the degree of sensitivity. Networks built into many integrated circuits provide some protection, but in many cases, ESD contains enough power to alter device parameters or melt silicon junctions.

A discharge of static electricity from a finger or other conductor can destroy static-sensitive devices or microcircuitry. Even if the spark is neither felt nor heard, damage may have occurred.

An electronic device exposed to ESD may not be affected at all and can work perfectly throughout a normal cycle. Or the device may function normally for a while, then degrade in the internal layers, reducing its life expectancy.

⚠ CAUTION: To prevent damage to the computer when you are removing or installing internal components, observe these precautions:

Keep components in their electrostatic-safe containers until you are ready to install them.

Before touching an electronic component, discharge static electricity by using the guidelines described in this section.

Avoid touching pins, leads, and circuitry. Handle electronic components as little as possible.

If you remove a component, place it in an electrostatic-safe container.

The following table shows how humidity affects the electrostatic voltage levels generated by different activities.

⚠ CAUTION: A product can be degraded by as little as 700 V.

Typical electrostatic voltage levels			
Event	Relative humidity		
	10%	40%	55%
Walking across carpet	35,000 V	15,000 V	7,500 V
Walking across vinyl floor	12,000 V	5,000 V	3,000 V
Motions of bench worker	6,000 V	800 V	400 V
Removing DIPs from plastic tube	2,000 V	700 V	400 V
Removing DIPs from vinyl tray	11,500 V	4,000 V	2,000 V
Removing DIPs from Styrofoam	14,500 V	5,000 V	3,500 V
Removing bubble pack from PCB	26,500 V	20,000 V	7,000 V
Packing PCBs in foam-lined box	21,000 V	11,000 V	5,000 V

Packaging and transporting guidelines

Follow these grounding guidelines when packaging and transporting equipment:

- To avoid hand contact, transport products in static-safe tubes, bags, or boxes.
- Protect ESD-sensitive parts and assemblies with conductive or approved containers or packaging.
- Keep ESD-sensitive parts in their containers until the parts arrive at static-free workstations.
- Place items on a grounded surface before removing items from their containers.
- Always be properly grounded when touching a component or assembly.
- Store reusable ESD-sensitive parts from assemblies in protective packaging or non-conductive foam.
- Use transporters and conveyors made of antistatic belts and roller bushings. Be sure that mechanized equipment used for moving materials is wired to ground and that proper materials are selected to avoid static charging. When grounding is not possible, use an ionizer to dissipate electric charges.

Workstation guidelines

Follow these grounding workstation guidelines:

- Cover the workstation with approved static-shielding material.
- Use a wrist strap connected to a properly grounded work surface and use properly grounded tools and equipment.
- Use conductive field service tools, such as cutters, screwdrivers, and vacuums.
- When fixtures must directly contact dissipative surfaces, use fixtures made only of static-safe materials.
- Keep the work area free of nonconductive materials, such as ordinary plastic assembly aids and Styrofoam.
- Handle ESD-sensitive components, parts, and assemblies by the case or PCM laminate. Handle these items only at static-free workstations.
- Avoid contact with pins, leads, or circuitry.
- Turn off power and input signals before inserting or removing connectors or test equipment.

Equipment guidelines

Grounding equipment must include either a wrist strap or a foot strap at a grounded workstation.

- When seated, wear a wrist strap connected to a grounded system. Wrist straps are flexible straps with a minimum of one megohm $\pm 10\%$ resistance in the ground cords. To provide proper ground, wear a strap snugly against the skin at all times. On grounded mats with banana-plug connectors, use alligator clips to connect a wrist strap.
- When standing, use foot straps and a grounded floor mat. Foot straps (heel, toe, or boot straps) can be used at standing workstations and are compatible with most types of shoes or boots. On conductive floors or dissipative floor mats, use foot straps on both feet with a minimum of one megohm resistance between the operator and ground. To be effective, the conductive must be worn in contact with the skin.

The following grounding equipment is recommended to prevent electrostatic damage:

- Antistatic tape
- Antistatic smocks, aprons, and sleeve protectors
- Conductive bins and other assembly or soldering aids
- Nonconductive foam
- Conductive tabletop workstations with ground cords of one megohm resistance
- Static-dissipative tables or floor mats with hard ties to the ground
- Field service kits
- Static awareness labels
- Material-handling packages
- Nonconductive plastic bags, tubes, or boxes
- Metal tote boxes
- Electrostatic voltage levels and protective materials

The following table lists the shielding protection provided by antistatic bags and floor mats.

Material	Use	Voltage protection level
Antistatic plastics	Bags	1,500 V
Carbon-loaded plastic	Floor mats	7,500 V
Metallized laminate	Floor mats	5,000 V

5 Removal and replacement procedures for Customer Self-Repair parts

 **CAUTION:** The Customer Self-Repair program is not available in all locations. Installing a part not supported by the Customer Self-Repair program may void your warranty. Check your warranty to determine if Customer Self-Repair is supported in your location.

 **NOTE:** HP continually improves and changes product parts. For complete and current information on supported parts for your computer, go to <http://partsurfer.hp.com>, select your country or region, and then follow the on-screen instructions.

Component replacement procedures

 **NOTE:** Please read and follow the procedures described here to access and replace Customer Self-Repair parts successfully.

 **NOTE:** Details about your computer, including model, serial number, product key, and length of warranty, are on the service tag at the bottom of your computer. See [Labels on page 16](#) for details.

This chapter provides removal and replacement procedures for Customer Self-Repair parts.

There are as many as 3 screws that must be removed, replaced, or loosened when servicing Customer Self-Repair parts. Make special note of each screw size and location during removal and replacement.

Battery

Description	Spare part number
4-cell, 41-Whr, 2.8-Ah Li-ion battery	919701-850
3-cell, 31-Whr, 2.8-Ah Li-ion battery	919700-850

Before disassembling the computer, follow these steps:

1. Shut down the computer. If you are unsure whether the computer is off or in Hibernation, turn the computer on, and then shut it down through the operating system.
2. Disconnect all external devices connected to the computer.
3. Disconnect the power from the computer by first unplugging the power cord from the AC outlet and then unplugging the AC adapter from the computer.

To remove the battery:

1. Position the computer upside down on a flat surface.
2. Slide the battery lock latch **(1)** to unlock the battery, and then slide the battery release latch **(2)** to release the battery.



NOTE: The battery release latch automatically returns to its original position.

3. Remove the battery **(3)** from the computer.

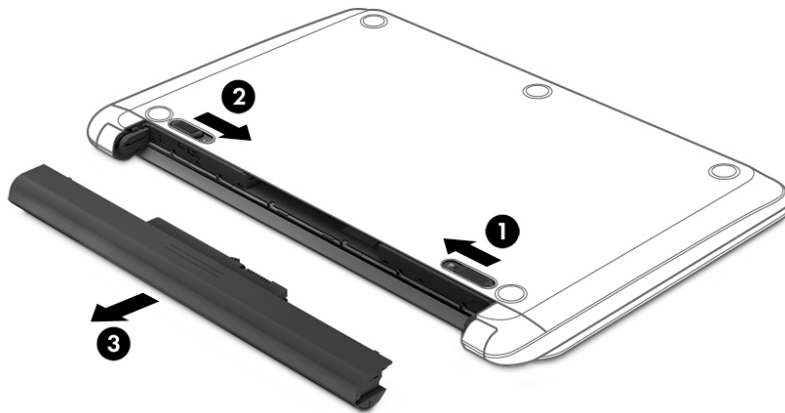

Optical drive

Description	Spare part number
DVD+/-RW Double-Layer SuperMulti Drive	920417-008
Optical drive bracket	924979-001
Optical drive bezel	
Pike silver	924917-001
Silk gold	924918-001
Smoke gray	924919-001
Marine blue	924920-001
Amethyst purple	924921-001
Pale mint	924922-001
Jet black	924923-001
Snow white	924924-001
Empress red	924296-001
Rose gold	924297-001

Before removing the optical drive, follow these steps:

1. Shut down the computer. If you are unsure whether the computer is off or in Hibernation, turn the computer on, and then shut it down through the operating system.
2. Disconnect all external devices connected to the computer.
3. Disconnect the power from the computer by first unplugging the power cord from the AC outlet and then unplugging the AC adapter from the computer.
4. Remove the battery (see [Battery on page 34](#)).

To remove the optical drive:

1. Remove the Phillips PM2.5×11.0 screw **(1)** that secures the optical drive to the computer.

2. Remove the optical drive **(2)** by sliding it out of the optical drive bay.

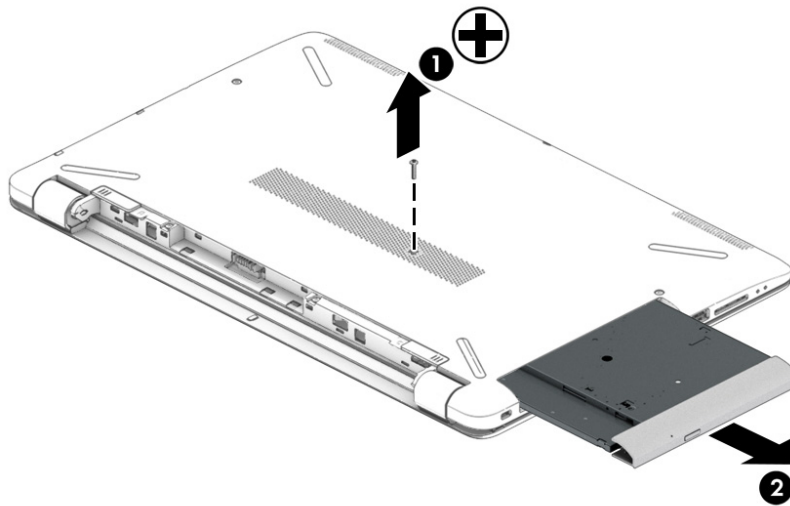

3. If it is necessary to remove the optical drive bezel, insert a paper clip into the release hole **(1)** to disengage the bezel. Press the tab **(2)** to release the bezel from the drive. Rotate the side of the bezel **(3)**, and then remove it **(4)**.

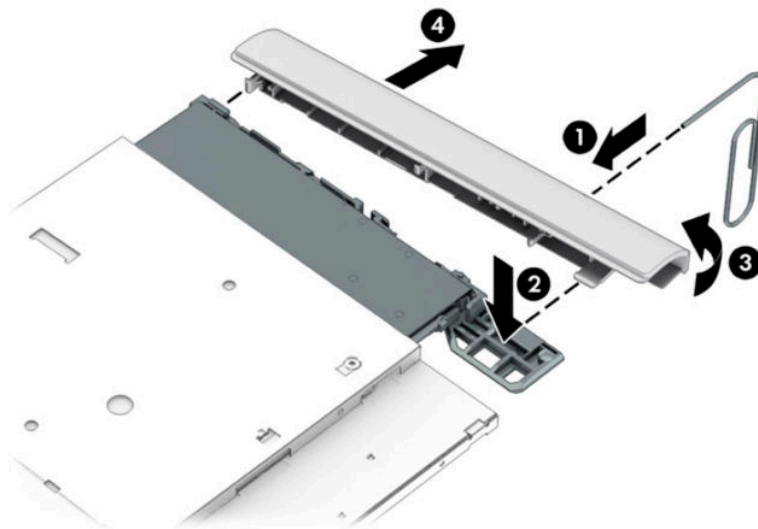

4. If it is necessary to replace the bracket on the rear of the optical drive, remove the Phillips PM2.0×2.5 screw **(1)** that secures the bracket to the drive, and then remove the bracket **(2)**.

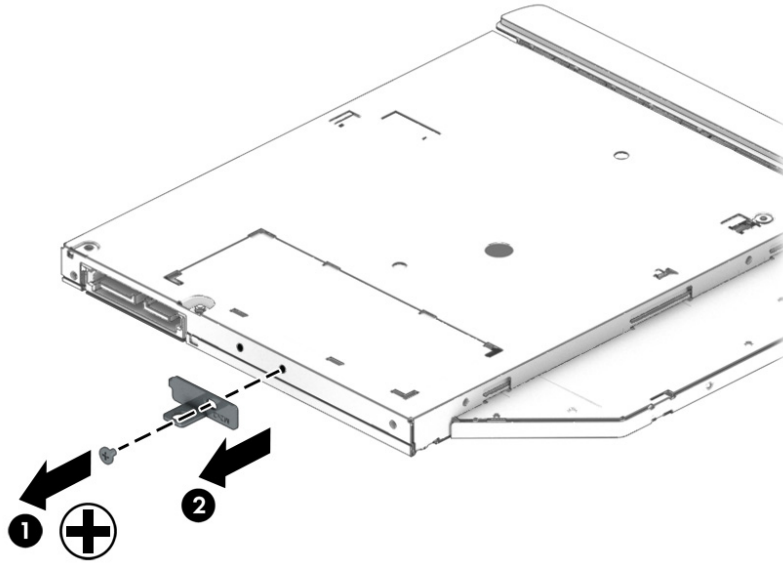

Reverse this procedure to reassemble and install the optical drive.

6 Removal and replacement procedures for Authorized Service Provider parts

 **CAUTION:** Components described in this chapter should only be accessed by an authorized service provider. Accessing these parts can damage the computer or void the warranty.

 **NOTE:** HP continually improves and changes product parts. For complete and current information on supported parts for your computer, go to <http://partsurfer.hp.com>, select your country or region, and then follow the on-screen instructions.

Component replacement procedures

 **NOTE:** Details about your computer, including model, serial number, product key, and length of warranty, are on the service tag at the bottom of your computer. See [Labels on page 16](#) for details.

This chapter provides removal and replacement procedures for Authorized Service Provider only parts.

There are as many as 54 screws that must be removed, replaced, or loosened when servicing Authorized Service Provider only parts. Make special note of each screw size and location during removal and replacement.

Display subcomponents (bezel, panel, camera)

 **NOTE:** Display assemblies are spared at the subcomponent level only.

This section illustrates how to remove the display bezel, display panel, and camera module without removing the display from the computer. The [Display assembly on page 72](#) section illustrates removing all display subcomponents.

To remove the display assembly subcomponents, follow these steps:

1. Shut down the computer. If you are unsure whether the computer is off or in Hibernation, turn the computer on, and then shut it down through the operating system.
2. Disconnect all external devices connected to the computer.
3. Disconnect the power from the computer by first unplugging the power cord from the AC outlet and then unplugging the AC adapter from the computer.

Remove the display assembly subcomponents:

1. Open the computer as far as it will open.
2. To remove the display bezel:
 - a. Flex the inside of the top edge **(1)**, the left and right edges **(2)**, and the bottom edge **(3)** of the display bezel until the bezel disengages from the display enclosure.

 **NOTE:** When removing the bezel from the bottom of the display **(3)**, be careful not to peel the Mylar from the bottom of the display panel.

- b. Remove the display bezel (4).

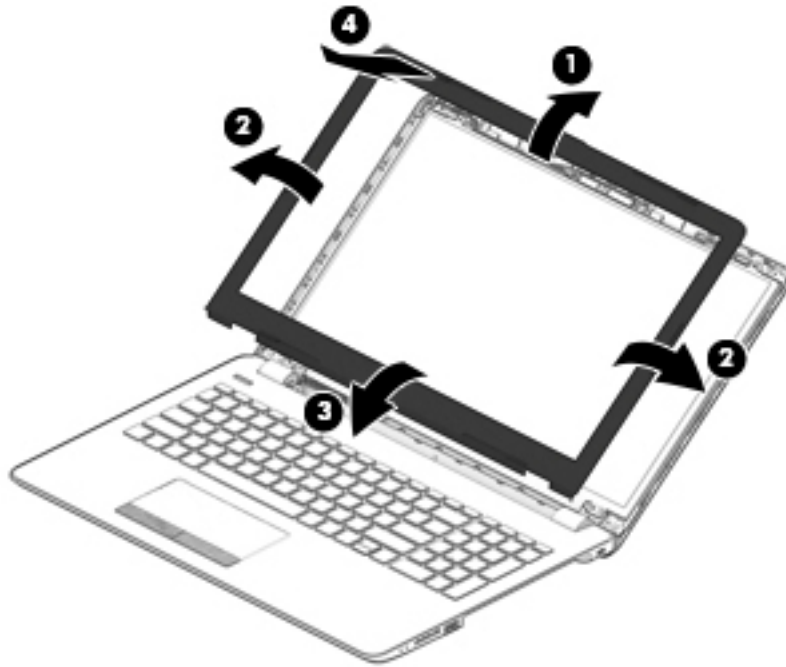

3. To remove the camera/microphone module:

- a. Position the display assembly with the top edge toward you.
- b. Pry up to disengage the camera/microphone module from the adhesive that secures it to the display (1).
- c. Disconnect the cable (2) from the module.
- d. Remove the tape from the enclosure (3). Replacement cameras come with tape already installed.

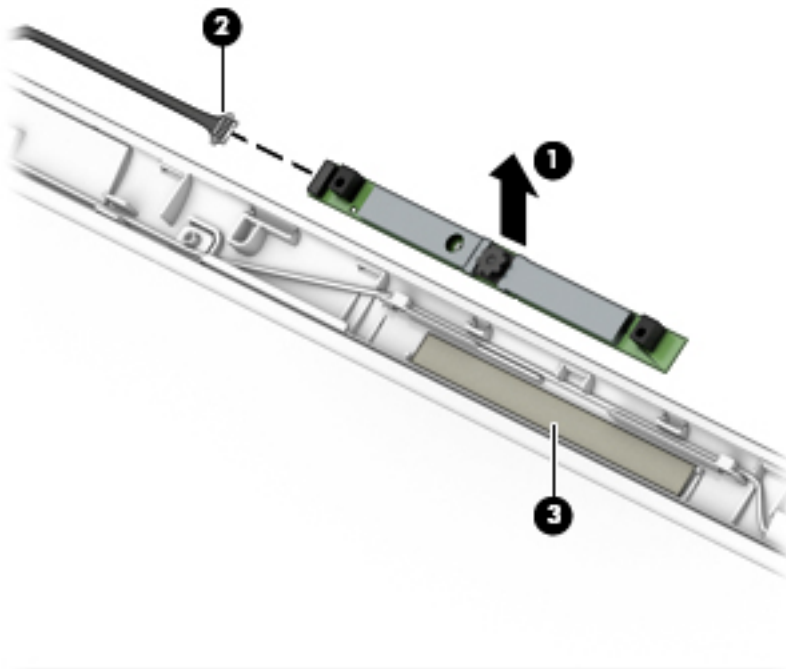

4. To remove the display panel:
 - a. Remove the four Phillips PM2.0×3.0 screws **(1)** that secure the display panel to the top of the enclosure.
 - b. Remove the two Phillips PM2.0×3.0 screws **(2)** that secure the display panel to the bottom of the enclosure.
 - c. Lift the hinges up and move aside enough to be able to rotate the panel up and over **(3)**.
 - d. Rotate the display panel onto the keyboard **(4)** to gain access to the display cable connection on the back of the panel.

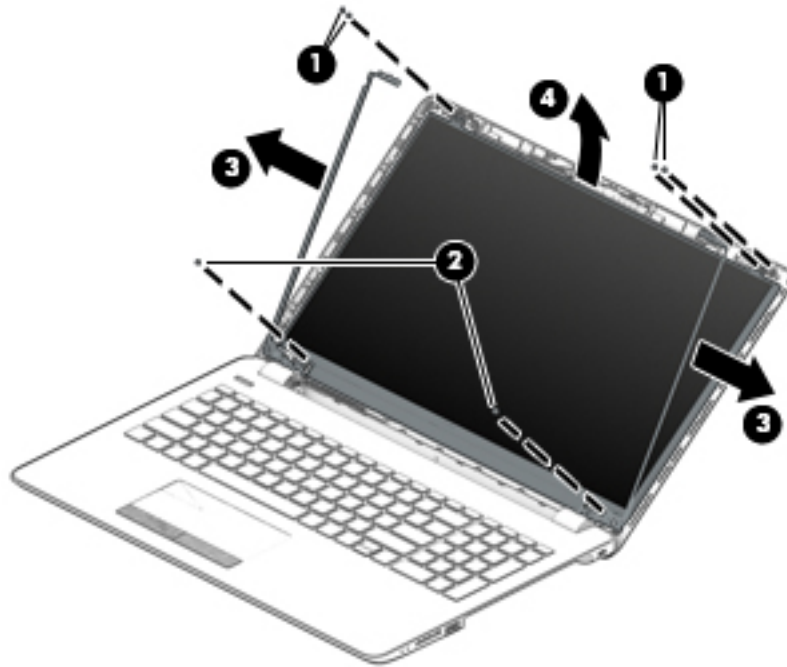

- e. On the back of the display panel, release the adhesive strip that secures the display panel cable to the display panel, and then disconnect the cable **(1)**.

- f. Remove the display panel from the computer **(2)**.

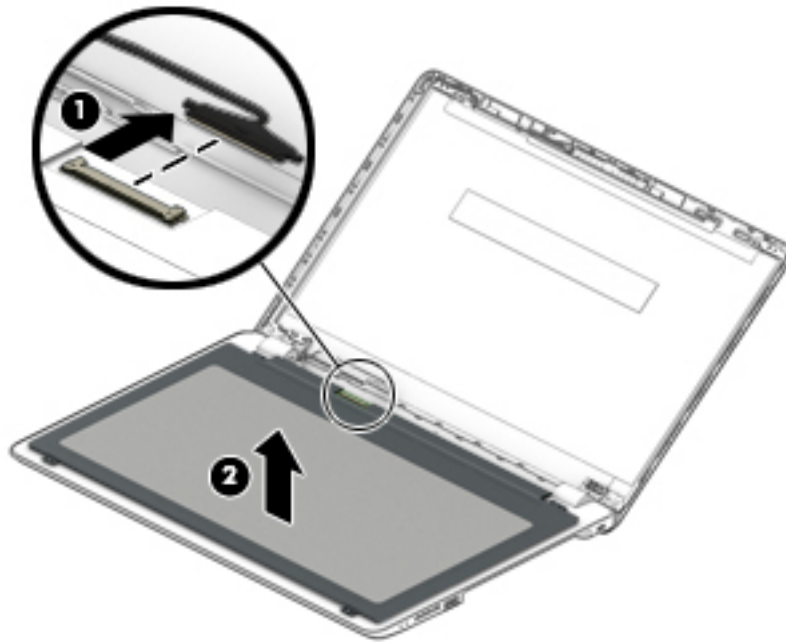

Reverse this procedure to reassemble and install the display assembly components.

Rubber feet

Description	Spare part number
Rubber feet, upper	
Asteroid silver	931599-001
Dark ash silver	931600-001
Silk gold	924998-001
Marine blue	925000-001
Amethyst purple	925001-001
Pale mint	925002-001
Empress red	926298-001
Rose gold	926299-001
Rubber feet, lower	
Asteroid silver	931601-001
Dark ash silver	931602-001
Silk gold	925299-001
Marine blue	925301-001
Amethyst purple	925302-001
Pale mint	925303-001
Empress red	926300-001
Rose gold	926301-001

Before removing the rubber feet, follow these steps:

1. Shut down the computer. If you are unsure whether the computer is off or in Hibernation, turn the computer on, and then shut it down through the operating system.
2. Disconnect all external devices connected to the computer.
3. Disconnect the power from the computer by first unplugging the power cord from the AC outlet and then unplugging the AC adapter from the computer.

To remove the rubber feet:

- ▲ Peel the lower rubber feet **(1)** and upper rubber feet **(2)** from the bottom of the computer.



NOTE: The lower feet and upper feet are different sizes.

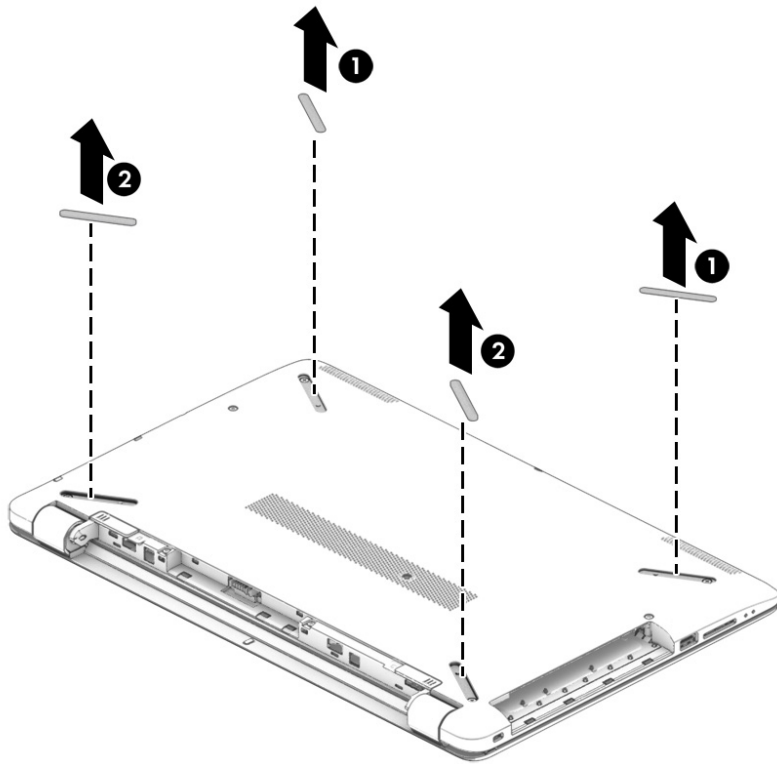

Reverse this procedure to install the rubber feet.

Bottom cover

Description	Spare part number
Bottom cover for use in models with an optical drive:	
• Pike silver	924901-001
• Silk gold	924902-001
• Smoke gray	924903-001
• Marine blue	924904-001
• Amethyst purple	924905-001
• Pale mint	924906-001
• Jet black	924907-001
• Snow white	924908-001
• Empress red	924913-001
• Rose gold	924914-001
Bottom cover for use in models without an optical drive:	
• Pike silver	924909-001
• Silk gold	924910-001
• Smoke gray	924911-001
• Marine blue	924912-001
• Jet black	924915-001
• Snow white	924916-001
• Empress red	926295-001

Before removing the bottom cover, follow these steps:

1. Shut down the computer. If you are unsure whether the computer is off or in Hibernation, turn the computer on, and then shut it down through the operating system.
2. Disconnect all external devices connected to the computer.
3. Disconnect the power from the computer by first unplugging the power cord from the AC outlet and then unplugging the AC adapter from the computer.
4. Remove the battery (see [Battery on page 34](#)).
5. Remove the optical drive (see [Optical drive on page 35](#)), if installed.

To remove the bottom cover:

1. Position the computer upside down with the front toward you.
2. Peel back the rubber feet enough to access the screws underneath **(1)**

3. Remove the 9 Phillips PM2.5×11.0 screws (2) that secure the bottom cover to the computer.

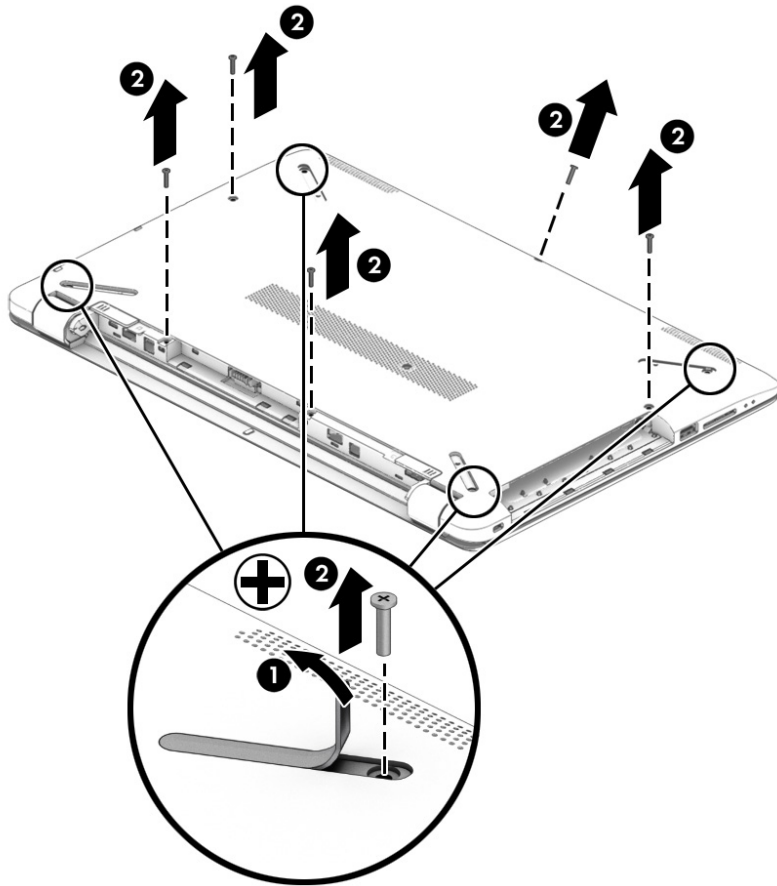

4. Start prying at the front of the computer and work around to the back to separate the bottom cover from computer **(1)**, and then remove the bottom cover **(2)**.

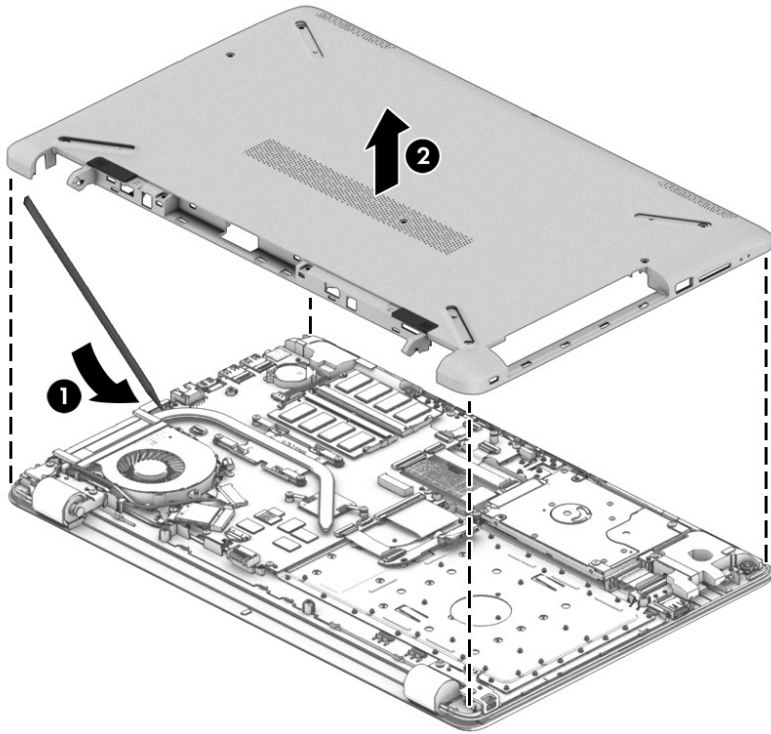

Reverse this procedure to install the bottom cover.

WLAN module

Description	Spare part number
Intel Dual Band Wireless-AC 7265 802.11AC 2x2 WiFi + BT 4.2 Combo Adapter (non-vPro)	901229-855
Realtek RTL8723DE 802.11 bgn 1x1 WiFi + BT 4.2 Combo Adapter	927230-855
Realtek RTL8723BE-VB 802.11b/g/n 1x1 Wi-Fi + BT4.0 Combo Adapter	855106-855
Realtek RTL 8188EE 802.11 bgn 1x1 WiFi Adapter	927235-855
Intel Dual Band Wireless-AC 3168 802.11 ac 1x1 WiFi + BT 4.2 Combo Adapter	863934-855

 **CAUTION:** To prevent an unresponsive system, replace the wireless module only with a wireless module authorized for use in the computer by the governmental agency that regulates wireless devices in your country or region. If you replace the module and then receive a warning message, remove the module to restore device functionality, and then contact support.

Before removing the WLAN module, follow these steps:

1. Shut down the computer. If you are unsure whether the computer is off or in Hibernation, turn the computer on, and then shut it down through the operating system.
2. Disconnect all external devices connected to the computer.
3. Disconnect the power from the computer by first unplugging the power cord from the AC outlet and then unplugging the AC adapter from the computer.
4. Remove the battery (see [Battery on page 34](#)).
5. Remove the optical drive (see [Optical drive on page 35](#)), if installed.
6. Remove the bottom cover (see [Bottom cover on page 45](#)).

To remove the WLAN module:

1. Disconnect the WLAN antenna cables **(1)** from the terminals on the WLAN module.

 **NOTE:** The WLAN antenna cable labeled “1” connects to the WLAN module “Main” terminal labeled “1”. The WLAN antenna cable labeled “2” connects to the WLAN module “Aux” terminal labeled “2” (if applicable).

2. Remove the Phillips PM2.0×3.0 screw **(2)** that secures the WLAN module to the system board. (The WLAN module tilts up.)

3. Remove the WLAN module by pulling the module away from the slot at an angle (3).

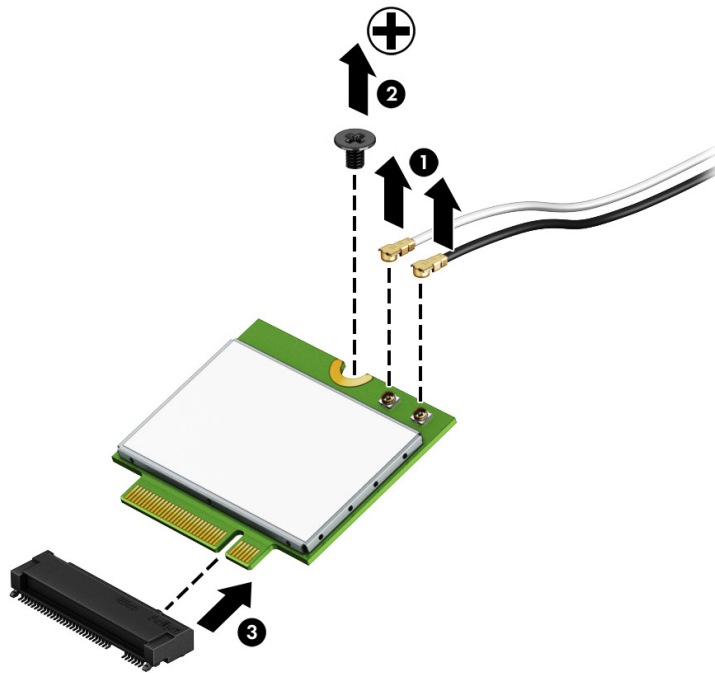

 **NOTE:** If the WLAN antennas are not connected to the terminals on the WLAN module, the protective sleeves must be installed on the antenna connectors, as shown in the following illustration.

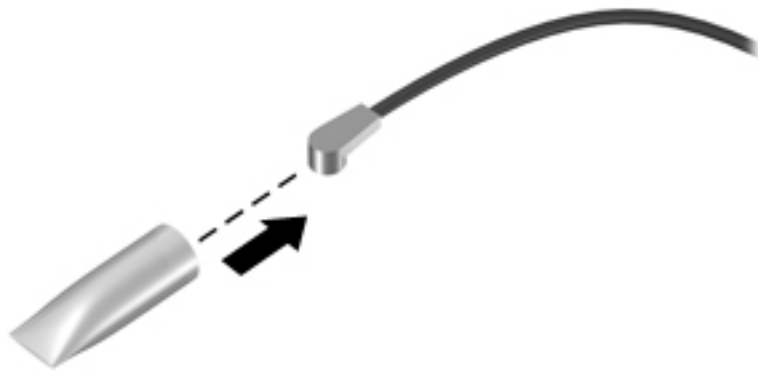

Reverse this procedure to install the WLAN module.

Memory module

Description	Spare part number
Memory module (PC3L-1600)	
For use in models with Intel Pentium and Celeron processors:	
8-GB	693374-005
4-GB	691740-005
2-GB	691739-005
Memory module (PC4-2400)	
For use in models with 6th and 7th generation Intel Core processors:	
8-GB	862398-855
4-GB	862397-855
2-GB	864271-855

Before removing a memory module, follow these steps:

1. Shut down the computer. If you are unsure whether the computer is off or in Hibernation, turn the computer on, and then shut it down through the operating system.
2. Disconnect all external devices connected to the computer.
3. Disconnect the power from the computer by first unplugging the power cord from the AC outlet and then unplugging the AC adapter from the computer.
4. Remove the battery (see [Battery on page 34](#)).
5. Remove the optical drive (see [Optical drive on page 35](#)), if installed.
6. Remove the bottom cover (see [Bottom cover on page 45](#)).

To remove a memory module:

1. Spread the retaining tabs **(1)** on each side of the memory module slot to release the memory module. (The memory module tilts up.)

2. Remove the memory module (2) by pulling it away from the slot at an angle.

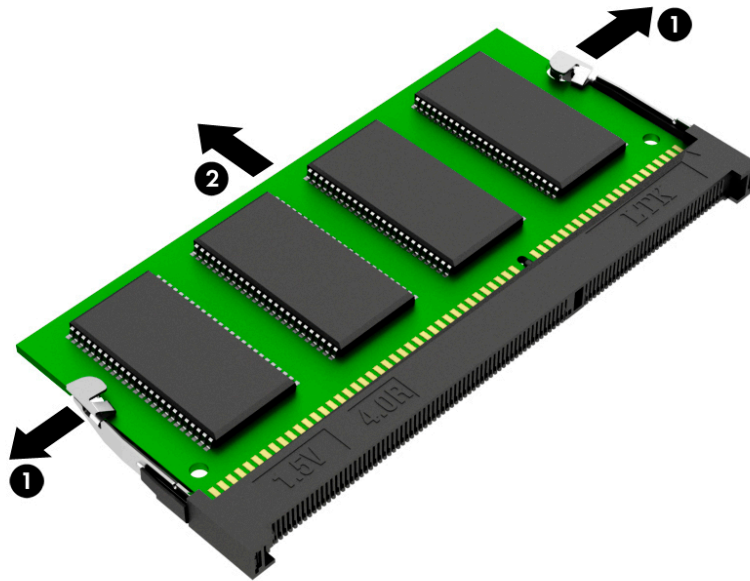

Reverse this procedure to install a memory module.

Optical drive connector board

Description	Spare part number
Optical drive connector board	924990-001
Optical drive cable	924926-001

Before removing the optical drive connector board, follow these steps:

1. Shut down the computer. If you are unsure whether the computer is off or in Hibernation, turn the computer on, and then shut it down through the operating system.
2. Disconnect all external devices connected to the computer.
3. Disconnect the power from the computer by first unplugging the power cord from the AC outlet and then unplugging the AC adapter from the computer.
4. Remove the battery (see [Battery on page 34](#)).
5. Remove the optical drive (see [Optical drive on page 35](#)), if installed.
6. Remove the bottom cover (see [Bottom cover on page 45](#)).

To remove the optical drive connector board:

1. Disconnect the cable from the optical drive connector board **(1)**.
2. Remove the Phillips PM2.0×2.0 screw **(2)** that secures the optical drive connector board to the computer.
3. Rotate the connector side of the board upward, and then pull the board up and out of the computer **(3)**.

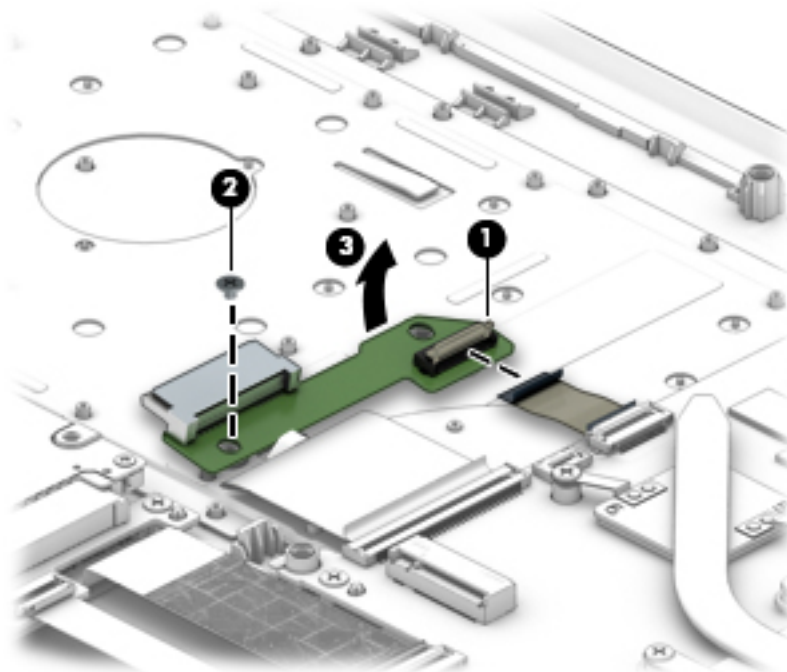

Reverse this procedure to install the optical drive board connector.

Hard drive and hard drive connector board



NOTE: The hard drive spare part kit does not include the hard drive bracket, cable, or connector board.

Description	Spare part number
Hard drives:	
2-TB, 5400-rpm	912487-855
1-TB, 5400-rpm	778192-005
500-GB, 5400-rpm	778186-005
Hard drive bracket	924980-001

Before removing the hard drive, follow these steps:

1. Shut down the computer. If you are unsure whether the computer is off or in Hibernation, turn the computer on, and then shut it down through the operating system.
2. Disconnect all external devices connected to the computer.
3. Disconnect the power from the computer by first unplugging the power cord from the AC outlet and then unplugging the AC adapter from the computer.
4. Remove the battery (see [Battery on page 34](#)).
5. Remove the optical drive (see [Optical drive on page 35](#)), if installed.
6. Remove the bottom cover (see [Bottom cover on page 45](#)).

To remove the hard drive:

1. Remove the Phillips PM2.0×3.0 screw **(1)** that secures the hard drive assembly to the computer.
2. Lift the rear of the hard drive upward **(2)**.

3. Pull the hard drive assembly away from connector to remove it **(3)**.

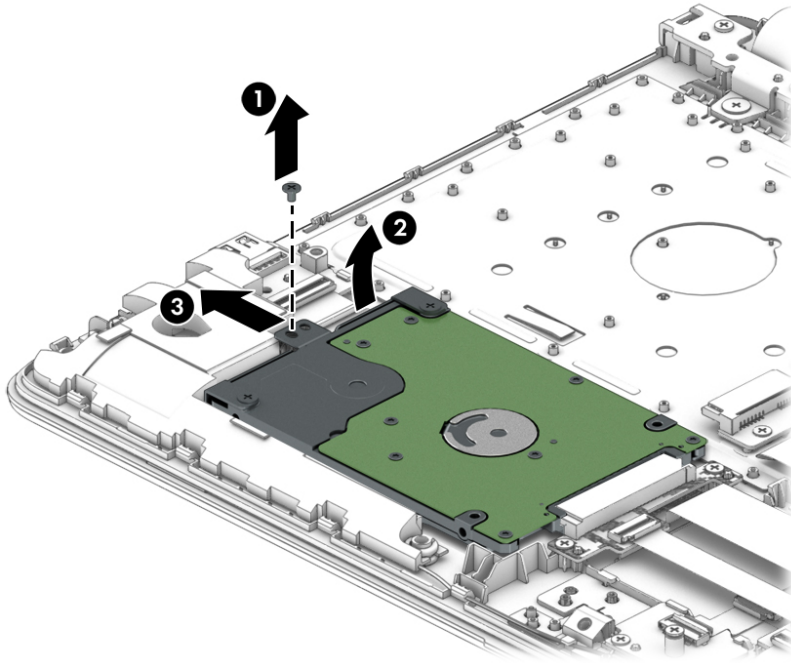

4. To remove the hard drive bracket, remove the two Phillips PM3.0×3.0 screws **(1)** that secure the bracket to the hard drive.
5. Remove the hard drive bracket from the hard drive **(2)**.

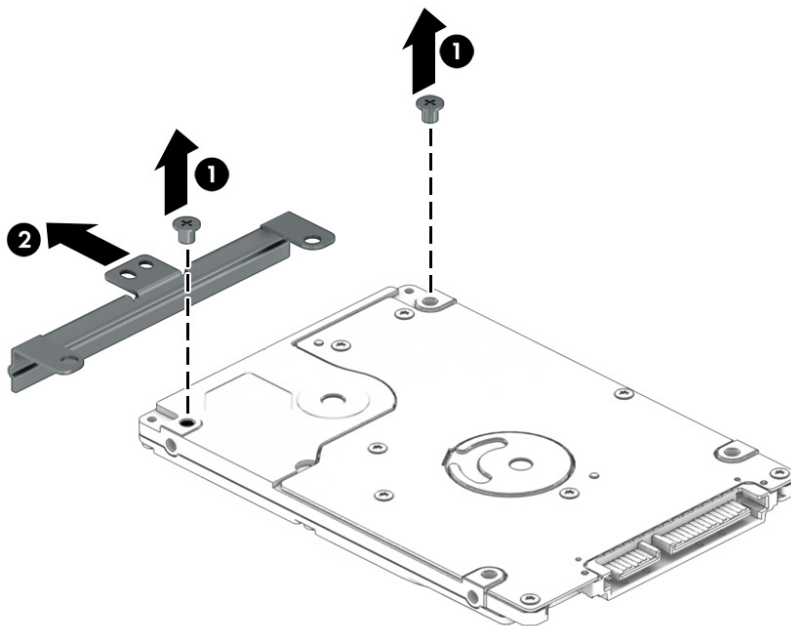

6. To remove the hard drive connector board, disconnect the cable from the board **(1)**.
7. Remove the two Phillips PM2.0×3.0 screws **(2)** that secure the hard drive board to the computer.

8. Remove the hard drive board from the computer **(3)**.

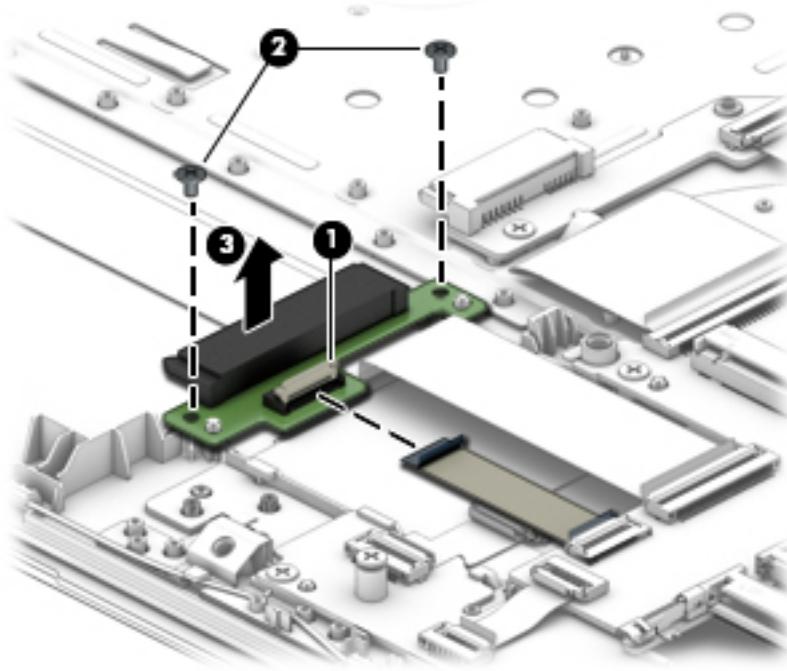

Reverse this procedure to reassemble and install the hard drive.

M.2 solid-state drive adapter bracket and connector board



NOTE: You can install an M.2 solid-state drive into the hard drive bay using an adapter bracket and connector board.

Description	Spare part number
Solid-state drive board	924992-001
Solid-state drive bracket	924981-001

Before removing the solid-state drive adapter bracket and connector board, follow these steps:

1. Shut down the computer. If you are unsure whether the computer is off or in Hibernation, turn the computer on, and then shut it down through the operating system.
2. Disconnect all external devices connected to the computer.
3. Disconnect the power from the computer by first unplugging the power cord from the AC outlet and then unplugging the AC adapter from the computer.
4. Remove the battery (see [Battery on page 34](#)).
5. Remove the optical drive (see [Optical drive on page 35](#)), if installed.
6. Remove the bottom cover (see [Bottom cover on page 45](#)).

To remove the solid-state drive adapter bracket and connector board:

1. Disconnect the cable from the connector board **(1)**.
2. Remove the two Phillips PM2.0×3.0 screws **(2)** that secure the connector board to the computer.
3. Lift the connector board out of the computer **(3)**.
4. Remove the Phillips PM2.0×3.0 screw **(4)** that secures the adapter bracket to the computer.

5. Lift the adapter bracket out of the computer (5)

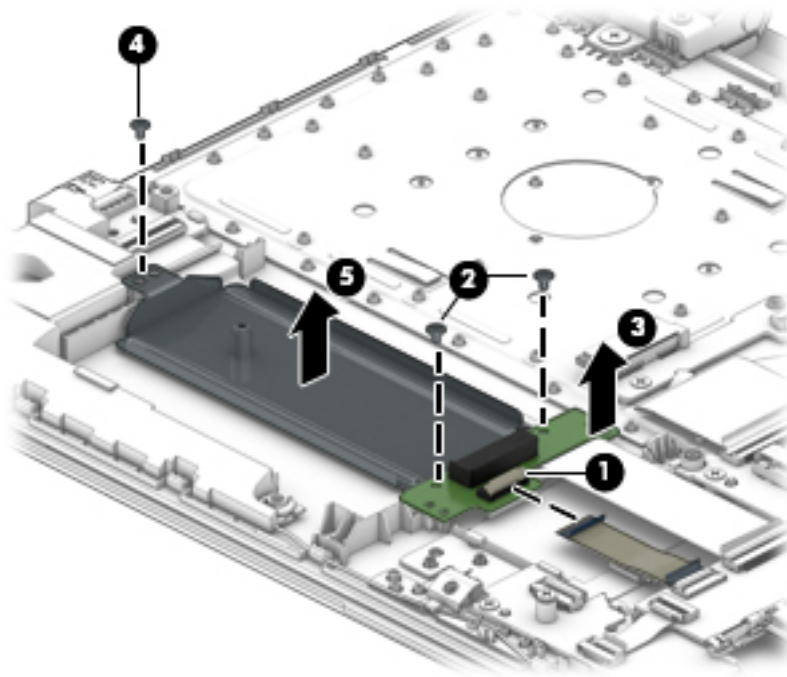

Reverse this procedure to reassemble and install the solid-state drive adapter bracket and connector board.

Solid-state drive (SSD)

Description	Spare part number
512 GB	763008-017
256 GB	865902-017
128 GB	827560-048

Before removing the solid-state drive, follow these steps:

1. Shut down the computer. If you are unsure whether the computer is off or in Hibernation, turn the computer on, and then shut it down through the operating system.
2. Disconnect all external devices connected to the computer.
3. Disconnect the power from the computer by first unplugging the power cord from the AC outlet and then unplugging the AC adapter from the computer.
4. Remove the battery (see [Battery on page 34](#)).
5. Remove the optical drive (see [Optical drive on page 35](#)), if installed.
6. Remove the bottom cover (see [Bottom cover on page 45](#)).

Remove the solid-state drive:

1. Remove the Phillips PM2.0×2.0 screw **(1)** that secures the drive to the system board.
2. Remove the drive **(2)** by pulling it away from the connector.

 **NOTE:** Solid-state drives are designed with notches to prevent incorrect insertion.

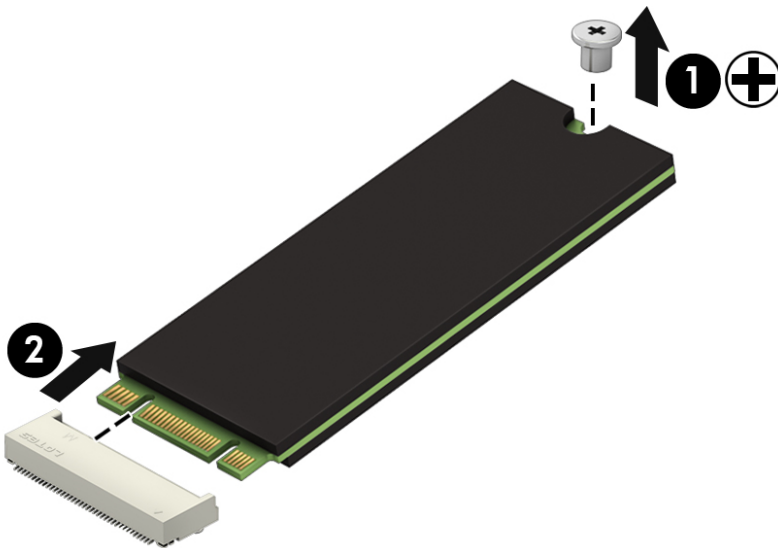

Reverse this procedure to reassemble and install the solid-state drive.

RTC battery

Description	Spare part number
RTC battery	922847-001

Before removing the RTC battery, follow these steps:

1. Shut down the computer. If you are unsure whether the computer is off or in Hibernation, turn the computer on, and then shut it down through the operating system.
2. Disconnect all external devices connected to the computer.
3. Disconnect the power from the computer by first unplugging the power cord from the AC outlet and then unplugging the AC adapter from the computer.
4. Remove the battery (see [Battery on page 34](#)).
5. Remove the optical drive (see [Optical drive on page 35](#)), if installed.
6. Remove the bottom cover (see [Bottom cover on page 45](#)).

To remove the RTC battery:

- ▲ Using a thin tool or screwdriver, disengage the battery from the socket **(1)**, and then remove the battery **(2)**.

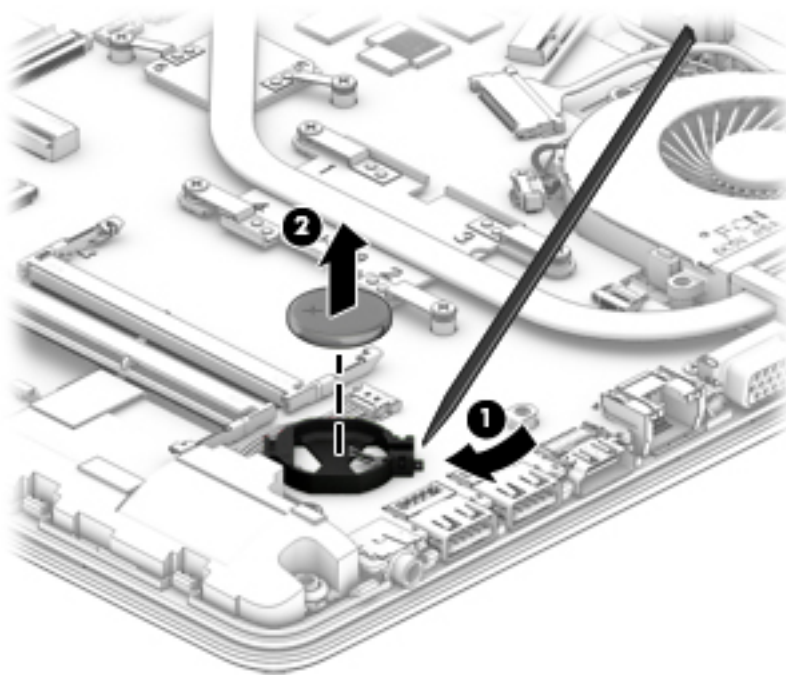

Reverse this procedure to install the RTC battery.

Speakers

Description	Spare part number
Speakers (includes left and right speakers and cable)	925306-001

Before removing the speakers, follow these steps:

1. Shut down the computer. If you are unsure whether the computer is off or in Hibernation, turn the computer on, and then shut it down through the operating system.
2. Disconnect all external devices connected to the computer.
3. Disconnect the power from the computer by first unplugging the power cord from the AC outlet and then unplugging the AC adapter from the computer.
4. Remove the battery (see [Battery on page 34](#)).
5. Remove the optical drive (see [Optical drive on page 35](#)), if installed.
6. Remove the bottom cover (see [Bottom cover on page 45](#)).

To remove the speakers:

1. Disconnect the speaker cable from the system board **(1)**.
2. Remove the cable from its routing path along the bottom of the computer **(2)**, and then lift up and remove the speakers from the computer **(3)**.

 **NOTE:** The speakers are not secured with screws. Note the rubber gaskets **(4)** that help secure the speakers to the computer. When installing the speakers, make sure the gaskets are installed correctly.



Reverse this procedure to install the speakers.

USB board

Description	Spare part number
USB board	924991-001
USB board cable	924929-001

Before removing the USB board, follow these steps:

1. Shut down the computer. If you are unsure whether the computer is off or in Hibernation, turn the computer on, and then shut it down through the operating system.
2. Disconnect all external devices connected to the computer.
3. Disconnect the power from the computer by first unplugging the power cord from the AC outlet and then unplugging the AC adapter from the computer.
4. Remove the battery (see [Battery on page 34](#)).
5. Remove the optical drive (see [Optical drive on page 35](#)), if installed.
6. Remove the bottom cover (see [Bottom cover on page 45](#)).
7. Remove the speakers (see [Speakers on page 60](#)).

To remove the USB board:

1. Disconnect the USB board cable from the USB board **(1)**.
2. Remove the Phillips PM2.0×3.0 screw **(2)** that secures the USB board to the computer.
3. Remove the USB board **(3)**.

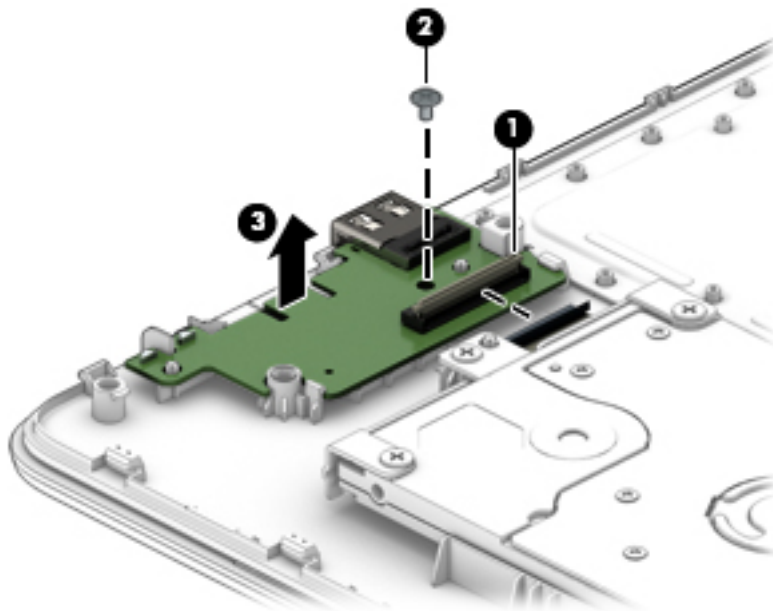

Reverse this procedure to install the USB board.

Fan

Description	Spare part number
Fan	925012-001



NOTE: To properly ventilate the computer, allow at least **7.6 cm** (3.0 in) of clearance on the left side of the computer. The computer uses an electric fan for ventilation. The fan is controlled by a temperature sensor and is designed to turn on automatically when high temperature conditions exist. These conditions are affected by high external temperatures, system power consumption, power management/battery conservation configurations, battery fast charging, and software requirements. Exhaust air is displaced through the ventilation grill located on the left side of the computer.

Before removing the fan/heat sink assembly, follow these steps:

1. Shut down the computer. If you are unsure whether the computer is off or in Hibernation, turn the computer on, and then shut it down through the operating system.
2. Disconnect all external devices connected to the computer.
3. Disconnect the power from the computer by first unplugging the power cord from the AC outlet and then unplugging the AC adapter from the computer.
4. Remove the battery (see [Battery on page 34](#)).
5. Remove the optical drive (see [Optical drive on page 35](#)), if installed.
6. Remove the bottom cover (see [Bottom cover on page 45](#)).

To remove the fan:

1. Lift the cables (antenna, display, power connector) from atop the screw **(1)**.
2. Disconnect the fan cable **(2)** from the system board.
3. Remove the Phillips PM2.5×6.5 screw **(3)** that secures the fan to the computer.

4. Remove the fan from the computer (4).

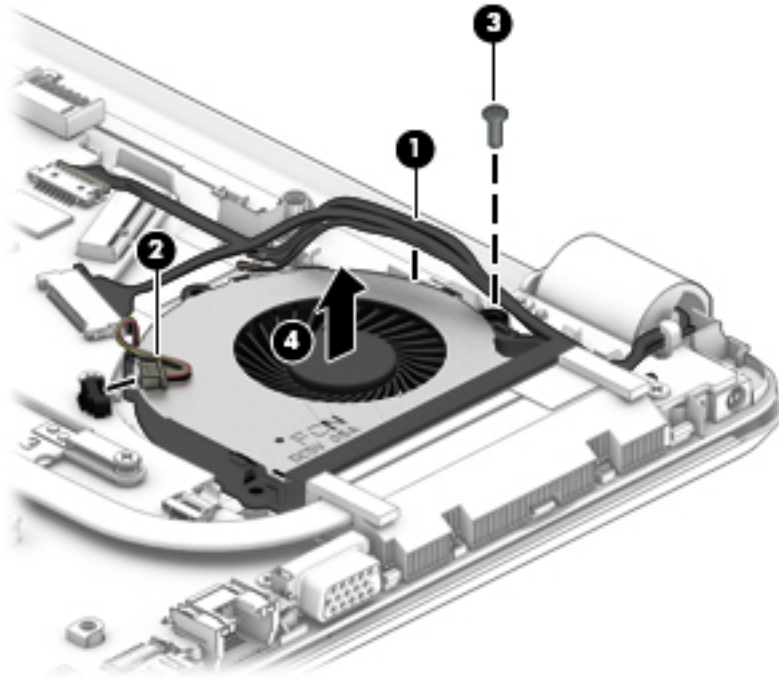

Reverse this procedure to install the fan.

Heat sink assembly

 **NOTE:** The heat sink assembly spare part kit includes replacement thermal materials.

Description	Spare part number
Heat sink for use in models with discrete graphics memory and 6th or 7th generation Intel Core processors	924976-001
Heat sink for use in models with discrete graphics memory and Intel Pentium or Celeron processors	924978-001
Heat sink for use in models with UMA graphics memory and 6th or 7th generation Intel Core processors	924975-001
Heat sink for use in models with UMA graphics and Intel Pentium or Celeron processors	924977-001

 **NOTE:** To properly ventilate the computer, allow at least **7.6 cm** (3.0 in) of clearance on the left side of the computer. The computer uses an electric fan for ventilation. The fan is controlled by a temperature sensor and is designed to turn on automatically when high temperature conditions exist. These conditions are affected by high external temperatures, system power consumption, power management/battery conservation configurations, battery fast charging, and software requirements. Exhaust air is displaced through the ventilation grill located on the left side of the computer.

Before removing the heat sink assembly, follow these steps:

1. Shut down the computer. If you are unsure whether the computer is off or in Hibernation, turn the computer on, and then shut it down through the operating system.
2. Disconnect all external devices connected to the computer.
3. Disconnect the power from the computer by first unplugging the power cord from the AC outlet and then unplugging the AC adapter from the computer.
4. Remove the battery (see [Battery on page 34](#)).
5. Remove the optical drive (see [Optical drive on page 35](#)), if installed.
6. Remove the bottom cover (see [Bottom cover on page 45](#)).

To remove the heat sink assembly:

1. Refer to the following heat sink removal image that matches your computer.
2. In the order indicated on the heat sink, remove the screws that secure the heat sink assembly to the system board.
3. Remove the heat sink assembly from the system board.

 **NOTE:** Heat sink appearance may vary.

Discrete graphics

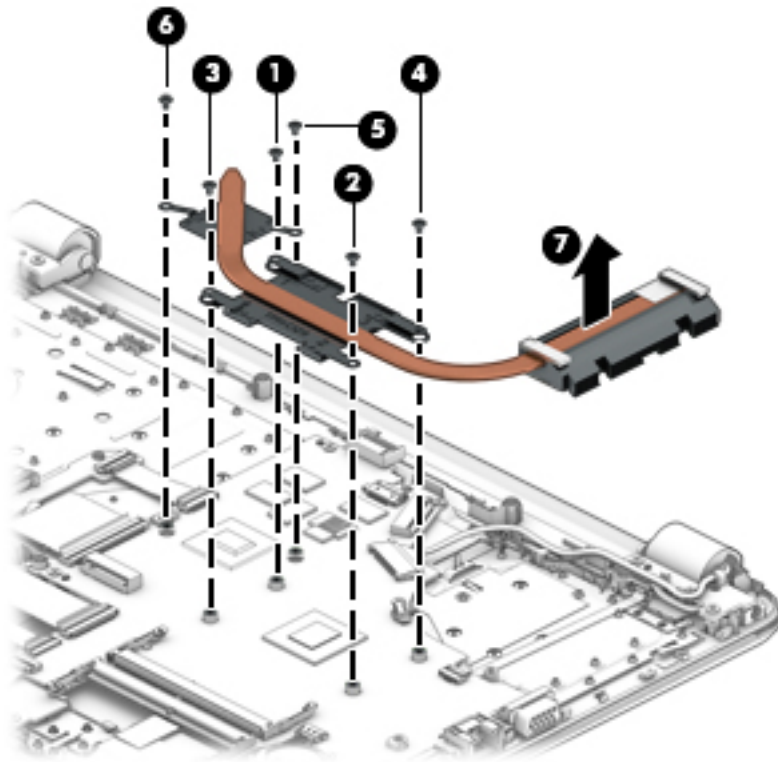

- **Discrete graphics** Thermal paste is used on the processor and associated heat sink area **(1)(2)**, as well as the graphics chip and associated heat sink area **(3)(4)**.

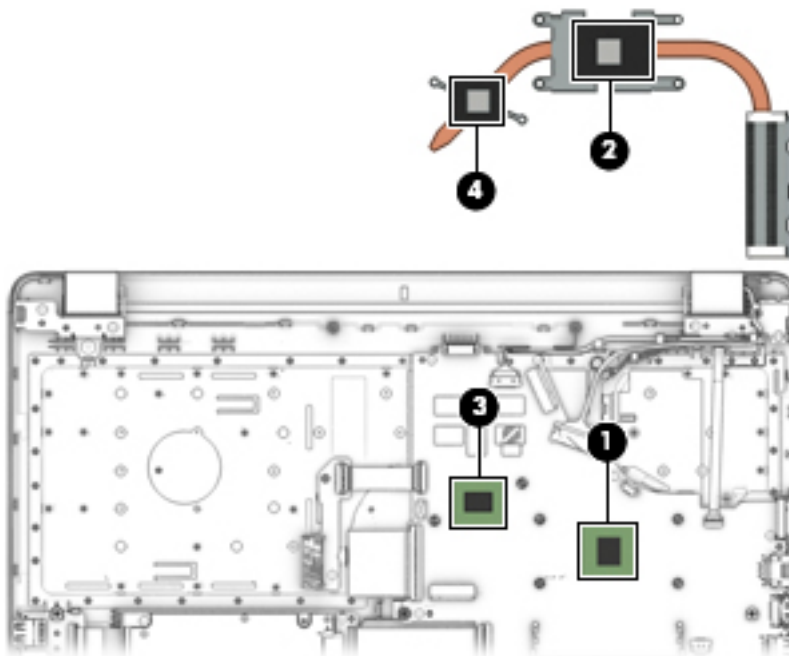

4. UMA graphics

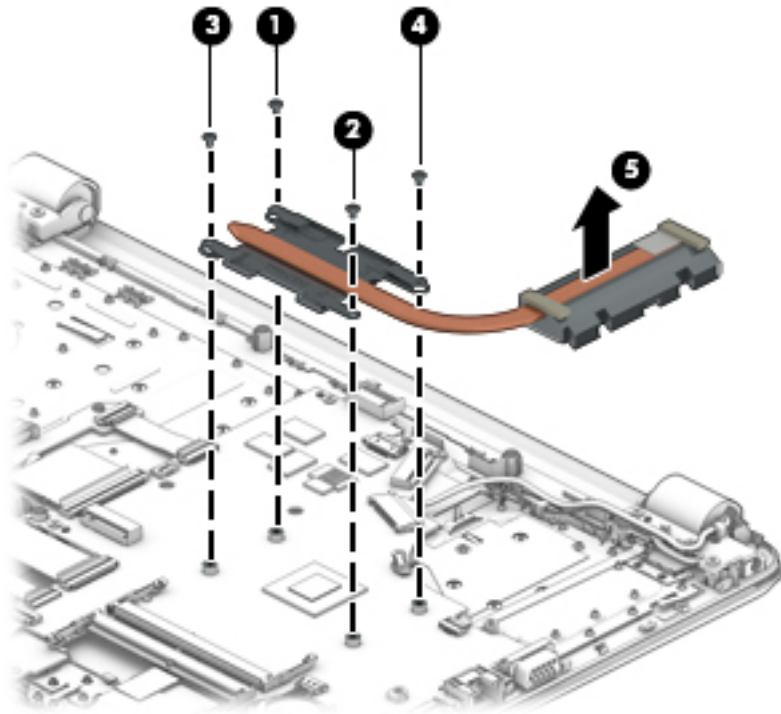

- **UMA graphics** Thermal paste is used on the heat sink (1) and the processor (2).

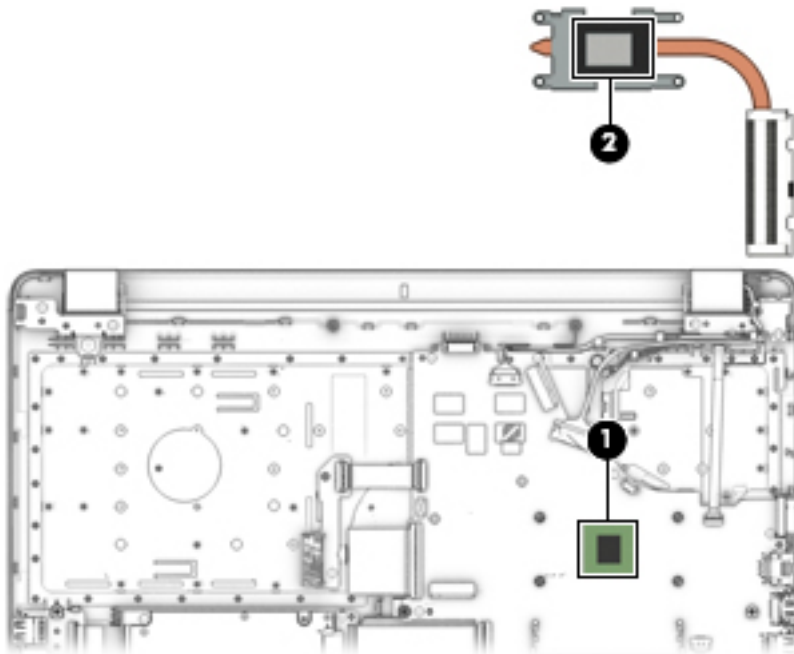

5. **UMA graphics (fanless)**

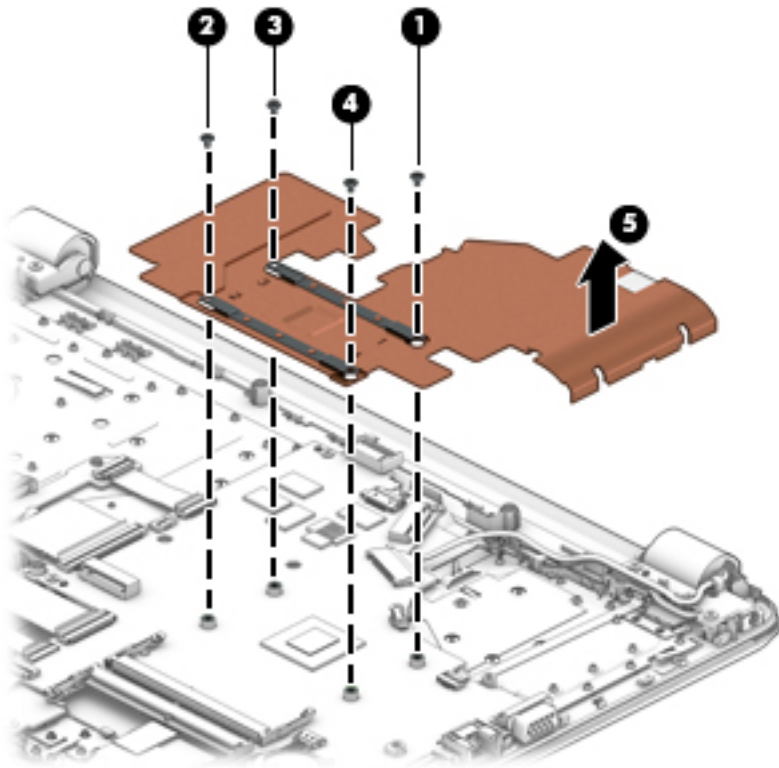

- **UMA graphics (fanless)** Thermal paste is used on the heat sink (1) and the processor (2).

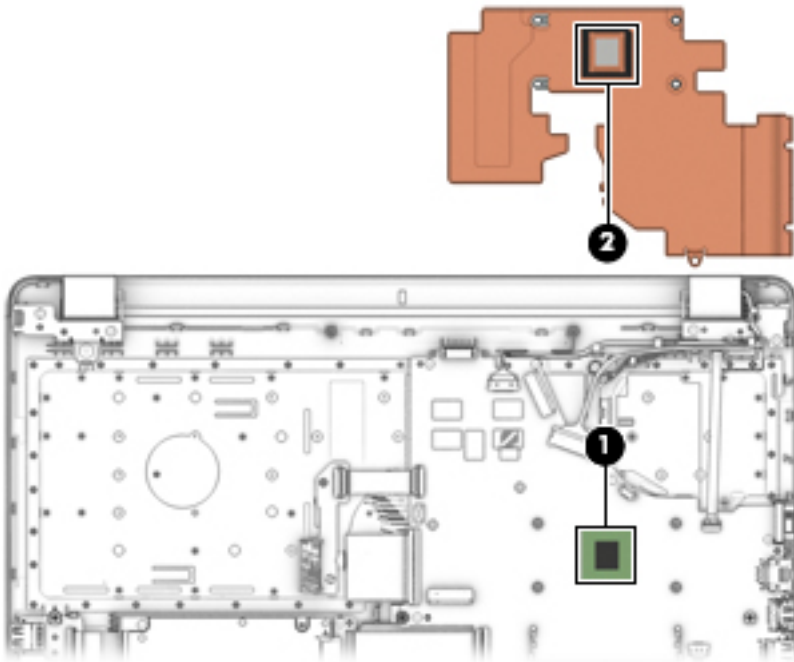

Reverse this procedure to reassemble and install the heat sink assembly.

TouchPad button board

Description	Spare part number
TouchPad button board for use in models without a solid-state drive	924993-001
TouchPad button board for use in models with a solid-state drive	934256-001
TouchPad button board cable	924934-001
TouchPad cable	924928-001

Before removing the TouchPad button board, follow these steps:

1. Shut down the computer. If you are unsure whether the computer is off or in Hibernation, turn the computer on, and then shut it down through the operating system.
2. Disconnect all external devices connected to the computer.
3. Disconnect the power from the computer by first unplugging the power cord from the AC outlet and then unplugging the AC adapter from the computer.
4. Remove the battery (see [Battery on page 34](#)).
5. Remove the optical drive (see [Optical drive on page 35](#)), if installed.
6. Remove the bottom cover (see [Bottom cover on page 45](#)).

To remove the TouchPad button board:

1. Disconnect the system board cable **(1)** and the TouchPad cable from the TouchPad button board **(2)**.
2. Remove the two Phillips PM2.0×3.0 screws **(3)** that secure the TouchPad button board to the computer.
3. Pull the TouchPad button board toward the bottom of the computer, and then remove the TouchPad button board **(4)**.

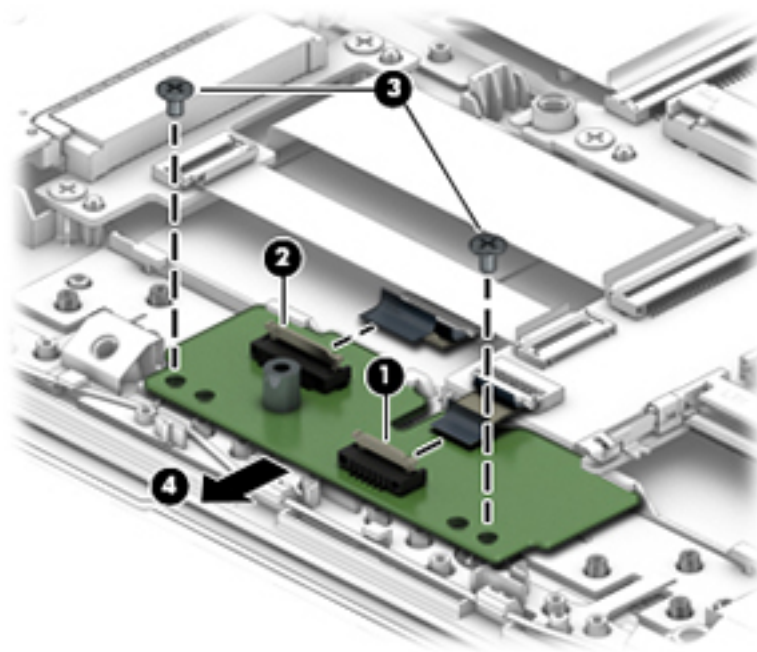

Reverse this procedure to install the TouchPad button board.

System board



NOTE: The system board spare part kit includes replacement thermal materials.

Description	Spare part number
System board (includes replacement thermal materials):	
All system boards use the following part numbers:	
xxxxxx-001: Non-Windows operating systems	
xxxxxx-601: Windows 10 operating system	
For use in models with discrete graphics memory:	
• Intel Core i7-7500U processor and 4 GB of discrete graphics memory	924759-xx1
• Intel Core i7-7500U processor and 2 GB of discrete graphics memory	924757-xx1
• Intel Core i5-7200U processor and 4 GB of discrete graphics memory	924758-xx1
• Intel Core i5-7200U processor and 2 GB of discrete graphics memory	924756-xx1
• Intel Core i3-6006U processor and 2 GB of discrete graphics memory	924755-xx1
• Intel Pentium N3710 processor and 2 GB of discrete graphics memory	924760-xx1
For use in models with UMA graphics memory:	
• Intel Core i7-7500U processor	924752-xx1
• Intel Core i5-7200U processor	924751-xx1
• Intel Core i3-7100U processor	924749-xx1
• Intel Core i3-6006U processor	924750-xx1
• Intel Pentium N3710 processor	924754-xx1
• Intel Celeron N3060 processor	924753-xx1

Before removing the system board, follow these steps:

1. Shut down the computer. If you are unsure whether the computer is off or in Hibernation, turn the computer on, and then shut it down through the operating system.
2. Disconnect all external devices connected to the computer.
3. Disconnect the power from the computer by first unplugging the power cord from the AC outlet and then unplugging the AC adapter from the computer.
4. Remove the battery (see [Battery on page 34](#)).
5. Remove the optical drive (see [Optical drive on page 35](#)), if installed.
6. Remove the bottom cover (see [Bottom cover on page 45](#)).
7. Remove the WLAN module (see [WLAN module on page 48](#)).
8. Remove the memory module (see [Memory module on page 50](#)).
9. Remove the solid-state drive (see [Solid-state drive \(SSD\) on page 58](#)).

To remove the system board:

1. Position the computer upright, and then disconnect the following cables from the system board:
 - (1): Power connector cable
 - (2): Display cable
 - (3): Power button board cable
 - (4): Speaker cable
 - (5): TouchPad cable
 - (6): Hard drive connector cable
 - (7): USB board cable
 - (8): Keyboard cable
 - (9): Optical drive board cable

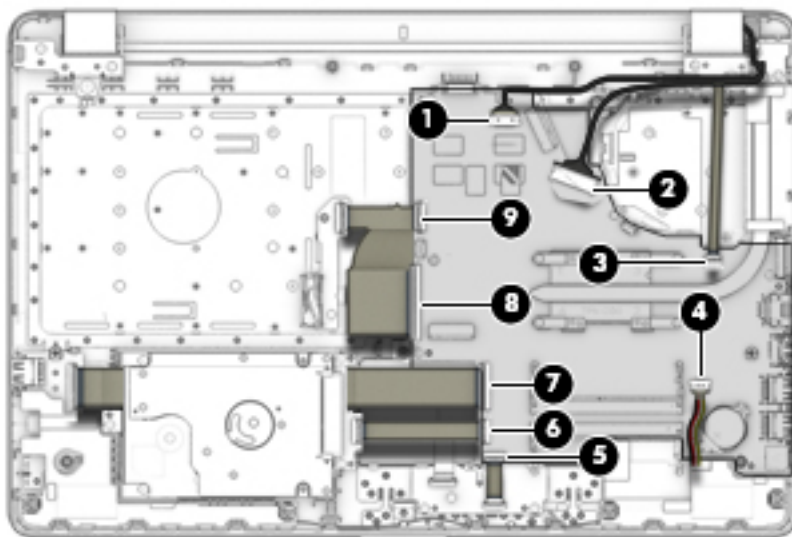

2. Remove the six Phillips PM2.0×3.0 screws **(1)** that secure the system board to the computer.

3. Rotate the side of the board upward **(2)**, and then lift the system board out of the computer **(3)**.

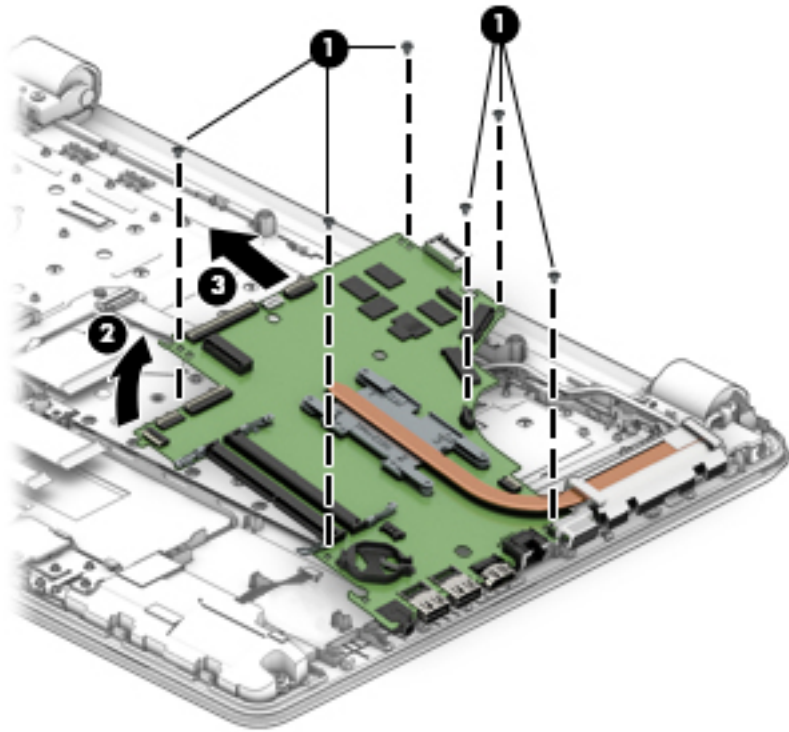

Reverse this procedure to install the system board.

Display assembly

This section describes removing the display assembly and disassembling display subcomponents. You must remove the display from the computer to disassemble display subcomponents.

Before removing the display assembly, follow these steps:

1. Shut down the computer. If you are unsure whether the computer is off or in Hibernation, turn the computer on, and then shut it down through the operating system.
2. Disconnect all external devices connected to the computer.
3. Disconnect the power from the computer by first unplugging the power cord from the AC outlet and then unplugging the AC adapter from the computer.
4. Remove the battery (see [Battery on page 34](#)).
5. Remove the optical drive (see [Optical drive on page 35](#)), if installed.
6. Remove the bottom cover (see [Bottom cover on page 45](#)).
7. Remove the fan (see [Fan on page 62](#)).

To remove the display assembly:

1. Disconnect the display panel cable from the system board **(1)**.
2. Disconnect the wireless antennas from the WLAN module **(2)**.
3. Remove the four Phillips PM2.5×6.0 screws **(3)** (two from each hinge) and one broadhead Phillips PM2.0×2.0 screw **(4)** (on the left hinge) that secures the display assembly to the computer.
4. Lift the display to bend the hinges upward **(5)**.

5. Separate the display from the computer (6).

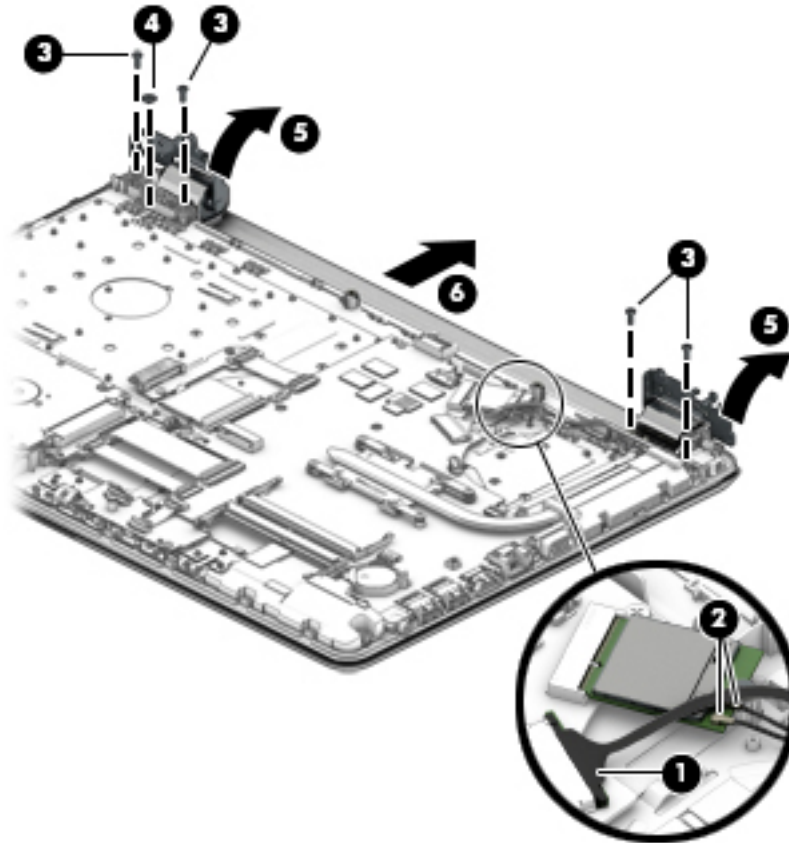

If it is necessary to replace any of the display assembly subcomponents:

1. To remove the display bezel:
 - a. Flex the inside of the top edge (1), the left and right edges (2), and the bottom edge (3) of the display bezel until the bezel disengages from the display enclosure.

 **NOTE:** When removing the bezel from the bottom of the display (3), be careful not to peel the Mylar from the bottom of the display panel.

- b.** Remove the display bezel **(4)**.

 **NOTE:** The display will not be connected to the computer as shown in the following image.

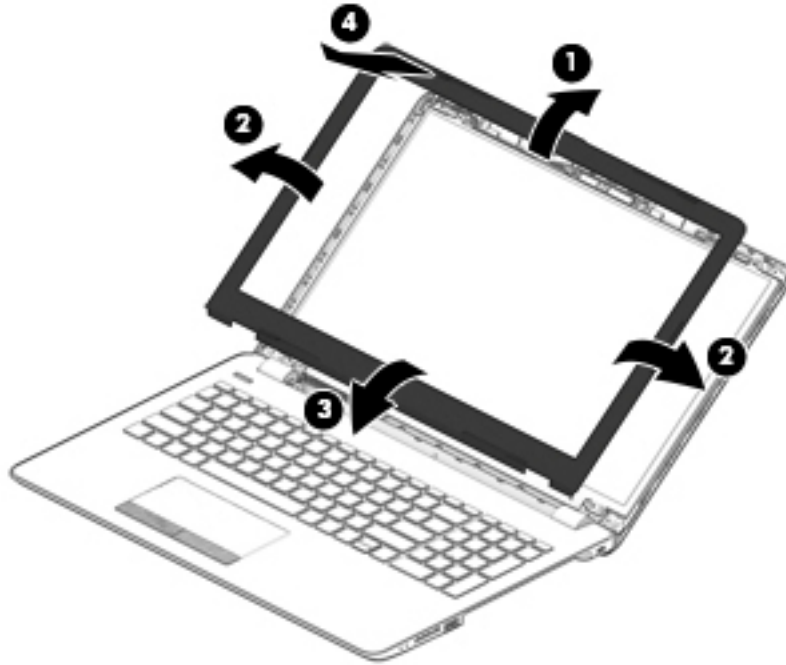

- 2.** To remove the camera/microphone module:
 - a.** Position the display assembly with the top edge toward you.
 - b.** Pry up to disengage the camera/microphone module from the adhesive that secures it to the display **(1)**.
 - c.** Disconnect the cable **(2)** from the module.

- d. Remove the tape from the enclosure **(3)**. Replacement cameras come with tape already installed.

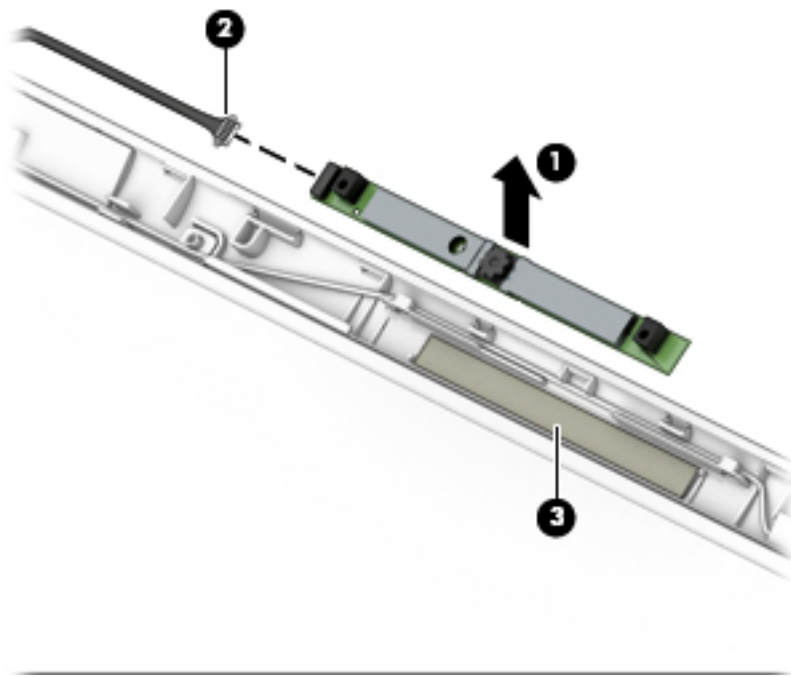

3. To remove the display panel:

- a. Remove the four Phillips PM2.0×3.0 screws **(1)** that secure the display panel to the top of the enclosure.
- b. Remove the two Phillips PM2.0×3.0 screws **(2)** that secure the display panel to the bottom of the enclosure.
- c. Lift the hinges up and move aside enough to be able to rotate the panel up and over **(3)**.

- d. Rotate the display panel onto the keyboard (4) to gain access to the display cable connection on the back of the panel.

 **NOTE:** The display will not be connected to the computer as shown in the following image.

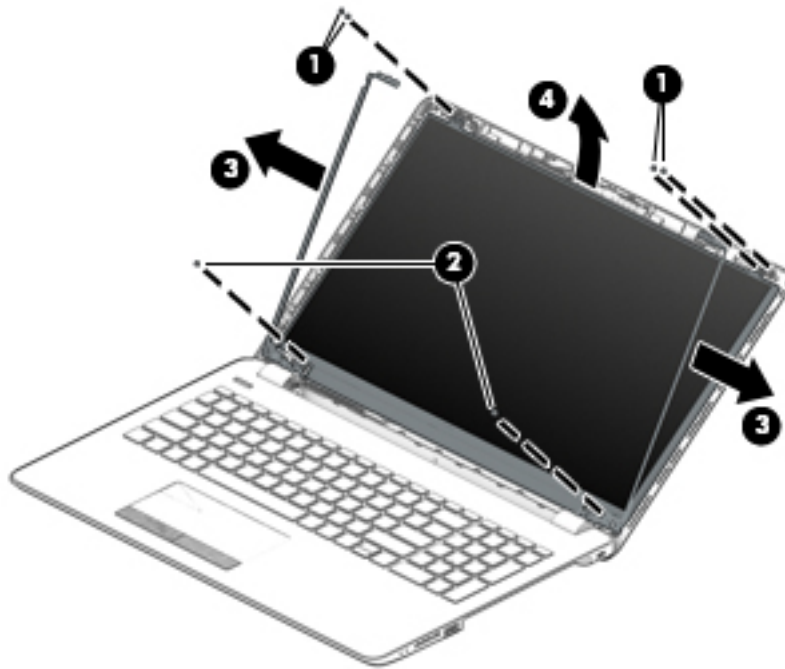

- e. On the back of the display panel, release the adhesive strip that secures the display panel cable to the display panel, and then disconnect the cable (1).
- f. Remove the display panel from the computer (2).

 **NOTE:** The display will not be connected to the computer as shown in the following image.

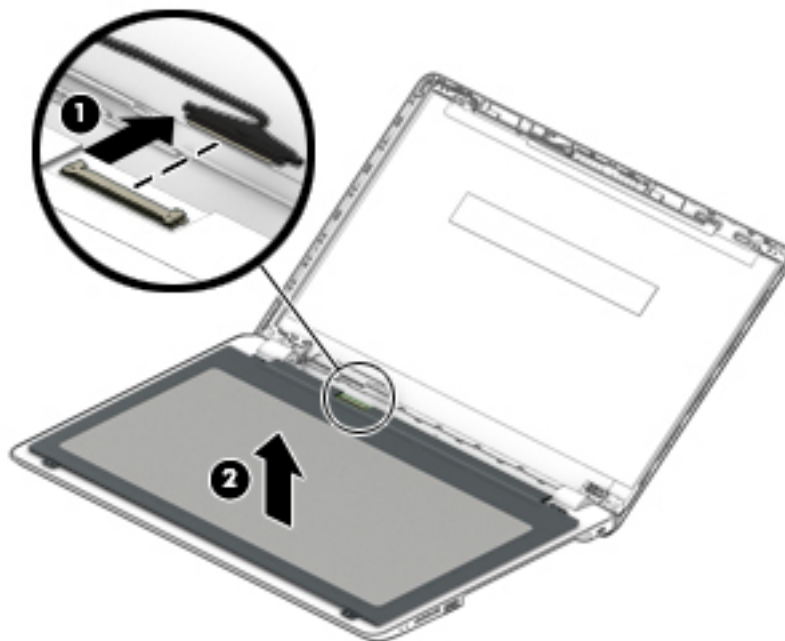

- 4. To remove the display hinges:

- a. Remove the Phillips PM2.0×3.0 screw **(1)** that secures each hinge cover to the display enclosure.
- b. Slide the left hinge cover toward the left and remove while threading the cable through the hinge cover **(2)**.
- c. Slide the right hinge cover toward the right to remove **(3)**.

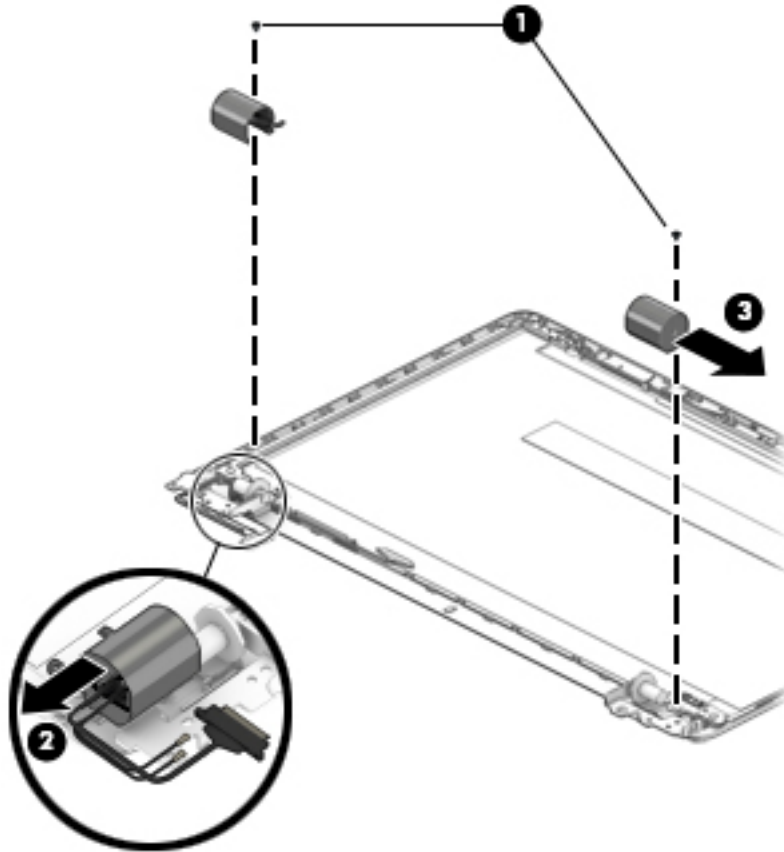

- d. Remove the two broadhead Phillips PM2.5×2.5 screws **(1)** and the broadhead PM2.5×3.0 screw **(2)** that secure each hinge to the bottom of the display enclosure.

- e. Remove the display hinges (3).

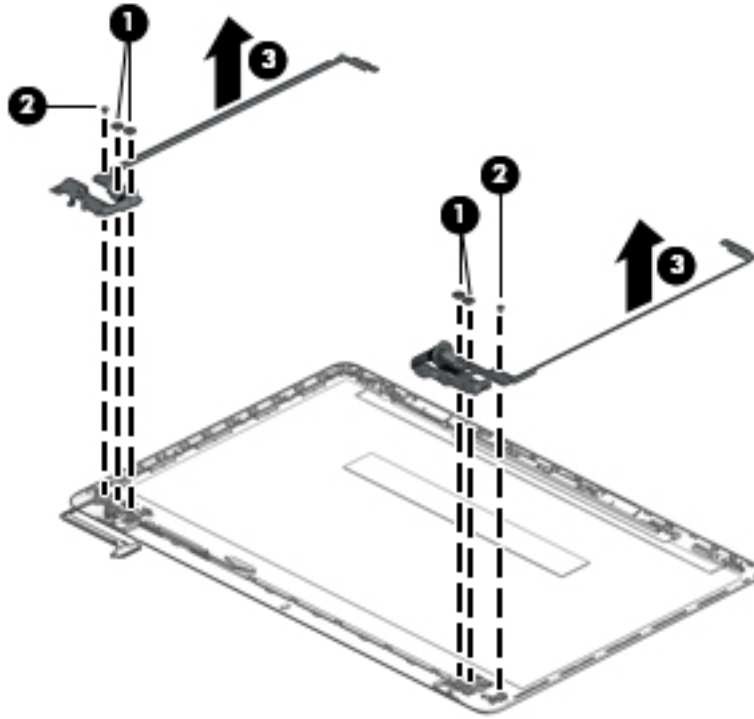

5. To remove the wireless antennas and cables, release the cables from the clips built into the side of the display enclosure (1), and then remove the antennas and cables (2).

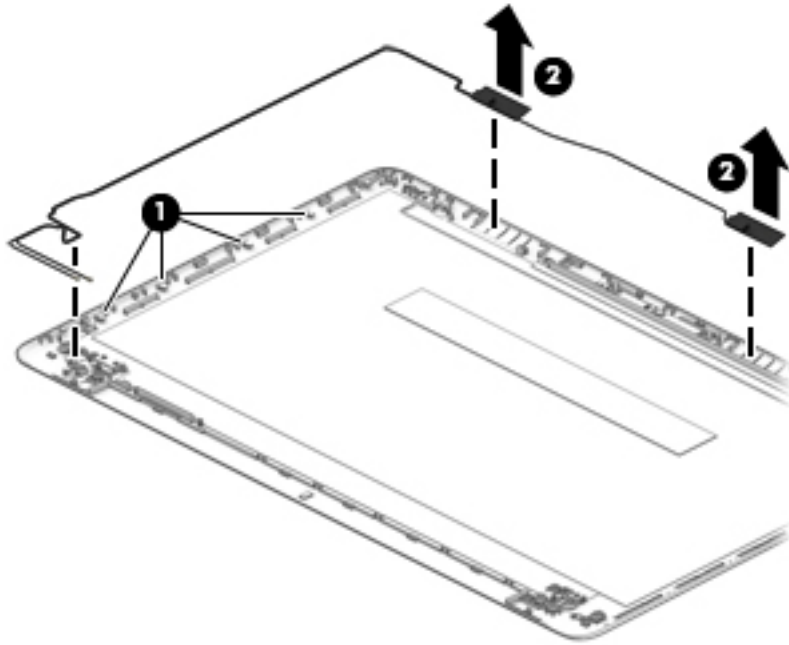

When installing the antennas, use the following image to determine correct installation locations at the top of the display enclosure.

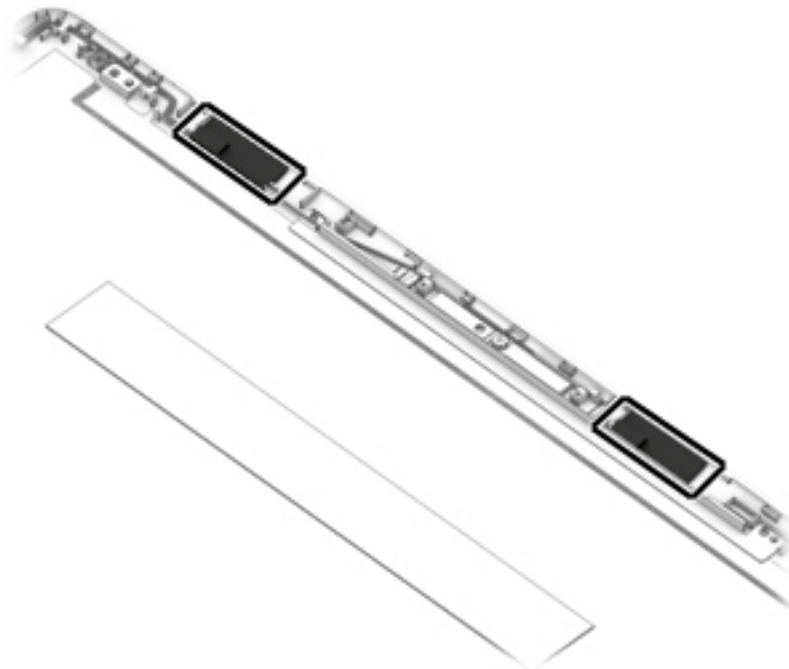

6. To remove the display/camera cable, remove the cable from the clips built into the side of the display enclosure (1), and then remove the cable from the display enclosure (2).

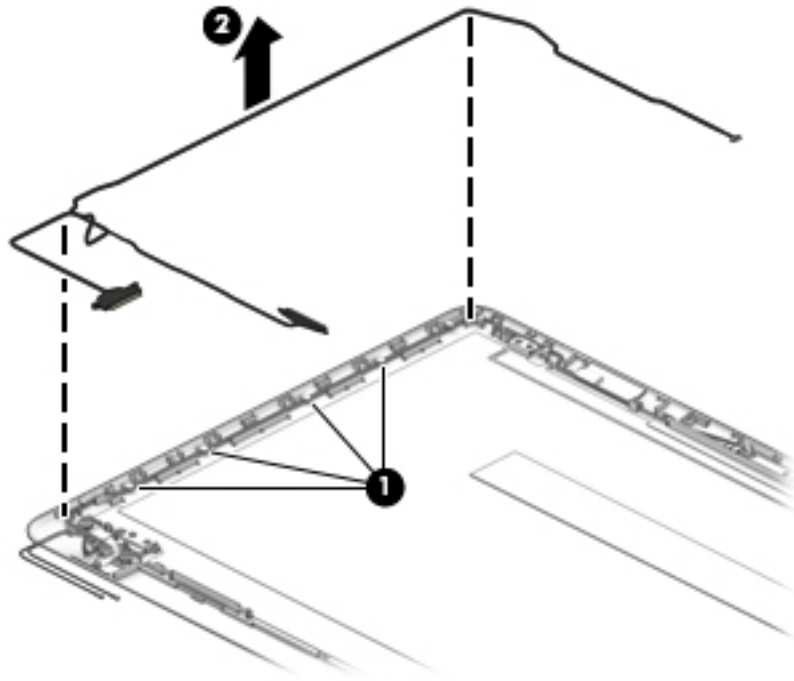

7. Use the following image to determine proper cable routing around the left hinge for the camera/display cable and the wireless antenna cables.

(1): Camera cable routing path

(2): Display/camera cable routing path

(3): Antenna cable routing path

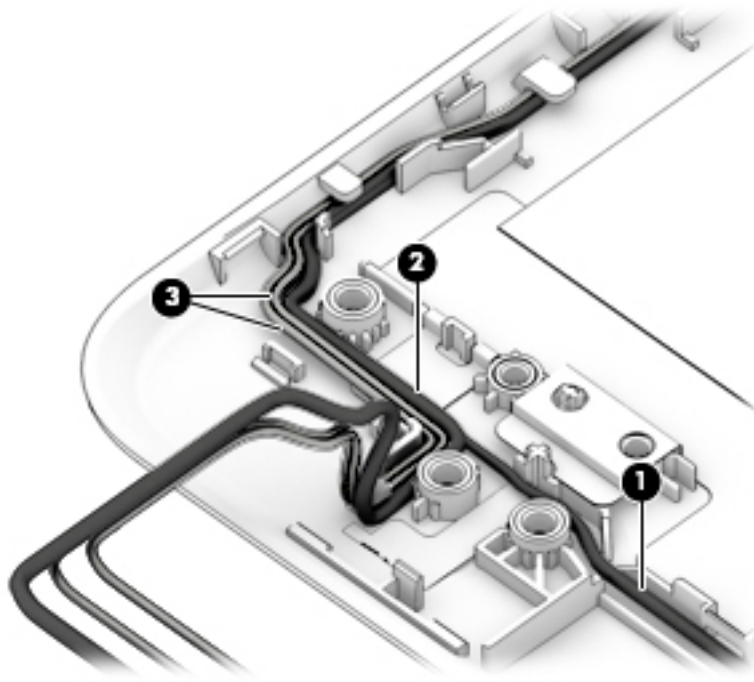

8. If replacing the display enclosure, be sure that the subcomponents (including the camera/microphone module, the antenna receivers, and all associated cables and hardware) are transferred to the new enclosure.

Reverse this procedure to reassemble and install the display assembly.

Power connector cable

Description	Spare part number
Power connector cable	931613-001

Before removing the power connector cable, follow these steps:

1. Shut down the computer. If you are unsure whether the computer is off or in Hibernation, turn the computer on, and then shut it down through the operating system.
2. Disconnect all external devices connected to the computer.
3. Disconnect the power from the computer by first unplugging the power cord from the AC outlet and then unplugging the AC adapter from the computer.
4. Remove the battery (see [Battery on page 34](#)).
5. Remove the optical drive (see [Optical drive on page 35](#)), if installed.
6. Remove the bottom cover (see [Bottom cover on page 45](#)).
7. Remove the display (see [Display assembly on page 72](#)).

To remove the power connector cable:

1. Disconnect the power connector cable from the system board **(1)**.
2. Remove the cable from its routing path in the computer **(2)**.
3. Use a tool to pry the connector out of the computer **(3)**, and then remove the power connector cable **(4)**.

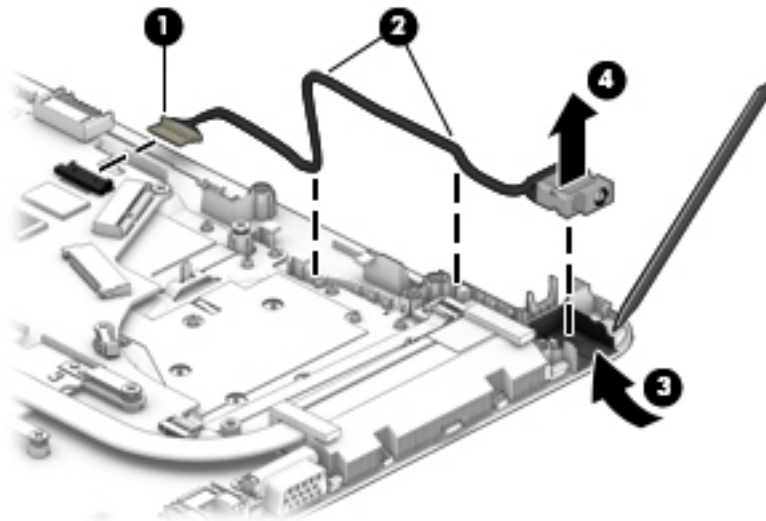

Reverse this procedure to install the power connector cable.

Power button board

Description	Spare part number
Power button board	924994-001
Power button board cable	924933-001

Before removing the power button board, follow these steps:

1. Shut down the computer. If you are unsure whether the computer is off or in Hibernation, turn the computer on, and then shut it down through the operating system.
2. Disconnect all external devices connected to the computer.
3. Disconnect the power from the computer by first unplugging the power cord from the AC outlet and then unplugging the AC adapter from the computer.
4. Remove the battery (see [Battery on page 34](#)).
5. Remove the optical drive (see [Optical drive on page 35](#)), if installed.
6. Remove the bottom cover (see [Bottom cover on page 45](#)).
7. Remove the display (see [Display assembly on page 72](#)).

To remove the power button board:

1. Disconnect the cable from the power button board **(1)**.
2. Remove the Phillips PM2.0×2.0 screw **(2)** that secures the power button board to the computer.
3. Remove the power button board from the computer **(3)**.

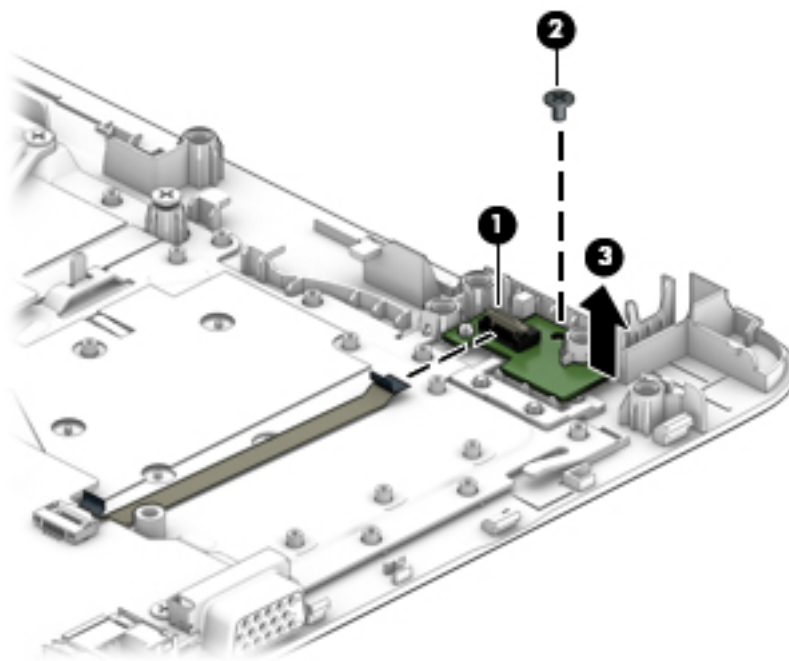

Reverse this procedure to install the power button board and cable.

Cable locations

Description	Spare part number
TouchPad cable	924928-001
Hard drive cable	924927-001
USB board cable	924929-001
Optical drive connector board cable	924926-001
Power button board cable	924933-001

Use the following image to determine properly cable location and routing.

- (1) TouchPad cable
- (2) Hard drive cable
- (3) USB board cable
- (4) Optical drive connector board cable
- (5) Power button board cable

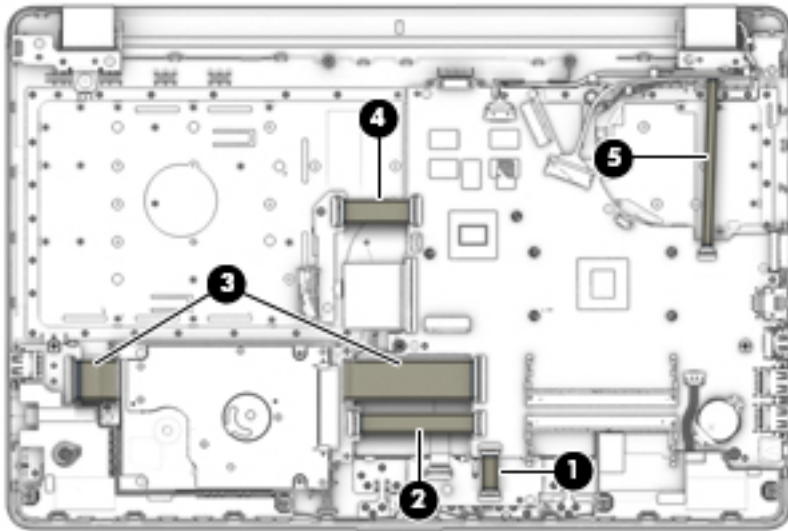

Top cover/keyboard

The top cover/keyboard spare part remains after all other spare parts have been removed.

The top cover/keyboard spare part kit includes the keyboard, keyboard cable and the keyboard backlight cable (if equipped).

In this section, the first table provides the main spare part number for the keyboard. The second table provides the country codes.



NOTE: All top cover/keyboard spare part kits include TouchPad.

Description	Spare part number
Models in the following color: jet black	925008-xxx
Models in the following color: snow white	925009-xxx
Models without a backlight in the following colors: pike silver, silk gold, empress red, smoke gray, marine blue, amethyst purple, pale mint, sparkling black	925010-xxx
Models with a backlight in the following colors: pike silver, silk gold, empress red, smoke gray, marine blue, amethyst purple, pale mint, sparkling black	925011-xxx
NOTE: Available only for the following countries and regions: the United States (-001), India (-002), English/French Canada (-DB1).	
Models without a backlight for use in the United States in the following color: rose gold	925564-001
Models with a backlight for use in the United States in the following color: rose gold	925565-001

For use in country or region	Spare part number	For use in country or region	Spare part number	For use in country or region	Spare part number
Belgium	-A41	India	-002	Slovenia	-BA1
Bulgaria	-261	Italy	-061	South Korea	-AD1
English/French Canada	-DB1	Latin America	-161	Spain	-071
Czech Republic and Slovakia	-FL1	Japan	-291	Switzerland	-BG1
Denmark, Finland, and Norway	-DH1	The Netherlands	-B31	Taiwan	-AB1
France	-051	Portugal	-131	Thailand	-281
Germany	-041	Romania	-271	Turkey	-141
Greece	-151	Russia	-251	United Kingdom	-031
Hungary	-211	Saudi Arabia	-171	United States	-001

7 Using Setup Utility (BIOS)

Setup Utility, or Basic Input/Output System (BIOS), controls communication between all the input and output devices on the system (such as disk drives, display, keyboard, mouse, and printer). Setup Utility (BIOS) includes settings for the types of devices installed, the startup sequence of the computer, and the amount of system and extended memory.

 **NOTE:** To start Setup Utility on convertible computers, your computer must be in notebook mode and you must use the keyboard attached to your notebook.

Starting Setup Utility (BIOS)

 **CAUTION:** Use extreme care when making changes in Setup Utility (BIOS). Errors can prevent the computer from operating properly.

- ▲ Turn on or restart the computer, quickly press **esc**, and then press **f10**.

Updating Setup Utility (BIOS)

Updated versions of Setup Utility (BIOS) may be available on the HP website.

Most BIOS updates on the HP website are packaged in compressed files called *SoftPaqs*.

Some download packages contain a file named *Readme.txt*, which contains information regarding installing and troubleshooting the file.

Determining the BIOS version

To decide whether you need to update Setup Utility (BIOS), first determine the BIOS version on your computer.

To reveal the BIOS version information (also known as *ROM date* and *System BIOS*), use one of these options.

- HP Support Assistant
 1. Type `support` in the taskbar search box, and then select the **HP Support Assistant** app.
– or –
Click the question mark icon in the taskbar.
 2. Select **My PC**, and then select **Specifications**.
- Setup Utility (BIOS)
 1. Start Setup Utility (BIOS) (see [Starting Setup Utility \(BIOS\) on page 87](#)).
 2. Select **Main**, select **System Information**, and then make note of the BIOS version.
 3. Select **Exit**, select **No**, and then follow the on-screen instructions.

To check for later BIOS versions, see [Downloading a BIOS update on page 88](#).

Downloading a BIOS update

 **CAUTION:** To reduce the risk of damage to the computer or an unsuccessful installation, download and install a BIOS update only when the computer is connected to reliable external power using the AC adapter. Do not download or install a BIOS update while the computer is running on battery power, docked in an optional docking device, or connected to an optional power source. During the download and installation, follow these instructions:

- Do not disconnect power from the computer by unplugging the power cord from the AC outlet.
- Do not shut down the computer or initiate Sleep.
- Do not insert, remove, connect, or disconnect any device, cable, or cord.

 **NOTE:** If your computer is connected to a network, consult the network administrator before installing any software updates, especially system BIOS updates.

1. Type `support` in the taskbar search box, and then select the **HP Support Assistant** app.
– or –
Click the question mark icon in the taskbar.
2. Click **Updates**, and then click **Check for updates and messages**.
3. Follow the on-screen instructions.
4. At the download area, follow these steps:
 - a. Identify the most recent BIOS update and compare it to the BIOS version currently installed on your computer. If the update is more recent than your BIOS version, make a note of the date, name, or other identifier. You may need this information to locate the update later, after it has been downloaded to your hard drive.
 - b. Follow the on-screen instructions to download your selection to the hard drive.

Make a note of the path to the location on your hard drive where the BIOS update is downloaded. You will need to access this path when you are ready to install the update.

BIOS installation procedures vary. Follow any instructions that appear on the screen after the download is complete. If no instructions appear, follow these steps:

1. Type `file` in the taskbar search box, and then select **File Explorer**.
2. Click your hard drive designation. The hard drive designation is typically Local Disk (C:).
3. Using the hard drive path you recorded earlier, open the folder that contains the update.
4. Double-click the file that has an `.exe` extension (for example, `filename.exe`).

The BIOS installation begins.
5. Complete the installation by following the on-screen instructions.

 **NOTE:** After a message on the screen reports a successful installation, you can delete the downloaded file from your hard drive.

8 Backing up, restoring, and recovering

This chapter provides information about the following processes. The information in the chapter is standard procedure for most products.

- Creating recovery media and backups
- Restoring and recovering your system

For additional information, refer to the HP Support Assistant app.

▲ Type `support` in the taskbar search box, and then select the **HP Support Assistant** app.

– or –

Select the question mark icon in the taskbar.

 **IMPORTANT:** If you will be performing recovery procedures on a tablet, the tablet battery must be at least 70% charged before you start the recovery process.

IMPORTANT: For a tablet with a detachable keyboard, connect the tablet to the keyboard base before beginning any recovery process.

Creating recovery media and backups

The following methods of creating recovery media and backups are available on select products only. Choose the available method according to your computer model.

- Use HP Recovery Manager to create HP Recovery media after you successfully set up the computer. This step creates a backup of the HP Recovery partition on the computer. The backup can be used to reinstall the original operating system in cases where the hard drive is corrupted or has been replaced. For information on creating recovery media, see [Creating HP Recovery media \(select products only\) on page 89](#). For information on the recovery options that are available using the recovery media, see [Using Windows tools on page 90](#).
- Use Windows tools to create system restore points and create backups of personal information.

For more information, see [Recovering using HP Recovery Manager on page 91](#).

 **NOTE:** If storage is 32 GB or less, Microsoft System Restore is disabled by default.

Creating HP Recovery media (select products only)

If possible, check for the presence of the Recovery partition and the Windows partition. From the **Start** menu, select **File Explorer**, and then select **This PC**.

- If your computer does not list the Windows partition and the Recovery partition, you can obtain recovery media for your system from support. See the *Worldwide Telephone Numbers* booklet included with the computer. You can also find contact information on the HP website. Go to <http://www.hp.com/support>, select your country or region, and follow the on-screen instructions.

You can use Windows tools to create system restore points and create backups of personal information, see [Using Windows tools on page 90](#).

- If your computer does list the Recovery partition and the Windows partition, you can use HP Recovery Manager to create recovery media after you successfully set up the computer. HP Recovery media can be used to perform system recovery if the hard drive becomes corrupted. System recovery reinstalls the original operating system and software programs that were installed at the factory and then configures the settings for the programs. HP Recovery media can also be used to customize the system or restore the factory image if you replace the hard drive.
 - Only one set of recovery media can be created. Handle these recovery tools carefully, and keep them in a safe place.
 - HP Recovery Manager examines the computer and determines the required storage capacity for the media that will be required.
 - To create recovery discs, your computer must have an optical drive with DVD writer capability, and you must use only high-quality blank DVD-R, DVD+R, DVD-R DL, or DVD+R DL discs. Do not use rewritable discs such as CD±RW, DVD±RW, double-layer DVD±RW, or BD-RE (rewritable Blu-ray) discs; they are not compatible with HP Recovery Manager software. Or, instead, you can use a high-quality blank USB flash drive.
 - If your computer does not include an integrated optical drive with DVD writer capability, but you would like to create DVD recovery media, you can use an external optical drive (purchased separately) to create recovery discs. If you use an external optical drive, it must be connected directly to a USB port on the computer; the drive cannot be connected to a USB port on an external device, such as a USB hub. If you cannot create DVD media yourself, you can obtain recovery discs for your computer from HP. See the *Worldwide Telephone Numbers* booklet included with the computer. You can also find contact information on the HP website. Go to <http://www.hp.com/support>, select your country or region, and follow the on-screen instructions.
 - Be sure that the computer is connected to AC power before you begin creating the recovery media.
 - The creation process can take an hour or more. Do not interrupt the creation process.
 - If necessary, you can exit the program before you have finished creating all of the recovery DVDs. HP Recovery Manager will finish burning the current DVD. The next time you start HP Recovery Manager, you will be prompted to continue.

To create HP Recovery media:



IMPORTANT: For a tablet with a detachable keyboard, connect the tablet to the keyboard base before beginning these steps.

1. Type `recovery` in the taskbar search box, and then select **HP Recovery Manager**.
2. Select **Create recovery media**, and then follow the on-screen instructions.

If you ever need to recover the system, see [Recovering using HP Recovery Manager on page 91](#).

Using Windows tools

You can create recovery media, system restore points, and backups of personal information using Windows tools.



NOTE: If storage is 32 GB or less, Microsoft System Restore is disabled by default.

For more information and steps, see the Get started app.

- ▲ Select the **Start** button, and then select the **Get started** app.

Restore and recovery

There are several options for recovering your system. Choose the method that best matches your situation and level of expertise:

 **IMPORTANT:** Not all methods are available on all products.

- Windows offers several options for restoring from backup, refreshing the computer, and resetting the computer to its original state. For more information see the Get started app.
 - ▲ Select the **Start** button, and then select the **Get started** app.
- If you need to correct a problem with a preinstalled application or driver, use the Reinstall drivers and/or applications option (select products only) of HP Recovery Manager to reinstall the individual application or driver.
 - ▲ Type `recovery` in the taskbar search box, select **HP Recovery Manager**, select **Reinstall drivers and/or applications**, and then follow the on-screen instructions.
- If you want to recover the Windows partition to original factory content, you can choose the System Recovery option from the HP Recovery partition (select products only) or use the HP Recovery media. For more information, see [Recovering using HP Recovery Manager on page 91](#). If you have not already created recovery media, see [Creating HP Recovery media \(select products only\) on page 89](#).
- On select products, if you want to recover the computer's original factory partition and content, or if you have replaced the hard drive, you can use the Factory Reset option of HP Recovery media. For more information, see [Recovering using HP Recovery Manager on page 91](#).
- On select products, if you want to remove the Recovery partition to reclaim hard drive space, HP Recovery Manager offers the Remove Recovery Partition option.

For more information, see [Removing the HP Recovery partition \(select products only\) on page 94](#).

Recovering using HP Recovery Manager

HP Recovery Manager software allows you to recover the computer to its original factory state by using the HP Recovery media that you either created or that you obtained from HP, or by using the HP Recovery partition (select products only). If you have not already created recovery media, see [Creating HP Recovery media \(select products only\) on page 89](#).

What you need to know before you get started

- HP Recovery Manager recovers only software that was installed at the factory. For software not provided with this computer, you must either download the software from the manufacturer's website or reinstall the software from the media provided by the manufacturer.

 **IMPORTANT:** Recovery through HP Recovery Manager should be used as a final attempt to correct computer issues.

- HP Recovery media must be used if the computer hard drive fails. If you have not already created recovery media, see [Creating HP Recovery media \(select products only\) on page 89](#).
- To use the Factory Reset option (select products only), you must use HP Recovery media. If you have not already created recovery media, see [Creating HP Recovery media \(select products only\) on page 89](#).
- If your computer does not allow the creation of HP Recovery media or if the HP Recovery media does not work, you can obtain recovery media for your system from support. See the *Worldwide Telephone Numbers* booklet included with the computer. You can also find contact information from the HP

website. Go to <http://www.hp.com/support>, select your country or region, and follow the on-screen instructions.

 **IMPORTANT:** HP Recovery Manager does not automatically provide backups of your personal data. Before beginning recovery, back up any personal data you want to retain.

Using HP Recovery media, you can choose from one of the following recovery options:

 **NOTE:** Only the options available for your computer display when you start the recovery process.

- System Recovery—Reinstalls the original operating system, and then configures the settings for the programs that were installed at the factory.
- Factory Reset—Restores the computer to its original factory state by deleting all information from the hard drive and re-creating the partitions. Then it reinstalls the operating system and the software that was installed at the factory.

The HP Recovery partition (select products only) allows System Recovery only.

Using the HP Recovery partition (select products only)

The HP Recovery partition allows you to perform a system recovery without the need for recovery discs or a recovery USB flash drive. This type of recovery can be used only if the hard drive is still working.

To start HP Recovery Manager from the HP Recovery partition:

 **IMPORTANT:** For a tablet with a detachable keyboard, connect the tablet to the keyboard base before beginning these steps (select products only).

1. Type `recovery` in the taskbar search box, select **Recovery Manager**, and then select **HP Recovery Environment**.

– or –

For computers or tablets with keyboards attached, press **f11** while the computer boots, or press and hold **f11** as you press the power button.

For tablets without keyboards:

- Turn on or restart the tablet, and then quickly hold down the volume up button; then select **f11**.

– or –

- Turn on or restart the tablet, and then quickly hold down the volume down button; then select **f11**.

2. Select **Troubleshoot** from the boot options menu.
3. Select **Recovery Manager**, and then follow the on-screen instructions.

Using HP Recovery media to recover

You can use HP Recovery media to recover the original system. This method can be used if your system does not have an HP Recovery partition or if the hard drive is not working properly.

1. If possible, back up all personal files.
2. Insert the HP Recovery media, and then restart the computer.

 **NOTE:** If the computer does not automatically restart in HP Recovery Manager, change the computer boot order. See [Changing the computer boot order on page 93](#).

3. Follow the on-screen instructions.

Changing the computer boot order

If your computer does not restart in HP Recovery Manager, you can change the computer boot order, which is the order of devices listed in BIOS where the computer looks for startup information. You can change the selection to an optical drive or a USB flash drive.

To change the boot order:



IMPORTANT: For a tablet with a detachable keyboard, connect the tablet to the keyboard base before beginning these steps.

1. Insert the HP Recovery media.
2. Access the system **Startup** menu.

For computers or tablets with keyboards attached:

- ▲ Turn on or restart the computer or tablet, quickly press **esc**, and then press **f9** for boot options.

For tablets without keyboards:

- ▲ Turn on or restart the tablet, and then quickly hold down the volume up button; then select **f9**.

– or –

Turn on or restart the tablet, and then quickly hold down the volume down button; then select **f9**.

3. Select the optical drive or USB flash drive from which you want to boot.
4. Follow the on-screen instructions.

Removing the HP Recovery partition (select products only)

HP Recovery Manager software allows you to remove the HP Recovery partition to free up hard drive space.



IMPORTANT: After you remove the HP Recovery partition, you will not be able to perform System Recovery or create HP Recovery media from the HP Recovery partition. So before you remove the Recovery partition, create HP Recovery media; see [Creating HP Recovery media \(select products only\) on page 89](#).



NOTE: The Remove Recovery Partition option is only available on products that support this function.

Follow these steps to remove the HP Recovery partition:

1. Type `recovery` in the taskbar search box, and then select **HP Recovery Manager**.
2. Select **Remove Recovery Partition**, and then follow the on-screen instructions.

9 Using HP PC Hardware Diagnostics (UEFI)

HP PC Hardware Diagnostics is a Unified Extensible Firmware Interface (UEFI) that allows you to run diagnostic tests to determine whether the computer hardware is functioning properly. The tool runs outside the operating system so that it can isolate hardware failures from issues that are caused by the operating system or other software components.

When HP PC Hardware Diagnostics (UEFI) detects a failure that requires hardware replacement, a 24-digit Failure ID code is generated. This ID code can then be provided to support to help determine how to correct the problem.

 **NOTE:** To start diagnostics on a convertible computer, your computer must be in notebook mode and you must use the keyboard attached.

To start HP PC Hardware Diagnostics (UEFI), follow these steps:

1. Turn on or restart the computer, and quickly press **esc**.
2. Press **f2**.

The BIOS searches three places for the diagnostic tools, in the following order:

- a. Connected USB drive

 **NOTE:** To download the HP PC Hardware Diagnostics (UEFI) tool to a USB drive, see [Downloading HP PC Hardware Diagnostics \(UEFI\) to a USB device on page 95](#).

- b. Hard drive
 - c. BIOS
3. When the diagnostic tool opens, select the type of diagnostic test you want to run, and then follow the on-screen instructions.

 **NOTE:** If you need to stop a diagnostic test, press **esc**.

Downloading HP PC Hardware Diagnostics (UEFI) to a USB device

 **NOTE:** The HP PC Hardware Diagnostics (UEFI) download instructions are provided in English only, and you must use a Windows computer to download and create the HP UEFI support environment because only .exe files are offered.

There are two options to download HP PC Hardware Diagnostics to a USB device.

Download the latest UEFI version

1. Go to <http://www.hp.com/go/techcenter/pcdiags>. The HP PC Diagnostics home page is displayed.
2. In the HP PC Hardware Diagnostics section, select the **Download** link, and then select **Run**.

Download any version of UEFI for a specific product

1. Go to <http://www.hp.com/support>.
2. Select **Get software and drivers**.

3. Enter the product name or number.

– or –

Select **Identify now** to let HP automatically detect your product.

4. Select your computer, and then select your operating system.
5. In the **Diagnostic** section, follow the on-screen instructions to select and download the UEFI version you want.

Additional BIOS crisis recovery tool

HP provides a BIOS crisis recovery tool through the HP PC Hardware Diagnostics 3-in-1 USB key. This tool can be used by HP authorized service providers to recover systems that have failed due to a corrupted BIOS. For more information about using the 3-in-1 USB key for BIOS crisis recovery, go to <http://www.hp.com/go/techcenter/pcdiags>. Additional information is included in the web-based training offered by HP University. See the modules that cover HP PC Hardware Diagnostics (UEFI).

10 Specifications

Computer specifications

	Metric	U.S.
Dimensions (touch models)		
Depth	253.8 mm	9.99 in
Width	380.0 mm	14.9 in
Height	23.8 mm	0.94 in
Weight		
3 cell battery	1.87 kg	4.12 lb
4 cell battery	1.92 kg	4.23 lb
Input power		
Operating voltage and current	19.5 V dc @ 3.33 A – 65 W	
	19.5 V dc @ 2.31 A – 45 W	
Temperature		
Operating	5°C to 35°C	41°F to 95°F
Nonoperating	-20°C to 60°C	-4°F to 140°F
Relative humidity (noncondensing)		
Operating	10% to 90%	
Nonoperating	5% to 95%	
Maximum altitude (unpressurized)		
Operating	-15 m to 3,048 m	-50 ft to 10,000 ft
Nonoperating	-15 m to 12,192 m	-50 ft to 40,000 ft
NOTE: Applicable product safety standards specify thermal limits for plastic surfaces. The device operates well within this range of temperatures.		

39.6-cm (15.6-in) display specifications

	Metric	U.S.
Active diagonal size	39.6-cm	15.6-in
Resolution	1366x768 (HD) 1920x1080 (FHD)	
Surface treatment	BrightView Anti glare	
Brightness	200 nits (touch) 220 nits (non-touch)	
Viewing angle	SVA	
Backlight	WLED	
Graphics adapter	eDP	
Thickness	3.2 mm (touch) 3.2 mm (non-touch)	

Hard drive specifications

	2-TB*	1-TB*	500-GB*
Dimensions			
Height	9.5 mm or 7.2 mm	9.5 mm or 7.2 mm	7.0 mm
Length	100.4 mm	100.4 mm	100.6 mm
Width	69.9 mm	69.9 mm	70.1 mm
Weight	130.0 g	107.0 g	92.0 g
Interface type	SATA	SATA	SATA
Transfer rate			
Synchronous (maximum)	300 MB/sec	300 MB/sec	300 MB/sec
Security	ATA security	ATA security	ATA security
Seek times (typical read, including setting)			
Single track	2.0 ms	2.0 ms	3 ms
Average (read/write)	12 ms	12 ms	13 ms
Maximum	22 ms	22 ms	24 ms
Logical blocks	3,907,029,168	1,953,525,168	1,048,576,000
Disk rotational speed	5400 rpm	5400 rpm	5400 rpm
Operating temperature	0°C to 60°C (32°F to 140°F)		
*1 GB = 1 billion bytes when referring to hard drive storage capacity. Actual accessible capacity is less.			
NOTE: Certain restrictions and exclusions apply. Contact technical support for details.			

M.2 solid-state drive specifications

	128-GB*	256-GB*	512-GB*
Dimensions			
Width	1 mm	1 mm	1.5 mm
Length	50.8 mm	50.8 mm	80.0 mm
Width	28.9 mm	28.9 mm	22.0 mm
Weight	< 10 g	< 10 g	< 9 g
Interface type	ATA-7	ATA-7	ATA-7
Transfer rate			
Sequential Read	Up to 520 MB/s	Up to 535 MB/s	Up to 530 MB/s
Random Read	Up to 60K IOPs	Up to 97K IOPs	Up to 97K IOPs
Sequential Write	Up to 160 MB/s	Up to 515 MB/s	Up to 515 MB/s
Random Write	Up to 34K IOPs	Up to 59K IOPs	Up to 88K IOPs
Ready time, Maximum (to not busy)	1.0 s	1.0 s	1.0 s
Access times			
Logical	0.1 ms	0.1 ms	0.1 ms
Total logical sectors	250,069,680	500,118,192	1,000,215,216
Operating temperature			
Operating	0° to 70°C (32°F to 158°F)	0° to 70°C (32°F to 158°F)	0° to 70°C (32°F to 158°F)
Non-operating	-40° to 85°C (-40°F to 185°F)	-40° to 85°C (-40°F to 185°F)	-40° to 85°C (-40°F to 185°F)
*1 GB = 1 billion bytes when referring to hard drive storage capacity. Actual accessible capacity is less.			
NOTE: Certain restrictions and exclusions apply. Contact technical support for details.			

DVD±RW SuperMulti DL Drive specifications

Component	Value	
Applicable disc	Read: CD-DA, CD+(E)G, CD-MIDI, CD-TEXT, CD-ROM, CD-ROM XA, MIXED MODE CD, CD-I, CD-I Bridge (Photo-CD, Video CD), Multisession CD (Photo-CD, CD-EXTRA, Portfolio, CD-R, CD-RW), CD-R, CD-RW, DVD-ROM (DVD-5, DVD-9, DVD-10, DVD-18), DVD-R, DVD-RW, DVD+R, DVD+RW, DVD-RAM	Write: CD-R and CD-RW DVD+R, DVD+RW, DVD-R, DVD-RW, DVD-RAM
Center hole diameter	1.5 cm (0.59 in)	
Disc diameter		
Standard disc	12 cm (4.72 in)	
Mini disc	8 cm (3.15 in)	
Disc thickness	1.2 mm (0.047 in)	
Track pitch	0.74 µm	
Access time	CD	DVD
Random	< 175 ms	< 230 ms
Full stroke	< 285 ms	< 335 ms
Audio output level	Line-out, 0.7 Vrms	
Cache buffer	2 MB	
Data transfer rate		
24X CD-ROM	3,600 KB/sec	
8X DVD-ROM	10,800 KB/sec	
24X CD-R	3,600 KB/sec	
16X CD-RW	2,400 KB/sec	
8X DVD+R	10,800 KB/sec	
4X DVD+RW	5,400 KB/sec	
8X DVD-R	10,800 KB/sec	
4X DVD-RW	5,400 KB/sec	
2.4X DVD+R(9)	2,700 KB/sec	
5X DVD-RAM	6,750 KB/sec	
Transfer mode	Multiword DMA Mode	
Startup time	< 15 seconds	
Stop time	< 6 seconds	

11 Power cord set requirements

The wide-range input feature of the computer permits it to operate from any line voltage from 100 to 120 volts ac, or from 220 to 240 volts ac.

The 3-conductor power cord set included with the computer meets the requirements for use in the country or region where the equipment is purchased.

Power cord sets for use in other countries and regions must meet the requirements of the country or region where the computer is used.

Requirements for all countries

The following requirements are applicable to all countries and regions:

- The length of the power cord set must be at least **1.5 m** (5.0 ft) and no more than **2.0 m** (6.5 ft).
- All power cord sets must be approved by an acceptable accredited agency responsible for evaluation in the country or region where the power cord set will be used.
- The power cord sets must have a minimum current capacity of 10 A and a nominal voltage rating of 125 or 250 V ac, as required by the power system of each country or region.
- The appliance coupler must meet the mechanical configuration of an EN 60 320/IEC 320 Standard Sheet C13 connector for mating with the appliance inlet on the back of the computer.

Requirements for specific countries and regions

Country/region	Accredited agency	Applicable note number
Argentina	IRAM	1
Australia	SAA	1
Austria	OVE	1
Belgium	CEBEC	1
Brazil	ABNT	1
Canada	CSA	2
Chile	IMQ	1
Denmark	DEMKO	1
Finland	FIMKO	1
France	UTE	1
Germany	VDE	1
India	ISI	1
Israel	SII	1
Italy	IMQ	1
Japan	JIS	3
The Netherlands	KEMA	1
New Zealand	SANZ	1
Norway	NEMKO	1
The People's Republic of China	CCC	4
Saudi Arabia	SASO	7
Singapore	PSB	1
South Africa	SABS	1
South Korea	KTL	5
Sweden	SEMKO	1
Switzerland	SEV	1
Taiwan	BSMI	6
Thailand	TISI	1
The United Kingdom	ASTA	1
The United States	UL	2

1. The flexible cord must be Type H05VV-F, 3-conductor, 0.75mm² conductor size. Power cord set fittings (appliance coupler and wall plug) must bear the certification mark of the agency responsible for evaluation in the country or region where it will be used.
2. The flexible cord must be Type SVT/SJT or equivalent, No. 18 AWG, 3-conductor. The wall plug must be a two-pole grounding type with a NEMA 5-15P (15 A, 125 V ac) or NEMA 6-15P (15 A, 250 V ac) configuration. CSA or C-UL mark. UL file number must be on each element.

Country/region	Accredited agency	Applicable note number
		3. The appliance coupler, flexible cord, and wall plug must bear a “T” mark and registration number in accordance with the Japanese Dentori Law. The flexible cord must be Type VCTF, 3-conductor, 0.75mm ² or 1.25mm ² conductor size. The wall plug must be a two-pole grounding type with a Japanese Industrial Standard C8303 (7 A, 125 V ac) configuration.
		4. The flexible cord must be Type RVV, 3-conductor, 0.75mm ² conductor size. Power cord set fittings (appliance coupler and wall plug) must bear the CCC certification mark.
		5. The flexible cord must be Type H05VV-F 3X0.75mm ² conductor size. KTL logo and individual approval number must be on each element. Corset approval number and logo must be printed on a flag label.
		6. The flexible cord must be Type HVCTF 3X1.25mm ² conductor size. Power cord set fittings (appliance coupler, cable, and wall plug) must bear the BSMI certification mark.
		7. For 127 V ac, the flexible cord must be Type SVT or SJT 3 x 18 AWG, with plug NEMA 5-15P (15 A, 125 V ac), with UL and CSA or C-UL marks. For 240 V ac, the flexible cord must be Type H05VV-F 3X0.75/1.00mm ² conductor size, with plug BS 1363/A with BSI or ASTA marks.

12 Recycling

When a non-rechargeable or rechargeable battery has reached the end of its useful life, do not dispose of the battery in general household waste. Follow the local laws and regulations in your area for battery disposal.

HP encourages customers to recycle used electronic hardware, HP original print cartridges, and rechargeable batteries. For more information about recycling programs, see the HP Web site at <http://www.hp.com/recycle>.

Index

A

- AC adapter and battery 8
- action keys
 - identifying 13
 - using 14
- airplane mode key 14
- antenna
 - illustrated 23
- antennas
 - removing 79, 80
- audio, product description 3
- audio-out (headphone)/audio-in (microphone) jack, identifying 8

B

- backups 89
- battery
 - illustrated 20
 - removing 34
- battery cover, identifying 15
- battery lock, identifying 15
- battery release latch 15
- BIOS
 - determining version 87
 - downloading an update 88
 - starting the Setup Utility 87
 - updating 87
- Bluetooth label 16
- boot order
 - changing 93
- bottom 16
- bottom cover
 - illustrated 20
 - removing 45
- buttons
 - left TouchPad 10
 - power 12
 - right TouchPad 10

C

- cable locations
 - removing 84
- cables
 - illustrated 24
- cables, service considerations 29

- camera
 - identifying 9
- camera light, identifying 9
- camera/microphone cable
 - illustrated 23
 - removing 41, 75, 76
- camera/microphone module
 - illustrated 22
 - removing 40, 74
- caps lock light, identifying 11
- components
 - bottom 15
 - display 9
 - keyboard area 10
 - left side 8
 - right side 7
- computer major components, illustrated 17
- computer specifications 97
- connector, power 8
- connectors, service considerations 29

D

- display assembly
 - illustrated 18
 - removing 72
- display assembly subcomponents
 - illustrated 22
 - removing 72
- display bezel
 - illustrated 22
 - removing 39, 73
- display cable
 - illustrated 23
 - removing 76
- display enclosure
 - illustrated 23
 - removing 81
- display panel
 - illustrated 22
 - product description 2
 - removing 41, 75, 76
- display specifications 98

- display subcomponents
 - removal 39
 - spare part numbers 39
- drive light 7
- DVD±RW SuperMulti DL Drive
 - specifications 101

E

- electrostatic discharge 30
- eMMC module
 - spare part number 18
- equipment guidelines 32
- esc key, identifying 13
- Ethernet, product description 3
- external media cards 4
- external monitor port, identifying 8

F

- fan
 - illustrated 18
 - removing 62
- fn key, identifying 13

G

- graphics, product description 1
- grounding guidelines 30
- guidelines
 - equipment 32
 - grounding 30
 - packaging 31
 - transporting 31
 - workstation 31

H

- hard drive
 - illustrated 19, 26
 - precautions 30
 - product description 2
 - removing 53
 - specifications 99
- hard drive board
 - illustrated 19
- hard drive bracket
 - illustrated 19, 26

- hard drive brackets
 - removing 54
- hard drive connector
 - removing 55
- hard drive connector and cable
 - removing 54
- hard drive connector board
 - removing 53
- hard drive connector board cable
 - illustrated 24
- HDMI port
 - identifying 8
- heat sink assembly
 - illustrated 18
 - removing 18, 64
- hinge cover
 - illustrated 22
- hinges
 - illustrated 23
 - removing 41, 75, 76
- HP PC Hardware Diagnostics (UEFI)
 - using 95
- HP Recovery Manager
 - correcting boot problems 93
 - starting 92
- HP Recovery media
 - creating 89
 - recovery 92
- HP Recovery partition
 - recovery 92
 - removing 94

I

- integrated numeric keypad,
 - identifying 13
- internal card
 - product description 4
- internal microphone, identifying 9

J

- jacks
 - audio-out (headphone)/audio-in (microphone) 8
 - network 8
 - RJ-45 (network) 8

K

- keyboard
 - illustrated 18
 - product description 4

- keys
 - action 13
 - airplane mode 14
 - esc 13
 - fn 13
 - Windows 13

L

- labels
 - Bluetooth 16
 - regulatory 16
 - serial number 16
 - service 16
 - wireless certification 16
 - WLAN 16
- latch, battery release 15
- lights
 - AC adapter and battery light 8
 - caps lock 11
 - drive 7
 - mute 11
 - power 7
 - RJ-45 (network) status 8

M

- M.2 solid-state drive
 - specifications 100
- M.2 solid-state drive adapter bracket
 - and connector board
 - removing 56
- mass storage devices
 - illustrated 25
 - precautions 30
- memory card reader, identifying 7
- memory card, identifying 7
- memory module
 - illustrated 18
 - product description 2
 - removing 50
- microphone 3
- minimized image recovery 92
- minimized image, creating 91
- model name 1
- mute light, identifying 11

N

- network jack, identifying 8

O

- operating system 5

- optical drive
 - illustrated 19, 25
 - precautions 30
 - product description 3
 - removing 35
 - specifications 101
- optical drive bezel
 - illustrated 25
- optical drive bracket
 - illustrated 25
- optical drive connector board
 - illustrated 19, 52
 - removing 52
- optical drive connector board cable
 - illustrated 24
- optical drive eject button,
 - identifying 7
- optical drive rear bracket
 - removing 36, 37
- optical drive, identifying 7
- original system recovery 91

P

- packaging guidelines 31
- plastic parts, service
 - considerations 29
- pointing device 4
- ports
 - external monitor 8
 - HDMI 8
 - product description 4
 - USB 2.0 7
 - USB 3.x SuperSpeed 8
- power button board
 - illustrated 18
 - removing 83
- power button board cable
 - illustrated 24
- power button, identifying 12
- power connector cable
 - illustrated 18
 - removing 82
- power connector, identifying 8
- power cord
 - requirements for all countries 103
 - requirements for specific countries and regions 104
 - set requirements 103
- power lights, identifying 7

- power requirements 5
- processor
 - product description 1
- product description
 - audio 3
 - display panel 2
 - Ethernet 3
 - external media cards 4
 - graphics 1
 - hard drive 2
 - internal card 4
 - keyboard 4
 - memory module 2
 - microphone 3
 - operating system 5
 - optical drive 3
 - pointing device 4
 - ports 4
 - power requirements 5
 - processor 1
 - product name 1
 - security 5
 - serviceability 5
 - video 3
 - wireless 3
- product name 1
- product name and number, computer 16
- R**
- recover
 - options 91
- recovery
 - discs 90, 92
 - HP Recovery Manager 91
 - media 92
 - starting 92
 - supported discs 90
 - system 91
 - USB flash drive 92
 - using HP Recovery media 90
- recovery media
 - creating 89
 - creating using HP Recovery Manager 90
- recovery partition
 - removing 94
- regulatory information
 - regulatory label 16
 - wireless certification labels 16
- removal/replacement
 - preliminaries 29
 - procedures 33, 39
- RJ-45 (network) jack, identifying 8
- RJ-45 (network) status lights, identifying 8
- RTC battery
 - illustrated 18
 - removing 59
- rubber feet
 - removing 43
- S**
- security cable slot, identifying 7
- security, product description 5
- serial number 16
- serial number, computer 16
- service considerations
 - cables 29
 - connectors 29
 - plastic parts 29
- service labels, locating 16
- serviceability, product description 5
- slots
 - memory card reader 7
 - security cable 7
- solid-state drive
 - illustrated 25
 - removal 58
 - spare part number 18, 26, 58
- solid-state drive board
 - illustrated 19, 56
- solid-state drive bracket
 - illustrated 19, 56
- speakers
 - illustrated 20
 - removing 60
- speakers, identifying 15
- specifications
 - computer 97
 - display 98
 - DVD±RW SuperMulti DL Drive 101
 - hard drive 99
 - M.2 solid-state drive 100
 - optical drive 101
- supported discs, recovery 90
- system board
 - removing 69
 - spare part number 19, 69
- system recovery 91
- system restore point
 - creating 90
- system restore point, creating 89
- T**
- tools required 29
- top cover/keyboard
 - removing 85
- TouchPad
 - buttons 10
- TouchPad button board
 - removing 68
 - spare part number 18, 68
- TouchPad button board cable
 - illustrated 24
- TouchPad cable
 - illustrated 24
- TouchPad zone, identifying 10
- transporting guidelines 31
- traveling with the computer 16
- U**
- USB 2.0 port, identifying 7
- USB 3.x SuperSpeed port, identifying 8
- USB board
 - removing 61
 - spare part number 18
- USB board cable
 - illustrated 24
- V**
- vents, identifying 8, 15
- video, product description 3
- W**
- Windows
 - system restore point 89, 90
- Windows key, identifying 13
- Windows tools
 - using 90
- wireless antenna
 - illustrated 23
- wireless antennas
 - removing 79, 80
- wireless certification label 16
- wireless, product description 3
- WLAN antennas, identifying 9
- WLAN device 16
- WLAN label 16

WLAN module
 illustrated 19
 removing 48
workstation guidelines 31

Free Manuals Download Website

<http://myh66.com>

<http://usermanuals.us>

<http://www.somanuals.com>

<http://www.4manuals.cc>

<http://www.manual-lib.com>

<http://www.404manual.com>

<http://www.luxmanual.com>

<http://aubethermostatmanual.com>

Golf course search by state

<http://golfingnear.com>

Email search by domain

<http://emailbydomain.com>

Auto manuals search

<http://auto.somanuals.com>

TV manuals search

<http://tv.somanuals.com>